

DS90CR217 +3.3V Rising Edge Data Strobe LVDS 21-Bit Channel Link - 85 MHz

Check for Samples: [DS90CR217](#)

FEATURES

- 20 to 85 MHz Shift Clock Support
- 50% Duty Cycle on Receiver Output Clock
- Best-in-Class Set & Hold Times on TxINPUTs
- Low Power Consumption
- $\pm 1V$ Common-Mode Range (Around +1.2V)
- Narrow Bus Reduces Cable Size and Cost
- Up to 1.785 Gbps Throughput
- Up to 223 Mbytes/sec Bandwidth
- 345 mV (typ) Swing LVDS Devices for Low EMI
- PLL Requires No External Components
- Rising Edge Data Strobe
- Compatible with TIA/EIA-644 LVDS Standard
- Low Profile 48-Lead TSSOP Package

DESCRIPTION

The DS90CR217 transmitter converts 21 bits of CMOS/TTL data into three LVDS (Low Voltage Differential Signaling) data streams. A phase-locked transmit clock is transmitted in parallel with the data streams over a fourth LVDS link. Every cycle of the transmit clock 21 bits of input data are sampled and transmitted. At a transmit clock frequency of 85 MHz, 21 bits of TTL data are transmitted at a rate of 595 Mbps per LVDS data channel. Using a 85 MHz clock, the data throughput is 1.785 Gbit/s (223 Mbytes/sec).

The narrow bus and LVDS signalling of the DS90CR217 is an ideal means to solve EMI and cable size problems associated with wide, high-speed TTL interfaces.

Block Diagram

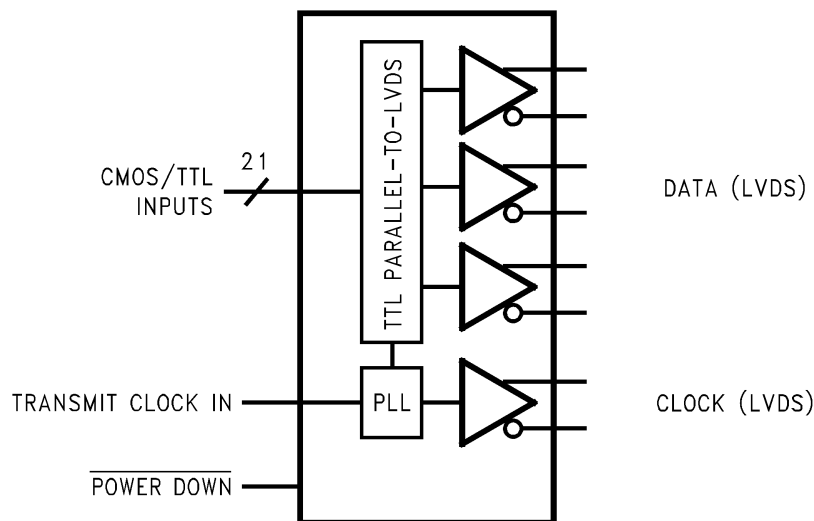

Figure 1. DS90CR217
See Package Number DGG0048A



Please be aware that an important notice concerning availability, standard warranty, and use in critical applications of Texas Instruments semiconductor products and disclaimers thereto appears at the end of this data sheet.

All trademarks are the property of their respective owners.

Connection Diagrams

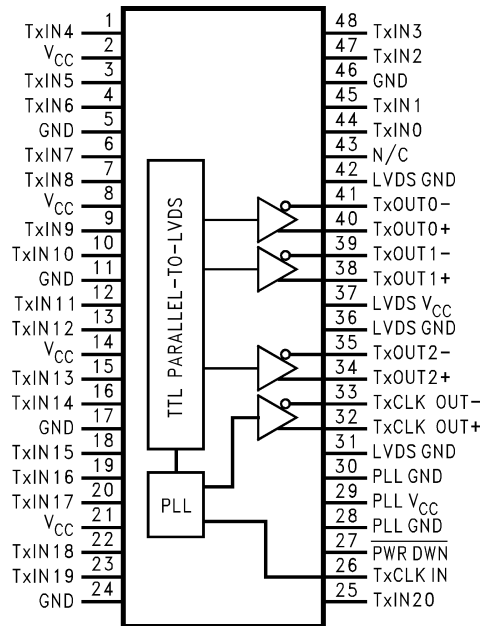
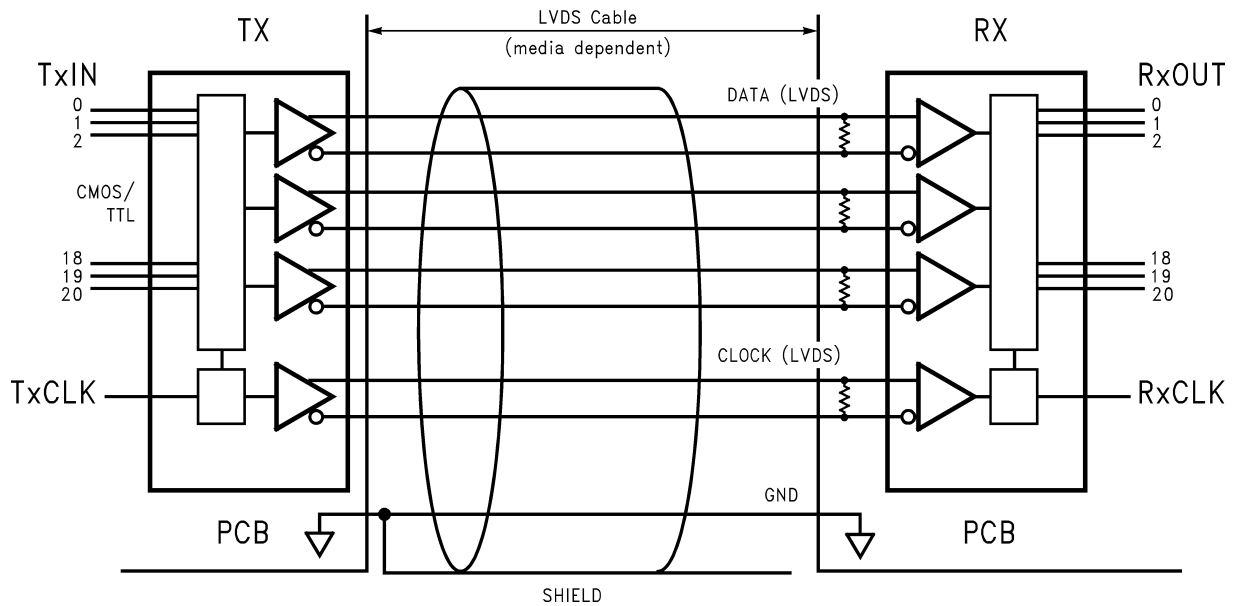

Figure 2.

Typical Application



These devices have limited built-in ESD protection. The leads should be shorted together or the device placed in conductive foam during storage or handling to prevent electrostatic damage to the MOS gates.

Absolute Maximum Ratings ⁽¹⁾⁽²⁾⁽¹⁾

Supply Voltage (V_{CC})	-0.3V to +4V
CMOS/TTL Input Voltage	-0.5V to ($V_{CC} + 0.3V$)
CMOS/TTL Output Voltage	-0.3V to ($V_{CC} + 0.3V$)
LVDS Receiver Input Voltage	-0.3V to ($V_{CC} + 0.3V$)
LVDS Driver Output Voltage	-0.3V to ($V_{CC} + 0.3V$)
LVDS Output Short	
Circuit Duration	Continuous
Junction Temperature	+150°C
Storage Temperature Range	-65°C to +150°C
Lead Temperature	
(Soldering, 4 sec.)	+260°C
Maximum Package Power Dissipation @ +25°C	
DGG0048A (TSSOP) Package:	
DS90CR217	1.98 W
Package Derating	
DS90CR217	16 mW/°C above +25°C
ESD Rating	
(HBM, 1.5k Ω , 100pF)	> 7kV
(EIAJ, 0 Ω , 200pF)	> 700V
Latch Up Tolerance @ 25°C	> ± 300 mA

- (1) If Military/Aerospace specified devices are required, please contact the Texas Instruments Sales Office/ Distributors for availability and specifications.
- (2) "Absolute Maximum Ratings" are those values beyond which the safety of the device cannot be guaranteed. They are not meant to imply that the device should be operated at these limits. "Electrical Characteristics" specify conditions for device operation.

Recommended Operating Conditions

	Min	Nom	Max	Units
Supply Voltage (V_{CC})	3.0	3.3	3.6	V
Operating Free Air				
Temperature (T_A)	-10	+25	+70	°C
Receiver Input Range	0		2.4	V
Supply Noise Voltage (V_{CC})			100	mV _{PP}

Electrical Characteristics

Over recommended operating supply and temperature ranges unless otherwise specified

Symbol	Parameter	Conditions	Min	Typ	Max	Units
CMOS/TTL DC SPECIFICATIONS						
V_{IH}	High Level Input Voltage		2.0		V_{CC}	V
V_{IL}	Low Level Input Voltage		GND		0.8	V
V_{CL}	Input Clamp Voltage	$I_{CL} = -18$ mA		-0.79	-1.5	V
I_{IN}	Input Current	$V_{IN} = 0.4V, 2.5V$ or V_{CC}		+1.8	+15	μ A
		$V_{IN} = GND$	-10	0		μ A
I_{OS}	Output Short Circuit Current	$V_{OUT} = 0V$		-60	-120	mA
LVDS DRIVER DC SPECIFICATIONS						
V_{OD}	Differential Output Voltage	$R_L = 100\Omega$	250	290	450	mV
ΔV_{OD}	Change in V_{OD} between Complimentary Output States				35	mV

Electrical Characteristics (continued)

Over recommended operating supply and temperature ranges unless otherwise specified

Symbol	Parameter	Conditions	Min	Typ	Max	Units	
V_{OS}	Offset Voltage ⁽¹⁾		1.125	1.25	1.375	V	
ΔV_{OS}	Change in V_{OS} between Complimentary Output States				35	mV	
I_{OS}	Output Short Circuit Current	$V_{OUT} = 0V, R_L = 100\Omega$		-3.5	-5	mA	
I_{OZ}	Output TRI-STATE Current	$\overline{PWR\ DWN} = 0V, V_{OUT} = 0V \text{ or } V_{CC}$		± 1	± 10	μA	
TRANSMITTER SUPPLY CURRENT							
I_{CCTW}	Transmitter Supply Current Worst Case (with Loads)	$R_L = 100\Omega,$ $C_L = 5 \text{ pF},$ Worst Case Pattern (Figure 3 and Figure 4)	f = 33 MHz		28	42	mA
			f = 40 MHz		29	47	mA
			f = 66 MHz		34	52	mA
			f = 85 MHz		39	57	mA
I_{CCTZ}	Transmitter Supply Current Power Down	$\overline{PWR\ DWN} = \text{Low}$ Driver Outputs in TRI-STATE under Powerdown Mode		10	55	μA	

(1) V_{OS} previously referred as V_{CM} .

Transmitter Switching Characteristics

Over recommended operating supply and temperature ranges unless otherwise specified

Symbol	Parameter	Min	Typ	Max	Units	
LLHT	LVDS Low-to-High Transition Time (Figure 4)		0.75	1.5	ns	
LHLT	LVDS High-to-Low Transition Time (Figure 4)		0.75	1.5	ns	
TCIT	TxCLK IN Transition Time (Figure 5)	1.0		6.0	ns	
TPPos0	Transmitter Output Pulse Position for Bit0 (Figure 12)	f = 85 MHz	-0.20	0	0.20	ns
TPPos1	Transmitter Output Pulse Position for Bit1		1.48	1.68	1.88	ns
TPPos2	Transmitter Output Pulse Position for Bit2		3.16	3.36	3.56	ns
TPPos3	Transmitter Output Pulse Position for Bit3		4.84	5.04	5.24	ns
TPPos4	Transmitter Output Pulse Position for Bit4		6.52	6.72	6.92	ns
TPPos5	Transmitter Output Pulse Position for Bit5		8.20	8.40	8.60	ns
TPPos6	Transmitter Output Pulse Position for Bit6		9.88	10.08	10.28	ns
TCIP	TxCLK IN Period (Figure 7)	11.76	T	50	ns	
TCIH	TxCLK IN High Time (Figure 7)	0.35T	0.5T	0.65T	ns	
TCIL	TxCLK IN Low Time (Figure 7)	0.35T	0.5T	0.65T	ns	
TSTC	TxIN Setup to TxCLK IN (Figure 7)	f = 85 MHz	2.5		ns	
THTC	TxIN Hold to TxCLK IN (Figure 7)		0		ns	
TCCD	TxCLK IN to TxCLK OUT Delay @ 25°C, $V_{CC} = 3.3V$ (Figure 8)	3.8		6.3	ns	
TPLLS	Transmitter Phase Lock Loop Set (Figure 9)			10	ms	
TPDD	Transmitter Powerdown Delay (Figure 11)			100	ns	
TJIT	TxCLK IN Cycle-to-Cycle Jitter			2	ns	

AC Timing Diagrams

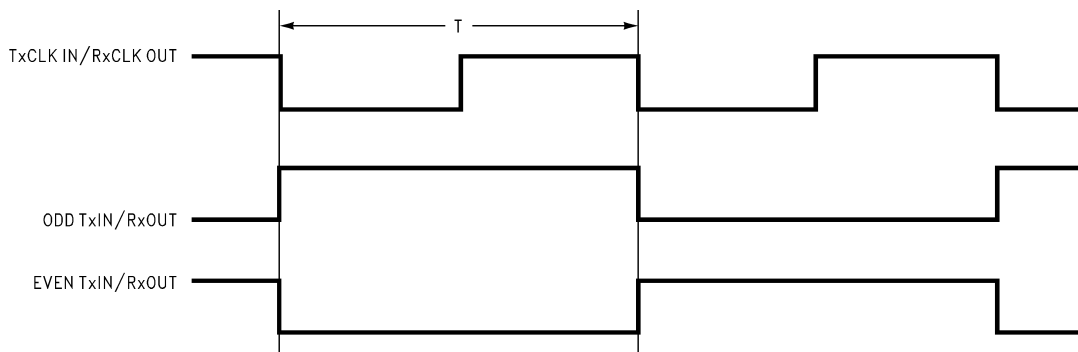

Figure 3. "Worst Case" Test Pattern

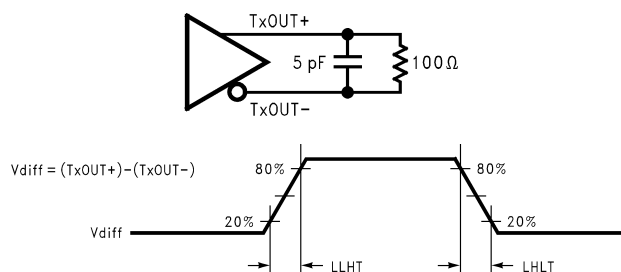

Figure 4. DS90CR217 (Transmitter) LVDS Output Load and Transition Times

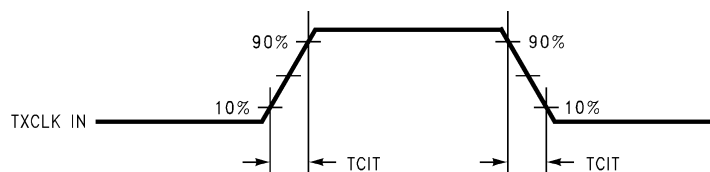
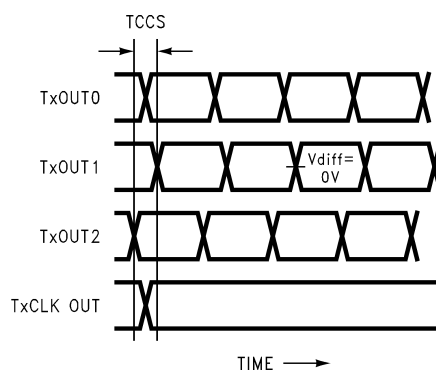

Figure 5. D590CR217 (Transmitter) Input Clock Transition Time



Measurements at $V_{DIFF} = 0V$
 TCCS measured between earliest and latest LVDS edges
 TxCLK Differential Low→High Edge

Figure 6. DS90CR217 (Transmitter) Channel-to-Channel Skew

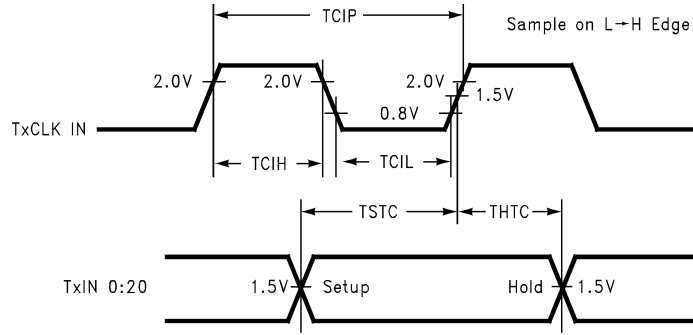

Figure 7. DS90CR217 (Transmitter) Setup/Hold and High/Low Times

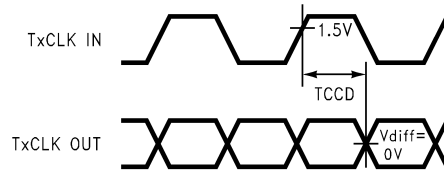

Figure 8. DS90CR217 (Transmitter) Clock In to Clock Out Delay

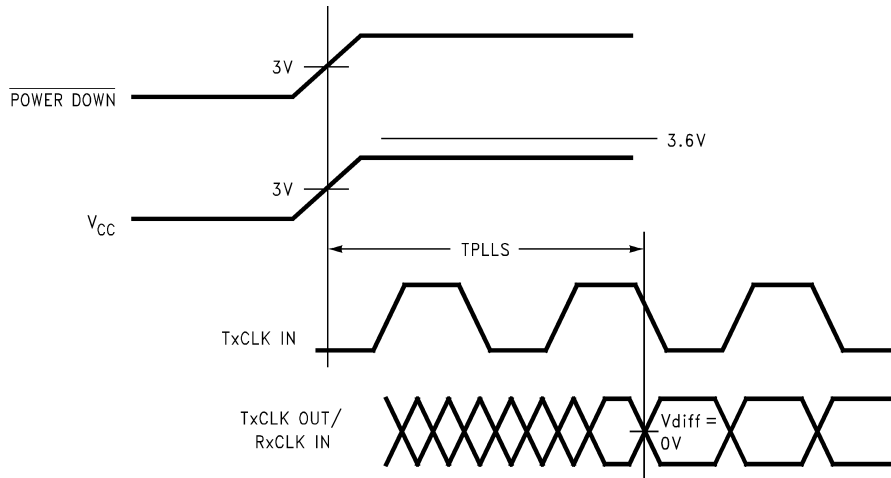

Figure 9. DS90CR217 (Transmitter) Phase Lock Loop Set Time

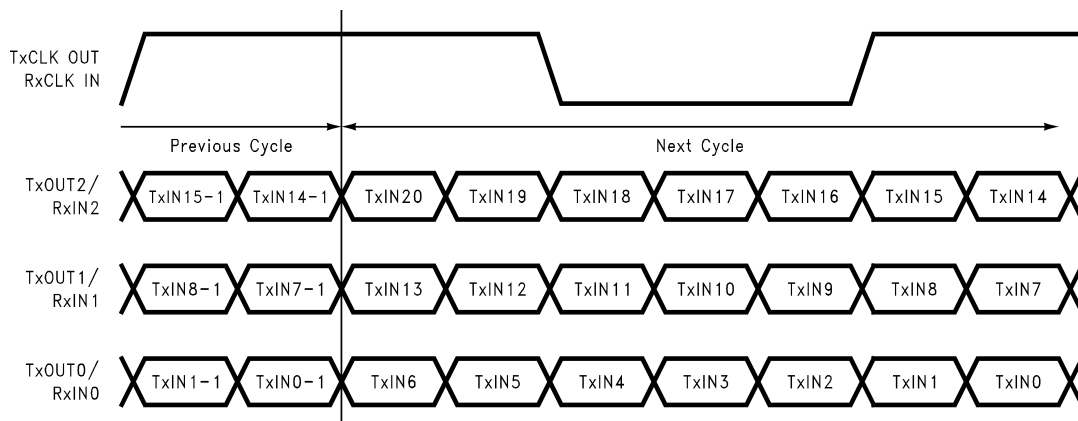

Figure 10. 21 Parallel TTL Data Inputs Mapped to LVDS Outputs (DS90CR217)

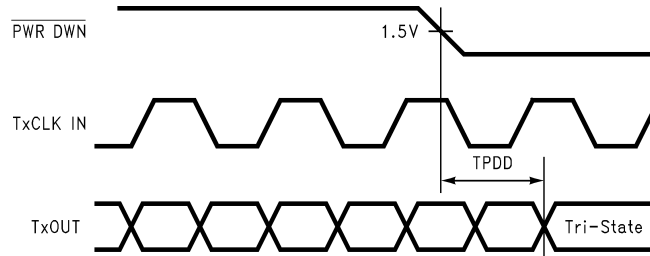

Figure 11. Transmitter Powerdown Delay

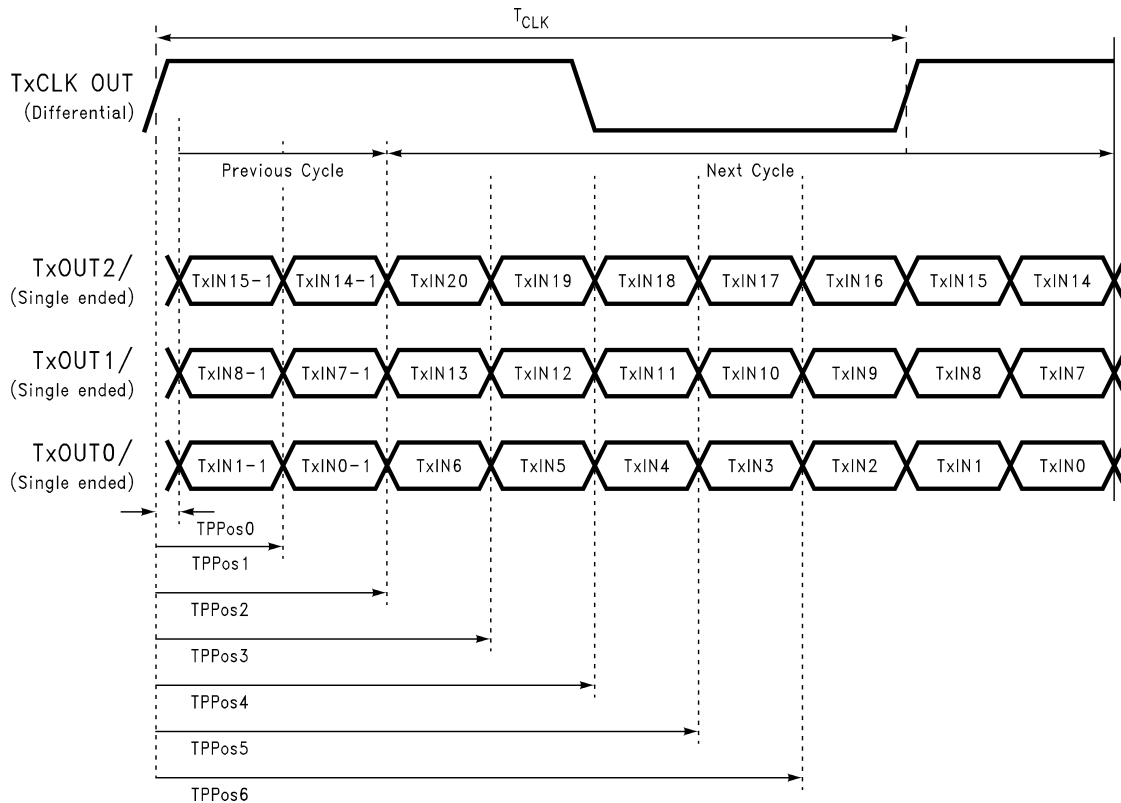

Figure 12. Transmitter LVDS Output Pulse Position Measurement

APPLICATIONS INFORMATION

Table 1. DS90CR217 PIN DESCRIPTIONS — CHANNEL LINK TRANSMITTER

Pin Name	I/O	No.	Description
TxIN	I	21	TTL level input.
TxOUT+	O	3	Positive LVDS differential data output.
TxOUT-	O	3	Negative LVDS differential data output.
TxCLK IN	I	1	TTL level clock input. The rising edge acts as data strobe. Pin name TxCLK IN.
TxCLK OUT+	O	1	Positive LVDS differential clock output.
TxCLK OUT-	O	1	Negative LVDS differential clock output.
PWR DWN	I	1	TTL level input. Assertion (low input) TRI-STATEs the outputs, ensuring low current at power down. See Applications Information section.
V _{CC}	I	4	Power supply pins for TTL inputs.
GND	I	5	Ground pins for TTL inputs.
PLL V _{CC}	I	1	Power supply pins for PLL.
PLL GND	I	2	Ground pins for PLL.
LVDS V _{CC}	I	1	Power supply pin for LVDS outputs.
LVDS GND	I	3	Ground pins for LVDS outputs.

The Channel Link devices are intended to be used in a wide variety of data transmission applications. Depending upon the application the interconnecting media may vary. For example, for lower data rate (clock rate) and shorter cable lengths (< 2m), the media electrical performance is less critical. For higher speed/long distance applications the media's performance becomes more critical. Certain cable constructions provide tighter skew (matched electrical length between the conductors and pairs). Twin-coax for example, has been demonstrated at distances as great as 5 meters and with the maximum data transfer of 1.785 Gbit/s. Additional applications information can be found in the following Interface Application Notes:

AN = ####	Topic
AN-1041 (SNLA218)	Introduction to Channel Link
AN-1108 (SNLA008)	Channel Link PCB and Interconnect Design-In Guidelines
AN-1109 (SNLA220)	Multi-Drop Channel-Link Operation
AN-806 (SNLA026)	Transmission Line Theory
AN-905 (SNLA035)	Transmission Line Calculations and Differential Impedance
AN-916 (SNLA219)	Cable Information

CABLES

A cable interface between the transmitter and receiver needs to support the differential LVDS pairs. The ideal cable/connector interface would have a constant 100Ω differential impedance throughout the path. It is also recommended that cable skew remain below 90ps (@ 85 MHz clock rate) to maintain a sufficient data sampling window at the receiver.

In addition to the four or five cable pairs that carry data and clock, it is recommended to provide at least one additional conductor (or pair) which connects ground between the transmitter and receiver. This low impedance ground provides a common-mode return path for the two devices. Some of the more commonly used cable types for point-to-point applications include flat ribbon, flex, twisted pair and Twin-Coax. All are available in a variety of configurations and options. Flat ribbon cable, flex and twisted pair generally perform well in short point-to-point applications while Twin-Coax is good for short and long applications. When using ribbon cable, it is recommended to place a ground line between each differential pair to act as a barrier to noise coupling between adjacent pairs. For Twin-Coax cable applications, it is recommended to utilize a shield on each cable pair. All extended point-to-point applications should also employ an overall shield surrounding all cable pairs regardless of the cable type. This overall shield results in improved transmission parameters such as faster attainable speeds, longer distances between transmitter and receiver and reduced problems associated with EMS or EMI.

The high-speed transport of LVDS signals has been demonstrated on several types of cables with excellent results. However, the best overall performance has been seen when using Twin-Coax cable. Twin-Coax has very low cable skew and EMI due to its construction and double shielding. All of the design considerations discussed here and listed in the supplemental application notes provide the subsystem communications designer with many useful guidelines. It is recommended that the designer assess the tradeoffs of each application thoroughly to arrive at a reliable and economical cable solution.

BOARD LAYOUT

To obtain the maximum benefit from the noise and EMI reductions of LVDS, attention should be paid to the layout of differential lines. Lines of a differential pair should always be adjacent to eliminate noise interference from other signals and take full advantage of the noise canceling of the differential signals. The board designer should also try to maintain equal length on signal traces for a given differential pair. As with any high-speed design, the impedance discontinuities should be limited (reduce the numbers of vias and no 90 degree angles on traces). Any discontinuities which do occur on one signal line should be mirrored in the other line of the differential pair. Care should be taken to ensure that the differential trace impedance match the differential impedance of the selected physical media (this impedance should also match the value of the termination resistor that is connected across the differential pair at the receiver's input). Finally, the location of the CHANNEL LINK TxOUT pins should be as close as possible to the board edge so as to eliminate excessive pcb runs. All of these considerations will limit reflections and crosstalk which adversely effect high frequency performance and EMI.

UNUSED INPUTS

All unused inputs at the TxIN inputs of the transmitter may be tied to ground or left no connect.

TERMINATION

Use of current mode drivers requires a terminating resistor across the receiver inputs. The CHANNEL LINK chipset will normally require a single 100Ω resistor between the true and complement lines on each differential pair of the receiver input. The actual value of the termination resistor should be selected to match the differential mode characteristic impedance (90Ω to 120Ω typical) of the cable. Figure 13 shows an example. No additional pull-up or pull-down resistors are necessary as with some other differential technologies such as PECL. Surface mount resistors are recommended to avoid the additional inductance that accompanies leaded resistors. These resistors should be placed as close as possible to the receiver input pins to reduce stubs and effectively terminate the differential lines.

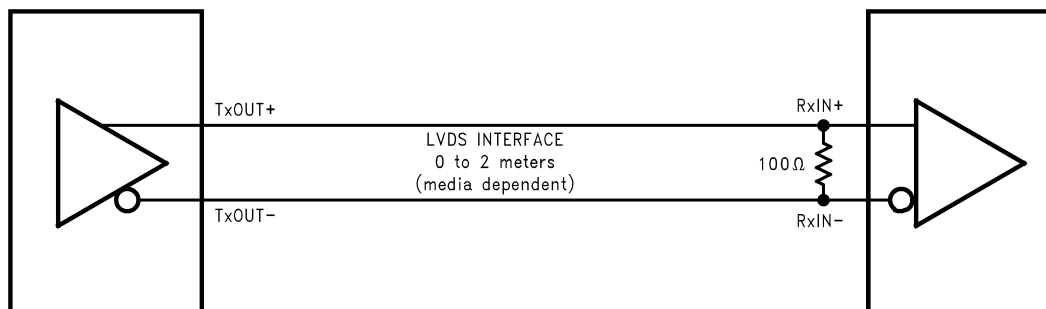
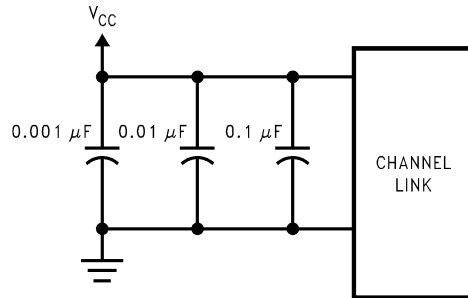

Figure 13. LVDS Serialized Link Termination

DECOUPLING CAPACITORS

Bypassing capacitors are needed to reduce the impact of switching noise which could limit performance. For a conservative approach three parallel-connected decoupling capacitors (Multi-Layered Ceramic type in surface mount form factor) between each V_{CC} and the ground plane(s) are recommended. The three capacitor values are 0.1 μF, 0.01 μF and 0.001 μF. An example is shown in Figure 14. The designer should employ wide traces for power and ground and ensure each capacitor has its own via to the ground plane. If board space is limiting the number of bypass capacitors, the PLL V_{CC} should receive the most filtering/bypassing. Next would be the LVDS V_{CC} pins and finally the logic V_{CC} pins.



**Figure 14. CHANNEL LINK
Decoupling Configuration**

CLOCK JITTER

The CHANNEL LINK devices employ a PLL to generate and recover the clock transmitted across the LVDS interface. The width of each bit in the serialized LVDS data stream is one-seventh the clock period. For example, a 85 MHz clock has a period of 11.76 ns which results in a data bit width of 1.68 ns. Differential skew (Δt within one differential pair), interconnect skew (Δt of one differential pair to another) and clock jitter will all reduce the available window for sampling the LVDS serial data streams. Care must be taken to ensure that the clock input to the transmitter be a clean low noise signal. Individual bypassing of each V_{CC} to ground will minimize the noise passed on to the PLL, thus creating a low jitter LVDS clock. These measures provide more margin for channel-to-channel skew and interconnect skew as a part of the overall jitter/skew budget.

COMMON-MODE vs. DIFFERENTIAL MODE NOISE MARGIN

The typical signal swing for LVDS is 300 mV centered at +1.2V. The CHANNEL LINK receiver supports a 100 mV threshold therefore providing approximately 200 mV of differential noise margin. Common-mode protection is of more importance to the system's operation due to the differential data transmission. LVDS supports an input voltage range of Ground to +2.4V. This allows for a $\pm 1.0V$ shifting of the center point due to ground potential differences and common-mode noise.

TRANSMITTER INPUT CLOCK

The transmitter input clock must always be present when the device is enabled ($\overline{PWR\ DWN} = \text{HIGH}$). If the clock is stopped, the $\overline{PWR\ DWN}$ pin must be used to disable the PLL. The $\overline{PWR\ DWN}$ pin must be held low until after the input clock signal has been reapplied. This will ensure a proper device reset and PLL lock to occur.

POWER SEQUENCING AND POWERDOWN MODE

Outputs of the CHANNEL LINK transmitter remain in TRI-STATE until the power supply reaches 2V. Clock and data outputs will begin to toggle 10 ms after V_{CC} has reached 3V and the Powerdown pin is above 1.5V. Either device may be placed into a powerdown mode at any time by asserting the Powerdown pin (active low). Total power dissipation for each device will decrease to 5 μW (typical).

The transmitter input clock may be applied prior to powering up and enabling the transmitter. The transmitter input clock may also be applied after power up; however, the use of the $\overline{PWR\ DWN}$ pin is required as described in the [TRANSMITTER INPUT CLOCK](#) section. Do not power up and enable ($\overline{PWR\ DWN} = \text{HIGH}$) the transmitter without a valid clock signal applied to the TxCLK IN pin.

The CHANNEL LINK chipset is designed to protect itself from accidental loss of power to either the transmitter or receiver. If power to the transmit board is lost, the receiver clocks (input and output) stop. The data outputs (RxOUT) retain the states they were in when the clocks stopped. When the receiver board loses power, the receiver inputs are shorted to V_{CC} through an internal diode. Current is limited (5 mA per input) by the fixed current mode drivers, thus avoiding the potential for latchup when powering the device.

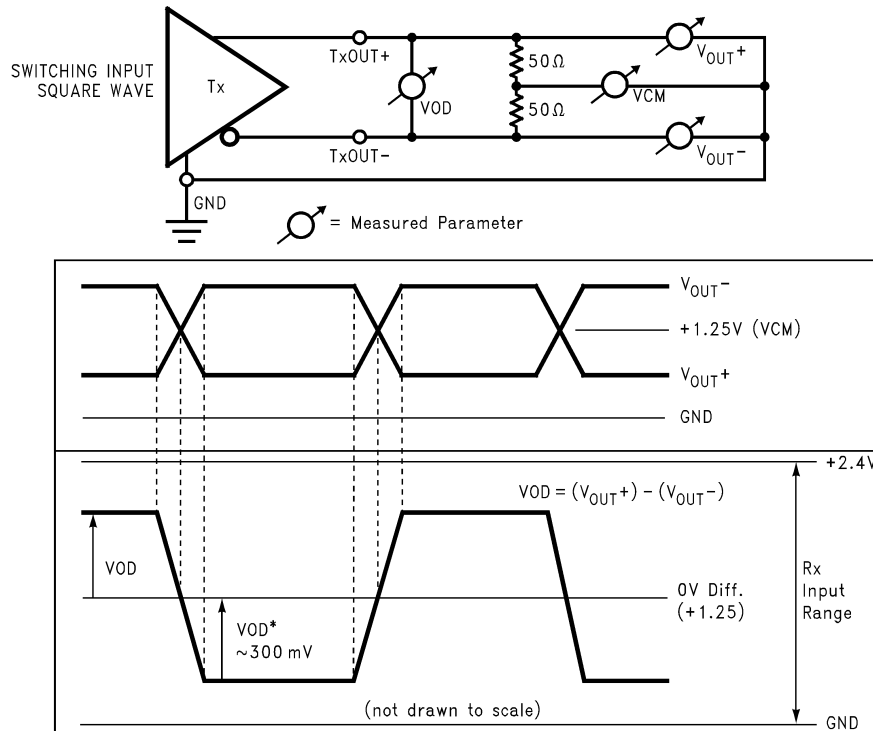



Figure 15. Single-Ended and Differential Waveforms

REVISION HISTORY

Changes from Original (February 2013) to Revision A	Page
• Changed layout of National Data Sheet to TI format	11

PACKAGING INFORMATION

Orderable Device	Status (1)	Package Type	Package Drawing	Pins	Package Qty	Eco Plan (2)	Lead finish/ Ball material (6)	MSL Peak Temp (3)	Op Temp (°C)	Device Marking (4/5)	Samples
DS90CR217MTD/NOPB	ACTIVE	TSSOP	DGG	48	38	RoHS & Green	SN	Level-2-260C-1 YEAR	-10 to 70	DS90CR217MTD >B	
DS90CR217MTDX/NOPB	ACTIVE	TSSOP	DGG	48	1000	RoHS & Green	SN	Level-2-260C-1 YEAR	-10 to 70	DS90CR217MTD >B	

(1) The marketing status values are defined as follows:

ACTIVE: Product device recommended for new designs.

LIFEBUY: TI has announced that the device will be discontinued, and a lifetime-buy period is in effect.

NRND: Not recommended for new designs. Device is in production to support existing customers, but TI does not recommend using this part in a new design.

PREVIEW: Device has been announced but is not in production. Samples may or may not be available.

OBSOLETE: TI has discontinued the production of the device.

(2) **RoHS:** TI defines "RoHS" to mean semiconductor products that are compliant with the current EU RoHS requirements for all 10 RoHS substances, including the requirement that RoHS substance do not exceed 0.1% by weight in homogeneous materials. Where designed to be soldered at high temperatures, "RoHS" products are suitable for use in specified lead-free processes. TI may reference these types of products as "Pb-Free".

RoHS Exempt: TI defines "RoHS Exempt" to mean products that contain lead but are compliant with EU RoHS pursuant to a specific EU RoHS exemption.

Green: TI defines "Green" to mean the content of Chlorine (Cl) and Bromine (Br) based flame retardants meet JS709B low halogen requirements of <=1000ppm threshold. Antimony trioxide based flame retardants must also meet the <=1000ppm threshold requirement.

(3) MSL, Peak Temp. - The Moisture Sensitivity Level rating according to the JEDEC industry standard classifications, and peak solder temperature.

(4) There may be additional marking, which relates to the logo, the lot trace code information, or the environmental category on the device.

(5) Multiple Device Markings will be inside parentheses. Only one Device Marking contained in parentheses and separated by a "~" will appear on a device. If a line is indented then it is a continuation of the previous line and the two combined represent the entire Device Marking for that device.

(6) Lead finish/Ball material - Orderable Devices may have multiple material finish options. Finish options are separated by a vertical ruled line. Lead finish/Ball material values may wrap to two lines if the finish value exceeds the maximum column width.

Important Information and Disclaimer:The information provided on this page represents TI's knowledge and belief as of the date that it is provided. TI bases its knowledge and belief on information provided by third parties, and makes no representation or warranty as to the accuracy of such information. Efforts are underway to better integrate information from third parties. TI has taken and continues to take reasonable steps to provide representative and accurate information but may not have conducted destructive testing or chemical analysis on incoming materials and chemicals. TI and TI suppliers consider certain information to be proprietary, and thus CAS numbers and other limited information may not be available for release.

In no event shall TI's liability arising out of such information exceed the total purchase price of the TI part(s) at issue in this document sold by TI to Customer on an annual basis.

TAPE AND REEL INFORMATION

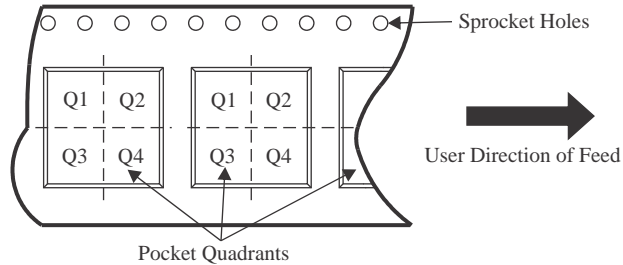
QUADRANT ASSIGNMENTS FOR PIN 1 ORIENTATION IN TAPE

*All dimensions are nominal

Device	Package Type	Package Drawing	Pins	SPQ	Reel Diameter (mm)	Reel Width W1 (mm)	A0 (mm)	B0 (mm)	K0 (mm)	P1 (mm)	W (mm)	Pin1 Quadrant
DS90CR217MTDX/NOPB	TSSOP	DGG	48	1000	330.0	24.4	8.6	13.2	1.6	12.0	24.0	Q1

TAPE AND REEL BOX DIMENSIONS

*All dimensions are nominal

Device	Package Type	Package Drawing	Pins	SPQ	Length (mm)	Width (mm)	Height (mm)
DS90CR217MTDX/NOPB	TSSOP	DGG	48	1000	356.0	356.0	45.0

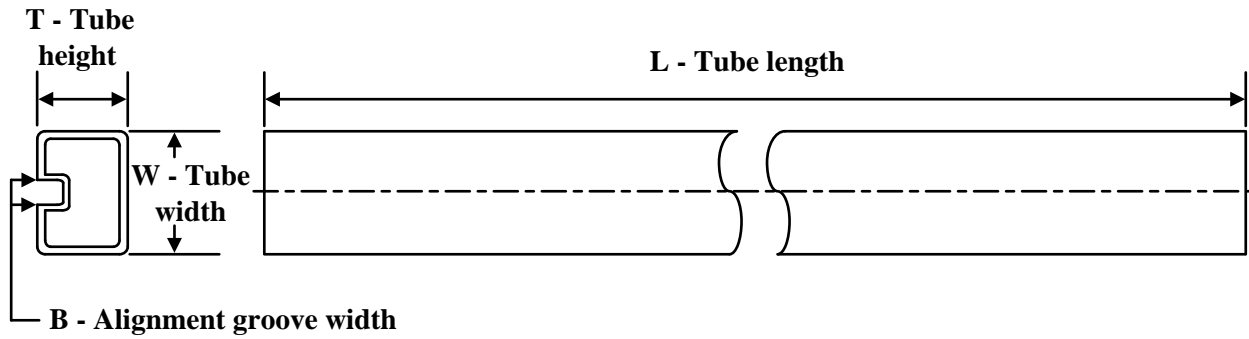
TUBE

*All dimensions are nominal

Device	Package Name	Package Type	Pins	SPQ	L (mm)	W (mm)	T (μm)	B (mm)
DS90CR217MTD/NOPB	DGG	TSSOP	48	38	495	10	2540	5.79

EXAMPLE BOARD LAYOUT

DGG0048A

TSSOP - 1.2 mm max height

SMALL OUTLINE PACKAGE

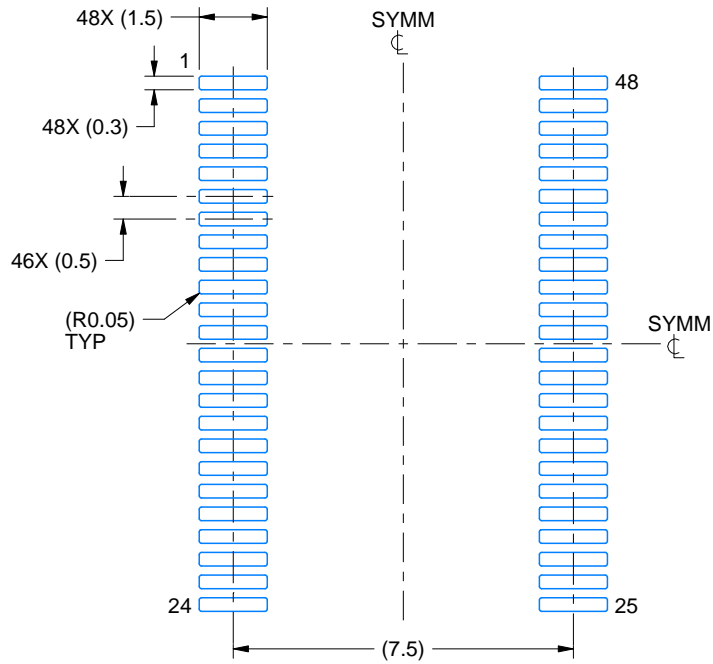

LAND PATTERN EXAMPLE
SCALE:6X

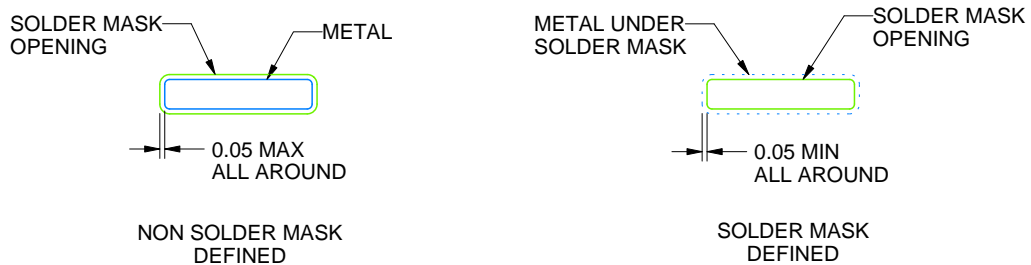

SOLDER MASK DETAILS

4214859/B 11/2020

NOTES: (continued)

- 5. Publication IPC-7351 may have alternate designs.
- 6. Solder mask tolerances between and around signal pads can vary based on board fabrication site.

EXAMPLE STENCIL DESIGN

DGG0048A

TSSOP - 1.2 mm max height

SMALL OUTLINE PACKAGE

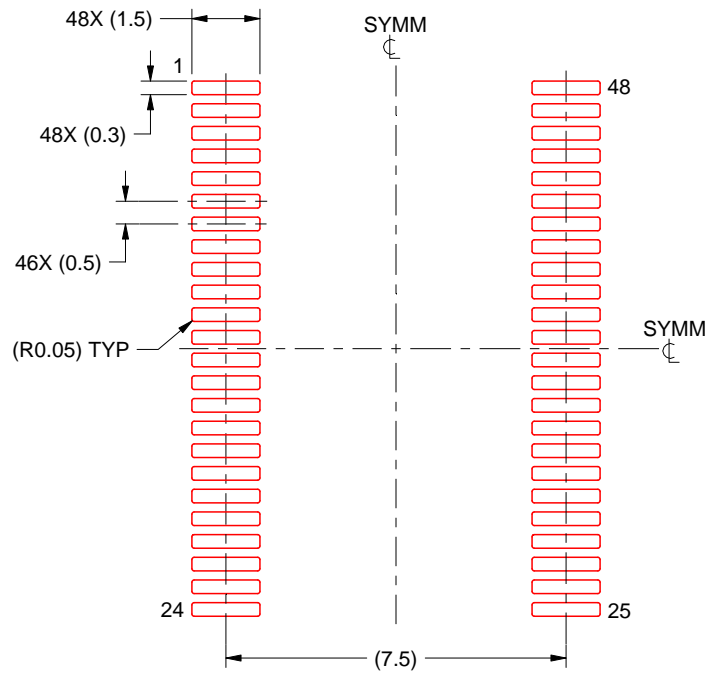

SOLDER PASTE EXAMPLE
BASED ON 0.125 mm THICK STENCIL
SCALE:6X

4214859/B 11/2020

NOTES: (continued)

7. Laser cutting apertures with trapezoidal walls and rounded corners may offer better paste release. IPC-7525 may have alternate design recommendations.
8. Board assembly site may have different recommendations for stencil design.

DGG (R-PDSO-G**)

PLASTIC SMALL-OUTLINE PACKAGE

48 PINS SHOWN

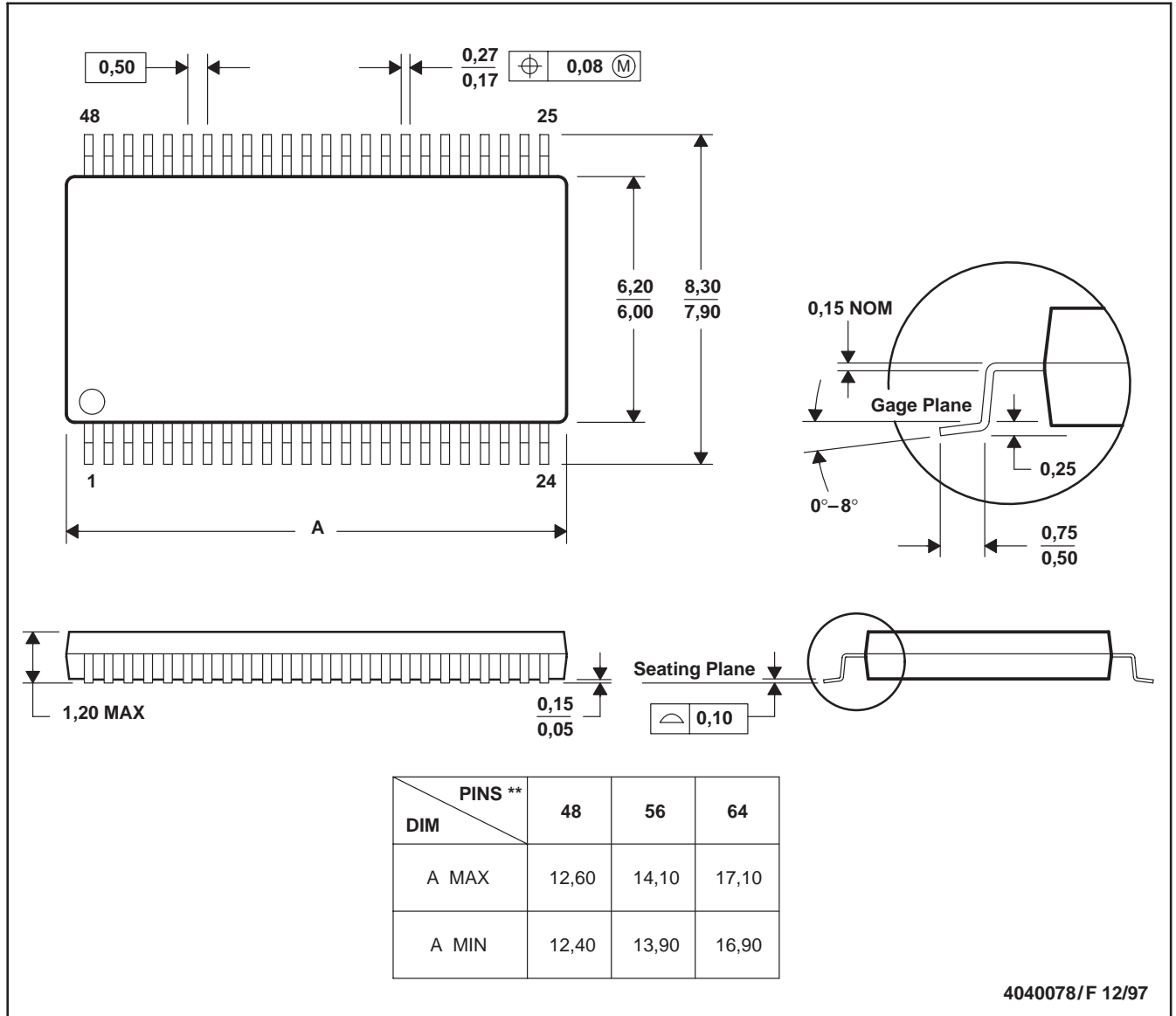

- NOTES: A. All linear dimensions are in millimeters.
 B. This drawing is subject to change without notice.
 C. Body dimensions do not include mold protrusion not to exceed 0,15.
 D. Falls within JEDEC MO-153

IMPORTANT NOTICE AND DISCLAIMER

TI PROVIDES TECHNICAL AND RELIABILITY DATA (INCLUDING DATA SHEETS), DESIGN RESOURCES (INCLUDING REFERENCE DESIGNS), APPLICATION OR OTHER DESIGN ADVICE, WEB TOOLS, SAFETY INFORMATION, AND OTHER RESOURCES "AS IS" AND WITH ALL FAULTS, AND DISCLAIMS ALL WARRANTIES, EXPRESS AND IMPLIED, INCLUDING WITHOUT LIMITATION ANY IMPLIED WARRANTIES OF MERCHANTABILITY, FITNESS FOR A PARTICULAR PURPOSE OR NON-INFRINGEMENT OF THIRD PARTY INTELLECTUAL PROPERTY RIGHTS.

These resources are intended for skilled developers designing with TI products. You are solely responsible for (1) selecting the appropriate TI products for your application, (2) designing, validating and testing your application, and (3) ensuring your application meets applicable standards, and any other safety, security, regulatory or other requirements.

These resources are subject to change without notice. TI grants you permission to use these resources only for development of an application that uses the TI products described in the resource. Other reproduction and display of these resources is prohibited. No license is granted to any other TI intellectual property right or to any third party intellectual property right. TI disclaims responsibility for, and you will fully indemnify TI and its representatives against, any claims, damages, costs, losses, and liabilities arising out of your use of these resources.

TI's products are provided subject to [TI's Terms of Sale](#) or other applicable terms available either on [ti.com](https://www.ti.com) or provided in conjunction with such TI products. TI's provision of these resources does not expand or otherwise alter TI's applicable warranties or warranty disclaimers for TI products.

TI objects to and rejects any additional or different terms you may have proposed.

Mailing Address: Texas Instruments, Post Office Box 655303, Dallas, Texas 75265
Copyright © 2024, Texas Instruments Incorporated