

LMx24、LMx24x、LMx24xx、LM2902、LM2902x、LM2902xx、LM2902xxx 四路运算放大器

1 特性

- 下一代 LM324B 和 LM2902B
- B 版本可直接替代所有版本的 LM224、LM324 和 LM2902
- 改进了 B 版本的规格
 - 电源电压范围：3V 至 36V (B、BA 版本)
 - 低输入失调电压： $\pm 2\text{mV}$ (BA 版本) / 3mV (B 版本)
 - ESD 等级：2kV (HBM)，1.5kV (CDM)
 - EMI 抑制：集成射频和 EMI 滤波器
 - 低输入偏置电流：最大值为 50nA (在 -40°C 至 125°C 范围内)
- 共模输入电压范围包括 V -
- 输入电压差可驱动至电源电压
- 有关双路 B 版本，请参阅 [LM358B](#) 和 [LM2904B](#)

2 应用

- 商用网络和服务电源单元
- 多功能打印机
- 电源和移动充电器
- 台式计算机和主板
- 室内外空调
- 洗衣机、烘干机和冰箱
- 交流逆变器、串式逆变器、中央逆变器和变频器
- 不间断电源

3 说明

LM324B 和 LM2902B 器件是业界通用运算放大器 LM324 和 LM2902 的下一代版本，其中包括四个高压 (36V) 运算放大器。这些器件为成本敏感型应用提供了卓越的价值，

其特性包括低失调电压 ($600\mu\text{V}$ ，典型值)、接地共模输入范围以及高差分输入电压能力。

LM324B 和 LM2902B 的特点是单位增益稳定，每个放大器可实现最大 3mV (LM324BA 和 LM2902BA 最大 2mV) 的低失调电压和 $240\mu\text{A}$ (典型值) 的静态电流。高 ESD (2kV HBM 和 1.5kV CDM) 和集成 EMI 以及射频滤波器可支持将 LM324B 和 LM2902B 器件用于更严苛、更具环境挑战性的应用。

LM324B 和 LM2902B 可直接替代所有版本的 LM224、LM324 和 LM2902 器件。

封装信息

器件型号 ⁽¹⁾	封装	封装尺寸 ⁽²⁾
LM324B、LM324BA、LM2902B、LM2902BA、LM324xx、LM224xx、LM124、LM2902xxx	D (SOIC , 14)	8.65mm × 6mm
LM324B、LM324BA、LM2902B、LM2902BA、LM324xx、LM124、LM2902xxx	PW (TSSOP , 14)	5mm × 6.4mm
LM324xx、LM224xx、LM2902xxx	N (PDIP , 14)	19.3mm × 9.4mm
LM324、LM324A、LM324K、LM324KA、LM2902、LM2902K	NS (SOP , 14)	10.3mm × 7.8mm
LM324A、LM2902K	DB (SSOP , 14)	6.2mm × 7.8mm
LM124A	J (CDIP , 14)	19.56mm × 6.67mm
	W (CFP , 14)	9.21mm × 6.3mm
	FK (LCCC , 20)	8.89mm × 8.89mm
LM324B、LM2902B	RTE (WQFN , 16 ⁽³⁾)	3mm × 3mm

(1) 有关更多信息，请参阅节 11。

(2) 封装尺寸 (长 × 宽) 为标称值，并包括引脚 (如适用)。

(3) 此封装仅为预发布状态。

系列产品比较

规格	LM324B LM324BA	LM2902B LM2902BA	LM324 LM324A	LM324K LM324KA	LM2902	LM2902K LM2902KV LM2902KAV	LM224 LM224A	LM224K LM224KA	LM124 LM124A	单位
电源电压	3 至 36	3 至 36	3 至 30	3 至 30	3 至 26	3 至 26 (K) 3 至 30 (kV、KAV)	3 至 30	3 至 30	3 至 30	V
失调电压 (25°C 时的最大值)	± 3 ± 2	± 3 ± 2	± 7 ± 3	± 7 ± 3	± 7	± 7 (K、kV) ± 2 (KAV)	± 5 ± 3	± 5 ± 3	± 5 ± 2	mV
25°C 时的输入偏置电流 (典型值/最大值)	10/35	10/35	20/250 15/100	20/250 15/100	20/250	20/250	20/150 15/80	20/150 15/80	20/150 - /50	nA
ESD (HBM)	2000	2000	500	2000	500	2000	500	2000	500	V
工作环境温度	-40 至 85	-40 至 125	0 至 70	0 至 70	-40 至 125	-40 至 125	-25 至 85	-25 至 85	-55 至 125	$^{\circ}\text{C}$



内容

1 特性	1	7 详细说明	21
2 应用	1	7.1 概述.....	21
3 说明	1	7.2 功能方框图.....	22
4 引脚配置和功能	3	7.3 特性说明.....	23
5 规格	5	7.4 器件功能模式.....	23
5.1 绝对最大额定值.....	5	8 应用和实现	24
5.2 ESD 等级.....	5	8.1 应用信息.....	24
5.3 建议运行条件.....	5	8.2 典型应用.....	24
5.4 热性能信息.....	6	8.3 电源相关建议.....	25
5.5 电气特性 - LM324B 和 LM324BA.....	7	8.4 布局.....	25
5.6 电气特性 - LM2902B 和 LM2902BA.....	9	9 器件和文档支持	27
5.7 LM324、LM324K、LM224、LM224K 和 LM124 的电气特性.....	11	9.1 接收文档更新通知.....	27
5.8 LM2902、LM2902K、LM2902KV 和 LM2902KAV 的电气特性.....	12	9.2 支持资源.....	27
5.9 LM324A、LM324KA、LM224A、LM224KA 和 LM124A 的电气特性.....	13	9.3 商标.....	27
5.10 运行条件.....	13	9.4 静电放电警告.....	27
5.11 典型特性.....	14	9.5 术语表.....	27
5.12 典型特性：B 和 BA 版本以外的所有器件.....	20	10 修订历史记录	27
6 参数测量信息	21	11 机械、封装和可订购信息	28
		11.1 封装选项附录.....	29
		11.2 卷带包装信息.....	30

4 引脚配置和功能



图 4-1. D、DB、J、N、NS、PW 和 W 封装
14 引脚 SOIC、SSOP、CDIP、PDIP、SO、TSSOP
和 CFP
(顶视图)



图 4-2. FK 封装,
20 引脚 LCCC
(顶视图)

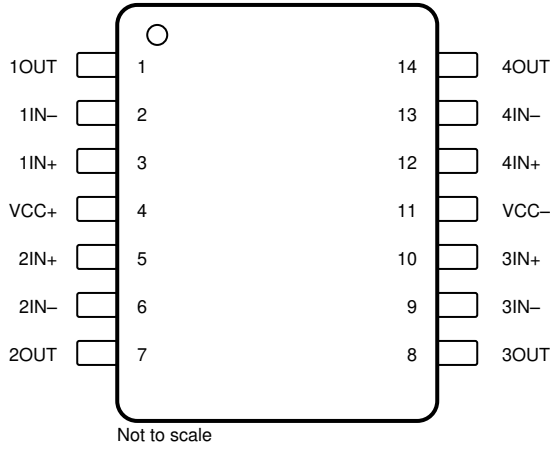

注意：RTE 封装仅为预发布状态

图 4-3. RTE 封装,
16 引脚 WQFN
(顶视图)

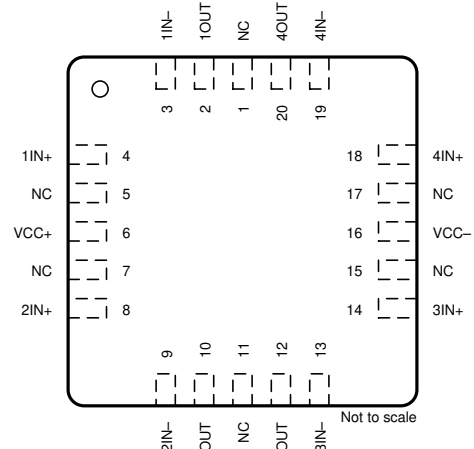
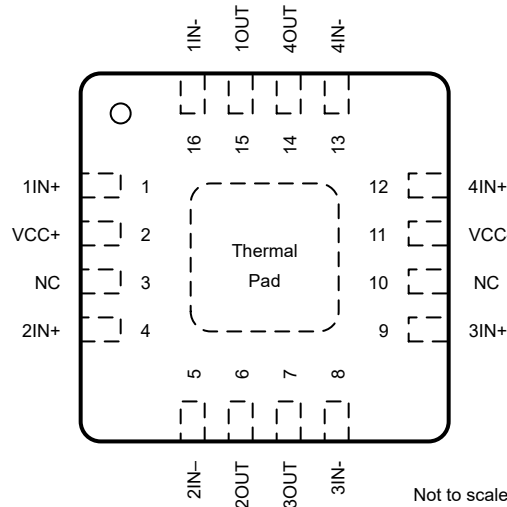
表 4-1. 引脚功能

名称	引脚			类型 ⁽¹⁾	说明
	LCCC	SOIC、TSSOP、PDIP、SSOP、SO、CDIP 和 CFP	WQFN		
1IN -	3	2	16	I	负输入
1IN+	4	3	1	I	正输入
1OUT	2	1	15	O	输出

表 4-1. 引脚功能 (续)

名称	引脚			类型 ⁽¹⁾	说明
	LCCC	SOIC、 TSSOP、 PDIP、SSOP、 SO、CDIP 和 CFP	WQFN		
2IN -	9	6	5	I	负输入
2IN+	8	5	4	I	正输入
2OUT	10	7	6	O	输出
3IN -	13	9	8	I	负输入
3IN+	14	10	9	I	正输入
3OUT	12	8	7	O	输出
4IN -	19	13	13	I	负输入
4IN+	18	12	12	I	正输入
4OUT	20	14	14	O	输出
V _{CC-}	16	11	11	—	负 (最低) 电源或接地 (对于单电源供电)
NC	1、5、7、11、 15、17	—	3、10	—	不连接
V _{CC+}	6	4	2	—	正 (最高) 电源

(1) I = 输入, O = 输出

5 规格

5.1 绝对最大额定值

在自然通风条件下的工作温度范围内测得 (除非另有说明) ⁽¹⁾

	LM324B、LM324BA、 LM2902B、LM2902BA		LM2902		LM324xx、LM224xx、 LM2902xxx、LM124x		单位	
	最小值	最大值	最小值	最大值	最小值	最大值		
电源电压, V_{CC} ⁽²⁾		40		26		32	V	
差分输入电压, V_{ID} ⁽³⁾		±40		±26		±32	V	
输入电压 V_I (任一输入)	-0.3	40	-0.3	26	-0.3	32	V	
输出对地短路 (一个放大器) 的持续时间 (在或低于 $T_A = 25^\circ\text{C}$ 、 $V_{CC} \leq 15\text{V}$ 条件下) ⁽⁴⁾		无限		无限		无限		
运行虚拟结温 T_J		150		150		150	$^\circ\text{C}$	
60 秒内的外壳温度	FK 封装					260	$^\circ\text{C}$	
60 秒内距离外壳 1.6 mm (1/16 英寸) 的引线温度	J 或 W 封装			300		300	$^\circ\text{C}$	
贮存温度, T_{stg}		-65	150	-65	150	-65	150	$^\circ\text{C}$

- (1) 应力超出绝对最大额定值下列出的值可能会对器件造成损坏。这些仅为压力额定值,并不表示器件在这些条件下以及在建议运行条件以外的任何其他条件下能够正常运行。长时间在最大绝对额定条件下运行会影响器件可靠性。
- (2) 所有电压值 (差分电压和为 I_{OS} 测量指定的 V_{CC} 除外) 都是相对于网络 GND 的值。
- (3) 差分电压是相对于 $IN-$ 的 $IN+$ 上的值。
- (4) 从输出到 V_{CC} 的短路会导致过热,并且最终会发生损坏。

5.2 ESD 等级

		值	单位
LM324B、LM324BA、LM2902B、LM2902BA、LM224K、LM224KA、 LM324K、LM324KA、LM2902K、LM2902KV、LM2902KAV			
$V_{(ESD)}$ 静电放电	人体放电模型 (HBM), 符合 ANSI/ESDA/JEDEC JS-001 标准 ⁽¹⁾	±2000	V
	充电器件模型 (CDM), 符合 JEDEC 规范 JESD22-C101	±1000	
LM124、LM124A、LM224、LM224A、LM324、LM324A、LM2902			
$V_{(ESD)}$ 静电放电	人体放电模型 (HBM), 符合 ANSI/ESDA/JEDEC JS-001 标准 ⁽¹⁾	±500	V
	充电器件模型 (CDM), 符合 JEDEC 规范 JESD22-C101	±1000	

- (1) JEDEC 文档 JEP155 指出: 500V HBM 时能够在标准 ESD 控制流程下安全生产。

5.3 建议运行条件

在自然通风条件下的工作温度范围内测得 (除非另有说明)

	LM324B、LM324BA、 LM2902B、LM2902BA		LM2902		LM324xx、LM224xx、 LM2902xxx、LM124x		单位
	最小值	最大值	最小值	最大值	最小值	最大值	
V_{CC} 电源电压	3	36	3	26	3	30	V
V_{CM} 共模电压	0	$V_{CC} - 2$	0	$V_{CC} - 2$	0	$V_{CC} - 2$	V
T_A 自然通风条件下的 工作温度	LM124x				-55	125	$^\circ\text{C}$
	LM2902xxx、 LM2902Bx	-40	125	-40	125		
	LM324Bx	-40	85				
	LM224xx				-25	85	
	LM324xx				0	70	

5.4 热性能信息

热指标 ⁽¹⁾	LMx24、LM2902						LMx24			单位
	D (SOIC)	DB (SSOP)	N (PDIP)	NS (SO)	PW (TSSOP)	RTE (WQFN) ⁽⁵⁾	FK (LCCC)	J (CDIP)	W (CFP)	
	14 引脚	14 引脚	14 引脚	14 引脚	14 引脚	16 引脚	20 引脚	14 引脚	14 引脚	
R _{θJA} ^{(2) (3)} 结至环境热阻	99.3	106.5	83.5	90.4	124.7	64.9	74.5	84.7	153.4	°C/W
R _{θJC(top)} ⁽⁴⁾ 结至外壳 (顶部) 热阻	60.4	55.5	62.0	48.0	57.9	68.8	49.9	37.5	72.7	°C/W
R _{θJB}	57.5	56.8	57.7	49.2	80.7	40.2	49.0	72.2	146.5	
ψ _{JT}	19.8	18.2	40.5	14.4	8.4	4.9	42.9	31.0	48.3	
ψ _{JB}	57.0	55.8	57.1	48.8	79.8	40.0	48.9	67.3	129.2	
R _{θJC(bot)} 结至外壳 (底部) 热阻	—	—	—	—	—	23.6	7.3	18.8	10.1	°C/W

- (1) 有关新旧热指标的更多信息，请参阅 [半导体和 IC 封装热指标](#) 应用手册。
- (2) 从输出到 VCC 的短路会导致过热，并且最终会发生损坏。
- (3) 最大功耗是与 T_{J(max)}、R_{θJA} 和 T_A 相关的函数。在任何允许的环境温度下，允许的最大功耗为 P_D = (T_{J(max)} - T_A)/R_{θJA}。在 150°C 的绝对最大 T_J 下运行可能会影响可靠性。
- (4) 最大功耗是与 T_{J(max)}、R_{θJA} 和 T_C 相关的函数。在任何允许的外壳温度下，允许的最大功率为 P_D = (T_{J(max)} - T_C)/R_{θJC}。在 150°C 的绝对最大 T_J 下运行可能会影响可靠性。
- (5) 此封装仅为预发布状态。

5.5 电气特性 - LM324B 和 LM324BA

在 $V_S = (V+) - (V-) = 5V$ 至 $36V$ ($\pm 2.5V$ 至 $\pm 18V$, $T_A = 25^\circ C$) , $V_{CM} = V_{OUT} = V_S/2$, 且 $R_L = 10k\Omega$ (连接至 $V_S/2$) 条件下 (除非另有说明)

参数		测试条件		最小值	典型值	最大值	单位
失调电压							
V_{OS}	输入失调电压	LM324B			± 0.6	± 3.0	mV
			$T_A = -40^\circ C$ 至 $85^\circ C$			± 4.0	
dV_{OS}/dT	输入失调电压漂移	$R_S = 0\Omega$	LM324BA		± 0.3	± 2	$\mu V/^\circ C$
				$T_A = -40^\circ C$ 至 $85^\circ C$			
PSRR	输入失调电压与电源间的关系			65	100		dB
	通道分离	$f = 1\text{ kHz}$ 至 20 kHz			120		dB
输入电压范围							
V_{CM}	共模电压范围	$V_S = 3V$ 至 $36V$		$V-$		$(V+) - 1.5$	V
		$V_S = 5V$ 至 $36V$	$T_A = -40^\circ C$ 至 $85^\circ C$	$V-$		$(V+) - 2$	
CMRR	共模抑制比	$(V-) \leq V_{CM} \leq (V+) - 1.5V$	$V_S = 3V$ 至 $36V$	70	80		dB
		$(V-) \leq V_{CM} \leq (V+) - 2V$	$V_S = 5V$ 至 $36V$	$T_A = -40^\circ C$ 至 $85^\circ C$	65	80	
输入偏置电流							
I_B	输入偏置电流				-10	-35	nA
				$T_A = -40^\circ C$ 至 $85^\circ C$			
dI_{OS}/dT	输入失调电流漂移			$T_A = -40^\circ C$ 至 $85^\circ C$	10		$pA/^\circ C$
I_{OS}	输入失调电流				± 0.5	± 4	nA
				$T_A = -40^\circ C$ 至 $85^\circ C$			
dI_{OS}/dT	输入失调电流漂移			$T_A = -40^\circ C$ 至 $85^\circ C$	10		$pA/^\circ C$
噪声							
E_N	输入电压噪声	$f = 0.1\text{ Hz}$ 至 10 Hz			3		μV_{PP}
e_N	输入电压噪声密度	$R_S = 100\Omega$, $V_I = 0V$, $f = 1\text{ kHz}$ (有关测试电路, 请参阅图 7-2)			35		nV/\sqrt{Hz}
输入电容							
Z_{ID}	差分				$10 \parallel 0.1$		$M\Omega \parallel pF$
Z_{ICM}	共模				$4 \parallel 1.5$		$G\Omega \parallel pF$
开环增益							
A_{OL}	开环电压增益	$V_S = 15V$, $V_O = 1V$ 至 $11V$, $R_L \geq 10k\Omega$, 连接到 (V-)			50	100	V/mV
				$T_A = -40^\circ C$ 至 $85^\circ C$	25		
频率响应							
GBW	增益带宽积	$R_L = 1M\Omega$, $C_L = 20pF$ (有关测试电路, 请参阅图 7-1)			1.2		MHz
SR	压摆率	$R_L = 1M\Omega$, $C_L = 30pF$, $V_I = \pm 10V$ (有关测试电路, 请参阅图 7-1)			0.5		$V/\mu s$
θ_m	相位裕度	$G = +1$, $R_L = 10k\Omega$, $C_L = 20pF$			56		$^\circ$
t_s	建立时间	精度达到 0.1%, $V_S = 5V$, $2V$ 阶跃, $G = +1$, $C_L = 100pF$			4		μs
	过载恢复时间	$V_{IN} \times \text{增益} > V_S$			10		μs
THD+N	总谐波失真 + 噪声	$G = +1$, $f = 1\text{ kHz}$, $V_O = 3.53V_{RMS}$, $V_S = 36V$, $R_L = 100k\Omega$, $I_{OUT} \leq 50\mu A$, $BW = 80\text{ kHz}$			0.001%		
输出							
V_O	相对于电源轨的电压输出摆幅	正电源轨 (V+)		$I_{OUT} = -50\mu A$	1.35	1.5	V
V_O				输出电流 = -1mA	1.4	1.6	V
V_O				$I_{OUT} = -5mA$	1.5	1.75	V
V_O		负电源轨 (V-)		$I_{OUT} = 50\mu A$	100	150	mV
V_O				输出电流 = 1mA	0.75	1	V
V_O				$V_S = 5V$, $R_L \leq 10k\Omega$ 连接到 (V-)	$T_A = -40^\circ C$ 至 $85^\circ C$	5	20
I_O	输出电流	$V_S = 15V$; $V_O = V-$; $V_{ID} = 1V$	吸电流		-20 ⁽¹⁾	-30	mA
				$T_A = -40^\circ C$ 至 $85^\circ C$	-10 ⁽¹⁾		mA
		$V_S = 15V$; $V_O = V+$; $V_{ID} = 1V$	灌电流		10 ⁽¹⁾	20	mA
				$T_A = -40^\circ C$ 至 $85^\circ C$	5 ⁽¹⁾		mA
		$V_{ID} = -1V$; $V_O = (V-) + 200mV$		50	85	μA	

5.5 电气特性 - LM324B 和 LM324BA (续)

在 $V_S = (V+) - (V-) = 5V$ 至 $36V$ ($\pm 2.5V$ 至 $\pm 18V$, $T_A = 25^\circ C$), $V_{CM} = V_{OUT} = V_S/2$, 且 $R_L = 10k\Omega$ (连接至 $V_S/2$) 条件下 (除非另有说明)

参数		测试条件		最小值	典型值	最大值	单位
I_{SC}	短路电流	$V_S = 20V, (V+) = 10V, (V-) = -10V, V_O = 0V$			± 40	± 60	mA
C_{LOAD}	容性负载驱动				100		pF
R_O	开环输出阻抗	$f=1MHz, I_O = 0A$			300		Ω
电源							
I_Q	每个放大器的静态电流	$V_S = 5V, I_O = 0A$	$T_A = -40^\circ C$ 至 $85^\circ C$		240	300	μA
		$V_S = 36V, I_O = 0A$	$T_A = -40^\circ C$ 至 $85^\circ C$		350	750	μA

(1) 仅由设计和特性指定。

5.6 电气特性 - LM2902B 和 LM2902BA

在 $V_S = (V+) - (V-) = 5V$ 至 $36V$ ($\pm 2.5V$ 至 $\pm 18V$, $T_A = 25^\circ C$) , $V_{CM} = V_{OUT} = V_S/2$, 且 $R_L = 10k\Omega$ (连接至 $V_S/2$) 条件下 (除非另有说明)

参数		测试条件		最小值	典型值	最大值	单位
失调电压							
V_{OS}	输入失调电压	LM2902B			± 0.6	± 3.0	mV
			$T_A = -40^\circ C$ 至 $125^\circ C$			± 4.0	
dV_{OS}/dT	输入失调电压漂移	$R_S = 0\Omega$	LM2902BA		± 0.3	± 2	$\mu V/^\circ C$
				$T_A = -40^\circ C$ 至 $125^\circ C$			
PSRR	输入失调电压与电源间的关系			65	100		dB
	通道分离	$f = 1\text{ kHz}$ 至 20 kHz			120		dB
输入电压范围							
V_{CM}	共模电压范围	$V_S = 3V$ 至 $36V$		$V-$		$(V+) - 1.5$	V
		$V_S = 5V$ 至 $36V$		$T_A = -40^\circ C$ 至 $125^\circ C$	$V-$		
CMRR	共模抑制比	$(V-) \leq V_{CM} \leq (V+) - 1.5V$	$V_S = 3V$ 至 $36V$	70	80		dB
		$(V-) \leq V_{CM} \leq (V+) - 2V$	$V_S = 5V$ 至 $36V$	$T_A = -40^\circ C$ 至 $125^\circ C$	65	80	
输入偏置电流							
I_B	输入偏置电流				-10	-35	nA
				$T_A = -40^\circ C$ 至 $125^\circ C$			
dI_{OS}/dT	输入失调电流漂移			$T_A = -40^\circ C$ 至 $125^\circ C$	10		$pA/^\circ C$
I_{OS}	输入失调电流				± 0.5	± 4	nA
				$T_A = -40^\circ C$ 至 $125^\circ C$			
dI_{OS}/dT	输入失调电流漂移			$T_A = -40^\circ C$ 至 $125^\circ C$	10		$pA/^\circ C$
噪声							
E_N	输入电压噪声	$f = 0.1\text{ Hz}$ 至 10 Hz			3		μV_{PP}
e_N	输入电压噪声密度	$R_S = 100\Omega$, $V_I = 0V$, $f = 1\text{ kHz}$ (有关测试电路, 请参阅图 7-2)			35		nV/\sqrt{Hz}
输入电容							
Z_{ID}	差分				$10 \parallel 0.1$		$M\Omega \parallel pF$
Z_{ICM}	共模				$4 \parallel 1.5$		$G\Omega \parallel pF$
开环增益							
A_{OL}	开环电压增益	$V_S = 15V$, $V_O = 1V$ 至 $11V$, $R_L \geq 10k\Omega$, 连接到 (V-)			50	100	V/mV
				$T_A = -40^\circ C$ 至 $125^\circ C$	25		
频率响应							
GBW	增益带宽积	$R_L = 1M\Omega$, $C_L = 20pF$ (有关测试电路, 请参阅图 7-1)			1.2		MHz
SR	压摆率	$R_L = 1M\Omega$, $C_L = 30pF$, $V_I = \pm 10V$ (有关测试电路, 请参阅图 7-1)			0.5		$V/\mu s$
θ_m	相位裕度	$G = +1$, $R_L = 10k\Omega$, $C_L = 20pF$			56		$^\circ$
t_s	建立时间	精度达到 0.1%, $V_S = 5V$, $2V$ 阶跃, $G = +1$, $C_L = 100pF$			4		μs
	过载恢复时间	$V_{IN} \times \text{增益} > V_S$			10		μs
THD+N	总谐波失真 + 噪声	$G = +1$, $f = 1\text{ kHz}$, $V_O = 3.53V_{RMS}$, $V_S = 36V$, $R_L = 100k\Omega$, $I_{OUT} \leq 50\mu A$, $BW = 80\text{ kHz}$			0.001%		
输出							
V_O	相对于电源轨的电压输出摆幅	正电源轨 (V+)		$I_{OUT} = -50\mu A$	1.35	1.5	V
V_O				输出电流 = -1mA	1.4	1.6	V
V_O				$I_{OUT} = -5mA$	1.5	1.75	V
V_O		负电源轨 (V-)		$I_{OUT} = 50\mu A$	100	150	mV
V_O				输出电流 = 1mA	0.75	1	V
V_O				$V_S = 5V$, $R_L \leq 10k\Omega$ 连接到 (V-)	$T_A = -40^\circ C$ 至 $125^\circ C$	5	20
I_O	输出电流	$V_S = 15V$; $V_O = V-$; $V_{ID} = 1V$	吸电流		-20 ⁽¹⁾	-30	mA
				$T_A = -40^\circ C$ 至 $125^\circ C$	-10 ⁽¹⁾		mA
		$V_S = 15V$; $V_O = V+$; $V_{ID} = 1V$	灌电流		10 ⁽¹⁾	20	mA
				$T_A = -40^\circ C$ 至 $125^\circ C$	5 ⁽¹⁾		mA
		$V_{ID} = -1V$; $V_O = (V-) + 200mV$		50	85	μA	

5.6 电气特性 - LM2902B 和 LM2902BA (续)

在 $V_S = (V+) - (V-) = 5V$ 至 $36V$ ($\pm 2.5V$ 至 $\pm 18V$, $T_A = 25^\circ C$), $V_{CM} = V_{OUT} = V_S/2$, 且 $R_L = 10k\Omega$ (连接至 $V_S/2$) 条件下 (除非另有说明)

参数		测试条件		最小值	典型值	最大值	单位
I_{SC}	短路电流	$V_S = 20V, (V+) = 10V, (V-) = -10V, V_O = 0V$			± 40	± 60	mA
C_{LOAD}	容性负载驱动				100		pF
R_O	开环输出阻抗	$f = 1MHz, I_O = 0A$			300		Ω
电源							
I_Q	每个放大器的静态电流	$V_S = 5V, I_O = 0A$	$T_A = -40^\circ C$ 至 $125^\circ C$		240	300	μA
		$V_S = 36V, I_O = 0A$	$T_A = -40^\circ C$ 至 $125^\circ C$			750	μA

(1) 仅由设计和特性指定。

5.7 LM324、LM324K、LM224、LM224K 和 LM124 的电气特性

在指定自然通风温度下， $V_{CC} = 5V$ (除非另有说明)

参数	测试条件 ⁽¹⁾		T_A ⁽²⁾	LM124、LM224、LM224K			LM324、LM324K			单位
				最小值	典型值 ⁽³⁾	最大值	最小值	典型值 ⁽³⁾	最大值	
V_{IO} 输入失调电压	$V_{CC} = 5V$ 至最大值, $V_{IC} = V_{ICRmin}$, $V_O = 1.4V$		25°C	3		5	3		7	mV
			完整范围			7			9	
I_{IO} 输入失调电流	$V_O = 1.4V$		25°C	2		30	2		50	nA
			完整范围			100			150	
I_{IB} 输入偏置电流	$V_O = 1.4V$		25°C	-20		-150	-20		-250	nA
			完整范围			-300			-500	
V_{ICR} 共模输入电压范围	$V_{CC} = 5V$ 至最大值		25°C	0 至 $V_{CC} - 1.5$			0 至 $V_{CC} - 1.5$			V
			完整范围	0 至 $V_{CC} - 2$			0 至 $V_{CC} - 2$			
V_{OH} 高电平输出电压	$R_L = 2k\Omega$ $V_{CC} =$ 最大值	$R_L = 2k\Omega$	25°C	$V_{CC} - 1.5$			$V_{CC} - 1.5$			V
			完整范围	26			26			
			$R_L \geq 10k\Omega$	完整范围	27	28		27	28	
V_{OL} 低电平输出电压	$R_L \leq 10k\Omega$		完整范围	5		20	5		20	mV
A_{VD} 大信号差分电压放大	$V_{CC+} = 15V$, $V_O = 1V$ 至 $11V$, $R_L \geq 2k\Omega$		25°C	50	100		25	100	V/mV	
			完整范围	25			15			
CMRR 共模抑制比	$V_{IC} = V_{ICRmin}$		25°C	70	80		65	80	dB	
k_{SVR} 电源电压抑制比 ($\Delta V_{CC} / \Delta V_{IO}$)			25°C	65	100		65	100	dB	
V_{O1} / V_{O2} 串扰衰减	$f = 1kHz$ 至 $20kHz$		25°C	120			120			dB
I_O 输出电流	$V_{CC} = 15V$, $V_{ID} = 1V$, $V_O = 0$	吸电流	25°C	-20		-30	-20		-30	mA
			完整范围	-10			-10			
	$V_{CC} = 15V$, $V_{ID} = -1V$, $V_O = 15V$	灌电流	25°C	10		20	10		20	mA
			完整范围	5			5			
	$V_{ID} = -1V$, $V_O = 200mV$		25°C	12		30	12		30	μA
I_{OS} 短路输出电流	V_{CC} 为 $5V$, $V_O = 0$, V_{CC-} 为 $-5V$		25°C	± 40		± 60	± 40		± 60	mA
I_{CC} 电源电流 (4 个放大器)	$V_O = 2.5V$, 空载		完整范围	0.7		1.2	0.7		1.2	mA
	$V_{CC} =$ 最大值, $V_O = 0.5V V_{CC}$, 空载		完整范围	1.4		3	1.4		3	

- 除非另有说明，所有特性均在开环条件下以零共模输入电压测定。对于 LM2902，用于测试目的的最大 V_{CC} 为 26V，其他器件则为 30V。
- 对于 LM124，完整范围为 $-55^\circ C$ 至 $+125^\circ C$ ，对于 LM224 为 $-25^\circ C$ 至 $+85^\circ C$ ，而对于 LM324 则为 $0^\circ C$ 至 $70^\circ C$ 。
- 所有典型值均在 $T_A=25^\circ C$ 下测得。

5.8 LM2902、LM2902K、LM2902KV 和 LM2902KAV 的电气特性

在指定自然通风温度下， $V_{CC} = 5V$ (除非另有说明)

参数	测试条件 ⁽¹⁾		T_A ⁽²⁾	LM2902、LM2902K			LM2902KV、LM2902KAV			单位
				最小值	典型值 ⁽³⁾	最大值	最小值	典型值 ⁽³⁾	最大值	
V_{IO} 输入失调电压	$V_{CC} = 5V$ 至最大值， $V_{IC} = V_{ICRmin}$ ， $V_O = 1.4V$	不带后级 A 的器件	25°C	3	7		3	7	mV	
			完整范围				10			
	A 后级器件	25°C				1	2			
		完整范围					4			
$\Delta V_{IO}/\Delta T$ 输入失调电压温漂	$R_S = 0\Omega$		完整范围				7	$\mu V/^\circ C$		
I_{IO} 输入失调电流	$V_O = 1.4V$		25°C	2	50		2	50	nA	
			完整范围				300	150		
$\Delta I_{IO}/\Delta T$ 输入失调电流温漂			完整范围				10	$pA/^\circ C$		
I_{IB} 输入偏置电流	$V_O = 1.4V$		25°C	-20	-250		-20	-250	nA	
			完整范围				-500	-500		
V_{ICR} 共模输入电压范围	$V_{CC} = 5V$ 至最大值		25°C	0 至 $V_{CC} - 1.5$			0 至 $V_{CC} - 1.5$	V		
			完整范围	0 至 $V_{CC} - 2$			0 至 $V_{CC} - 2$			
V_{OH} 高电平输出电压	$R_L = 10k\Omega$ $V_{CC} =$ 最大值		25°C	$V_{CC} - 1.5$			$V_{CC} - 1.5$	V		
			$R_L = 2k\Omega$ $R_L \geq 10k\Omega$	完整范围	22				26	
				完整范围	23	24			27	
V_{OL} 低电平输出电压	$R_L \leq 10k\Omega$		完整范围	5	20		5	20	mV	
A_{VD} 大信号差分电压放大	$V_{CC} = 15V$ ， $V_O = 1V$ 至 $11V$ ， $R_L \geq 2k\Omega$		25°C	25	100		25	100	V/mV	
			完整范围	15			15			
CMRR 共模抑制比	$V_{IC} = V_{ICRmin}$		25°C	50	80		60	80	dB	
k_{SVR} 电源电压抑制比 ($\Delta V_{CC}/\Delta V_{IO}$)			25°C	50	100		60	100	dB	
V_{O1}/V_{O2} 串扰衰减	$f = 1kHz$ 至 $20kHz$		25°C		120		120		dB	
I_O 输出电流	$V_{CC} = 15V$ ， $V_{ID} = 1V$ ， $V_O = 0$	拉电流	25°C	-20	-30	-60	-20	-30	-60	mA
			完整范围	-10			-10			
	$V_{CC} = 15V$ ， $V_{ID} = -1V$ ， $V_O = 15V$	灌电流	25°C	10	20		10	20		
			完整范围	5			5			
I_{OS} 短路输出电流	$V_{ID} = -1V$ ， $V_O = 200mV$		25°C	30			12	40	μA	
I_{CC} 电源电流 (4 个放大器)	V_{CC} 为 $5V$ ， $V_O = 0$ ， V_{CC-} 为 $-5V$		25°C	± 40	± 60		± 40	± 60	mA	
	$V_O = 2.5V$ ，空载		完整范围	0.7	1.2		0.7	1.2		
I_{CC} 电源电流 (4 个放大器)	$V_{CC} =$ 最大值， $V_O = 0.5V V_{CC}$ ，空载		完整范围	1.4	3		1.4	3	mA	

- (1) 除非另有说明，否则所有特性均在开环条件下以零共模输入电压测定。对于 LM2902，用于测试目的的最大 V_{CC} 为 26V，对于 LM2902V 则为 32V。
- (2) 对于 LM2902，完整范围为 $-40^\circ C$ 至 $+125^\circ C$ 。
- (3) 所有典型值均在 $T_A = 25^\circ C$ 下测得。

5.9 LM324A、LM324KA、LM224A、LM224KA 和 LM124A 的电气特性

在指定自然通风温度下， $V_{CC} = 5V$ (除非另有说明)

参数	测试条件 ⁽¹⁾	T_A ⁽²⁾	LM124A			LM224A、LM224KA			LM324A、LM324KA			单位	
			最小值	典型值 ⁽³⁾	最大值	最小值	典型值 ⁽³⁾	最大值	最小值	典型值 ⁽³⁾	最大值		
V_{IO} 输入失调电压	$V_{CC} = 5V$ 至 $30V$, $V_{IC} = V_{ICRmin}$, $V_O = 1.4V$	25°C			2		2	3		2	3	mV	
		完整范围			4			4			5		
I_{IO} 输入失调电流	$V_O = 1.4V$	25°C			10		2	15		2	30	nA	
		完整范围			30			30			75		
I_{IB} 输入偏置电流	$V_O = 1.4V$	25°C			-50		-15	-80		-15	-100	nA	
		完整范围			-100			-100			-200		
V_{ICR} 共模输入电压范围	$V_{CC} = 30V$	25°C	0 至 $V_{CC} - 1.5$			0 至 $V_{CC} - 1.5$				0 至 $V_{CC} - 1.5$		V	
		完整范围	0 至 $V_{CC} - 2$			0 至 $V_{CC} - 2$				0 至 $V_{CC} - 2$			
V_{OH} 高电平输出电压	$R_L = 2k\Omega$ $V_{CC} = 30V$	25°C	$V_{CC} - 1.5$			$V_{CC} - 1.5$				$V_{CC} - 1.5$		V	
		完整范围	26			26				26			
		$R_L \geq 10k\Omega$	完整范围	27			27	28			27		28
V_{OL} 低电平输出电压	$R_L \leq 10k\Omega$	完整范围			20		5	20		5	20	mV	
A_{VD} 大信号差分电压放大	$V_{CC} = 15V$, $V_O = 1V$ 至 $11V$, $R_L \geq 2k\Omega$	25°C	50	100		50	100		25	100		V/mV	
		完整范围	25			25			15				
CMRR 共模抑制比	$V_{IC} = V_{ICRmin}$	25°C	70 岁			70	80		65	80		dB	
k_{SVR} 电源电压抑制比 ($\Delta V_{CC} / \Delta V_{IO}$)		25°C	65			65	100		65	100		dB	
V_{O1} / V_{O2} 串扰衰减	$f = 1\text{ kHz}$ 至 20 kHz	25°C		120			120			120		dB	
I_O 输出电流	$V_{CC} = 15V$, $V_{ID} = 1V$, $V_O = 0$	吸电流	25°C		-20		-20	-30	-60	-20	-30	-60	mA
		完整范围			-10			-10			-10		
	$V_{CC} = 15V$, $V_{ID} = -1V$, $V_O = 15V$	灌电流	25°C		10		10	20		1	20		
		完整范围			5		5			5			
$V_{ID} = -1V$, $V_O = 200mV$	25°C		12		12	30		12	30		μA		
I_{OS} 短路输出电流	V_{CC} 为 $5V$, V_{CC} 为 $-5V$, $V_O = 0$	25°C		± 40	± 60		± 40	± 60		± 40	± 60	mA	
I_{CC} 电源电流 (4 个放大器)	$V_O = 2.5V$, 空载	完整范围		0.7	1.2		0.7	1.2		0.7	1.2	mA	
	$V_{CC} = 30V$, $V_O = 15V$, 空载	完整范围		1.4	3.		1.4	3		1.4	3		

(1) 除非另有说明，所有特性均在开环条件下以零共模输入电压测定。

(2) 对于 LM124A，完整范围为 $-55^\circ C$ 至 $+125^\circ C$ ，对于 LM224A，为 $-25^\circ C$ 至 $+85^\circ C$ ，而对于 LM324A 则为 $0^\circ C$ 至 $70^\circ C$ 。

(3) 所有典型值均在 $T_A = 25^\circ C$ 下测得。

5.10 运行条件

$V_{CC} = \pm 15V$, $T_A = 25^\circ C$

参数	测试条件	典型值	单位
SR 单位增益下的压摆率	$R_L = 1M\Omega$, $C_L = 30pF$, $V_I = \pm 10V$ (请参阅图 6-1)	0.5	$V/\mu s$
B_1 单位增益带宽	$R_L = 1M\Omega$, $C_L = 20pF$ (请参阅图 6-1)	1.2	MHz
V_n 等效输入噪声电压	$R_S = 100\Omega$, $V_I = 0V$, $f = 1\text{ kHz}$ (请参阅图 6-2)	35	nV/\sqrt{Hz}

5.11 典型特性

此典型特性部分适用于 LM324B 和 LM2902B。此部分中的典型特性数据均在 $T_A = 25^\circ\text{C}$ 、 $V_S = 36\text{V} (\pm 18\text{V})$ 、 $V_{CM} = V_S / 2$ 、 $R_{LOAD} = 10\text{k}\Omega$ (连接到 $V_S / 2$) 条件下获得 (除非另有说明)。

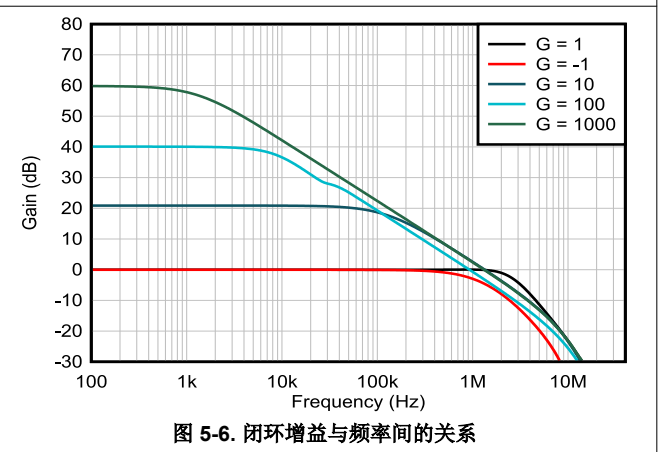
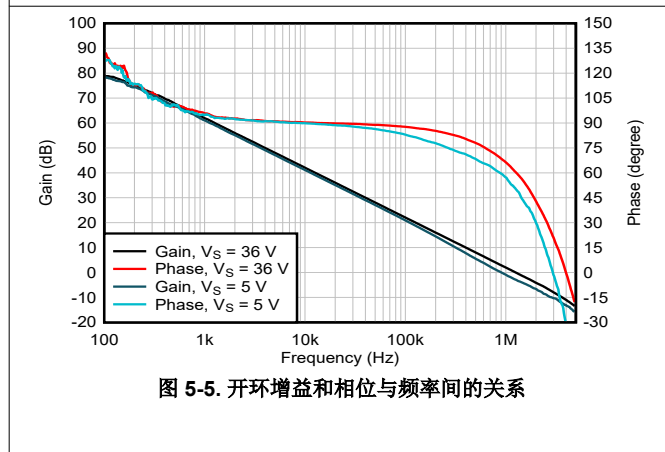
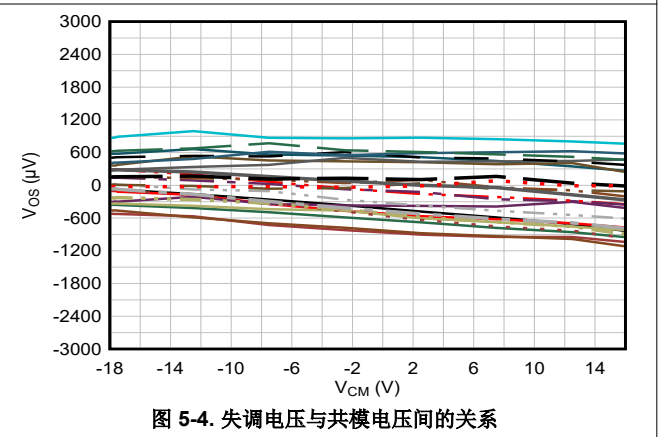
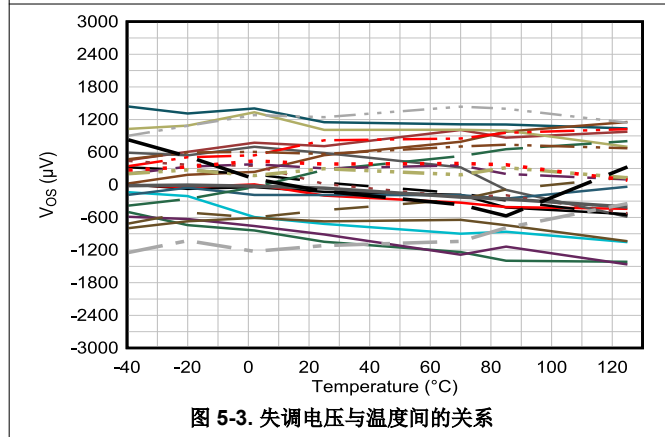
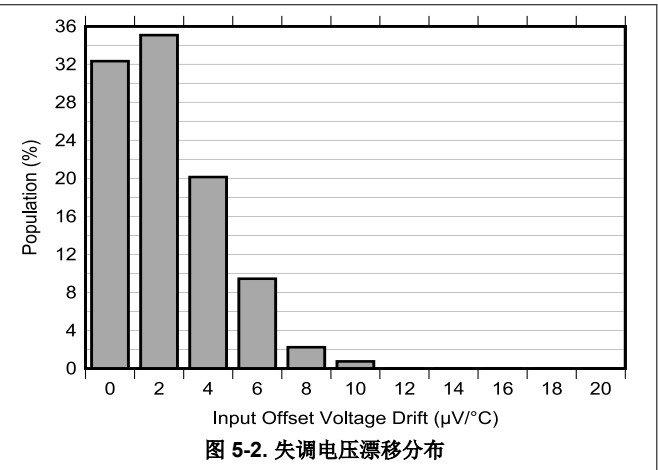
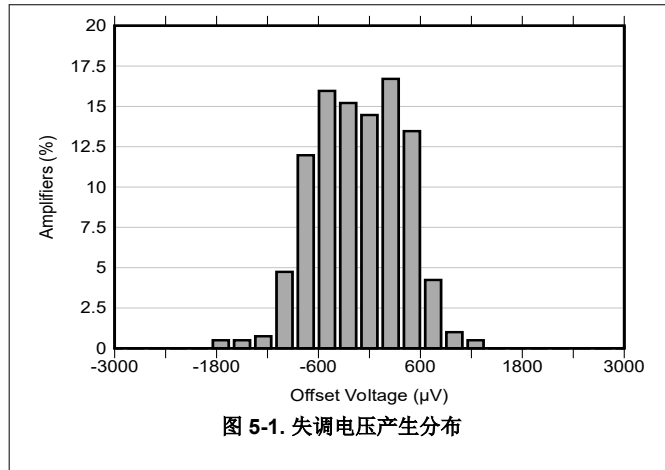

5.11 典型特性 (续)

此典型特性部分适用于 LM324B 和 LM2902B。此部分中的典型特性数据均在 $T_A = 25^\circ\text{C}$ 、 $V_S = 36\text{V} (\pm 18\text{V})$ 、 $V_{CM} = V_S / 2$ 、 $R_{LOAD} = 10\text{k}\Omega$ (连接到 $V_S / 2$) 条件下获得 (除非另有说明)。



图 5-7. 输出电压摆幅与输出电流 (拉电流) 间的关系



图 5-8. CMRR 与频率间的关系

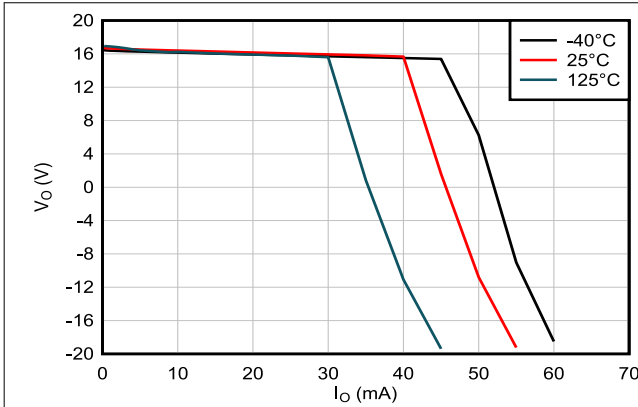

图 5-9. PSRR 与频率间的关系

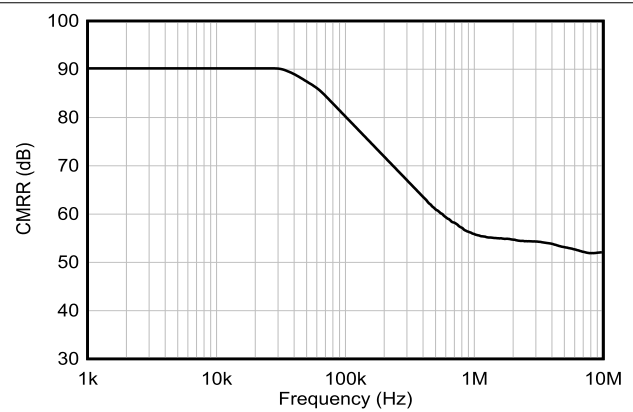

图 5-10. 共模抑制比与温度间的关系

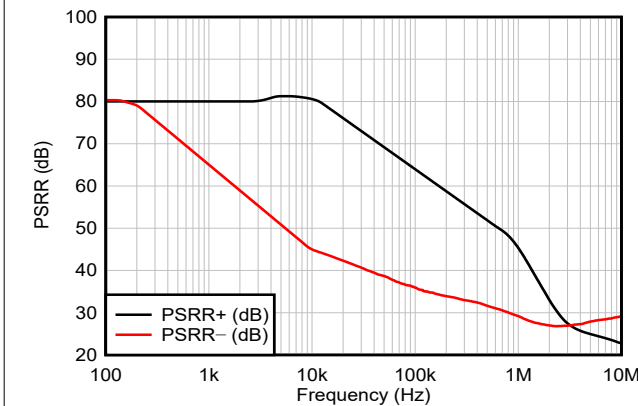

图 5-11. 电源抑制比与温度间的关系

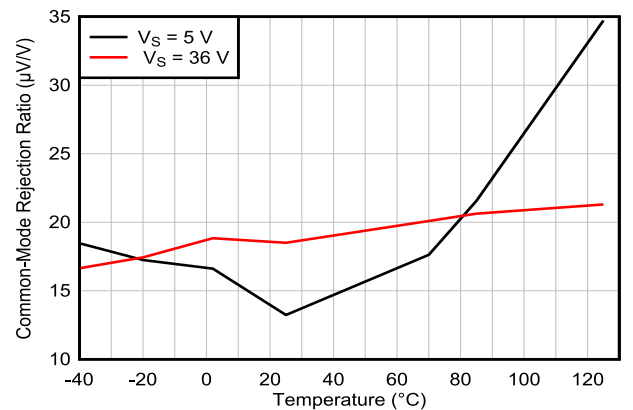

图 5-12. 0.1Hz 至 10Hz 噪声

5.11 典型特性 (续)

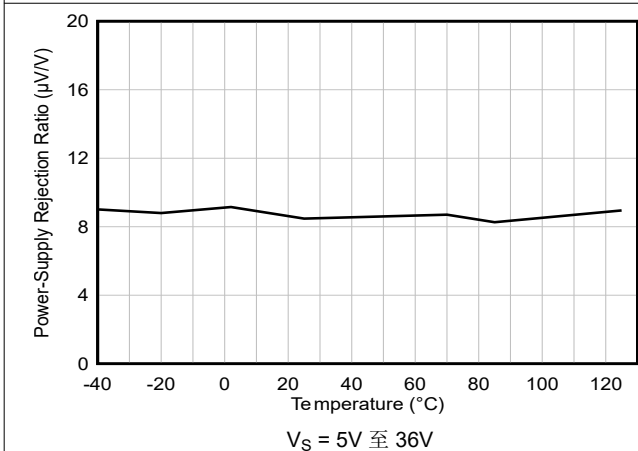
此典型特性部分适用于 LM324B 和 LM2902B。此部分中的典型特性数据均在 $T_A = 25^\circ\text{C}$ 、 $V_S = 36\text{V} (\pm 18\text{V})$ 、 $V_{CM} = V_S / 2$ 、 $R_{LOAD} = 10\text{k}\Omega$ (连接到 $V_S / 2$) 条件下获得 (除非另有说明)。

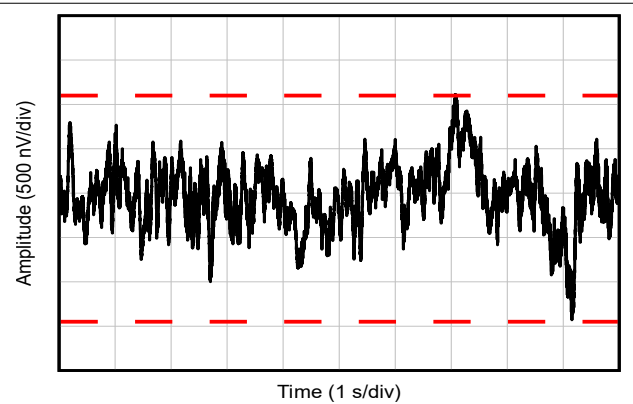

图 5-13. 输入电压噪声频谱密度与频率间的关系



$G = 1$, $f = 1\text{kHz}$, $BW = 80\text{kHz}$,
 $V_{OUT} = 10\text{V}_{PP}$, R_L 连接至 V^-

图 5-14. THD+N 比与频率间的关系, $G = 1$

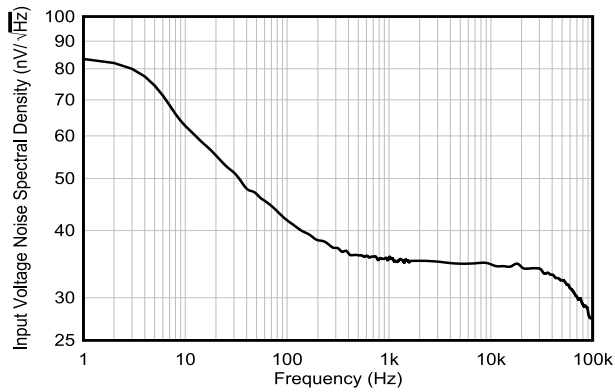
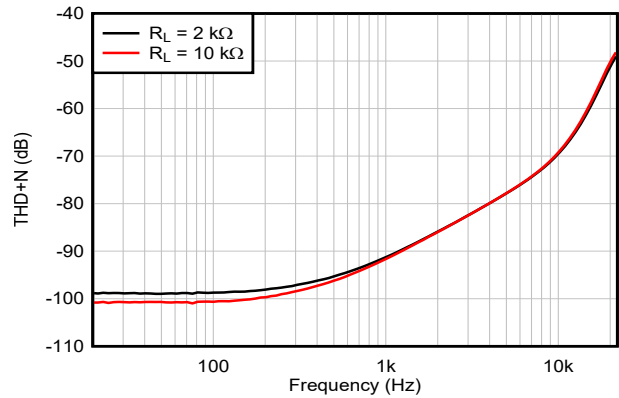
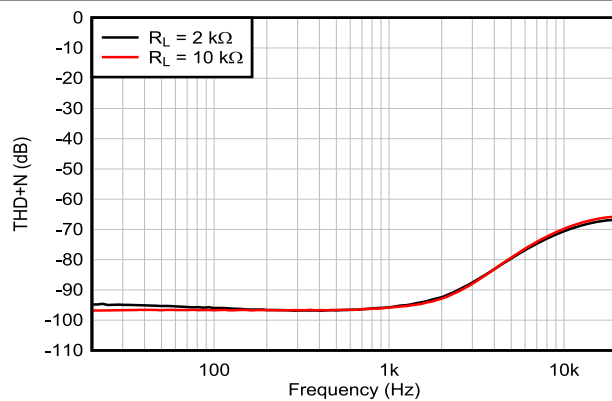

$G = -1$, $f = 1\text{kHz}$, $BW = 80\text{kHz}$,
 $V_{OUT} = 10\text{V}_{PP}$, R_L 连接至 V^-
 请参阅节 6

图 5-15. THD+N 比与频率间的关系, $G = -1$

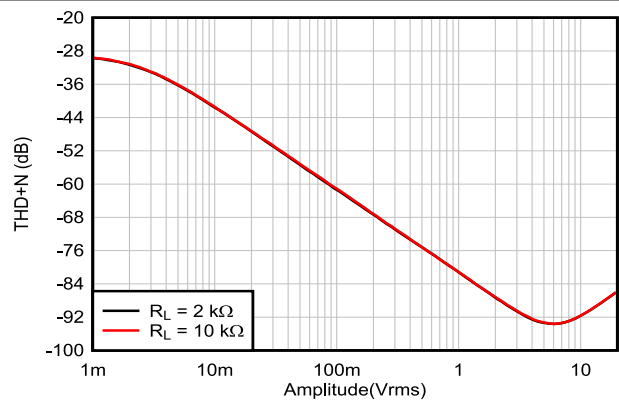

$G = 1$, $f = 1\text{kHz}$, $BW = 80\text{kHz}$,
 R_L 连接至 V^-

图 5-16. THD+N 与输出振幅间的关系, $G = 1$

5.11 典型特性 (续)

此典型特性部分适用于 LM324B 和 LM2902B。此部分中的典型特性数据均在 $T_A = 25^\circ\text{C}$ 、 $V_S = 36\text{V} (\pm 18\text{V})$ 、 $V_{CM} = V_S / 2$ 、 $R_{LOAD} = 10\text{k}\Omega$ (连接到 $V_S / 2$) 条件下获得 (除非另有说明)。

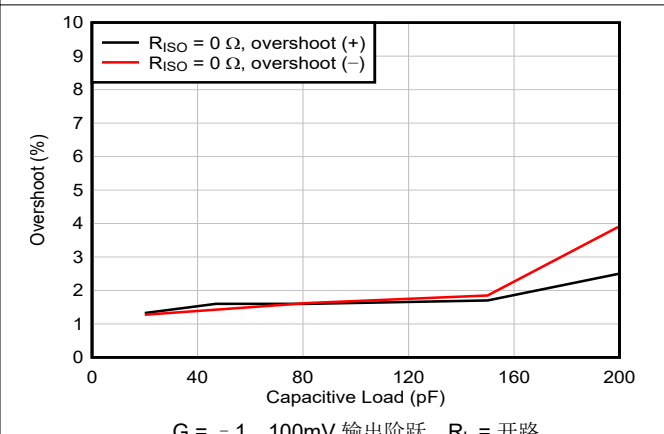
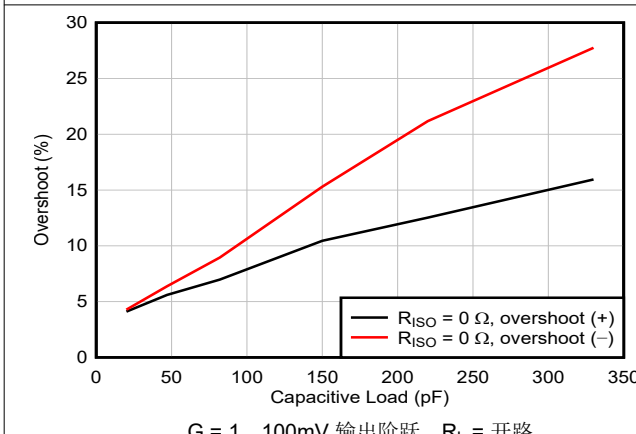
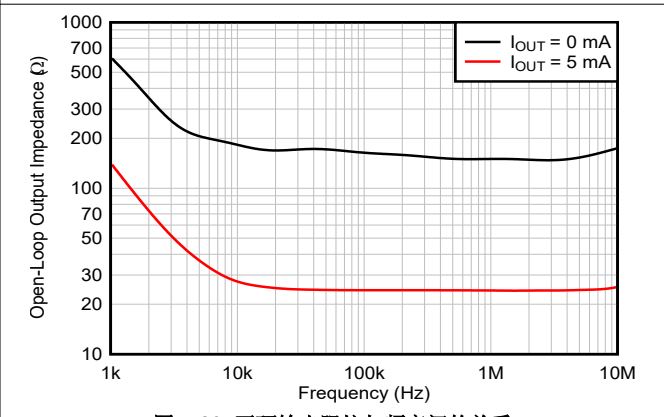
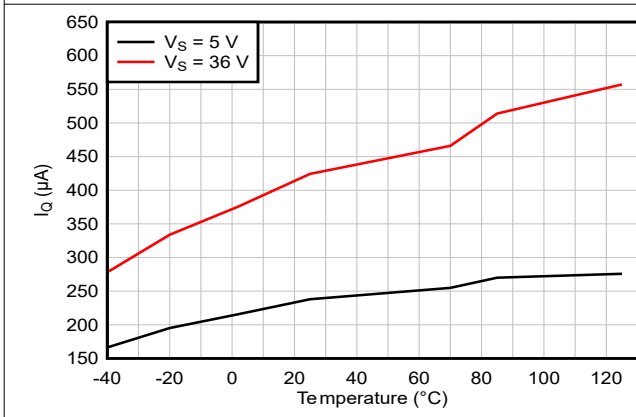
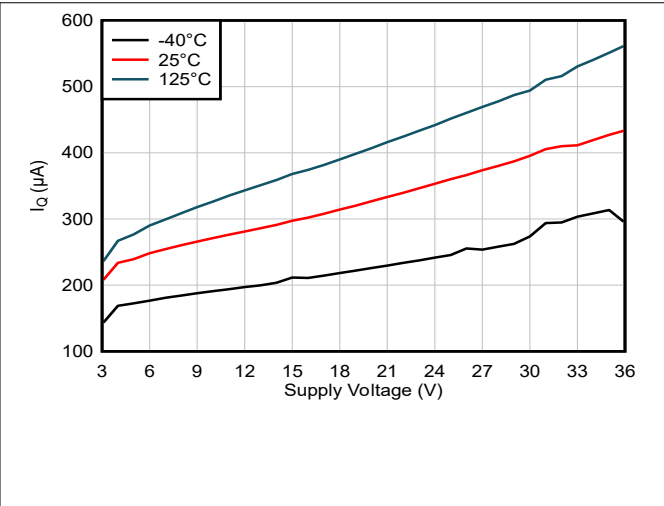
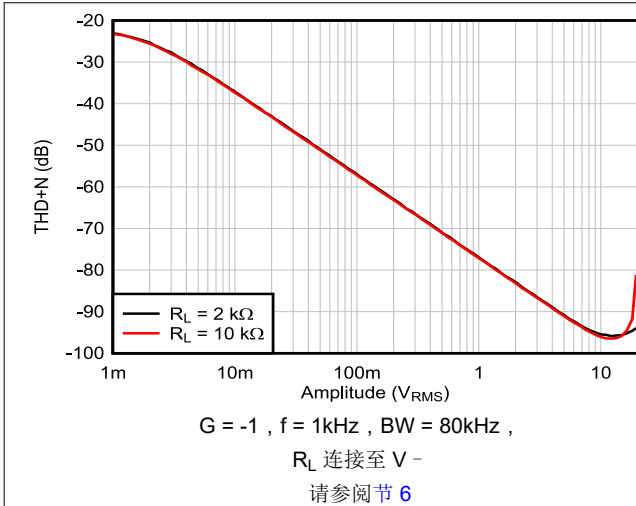

5.11 典型特性 (续)

此典型特性部分适用于 LM324B 和 LM2902B。此部分中的典型特性数据均在 $T_A = 25^\circ\text{C}$ 、 $V_S = 36\text{V} (\pm 18\text{V})$ 、 $V_{CM} = V_S / 2$ 、 $R_{LOAD} = 10\text{k}\Omega$ (连接到 $V_S / 2$) 条件下获得 (除非另有说明)。



图 5-23. 相位裕度与容性负载间的关系



图 5-24. 过载恢复 (正轨)

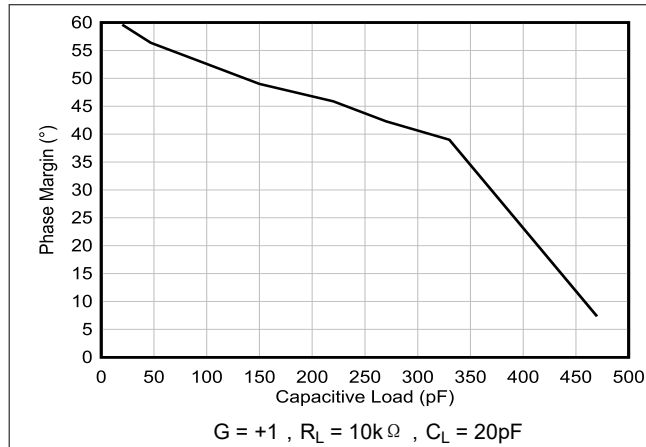

图 5-25. 过载恢复 (负轨)

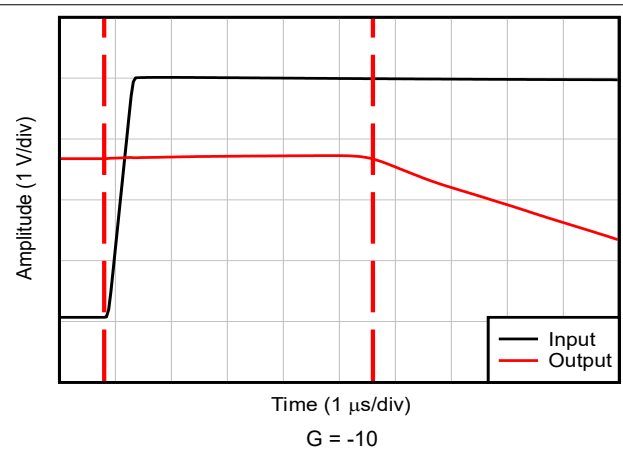

图 5-26. 小信号阶跃响应, $G = 1$

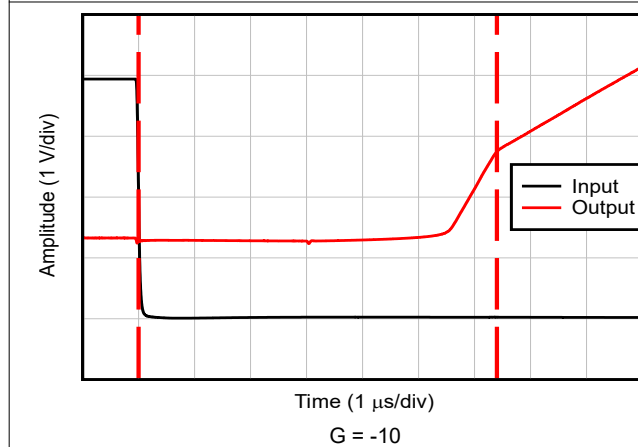

图 5-27. 小信号阶跃响应, $G = -1$

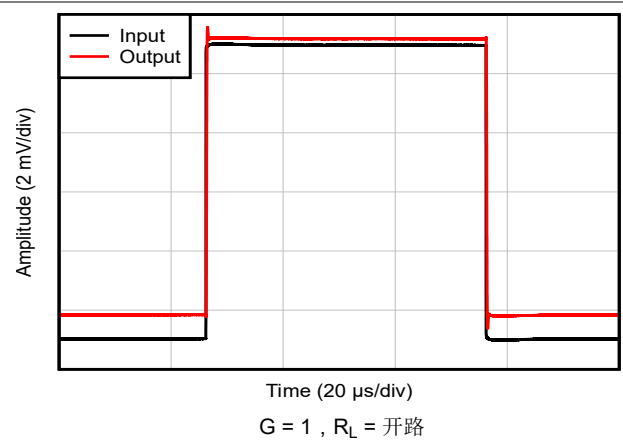

图 5-28. 大信号阶跃响应 (下降)

5.11 典型特性 (续)

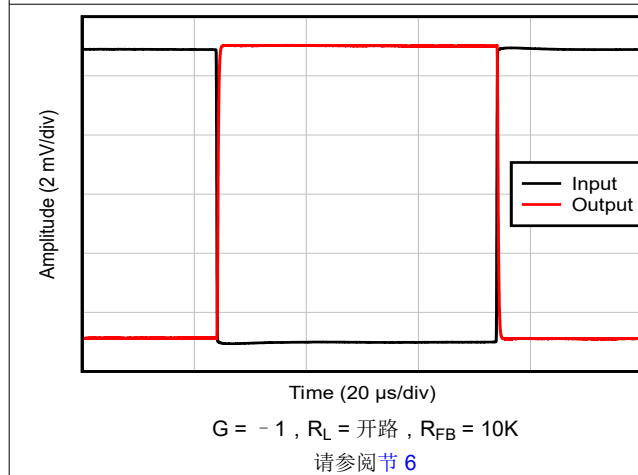
此典型特性部分适用于 LM324B 和 LM2902B。此部分中的典型特性数据均在 $T_A = 25^\circ\text{C}$ 、 $V_S = 36\text{V} (\pm 18\text{V})$ 、 $V_{\text{CM}} = V_S / 2$ 、 $R_{\text{LOAD}} = 10\text{k}\Omega$ (连接到 $V_S / 2$) 条件下获得 (除非另有说明)。

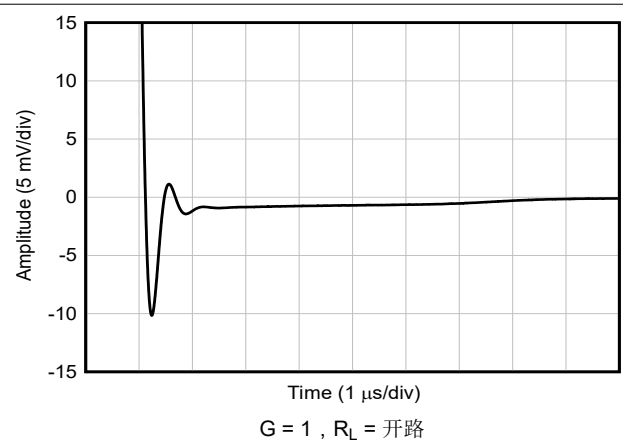

图 5-29. 大信号阶跃响应, $G = 1$



图 5-30. 大信号阶跃响应, $G = -1$

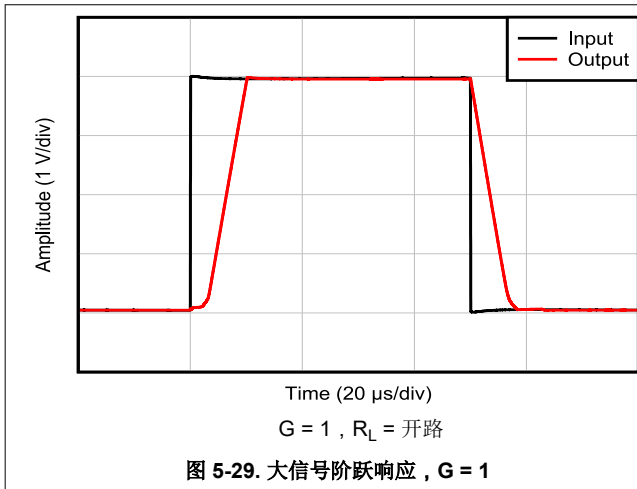

图 5-31. 短路电流与温度间的关系

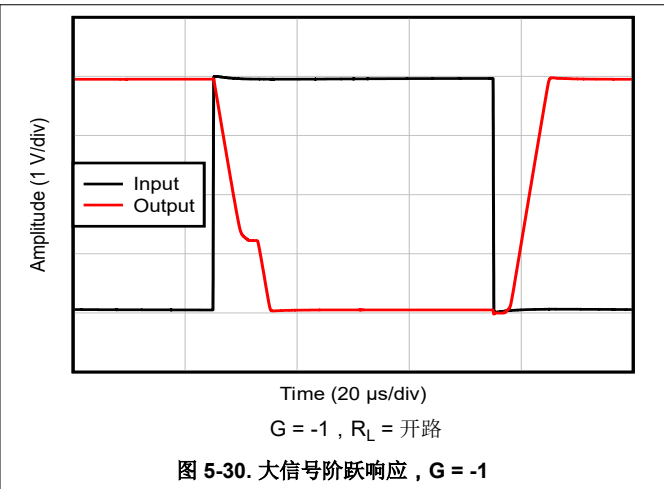

图 5-32. 最大输出电压与频率间的关系

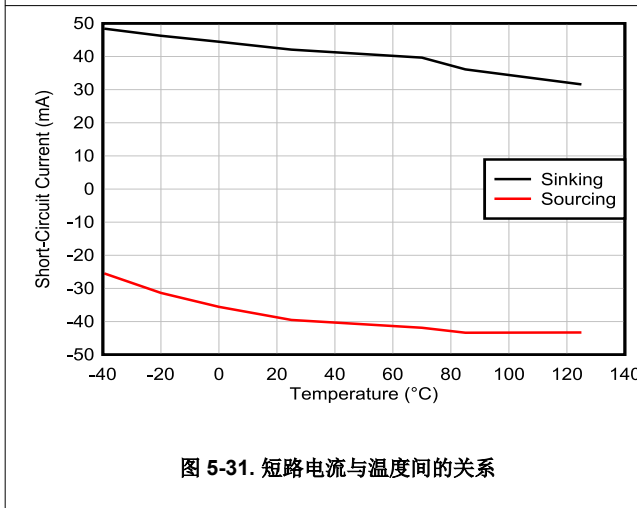

图 5-33. 通道隔离与频率间的关系

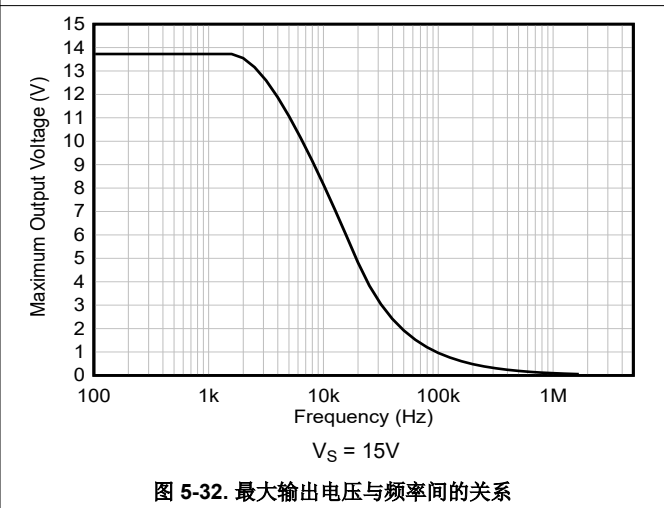

图 5-34. EMIRR (电磁干扰抑制比) 与频率间的关系

5.12 典型特性：B 和 BA 版本以外的所有器件

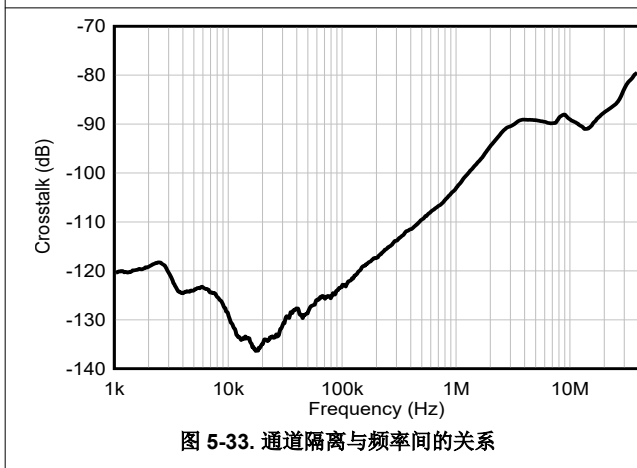

6 参数测量信息

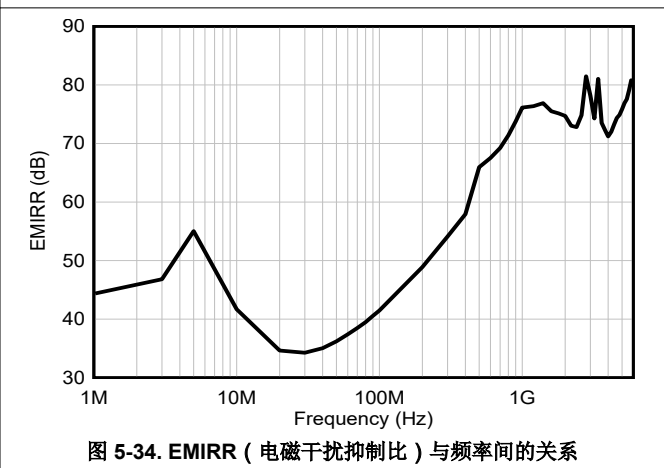
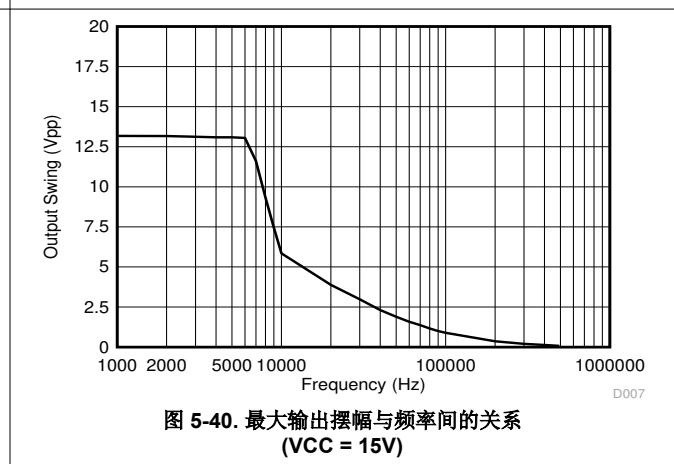
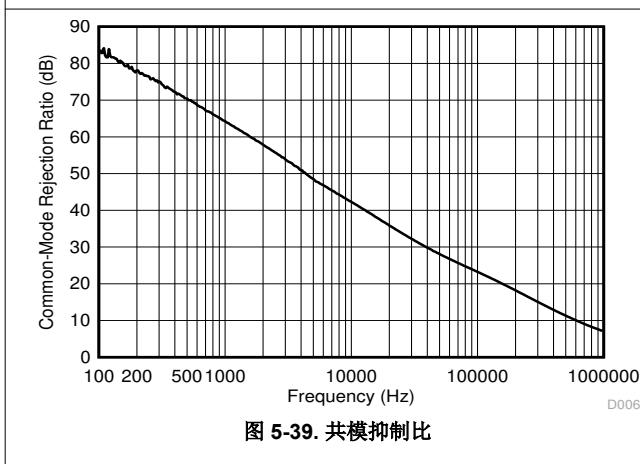
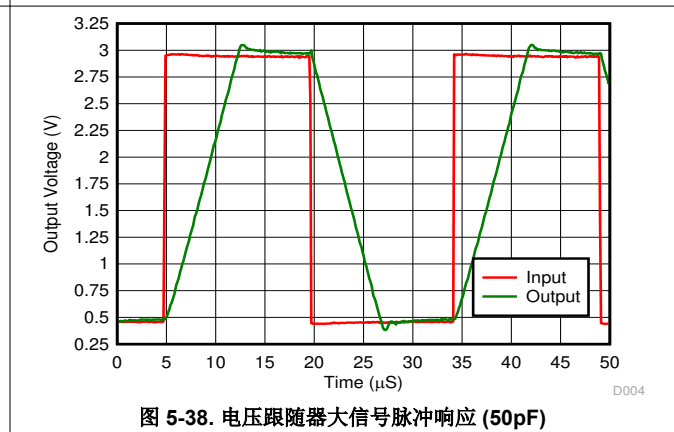
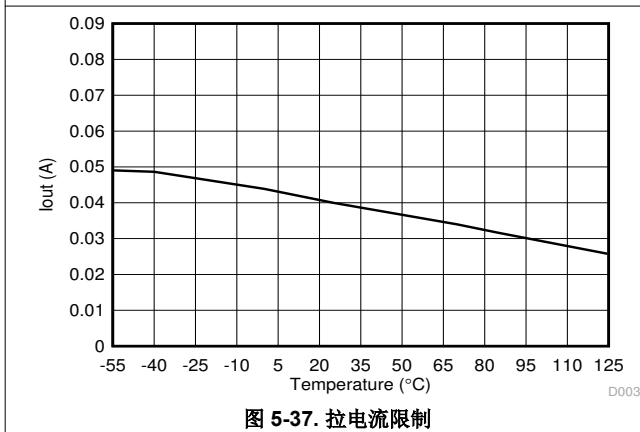
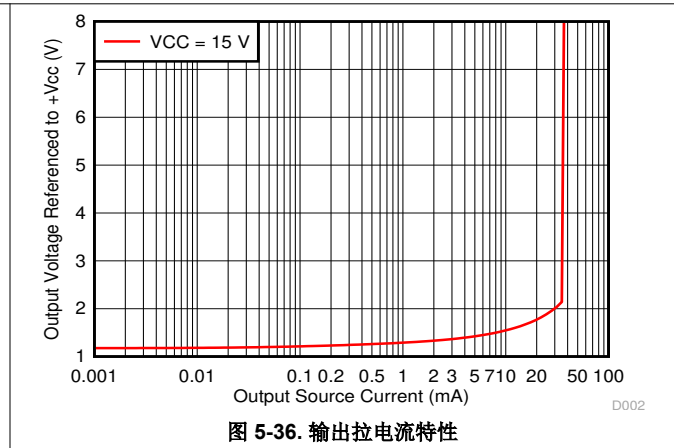
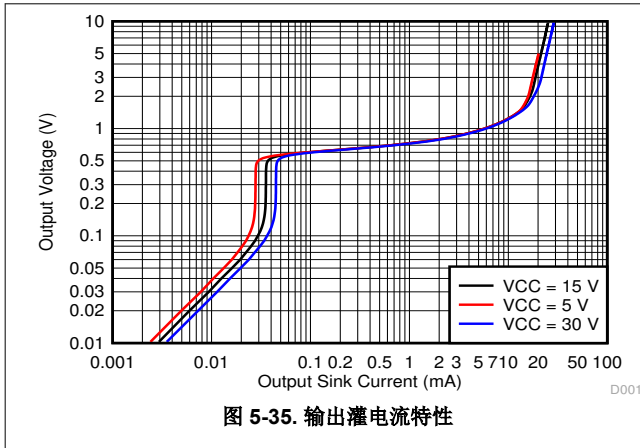

图 6-1. 单位增益放大器



图 6-2. 噪声测试电路

7 详细说明

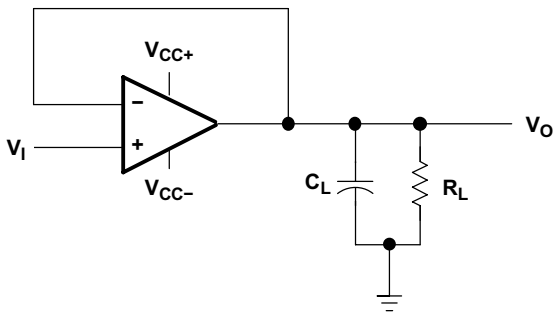
7.1 概述

这些器件包含 4 个独立的高增益频率补偿运算放大器，专为在宽电压范围内使用单电源而设计。如果两个电源之间的电压差在 3V 和 36V 之间 (B 和 BA 版本)、3V 和 26V 之间 (LM2902 器件) 或 3V 和 30V 之间 (所有其他器件)，并且 V_{CC} 比输入共模电压的正值至少高 1.5V，也可使用双电源供电运行。低电源电流漏极与电源电压的幅度无关。

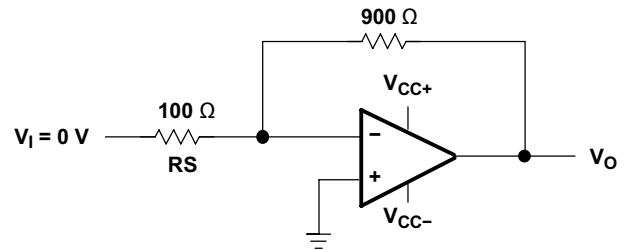
应用包括传感器放大器、直流放大块和所有可在单电源电压系统中更轻松实现的传统运算放大器电路。例如，LM324B 和 LM2902B 器件可以直接在数字系统中使用的标准 5V 电源电压下工作，并提供所需的接口电子元件，而无需添加 $\pm 15V$ 电源。

7.2 功能方框图

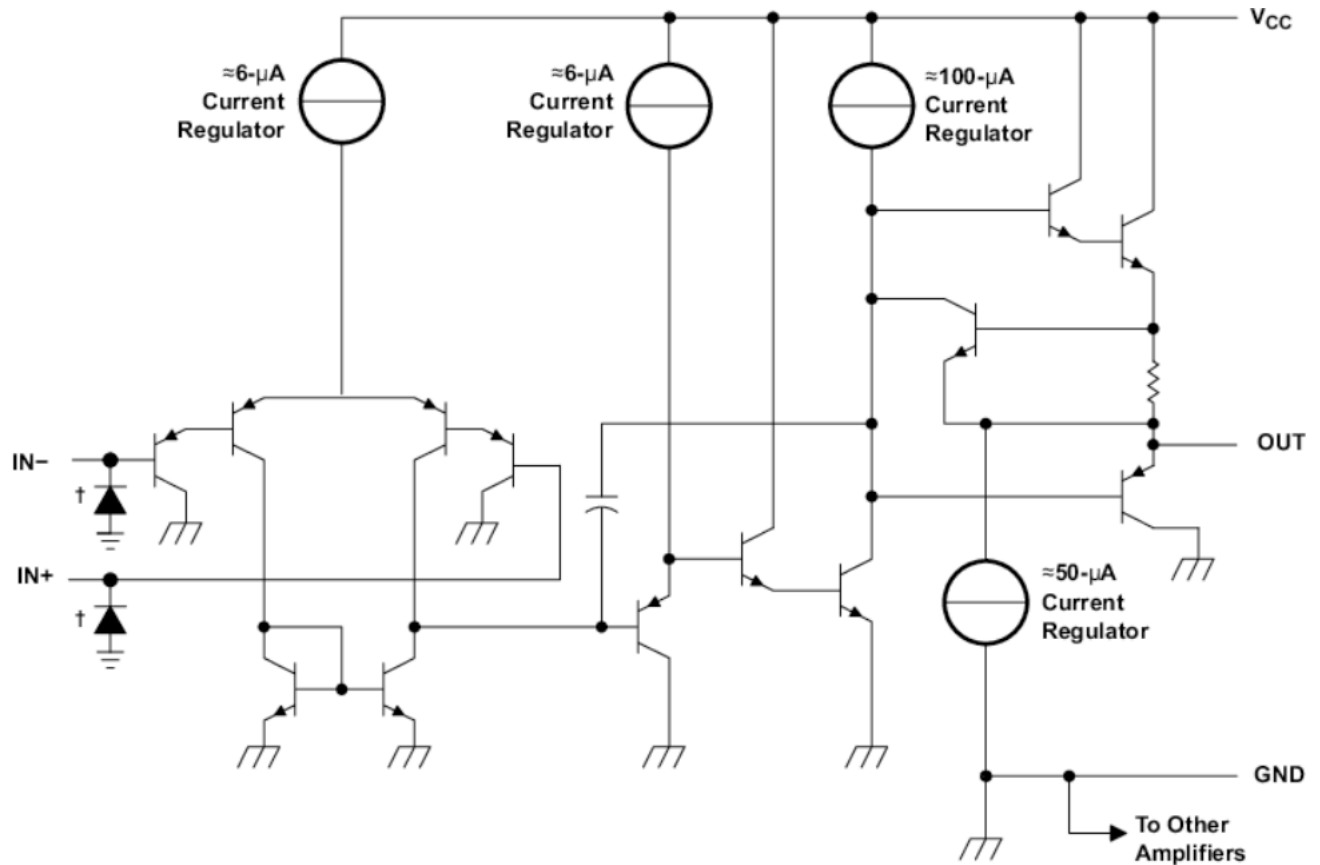

COMPONENT COUNT (total device)	
Epi-FET	1
Transistors	95
Diodes	4
Resistors	11
Capacitors	4

ESD 保护单元 - 仅在 B、BA 和 K 版本上提供

7.3 特性说明

7.3.1 单位增益带宽

增益带宽积等于测得的放大器带宽乘以所测带宽对应的增益。这些器件具有 1.2MHz 的高增益带宽。

7.3.2 压摆率

压摆率是运算放大器在输入发生变化时可以改变输出的速率。这些器件具有 $0.5V/\mu s$ 的压摆率。

7.3.3 输入共模范围

有效的共模范围是从器件接地到 $V_{CC} - 1.5V$ (在整个温度范围内为 $V_{CC} - 2V$)。输入可能会超过 V_{CC} 直至最大 V_{CC} 而不会损坏器件。至少一个输入必须在有效的输入共模范围内，才能使输出具有正确的相位。如果两个输入都超出有效范围，则输出相位未定义。如果任一输入低于 $-0.3V$ ，则输入电流应限制为 $1mA$ ，并且输出相位未定义。

7.4 器件功能模式

这些器件会在连接电源时通电。该器件可根据应用情况作为单电源运算放大器或双电源放大器使用。

8 应用和实现

备注

以下应用部分中的信息不属于 TI 器件规格的范围，TI 不担保其准确性和完整性。TI 的客户应负责确定器件是否适用于其应用。客户应验证并测试其设计，以确保系统功能。

8.1 应用信息

LMx24 和 LM2902 运算放大器适用于各种信号调节应用。可以在 VCC 之前为输入供电，从而实现多电源电路的灵活性。

8.2 典型应用

运算放大器的典型应用是反相放大器。该放大器在输入端接受正电压，然后使电压变为同样幅度的负电压。它还会以相同的方式使负输入电压变为正电压。



图 8-1. 应用原理图

8.2.1 设计要求

选择的电源电压必须大于输入电压范围和输出范围。例如，此应用将 $\pm 0.5\text{V}$ 的信号扩展到了 $\pm 1.8\text{V}$ 。将电源设置在 $\pm 12\text{V}$ 就足以满足此应用的要求。

8.2.2 详细设计流程

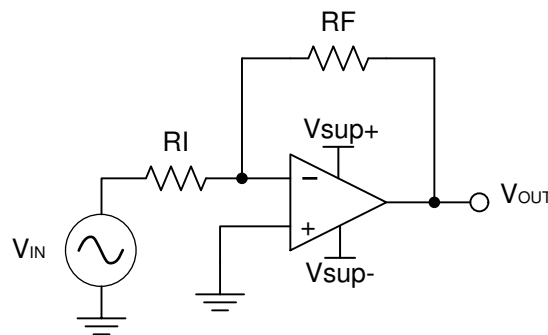
使用 [方程式 1](#) 和 [方程式 2](#) 来确定反相放大器需要的增益：

$$A_V = \frac{V_{OUT}}{V_{IN}} \quad (1)$$

$$A_V = \frac{1.8}{-0.5} = -3.6 \quad (2)$$

确定所需增益后，选择 R_I 或 R_F 的阻值。由于放大器电路使用 mA 级电流，因此需要选择 $k\Omega$ 级阻值。这样可以确保该器件不会消耗过多电流。此示例使用的 R_I 为 $10k\Omega$ ，这意味着对 R_F 使用 $36k\Omega$ 。这是由 [方程式 3](#) 算出的。

$$A_V = \frac{R_F}{R_I} \quad (3)$$

8.2.3 应用曲线



图 8-2. 反相放大器的输入和输出电压

8.3 电源相关建议

小心

单电源的电源电压超过 32V 或双电源的电源电压范围超出 $\pm 16V$ 可能会对器件造成永久损坏（请参阅节 5.1）。

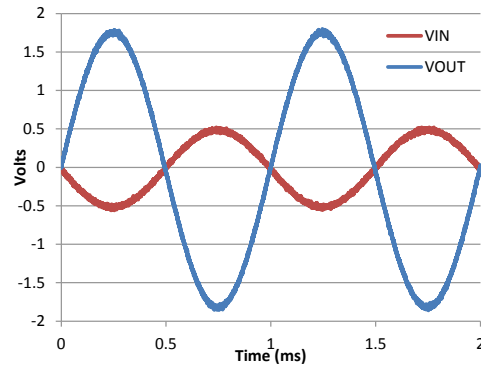
将 0.1 μF 旁路电容器置于电源引脚附近，可减少从高噪声电源或高阻抗电源中耦合进来的误差。有关旁路电容器放置的更多详细信息，请参阅节 8.4。

8.4 布局

8.4.1 布局指南

为了实现器件的最佳工作性能，应使用良好的 PCB 布局实践，包括：

- 噪声可通过全部电路电源引脚以及运算放大器自身传入模拟电路。旁路电容器通过提供位于模拟电路本地的低阻抗电源来降低耦合噪声。
 - 在每个电源引脚和接地端之间连接低 ESR 0.1 μF 陶瓷旁路电容器，放置位置尽量靠近器件。从 V+ 到接地端的单个旁路电容器适用于单电源应用。
- 将电路的模拟和数字部分单独接地是最简单且最有效的噪声抑制方法之一。通常将多层 PCB 中的一层或多层专门作为接地层。接地层有助于散热和降低 EMI 噪声拾取。确保对数字接地和模拟接地进行物理隔离，同时应注意接地电流。
- 为了减少寄生耦合，请让输入走线尽可能远离电源或输出走线。如果这些迹线不能保持分离状态，最好让敏感走线与有噪声的走线垂直相交，而不是平行相交。
- 外部组件的位置应尽量靠近器件。如节 8.4.2 中所示，使 RF 和 RG 接近反相输入可尽可能减小寄生电容。
- 尽可能缩短输入走线。切记：输入走线是电路中最敏感的部分。
- 考虑在关键走线周围设定驱动型低阻抗保护环。这样可显著减少附近走线在不同电势下产生的漏电流。

8.4.2 布局示例



图 8-3. 非反相配置的运算放大器电路板布局



图 8-4. 同相配置的运算放大器原理图

9 器件和文档支持

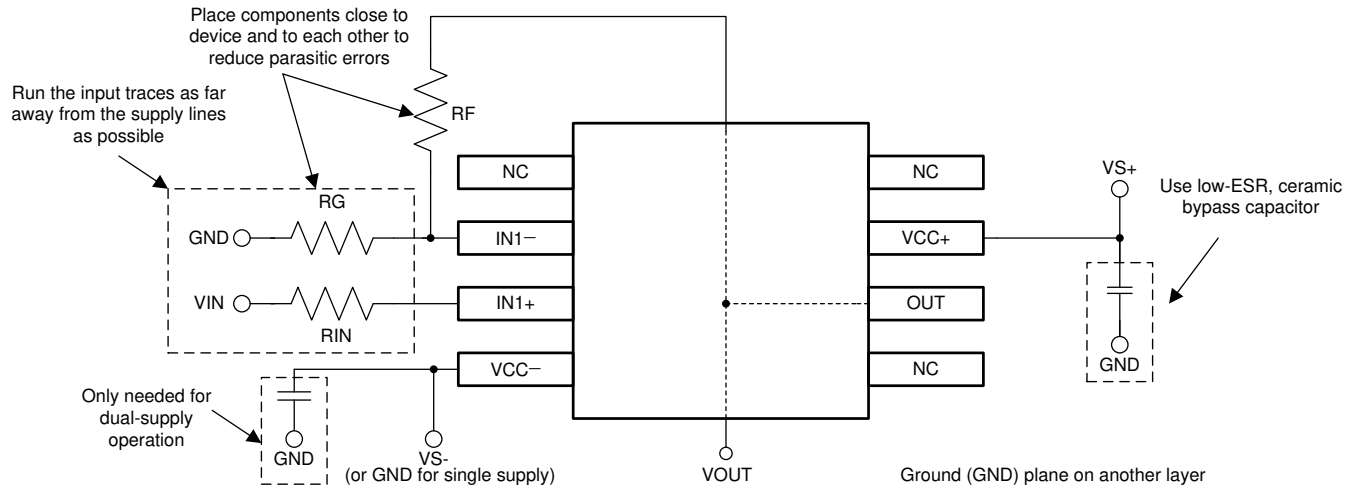
9.1 接收文档更新通知

要接收文档更新通知，请导航至 [ti.com](https://www.ti.com) 上的器件产品文件夹。点击 [通知](#) 进行注册，即可每周接收产品信息更改摘要。有关更改的详细信息，请查看任何已修订文档中包含的修订历史记录。

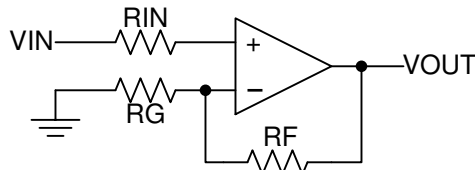
9.2 支持资源

[TI E2E™ 中文支持论坛](#) 是工程师的重要参考资料，可直接从专家处获得快速、经过验证的解答和设计帮助。搜索现有解答或提出自己的问题，获得所需的快速设计帮助。

链接的内容由各个贡献者“按原样”提供。这些内容并不构成 TI 技术规范，并且不一定反映 TI 的观点；请参阅 TI 的 [使用条款](#)。

9.3 商标

TI E2E™ is a trademark of Texas Instruments.

所有商标均为其各自所有者的财产。

9.4 静电放电警告



静电放电 (ESD) 会损坏这个集成电路。德州仪器 (TI) 建议通过适当的预防措施处理所有集成电路。如果不遵守正确的处理和安装程序，可能会损坏集成电路。

ESD 的损坏小至导致微小的性能降级，大至整个器件故障。精密的集成电路可能更容易受到损坏，这是因为非常细微的参数更改都可能会导致器件与其发布的规格不相符。

9.5 术语表

[TI 术语表](#) 本术语表列出并解释了术语、首字母缩略词和定义。

10 修订历史记录

注：以前版本的页码可能与当前版本的页码不同

Changes from Revision AC (March 2024) to Revision AD (October 2024) Page

• 删除了 B 和 BA 器件的 D (SOIC , 14) 封装预发布说明.....	1
---	---

Changes from Revision AB (November 2023) to Revision AC (March 2024) Page

Changes from Revision AA (September 2023) to Revision AB (November 2023) Page

• 将 LM324BA 和 LM2902BA 的状态从预发布更改为正在供货.....	1
--	---

Changes from Revision Z (April 2023) to Revision AA (September 2023) Page

• 删除了 器件信息 表中 TSSOP-14 BA 器件的预发布说明.....	1
• 更改了 封装信息 表的格式以包含封装引线尺寸.....	1

Changes from Revision Y (October 2022) to Revision Z (April 2023)	Page
• 向封装信息表中添加了 WQFN-16 封装.....	1
• 向引脚配置和功能部分添加了 WQFN-16 封装详细信息.....	3
• 向典型特性添加了 LM324Bx 和 LM2902Bx 的其他图.....	14

Changes from Revision X (May 2022) to Revision Y (October 2022)	Page
• 删除了器件信息表中 TSSOP-14 B 封装器件的预发布说明.....	1
• 更新了说明信息.....	1
• RTM 修订版更新了 LM324B 和 LM324BA 电气特性表.....	7
• 更新了 RTM 修订版 LM2902B 和 LM2902BA 电气特性表.....	9
• 向典型特性添加了 LM324Bx 和 LM2902Bx 的图.....	14

Changes from Revision W (March 2015) to Revision X (May 2022)	Page
• 更新了特性以包括 B 和 BA 版本。.....	1
• 向应用部分添加了应用链接.....	1
• 更正了器件信息表中的可用封装.....	1
• 向器件信息表中添加了 B 和 BA 版本.....	1
• 将引脚配置和功能部分中的封装图像更新成了新的格式 - 无规格变化.....	3
• 在引脚功能表中分别将 GND 和 Vcc 重命名为了 Vcc- 和 Vcc+.....	3
• 向绝对最大额定值表中添加了 B 和 BA 版本.....	5
• 向 ESD 等级表中添加了 B 和 BA 版本.....	5
• 向建议运行条件表中添加了 B 和 BA 版本.....	5
• 添加了电气特性 - LM324B 和 LM324BA 表.....	7
• 添加了电气特性 - LM2902B 和 LM2902BA 表.....	9
• 从器件和文档支持部分中移除了文档支持和相关链接.....	27

Changes from Revision V (January 2014) to Revision W (March 2014)	Page
• 添加了应用.....	1
• 添加了器件信息表.....	1
• 添加了机械、封装和可订购信息部分.....	28

Changes from Revision U (August 2010) to Revision V (January 2014)	Page
• 将文档更新为新的 TI 数据表格式 - 无规格变化.....	1
• 更新了特性.....	1
• 更新了特性.....	1
• 删除了订购信息表.....	3
• 添加了引脚功能表.....	3

11 机械、封装和可订购信息

以下页面包含机械、封装和可订购信息。这些信息是指定器件可用的最新数据。数据如有变更，恕不另行通知，且不会对此文档进行修订。如需获取此数据表的浏览器版本，请查阅左侧的导航栏。

11.1 封装选项附录

封装信息

可订购器件	状态 ⁽¹⁾	封装类型	封装图	引脚	包装数量	环保计划 ⁽²⁾	铅/焊球镀层 ⁽⁶⁾	MSL 峰值温度 ⁽³⁾	工作温度 (°C)	器件标识 ^{(4) (5)}
LM324BIRTER	预发布	WQFN	RTE	16	5000	RoHS 和绿色环保	NIPDAU	Level-1-260C-UNLIM	-40 至 125	LM324B
LM2902BIRTER	预发布	WQFN	RTE	16	5000	RoHS 和绿色环保	NIPDAU	Level-1-260C-UNLIM	-40 至 125	L2902B

(1) 销售状态值定义如下：

正在供货：建议用于新设计的产品器件。

限期购买：TI 已宣布器件即将停产，但仍在购买期限内。

NRND：不推荐用于新设计。为支持现有客户，器件仍在生产，但 TI 不建议在新设计中使用此器件。

PRE_PROD：器件未发布，尚未量产，未向大众市场供货，也未在网络上供应，未提供样片。

预发布：器件已发布，但未量产。可能提供样片，也可能无法提供样片。

已停产：TI 已停止生产该器件。

(2) 环保计划 - 规划的环保分级包括：无铅 (RoHS)，无铅 (RoHS 豁免) 或绿色 (RoHS，无镉/溴) - 如需了解最新供货信息及更多产品内容详情，请访问 www.ti.com.cn/productcontent。

待定：无铅/绿色环保转换计划尚未确定。

无铅 (RoHS)：TI 所说的“无铅”或“无 Pb”是指半导体产品符合针对所有 6 种物质的现行 RoHS 要求，包括要求铅的重量不超过同质材料总重量的 0.1%。因在设计时就考虑到了高温焊接要求，因此 TI 的无铅产品适用于指定的无铅作业。

无铅 (RoHS 豁免)：该元件在以下两种情况下可享受 RoHS 豁免：1) 芯片和封装之间使用铅基倒装芯片焊接凸点；2) 芯片和引线框之间使用铅基芯片粘合剂。否则，元件将根据上述规定视为无铅 (符合 RoHS)。

绿色环保 (RoHS，无镉/溴)：TI 定义的“绿色环保”表示无铅 (符合 RoHS 标准)、无溴 (Br) 和无镉 (Sb) 系阻燃剂 (均质材料中 Br 或 Sb 的质量不超过总质量的 0.1%)。

(3) MSL，峰值温度-- 湿敏等级额定值 (符合 JEDEC 工业标准分级) 和峰值焊接温度。

(4) 器件上可能还有与标识、批次跟踪代码信息或环境分类相关的其他标志。

(5) 如有多个器件标识，将用括号括起来。不过，器件上仅显示括号中以“~”隔开的其中一个器件标识。如果某一行缩进，说明该行续接上一行，这两行合在一起表示该器件的完整器件标识。

(6) 铅/焊球镀层 - 可订购器件可能有多种镀层材料选项。各镀层选项用垂直线隔开。如果铅/焊球镀层值超出最大列宽，则会折为两行。

重要信息和免责声明：本页面上提供的信息代表 TI 在提供该信息之日的认知和观点。TI 的认知和观点基于第三方提供的信息，TI 不对此类信息的正确性做任何声明或保证。TI 正在致力于更好地整合第三方信息。TI 已经并将继续采取合理的措施来提供有代表性且准确的信息，但是可能尚未对引入的原料和化学制品进行破坏性测试或化学分析。TI 和 TI 供应商认为某些信息属于专有信息，因此可能不会公布其 CAS 编号及其他受限制的信息。

在任何情况下，TI 因此类信息产生的责任决不超过 TI 每年向客户销售的本文档所述 TI 器件的总购买价。

11.2 卷带包装信息

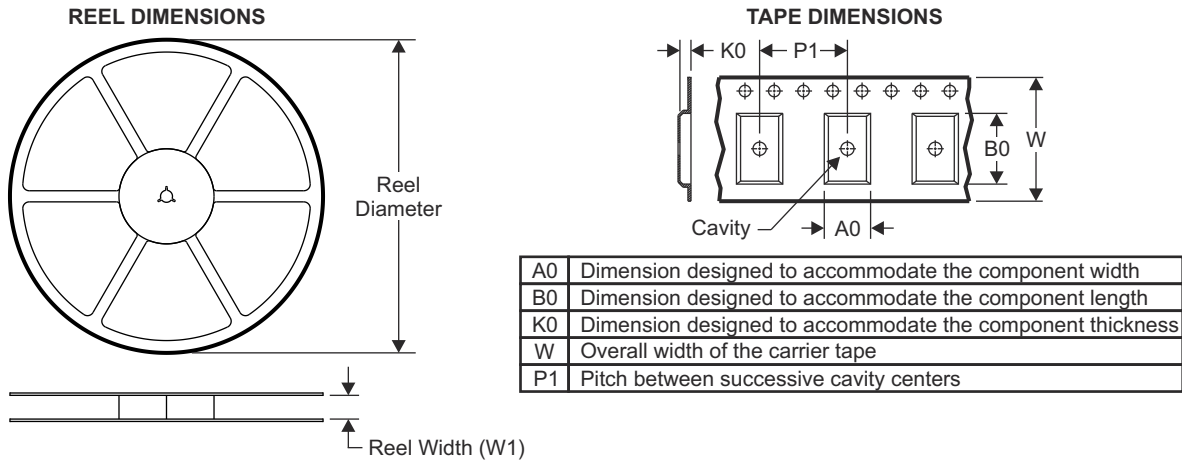

QUADRANT ASSIGNMENTS FOR PIN 1 ORIENTATION IN TAPE

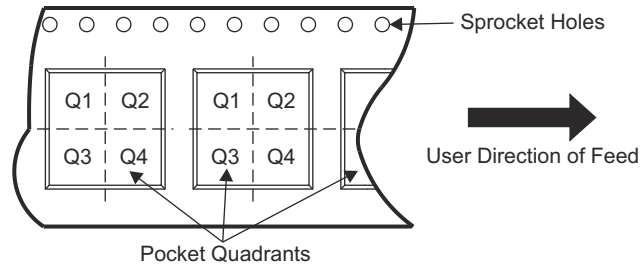

器件	封装类型	封装图	引脚	SPQ	卷带直径 (mm)	卷带宽度 W1 (mm)	A0 (mm)	B0 (mm)	K0 (mm)	P1 (mm)	W (mm)	Pin1 象限
LM324BIRTER	WQFN	RTE	16	5000	330	12.4	3.3	3.3	1.1	8	12	Q2
LM2902BIRTER	WQFN	RTE	16	5000	330	12.4	3.3	3.3	1.1	8	12	Q2

TAPE AND REEL BOX DIMENSIONS



器件	封装类型	封装图	引脚	SPQ	长度 (mm)	宽度 (mm)	高度 (mm)
LM324BIRTER	WQFN	RTE	16	5000	367.0	367.0	35.0
LM2902BIRTER	WQFN	RTE	16	5000	367.0	367.0	35.0

RTE0016C



PACKAGE OUTLINE
WQFN - 0.8 mm max height
 PLASTIC QUAD FLATPACK - NO LEAD

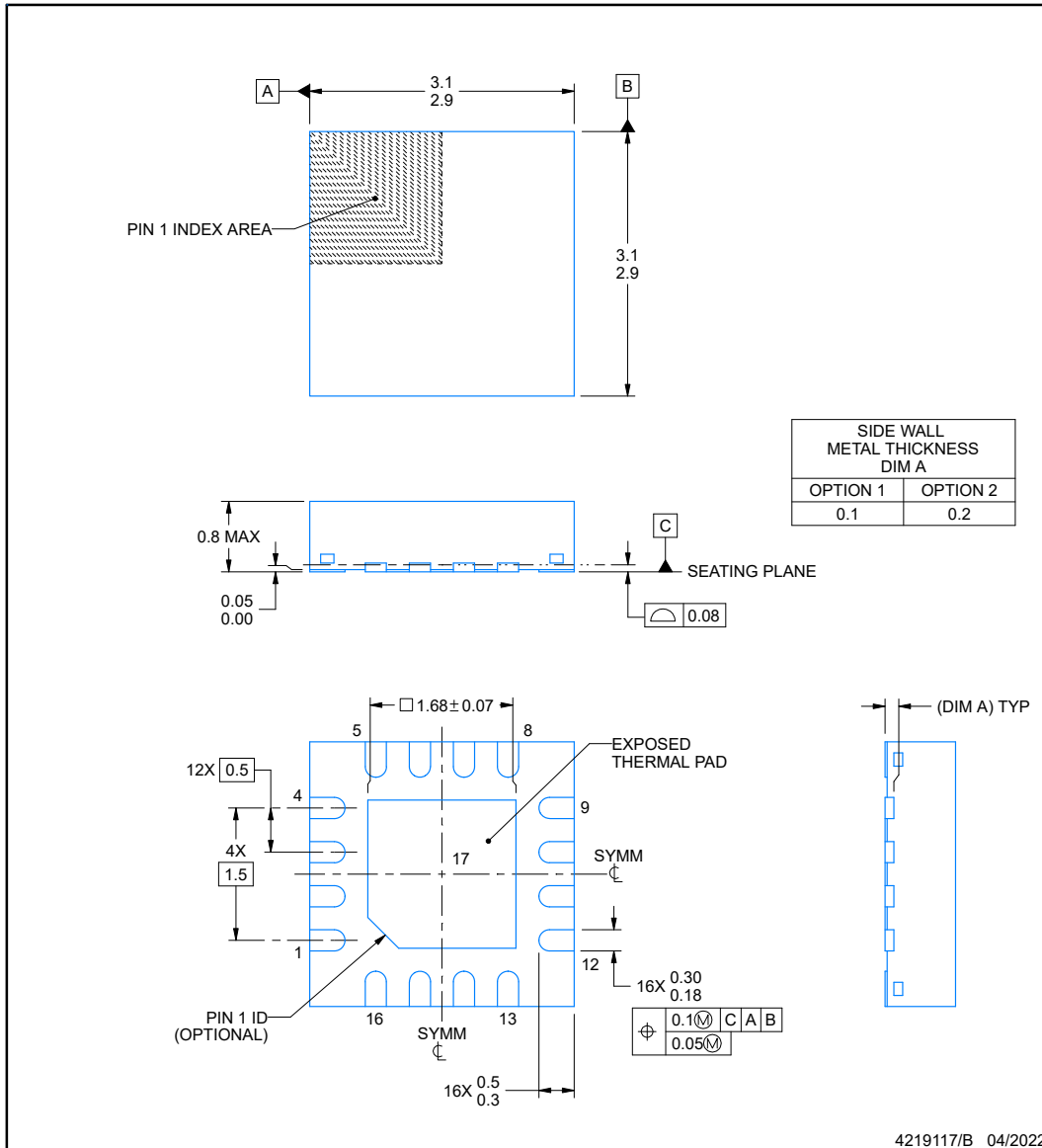

NOTES:

1. All linear dimensions are in millimeters. Any dimensions in parenthesis are for reference only. Dimensioning and tolerancing per ASME Y14.5M.
2. This drawing is subject to change without notice.
3. The package thermal pad must be soldered to the printed circuit board for thermal and mechanical performance.

EXAMPLE BOARD LAYOUT

RTE0016C

WQFN - 0.8 mm max height

PLASTIC QUAD FLATPACK - NO LEAD

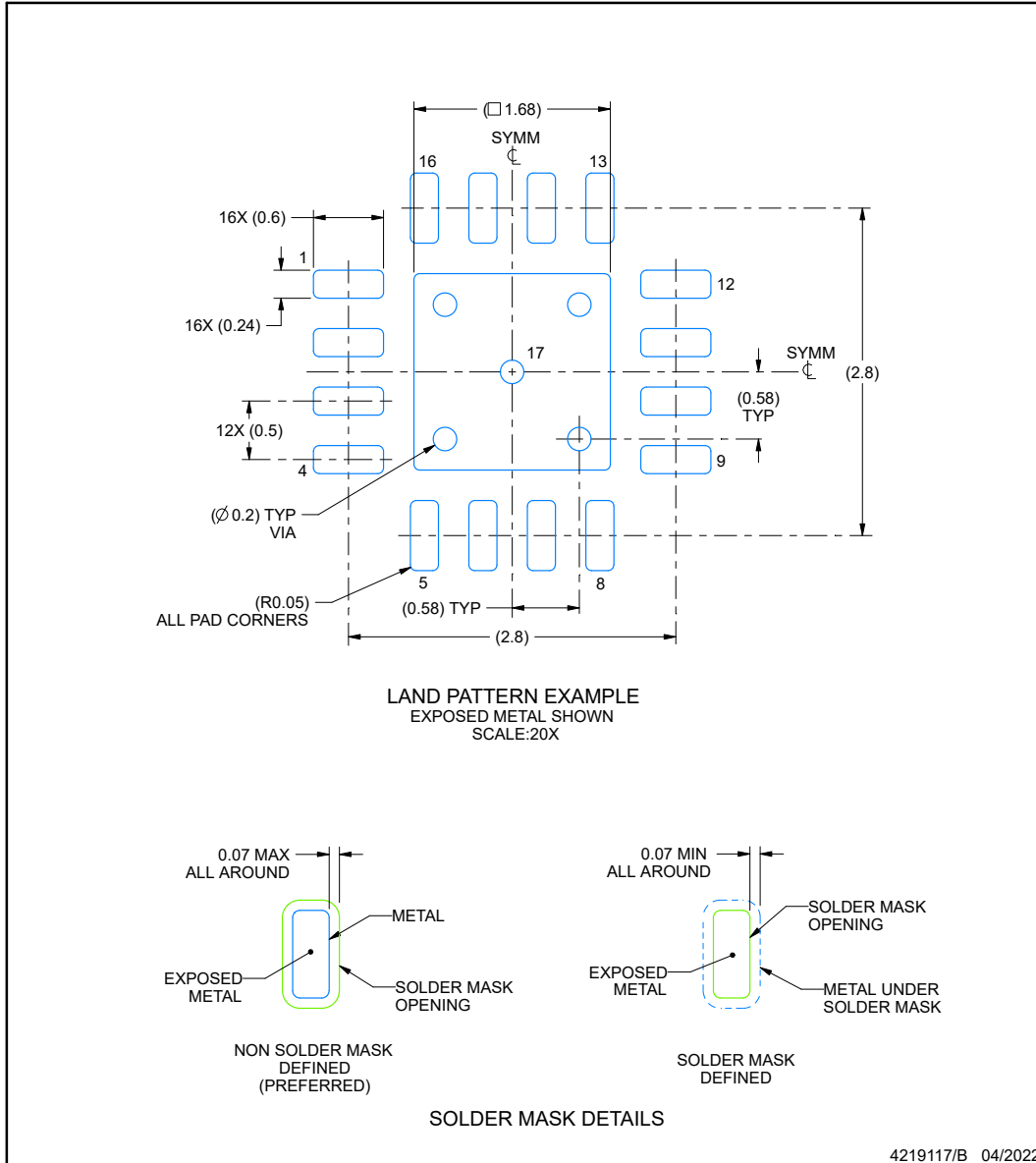

NOTES: (continued)

- This package is designed to be soldered to a thermal pad on the board. For more information, see Texas Instruments literature number SLUA271 (www.ti.com/lit/slua271).
- Vias are optional depending on application, refer to device data sheet. If any vias are implemented, refer to their locations shown on this view. It is recommended that vias under paste be filled, plugged or tented.

EXAMPLE STENCIL DESIGN

RTE0016C

WQFN - 0.8 mm max height

PLASTIC QUAD FLATPACK - NO LEAD

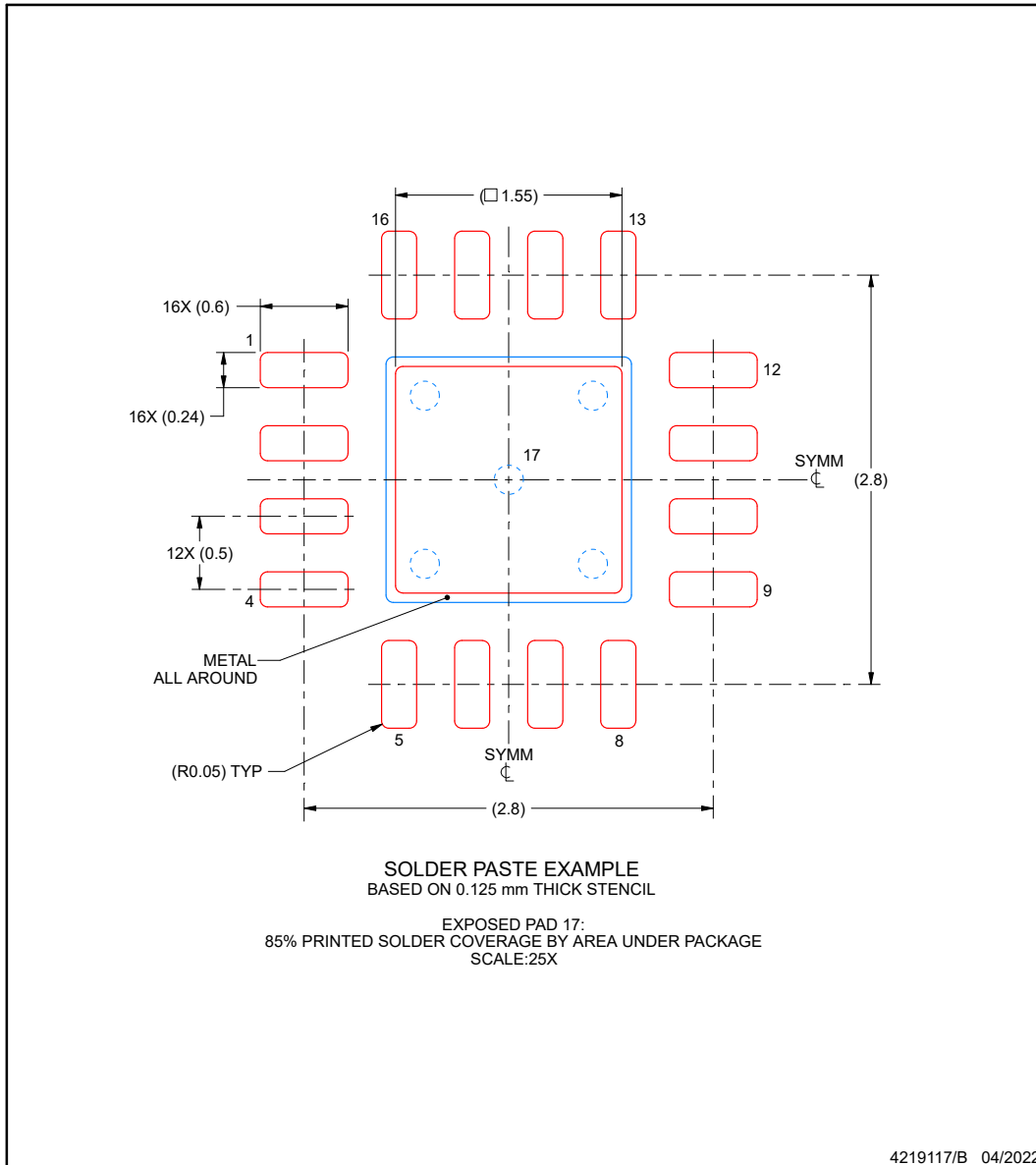

NOTES: (continued)

6. Laser cutting apertures with trapezoidal walls and rounded corners may offer better paste release. IPC-7525 may have alternate design recommendations.

PACKAGING INFORMATION

Orderable Device	Status (1)	Package Type	Package Drawing	Pins	Package Qty	Eco Plan (2)	Lead finish/ Ball material (6)	MSL Peak Temp (3)	Op Temp (°C)	Device Marking (4/5)	Samples
5962-7704301VCA	ACTIVE	CDIP	J	14	25	Non-RoHS & Green	SNPB	N / A for Pkg Type	-55 to 125	5962-7704301VC A LM124JQMLV	Samples
5962-9950403V9B	ACTIVE	XCEPT	KGD	0	100	RoHS & Green	Call TI	N / A for Pkg Type	-55 to 125		Samples
5962-9950403VCA	ACTIVE	CDIP	J	14	25	Non-RoHS & Green	SNPB	N / A for Pkg Type	-55 to 125	5962-9950403VC A LM124AJQMLV	Samples
77043012A	ACTIVE	LCCC	FK	20	55	Non-RoHS & Green	SNPB	N / A for Pkg Type	-55 to 125	77043012A LM124FKB	Samples
7704301CA	ACTIVE	CDIP	J	14	25	Non-RoHS & Green	SNPB	N / A for Pkg Type	-55 to 125	7704301CA LM124JB	Samples
7704301DA	ACTIVE	CFP	W	14	25	Non-RoHS & Green	SNPB	N / A for Pkg Type	-55 to 125	7704301DA LM124WB	Samples
77043022A	ACTIVE	LCCC	FK	20	55	Non-RoHS & Green	SNPB	N / A for Pkg Type	-55 to 125	77043022A LM124AFKB	Samples
7704302CA	ACTIVE	CDIP	J	14	25	Non-RoHS & Green	SNPB	N / A for Pkg Type	-55 to 125	7704302CA LM124AJB	Samples
7704302DA	ACTIVE	CFP	W	14	25	Non-RoHS & Green	SNPB	N / A for Pkg Type	-55 to 125	7704302DA LM124AWB	Samples
JM38510/11005BCA	ACTIVE	CDIP	J	14	25	Non-RoHS & Green	SNPB	N / A for Pkg Type	-55 to 125	JM38510 /11005BCA	Samples
LM124AFKB	ACTIVE	LCCC	FK	20	55	Non-RoHS & Green	SNPB	N / A for Pkg Type	-55 to 125	77043022A LM124AFKB	Samples
LM124AJ	ACTIVE	CDIP	J	14	25	Non-RoHS & Green	SNPB	N / A for Pkg Type	-55 to 125	LM124AJ	Samples
LM124AJB	ACTIVE	CDIP	J	14	25	Non-RoHS & Green	SNPB	N / A for Pkg Type	-55 to 125	7704302CA LM124AJB	Samples
LM124AWB	ACTIVE	CFP	W	14	25	Non-RoHS & Green	SNPB	N / A for Pkg Type	-55 to 125	7704302DA LM124AWB	Samples
LM124D	OBSOLETE	SOIC	D	14		TBD	Call TI	Call TI	-55 to 125	LM124	
LM124DR	ACTIVE	SOIC	D	14	2500	RoHS & Green	NIPDAU	Level-1-260C-UNLIM	-55 to 125	LM124	Samples
LM124DRG4	ACTIVE	SOIC	D	14	2500	RoHS & Green	NIPDAU	Level-1-260C-UNLIM	-55 to 125	LM124	Samples

Orderable Device	Status (1)	Package Type	Package Drawing	Pins	Package Qty	Eco Plan (2)	Lead finish/ Ball material (6)	MSL Peak Temp (3)	Op Temp (°C)	Device Marking (4/5)	Samples
LM124FKB	ACTIVE	LCCC	FK	20	55	Non-RoHS & Green	SNPB	N / A for Pkg Type	-55 to 125	77043012A LM124FKB	Samples
LM124J	ACTIVE	CDIP	J	14	25	Non-RoHS & Green	SNPB	N / A for Pkg Type	-55 to 125	LM124J	Samples
LM124JB	ACTIVE	CDIP	J	14	25	Non-RoHS & Green	SNPB	N / A for Pkg Type	-55 to 125	7704301CA LM124JB	Samples
LM124W	ACTIVE	CFP	W	14	25	Non-RoHS & Green	SNPB	N / A for Pkg Type	-55 to 125	LM124W	Samples
LM124WB	ACTIVE	CFP	W	14	25	Non-RoHS & Green	SNPB	N / A for Pkg Type	-55 to 125	7704301DA LM124WB	Samples
LM224AD	OBSOLETE	SOIC	D	14		TBD	Call TI	Call TI	-25 to 85	LM224A	
LM224ADR	ACTIVE	SOIC	D	14	2500	RoHS & Green	NIPDAU SN	Level-1-260C-UNLIM	-25 to 85	LM224A	Samples
LM224ADRE4	ACTIVE	SOIC	D	14	2500	RoHS & Green	NIPDAU	Level-1-260C-UNLIM	-25 to 85	LM224A	Samples
LM224ADRG4	ACTIVE	SOIC	D	14	2500	RoHS & Green	NIPDAU	Level-1-260C-UNLIM	-25 to 85	LM224A	Samples
LM224AN	ACTIVE	PDIP	N	14	25	RoHS & Green	NIPDAU	N / A for Pkg Type	-25 to 85	LM224AN	Samples
LM224D	OBSOLETE	SOIC	D	14		TBD	Call TI	Call TI	-25 to 85	LM224	
LM224DR	ACTIVE	SOIC	D	14	2500	RoHS & Green	NIPDAU SN	Level-1-260C-UNLIM	-25 to 85	LM224	Samples
LM224DRG3	OBSOLETE	SOIC	D	14		TBD	Call TI	Call TI	-25 to 85	LM224	
LM224DRG4	ACTIVE	SOIC	D	14	2500	RoHS & Green	NIPDAU	Level-1-260C-UNLIM	-25 to 85	LM224	Samples
LM224KAD	OBSOLETE	SOIC	D	14		TBD	Call TI	Call TI	-25 to 85	LM224KA	
LM224KADR	ACTIVE	SOIC	D	14	2500	RoHS & Green	NIPDAU	Level-1-260C-UNLIM	-25 to 85	LM224KA	Samples
LM224KADRG4	ACTIVE	SOIC	D	14	2500	TBD	Call TI	Call TI	-25 to 85		Samples
LM224KAN	ACTIVE	PDIP	N	14	25	RoHS & Green	NIPDAU	N / A for Pkg Type	-25 to 85	LM224KAN	Samples
LM224KDR	ACTIVE	SOIC	D	14	2500	RoHS & Green	NIPDAU	Level-1-260C-UNLIM	-25 to 85	LM224K	Samples
LM224KN	ACTIVE	PDIP	N	14	25	RoHS & Green	NIPDAU	N / A for Pkg Type	-25 to 85	LM224KN	Samples
LM224N	ACTIVE	PDIP	N	14	25	RoHS & Green	NIPDAU	N / A for Pkg Type	-25 to 85	LM224N	Samples

Orderable Device	Status (1)	Package Type	Package Drawing	Pins	Package Qty	Eco Plan (2)	Lead finish/ Ball material (6)	MSL Peak Temp (3)	Op Temp (°C)	Device Marking (4/5)	Samples
LM224NE4	ACTIVE	PDIP	N	14	25	TBD	Call TI	Call TI	-25 to 85		Samples
LM2902BAIDR	ACTIVE	SOIC	D	14	3000	RoHS & Green	NIPDAU	Level-1-260C-UNLIM	-40 to 125	LM2902BA	Samples
LM2902BAIPWR	ACTIVE	TSSOP	PW	14	3000	RoHS & Green	NIPDAU	Level-1-260C-UNLIM	-40 to 125	L2902BA	Samples
LM2902BIDR	ACTIVE	SOIC	D	14	3000	RoHS & Green	NIPDAU	Level-1-260C-UNLIM	-40 to 125	LM2902B	Samples
LM2902BIPWR	ACTIVE	TSSOP	PW	14	3000	RoHS & Green	NIPDAU	Level-1-260C-UNLIM	-40 to 125	LM2902B	Samples
LM2902D	OBSOLETE	SOIC	D	14		TBD	Call TI	Call TI	-40 to 125	LM2902	
LM2902DR	ACTIVE	SOIC	D	14	2500	RoHS & Green	NIPDAU SN	Level-1-260C-UNLIM	-40 to 125	LM2902	Samples
LM2902DRE4	ACTIVE	SOIC	D	14	2500	RoHS & Green	NIPDAU	Level-1-260C-UNLIM	-40 to 125	LM2902	Samples
LM2902DRG3	OBSOLETE	SOIC	D	14		TBD	Call TI	Call TI	-40 to 125	LM2902	
LM2902DRG4	ACTIVE	SOIC	D	14	2500	RoHS & Green	NIPDAU	Level-1-260C-UNLIM	-40 to 125	LM2902	Samples
LM2902KAVQDR	ACTIVE	SOIC	D	14	2500	RoHS & Green	NIPDAU	Level-1-260C-UNLIM	-40 to 125	L2902KA	Samples
LM2902KAVQDRG4	OBSOLETE	SOIC	D	14		TBD	Call TI	Call TI	-40 to 125	L2902KA	
LM2902KAVQPWR	ACTIVE	TSSOP	PW	14	2000	RoHS & Green	NIPDAU	Level-1-260C-UNLIM	-40 to 125	L2902KA	Samples
LM2902KAVQPWRG4	ACTIVE	TSSOP	PW	14	2000	RoHS & Green	NIPDAU	Level-1-260C-UNLIM	-40 to 125	L2902KA	Samples
LM2902KD	OBSOLETE	SOIC	D	14		TBD	Call TI	Call TI	-40 to 125	LM2902K	
LM2902KDB	ACTIVE	SSOP	DB	14	80	RoHS & Green	NIPDAU	Level-1-260C-UNLIM	-40 to 125	L2902K	Samples
LM2902KDR	ACTIVE	SOIC	D	14	2500	RoHS & Green	NIPDAU	Level-1-260C-UNLIM	-40 to 125	LM2902K	Samples
LM2902KN	ACTIVE	PDIP	N	14	25	RoHS & Green	NIPDAU	N / A for Pkg Type	-40 to 125	LM2902KN	Samples
LM2902KNSR	ACTIVE	SO	NS	14	2000	RoHS & Green	NIPDAU	Level-1-260C-UNLIM	-40 to 125	LM2902K	Samples
LM2902KNSRG4	ACTIVE	SO	NS	14	2000	RoHS & Green	NIPDAU	Level-1-260C-UNLIM	-40 to 125	LM2902K	Samples
LM2902KPW	OBSOLETE	TSSOP	PW	14		TBD	Call TI	Call TI	-40 to 125	L2902K	
LM2902KPWR	ACTIVE	TSSOP	PW	14	2000	RoHS & Green	NIPDAU	Level-1-260C-UNLIM	-40 to 125	L2902K	Samples
LM2902KVQDR	ACTIVE	SOIC	D	14	2500	RoHS & Green	NIPDAU	Level-1-260C-UNLIM	-40 to 125	L2902KV	Samples

Orderable Device	Status (1)	Package Type	Package Drawing	Pins	Package Qty	Eco Plan (2)	Lead finish/ Ball material (6)	MSL Peak Temp (3)	Op Temp (°C)	Device Marking (4/5)	Samples
LM2902KVQDRG4	OBSOLETE	SOIC	D	14		TBD	Call TI	Call TI	-40 to 125	L2902KV	
LM2902KVQPWR	ACTIVE	TSSOP	PW	14	2000	RoHS & Green	NIPDAU	Level-1-260C-UNLIM	-40 to 125	L2902KV	Samples
LM2902KVQPWRG4	OBSOLETE	TSSOP	PW	14		TBD	Call TI	Call TI	-40 to 125	L2902KV	
LM2902N	ACTIVE	PDIP	N	14	25	RoHS & Green	NIPDAU SN	N / A for Pkg Type	-40 to 125	LM2902N	Samples
LM2902NE4	OBSOLETE	PDIP	N	14		TBD	Call TI	Call TI	-40 to 125	LM2902N	
LM2902NSR	ACTIVE	SO	NS	14	2000	RoHS & Green	NIPDAU	Level-1-260C-UNLIM	-40 to 125	LM2902	Samples
LM2902PW	OBSOLETE	TSSOP	PW	14		TBD	Call TI	Call TI	-40 to 125	L2902	
LM2902PWR	ACTIVE	TSSOP	PW	14	2000	RoHS & Green	NIPDAU SN	Level-1-260C-UNLIM	-40 to 125	L2902	Samples
LM2902PWRE4	ACTIVE	TSSOP	PW	14	2000	RoHS & Green	NIPDAU	Level-1-260C-UNLIM	-40 to 125	L2902	Samples
LM2902PWRG3	OBSOLETE	TSSOP	PW	14		TBD	Call TI	Call TI	-40 to 125	L2902	
LM2902PWRG4	ACTIVE	TSSOP	PW	14	2000	RoHS & Green	NIPDAU	Level-1-260C-UNLIM	-40 to 125	L2902	Samples
LM324AD	OBSOLETE	SOIC	D	14		TBD	Call TI	Call TI	0 to 70	LM324A	
LM324ADBR	ACTIVE	SSOP	DB	14	2000	RoHS & Green	NIPDAU	Level-1-260C-UNLIM	0 to 70	LM324A	Samples
LM324ADR	ACTIVE	SOIC	D	14	2500	RoHS & Green	NIPDAU SN	Level-1-260C-UNLIM	0 to 70	LM324A	Samples
LM324ADRG4	OBSOLETE	SOIC	D	14		TBD	Call TI	Call TI	0 to 70	LM324A	
LM324AN	ACTIVE	PDIP	N	14	25	RoHS & Green	NIPDAU	N / A for Pkg Type	0 to 70	LM324AN	Samples
LM324ANSR	ACTIVE	SO	NS	14	2000	RoHS & Green	NIPDAU	Level-1-260C-UNLIM	0 to 70	LM324A	Samples
LM324ANSRG4	ACTIVE	SO	NS	14	2000	RoHS & Green	NIPDAU	Level-1-260C-UNLIM	0 to 70	LM324A	Samples
LM324APW	OBSOLETE	TSSOP	PW	14		TBD	Call TI	Call TI	0 to 70	L324A	
LM324APWR	ACTIVE	TSSOP	PW	14	2000	RoHS & Green	NIPDAU SN	Level-1-260C-UNLIM	0 to 70	L324A	Samples
LM324APWRG4	ACTIVE	TSSOP	PW	14	2000	RoHS & Green	NIPDAU	Level-1-260C-UNLIM	0 to 70	L324A	Samples
LM324BAIDR	ACTIVE	SOIC	D	14	3000	RoHS & Green	NIPDAU	Level-1-260C-UNLIM	-40 to 85	LM324BA	Samples
LM324BAIPWR	ACTIVE	TSSOP	PW	14	3000	RoHS & Green	NIPDAU	Level-1-260C-UNLIM	-40 to 85	L324BA	Samples

Orderable Device	Status (1)	Package Type	Package Drawing	Pins	Package Qty	Eco Plan (2)	Lead finish/ Ball material (6)	MSL Peak Temp (3)	Op Temp (°C)	Device Marking (4/5)	Samples
LM324BIDR	ACTIVE	SOIC	D	14	3000	RoHS & Green	NIPDAU	Level-1-260C-UNLIM	-40 to 85	LM324B	Samples
LM324BIPWR	ACTIVE	TSSOP	PW	14	3000	RoHS & Green	NIPDAU	Level-1-260C-UNLIM	-40 to 85	LM324B	Samples
LM324D	OBSOLETE	SOIC	D	14		TBD	Call TI	Call TI	0 to 70	LM324	
LM324DR	ACTIVE	SOIC	D	14	2500	RoHS & Green	NIPDAU SN	Level-1-260C-UNLIM	0 to 70	LM324	Samples
LM324DRE4	ACTIVE	SOIC	D	14	2500	RoHS & Green	NIPDAU	Level-1-260C-UNLIM	0 to 70	LM324	Samples
LM324DRG3	OBSOLETE	SOIC	D	14		TBD	Call TI	Call TI	0 to 70	LM324	
LM324DRG4	ACTIVE	SOIC	D	14	2500	RoHS & Green	NIPDAU	Level-1-260C-UNLIM	0 to 70	LM324	Samples
LM324KAD	OBSOLETE	SOIC	D	14		TBD	Call TI	Call TI	0 to 70	LM324KA	
LM324KADR	ACTIVE	SOIC	D	14	2500	RoHS & Green	NIPDAU	Level-1-260C-UNLIM	0 to 70	LM324KA	Samples
LM324KADRG4	ACTIVE	SOIC	D	14	2500	TBD	Call TI	Call TI	0 to 70		Samples
LM324KAN	ACTIVE	PDIP	N	14	25	RoHS & Green	NIPDAU	N / A for Pkg Type	0 to 70	LM324KAN	Samples
LM324KANSR	ACTIVE	SO	NS	14	2000	RoHS & Green	NIPDAU	Level-1-260C-UNLIM	0 to 70	LM324KA	Samples
LM324KAPW	OBSOLETE	TSSOP	PW	14		TBD	Call TI	Call TI	0 to 70	L324KA	
LM324KAPWR	ACTIVE	TSSOP	PW	14	2000	RoHS & Green	NIPDAU	Level-1-260C-UNLIM	0 to 70	L324KA	Samples
LM324KDR	ACTIVE	SOIC	D	14	2500	RoHS & Green	NIPDAU	Level-1-260C-UNLIM	0 to 70	LM324K	Samples
LM324KN	ACTIVE	PDIP	N	14	25	RoHS & Green	NIPDAU	N / A for Pkg Type	0 to 70	LM324KN	Samples
LM324KNSR	ACTIVE	SO	NS	14	2000	RoHS & Green	NIPDAU	Level-1-260C-UNLIM	0 to 70	LM324K	Samples
LM324KPW	OBSOLETE	TSSOP	PW	14		TBD	Call TI	Call TI	0 to 70	L324K	
LM324KPWR	ACTIVE	TSSOP	PW	14	2000	RoHS & Green	NIPDAU	Level-1-260C-UNLIM	0 to 70	L324K	Samples
LM324N	ACTIVE	PDIP	N	14	25	RoHS & Green	NIPDAU SN	N / A for Pkg Type	0 to 70	LM324N	Samples
LM324NE3	OBSOLETE	PDIP	N	14		TBD	Call TI	Call TI	0 to 70	LM324N	
LM324NE4	OBSOLETE	PDIP	N	14		TBD	Call TI	Call TI	0 to 70	LM324N	
LM324NSR	ACTIVE	SO	NS	14	2000	RoHS & Green	NIPDAU	Level-1-260C-UNLIM	0 to 70	LM324	Samples

Orderable Device	Status (1)	Package Type	Package Drawing	Pins	Package Qty	Eco Plan (2)	Lead finish/ Ball material (6)	MSL Peak Temp (3)	Op Temp (°C)	Device Marking (4/5)	Samples
LM324NSRE4	ACTIVE	SO	NS	14	2000	RoHS & Green	NIPDAU	Level-1-260C-UNLIM	0 to 70	LM324	Samples
LM324NSRG4	ACTIVE	SO	NS	14	2000	RoHS & Green	NIPDAU	Level-1-260C-UNLIM	0 to 70	LM324	Samples
LM324PW	OBSOLETE	TSSOP	PW	14		TBD	Call TI	Call TI	0 to 70	L324	
LM324PWR	ACTIVE	TSSOP	PW	14	2000	RoHS & Green	NIPDAU SN	Level-1-260C-UNLIM	0 to 70	L324	Samples
LM324PWRE4	ACTIVE	TSSOP	PW	14	2000	RoHS & Green	NIPDAU	Level-1-260C-UNLIM	0 to 70	L324	Samples
LM324PWRG3	OBSOLETE	TSSOP	PW	14		TBD	Call TI	Call TI	0 to 70	L324	
LM324PWRG4	ACTIVE	TSSOP	PW	14	2000	RoHS & Green	NIPDAU	Level-1-260C-UNLIM	0 to 70	L324	Samples
M38510/11005BCA	ACTIVE	CDIP	J	14	25	Non-RoHS & Green	SNPB	N / A for Pkg Type	-55 to 125	JM38510 /11005BCA	Samples
PLM2902BIDR	ACTIVE	SOIC	D	14	3000	TBD	Call TI	Call TI	-40 to 125		Samples
PLM324BIDR	ACTIVE	SOIC	D	14	3000	TBD	Call TI	Call TI	-40 to 85		Samples

(1) The marketing status values are defined as follows:

ACTIVE: Product device recommended for new designs.

LIFEBUY: TI has announced that the device will be discontinued, and a lifetime-buy period is in effect.

NRND: Not recommended for new designs. Device is in production to support existing customers, but TI does not recommend using this part in a new design.

PREVIEW: Device has been announced but is not in production. Samples may or may not be available.

OBSOLETE: TI has discontinued the production of the device.

(2) **RoHS:** TI defines "RoHS" to mean semiconductor products that are compliant with the current EU RoHS requirements for all 10 RoHS substances, including the requirement that RoHS substance do not exceed 0.1% by weight in homogeneous materials. Where designed to be soldered at high temperatures, "RoHS" products are suitable for use in specified lead-free processes. TI may reference these types of products as "Pb-Free".

RoHS Exempt: TI defines "RoHS Exempt" to mean products that contain lead but are compliant with EU RoHS pursuant to a specific EU RoHS exemption.

Green: TI defines "Green" to mean the content of Chlorine (Cl) and Bromine (Br) based flame retardants meet JS709B low halogen requirements of <=1000ppm threshold. Antimony trioxide based flame retardants must also meet the <=1000ppm threshold requirement.

(3) MSL, Peak Temp. - The Moisture Sensitivity Level rating according to the JEDEC industry standard classifications, and peak solder temperature.

(4) There may be additional marking, which relates to the logo, the lot trace code information, or the environmental category on the device.

(5) Multiple Device Markings will be inside parentheses. Only one Device Marking contained in parentheses and separated by a "~" will appear on a device. If a line is indented then it is a continuation of the previous line and the two combined represent the entire Device Marking for that device.

(6) Lead finish/Ball material - Orderable Devices may have multiple material finish options. Finish options are separated by a vertical ruled line. Lead finish/Ball material values may wrap to two lines if the finish value exceeds the maximum column width.

Important Information and Disclaimer:The information provided on this page represents TI's knowledge and belief as of the date that it is provided. TI bases its knowledge and belief on information provided by third parties, and makes no representation or warranty as to the accuracy of such information. Efforts are underway to better integrate information from third parties. TI has taken and continues to take reasonable steps to provide representative and accurate information but may not have conducted destructive testing or chemical analysis on incoming materials and chemicals. TI and TI suppliers consider certain information to be proprietary, and thus CAS numbers and other limited information may not be available for release.

In no event shall TI's liability arising out of such information exceed the total purchase price of the TI part(s) at issue in this document sold by TI to Customer on an annual basis.

OTHER QUALIFIED VERSIONS OF LM124, LM124-SP, LM124M, LM2902, LM2902B, LM2902BA :

- Catalog : [LM124](#), [LM124](#)

- Automotive : [LM2902-Q1](#), [LM2902B-Q1](#), [LM2902BA-Q1](#)

- Enhanced Product : [LM2902-EP](#)

- Military : [LM124M](#), [LM124M](#)

- Space : [LM124-SP](#), [LM124-SP](#)

NOTE: Qualified Version Definitions:

- Catalog - TI's standard catalog product

- Automotive - Q100 devices qualified for high-reliability automotive applications targeting zero defects

- Enhanced Product - Supports Defense, Aerospace and Medical Applications

- Military - QML certified for Military and Defense Applications

- Space - Radiation tolerant, ceramic packaging and qualified for use in Space-based application

TAPE AND REEL INFORMATION

QUADRANT ASSIGNMENTS FOR PIN 1 ORIENTATION IN TAPE

*All dimensions are nominal

Device	Package Type	Package Drawing	Pins	SPQ	Reel Diameter (mm)	Reel Width W1 (mm)	A0 (mm)	B0 (mm)	K0 (mm)	P1 (mm)	W (mm)	Pin1 Quadrant
LM124DR	SOIC	D	14	2500	330.0	16.4	6.5	9.0	2.1	8.0	16.0	Q1
LM224ADR	SOIC	D	14	2500	330.0	16.4	6.5	9.0	2.1	8.0	16.0	Q1
LM224ADR	SOIC	D	14	2500	330.0	16.4	6.5	9.0	2.1	8.0	16.0	Q1
LM224ADRG4	SOIC	D	14	2500	330.0	16.4	6.5	9.0	2.1	8.0	16.0	Q1
LM224ADRG4	SOIC	D	14	2500	330.0	16.4	6.5	9.0	2.1	8.0	16.0	Q1
LM224DR	SOIC	D	14	2500	330.0	16.4	6.5	9.0	2.1	8.0	16.0	Q1
LM224DRG4	SOIC	D	14	2500	330.0	16.4	6.5	9.0	2.1	8.0	16.0	Q1
LM224KADR	SOIC	D	14	2500	330.0	16.4	6.5	9.0	2.1	8.0	16.0	Q1
LM224KADR	SOIC	D	14	2500	330.0	16.4	6.5	9.0	2.1	8.0	16.0	Q1
LM224KDR	SOIC	D	14	2500	330.0	16.4	6.5	9.0	2.1	8.0	16.0	Q1
LM2902BAIDR	SOIC	D	14	3000	330.0	12.4	6.4	5.2	2.1	8.0	12.0	Q1
LM2902BAIPWR	TSSOP	PW	14	3000	330.0	12.4	6.9	5.6	1.6	8.0	12.0	Q1
LM2902BIDR	SOIC	D	14	3000	330.0	12.4	6.4	5.2	2.1	8.0	12.0	Q1
LM2902DR	SOIC	D	14	2500	330.0	16.4	6.5	9.0	2.1	8.0	16.0	Q1
LM2902DRG4	SOIC	D	14	2500	330.0	16.4	6.5	9.0	2.1	8.0	16.0	Q1
LM2902KAVQPWR	TSSOP	PW	14	2000	330.0	12.4	6.9	5.6	1.6	8.0	12.0	Q1
LM2902KAVQPWRG4	TSSOP	PW	14	2000	330.0	12.4	6.9	5.6	1.6	8.0	12.0	Q1

Device	Package Type	Package Drawing	Pins	SPQ	Reel Diameter (mm)	Reel Width W1 (mm)	A0 (mm)	B0 (mm)	K0 (mm)	P1 (mm)	W (mm)	Pin1 Quadrant
LM2902KDR	SOIC	D	14	2500	330.0	16.4	6.5	9.0	2.1	8.0	16.0	Q1
LM2902KNSR	SO	NS	14	2000	330.0	16.4	8.2	10.5	2.5	12.0	16.0	Q1
LM2902KPWR	TSSOP	PW	14	2000	330.0	12.4	6.9	5.6	1.6	8.0	12.0	Q1
LM2902KVQPWR	TSSOP	PW	14	2000	330.0	12.4	6.9	5.6	1.6	8.0	12.0	Q1
LM2902NSR	SO	NS	14	2000	330.0	16.4	8.2	10.5	2.5	12.0	16.0	Q1
LM2902PWR	TSSOP	PW	14	2000	330.0	12.4	6.9	5.6	1.6	8.0	12.0	Q1
LM2902PWRG4	TSSOP	PW	14	2000	330.0	12.4	6.9	5.6	1.6	8.0	12.0	Q1
LM324ADBR	SSOP	DB	14	2000	330.0	16.4	8.35	6.6	2.4	12.0	16.0	Q1
LM324ADR	SOIC	D	14	2500	330.0	16.4	6.5	9.0	2.1	8.0	16.0	Q1
LM324ANSR	SO	NS	14	2000	330.0	16.4	8.2	10.5	2.5	12.0	16.0	Q1
LM324APWR	TSSOP	PW	14	2000	330.0	12.4	6.9	5.6	1.6	8.0	12.0	Q1
LM324APWRG4	TSSOP	PW	14	2000	330.0	12.4	6.9	5.6	1.6	8.0	12.0	Q1
LM324BAIDR	SOIC	D	14	3000	330.0	12.4	6.4	5.2	2.1	8.0	12.0	Q1
LM324BAIPWR	TSSOP	PW	14	3000	330.0	12.4	6.9	5.6	1.6	8.0	12.0	Q1
LM324BIDR	SOIC	D	14	3000	330.0	12.4	6.4	5.2	2.1	8.0	12.0	Q1
LM324BIPWR	TSSOP	PW	14	3000	330.0	12.4	6.9	5.6	1.6	8.0	12.0	Q1
LM324DR	SOIC	D	14	2500	330.0	16.4	6.5	9.0	2.1	8.0	16.0	Q1
LM324DR	SOIC	D	14	2500	330.0	16.4	6.5	9.0	2.1	8.0	16.0	Q1
LM324DRG4	SOIC	D	14	2500	330.0	16.4	6.5	9.0	2.1	8.0	16.0	Q1
LM324DRG4	SOIC	D	14	2500	330.0	16.4	6.5	9.0	2.1	8.0	16.0	Q1
LM324KADR	SOIC	D	14	2500	330.0	16.4	6.5	9.0	2.1	8.0	16.0	Q1
LM324KANSR	SO	NS	14	2000	330.0	16.4	8.2	10.5	2.5	12.0	16.0	Q1
LM324KAPWR	TSSOP	PW	14	2000	330.0	12.4	6.9	5.6	1.6	8.0	12.0	Q1
LM324KDR	SOIC	D	14	2500	330.0	16.4	6.5	9.0	2.1	8.0	16.0	Q1
LM324KNSR	SO	NS	14	2000	330.0	16.4	8.2	10.5	2.5	12.0	16.0	Q1
LM324KPWR	TSSOP	PW	14	2000	330.0	12.4	6.9	5.6	1.6	8.0	12.0	Q1
LM324NSR	SO	NS	14	2000	330.0	16.4	8.2	10.5	2.5	12.0	16.0	Q1
LM324PWR	TSSOP	PW	14	2000	330.0	12.4	6.9	5.6	1.6	8.0	12.0	Q1
LM324PWRG4	TSSOP	PW	14	2000	330.0	12.4	6.9	5.6	1.6	8.0	12.0	Q1

TAPE AND REEL BOX DIMENSIONS

*All dimensions are nominal

Device	Package Type	Package Drawing	Pins	SPQ	Length (mm)	Width (mm)	Height (mm)
LM124DR	SOIC	D	14	2500	350.0	350.0	43.0
LM224ADR	SOIC	D	14	2500	356.0	356.0	35.0
LM224ADR	SOIC	D	14	2500	340.5	336.1	32.0
LM224ADRG4	SOIC	D	14	2500	340.5	336.1	32.0
LM224ADRG4	SOIC	D	14	2500	356.0	356.0	35.0
LM224DR	SOIC	D	14	2500	356.0	356.0	35.0
LM224DRG4	SOIC	D	14	2500	356.0	356.0	35.0
LM224KADR	SOIC	D	14	2500	356.0	356.0	35.0
LM224KDR	SOIC	D	14	2500	356.0	356.0	35.0
LM2902BAIDR	SOIC	D	14	3000	353.0	353.0	32.0
LM2902BAIPWR	TSSOP	PW	14	3000	356.0	356.0	35.0
LM2902BIDR	SOIC	D	14	3000	340.5	336.1	25.0
LM2902DR	SOIC	D	14	2500	353.0	353.0	32.0
LM2902DRG4	SOIC	D	14	2500	353.0	353.0	32.0
LM2902KAVQPWR	TSSOP	PW	14	2000	356.0	356.0	35.0
LM2902KAVQPWRG4	TSSOP	PW	14	2000	367.0	367.0	35.0
LM2902KDR	SOIC	D	14	2500	356.0	356.0	35.0
LM2902KNSR	SO	NS	14	2000	356.0	356.0	35.0

Device	Package Type	Package Drawing	Pins	SPQ	Length (mm)	Width (mm)	Height (mm)
LM2902KPWR	TSSOP	PW	14	2000	356.0	356.0	35.0
LM2902KVQPWR	TSSOP	PW	14	2000	356.0	356.0	35.0
LM2902NSR	SO	NS	14	2000	356.0	356.0	35.0
LM2902PWR	TSSOP	PW	14	2000	356.0	356.0	35.0
LM2902PWRG4	TSSOP	PW	14	2000	356.0	356.0	35.0
LM324ADBR	SSOP	DB	14	2000	356.0	356.0	35.0
LM324ADR	SOIC	D	14	2500	356.0	356.0	35.0
LM324ANSR	SO	NS	14	2000	356.0	356.0	35.0
LM324APWR	TSSOP	PW	14	2000	356.0	356.0	35.0
LM324APWRG4	TSSOP	PW	14	2000	356.0	356.0	35.0
LM324BAIDR	SOIC	D	14	3000	340.5	336.1	25.0
LM324BAIPWR	TSSOP	PW	14	3000	356.0	356.0	35.0
LM324BIDR	SOIC	D	14	3000	340.5	336.1	25.0
LM324BIPWR	TSSOP	PW	14	3000	356.0	356.0	35.0
LM324DR	SOIC	D	14	2500	353.0	353.0	32.0
LM324DR	SOIC	D	14	2500	356.0	356.0	35.0
LM324DRG4	SOIC	D	14	2500	353.0	353.0	32.0
LM324DRG4	SOIC	D	14	2500	356.0	356.0	35.0
LM324KADR	SOIC	D	14	2500	356.0	356.0	35.0
LM324KANSR	SO	NS	14	2000	356.0	356.0	35.0
LM324KAPWR	TSSOP	PW	14	2000	356.0	356.0	35.0
LM324KDR	SOIC	D	14	2500	356.0	356.0	35.0
LM324KNSR	SO	NS	14	2000	356.0	356.0	35.0
LM324KPWR	TSSOP	PW	14	2000	356.0	356.0	35.0
LM324NSR	SO	NS	14	2000	356.0	356.0	35.0
LM324PWR	TSSOP	PW	14	2000	356.0	356.0	35.0
LM324PWRG4	TSSOP	PW	14	2000	356.0	356.0	35.0

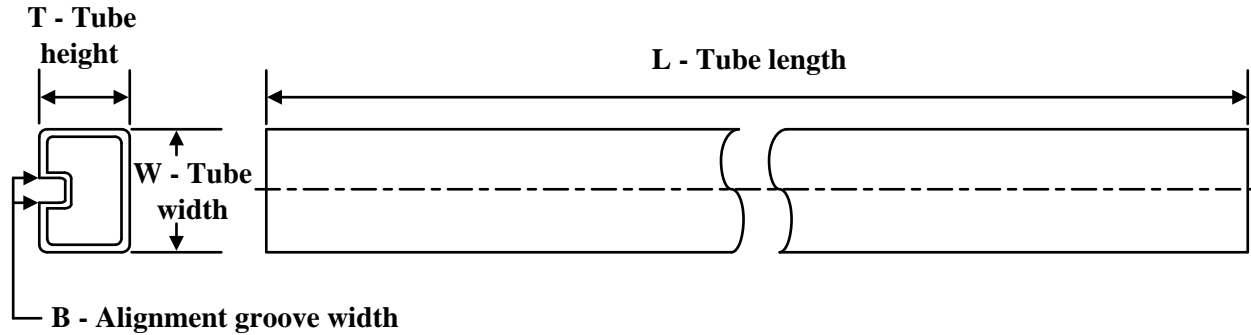
TUBE

*All dimensions are nominal

Device	Package Name	Package Type	Pins	SPQ	L (mm)	W (mm)	T (µm)	B (mm)
5962-9950403VCA	J	CDIP	14	25	506.98	15.24	13440	NA
77043012A	FK	LCCC	20	55	506.98	12.06	2030	NA
7704301DA	W	CFP	14	25	506.98	26.16	6220	NA
77043022A	FK	LCCC	20	55	506.98	12.06	2030	NA
7704302DA	W	CFP	14	25	506.98	26.16	6220	NA
LM124AFKB	FK	LCCC	20	55	506.98	12.06	2030	NA
LM124AWB	W	CFP	14	25	506.98	26.16	6220	NA
LM124FKB	FK	LCCC	20	55	506.98	12.06	2030	NA
LM124W	W	CFP	14	25	506.98	26.16	6220	NA
LM124WB	W	CFP	14	25	506.98	26.16	6220	NA
LM224AN	N	PDIP	14	25	506	13.97	11230	4.32
LM224KAN	N	PDIP	14	25	506	13.97	11230	4.32
LM224KN	N	PDIP	14	25	506	13.97	11230	4.32
LM224N	N	PDIP	14	25	506	13.97	11230	4.32
LM2902KDB	DB	SSOP	14	80	530	10.5	4000	4.1
LM2902KN	N	PDIP	14	25	506	13.97	11230	4.32
LM2902N	N	PDIP	14	25	506.1	9	600	5.4
LM2902N	N	PDIP	14	25	506	13.97	11230	4.32
LM324AN	N	PDIP	14	25	506	13.97	11230	4.32
LM324AN	N	PDIP	14	25	506	13.97	11230	4.32
LM324KAN	N	PDIP	14	25	506	13.97	11230	4.32
LM324KAN	N	PDIP	14	25	506	13.97	11230	4.32
LM324KN	N	PDIP	14	25	506	13.97	11230	4.32
LM324KN	N	PDIP	14	25	506	13.97	11230	4.32
LM324N	N	PDIP	14	25	506	13.97	11230	4.32
LM324N	N	PDIP	14	25	506.1	9	600	5.4
LM324N	N	PDIP	14	25	506	13.97	11230	4.32
LM324N	N	PDIP	14	25	506	13.97	11230	4.32

N (R-PDIP-T**)

PLASTIC DUAL-IN-LINE PACKAGE

16 PINS SHOWN



- NOTES:
- A. All linear dimensions are in inches (millimeters).
 - B. This drawing is subject to change without notice.
 - Falls within JEDEC MS-001, except 18 and 20 pin minimum body length (Dim A).
 - The 20 pin end lead shoulder width is a vendor option, either half or full width.



4220202/B 12/2023

NOTES:

1. All linear dimensions are in millimeters. Any dimensions in parenthesis are for reference only. Dimensioning and tolerancing per ASME Y14.5M.
2. This drawing is subject to change without notice.
3. This dimension does not include mold flash, protrusions, or gate burrs. Mold flash, protrusions, or gate burrs shall not exceed 0.15 mm per side.
4. This dimension does not include interlead flash. Interlead flash shall not exceed 0.25 mm per side.
5. Reference JEDEC registration MO-153.

EXAMPLE BOARD LAYOUT

PW0014A

TSSOP - 1.2 mm max height

SMALL OUTLINE PACKAGE



LAND PATTERN EXAMPLE
EXPOSED METAL SHOWN
SCALE: 10X



4220202/B 12/2023

NOTES: (continued)

- 6. Publication IPC-7351 may have alternate designs.
- 7. Solder mask tolerances between and around signal pads can vary based on board fabrication site.

EXAMPLE STENCIL DESIGN

PW0014A

TSSOP - 1.2 mm max height

SMALL OUTLINE PACKAGE



SOLDER PASTE EXAMPLE
BASED ON 0.125 mm THICK STENCIL
SCALE: 10X

4220202/B 12/2023

NOTES: (continued)

8. Laser cutting apertures with trapezoidal walls and rounded corners may offer better paste release. IPC-7525 may have alternate design recommendations.
9. Board assembly site may have different recommendations for stencil design.

GENERIC PACKAGE VIEW

RTE 16

WQFN - 0.8 mm max height

3 x 3, 0.5 mm pitch

PLASTIC QUAD FLATPACK - NO LEAD

This image is a representation of the package family, actual package may vary.
Refer to the product data sheet for package details.

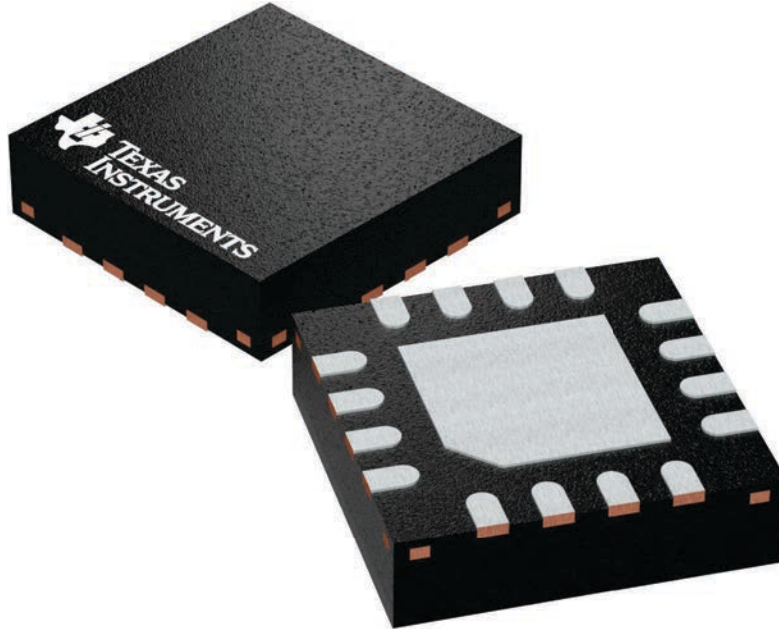

4225944/A

D0014A



PACKAGE OUTLINE

SOIC - 1.75 mm max height

SMALL OUTLINE INTEGRATED CIRCUIT



4220718/A 09/2016

NOTES:

- All linear dimensions are in millimeters. Dimensions in parenthesis are for reference only. Dimensioning and tolerancing per ASME Y14.5M.
- This drawing is subject to change without notice.
- This dimension does not include mold flash, protrusions, or gate burrs. Mold flash, protrusions, or gate burrs shall not exceed 0.15 mm, per side.
- This dimension does not include interlead flash. Interlead flash shall not exceed 0.43 mm, per side.
- Reference JEDEC registration MS-012, variation AB.

EXAMPLE BOARD LAYOUT

D0014A

SOIC - 1.75 mm max height

SMALL OUTLINE INTEGRATED CIRCUIT



LAND PATTERN EXAMPLE
SCALE:8X



SOLDER MASK DETAILS

4220718/A 09/2016

NOTES: (continued)

- 6. Publication IPC-7351 may have alternate designs.
- 7. Solder mask tolerances between and around signal pads can vary based on board fabrication site.

EXAMPLE STENCIL DESIGN

D0014A

SOIC - 1.75 mm max height

SMALL OUTLINE INTEGRATED CIRCUIT



SOLDER PASTE EXAMPLE
BASED ON 0.125 mm THICK STENCIL
SCALE:8X

4220718/A 09/2016

NOTES: (continued)

8. Laser cutting apertures with trapezoidal walls and rounded corners may offer better paste release. IPC-7525 may have alternate design recommendations.
9. Board assembly site may have different recommendations for stencil design.

MECHANICAL DATA

NS (R-PDSO-G**)

PLASTIC SMALL-OUTLINE PACKAGE

14-PINS SHOWN



- NOTES:
- A. All linear dimensions are in millimeters.
 - B. This drawing is subject to change without notice.
 - C. Body dimensions do not include mold flash or protrusion, not to exceed 0,15.

W (R-GDFP-F14)

CERAMIC DUAL FLATPACK



- NOTES:
- A. All linear dimensions are in inches (millimeters).
 - B. This drawing is subject to change without notice.
 - C. This package can be hermetically sealed with a ceramic lid using glass frit.
 - D. Index point is provided on cap for terminal identification only.
 - E. Falls within MIL STD 1835 GDFP1-F14

DB0014A



PACKAGE OUTLINE

SSOP - 2 mm max height

SMALL OUTLINE PACKAGE



NOTES:

1. All linear dimensions are in millimeters. Any dimensions in parenthesis are for reference only. Dimensioning and tolerancing per ASME Y14.5M.
2. This drawing is subject to change without notice.
3. This dimension does not include mold flash, protrusions, or gate burrs. Mold flash, protrusions, or gate burrs shall not exceed 0.15 mm per side.
4. Reference JEDEC registration MO-150.

EXAMPLE BOARD LAYOUT

DB0014A

SSOP - 2 mm max height

SMALL OUTLINE PACKAGE



LAND PATTERN EXAMPLE
EXPOSED METAL SHOWN
SCALE: 10X



4220762/A 05/2024

NOTES: (continued)

- 5. Publication IPC-7351 may have alternate designs.
- 6. Solder mask tolerances between and around signal pads can vary based on board fabrication site.

EXAMPLE STENCIL DESIGN

DB0014A

SSOP - 2 mm max height

SMALL OUTLINE PACKAGE



SOLDER PASTE EXAMPLE
BASED ON 0.125 mm THICK STENCIL
SCALE: 10X

4220762/A 05/2024

NOTES: (continued)

7. Laser cutting apertures with trapezoidal walls and rounded corners may offer better paste release. IPC-7525 may have alternate design recommendations.
8. Board assembly site may have different recommendations for stencil design.

GENERIC PACKAGE VIEW

FK 20

LCCC - 2.03 mm max height

8.89 x 8.89, 1.27 mm pitch

LEADLESS CERAMIC CHIP CARRIER

This image is a representation of the package family, actual package may vary.
Refer to the product data sheet for package details.

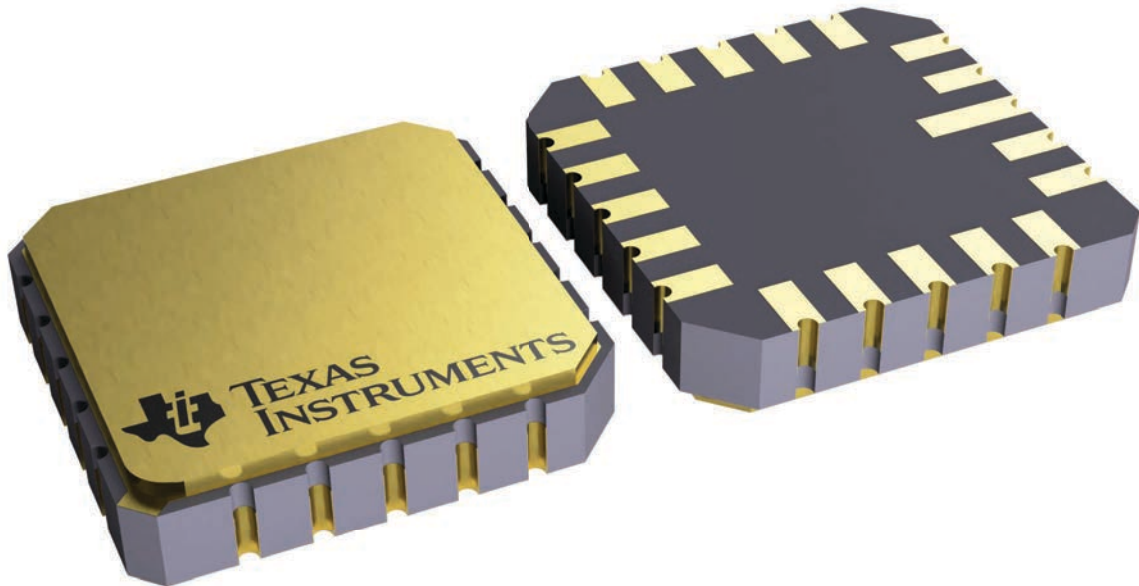

4229370VA\

J 14

GENERIC PACKAGE VIEW
CDIP - 5.08 mm max height
CERAMIC DUAL IN LINE PACKAGE



Images above are just a representation of the package family, actual package may vary.
Refer to the product data sheet for package details.

4040083-5/G

J0014A



PACKAGE OUTLINE

CDIP - 5.08 mm max height

CERAMIC DUAL IN LINE PACKAGE



4214771/A 05/2017

NOTES:

1. All controlling linear dimensions are in inches. Dimensions in brackets are in millimeters. Any dimension in brackets or parenthesis are for reference only. Dimensioning and tolerancing per ASME Y14.5M.
2. This drawing is subject to change without notice.
3. This package is hermetically sealed with a ceramic lid using glass frit.
4. Index point is provided on cap for terminal identification only and on press ceramic glass frit seal only.
5. Falls within MIL-STD-1835 and GDIP1-T14.

EXAMPLE BOARD LAYOUT

J0014A

CDIP - 5.08 mm max height

CERAMIC DUAL IN LINE PACKAGE



LAND PATTERN EXAMPLE
NON-SOLDER MASK DEFINED
SCALE: 5X



4214771/A 05/2017

重要声明和免责声明

TI“按原样”提供技术和可靠性数据（包括数据表）、设计资源（包括参考设计）、应用或其他设计建议、网络工具、安全信息和其他资源，不保证没有瑕疵且不做任何明示或暗示的担保，包括但不限于对适销性、某特定用途方面的适用性或不侵犯任何第三方知识产权的暗示担保。

这些资源可供使用 TI 产品进行设计的熟练开发人员使用。您将自行承担以下全部责任：(1) 针对您的应用选择合适的 TI 产品，(2) 设计、验证并测试您的应用，(3) 确保您的应用满足相应标准以及任何其他功能安全、信息安全、监管或其他要求。

这些资源如有变更，恕不另行通知。TI 授权您仅可将这些资源用于研发本资源所述的 TI 产品的应用。严禁对这些资源进行其他复制或展示。您无权使用任何其他 TI 知识产权或任何第三方知识产权。您应全额赔偿因在这些资源的使用中对 TI 及其代表造成的任何索赔、损害、成本、损失和债务，TI 对此概不负责。

TI 提供的产品受 [TI 的销售条款](#) 或 [ti.com](#) 上其他适用条款/TI 产品随附的其他适用条款的约束。TI 提供这些资源并不会扩展或以其他方式更改 TI 针对 TI 产品发布的适用的担保或担保免责声明。

TI 反对并拒绝您可能提出的任何其他或不同的条款。

邮寄地址：Texas Instruments, Post Office Box 655303, Dallas, Texas 75265

Copyright © 2024，德州仪器 (TI) 公司