

LM2903-Q1 和 LM2903B-Q1 汽车类双路比较器

特性

- 符合汽车应用要求
- 具有符合 AEC-Q100 标准的下列特性：
 - 器件温度等级 0：-40°C 至 150°C 的环境工作温度范围 (LM2903E-Q1)
 - 器件温度等级 1：-40°C 至 125°C 的环境工作温度范围
 - 器件 HBM ESD 分级等级 H1C
 - 器件 CDM ESD 分级等级 C4B
- 改进了“B”器件的 2kV HBM ESD
- 可用于“B”器件的 Tri-Temp 测试
- 单电源或双电源
- 独立于电源电压的低电源电流：
 - 每个比较器 200uA (典型值) (“B”版本)
- 低输入偏置电流：3.5nA (典型值) (“B”器件)
- 低输入失调电流：0.5nA (典型值) (“B”器件)
- 低输入失调电压： $\pm 0.37\text{mV}$ (典型值) (“B”器件)
- 共模输入电压范围包括接地
- 差动输入电压范围等于最大额定电源电压： $\pm 36\text{V}$
- 输出与 TTL、MOS 和 CMOS 兼容
- 提供功能安全
 - 有助于进行功能安全系统设计的文档

应用

- 汽车
 - HEV/EV 和动力总成
 - 信息娱乐系统与仪表组
 - 车身控制模块
- 工业
- 电器

说明

LM2903B-Q1 器件是业界通用 LM2903-Q1 比较器系列的下一代版本。该下一代系列为成本敏感型应用提供了卓越的价值，其特性包括更低的失调电压、更高的电源电压能力、更低的电源电流、更低的输入偏置电流、更低的传播延迟以及更高的 2kV ESD 性能，并提供了直接替代的便利性。

所有器件都包含两个独立的电压比较器，这些比较器可在广泛的电压范围内运行。如果两个电源的电压差处于 2V 至 36V 范围内且 VCC 比输入共模电压至少高 1.5V，那么也可以使用双电源。输出可以连接到其他集电极开路输出。

LM2903-Q1 和 LM2903B-Q1 符合 -40°C 至 +125°C 的 AEC-Q100 1 级温度范围。LM2903E-Q1 符合 -40°C 至 +150°C 的 0 级工作温度范围。

器件信息

器件型号	封装 ⁽¹⁾	封装尺寸 (标称值)
LM2903B-Q1	SOIC (8)	4.90mm × 3.91mm
	TSSOP (8)	3.00mm × 4.40mm
	VSSOP (8)	3.00mm × 3.00mm
	WSON (8)	2.00mm × 2.00mm
	SOT-23 (8)	1.60mm × 2.90mm
LM2903-Q1	SOIC (8)	4.90mm × 3.91mm
	TSSOP (8)	3.00mm × 4.40mm
	VSSOP (8)	3.00mm × 3.00mm
LM2903E-Q1	TSSOP (8)	3.00mm × 4.40mm

(1) 如需了解所有可用封装，请参阅产品说明书末尾的可订购产品附录。

系列比较表

规格	LM2903B-Q1	LM2903-Q1	LM2903-Q1 “A” 器件	LM2903-Q1 “AV” 器件	LM2903E-Q1	单位
指定电源电压	2 至 36	2 至 30	2 至 30	2 至 32	2 至 30	V
总电源电流 (5V 至 V_S max)	0.6 至 0.8	1 至 2.5	1 至 2.5	1 至 2.5	1 至 2.5	mA
温度范围	-40 至 125	-40 至 125	-40 至 125	-40 至 125	-40 至 150	°C
ESD (HBM/CDM)	2k/1k	1k/750	1k/750	1k/750	1k/750	V
失调电压 (整个温度范围内的最大值)	± 4	± 15	± 4	± 4	± 15	mV
输入偏置电流 (典型值/最大值)	3.5/25	25/250	25/250	25/250	25/250	nA
响应时间 (典型值)	1	1.3	1.3	1.3	1.3	μsec



Table of Contents

特性.....	1	3.14 Switching Characteristics, LM2903-Q1 and LM2903E-Q1.....	9
应用.....	1	3.15 Typical Characteristics, LM2903-Q1 and LM2903E-Q1 Only.....	10
说明.....	1	3.16 Typical Characteristics, LM2903B-Q1 Only.....	11
1 Revision History.....	2	4 Detailed Description.....	17
2 Pin Configuration and Functions.....	4	4.1 Overview.....	17
2.1 Pin Functions.....	4	4.2 Functional Block Diagram.....	17
3 Specifications.....	5	4.3 Feature Description.....	17
3.1 Absolute Maximum Ratings, LM2903-Q1 and LM2903E-Q1.....	5	4.4 Device Functional Modes.....	17
3.2 Absolute Maximum Ratings, LM2903B-Q1.....	5	5 Application and Implementation.....	18
3.3 ESD Ratings, LM2903-Q1 and LM2903E-Q1.....	5	5.1 Application Information.....	18
3.4 ESD Ratings, LM2903B-Q1.....	5	5.2 Typical Application.....	18
3.5 Recommended Operating Conditions, LM2903B-Q1.....	6	5.3 Power Supply Recommendations.....	20
3.6 Recommended Operating Conditions, LM2903-Q1.....	6	5.4 Layout.....	20
3.7 Recommended Operating Conditions, LM2903E-Q1.....	6	6 Device and Documentation Support.....	21
3.8 Thermal Information, LM2903-Q1 and LM2903E-Q1.....	6	6.1 Documentation Support.....	21
3.9 Thermal Information, LM2903B-Q1.....	7	6.2 Receiving Notification of Documentation Updates.....	21
3.10 Electrical Characteristics LM2903B - Q1.....	8	6.3 支持资源.....	21
3.11 Switching Characteristics LM2903B - Q1.....	8	6.4 Trademarks.....	21
3.12 LM2903B-Q1 "T", "R" and "H" Temperature Test Options.....	8	6.5 静电放电警告.....	21
3.13 Electrical Characteristics, LM2903-Q1 and LM2903E-Q1.....	9	6.6 术语表.....	21
		7 Mechanical, Packaging, and Orderable Information..	22

1 Revision History

注：以前版本的页码可能与当前版本的页码不同

Changes from Revision K (August 2022) to Revision L (August 2023)	Page
• Added reference to Application Note.....	18
Changes from Revision J (November 2020) to Revision K (August 2022)	Page
• Added T, R and H Temp Test Options table.....	8
Changes from Revision I (June 2020) to Revision J (November 2020)	Page
• 在整个数据表中将 LM2903B-Q1 最小建议电源电压更改为 2V.....	1
• Added Operating Virtual Temp to Abs Max Table for both versions.....	5
• Updated Supply Voltage vs Supply Current graph for 2V.....	5
Changes from Revision H (January 2020) to Revision I (June 2020)	Page
• 添加了“功能安全”文本和链接.....	1
• 将 VSSOP 封装添加到“B”器件信息列表中.....	1
• Added DGK to "B" Thermal Table.....	7
• Added text to Apps Overview section for ESD.....	17
Changes from Revision G (November 2018) to Revision H (January 2020)	Page
• 向数据表中添加了 LM2903B-Q1.....	1
• 添加了“器件信息”表.....	1
• Added "B" device graphs	11
• Changed incorrect input text in Feature Description in Apps Section.....	17
Changes from Revision F (May 2018) to Revision G (November 2018)	Page
• Changed previous Q1 graphs to match new format	10
• Added LM2903E-Q1 specific graphs.....	10

2 Pin Configuration and Functions



图 2-1. D, DGK, DDF OR PW PACKAGE
Top View



Connect thermal pad directly to GND pin.

图 2-2. DSG Package
8-Pin WSON With Exposed Pad
Top View

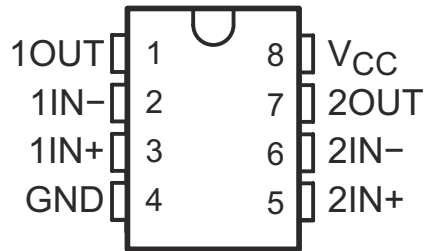
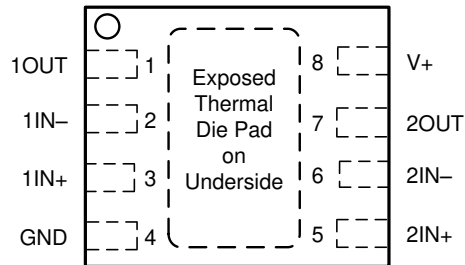
2.1 Pin Functions

NAME	PIN		I/O	DESCRIPTION
	SOIC, VSSOP, PDIP, SO, DDF and TSSOP	DSG		
1OUT	1	1	Output	Output pin of comparator 1
1IN -	2	2	Input	Negative input pin of comparator 1
1IN+	3	3	Input	Positive input pin of comparator 1
GND	4	4	—	Ground
2IN+	5	5	Input	Positive input pin of comparator 2
2IN-	6	6	Input	Negative input pin of comparator 2
2OUT	7	7	Output	Output pin of comparator 2
V _{CC}	8	8	—	Positive Supply
Thermal Pad	—	PAD	—	Connect directly to GND pin

3 Specifications

3.1 Absolute Maximum Ratings, LM2903-Q1 and LM2903E-Q1

over operating free-air temperature range (unless otherwise noted) ⁽¹⁾

		MIN	MAX	UNIT
V _{CC}	Supply voltage ⁽²⁾		36	V
V _{CC}	Supply voltage, LM2903E-Q1 Only ⁽²⁾		32	V
V _{ID}	Differential input voltage ⁽³⁾	- 36	36	V
V _I	Input voltage range (either input)	-0.3	36	V
V _O	Output voltage		36	V
I _O	Output current		20	mA
T _J	Operating virtual-junction temperature		150	°C
T _{SCG}	Duration of output short-circuit to ground		Unlimited	s

- (1) Stresses beyond those listed under *Absolute Maximum Ratings* may cause permanent damage to the device. These are stress ratings only, and functional operation of the device at these or any other conditions beyond those indicated under *Recommended Operating Conditions* is not implied. Exposure to absolute-maximum-rated conditions for extended periods may affect device reliability.
- (2) All voltage values, except differential voltages, are with respect to GND.
- (3) Differential voltages are at IN+ with respect to IN-.

3.2 Absolute Maximum Ratings, LM2903B-Q1

over operating free-air temperature range (unless otherwise noted)⁽¹⁾

		MIN	MAX	UNIT
Supply voltage: V _S = (V+) - (V-)		-0.3	38	V
Differential input voltage : V _{ID} ⁽²⁾			±38	V
Input pins (IN+, IN-)		-0.3	38	V
Current into input pins (IN+, IN-)			-50	mA
Output pin (OUT)		-0.3	38	V
Output sink current			25	mA
Operating virtual-junction temperature			150	°C
Output short-circuit duration ⁽³⁾			Unlimited	s

- (1) Stresses beyond those listed under *Absolute Maximum Ratings* may cause permanent damage to the device. These are stress ratings only, which do not imply functional operation of the device at these or any other conditions beyond those indicated under *Recommended Operating Conditions*. Exposure to absolute-maximum-rated conditions for extended periods may affect device reliability.
- (2) Differential voltages are at IN+ with respect to IN-.
- (3) Short circuits from outputs to V+ can cause excessive heating and eventual destruction.

3.3 ESD Ratings, LM2903-Q1 and LM2903E-Q1

			MIN	MAX	UNIT
T _{stg}	Storage temperature range	LM2903-Q1 Only	- 65	150	°C
V _(ESD)	Electrostatic discharge	Human body model (HBM), per AEC Q100-002 ⁽¹⁾	-1000	1000	V
		Charged device model (CDM), per AEC Q100-011	-750	750	

- (1) AEC Q100-002 indicates HBM stressing is done in accordance with the ANSI/ESDA/JEDEC JS-001 specification.

3.4 ESD Ratings, LM2903B-Q1

			MIN	MAX	UNIT
T _{stg}	Storage temperature range		- 65	150	°C
V _(ESD)	Electrostatic discharge	Human body model (HBM), per AEC Q100-002 ⁽¹⁾	-2000	2000	V
		Charged device model (CDM), per AEC Q100-011	-1000	1000	

- (1) AEC Q100-002 indicates HBM stressing is done in accordance with the ANSI/ESDA/JEDEC JS-001 specification.

3.5 Recommended Operating Conditions, LM2903B-Q1

over operating free-air temperature range (unless otherwise noted)

	MIN	MAX	UNIT
Supply voltage: $V_S = (V+) - (V-)$	2	36	V
Ambient temperature, T_A , LM2903B	-40	125	°C
Input voltage range, V_{IVR}	-0.1	(V+) - 2	V

3.6 Recommended Operating Conditions, LM2903-Q1

over operating free-air temperature range (unless otherwise noted)

	MIN	MAX	UNIT
V_{CC} (non-V devices)	2	30	V
V_{CC} (V devices)	2	32	V
T_J Junction Temperature	-40	125	°C

3.7 Recommended Operating Conditions, LM2903E-Q1

over operating free-air temperature range (unless otherwise noted)

	MIN	MAX	UNIT
V_{CC}	2	30	V
T_J Junction Temperature	-40	150	°C

3.8 Thermal Information, LM2903-Q1 and LM2903E-Q1

THERMAL METRIC ⁽¹⁾	LM2903E-Q1	LM2903-Q1			UNIT
	PW (TSSOP)	DGK (VSSOP)	PW (TSSOP)	D (SOIC)	
	8 PINS	8 PINS	8 PINS	8 PINS	
$R_{\theta JA}$ Junction-to-ambient thermal resistance	178.9	199.4	186.6	126.0	°C/W
$R_{\theta JC(top)}$ Junction-to-case (top) thermal resistance	70.7	120.8	79.6	74.2	
$R_{\theta JB}$ Junction-to-board thermal resistance	108.9	90.2	116.5	66.4	
ψ_{JT} Junction-to-top characterization parameter	11.9	21.5	17.7	25.4	
ψ_{JB} Junction-to-board characterization parameter	107.3	119.1	114.9	65.9	

(1) For more information about traditional and new thermal metrics, see the [Semiconductor and IC Package Thermal Metrics](#) application report.

3.9 Thermal Information, LM2903B-Q1

THERMAL METRIC ⁽¹⁾	LM2903B-Q1					UNIT
	D (SOIC)	DGK (VSSOP)	PW (TSSOP)	DSG (WSON)	DDF (SOT-23)	
	8 PINS	8 PINS	8 PINS	8 PINS	8 PINS	
$R_{\theta JA}$ Junction-to-ambient thermal resistance	148.5	193.7	200.6	96.9	197.9	°C/W
$R_{\theta JC(top)}$ Junction-to-case (top) thermal resistance	90.2	82.9	89.6	119.0	119.2	
$R_{\theta JB}$ Junction-to-board thermal resistance	91.8	115.5	131.3	63.1	115.4	
ψ_{JT} Junction-to-top characterization parameter	38.5	20.8	22.1	12.4	19.4	
ψ_{JB} Junction-to-board characterization parameter	91.1	113.9	129.6	63.0	113.7	
$R_{\theta JC(bot)}$ Junction-to-case (bottom) thermal resistance	-	-	-	38.7	-	

- (1) For more information about traditional and new thermal metrics, see the [Semiconductor and IC Package Thermal Metrics](#) application report.

3.10 Electrical Characteristics LM2903B - Q1

$V_S = 5\text{ V}$, $V_{CM} = (V^-)$; $T_A = 25^\circ\text{C}$ (unless otherwise noted).

PARAMETER		TEST CONDITIONS	MIN	TYP	MAX	UNIT
V_{IO}	Input offset voltage	$V_S = 5$ to 36V	- 2.5	± 0.37	2.5	mV
		$V_S = 5$ to 36V, $T_A = -40^\circ\text{C}$ to $+125^\circ\text{C}$	- 4		4	mV
V_{IO}	Input offset voltage, DGK package only	$V_S = 5$ to 36V	- 3.5	± 0.37	3.5	mV
		$V_S = 5$ to 36V, $T_A = -40^\circ\text{C}$ to $+125^\circ\text{C}$	- 5		5	mV
I_B	Input bias current			- 3.5	- 25	nA
		$T_A = -40^\circ\text{C}$ to $+125^\circ\text{C}$			- 50	nA
I_{OS}	Input offset current		- 10	± 0.5	10	nA
		$T_A = -40^\circ\text{C}$ to $+125^\circ\text{C}$	- 25		25	nA
V_{CM}	Common mode range ⁽¹⁾	$V_S = 3$ to 36V	(V ⁻)	(V ⁺) - 1.5		V
		$V_S = 3$ to 36V, $T_A = -40^\circ\text{C}$ to $+125^\circ\text{C}$	(V ⁻)	(V ⁺) - 2.0		V
A_{VD}	Large signal differential voltage amplification	$V_S = 15\text{V}$, $V_O = 1.4\text{V}$ to 11.4V ; $R_L \geq 15\text{k}$ to (V ⁺)	50	200		V/mV
V_{OL}	Low level output Voltage {swing from (V ⁻)}	$I_{SINK} \leq 4\text{mA}$, $V_{ID} = -1\text{V}$		110	400	mV
		$I_{SINK} \leq 4\text{mA}$, $V_{ID} = -1\text{V}$ $T_A = -40^\circ\text{C}$ to $+125^\circ\text{C}$			550	mV
I_{OH-LKG}	High-level output leakage current	(V ⁺) = $V_O = 5\text{V}$; $V_{ID} = 1\text{V}$		0.1	20	nA
		(V ⁺) = $V_O = 36\text{V}$; $V_{ID} = 1\text{V}$		0.3	50	nA
I_{OL}	Low level output current	$V_{OL} = 1.5\text{V}$; $V_{ID} = -1\text{V}$; $V_S = 5\text{V}$	6	21		mA
I_Q	Quiescent current (all comparators)	$V_S = 5\text{V}$, no load		400	600	μA
		$V_S = 36\text{V}$, no load, $T_A = -40^\circ\text{C}$ to $+125^\circ\text{C}$		550	800	μA

- (1) The voltage at any input should not be allowed to go negative by more than 0.3 V. The upper end of the input voltage range is $V_{CC} - 1.5\text{V}$ for one input, and the other input can exceed the V_{CC} level; the comparator provides a proper output state. Either or both inputs can go to 36 V without damage.

3.11 Switching Characteristics LM2903B - Q1

$V_S = 5\text{V}$, $V_{O_PULLUP} = 5\text{V}$, $V_{CM} = V_S/2$, $C_L = 15\text{pF}$, $R_L = 5.1\text{k}\Omega$, $T_A = 25^\circ\text{C}$ (unless otherwise noted).

PARAMETER		TEST CONDITIONS	MIN	TYP	MAX	UNIT
t_{response}	Propagation delay time, high-to-low; TTL input signal ⁽¹⁾	TTL input with $V_{\text{ref}} = 1.4\text{V}$		300		ns
t_{response}	Propagation delay time, high-to-low; Small scale input signal ⁽¹⁾	Input overdrive = 5mV, Input step = 100mV		1000		ns

- (1) High-to-low and low-to-high refers to the transition at the input.

3.12 LM2903B-Q1 "T", "R" and "H" Temperature Test Options

The following table describes the production temperature testing for the LM2903B-Q1 "H", "R" and "T" options. Specifications are the same as the LM2903B-Q1 above.

Test	LM2903B-Q1	LM2903BR-Q1	LM2903BH-Q1	LM2903BT-Q1
Probe (Wafer)	-	25°C	125°C	-40°C and 125°C
Final (Packaged)	25°C	25°C	25°C	25°C

3.13 Electrical Characteristics, LM2903-Q1 and LM2903E-Q1

at specified free-air temperature, $V_{CC} = 5\text{ V}$ (unless otherwise noted)

PARAMETER	TEST CONDITIONS		T_A ⁽¹⁾	MIN	TYP	MAX	UNIT	
V_{IO} Input offset voltage	$V_O = 1.4\text{ V}$, $V_{IC} = V_{IC(min)}$, $V_{CC} = 5\text{ V to MAX}^{(2)}$	Non-A devices	25°C	2	7		mV	
			Full range			15		
		A-suffix devices	25°C		1	2		
			Full range					4
I_{IO} Input offset current	$V_O = 1.4\text{ V}$		25°C		5	50	nA	
			Full range			200		
I_{IB} Input bias current	$V_O = 1.4\text{ V}$		25°C	-25	-250		nA	
			Full range			-500		
V_{ICR} Common-mode input voltage range ⁽³⁾			25°C	0 to $V_{CC}-1.5$			V	
			Full range	0 to $V_{CC}-2$				
A_{VD} Large-signal differential-voltage amplification	$V_{CC} = 15\text{ V}$, $V_O = 1.4\text{ V to }11.4\text{ V}$, $R_L \geq 15\text{ k}\Omega\text{ to }V_{CC}$		25°C	25	100		V/mV	
I_{OH} High-level output current	$V_{OH} = 5\text{ V}$ $V_{OH} = V_{CC}\text{ MAX}^{(2)}$	$V_{ID} = 1\text{ V}$	25°C		0.1	50	nA	
			Full range				1	μA
V_{OL} Low-level output voltage	$I_{OL} = 4\text{ mA}$,	$V_{ID} = -1\text{ V}$	25°C		150	400	mV	
			Full range			700		
I_{OL} Low-level output current	$V_{OL} = 1.5\text{ V}$,	$V_{ID} = -1\text{ V}$	25°C	6			mA	
I_{CC} Supply current	$R_L = \infty$		25°C		0.8	1	mA	
			Full range			2.5		

- (1) Full range (MIN or MAX) for LM2903-Q1 is -40°C to 125°C and -40°C to 150°C for the LM2903E-Q1. All characteristics are measured with zero common-mode input voltage, unless otherwise specified.
- (2) $V_{CC}\text{ MAX} = 30\text{ V}$ for non-V devices and 32 V for V-suffix devices.
- (3) The voltage at either input or common-mode should not be allowed to go negative by more than 0.3 V . The upper end of the common-mode voltage range is $V_{CC} + 1.5\text{ V}$ for the inverting input (-), and the non-inverting input (+) can exceed the V_{CC} level; the comparator provides a proper output state. Either or both inputs can go to 30 V (32 V for V-suffix devices) without damage.

3.14 Switching Characteristics, LM2903-Q1 and LM2903E-Q1

$V_{CC} = 5\text{ V}$, $T_A = 25^\circ\text{C}$

PARAMETER	TEST CONDITIONS		TYP	UNIT
Response time	R_L connected to 5 V through $5.1\text{ k}\Omega$,	100-mV input step with 5-mV overdrive	1.3	μs
	$C_L = 15\text{ pF}^{(1)}\text{ }^{(2)}$	TTL-level input step	0.3	

- (1) C_L includes probe and jig capacitance.
- (2) The response time specified is the interval between the input step function and the instant when the output crosses 1.4 V .

3.15 Typical Characteristics, LM2903-Q1 and LM2903E-Q1 Only



图 3-1. Supply Current vs. Supply Voltage



图 3-2. Supply Current vs. Supply Voltage LM2903E-Q1 Only

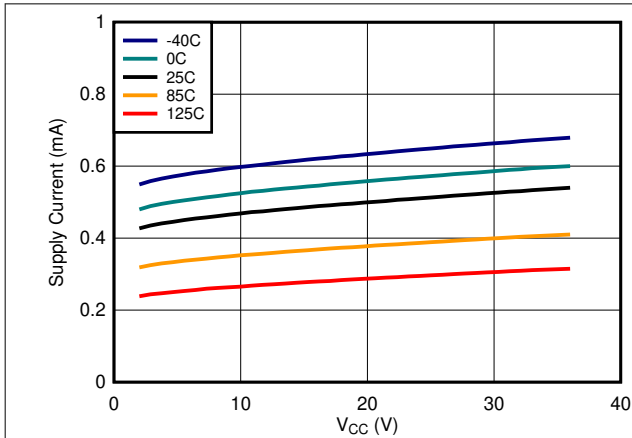

图 3-3. Input Bias Current vs. Supply Voltage

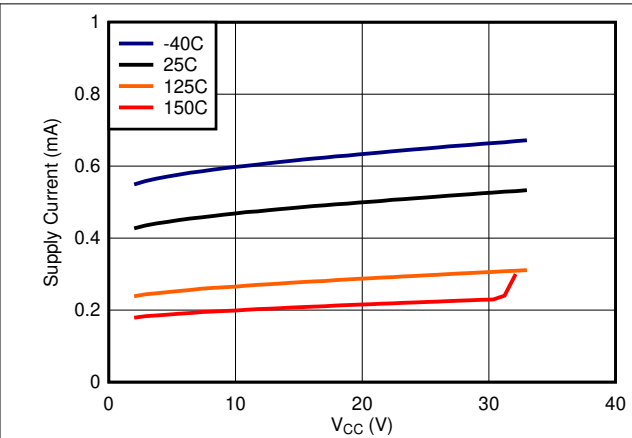

图 3-4. Input Bias Current vs. Supply Voltage LM2903E-Q1 Only

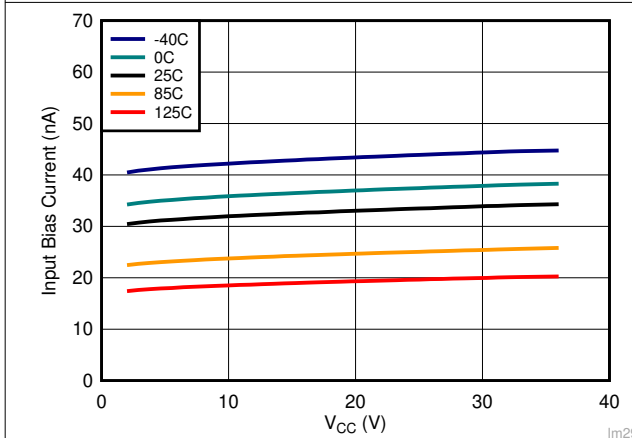

图 3-5. Output Low Voltage vs. Output Current

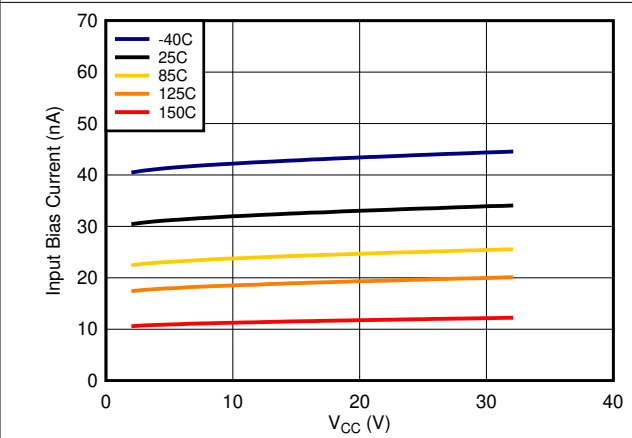

图 3-6. Output Low Voltage vs. Output Current LM2903E-Q1 Only

3.16 Typical Characteristics, LM2903B-Q1 Only

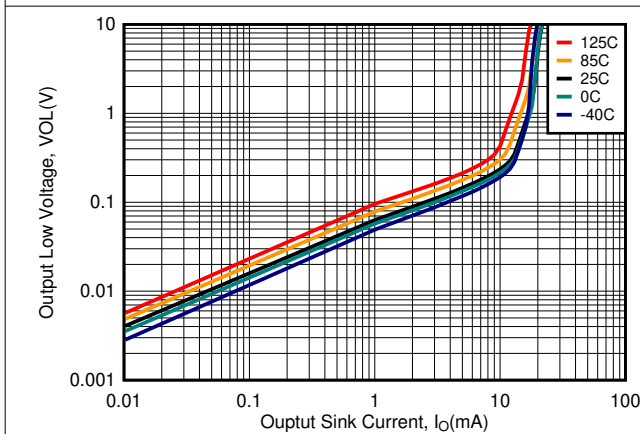
$T_A = 25^\circ\text{C}$, $V_S = 5\text{ V}$, $R_{\text{PULLUP}} = 5.1\text{ k}$, $C_L = 15\text{ pF}$, $V_{\text{CM}} = 0\text{ V}$, $V_{\text{UNDERDRIVE}} = 100\text{ mV}$, $V_{\text{OVERDRIVE}} = 100\text{ mV}$ unless otherwise noted.

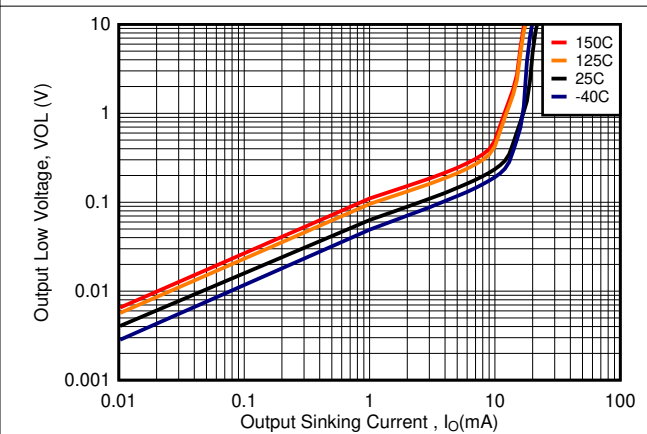

图 3-7. Total Supply Current vs. Supply Voltage



图 3-8. Total Supply Current vs. Input Voltage at 3V

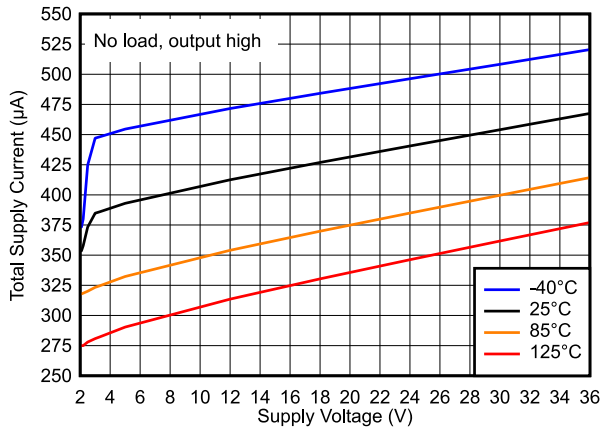

图 3-9. Total Supply Current vs. Input Voltage at 3.3V

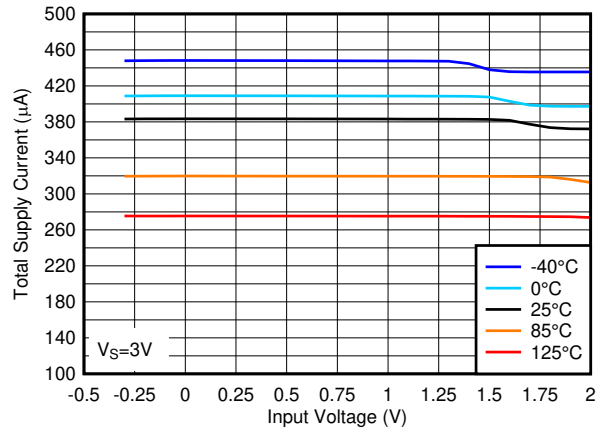

图 3-10. Total Supply Current vs. Input Voltage at 5V

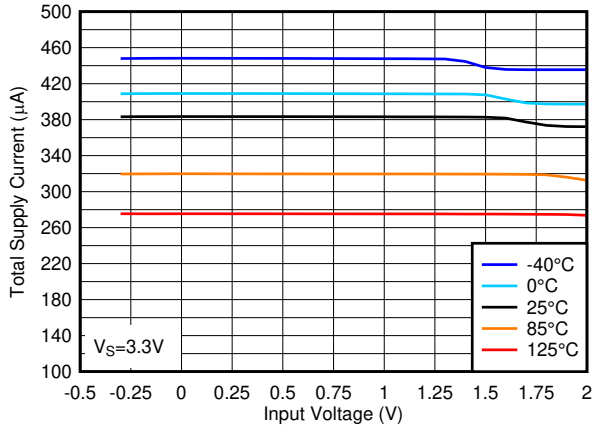

图 3-11. Total Supply Current vs. Input Voltage at 12V

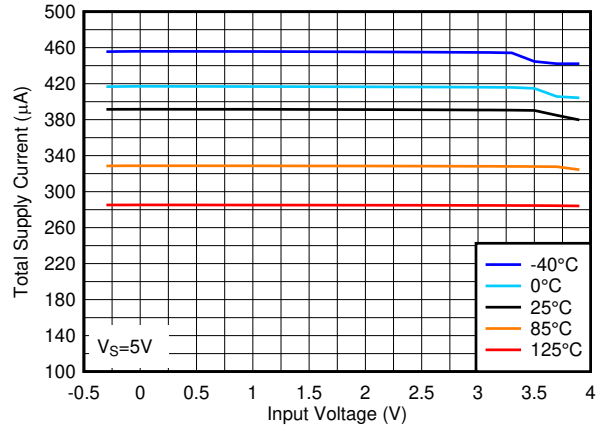

图 3-12. Total Supply Current vs. Input Voltage at 36V

3.16 Typical Characteristics, LM2903B-Q1 Only (continued)

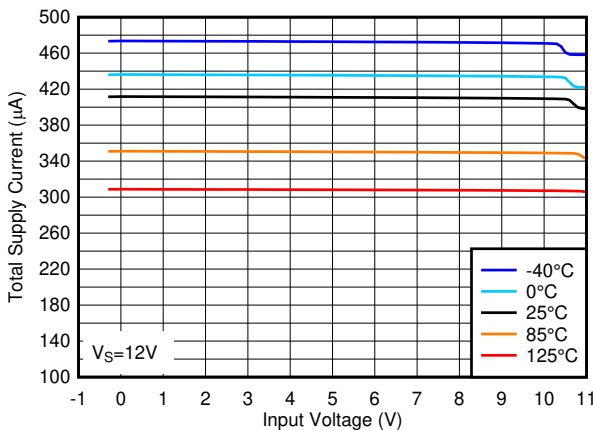
$T_A = 25^\circ\text{C}$, $V_S = 5\text{ V}$, $R_{\text{PULLUP}} = 5.1\text{ k}$, $C_L = 15\text{ pF}$, $V_{\text{CM}} = 0\text{ V}$, $V_{\text{UNDERDRIVE}} = 100\text{ mV}$, $V_{\text{OVERDRIVE}} = 100\text{ mV}$ unless otherwise noted.

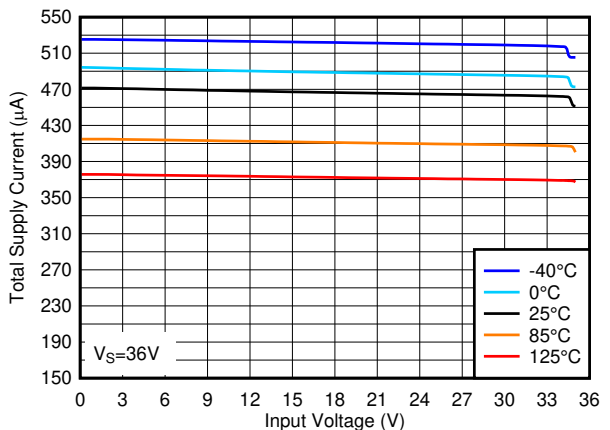

图 3-13. Input Offset Voltage vs. Temperature at 3V



图 3-14. Input Offset Voltage vs. Temperature at 5V

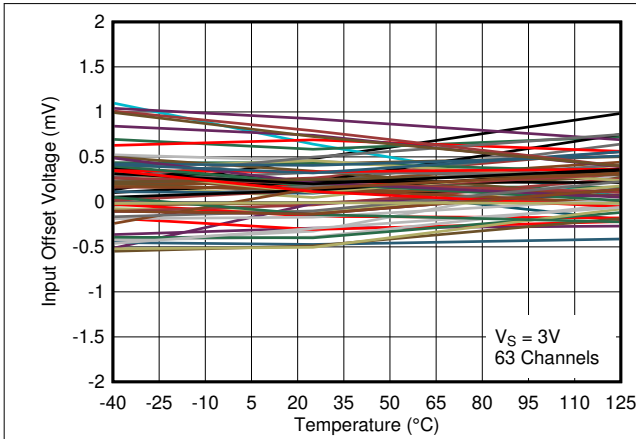

图 3-15. Input Offset Voltage vs. Temperature at 12V

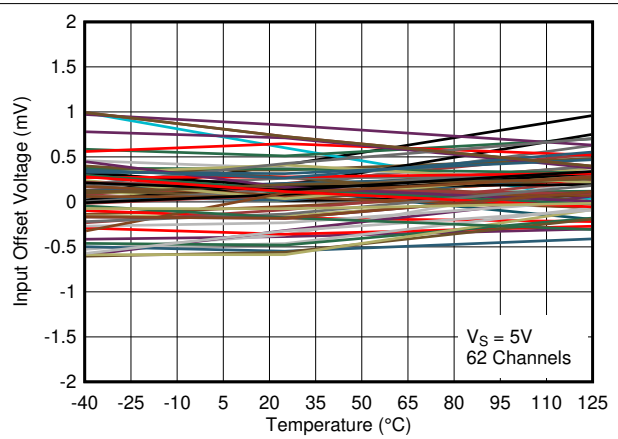

图 3-16. Input Offset Voltage vs. Temperature at 36V

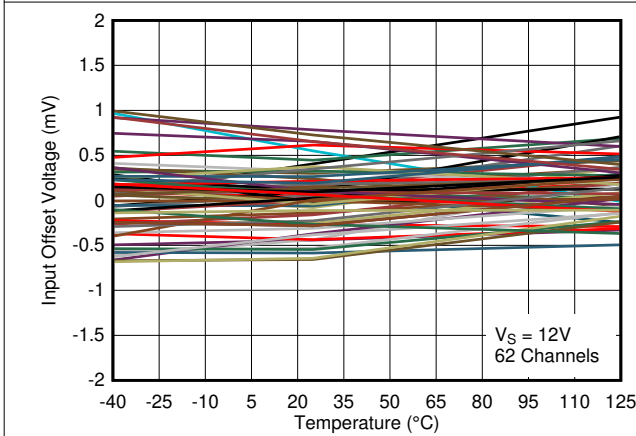

图 3-17. Input Offset Voltage vs. Supply Voltage at -40°C

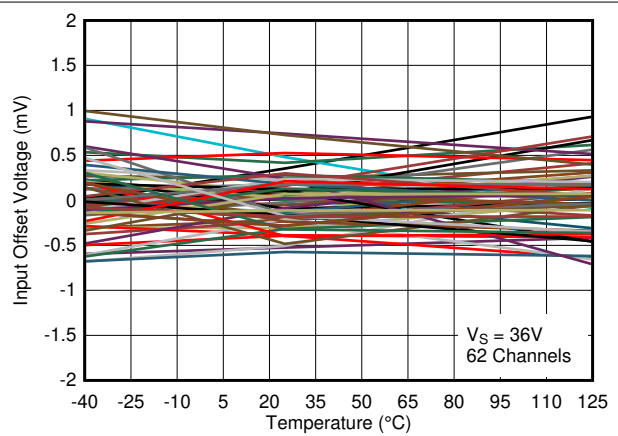

图 3-18. Input Offset Voltage vs. Supply Voltage at 25°C

3.16 Typical Characteristics, LM2903B-Q1 Only (continued)

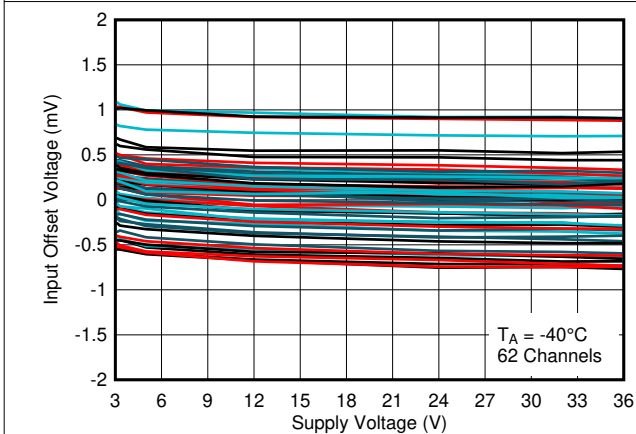
$T_A = 25^\circ\text{C}$, $V_S = 5\text{ V}$, $R_{\text{PULLUP}} = 5.1\text{ k}$, $C_L = 15\text{ pF}$, $V_{\text{CM}} = 0\text{ V}$, $V_{\text{UNDERDRIVE}} = 100\text{ mV}$, $V_{\text{OVERDRIVE}} = 100\text{ mV}$ unless otherwise noted.

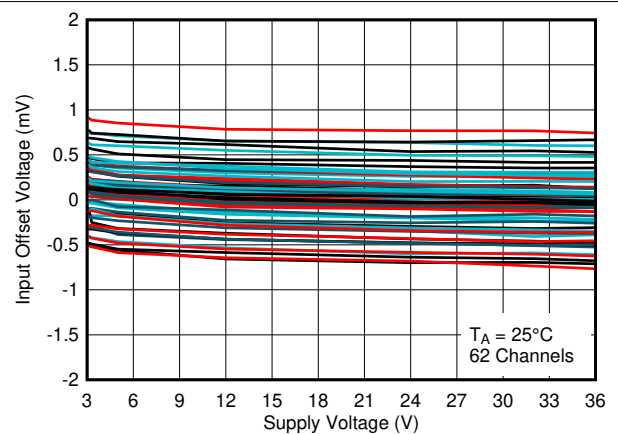

图 3-19. Input Offset Voltage vs. Supply Voltage at 85°C



图 3-20. Input Offset Voltage vs. Supply Voltage at 125°C

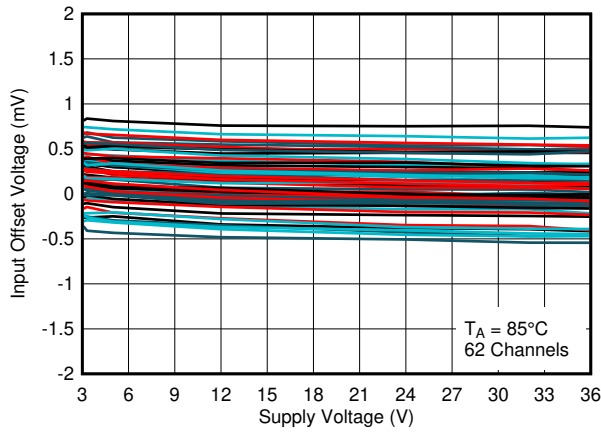

图 3-21. Input Bias Current vs. Supply Voltage

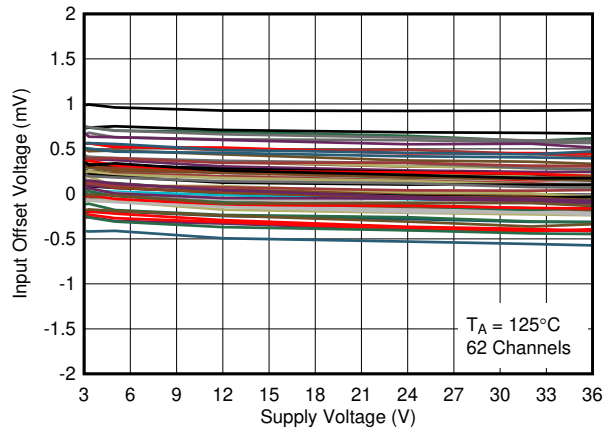

图 3-22. Input Bias Current vs. Input Voltage at 5V

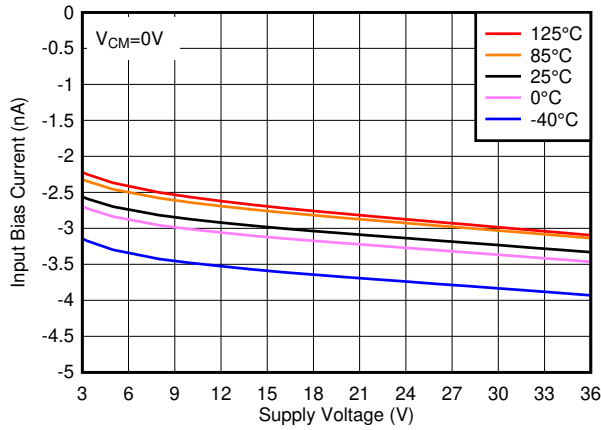

图 3-23. Input Bias Current vs. Input Voltage at 12V

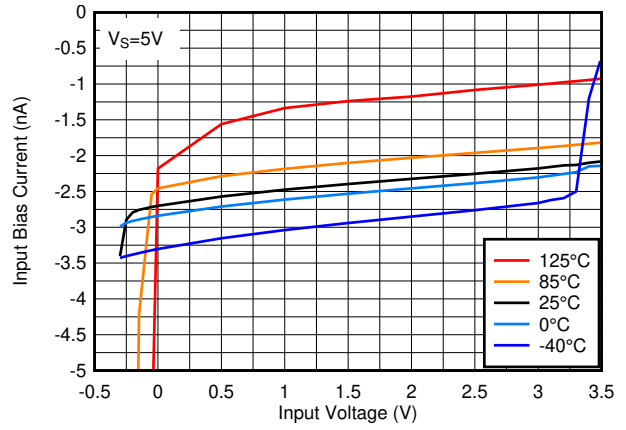

图 3-24. Input Bias Current vs. Input Voltage at 36V

3.16 Typical Characteristics, LM2903B-Q1 Only (continued)

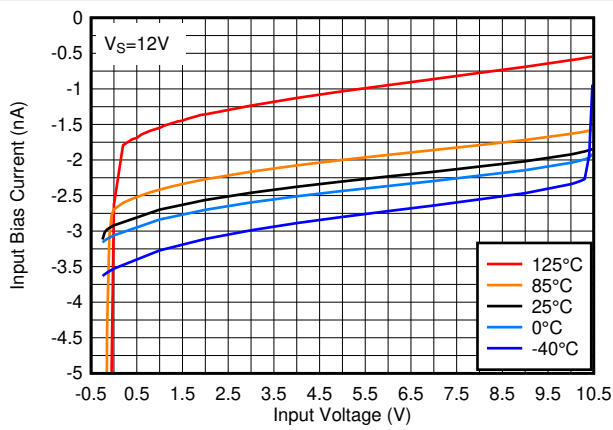
$T_A = 25^\circ\text{C}$, $V_S = 5\text{ V}$, $R_{\text{PULLUP}} = 5.1\text{k}$, $C_L = 15\text{ pF}$, $V_{\text{CM}} = 0\text{ V}$, $V_{\text{UNDERDRIVE}} = 100\text{ mV}$, $V_{\text{OVERDRIVE}} = 100\text{ mV}$ unless otherwise noted.

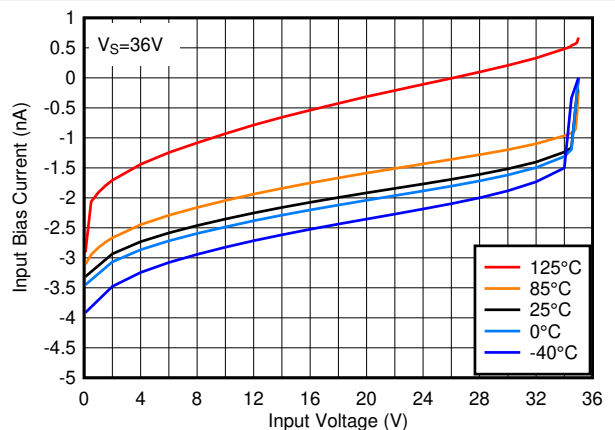

图 3-25. Output Low Voltage vs. Output Sinking Current at 3V



图 3-26. Output Low Voltage vs. Output Sinking Current at 5V

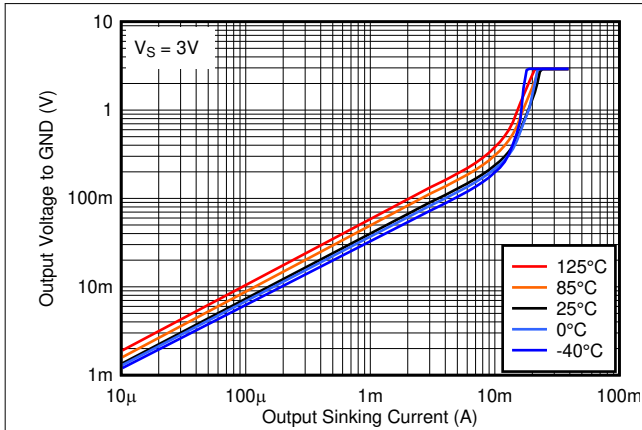

图 3-27. Output Low Voltage vs. Output Sinking Current at 12V

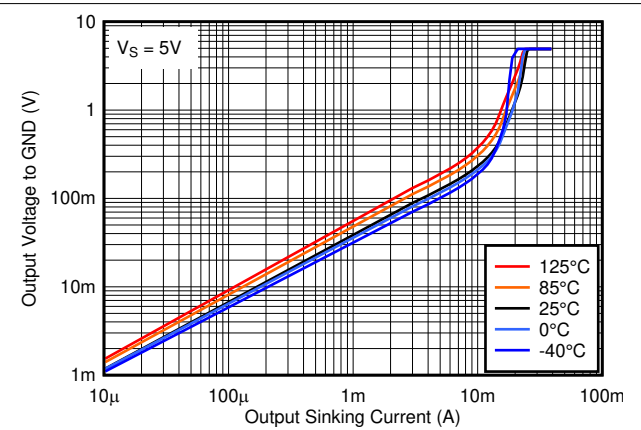

图 3-28. Output Low Voltage vs. Output Sinking Current at 36V

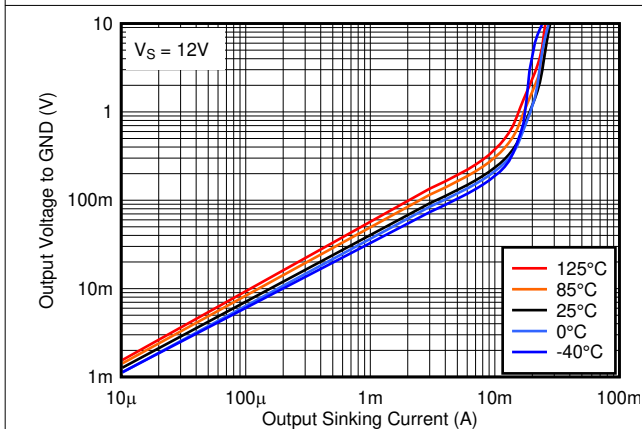

图 3-29. Output High Leakage Current vs. Temperature at 5V

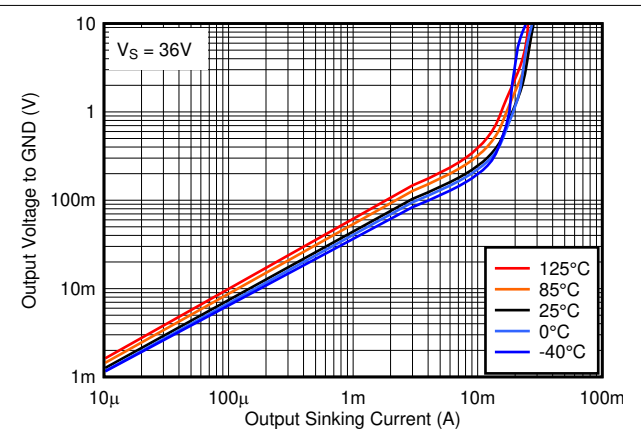

图 3-30. Output High Leakage Current vs. Temperature at 36V

3.16 Typical Characteristics, LM2903B-Q1 Only (continued)

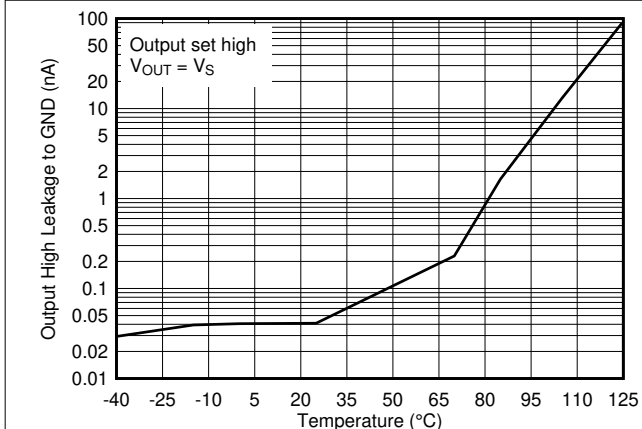
$T_A = 25^\circ\text{C}$, $V_S = 5\text{ V}$, $R_{\text{PULLUP}} = 5.1\text{ k}$, $C_L = 15\text{ pF}$, $V_{\text{CM}} = 0\text{ V}$, $V_{\text{UNDERDRIVE}} = 100\text{ mV}$, $V_{\text{OVERDRIVE}} = 100\text{ mV}$ unless otherwise noted.

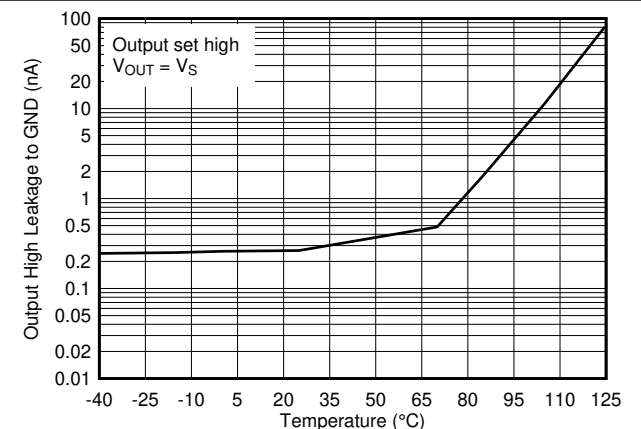
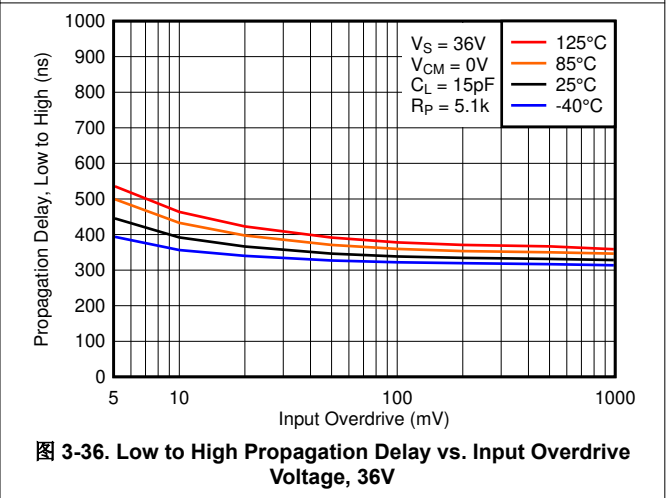
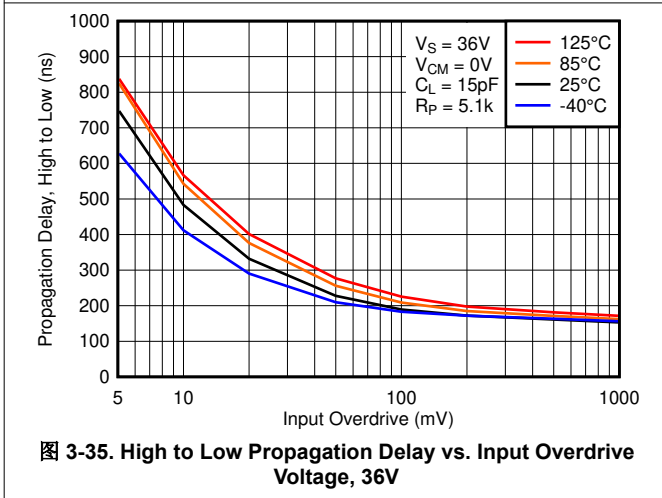
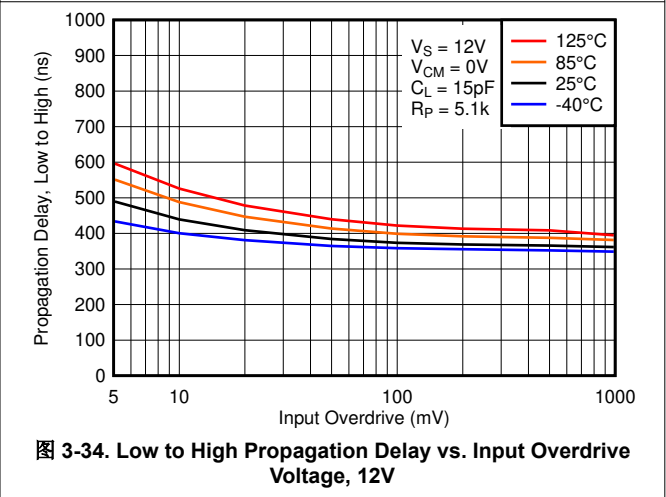
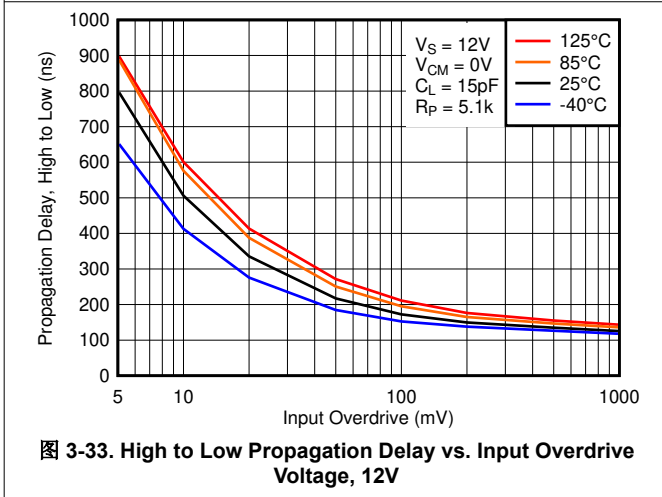
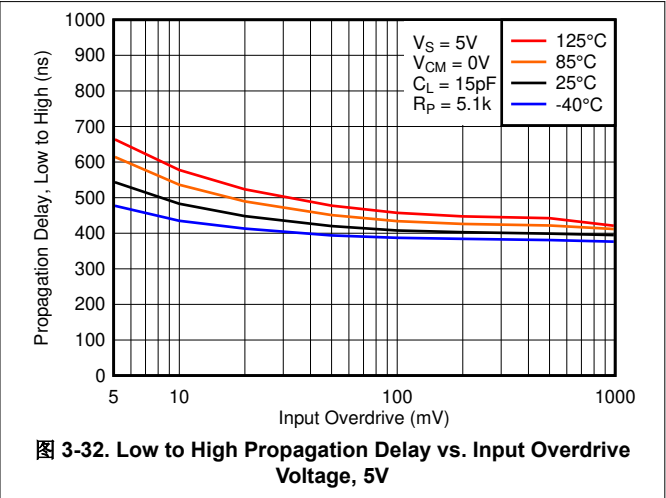
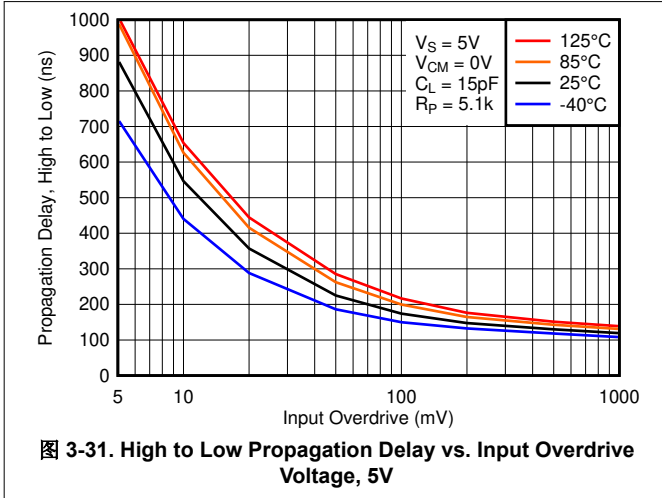

3.16 Typical Characteristics, LM2903B-Q1 Only (continued)

$T_A = 25^\circ\text{C}$, $V_S = 5\text{ V}$, $R_{\text{PULLUP}} = 5.1\text{ k}$, $C_L = 15\text{ pF}$, $V_{\text{CM}} = 0\text{ V}$, $V_{\text{UNDERDRIVE}} = 100\text{ mV}$, $V_{\text{OVERDRIVE}} = 100\text{ mV}$ unless otherwise noted.



图 3-37. Response Time for Various Overdrives, High-to-Low Transition



图 3-38. Response Time for Various Overdrives, Low-to-High Transition

4 Detailed Description

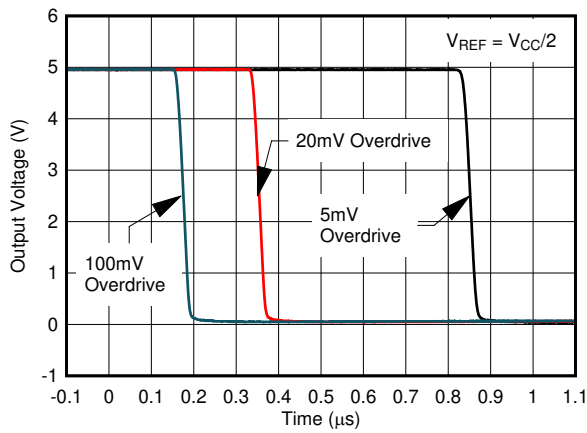
4.1 Overview

The LM2903-Q1 family is a dual comparator with the ability to operate up to 36 V on the supply pin. This standard device has proven ubiquity and versatility across a wide range of applications. This is due to its very wide supply voltages range (2 V to 36 V), low I_q and fast response.

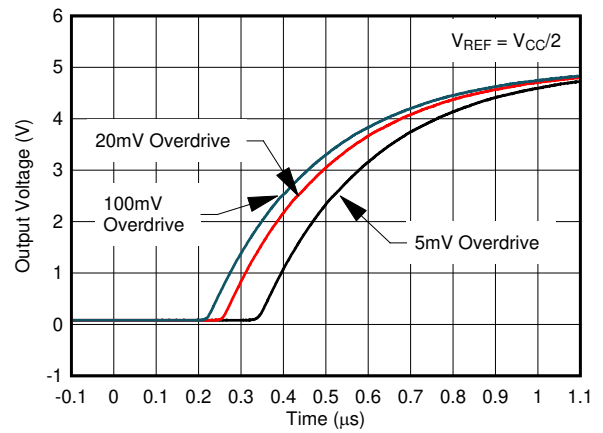
This device is AEC-Q100 qualified and can operate over a wide temperature range of -40°C to 125°C (LM2903-Q1 and LM2903B-Q1) or -40°C to 150°C (LM2903E-Q1).

The open-drain output allows the user to configure the output's logic low voltage (V_{OL}) and can be utilized to enable the comparator to be used in AND functionality.

The "B" versions add dedicated ESD protections on all the pins for improved ESD performance as well as improved negative input voltage handling. Please see Application Note [SNOAA35](#) for more information

4.2 Functional Block Diagram



图 4-1. Schematic (Each Comparator)

4.3 Feature Description

LM2903-Q1 family consists of a PNP darlington pair input, allowing the device to operate with very high gain and fast response with minimal input bias current. The input Darlington pair creates a limit on the input common mode voltage capability, allowing LM2903-Q1 to accurately function from ground to $V_{CC} - 1.5\text{V}$ differential input. This enables much head room for modern day supplies of 3.3 V and 5.0 V.

The output consists of an open drain NPN (pull-down or low side) transistor. The output NPN will sink current when the negative input voltage is higher than the positive input voltage and the offset voltage. The V_{OL} is resistive and will scale with the output current. Please see [图 3-3](#) in the [节 3.15](#) section for V_{OL} values with respect to the output current.

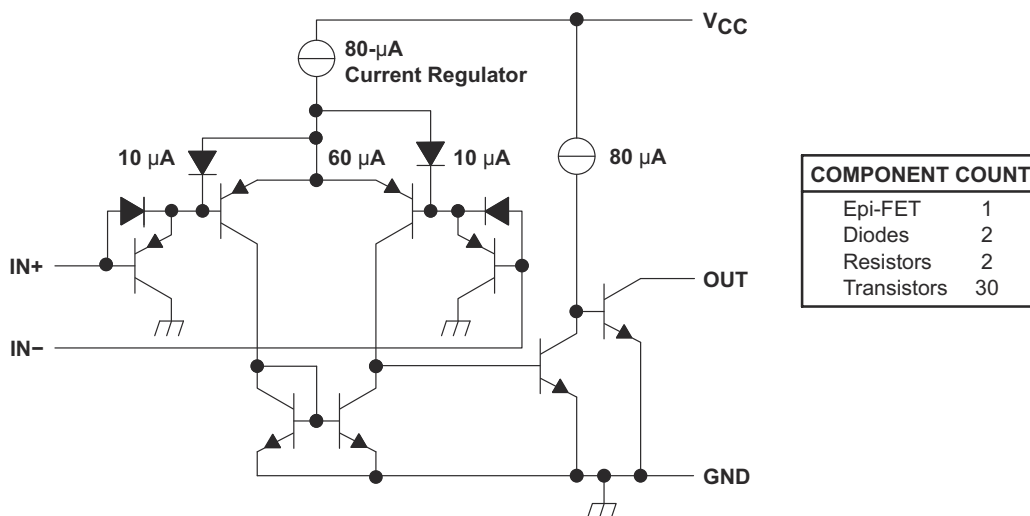
4.4 Device Functional Modes

4.4.1 Voltage Comparison

The LM2903-Q1 family operates solely as a voltage comparator, comparing the differential voltage between the positive and negative pins and outputting a logic low or high impedance (logic high with pull-up) based on the input differential polarity.

5 Application and Implementation

备注

以下应用部分中的信息不属于 TI 器件规格的范围，TI 不担保其准确性和完整性。TI 的客户应负责确定器件是否适用于其应用。客户应验证并测试其设计，以确保系统功能。

5.1 Application Information

LM2903-Q1 will typically be used to compare a single signal to a reference or two signals against each other. Many users take advantage of the open drain output to drive the comparison logic output to a logic voltage level to an MCU or logic device. The wide supply range and high voltage capability makes LM2903Q1 optimal for level shifting to a higher or lower voltage.

5.2 Typical Application



图 5-1. Single-ended and Differential Comparator Configurations

5.2.1 Design Requirements

For this design example, use the parameters listed in 表 5-1 as the input parameters.

表 5-1. Design Parameters

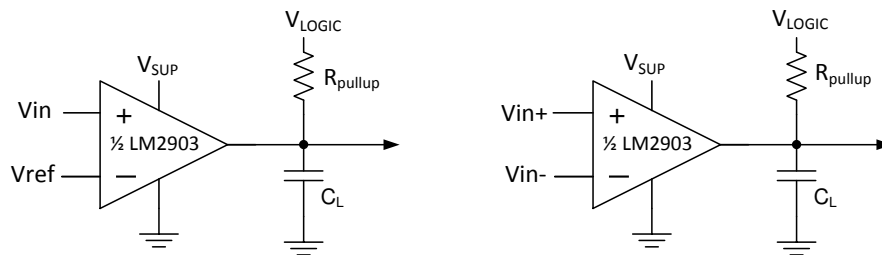
DESIGN PARAMETER	EXAMPLE VALUE
Input Voltage Range	0 V to $V_{SUP}-1.5$ V
Supply Voltage	2 V to 36 V
Logic Supply Voltage	2 V to 36 V
Output Current (R_{PULLUP})	1 μ A to 20 mA
Input Overdrive Voltage	100 mV
Reference Voltage	2.5 V
Load Capacitance (C_L)	15 pF

5.2.2 Detailed Design Procedure

When using LM2903-Q1 family in a general comparator application, determine the following:

- Input Voltage Range
- Minimum Overdrive Voltage
- Output and Drive Current
- Response Time

5.2.2.1 Input Voltage Range

When choosing the input voltage range, the input common mode voltage range (V_{ICR}) must be taken in to account. If temperature operation is above or below 25°C the V_{ICR} can range from 0 V to $V_{CC} - 2.0$ V. This limits the input voltage range to as high as $V_{CC} - 2.0$ V and as low as 0 V. Operation outside of this range can yield incorrect comparisons.

Below is a list of input voltage situation and their outcomes:

1. When both IN- and IN+ are both within the common mode range:
 - a. If IN- is higher than IN+ and the offset voltage, the output is low and the output transistor is sinking current
 - b. If IN- is lower than IN+ and the offset voltage, the output is high impedance and the output transistor is not conducting
2. When IN- is higher than common mode and IN+ is within common mode, the output is low and the output transistor is sinking current
3. When IN+ is higher than common mode and IN- is within common mode, the output is high impedance and the output transistor is not conducting
4. When IN- and IN+ are both higher than common mode, see Section 2 of [Application Design Guidelines for LM339, LM393, TL331 Family Comparators Including the New B-versions](#)

5.2.2.2 Minimum Overdrive Voltage

Overdrive Voltage is the differential voltage produced between the positive and negative inputs of the comparator over the offset voltage (V_{IO}). In order to make an accurate comparison the Overdrive Voltage (V_{OD}) should be higher than the input offset voltage (V_{IO}). Overdrive voltage can also determine the response time of the comparator, with the response time decreasing with increasing overdrive. [图 5-2](#) and [图 5-3](#) show positive and negative response times with respect to overdrive voltage.

5.2.2.3 Output and Drive Current

Output current is determined by the load/pull-up resistance and logic/pull-up voltage. The output current will produce a output low voltage (V_{OL}) from the comparator. In which V_{OL} is proportional to the output current. Use [图 3-5](#) to determine V_{OL} based on the output current.

The output current can also effect the transient response. More will be explained in the next section.

5.2.2.4 Response Time

The transient response can be determined by the load capacitance (C_L), load/pull-up resistance (R_{PULLUP}) and equivalent collector-emitter resistance (R_{CE}).

- The positive response time (τ_p) is approximately $\tau_p \sim R_{PULLUP} \times C_L$
- The negative response time (τ_n) is approximately $\tau_n \sim R_{CE} \times C_L$
 - R_{CE} can be determine by taking the slope of [图 3-5](#) in it's linear region at the desired temperature, or by dividing the V_{OL} by I_{out}

5.2.3 Application Curves

The following curves were generated with 5 V on V_{CC} and V_{Logic} , $R_{PULLUP} = 5.1 \text{ k}\Omega$, and 50 pF scope probe.



图 5-2. Response Time for Various Overdrives (Positive Transition)



图 5-3. Response Time for Various Overdrives (Negative Transition)

5.3 Power Supply Recommendations

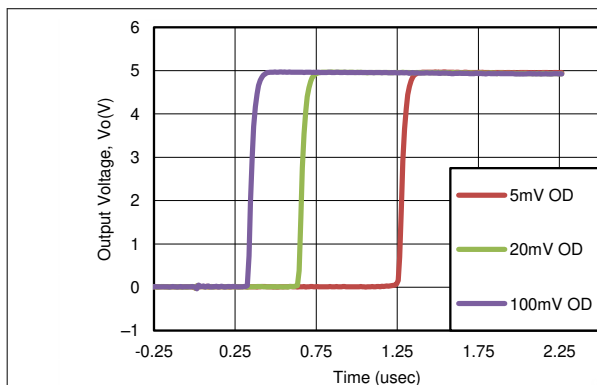
For fast response and comparison applications with noisy or AC inputs, it is recommended to use a bypass capacitor on the supply pin to reject any variation on the supply voltage. This variation can eat into the comparator's input common mode range and create an inaccurate comparison.

5.4 Layout

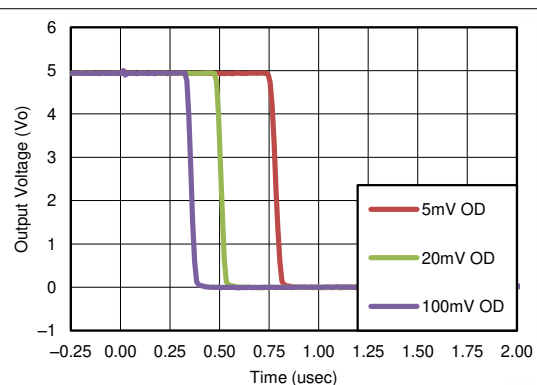
5.4.1 Layout Guidelines

For accurate comparator applications without hysteresis it is important maintain a stable power supply with minimized noise and glitches, which can affect the high level input common mode voltage range. In order to achieve this, it is best to add a bypass capacitor between the supply voltage and ground. This should be implemented on the positive power supply and negative supply (if available). If a negative supply is not being used, do not put a capacitor between the IC's GND pin and system ground.

5.4.2 Layout Example



图 5-4. LM2903Q1 Layout Example

6 Device and Documentation Support

6.1 Documentation Support

6.1.1 Related Documentation

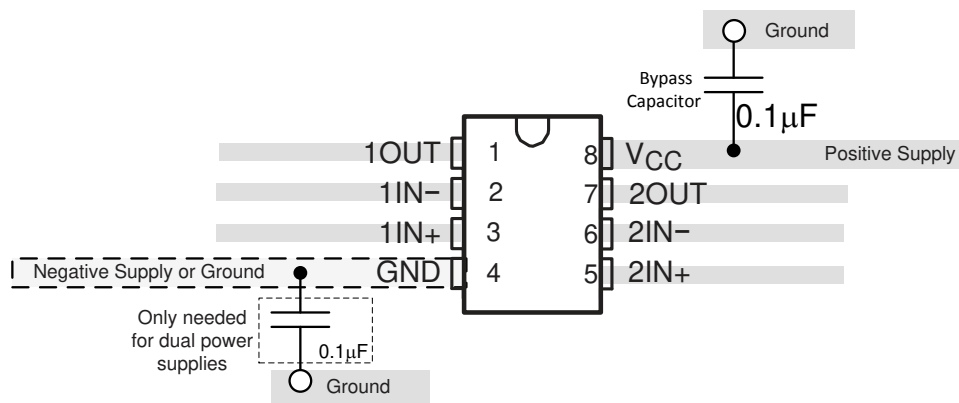
[LM2903B-Q1 Functional Safety FIT Rate, FMD and Pin FMA](#) - SLCA005

[Application Design Guidelines for LM339, LM393, TL331 Family Comparators](#) - SNOAA35

[Analog Engineers Circuit Cookbook: Amplifiers \(See Comparators section\)](#) - SLYY137

6.2 Receiving Notification of Documentation Updates

To receive notification of documentation updates, navigate to the device product folder on ti.com. In the upper right corner, click on *Alert me* to register and receive a weekly digest of any product information that has changed. For change details, review the revision history included in any revised document.

6.3 支持资源

TI E2E™ 支持论坛是工程师的重要参考资料，可直接从专家获得快速、经过验证的解答和设计帮助。搜索现有解答或提出自己的问题可获得所需的快速设计帮助。

链接的内容由各个贡献者“按原样”提供。这些内容并不构成 TI 技术规范，并且不一定反映 TI 的观点；请参阅 TI 的《使用条款》。

6.4 Trademarks

TI E2E™ is a trademark of Texas Instruments.

所有商标均为其各自所有者的财产。

6.5 静电放电警告



静电放电 (ESD) 会损坏这个集成电路。德州仪器 (TI) 建议通过适当的预防措施处理所有集成电路。如果不遵守正确的处理和安装程序，可能会损坏集成电路。

ESD 的损坏小至导致微小的性能降级，大至整个器件故障。精密的集成电路可能更容易受到损坏，这是因为非常细微的参数更改都可能会导致器件与其发布的规格不相符。

6.6 术语表

TI 术语表 本术语表列出并解释了术语、首字母缩略词和定义。

7 Mechanical, Packaging, and Orderable Information

The following pages include mechanical, packaging, and orderable information. This information is the most current data available for the designated devices. This data is subject to change without notice and revision of this document. For browser-based versions of this data sheet, refer to the left-hand navigation.

PACKAGING INFORMATION

Orderable Device	Status (1)	Package Type	Package Drawing	Pins	Package Qty	Eco Plan (2)	Lead finish/ Ball material (6)	MSL Peak Temp (3)	Op Temp (°C)	Device Marking (4/5)	Samples
LM2903AVQDRG4Q1	ACTIVE	SOIC	D	8	2500	RoHS & Green	NIPDAU	Level-1-260C-UNLIM	-40 to 125	2903AVQ	Samples
LM2903AVQDRQ1	ACTIVE	SOIC	D	8	2500	RoHS & Green	NIPDAU	Level-1-260C-UNLIM	-40 to 125	2903AVQ	Samples
LM2903AVQPWRG4Q1	ACTIVE	TSSOP	PW	8	2000	RoHS & Green	NIPDAU	Level-1-260C-UNLIM	-40 to 125	2903AVQ	Samples
LM2903AVQPWRQ1	ACTIVE	TSSOP	PW	8	2000	RoHS & Green	NIPDAU	Level-1-260C-UNLIM	-40 to 125	2903AVQ	Samples
LM2903BHQDGKRQ1	ACTIVE	VSSOP	DGK	8	2500	RoHS & Green	NIPDAU	Level-1-260C-UNLIM	-40 to 125	3BHQ	Samples
LM2903BHQDRQ1	ACTIVE	SOIC	D	8	3000	RoHS & Green	NIPDAU	Level-1-260C-UNLIM	-40 to 125	903BHQ	Samples
LM2903BHQPWRQ1	ACTIVE	TSSOP	PW	8	3000	RoHS & Green	NIPDAU	Level-1-260C-UNLIM	-40 to 125	2903BH	Samples
LM2903BQDDFRQ1	ACTIVE	SOT-23-THIN	DDF	8	3000	RoHS & Green	NIPDAU	Level-1-260C-UNLIM	-40 to 125	903BQ	Samples
LM2903BQDGKRQ1	ACTIVE	VSSOP	DGK	8	2500	RoHS & Green	NIPDAU	Level-1-260C-UNLIM	-40 to 125	03BQ	Samples
LM2903BQDRQ1	ACTIVE	SOIC	D	8	2500	RoHS & Green	NIPDAU	Level-1-260C-UNLIM	-40 to 125	2903BQ	Samples
LM2903BQPWRQ1	ACTIVE	TSSOP	PW	8	2000	RoHS & Green	NIPDAU	Level-1-260C-UNLIM	-40 to 125	2903BQ	Samples
LM2903BRQDGKRQ1	ACTIVE	VSSOP	DGK	8	2500	RoHS & Green	NIPDAU	Level-1-260C-UNLIM	-40 to 125	3BRQ	Samples
LM2903BRQDRQ1	ACTIVE	SOIC	D	8	3000	RoHS & Green	NIPDAU	Level-1-260C-UNLIM	-40 to 125	903BRQ	Samples
LM2903BRQPWRQ1	ACTIVE	TSSOP	PW	8	3000	RoHS & Green	NIPDAU	Level-1-260C-UNLIM	-40 to 125	2903BR	Samples
LM2903BTQDGKRQ1	ACTIVE	VSSOP	DGK	8	2500	RoHS & Green	NIPDAU	Level-1-260C-UNLIM	-40 to 125	3BTQ	Samples
LM2903BTQDRQ1	ACTIVE	SOIC	D	8	3000	RoHS & Green	NIPDAU	Level-1-260C-UNLIM	-40 to 125	903BTQ	Samples
LM2903BTQPWRQ1	ACTIVE	TSSOP	PW	8	3000	RoHS & Green	NIPDAU	Level-1-260C-UNLIM	-40 to 125	2903BT	Samples
LM2903BWDSGRQ1	ACTIVE	WSON	DSG	8	3000	RoHS & Green	Call TI SN	Level-2-260C-1 YEAR	-40 to 125	3BWQ	Samples
LM2903EPWRQ1	ACTIVE	TSSOP	PW	8	2000	RoHS & Green	NIPDAU	Level-2-260C-1 YEAR	-40 to 150	2903Q0	Samples
LM2903QDQDGKRQ1	ACTIVE	VSSOP	DGK	8	2500	RoHS & Green	NIPDAUAG	Level-2-260C-1 YEAR	-40 to 125	KACQ	Samples

Orderable Device	Status (1)	Package Type	Package Drawing	Pins	Package Qty	Eco Plan (2)	Lead finish/ Ball material (6)	MSL Peak Temp (3)	Op Temp (°C)	Device Marking (4/5)	Samples
LM2903QDRG4Q1	ACTIVE	SOIC	D	8	2500	RoHS & Green	NIPDAU	Level-1-260C-UNLIM	-40 to 125	2903Q1	Samples
LM2903QDRQ1	ACTIVE	SOIC	D	8	2500	RoHS & Green	NIPDAU	Level-1-260C-UNLIM	-40 to 125	2903Q1	Samples
LM2903QPWRG4Q1	ACTIVE	TSSOP	PW	8	2000	RoHS & Green	NIPDAU	Level-1-260C-UNLIM	-40 to 125	2903Q1	Samples
LM2903QPWRQ1	ACTIVE	TSSOP	PW	8	2000	RoHS & Green	NIPDAU	Level-1-260C-UNLIM	-40 to 125	2903Q1	Samples
LM2903VQDRG4Q1	LIFEBUY	SOIC	D	8	2500	RoHS & Green	NIPDAU	Level-1-260C-UNLIM	-40 to 125	2903VQ1	
LM2903VQDRQ1	ACTIVE	SOIC	D	8	2500	RoHS & Green	NIPDAU	Level-1-260C-UNLIM	-40 to 125	2903VQ1	Samples
LM2903VQPWRG4Q1	ACTIVE	TSSOP	PW	8	2000	RoHS & Green	NIPDAU	Level-1-260C-UNLIM	-40 to 125	2903VQ	Samples
LM2903VQPWRQ1	ACTIVE	TSSOP	PW	8	2000	RoHS & Green	NIPDAU	Level-1-260C-UNLIM	-40 to 125	2903VQ	Samples

(1) The marketing status values are defined as follows:

ACTIVE: Product device recommended for new designs.

LIFEBUY: TI has announced that the device will be discontinued, and a lifetime-buy period is in effect.

NRND: Not recommended for new designs. Device is in production to support existing customers, but TI does not recommend using this part in a new design.

PREVIEW: Device has been announced but is not in production. Samples may or may not be available.

OBsolete: TI has discontinued the production of the device.

(2) **RoHS:** TI defines "RoHS" to mean semiconductor products that are compliant with the current EU RoHS requirements for all 10 RoHS substances, including the requirement that RoHS substance do not exceed 0.1% by weight in homogeneous materials. Where designed to be soldered at high temperatures, "RoHS" products are suitable for use in specified lead-free processes. TI may reference these types of products as "Pb-Free".

RoHS Exempt: TI defines "RoHS Exempt" to mean products that contain lead but are compliant with EU RoHS pursuant to a specific EU RoHS exemption.

Green: TI defines "Green" to mean the content of Chlorine (Cl) and Bromine (Br) based flame retardants meet JS709B low halogen requirements of <=1000ppm threshold. Antimony trioxide based flame retardants must also meet the <=1000ppm threshold requirement.

(3) MSL, Peak Temp. - The Moisture Sensitivity Level rating according to the JEDEC industry standard classifications, and peak solder temperature.

(4) There may be additional marking, which relates to the logo, the lot trace code information, or the environmental category on the device.

(5) Multiple Device Markings will be inside parentheses. Only one Device Marking contained in parentheses and separated by a "~" will appear on a device. If a line is indented then it is a continuation of the previous line and the two combined represent the entire Device Marking for that device.

⁽⁶⁾ Lead finish/Ball material - Orderable Devices may have multiple material finish options. Finish options are separated by a vertical ruled line. Lead finish/Ball material values may wrap to two lines if the finish value exceeds the maximum column width.

Important Information and Disclaimer:The information provided on this page represents TI's knowledge and belief as of the date that it is provided. TI bases its knowledge and belief on information provided by third parties, and makes no representation or warranty as to the accuracy of such information. Efforts are underway to better integrate information from third parties. TI has taken and continues to take reasonable steps to provide representative and accurate information but may not have conducted destructive testing or chemical analysis on incoming materials and chemicals. TI and TI suppliers consider certain information to be proprietary, and thus CAS numbers and other limited information may not be available for release.

In no event shall TI's liability arising out of such information exceed the total purchase price of the TI part(s) at issue in this document sold by TI to Customer on an annual basis.

OTHER QUALIFIED VERSIONS OF LM2903-Q1, LM2903B-Q1 :

- Catalog : [LM2903](#), [LM2903B](#)

NOTE: Qualified Version Definitions:

- Catalog - TI's standard catalog product

TAPE AND REEL INFORMATION

QUADRANT ASSIGNMENTS FOR PIN 1 ORIENTATION IN TAPE

*All dimensions are nominal

Device	Package Type	Package Drawing	Pins	SPQ	Reel Diameter (mm)	Reel Width W1 (mm)	A0 (mm)	B0 (mm)	K0 (mm)	P1 (mm)	W (mm)	Pin1 Quadrant
LM2903AVQDRG4Q1	SOIC	D	8	2500	330.0	12.4	6.4	5.2	2.1	8.0	12.0	Q1
LM2903AVQDRQ1	SOIC	D	8	2500	330.0	12.4	6.4	5.2	2.1	8.0	12.0	Q1
LM2903AVQDRQ1	SOIC	D	8	2500	330.0	12.5	6.4	5.2	2.1	8.0	12.0	Q1
LM2903AVQPWRG4Q1	TSSOP	PW	8	2000	330.0	12.4	7.0	3.6	1.6	8.0	12.0	Q1
LM2903AVQPWRQ1	TSSOP	PW	8	2000	330.0	12.4	7.0	3.6	1.6	8.0	12.0	Q1
LM2903BHQDGRQ1	VSSOP	DGK	8	2500	330.0	12.4	5.3	3.4	1.4	8.0	12.0	Q1
LM2903BHQDRQ1	SOIC	D	8	3000	330.0	12.4	6.4	5.2	2.1	8.0	12.0	Q1
LM2903BHPWRQ1	TSSOP	PW	8	3000	330.0	12.4	7.0	3.6	1.6	8.0	12.0	Q1
LM2903BQDDFRQ1	SOT-23-THIN	DDF	8	3000	180.0	8.4	3.2	3.2	1.4	4.0	8.0	Q3
LM2903BQDGRQ1	VSSOP	DGK	8	2500	330.0	12.4	5.3	3.4	1.4	8.0	12.0	Q1
LM2903BQDRQ1	SOIC	D	8	2500	330.0	12.4	6.4	5.2	2.1	8.0	12.0	Q1
LM2903BQDRQ1	SOIC	D	8	2500	330.0	12.4	6.4	5.2	2.1	8.0	12.0	Q1
LM2903BQPWRQ1	TSSOP	PW	8	2000	330.0	12.4	7.0	3.6	1.6	8.0	12.0	Q1
LM2903BRQDGRQ1	VSSOP	DGK	8	2500	330.0	12.4	5.3	3.4	1.4	8.0	12.0	Q1
LM2903BRQDRQ1	SOIC	D	8	3000	330.0	12.4	6.4	5.2	2.1	8.0	12.0	Q1

Device	Package Type	Package Drawing	Pins	SPQ	Reel Diameter (mm)	Reel Width W1 (mm)	A0 (mm)	B0 (mm)	K0 (mm)	P1 (mm)	W (mm)	Pin1 Quadrant
LM2903BRQPWRQ1	TSSOP	PW	8	3000	330.0	12.4	7.0	3.6	1.6	8.0	12.0	Q1
LM2903BTQDGKRQ1	VSSOP	DGK	8	2500	330.0	12.4	5.3	3.4	1.4	8.0	12.0	Q1
LM2903BTQDRQ1	SOIC	D	8	3000	330.0	12.4	6.4	5.2	2.1	8.0	12.0	Q1
LM2903BTQPWRQ1	TSSOP	PW	8	3000	330.0	12.4	7.0	3.6	1.6	8.0	12.0	Q1
LM2903BWDSGRQ1	WSON	DSG	8	3000	180.0	8.4	2.2	2.2	1.2	4.0	8.0	Q2
LM2903EPWRQ1	TSSOP	PW	8	2000	330.0	12.4	7.0	3.6	1.6	8.0	12.0	Q1
LM2903QDGKRQ1	VSSOP	DGK	8	2500	330.0	12.4	5.3	3.4	1.4	8.0	12.0	Q1
LM2903QDRG4Q1	SOIC	D	8	2500	330.0	12.4	6.4	5.2	2.1	8.0	12.0	Q1
LM2903QDRQ1	SOIC	D	8	2500	330.0	12.4	6.4	5.2	2.1	8.0	12.0	Q1
LM2903QPWRG4Q1	TSSOP	PW	8	2000	330.0	12.4	7.0	3.6	1.6	8.0	12.0	Q1
LM2903QPWRQ1	TSSOP	PW	8	2000	330.0	12.4	7.0	3.6	1.6	8.0	12.0	Q1
LM2903VQDRG4Q1	SOIC	D	8	2500	330.0	12.4	6.4	5.2	2.1	8.0	12.0	Q1
LM2903VQPWRG4Q1	TSSOP	PW	8	2000	330.0	12.4	7.0	3.6	1.6	8.0	12.0	Q1
LM2903VQPWRG4Q1	TSSOP	PW	8	2000	330.0	12.4	7.0	3.6	1.6	8.0	12.0	Q1
LM2903VQPWRQ1	TSSOP	PW	8	2000	330.0	12.4	7.0	3.6	1.6	8.0	12.0	Q1
LM2903VQPWRQ1	TSSOP	PW	8	2000	330.0	12.4	7.0	3.6	1.6	8.0	12.0	Q1

TAPE AND REEL BOX DIMENSIONS

*All dimensions are nominal

Device	Package Type	Package Drawing	Pins	SPQ	Length (mm)	Width (mm)	Height (mm)
LM2903AVQDRG4Q1	SOIC	D	8	2500	340.5	338.1	20.6
LM2903AVQDRQ1	SOIC	D	8	2500	340.5	338.1	20.6
LM2903AVQDRQ1	SOIC	D	8	2500	340.5	338.1	20.6
LM2903AVQPWRG4Q1	TSSOP	PW	8	2000	367.0	367.0	35.0
LM2903AVQPWRQ1	TSSOP	PW	8	2000	356.0	356.0	35.0
LM2903BHQDGKRQ1	VSSOP	DGK	8	2500	366.0	364.0	50.0
LM2903BHQDRQ1	SOIC	D	8	3000	340.5	338.1	20.6
LM2903BHPWRQ1	TSSOP	PW	8	3000	356.0	356.0	35.0
LM2903BQDDFRQ1	SOT-23-THIN	DDF	8	3000	210.0	185.0	35.0
LM2903BQDGKRQ1	VSSOP	DGK	8	2500	366.0	364.0	50.0
LM2903BQDRQ1	SOIC	D	8	2500	340.5	338.1	20.6
LM2903BQDRQ1	SOIC	D	8	2500	356.0	356.0	35.0
LM2903BQPWRQ1	TSSOP	PW	8	2000	356.0	356.0	35.0
LM2903BRQDGKRQ1	VSSOP	DGK	8	2500	366.0	364.0	50.0
LM2903BRQDRQ1	SOIC	D	8	3000	340.5	338.1	20.6
LM2903BRQPWRQ1	TSSOP	PW	8	3000	356.0	356.0	35.0
LM2903BTQDGKRQ1	VSSOP	DGK	8	2500	366.0	364.0	50.0
LM2903BTQDRQ1	SOIC	D	8	3000	340.5	338.1	20.6

Device	Package Type	Package Drawing	Pins	SPQ	Length (mm)	Width (mm)	Height (mm)
LM2903BTQPWRQ1	TSSOP	PW	8	3000	356.0	356.0	35.0
LM2903BWDSGRQ1	WSON	DSG	8	3000	213.0	191.0	35.0
LM2903EPWRQ1	TSSOP	PW	8	2000	356.0	356.0	35.0
LM2903QDGKRQ1	VSSOP	DGK	8	2500	366.0	364.0	50.0
LM2903QDRG4Q1	SOIC	D	8	2500	340.5	338.1	20.6
LM2903QDRQ1	SOIC	D	8	2500	340.5	338.1	20.6
LM2903QPWRG4Q1	TSSOP	PW	8	2000	356.0	356.0	35.0
LM2903QPWRQ1	TSSOP	PW	8	2000	356.0	356.0	35.0
LM2903VQDRG4Q1	SOIC	D	8	2500	340.5	338.1	20.6
LM2903VQPWRG4Q1	TSSOP	PW	8	2000	367.0	367.0	35.0
LM2903VQPWRG4Q1	TSSOP	PW	8	2000	356.0	356.0	35.0
LM2903VQPWRQ1	TSSOP	PW	8	2000	356.0	356.0	35.0
LM2903VQPWRQ1	TSSOP	PW	8	2000	356.0	356.0	35.0

DGK0008A



PACKAGE OUTLINE

VSSOP - 1.1 mm max height

SMALL OUTLINE PACKAGE



4214862/A 04/2023

NOTES:

PowerPAD is a trademark of Texas Instruments.

1. All linear dimensions are in millimeters. Any dimensions in parenthesis are for reference only. Dimensioning and tolerancing per ASME Y14.5M.
2. This drawing is subject to change without notice.
3. This dimension does not include mold flash, protrusions, or gate burrs. Mold flash, protrusions, or gate burrs shall not exceed 0.15 mm per side.
4. This dimension does not include interlead flash. Interlead flash shall not exceed 0.25 mm per side.
5. Reference JEDEC registration MO-187.

EXAMPLE BOARD LAYOUT

DGK0008A

™ VSSOP - 1.1 mm max height

SMALL OUTLINE PACKAGE



LAND PATTERN EXAMPLE
EXPOSED METAL SHOWN
SCALE: 15X



SOLDER MASK DETAILS

4214862/A 04/2023

NOTES: (continued)

6. Publication IPC-7351 may have alternate designs.
7. Solder mask tolerances between and around signal pads can vary based on board fabrication site.
8. Vias are optional depending on application, refer to device data sheet. If any vias are implemented, refer to their locations shown on this view. It is recommended that vias under paste be filled, plugged or tented.
9. Size of metal pad may vary due to creepage requirement.

EXAMPLE STENCIL DESIGN

DGK0008A

TM VSSOP - 1.1 mm max height

SMALL OUTLINE PACKAGE



SOLDER PASTE EXAMPLE
SCALE: 15X

4214862/A 04/2023

NOTES: (continued)

11. Laser cutting apertures with trapezoidal walls and rounded corners may offer better paste release. IPC-7525 may have alternate design recommendations.
12. Board assembly site may have different recommendations for stencil design.

DDF0008A



PACKAGE OUTLINE

SOT-23 - 1.1 mm max height

PLASTIC SMALL OUTLINE

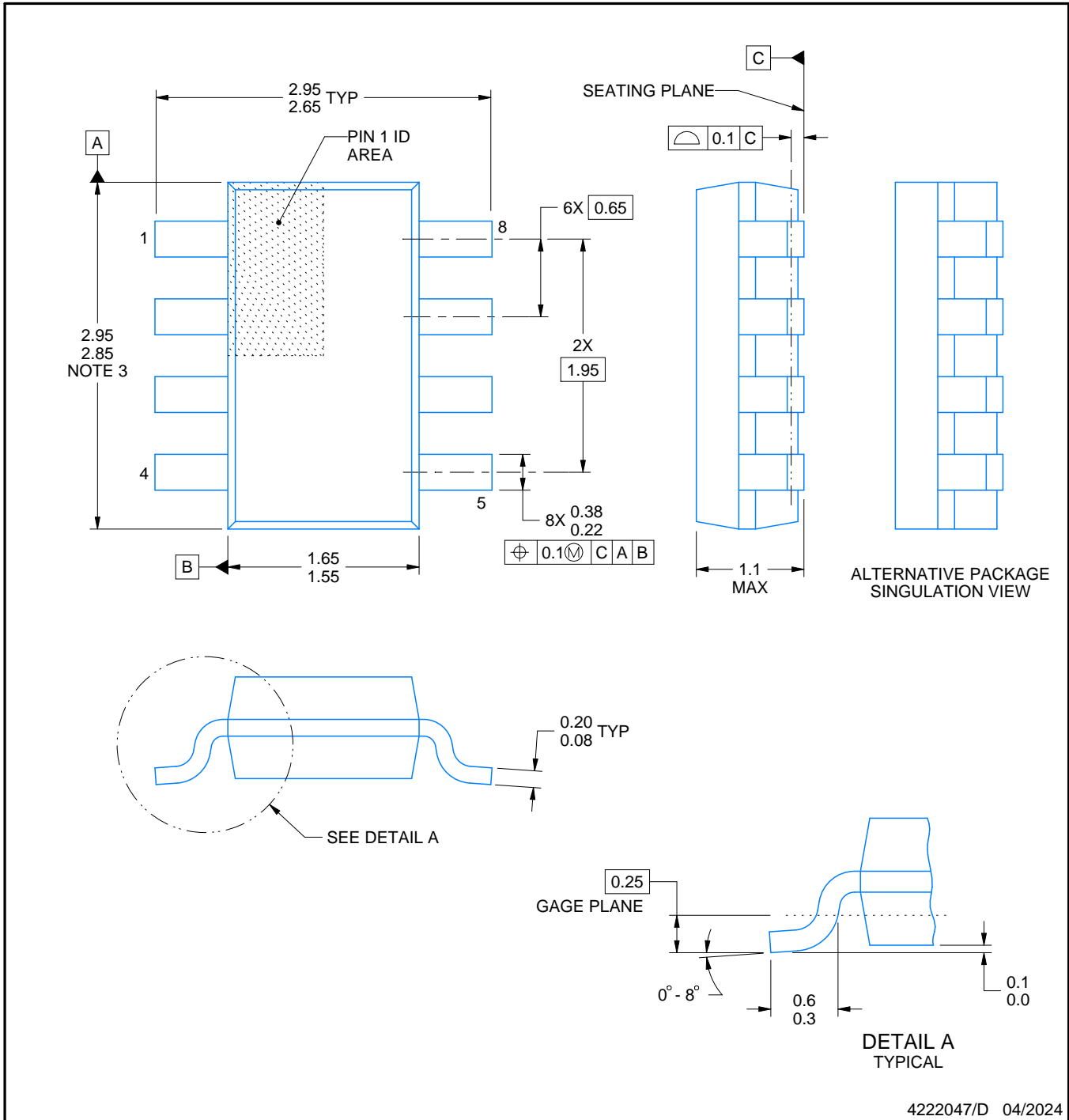

NOTES:

1. All linear dimensions are in millimeters. Any dimensions in parenthesis are for reference only. Dimensioning and tolerancing per ASME Y14.5M.
2. This drawing is subject to change without notice.
3. This dimension does not include mold flash, protrusions, or gate burrs. Mold flash, protrusions, or gate burrs shall not exceed 0.15 mm per side.

4222047/D 04/2024

EXAMPLE BOARD LAYOUT

DDF0008A

SOT-23 - 1.1 mm max height

PLASTIC SMALL OUTLINE

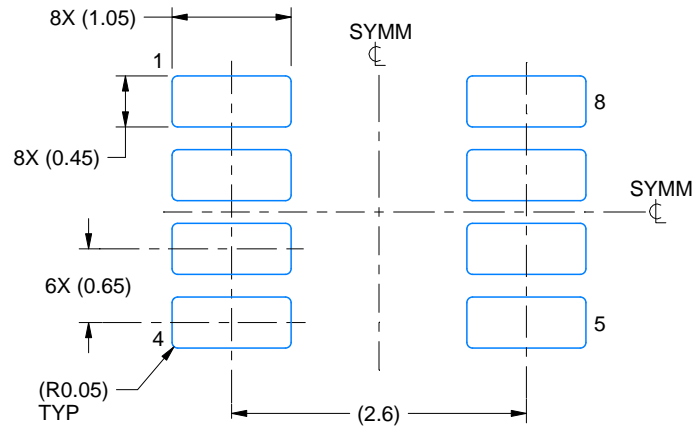

LAND PATTERN EXAMPLE
EXPOSED METAL SHOWN
SCALE:15X

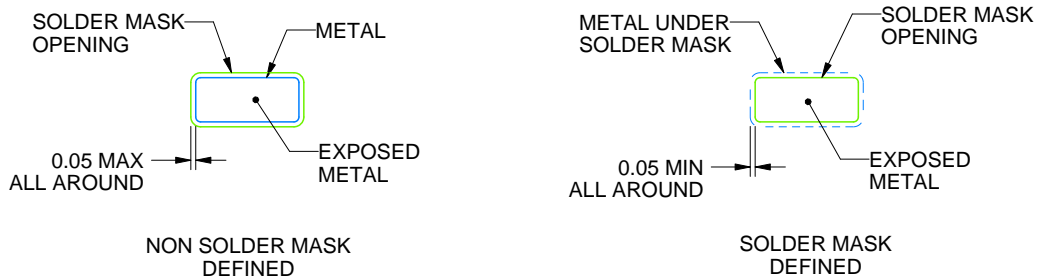

SOLDER MASK DETAILS

4222047/D 04/2024

NOTES: (continued)

- 4. Publication IPC-7351 may have alternate designs.
- 5. Solder mask tolerances between and around signal pads can vary based on board fabrication site.

EXAMPLE STENCIL DESIGN

DDF0008A

SOT-23 - 1.1 mm max height

PLASTIC SMALL OUTLINE



SOLDER PASTE EXAMPLE
BASED ON 0.125 mm THICK STENCIL
SCALE:15X

4222047/D 04/2024

NOTES: (continued)

6. Laser cutting apertures with trapezoidal walls and rounded corners may offer better paste release. IPC-7525 may have alternate design recommendations.
7. Board assembly site may have different recommendations for stencil design.



D0008A

PACKAGE OUTLINE

SOIC - 1.75 mm max height

SMALL OUTLINE INTEGRATED CIRCUIT



4214825/C 02/2019

NOTES:

- Linear dimensions are in inches [millimeters]. Dimensions in parenthesis are for reference only. Controlling dimensions are in inches. Dimensioning and tolerancing per ASME Y14.5M.
- This drawing is subject to change without notice.
- This dimension does not include mold flash, protrusions, or gate burrs. Mold flash, protrusions, or gate burrs shall not exceed $.006$ [0.15] per side.
- This dimension does not include interlead flash.
- Reference JEDEC registration MS-012, variation AA.

EXAMPLE BOARD LAYOUT

D0008A

SOIC - 1.75 mm max height

SMALL OUTLINE INTEGRATED CIRCUIT



LAND PATTERN EXAMPLE
EXPOSED METAL SHOWN
SCALE:8X



SOLDER MASK DETAILS

4214825/C 02/2019

NOTES: (continued)

- 6. Publication IPC-7351 may have alternate designs.
- 7. Solder mask tolerances between and around signal pads can vary based on board fabrication site.

EXAMPLE STENCIL DESIGN

D0008A

SOIC - 1.75 mm max height

SMALL OUTLINE INTEGRATED CIRCUIT



SOLDER PASTE EXAMPLE
BASED ON .005 INCH [0.125 MM] THICK STENCIL
SCALE:8X

4214825/C 02/2019

NOTES: (continued)

8. Laser cutting apertures with trapezoidal walls and rounded corners may offer better paste release. IPC-7525 may have alternate design recommendations.
9. Board assembly site may have different recommendations for stencil design.

GENERIC PACKAGE VIEW

DSG 8

WSON - 0.8 mm max height

2 x 2, 0.5 mm pitch

PLASTIC SMALL OUTLINE - NO LEAD

This image is a representation of the package family, actual package may vary.
Refer to the product data sheet for package details.



4224783/A

DSG0008B

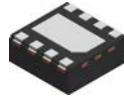

PACKAGE OUTLINE

WSON - 0.8 mm max height

PLASTIC SMALL OUTLINE - NO LEAD

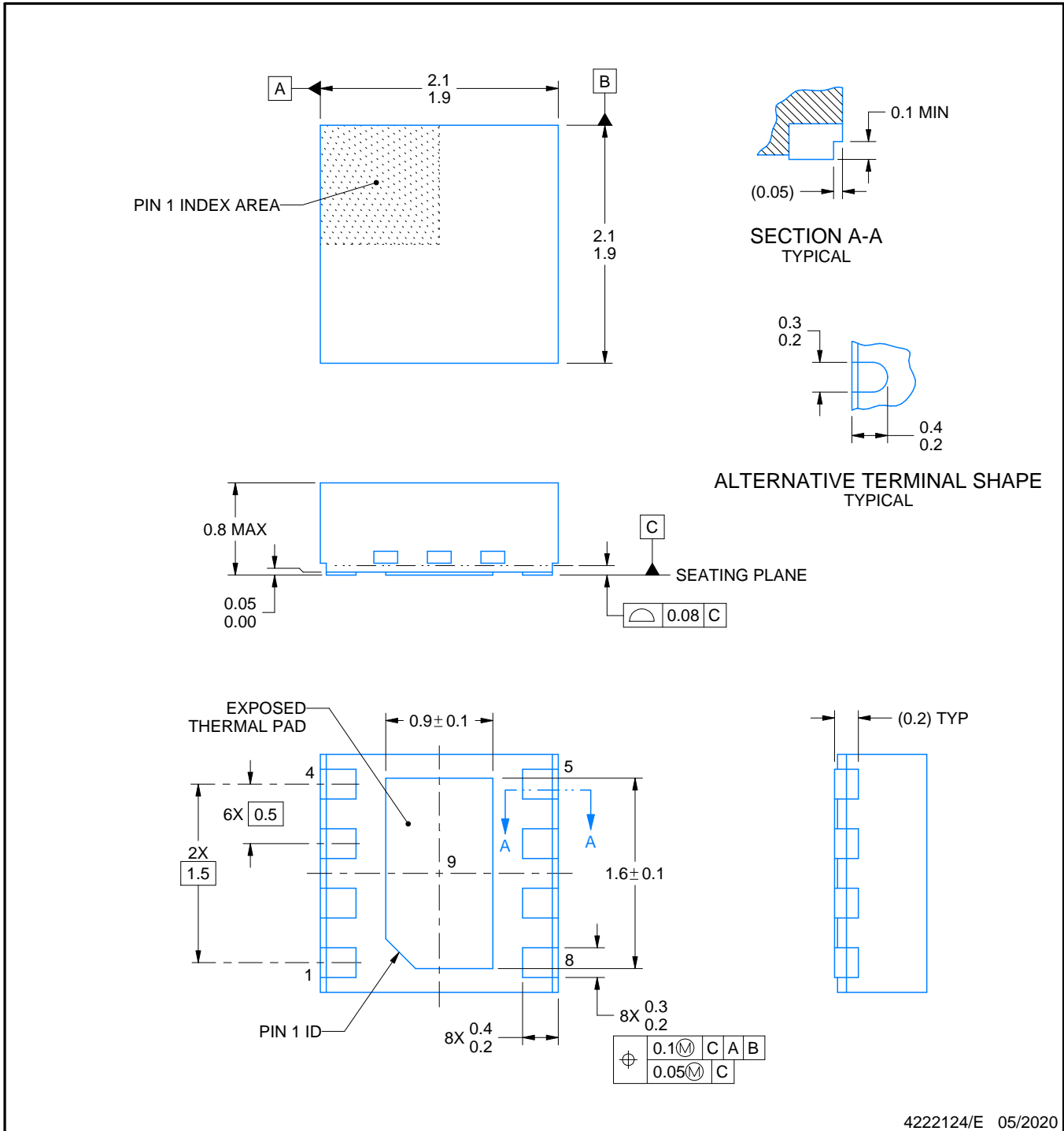

4222124/E 05/2020

NOTES:

1. All linear dimensions are in millimeters. Any dimensions in parenthesis are for reference only. Dimensioning and tolerancing per ASME Y14.5M.
2. This drawing is subject to change without notice.
3. The package thermal pad must be soldered to the printed circuit board for thermal and mechanical performance.

EXAMPLE BOARD LAYOUT

DSG0008B

WSON - 0.8 mm max height

PLASTIC SMALL OUTLINE - NO LEAD

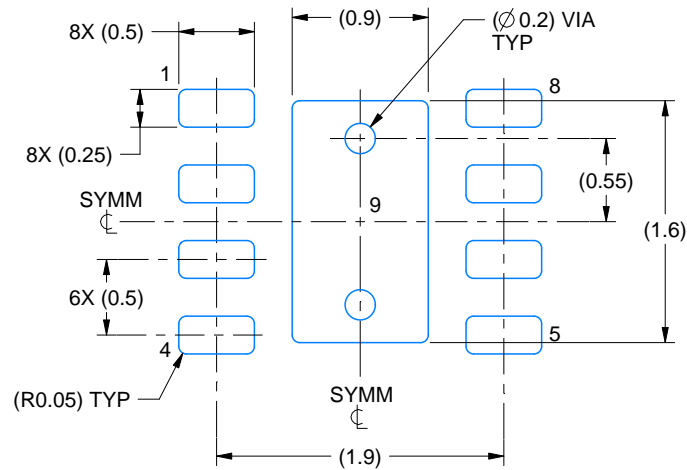

LAND PATTERN EXAMPLE
EXPOSED METAL SHOWN
SCALE:20X

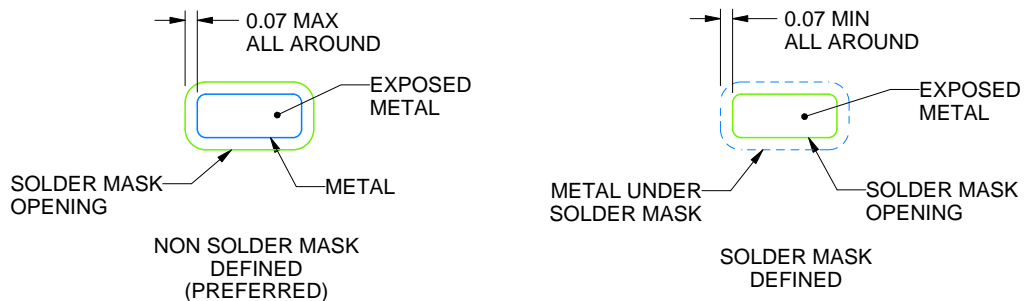

SOLDER MASK DETAILS

4222124/E 05/2020

NOTES: (continued)

- This package is designed to be soldered to a thermal pad on the board. For more information, see Texas Instruments literature number SLUA271 (www.ti.com/lit/sluea271).
- Vias are optional depending on application, refer to device data sheet. If any vias are implemented, refer to their locations shown on this view. It is recommended that vias under paste be filled, plugged or tented.

EXAMPLE STENCIL DESIGN

DSG0008B

WSON - 0.8 mm max height

PLASTIC SMALL OUTLINE - NO LEAD

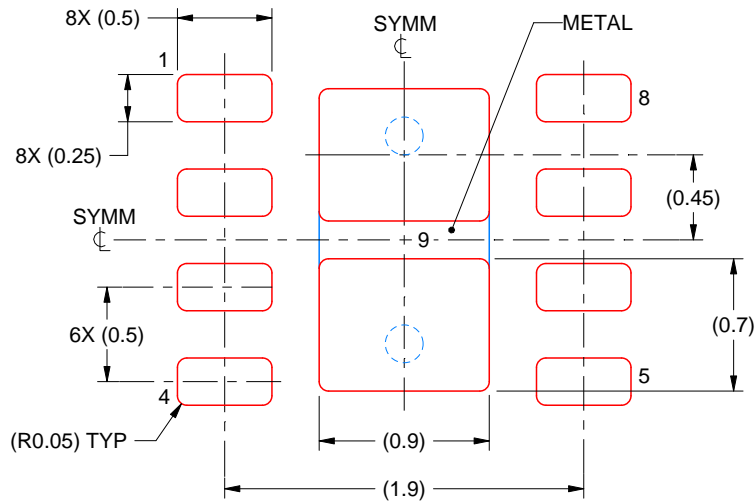

SOLDER PASTE EXAMPLE
BASED ON 0.125 mm THICK STENCIL

EXPOSED PAD 9:
87% PRINTED SOLDER COVERAGE BY AREA UNDER PACKAGE
SCALE:25X

4222124/E 05/2020

NOTES: (continued)

6. Laser cutting apertures with trapezoidal walls and rounded corners may offer better paste release. IPC-7525 may have alternate design recommendations.

PW0008A



PACKAGE OUTLINE
TSSOP - 1.2 mm max height

SMALL OUTLINE PACKAGE



4221848/A 02/2015

NOTES:

1. All linear dimensions are in millimeters. Any dimensions in parenthesis are for reference only. Dimensioning and tolerancing per ASME Y14.5M.
2. This drawing is subject to change without notice.
3. This dimension does not include mold flash, protrusions, or gate burrs. Mold flash, protrusions, or gate burrs shall not exceed 0.15 mm per side.
4. This dimension does not include interlead flash. Interlead flash shall not exceed 0.25 mm per side.
5. Reference JEDEC registration MO-153, variation AA.

EXAMPLE BOARD LAYOUT

PW0008A

TSSOP - 1.2 mm max height

SMALL OUTLINE PACKAGE



LAND PATTERN EXAMPLE
SCALE:10X



SOLDER MASK DETAILS
NOT TO SCALE

4221848/A 02/2015

NOTES: (continued)

- 6. Publication IPC-7351 may have alternate designs.
- 7. Solder mask tolerances between and around signal pads can vary based on board fabrication site.

EXAMPLE STENCIL DESIGN

PW0008A

TSSOP - 1.2 mm max height

SMALL OUTLINE PACKAGE



SOLDER PASTE EXAMPLE
BASED ON 0.125 mm THICK STENCIL
SCALE:10X

4221848/A 02/2015

NOTES: (continued)

8. Laser cutting apertures with trapezoidal walls and rounded corners may offer better paste release. IPC-7525 may have alternate design recommendations.
9. Board assembly site may have different recommendations for stencil design.

重要声明和免责声明

TI“按原样”提供技术和可靠性数据（包括数据表）、设计资源（包括参考设计）、应用或其他设计建议、网络工具、安全信息和其他资源，不保证没有瑕疵且不做任何明示或暗示的担保，包括但不限于对适销性、某特定用途方面的适用性或不侵犯任何第三方知识产权的暗示担保。

这些资源可供使用 TI 产品进行设计的熟练开发人员使用。您将自行承担以下全部责任：(1) 针对您的应用选择合适的 TI 产品，(2) 设计、验证并测试您的应用，(3) 确保您的应用满足相应标准以及任何其他功能安全、信息安全、监管或其他要求。

这些资源如有变更，恕不另行通知。TI 授权您仅可将这些资源用于研发本资源所述的 TI 产品的应用。严禁对这些资源进行其他复制或展示。您无权使用任何其他 TI 知识产权或任何第三方知识产权。您应全额赔偿因在这些资源的使用中对 TI 及其代表造成的任何索赔、损害、成本、损失和债务，TI 对此概不负责。

TI 提供的产品受 [TI 的销售条款](#) 或 [ti.com](#) 上其他适用条款/TI 产品随附的其他适用条款的约束。TI 提供这些资源并不会扩展或以其他方式更改 TI 针对 TI 产品发布的适用的担保或担保免责声明。

TI 反对并拒绝您可能提出的任何其他或不同的条款。

邮寄地址：Texas Instruments, Post Office Box 655303, Dallas, Texas 75265

Copyright © 2024，德州仪器 (TI) 公司