

# 具有 20V 最大输入电压的 LMZ12010 10A SIMPLE SWITCHER® 电源模块

## 1 特性

- 集成屏蔽式电感器
- 简单的 PCB 布局
- 固定开关频率 (350 kHz)
- 采用外部软启动、跟踪和精密使能组件实现灵活启动排序
- 针对浪涌电流以及输入 UVLO 和输出短路等故障提供保护
- 结温范围：-40°C 至 125°C
- 便于装配和制造的单个外露焊盘和标准引脚分配
- 完全支持 WEBENCH® power designer
- 与 [LMZ22010](#)、[LMZ22008](#)、[LMZ22006](#)、[LMZ12008](#)、[LMZ12006](#)、[LMZ23610](#)、[LMZ23608](#)、[LMZ23606](#)、[LMZ13610](#)、[LMZ13608](#) 和 [LMZ13606](#) 引脚兼容
- 电气规范
  - 总输出功率最大值达 50W
  - 高达 10A 输出电流
  - 输入电压范围：6 V 至 20 V
  - 输出电压范围：0.8 V 至 6 V
  - 效率高达 92%
- 性能优势
  - 高效率帮助减少了系统产生的热量
  - 经低辐射发射 (EMI) 测试，符合 EN55022 <sup>1</sup>
  - 仅七个外部组件
  - 低输出电压纹波
  - 无需外部散热片

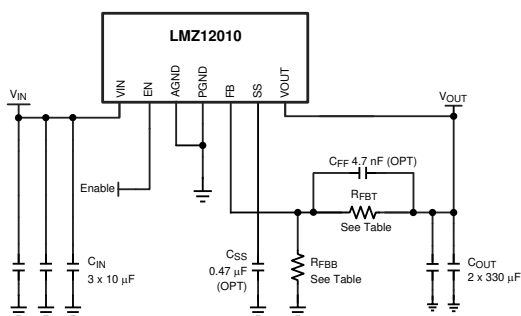

简化版应用原理图

## 2 应用

- 12V 输入轨的负载点转换
- 时间关键型项目
- 空间受限且散热要求较高的应用
- 负输出电压应用  
(请参见 AN-2027 [SNVA425](#))

## 3 说明

LMZ12010 SIMPLE SWITCHER® 电源模块是易于使用的降压直流/直流解决方案，能够驱动高达 10A 的负载。LMZ12010 采用创新型封装，可提高热性能并支持手工或机器焊接。

LMZ12010 器件支持 6V 至 20V 的输入电压轨范围，可提供低至 0.8V 的高精度可调节输出电压。LMZ12010 仅需两个外部电阻和外部电容器即可完善电源解决方案。LMZ12010 采用可靠而稳健的设计，并具有以下保护特性：热关断、可编程输入欠压锁定、输出过压保护、短路保护、输出限流，并且该器件支持启动至预偏置输出。

### 器件信息

器件型号 <sup>(2)</sup>	封装 <sup>(1)</sup>	封装尺寸 (标称值)
LMZ12010	NDY (11)	15.00mm × 15.00mm

- (1) 如需了解所有可用封装，请参阅数据表末尾的可订购产品附录。
- (2) 峰值回流焊温度等于 245°C。请参阅 [SNAA214](#) 了解更多详细信息。

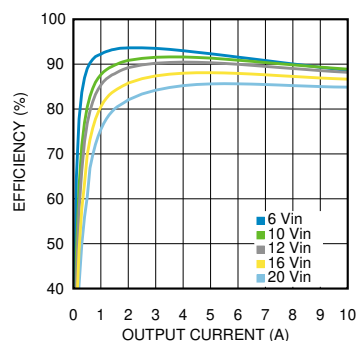

25°C、输入电压为 3.3V 时的效率

<sup>1</sup> EN 55022:2006、+A1:2007、FCC 第 15 部分 B 子部分，在具有 EMI 配置的评估板上进行了测试。



## Table of Contents

<b>1 特性</b> .....	1	8.1 Application Information.....	17
<b>2 应用</b> .....	1	8.2 Typical Application.....	17
<b>3 说明</b> .....	1	<b>9 Power Supply Recommendations</b> .....	24
<b>4 Revision History</b> .....	2	<b>10 Layout</b> .....	25
<b>5 Pin Configuration and Functions</b> .....	3	10.1 Layout Guidelines.....	25
<b>6 Specifications</b> .....	4	10.2 Layout Examples.....	25
6.1 Absolute Maximum Ratings .....	4	10.3 Power Dissipation and Thermal Considerations.....	27
6.2 ESD Ratings.....	4	10.4 Power Module SMT Guidelines.....	28
6.3 Recommended Operating Conditions.....	4	<b>11 Device and Documentation Support</b> .....	30
6.4 Thermal Information.....	4	11.1 Device Support.....	30
6.5 Electrical Characteristics.....	5	11.2 Documentation Support.....	30
6.6 Typical Characteristics.....	6	11.3 支持资源.....	30
<b>7 Detailed Description</b> .....	14	11.4 接收文档更新通知.....	30
7.1 Overview.....	14	11.5 Trademarks.....	30
7.2 Functional Block Diagram.....	14	11.6 Electrostatic Discharge Caution.....	30
7.3 Feature Description.....	14	11.7 术语表.....	30
7.4 Device Functional Modes.....	15	<b>12 Mechanical, Packaging, and Orderable Information</b> .....	31
<b>8 Application and Implementation</b> .....	17		

## 4 Revision History

注：以前版本的页码可能与当前版本的页码不同

<b>Changes from Revision H (July 2015) to Revision I (March 2022)</b>	<b>Page</b>
• 更新了整个文档中的表格、图和交叉参考的编号格式。.....	1
• Corrected AGND pin 2 to AGND pin 3.....	3

<b>Changes from Revision G (October 2013) to Revision H (July 2015)</b>	<b>Page</b>
• 新增了引脚配置和功能部分、ESD 等级表、特性说明部分、器件功能模式、应用和实施部分、电源相关建议部分、布局部分、器件和文档支持部分以及机械、封装和可订购信息部分.....	1

## 5 Pin Configuration and Functions



图 5-1. 11-Pin NDY Package (Top View)

表 5-1. Pin Functions

PIN		TYPE	DESCRIPTION
NAME	NO.		
AGND	3	Ground	Analog ground — Reference point for all stated voltages. Must be externally connected to PGND (EP).
	5		
	6		
EN	4	Analog	Enable — Input to the precision enable comparator. Rising threshold is 1.274 V (typical). Once the module is enabled, a 13- $\mu$ A source current is internally activated to facilitate programmable hysteresis.
FB	7	Analog	Feedback — Internally connected to the regulation amplifier and overvoltage comparator. The regulation reference point is 0.795 V at this input pin. Connect the feedback resistor divider between VOUT and AGND to set the output voltage.
NC	9	—	No connect — This pin must remain floating, do not ground.
PGND	—	Ground	Exposed pad/power ground — Electrical path for the power circuits within the module. PGND is not internally connected to AGND (pin 5, 6). Must be electrically connected to pins 5 and 6 external to the package. The exposed pad is also used to dissipate heat from the package during operation. Use 100 12-mil thermal vias from top to bottom copper for best thermal performance.
SS	8	Analog	Soft-start/track input — To extend the 1.6-ms internal soft start, connect an external soft-start capacitor. For tracking, connect to an external resistive divider to a higher priority supply rail. See <a href="#">节 8.2.2</a> .
VIN	1	Power	Input supply — Nominal operating range is 6 V to 20 V. A small amount of internal capacitance is contained within the package assembly. Additional external input capacitance is required between this pin and the exposed pad (PGND).
	2		
VOUT	10	Power	Output voltage — Output from the internal inductor. Connect the output capacitor between this pin and exposed pad (PGND).
	11		

## 6 Specifications

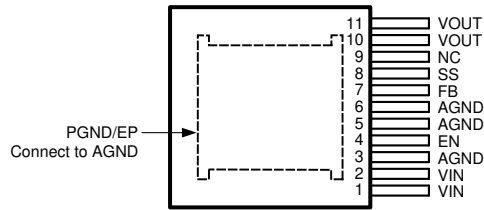
### 6.1 Absolute Maximum Ratings

	MIN <sup>(1) (2)</sup>	MAX <sup>(1) (2)</sup>	UNIT
VIN to PGND	- 0.3	24	V
EN to AGND	- 0.3	5.5	V
SS, FB to AGND	- 0.3	2.5	V
AGND to PGND	- 0.3	0.3	V
Junction Temperature		150	°C
Peak reflow case temperature (30 sec)		245	°C
Storage temperature, T <sub>stg</sub>	- 65	150	°C

- (1) Stresses beyond those listed under *Absolute Maximum Ratings* may cause permanent damage to the device. These are stress ratings only, which do not imply functional operation of the device at these or any other conditions beyond those indicated under *Recommended Operating Conditions*. Exposure to absolute-maximum-rated conditions for extended periods may affect device reliability.
- (2) For soldering specifications, refer to the [Absolute Maximum Ratings for Soldering](#) application report.

### 6.2 ESD Ratings

		VALUE	UNIT
V <sub>(ESD)</sub>	Electrostatic discharge	Human body model (HBM), per ANSI/ESDA/JEDEC JS-001 <sup>(1) (2)</sup>	±2000 V

- (1) JEDEC document JEP155 states that 500-V HBM allows safe manufacturing with a standard ESD control process.
- (2) The human body model is a 100-pF capacitor discharged through a 1.5-kΩ resistor into each pin. Test method is per JESD-22-114.

### 6.3 Recommended Operating Conditions

	MIN <sup>(1)</sup>	MAX <sup>(1)</sup>	UNIT
VIN	6	20	V
EN	0	5	V
Operation junction temperature	-40	125	°C

- (1) *Absolute Maximum Ratings* are limits beyond which damage to the device may occur. Operating Ratings are conditions under which operation of the device is intended to be functional. For compliant specifications and test conditions, see the *Electrical Characteristics*.

### 6.4 Thermal Information

THERMAL METRIC <sup>(1)</sup>		LMZ12010	UNIT	
		NDY		
		11 PINS		
R <sub>θJA</sub>	Junction-to-ambient thermal resistance	Natural Convection	9.9	°C/W
		225 LFPM	6.8	
		500 LFPM	5.2	
R <sub>θJC(top)</sub>	Junction-to-case (top) thermal resistance		1.0	°C/W

- (1) For more information about traditional and new thermal metrics, see the *Semiconductor and IC Package Thermal Metrics* application report, [SPRA953](#).

## 6.5 Electrical Characteristics

Limits are for  $T_J = 25^\circ\text{C}$  unless otherwise specified. Minimum and Maximum limits are ensured through test, design or statistical correlation. Typical values represent the most likely parametric norm at  $T_J = 25^\circ\text{C}$ , and are provided for reference purposes only. Unless otherwise stated the following conditions apply:  $V_{IN} = 12\text{ V}$ ,  $V_{OUT} = 3.3\text{ V}$

PARAMETER		TEST CONDITIONS		MIN	TYP	MAX	UNIT
<b>SYSTEM PARAMETERS</b>							
<b>ENABLE CONTROL</b>							
$V_{EN}$	EN threshold	$V_{EN}$ rising			1.274		V
			Over the junction temperature ( $T_J$ ) range of $-40^\circ\text{C}$ to $+125^\circ\text{C}$	1.096		1.452	
$I_{EN-HYS}$	EN hysteresis source current	$V_{EN} > 1.274\text{ V}$			13		$\mu\text{A}$
<b>SOFT-START</b>							
$I_{SS}$	SS source current	$V_{SS} = 0\text{ V}$			50		$\mu\text{A}$
			Over the junction temperature ( $T_J$ ) range of $-40^\circ\text{C}$ to $+125^\circ\text{C}$	40		60	
$t_{SS}$	Internal soft-start interval				1.6		ms
<b>CURRENT LIMIT</b>							
$I_{CL}$	Current limit threshold	DC average			12.5		A
<b>INTERNAL SWITCHING OSCILLATOR</b>							
$f_{osc}$	Free-running oscillator frequency			314	359	404	kHz
<b>REGULATION AND OVERVOLTAGE COMPARATOR</b>							
$V_{FB}$	In-regulation feedback voltage	$V_{SS} >+ 0.8\text{ V}$ $I_O = 10\text{ A}$			0.795		V
			over the junction temperature ( $T_J$ ) range of $-40^\circ\text{C}$ to $+125^\circ\text{C}$	0.775		0.815	
$V_{FB-OV}$	Feedback overvoltage protection threshold				0.86		V
$I_{FB}$	Feedback input bias current				5		nA
$I_Q$	Nonswitching quiescent current				3		mA
$I_{SD}$	Shutdown quiescent current	$V_{EN} = 0\text{ V}$			32		$\mu\text{A}$
$D_{max}$	Maximum duty factor				85%		
<b>THERMAL CHARACTERISTICS</b>							
$T_{SD}$	Thermal shutdown	Rising			165		$^\circ\text{C}$
$T_{SD-HYST}$	Thermal shutdown hysteresis	Falling			15		$^\circ\text{C}$
<b>PERFORMANCE PARAMETERS <sup>(1)</sup></b>							
$\Delta V_O$	Output voltage ripple	BW at 20 MHz			24		mV <sub>PP</sub>
$\Delta V_O / \Delta V_{IN}$	Line regulation	$V_{IN} = 12\text{ V}$ to $20\text{ V}$ , $I_{OUT} = 10\text{ A}$			$\pm 0.2\%$		
$\Delta V_O / \Delta I_{OUT}$	Load regulation	$V_{IN} = 12\text{ V}$ , $I_{OUT} = 0.001\text{ A}$ to $10\text{ A}$			1		mV/A
$\eta$	Peak efficiency	$V_{IN} = 12\text{ V}$ , $V_{OUT} = 3.3\text{ V}$ , $I_{OUT} = 5\text{ A}$			89.5%		
$\eta$	Full load efficiency	$V_{IN} = 12\text{ V}$ , $V_{OUT} = 3.3\text{ V}$ , $I_{OUT} = 10\text{ A}$			87.5%		

(1) EN 55022:2006, +A1:2007, FCC Part 15 Subpart B, tested on Evaluation Board with EMI configuration.

## 6.6 Typical Characteristics

Unless otherwise specified, the following conditions apply:  $V_{IN} = 12\text{ V}$ ;  $C_{IN} = \text{three} \times 10\text{-}\mu\text{F} + 47\text{-nF X7R Ceramic}$ ;  $C_{OUT} = \text{two} \times 330\text{-}\mu\text{F Specialty Polymer} + 47\text{-}\mu\text{F Ceramic} + 47\text{-nF Ceramic}$ ;  $C_{FF} = 4.7\text{ nF}$ ;  $T_A = 25^\circ\text{C}$  for waveforms. All indicated temperatures are ambient.



图 6-1. Efficiency 5-V Output at 25°C



图 6-2. Dissipation 5-V Output at 25°C

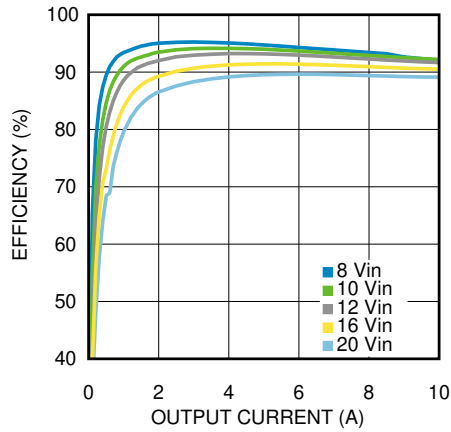

图 6-3. Efficiency 3.3-V Output at 25°C

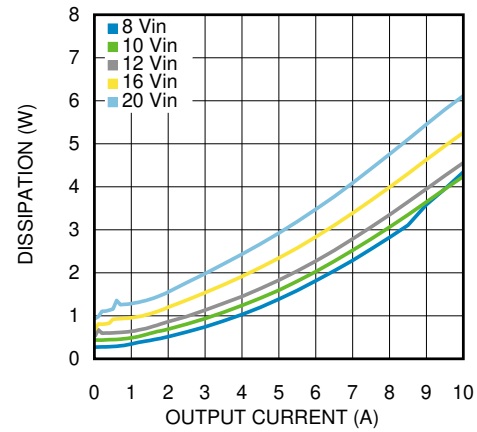

图 6-4. Dissipation 3.3-V Output at 25°C

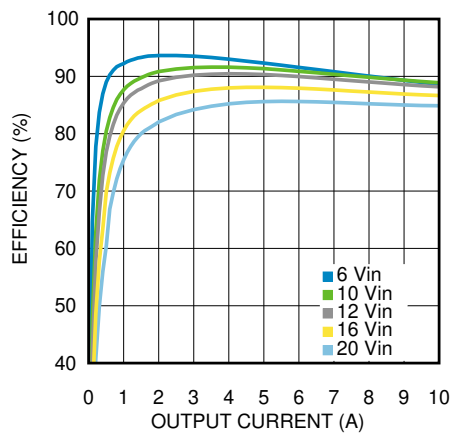

图 6-5. Efficiency 2.5-V Output at 25°C

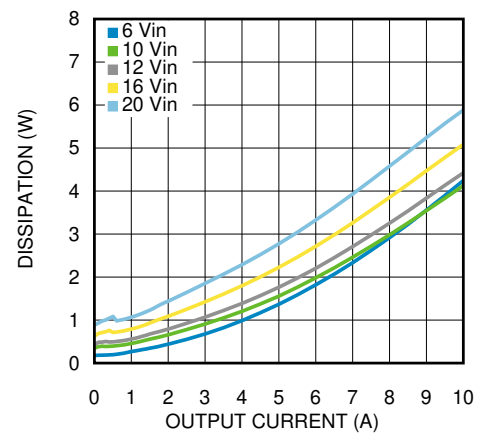

图 6-6. Dissipation 2.5-V Output at 25°C

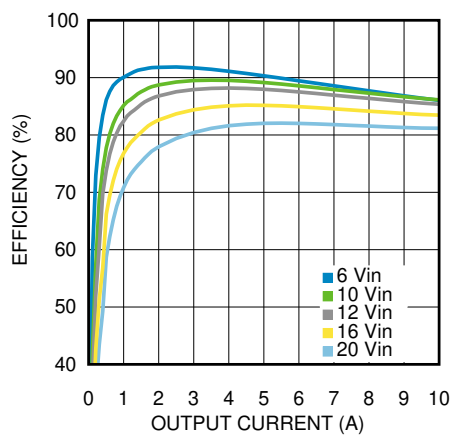

图 6-7. Efficiency 1.8-V Output at 25°C

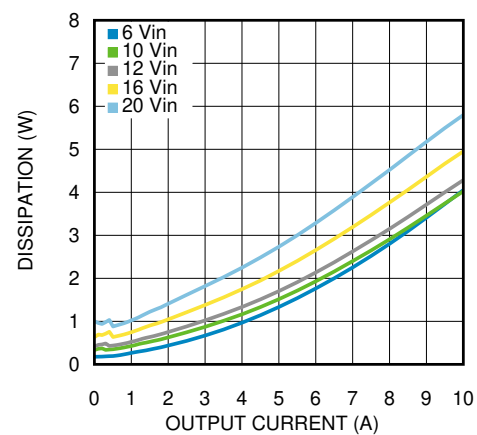

图 6-8. Dissipation 1.8-V Output at 25°C

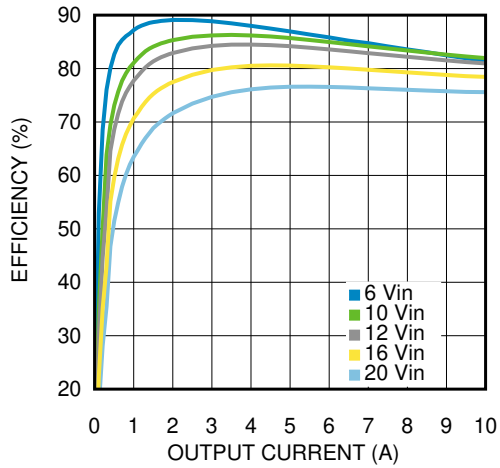

图 6-9. Efficiency 1.5-V Output at 25°C

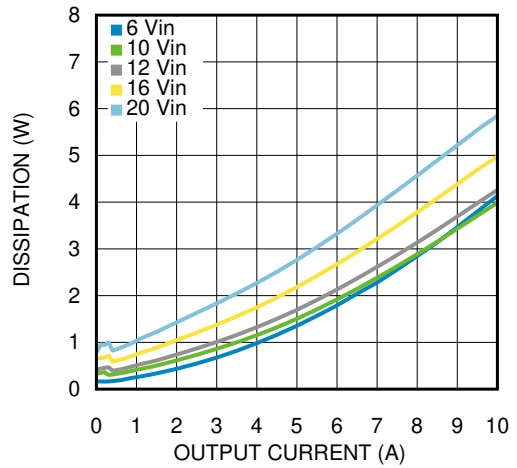

图 6-10. Dissipation 1.5-V Output at 25°C

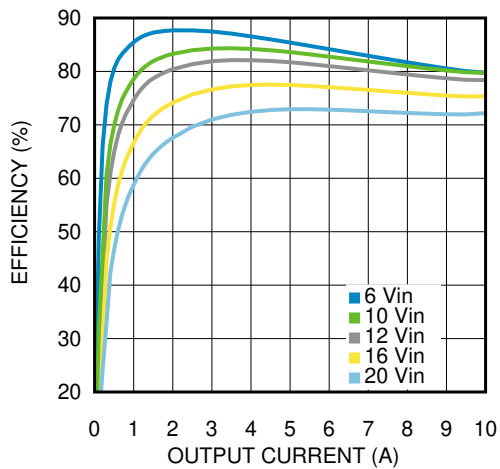

图 6-11. Efficiency 1.2-V Output at 25°C

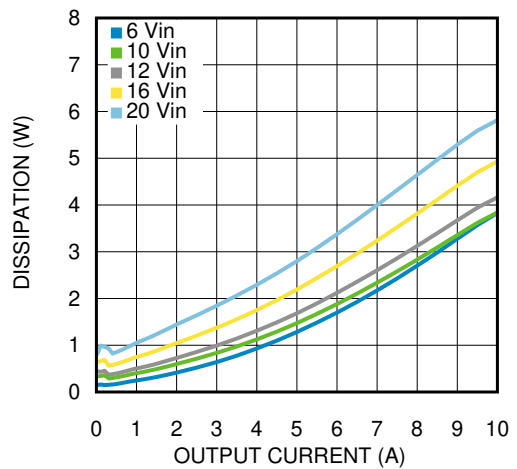

图 6-12. Dissipation 1.2-V Output at 25°C

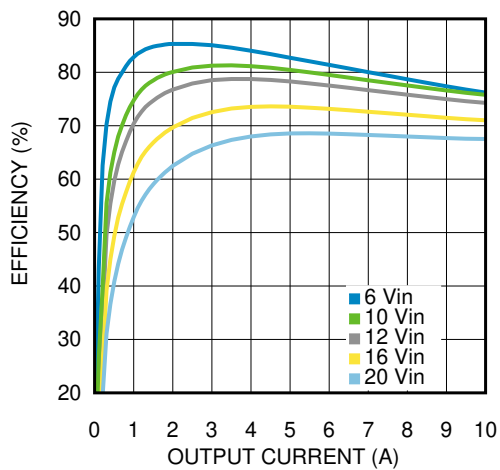

图 6-13. Efficiency 1-V Output at 25°C

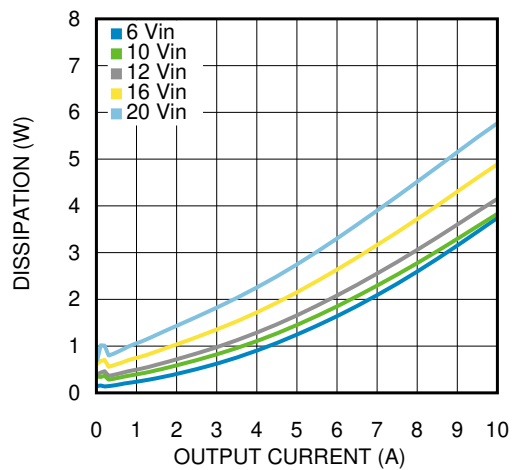

图 6-14. Dissipation 1-V Output at 25°C

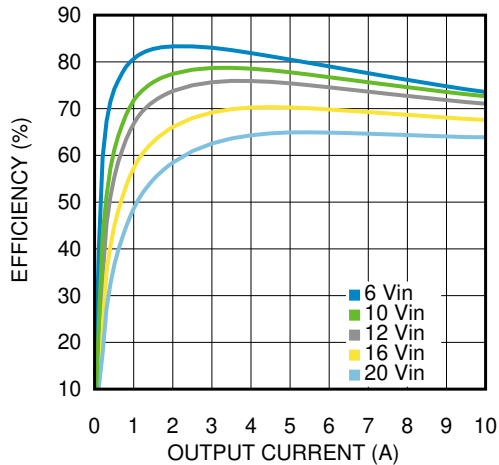

图 6-15. Efficiency 5-V Output at 85°C

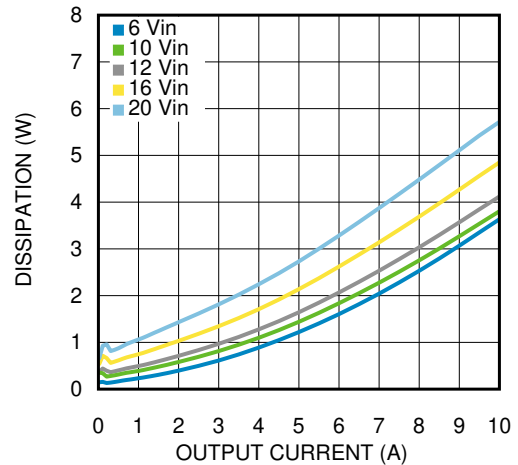

图 6-16. Dissipation 5-V Output at 85°C

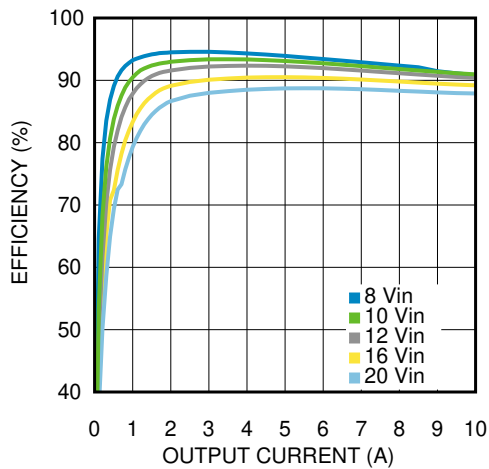

图 6-17. Efficiency 3.3-V Output at 85°C

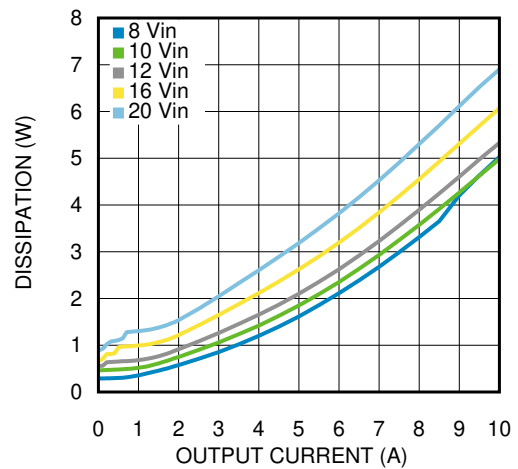

图 6-18. Dissipation 3.3-V Output at 85°C



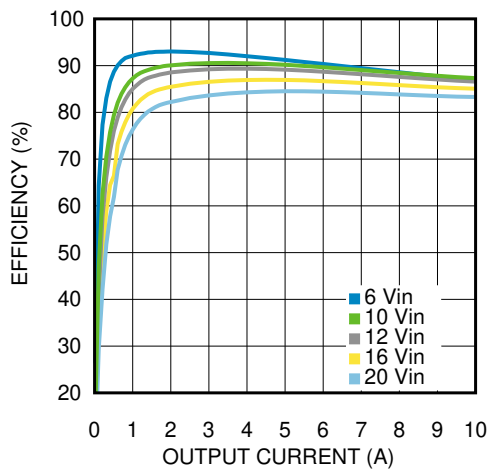

图 6-19. Efficiency 2.5-V Output at 85°C

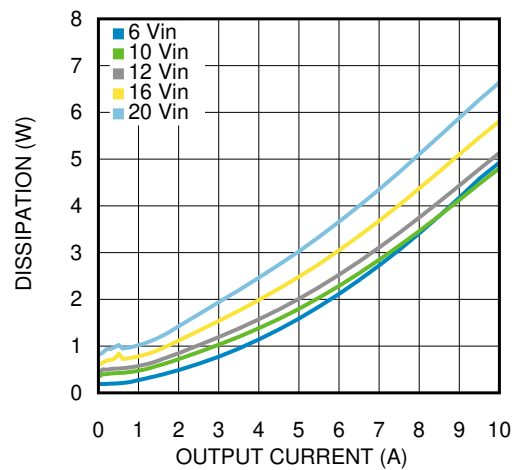

图 6-20. Dissipation 2.5-V Output at 85°C

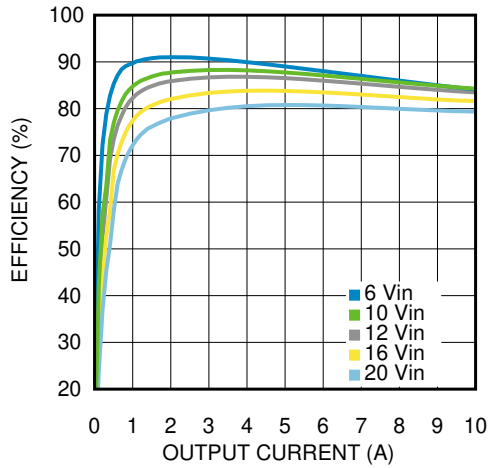

图 6-21. Efficiency 1.8-V Output at 85°C

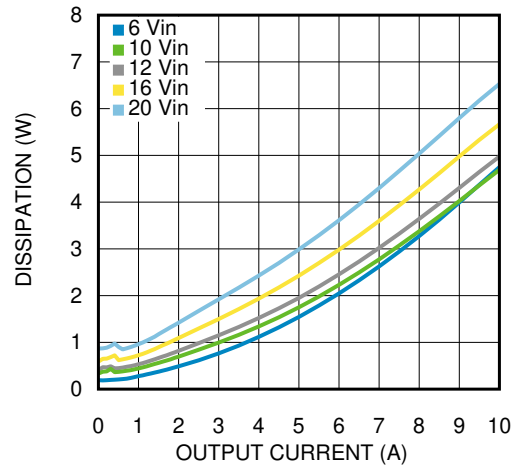

图 6-22. Dissipation 1.8-V Output at 85°C

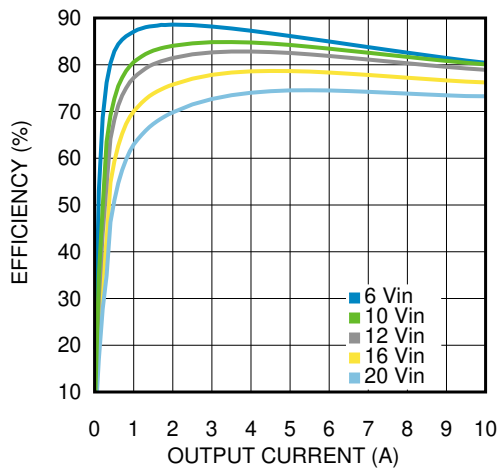

图 6-23. Efficiency 1.5-V Output at 85°C

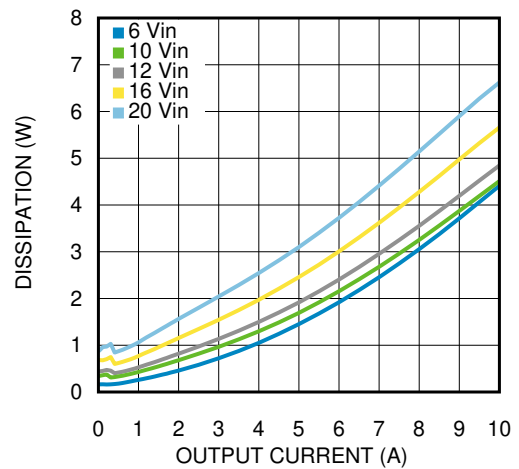

图 6-24. Dissipation 1.5-V Output at 85°C

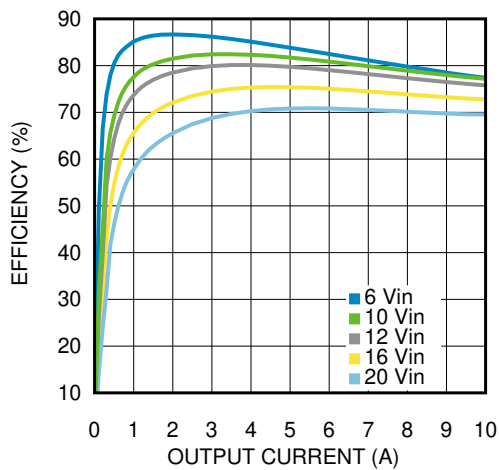

图 6-25. Efficiency 1.2-V Output at 85°C

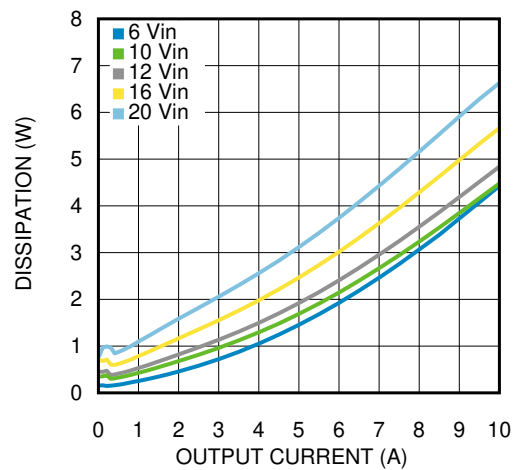

图 6-26. Dissipation 1.2-V Output at 85°C

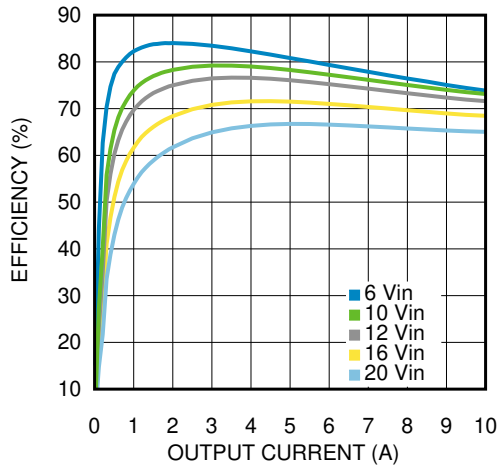

图 6-27. Efficiency 1-V Output at 85°C

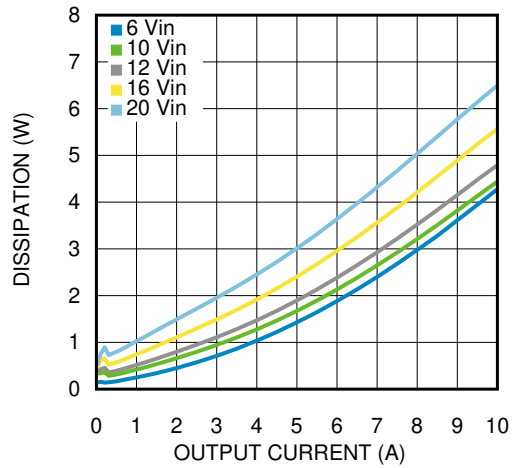

图 6-28. Dissipation 1-V Output at 85°C

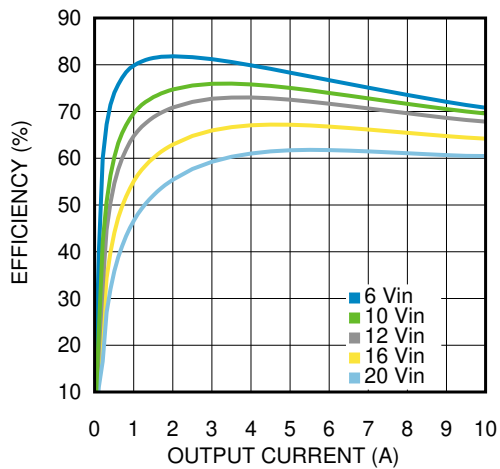

图 6-29. Normalized Line and Load Regulation

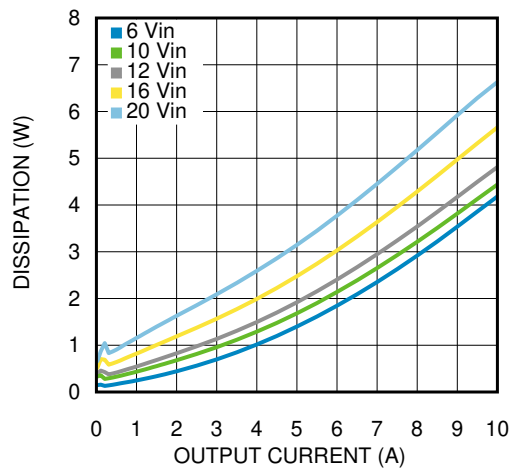

图 6-30. Thermal Derating

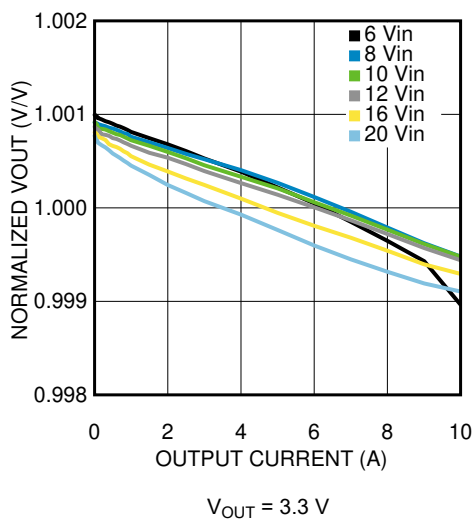

图 6-31. Thermal Derating

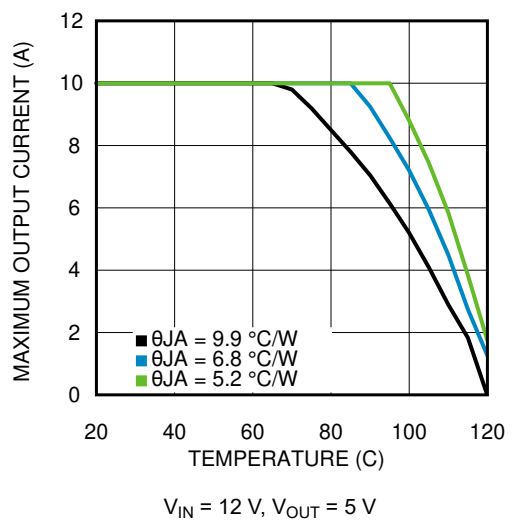

图 6-32.  $R_{\theta JA}$  vs Copper Heat Sinking Area

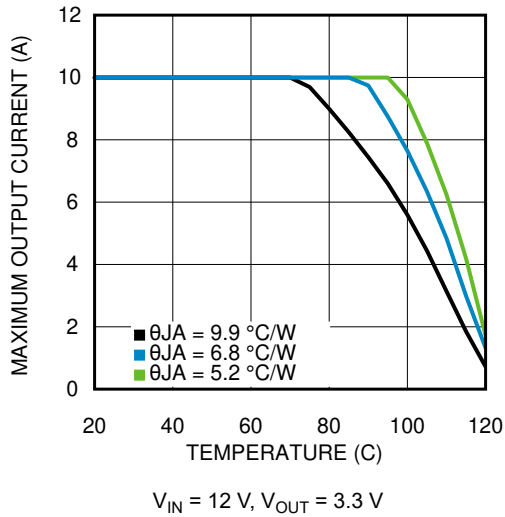

12  $V_{IN}$ , 5  $V_{OUT}$  at Full Load, BW = 20 MHz

图 6-33. Output Ripple

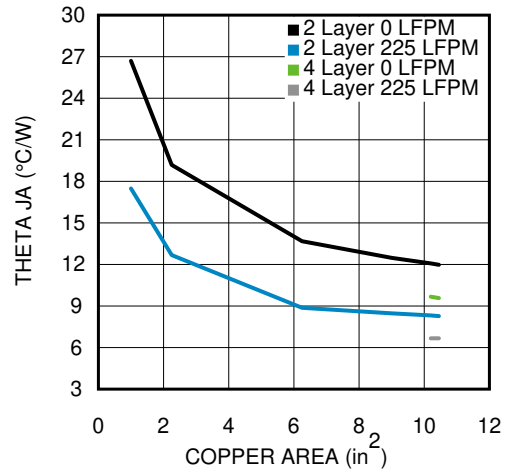
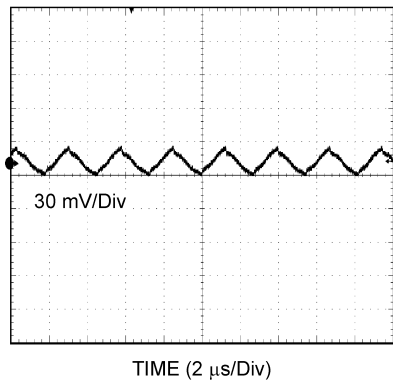
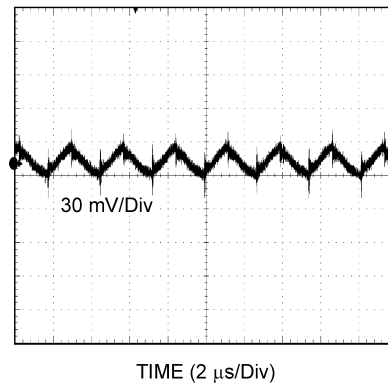

12  $V_{IN}$ , 5  $V_{OUT}$  at Full Load, BW = 250 MHz

图 6-34. Output Ripple

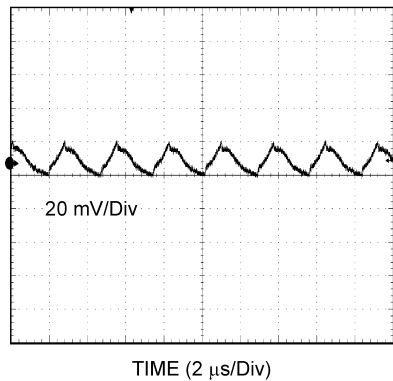

12  $V_{IN}$ , 3.3  $V_{OUT}$  at Full Load, BW = 20 MHz

图 6-35. Output Ripple

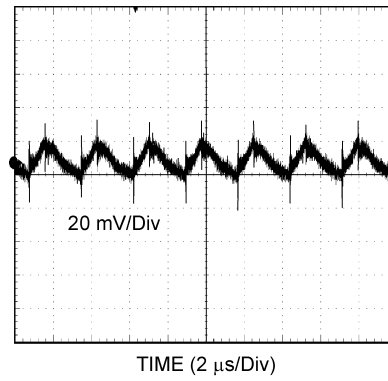

12  $V_{IN}$ , 3.3  $V_{OUT}$  at Full Load, BW = 250 MHz

图 6-36. Output Ripple

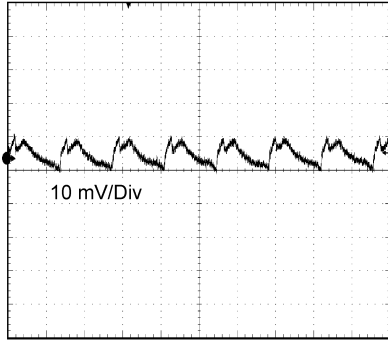

TIME (2  $\mu$ s/Div)

12 V<sub>IN</sub>, 1.2 V<sub>OUT</sub> at Full Load, BW = 20 MHz

**图 6-37. Output Ripple**

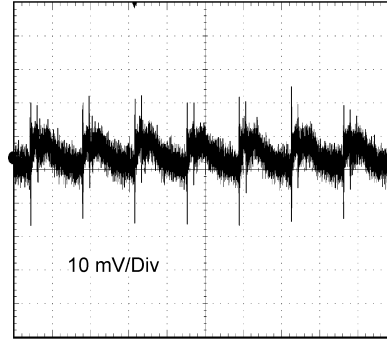

TIME (2  $\mu$ s/Div)

12 V<sub>IN</sub>, 1.2 V<sub>OUT</sub> at Full Load, BW = 250 MHz

**图 6-38. Output Ripple**

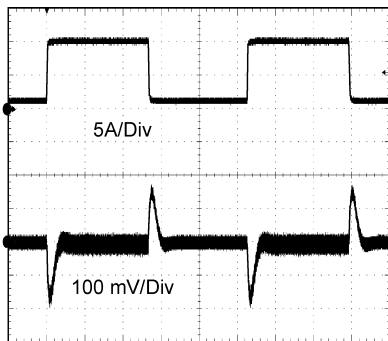

TIME (500  $\mu$ s/Div)

12 V<sub>IN</sub>, 5 V<sub>OUT</sub> 1- to 10-A Step

**图 6-39. Transient Response**

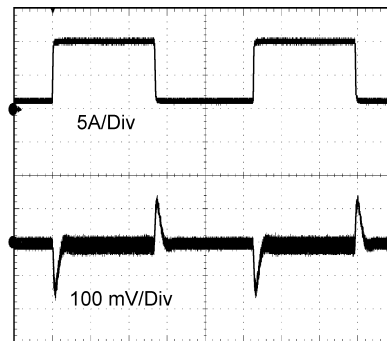

TIME (500  $\mu$ s/Div)

12 V<sub>IN</sub>, 3.3 V<sub>OUT</sub> 1- to 10-A Step

**图 6-40. Transient Response**

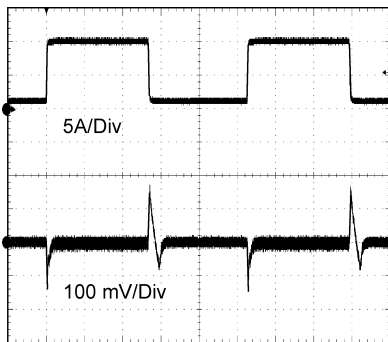

TIME (500  $\mu$ s/Div)

12 V<sub>IN</sub>, 1.2 V<sub>OUT</sub> 1- to 10-A Step

**图 6-41. Transient Response**

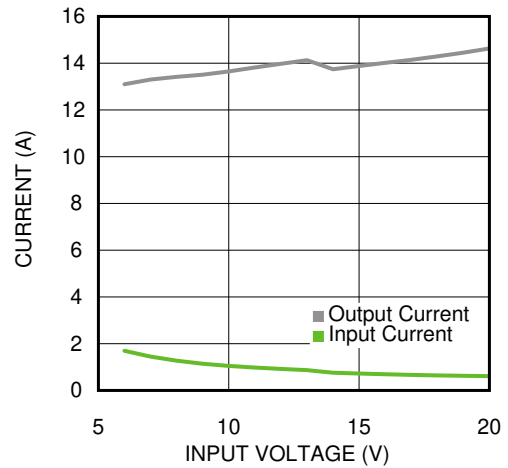

**图 6-42. Short Circuit Current vs Input Voltage**

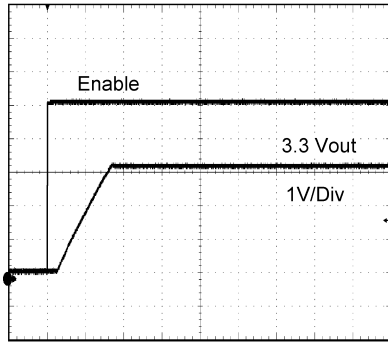

TIME (1 ms/Div)

No  $C_{SS}$

图 6-43. 3.3-V<sub>OUT</sub> Soft Start

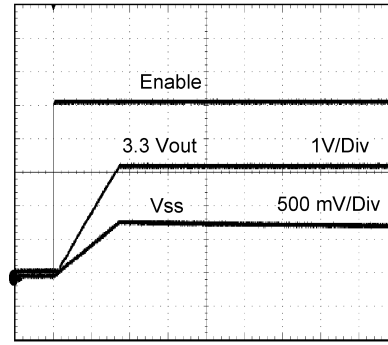

TIME (5 ms/Div)

$C_{SS} = 0.47 \mu\text{F}$

图 6-44. 3.3-V<sub>OUT</sub> Soft Start

## 7 Detailed Description

### 7.1 Overview

The architecture used is an internally compensated emulated peak current mode control, based on a monolithic synchronous SIMPLE SWITCHER core capable of supporting high load currents. The output voltage is maintained through feedback compared with an internal 0.8-V reference. For emulated peak current mode, the valley current is sampled on the down-slope of the inductor current. This is used as the DC value of current to start the next cycle. The primary application for emulated peak current mode is high input voltage to low output voltage operating at a narrow duty cycle. By sampling the inductor current at the end of the switching cycle and adding an external ramp, the minimum on time can be significantly reduced, without the need for blanking or filtering, which is normally required for peak current mode control.

### 7.2 Functional Block Diagram

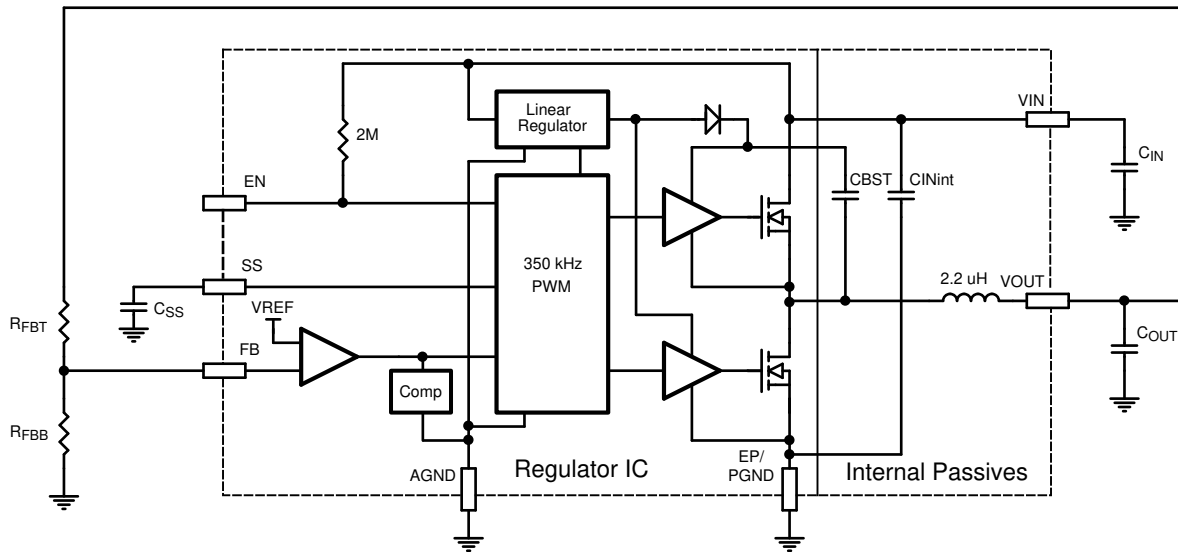

### 7.3 Feature Description

#### 7.3.1 Output Overvoltage Protection

If the voltage at FB is greater than a 0.86-V internal reference, the output of the error amplifier is pulled toward ground, causing  $V_{OUT}$  to fall.

#### 7.3.2 Current Limit

The LMZ12010 is protected by both low-side (LS) and high-side (HS) current limit circuitry. The LS current limit detection is carried out during the off time by monitoring the current through the LS synchronous MOSFET. Referring to the [Functional Block Diagram](#), when the top MOSFET is turned off, the inductor current flows through the load, the PGND pin, and the internal synchronous MOSFET. If this current exceeds 13 A (typical), the current limit comparator disables the start of the next switching period. Switching cycles are prohibited until current drops below the limit.

#### 备注

DC current limit is dependent on duty cycle as illustrated in the graph in [节 6.6](#).

The HS current limit monitors the current of top-side MOSFET. Once HS current limit is detected (16 A typical), the HS MOSFET is shut off immediately until the next cycle. Exceeding HS current limit causes  $V_{OUT}$  to fall. Typical behavior of exceeding LS current limit is that  $f_{SW}$  drops to 1/2 of the operating frequency.

### 7.3.3 Thermal Protection

The junction temperature of the LMZ12010 must not be allowed to exceed its maximum ratings. Thermal protection is implemented by an internal thermal shutdown circuit, which activates at 165°C (typical), causing the device to enter a low power standby state. In this state, the main MOSFET remains off, causing  $V_{OUT}$  to fall, and the  $C_{SS}$  capacitor is discharged to ground. Thermal protection helps prevent catastrophic failures for accidental device overheating. When the junction temperature falls back below 150°C (typical hysteresis = 15°C), the SS pin is released,  $V_{OUT}$  rises smoothly, and normal operation resumes.

Applications requiring maximum output current, especially those at high input voltages, can require additional derating at elevated temperatures.

### 7.3.4 Prebiased Start-Up

The LMZ12010 will properly start up into a prebiased output. This start-up situation is common in multiple rail logic applications where current paths can exist between different power rails during the start-up sequence. [Figure 7-1](#) shows proper behavior in this mode. Trace one is Enable going high. Trace two is 1.8-V prebias rising to 3.3 V. Trace three is the SS voltage with a  $C_{SS} = 0.47 \mu\text{F}$ . Rise time is determined by  $C_{SS}$ .



图 7-1. Prebiased Start-Up

## 7.4 Device Functional Modes

### 7.4.1 Discontinuous Conduction and Continuous Conduction Modes

At light load, the regulator will operate in discontinuous conduction mode (DCM). With load currents above the critical conduction point, it will operate in continuous conduction mode (CCM). When operating in DCM, inductor current is maintained to an average value equaling  $I_{OUT}$ . In DCM, the low-side switch will turn off when the inductor current falls to zero. This causes the inductor current to resonate. Although it is in DCM, the current is allowed to go slightly negative to charge the bootstrap capacitor.

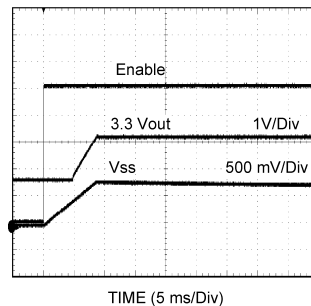
In CCM, current flows through the inductor through the entire switching cycle and never falls to zero during the off time.

图 7-2 is a comparison pair of waveforms showing both the CCM (upper) and DCM operating modes.



图 7-2. CCM and DCM Operating Modes

The approximate formula for determining the DCM/CCM boundary is:

$$I_{DCB} = \frac{(V_{IN} - V_{OUT}) \times D}{2 \times L \times f_{SW}} \quad (1)$$

The inductor internal to the module is 2.2  $\mu$  H. This value was chosen as a good balance between low and high input voltage applications. The main parameter affected by the inductor is the amplitude of the inductor ripple current ( $\Delta i_L$ ).  $\Delta i_L$  can be calculated with:

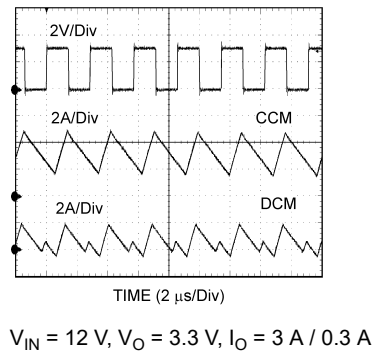
$$\Delta i_L = \frac{(V_{IN} - V_{OUT}) \times D}{L \times f_{SW}} \quad (2)$$

where

- $V_{IN}$  is the maximum input voltage.
- $f_{SW}$  is typically 359 kHz.

If the output current  $I_{OUT}$  is determined by assuming that  $I_{OUT} = I_L$ , the higher and lower peak of  $\Delta i_L$  can be determined.



## 8 Application and Implementation

### 备注

以下应用部分中的信息不属于 TI 器件规格的范围，TI 不担保其准确性和完整性。TI 的客户应负责确定器件是否适用于其应用。客户应验证并测试其设计，以确保系统功能。

### 8.1 Application Information

The LMZ12010 is a step-down DC-to-DC power module. It is typically used to convert a higher DC voltage to a lower DC voltage with a maximum output current of 10 A. The following design procedure can be used to select components for the LMZ12010. Alternately, the WEBENCH software may be used to generate complete designs.

When generating a design, the WEBENCH software utilizes iterative design procedure and accesses comprehensive databases of components. Please go to [www.ti.com](http://www.ti.com) for more details.

### 8.2 Typical Application



图 8-1. Typical Application Schematic Diagram

#### 8.2.1 Design Requirements

For this example, the following application parameters exist.

- $V_{IN}$  range = up to 20 V
- $V_{OUT}$  = 0.8 V to 6 V
- $I_{OUT}$  = 10 A

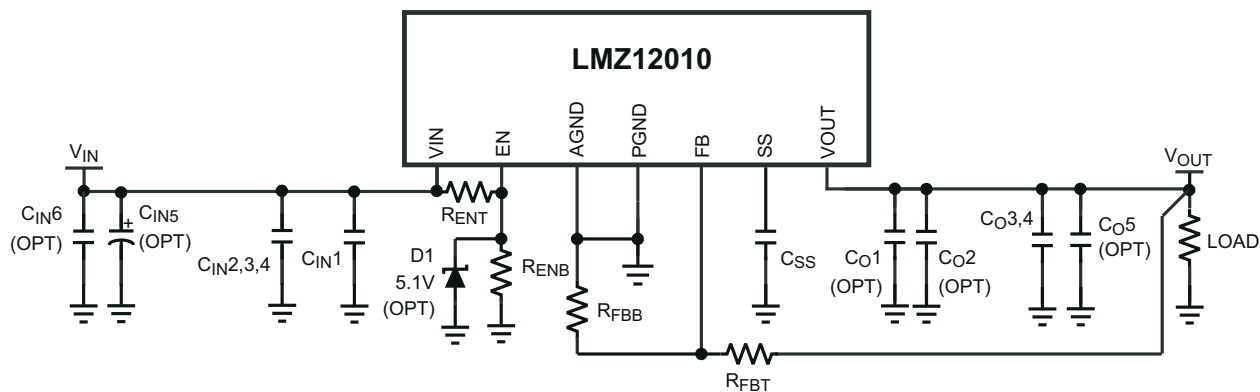
#### 8.2.2 Detailed Design Procedure

The LMZ12010 is fully supported by WEBENCH which offers: component selection, and electrical and thermal simulations. Additionally, there are both evaluation and demonstration boards that can be used as a starting point for design. The following list of steps can be used to manually design the LMZ12010 application.

All references to values refer to the typical applications schematic [图 8-1](#).

1. Select minimum operating  $V_{IN}$  with enable divider resistors.
2. Program  $V_{OUT}$  with FB resistor divider selection.
3. Select  $C_{OUT}$ .
4. Select  $C_{IN}$ .
5. Determine module power dissipation,
6. Lay out PCB for required thermal performance.

### 8.2.2.1 Enable Divider, $R_{ENT}$ , $R_{ENB}$ , and $R_{ENH}$ Selection

Internal to the module is a 2-M $\Omega$  pullup resistor connected from  $V_{IN}$  to Enable. For applications not requiring precision undervoltage lockout (UVLO), the Enable input can be left open circuit and the internal resistor will always enable the module. In such case, the internal UVLO occurs typically at 4.3 V ( $V_{IN}$  rising).

In applications with separate supervisory circuits, Enable can be directly interfaced to a logic source. In the case of sequencing supplies, the divider is connected to a rail that becomes active earlier in the power-up cycle than the LMZ12010 output rail.

Enable provides a precise 1.274-V threshold to allow direct logic drive or connection to a voltage divider from a higher enable voltage such as  $V_{IN}$ . Additionally there is 13  $\mu$ A (typical) of switched offset current, allowing programmable hysteresis.

The function of the enable divider is to allow the designer to choose an input voltage below which the circuit will be disabled. This implements the feature of a programmable UVLO. The two resistors must be chosen based on the following ratio:

$$R_{ENT} / R_{ENB} = (V_{IN\ UVLO} / 1.274\ V) - 1 \quad (3)$$

The LMZ12010 typical application shows 12.7 k $\Omega$  for  $R_{ENB}$  and 42.2 k $\Omega$  for  $R_{ENT}$ , resulting in a rising UVLO of 5.51 V. Note that this divider presents 4.62 V to the EN input when  $V_{IN}$  is raised to 20 V. This upper voltage must always be checked, making sure that it never exceeds the absolute maximum 5.5-V limit for Enable. A 5.1-V Zener clamp can be applied in cases where the upper voltage would exceed the range of operation for the EN input. The Zener clamp is not required if the target application prohibits the maximum Enable input voltage from being exceeded.

Additional enable voltage hysteresis can be added with the inclusion of  $R_{ENH}$ . It is possible to select values for  $R_{ENT}$  and  $R_{ENB}$  such that  $R_{ENH}$  is a value of zero allowing it to be omitted from the design.

Rising threshold can be calculated as follows:

$$V_{EN(\text{rising})} = 1.274 ( 1 + (R_{ENT} || 2\ \text{meg}) / R_{ENB} ) \quad (4)$$

Whereas the falling threshold level can be calculated using:

$$V_{EN(\text{falling})} = V_{EN(\text{rising})} - 13\ \mu\text{A} ( R_{ENT} || 2\ \text{meg} || R_{ENTB} + R_{ENH} ) \quad (5)$$



图 8-2. Enable Input Detail

### 8.2.2.2 Output Voltage Selection

Output voltage is determined by a divider of two resistors connected between  $V_{OUT}$  and AGND. The midpoint of the divider is connected to the FB input.

The regulated output voltage determined by the external divider resistors,  $R_{FBT}$  and  $R_{FBB}$ , is:

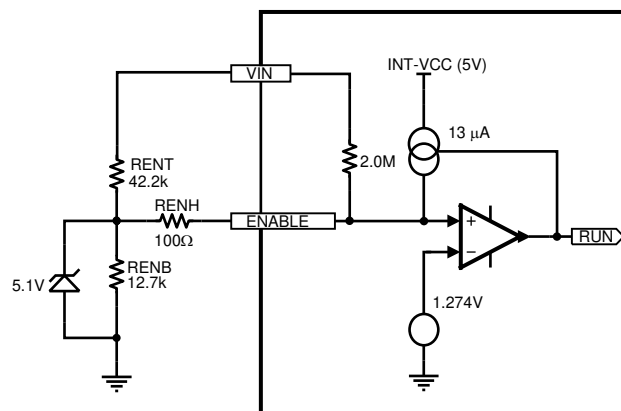
$$V_{OUT} = 0.795 \text{ V} \times (1 + R_{FBT} / R_{FBB}) \quad (6)$$

Rearranging terms, the ratio of the feedback resistors for a desired output voltage is:

$$R_{FBT} / R_{FBB} = (V_{OUT} / 0.795 \text{ V}) - 1 \quad (7)$$

These resistors must generally be chosen from values in the range of 1.0 kΩ to 10.0 kΩ.

For  $V_{OUT} = 0.8 \text{ V}$ , the FB pin can be connected to the output directly and  $R_{FBB}$  can be set to 8.06 kΩ to provide minimum output load.

表 8-1 lists the values for  $R_{FBT}$ , and  $R_{FBB}$ .

**表 8-1. Typical Application Bill of Materials**

Ref Des	Description	Case Size	Manufacturer	Manufacturer P/N
U1	SIMPLE SWITCHER	PFM-11	Texas Instruments	LMZ12010TZ
$C_{IN1,6}$ (OPT)	0.047 μF, 50 V, X7R	1206	Yageo America	CC1206KRX7R9BB473
$C_{IN2,3,4}$	10 μF, 50 V, X7R	1210	Taiyo Yuden	UMK325BJ106MM-T
$C_{IN5}$ (OPT)	CAP, AL, 150 μF, 50 V	Radial G	Panasonic	EEE-FK1H151P
$C_{O1,5}$ (OPT)	0.047 μF, 50 V, X7R	1206	Yageo America	CC1206KRX7R9BB473
$C_{O2}$ (OPT)	47 μF, 10 V, X7R	1210	Murata	GRM32ER61A476KE20L
$C_{O3,4}$	330 μF, 6.3 V, 0.015 Ω	CAPSMT_6_UE	Kemet	T520D337M006ATE015
$R_{FBT}$	3.32 kΩ	0805	Panasonic	ERJ-6ENF3321V
$R_{FBB}$	1.07 kΩ	0805	Panasonic	ERJ-6ENF1071V
$R_{ENT}$	42.2 kΩ	0805	Panasonic	ERJ-6ENF4222V
$R_{ENB}$	12.7 kΩ	0805	Panasonic	ERJ-6ENF1272V
$C_{SS}$	0.47 μF, ±10%, X7R, 16 V	0805	AVX	0805YC474KAT2A
D1 (OPT)	5.1 V, 0.5 W	SOD-123	Diodes Inc.	MMSZ5231BS-7-F

### 8.2.2.3 Soft-Start Capacitor Selection

Programmable soft start permits the regulator to slowly ramp to its steady-state operating point after being enabled, thereby reducing current inrush from the input supply and slowing the output voltage rise time.

Upon turn-on, after all UVLO conditions have been passed, an internal 1.6-ms circuit slowly ramps the SS input to implement internal soft start. If 1.6 ms is an adequate turn-on time, then the  $C_{SS}$  capacitor can be left unpopulated. Longer soft-start periods are achieved by adding an external capacitor to this input.

Soft-start duration is given by the formula:

$$t_{SS} = V_{REF} \times C_{SS} / I_{SS} = 0.795 \text{ V} \times C_{SS} / 50 \mu\text{A} \quad (8)$$

This equation can be rearranged as follows:

$$C_{SS} = t_{SS} \times 50 \mu\text{A} / 0.795 \text{ V} \quad (9)$$

Using a 0.22-μF capacitor results in 3.5-ms typical soft-start duration and 0.47 μF results in 7.5 ms typical. 0.47 μF is a recommended initial value.

As the soft-start input exceeds 0.795 V, the output of the power stage will be in regulation and the 50-μA current is deactivated. Note that the following conditions will reset the soft-start capacitor by discharging the SS input to ground with an internal current sink.

- The Enable input being *pulled low*
- A thermal shutdown condition

- $V_{IN}$  falling below 4.3 V (typical) and triggering the  $V_{CC}$  UVLO

### 8.2.2.4 Tracking Supply Divider Option

The tracking function allows the module to be connected as a slave supply to a primary voltage rail (often the 3.3-V system rail) where the slave module output voltage is lower than that of the master. Proper configuration allows the slave rail to power up coincident with the master rail such that the voltage difference between the rails during ramp-up is small (that is, < 0.15 V typical). The values for the tracking resistive divider must be selected such that the effect of the internal 50- $\mu$ A current source is minimized. In most cases, the ratio of the tracking divider resistors is the same as the ratio of the output voltage setting divider. Proper operation in tracking mode dictates the soft-start time of the slave rail be shorter than the master rail; a condition that is easy to satisfy because the  $C_{SS}$  capacitor is replaced by  $R_{TKB}$ . The tracking function is only supported for the power-up interval of the master supply; once the SS/TRK rises past 0.795 V, the input is no longer enabled and the 50- $\mu$ A internal current source is switched off.



图 8-3. Tracking Option Input Detail

### 8.2.2.5 $C_{OUT}$ Selection

None of the required  $C_{OUT}$  output capacitance is contained within the module. A minimum value ranging from 330  $\mu$ F for 6  $V_{OUT}$  to 660  $\mu$ F for 1.2- $V_{OUT}$  applications is required based on the values of internal compensation in the error amplifier. These minimum values can be decreased if the effective capacitor ESR is higher than 15  $m\Omega$ .

A low-ESR (15  $m\Omega$ ) tantalum, organic semiconductor or specialty polymer capacitor types in parallel with a 47-nF X7R ceramic capacitor for high-frequency noise reduction is recommended for obtaining lowest ripple. The output capacitor  $C_{OUT}$  can consist of several capacitors in parallel placed in close proximity to the module. The output voltage ripple of the module depends on the equivalent series resistance (ESR) of the capacitor bank, and can be calculated by multiplying the ripple current of the module by the effective impedance of your chosen output capacitors. Electrolytic capacitors will have large ESR and lead to larger output ripple than ceramic or polymer types. For this reason, a combination of ceramic and polymer capacitors is recommended for low output ripple performance.

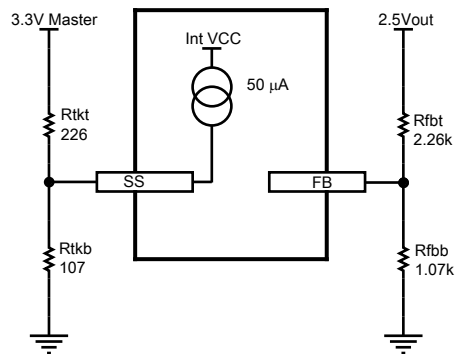
The output capacitor assembly must also meet the worst case ripple current rating of  $\Delta I_L$ . Loop response verification is also valuable to confirm closed loop behavior.

For applications with dynamic load steps; 方程式 10 provides a good first pass approximation of  $C_{OUT}$  for load transient requirements.

$$C_{OUT} \geq \frac{I_{STEP}}{(\Delta V_{OUT} - I_{STEP} \times ESR) \times \left(\frac{f_{SW}}{V_{OUT}}\right)} \quad (10)$$

For 12  $V_{IN}$ , 3.3  $V_{OUT}$ , a transient voltage of 5% of  $V_{OUT} = 0.165$  V ( $\Delta V_{OUT}$ ), a 9-A load step ( $I_{STEP}$ ), an output capacitor effective ESR of 3  $m\Omega$ , and a switching frequency of 350 kHz ( $f_{SW}$ ):

$$C_{OUT} \geq \frac{9A}{(0.165V - 9A \times 0.003) \times \left(\frac{350e3}{3.3V}\right)} \geq 615 \mu F \quad (11)$$

**备注**

The stability requirement for minimum output capacitance must always be met.

One recommended output capacitor combination is two 330- $\mu$ F, 15-m $\Omega$  ESR tantalum polymer capacitors connected in parallel with a 47- $\mu$ F 6.3-V X5R ceramic. This combination provides excellent performance that can exceed the requirements of certain applications. Additionally some small 47-nF ceramic capacitors can be used for high-frequency EMI suppression.

**8.2.2.6  $C_{IN}$  Selection**

The LMZ12010 module contains two internal ceramic input capacitors. Additional input capacitance is required external to the module to handle the input ripple current of the application. The input capacitor can be several capacitors in parallel. This input capacitance must be located in very close proximity to the module. Input capacitor selection is generally directed to satisfy the input ripple current requirements rather than by capacitance value. Input ripple current rating is dictated by [方程式 12](#):

$$I_{CIN-RMS} = I_{OUT} \times \sqrt{D(1-D)} \quad (12)$$

where

- $D \cong V_{OUT} / V_{IN}$

As a point of reference, the worst case ripple current will occur when the module is presented with full load current and when  $V_{IN} = 2 \times V_{OUT}$ .

Recommended minimum input capacitance is 30- $\mu$ F X7R (or X5R) ceramic with a voltage rating at least 25% higher than the maximum applied input voltage for the application. TI also recommends to pay attention to the voltage and temperature derating of the capacitor selected.

**备注**

Ripple current rating of ceramic capacitors may be missing from the capacitor data sheet and the user may have to contact the capacitor manufacturer for this parameter.

If the system design requires a certain minimum value of peak-to-peak input ripple voltage ( $\Delta V_{IN}$ ) to be maintained then [方程式 13](#) may be used.

$$C_{IN} \geq \frac{I_{OUT} \times D \times (1 - D)}{f_{SW} \times \Delta V_{IN}} \quad (13)$$

If  $\Delta V_{IN}$  is 200 mV or 1.66% of  $V_{IN}$  for a 12-V input to 3.3-V output application and  $f_{SW} = 350$  kHz then:

$$C_{IN} \geq \frac{10A \times \left(\frac{3.3V}{12V}\right) \times \left(1 - \frac{3.3V}{12V}\right)}{350 \text{ kHz} \times 200 \text{ mV}} \geq 28 \mu F \quad (14)$$

Additional bulk capacitance with higher ESR can be required to damp any resonant effects of the input capacitance and parasitic inductance of the incoming supply lines. The LMZ12010 typical applications schematic

and evaluation board include a 150-  $\mu$ F 50-V aluminum capacitor for this function. There are many situations where this capacitor is not necessary.

### 8.2.3 Application Curves

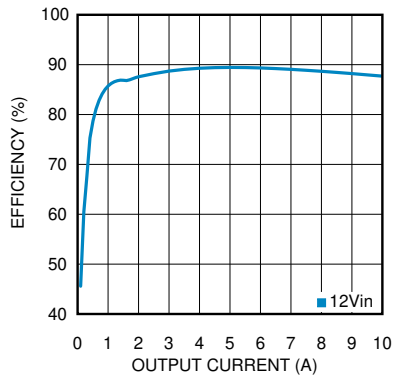

$V_{IN} = 12\text{ V}, V_{OUT} = 3.3\text{ V}$

图 8-4. Efficiency

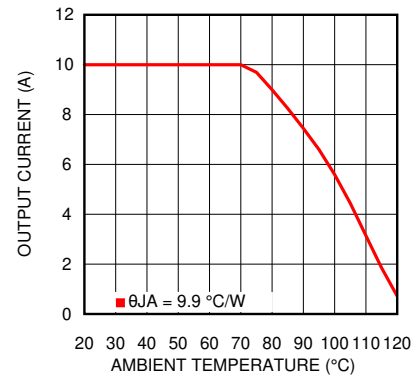

$V_{IN} = 12\text{ V}, V_{OUT} = 3.3\text{ V}$

图 8-5. Thermal Derating Curve

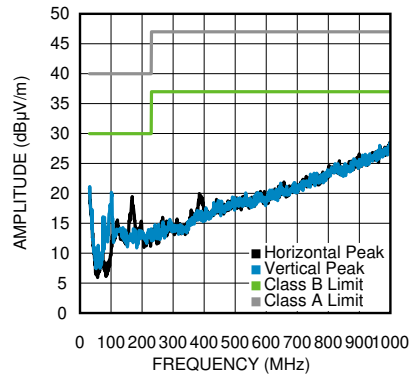

$V_{IN} = 12\text{ V}, V_{OUT} = 5\text{ V}, I_{OUT} = 10\text{ A}$

图 8-6. Radiated EMI (EN 55022)

## 9 Power Supply Recommendations

The LMZ12010 device is designed to operate from an input voltage supply range between 6 V and 20 V. This input supply must be well regulated and able to withstand maximum input current and maintain a stable voltage. The resistance of the input supply rail must be low enough that an input current transient does not cause a high enough drop at the LMZ12010 supply voltage that can cause a false UVLO fault triggering and system reset. If the input supply is more than a few inches from the LMZ12010, additional bulk capacitance can be required in addition to the ceramic bypass capacitors. The amount of bulk capacitance is not critical, but a 47-  $\mu$ F or 100-  $\mu$ F electrolytic capacitor is a typical choice.



## 10 Layout

### 10.1 Layout Guidelines

PCB layout is an important part of DC-DC converter design. Poor board layout can disrupt the performance of a DC-DC converter and surrounding circuitry by contributing to EMI, ground bounce and resistive voltage drop in the traces. These can send erroneous signals to the DC-DC converter resulting in poor regulation or instability. Good layout can be implemented by following a few simple design rules. A good layout example is shown in [节 10.2](#).

- **Minimize area of switched current loops.**

From an EMI reduction standpoint, it is imperative to minimize the high di/dt paths during PCB layout. The high current loops that do not overlap have high di/dt content that will cause observable high frequency noise on the output pin if the input capacitor ( $C_{IN}$ ) is placed at a distance away from the LMZ12010. Therefore place  $C_{IN}$  as close as possible to the LMZ12010  $V_{IN}$  and PGND exposed pad. This will minimize the high di/dt area and reduce radiated EMI. Additionally, grounding for both the input and output capacitor must consist of a localized top side plane that connects to the PGND exposed pad (EP).

- **Have a single point ground.**

The ground connections for the feedback, soft-start, and enable components must be routed to the AGND pin of the device. This prevents any switched or load currents from flowing in the analog ground traces. If not properly handled, poor grounding can result in degraded load regulation or erratic output voltage ripple behavior. Additionally provide a single point ground connection from pin 4 (AGND) to EP/PGND.

- **Minimize trace length to the FB pin.**

Both feedback resistors,  $R_{FBT}$  and  $R_{FBB}$  must be located close to the FB pin. Because the FB node is high impedance, maintain the copper area as small as possible. The traces from  $R_{FBT}$ ,  $R_{FBB}$  must be routed away from the body of the LMZ12010 to minimize possible noise pickup.

- **Make input and output bus connections as wide as possible.**

This reduces any voltage drops on the input or output of the converter and maximizes efficiency. To optimize voltage accuracy at the load, ensure that a separate feedback voltage sense trace is made to the load. Doing so will correct for voltage drops and provide optimum output accuracy.

- **Provide adequate device heat-sinking.**

Use an array of heat-sinking vias to connect the exposed pad to the ground plane on the bottom PCB layer. If the PCB has multiple copper layers, these thermal vias can also be connected to inner layer heat-spreading ground planes. For best results use a  $10 \times 10$  via array or larger with a minimum via diameter of 8 mil thermal vias spaced 46.8 mil (1.5 mm). Ensure enough copper area is used for heat-sinking to keep the junction temperature below  $125^{\circ}\text{C}$ .

### 10.2 Layout Examples



图 10-1. Critical Current Loops to Minimize



图 10-2. PCB Layout Guide

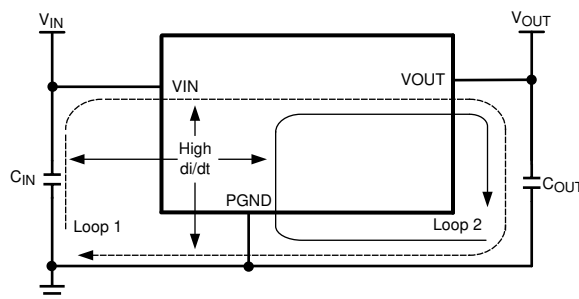

图 10-3. Top View of Evaluation PCB

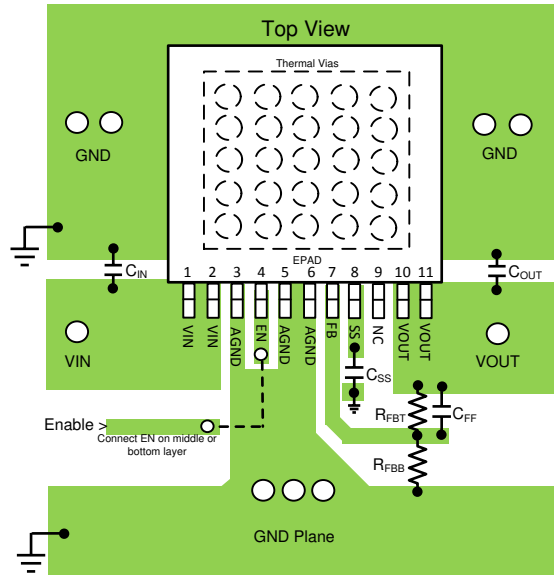

图 10-4. Bottom View of Evaluation PCB

### 10.3 Power Dissipation and Thermal Considerations

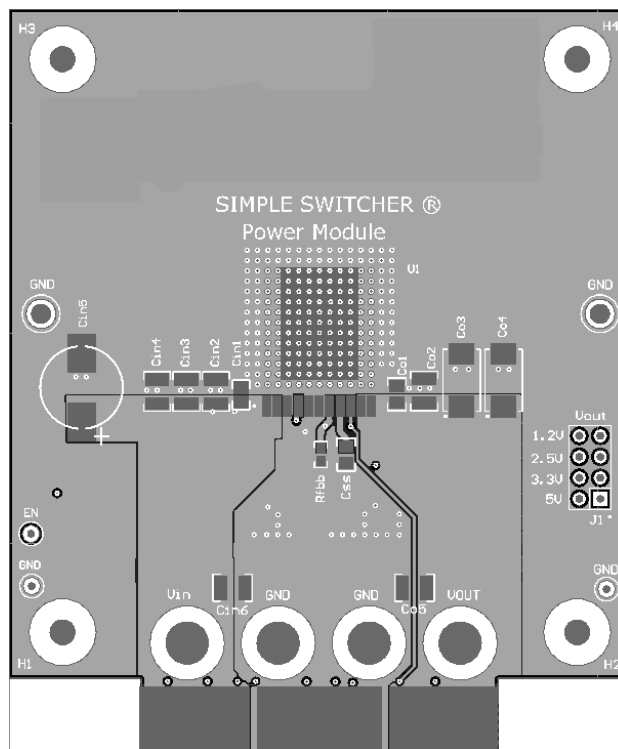
When calculating module dissipation, use the maximum input voltage and the average output current for the application. Many common operating conditions are provided in the characteristic curves such that less common applications can be derived through interpolation. In all designs, the junction temperature must be kept below the rated maximum of 125°C.

For the design case of  $V_{IN} = 12\text{ V}$ ,  $V_{OUT} = 3.3\text{ V}$ ,  $I_{OUT} = 10\text{ A}$ , and  $T_{A-MAX} = 50^\circ\text{C}$ , the module must see a thermal resistance from case to ambient ( $\theta_{CA}$ ) of less than:

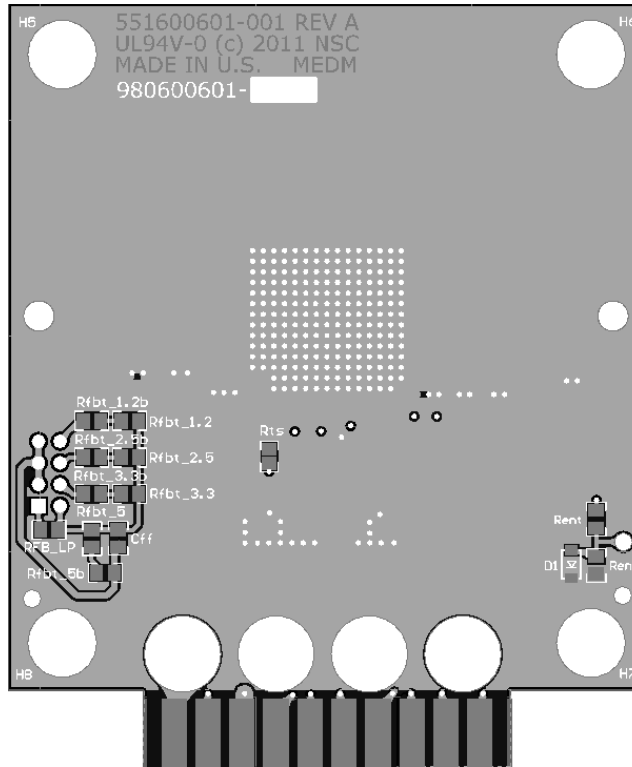
$$\theta_{CA} < \frac{T_{J-MAX} - T_{A-MAX}}{P_{IC\_LOSS}} - \theta_{JC} \quad (15)$$

Given the typical thermal resistance from junction to case ( $\theta_{JC}$ ) to be 1.0°C/W. Use the 85°C power dissipation curves in 节 6.6 to estimate the  $P_{IC\_LOSS}$  for the application being designed. In this application it is 5.3 W.

$$\theta_{CA} < \frac{125^\circ\text{C} - 50^\circ\text{C}}{5.3\text{ W}} - 1.0 \frac{^\circ\text{C}}{\text{W}} < 13.15 \frac{^\circ\text{C}}{\text{W}} \quad (16)$$

To reach  $\theta_{CA} = 13.15$ , the PCB is required to dissipate heat effectively. With no airflow and no external heat-sink, a good estimate of the required board area covered by 2-oz. copper on both the top and bottom metal layers is:

$$\text{Board Area}_{\text{cm}^2} \geq \frac{500}{\theta_{CA}} \cdot \frac{^\circ\text{C} \times \text{cm}^2}{\text{W}} \quad (17)$$

As a result, approximately 38.02 square cm of 2-oz. copper on top and bottom layers is the minimum required area for the example PCB design. This is a 6.16-cm × 6.16-cm (2.42-in × 2.42-in) square. The PCB copper heat

sink must be connected to the exposed pad. For best performance, use approximately 100 8-mil thermal vias spaced 59 mil (1.5 mm) apart connect the top copper to the bottom copper.

Another way to estimate the temperature rise of a design is using  $\theta_{JA}$ . An estimate of  $\theta_{JA}$  for varying heat sinking copper areas and airflows can be found in the typical applications curves. If our design required the same operating conditions as before but had 225 LFPM of airflow. The required  $\theta_{JA}$  is located:

$$\theta_{JA} < \frac{T_{J-MAX} - T_{A-MAX}}{P_{IC\_LOSS}}$$

$$\theta_{JA} < \frac{(125 - 50) \text{ }^{\circ}\text{C}}{5.3 \text{ W}} < 14.15 \frac{\text{ }^{\circ}\text{C}}{\text{W}} \tag{18}$$

On the  $\theta_{JA}$  vs copper heatsinking curve, the copper area required for this application is now only two square inches. The airflow reduced the required heat sinking area by a factor of three.

To reduce the heat sinking copper area further, this package is compatible with D3-PAK surface mount heat sinks.

For an example of a high thermal performance PCB layout for SIMPLE SWITCHER power modules, refer to the following:

- [AN-2093 LMZ23610/8/6 and LMZ22010/8/6 Current Sharing Evaluation Board](#) user's guide
- [AN-2084 LMZ1420xEXT / LMZ1200xEXT Evaluation Board](#) user's guide
- [Step-Down DC-DC Converter with Integrated Low Dropout Regulator and Startup Mode](#) data sheet
- [AN-2020 Thermal Design By Insight, Not Hindsight](#) application report
- [AN-2026 Effect of PCB Design on Thermal Performance of SIMPLE SWITCHER Modules](#) application report

#### 10.4 Power Module SMT Guidelines

The recommendations below are for a standard module surface mount assembly

- Land Pattern — Follow the PCB land pattern with either soldermask defined or non-soldermask defined pads.
- Stencil Aperture
  - For the exposed die attach pad (DAP), adjust the stencil for approximately 80% coverage of the PCB land pattern.
  - For all other I/O pads, use a 1:1 ratio between the aperture and the land pattern recommendation.
- Solder Paste — Use a standard SAC Alloy such as SAC 305, type 3 or higher.
- Stencil Thickness — 0.125 to 0.15 mm
- Reflow — Refer to solder paste supplier recommendation and optimized per board size and density.
- Refer to the [Design Summary LMZ1xxx and LMZ2xxx Power Modules Family](#) application report for reflow information.
- Maximum number of reflows allowed is one.



图 10-5. Sample Reflow Profile

表 10-1. Sample Reflow Profile Table

Probe	Max Temp (°C)	Reached Max Temp	Time Above 235°C	Reached 235°C	Time Above 245°C	Reached 245°C	Time Above 260°C	Reached 260°C
1	242.5	6.58	0.49	6.39	0.00	—	0.00	—
2	242.5	7.10	0.55	6.31	0.00	7.10	0.00	—
3	241.0	7.09	0.42	6.44	0.00	—	0.00	—

## 11 Device and Documentation Support

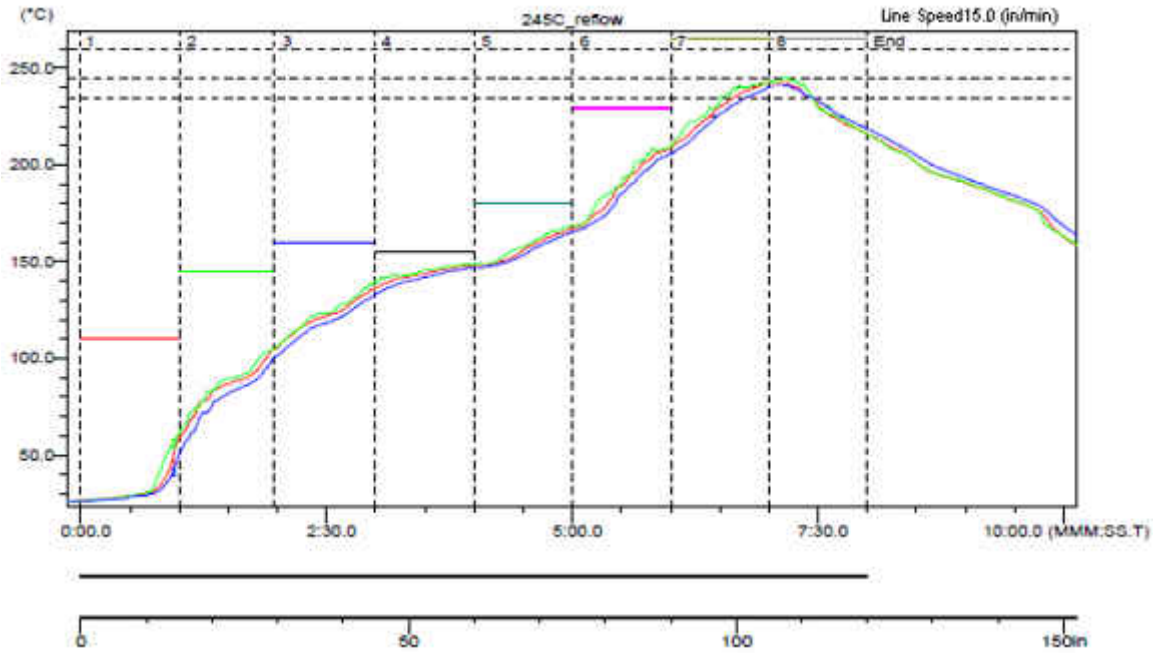
### 11.1 Device Support

#### 11.1.1 第三方产品免责声明

TI 发布的与第三方产品或服务有关的信息，不能构成与此类产品或服务或保修的适用性有关的认可，不能构成此类产品或服务单独或与任何 TI 产品或服务一起的表示或认可。

#### 11.1.2 Development Support

For developmental support, see the following:

WEBENCH Tool, <http://www.ti.com/webench>

### 11.2 Documentation Support

#### 11.2.1 Related Documentation

For related documentation, see the following:

- Texas Instruments, [Inverting Application for the LMZ14203 SIMPLE SWITCHER Power Module](#) application report
- Texas Instruments, [Absolute Maximum Ratings for Soldering](#) application report
- Texas Instruments, [LMZ1420x / LMZ1200x Evaluation Board](#) application report
- Texas Instruments, [LMZ23605/03, LMZ22005/03 Evaluation Board](#) application report
- Texas Instruments, [Evaluation Board for LM10000 - PowerWise AVS System Controller](#) application report
- Texas Instruments, [Thermal Design By Insight, Not Hindsight](#) application report
- Texas Instruments, [LMZ23610/8/6 and LMZ22010/8/6 Current Sharing Evaluation Board](#) application report
- Texas Instruments, [LMZ23605/03, LMZ22005/03 Demonstration Board](#) data sheet
- Texas Instruments, [Effect of PCB Design on Thermal Performance of SIMPLE SWITCHER Power Modules](#) application report
- Texas Instruments, [Design Summary LMZ1xxx and LMZ2xxx Power Modules Family](#) application report

### 11.3 支持资源

**TI E2E™ 支持论坛**是工程师的重要参考资料，可直接从专家获得快速、经过验证的解答和设计帮助。搜索现有解答或提出自己的问题可获得所需的快速设计帮助。

链接的内容由各个贡献者“按原样”提供。这些内容并不构成 TI 技术规范，并且不一定反映 TI 的观点；请参阅 TI 的《使用条款》。

### 11.4 接收文档更新通知

要接收文档更新通知，请导航至 [ti.com](http://ti.com) 上的器件产品文件夹。点击 [订阅更新](#) 进行注册，即可每周接收产品信息更改摘要。有关更改的详细信息，请查看任何已修订文档中包含的修订历史记录。

### 11.5 Trademarks

TI E2E™ is a trademark of Texas Instruments.

WEBENCH® and SIMPLE SWITCHER® are registered trademarks of Texas Instruments.

所有商标均为其各自所有者的财产。

### 11.6 Electrostatic Discharge Caution



This integrated circuit can be damaged by ESD. Texas Instruments recommends that all integrated circuits be handled with appropriate precautions. Failure to observe proper handling and installation procedures can cause damage.

ESD damage can range from subtle performance degradation to complete device failure. Precision integrated circuits may be more susceptible to damage because very small parametric changes could cause the device not to meet its published specifications.

### 11.7 术语表

#### TI 术语表

本术语表列出并解释了术语、首字母缩略词和定义。

## 12 Mechanical, Packaging, and Orderable Information

The following pages include mechanical, packaging, and orderable information. This information is the most current data available for the designated devices. This data is subject to change without notice and revision of this document. For browser-based versions of this data sheet, refer to the left-hand navigation.

**PACKAGING INFORMATION**

Orderable Device	Status (1)	Package Type	Package Drawing	Pins	Package Qty	Eco Plan (2)	Lead finish/ Ball material (6)	MSL Peak Temp (3)	Op Temp (°C)	Device Marking (4/5)	Samples
LMZ12010TZ/NOPB	ACTIVE	PFM	NDY	11	32	RoHS & Green	SN	Level-3-245C-168 HR	-40 to 85	LMZ12010	<a href="#">Samples</a>
LMZ12010TZE/NOPB	ACTIVE	PFM	NDY	11	250	RoHS & Green	SN	Level-3-245C-168 HR	-40 to 85	LMZ12010	<a href="#">Samples</a>

(1) The marketing status values are defined as follows:

**ACTIVE:** Product device recommended for new designs.

**LIFEBUY:** TI has announced that the device will be discontinued, and a lifetime-buy period is in effect.

**NRND:** Not recommended for new designs. Device is in production to support existing customers, but TI does not recommend using this part in a new design.

**PREVIEW:** Device has been announced but is not in production. Samples may or may not be available.

**OBSOLETE:** TI has discontinued the production of the device.

(2) **RoHS:** TI defines "RoHS" to mean semiconductor products that are compliant with the current EU RoHS requirements for all 10 RoHS substances, including the requirement that RoHS substance do not exceed 0.1% by weight in homogeneous materials. Where designed to be soldered at high temperatures, "RoHS" products are suitable for use in specified lead-free processes. TI may reference these types of products as "Pb-Free".

**RoHS Exempt:** TI defines "RoHS Exempt" to mean products that contain lead but are compliant with EU RoHS pursuant to a specific EU RoHS exemption.

**Green:** TI defines "Green" to mean the content of Chlorine (Cl) and Bromine (Br) based flame retardants meet JS709B low halogen requirements of <=1000ppm threshold. Antimony trioxide based flame retardants must also meet the <=1000ppm threshold requirement.

(3) MSL, Peak Temp. - The Moisture Sensitivity Level rating according to the JEDEC industry standard classifications, and peak solder temperature.

(4) There may be additional marking, which relates to the logo, the lot trace code information, or the environmental category on the device.

(5) Multiple Device Markings will be inside parentheses. Only one Device Marking contained in parentheses and separated by a "~" will appear on a device. If a line is indented then it is a continuation of the previous line and the two combined represent the entire Device Marking for that device.

(6) Lead finish/Ball material - Orderable Devices may have multiple material finish options. Finish options are separated by a vertical ruled line. Lead finish/Ball material values may wrap to two lines if the finish value exceeds the maximum column width.

**Important Information and Disclaimer:**The information provided on this page represents TI's knowledge and belief as of the date that it is provided. TI bases its knowledge and belief on information provided by third parties, and makes no representation or warranty as to the accuracy of such information. Efforts are underway to better integrate information from third parties. TI has taken and continues to take reasonable steps to provide representative and accurate information but may not have conducted destructive testing or chemical analysis on incoming materials and chemicals. TI and TI suppliers consider certain information to be proprietary, and thus CAS numbers and other limited information may not be available for release.

In no event shall TI's liability arising out of such information exceed the total purchase price of the TI part(s) at issue in this document sold by TI to Customer on an annual basis.





**TAPE AND REEL INFORMATION**

**QUADRANT ASSIGNMENTS FOR PIN 1 ORIENTATION IN TAPE**

\*All dimensions are nominal

Device	Package Type	Package Drawing	Pins	SPQ	Reel Diameter (mm)	Reel Width W1 (mm)	A0 (mm)	B0 (mm)	K0 (mm)	P1 (mm)	W (mm)	Pin1 Quadrant
LMZ12010TZE/NOPB	PFM	NDY	11	250	330.0	32.4	15.45	18.34	6.2	20.0	32.0	Q2

**TAPE AND REEL BOX DIMENSIONS**

\*All dimensions are nominal

Device	Package Type	Package Drawing	Pins	SPQ	Length (mm)	Width (mm)	Height (mm)
LMZ12010TZE/NOPB	PFM	NDY	11	250	367.0	367.0	55.0

**TUBE**



\*All dimensions are nominal

Device	Package Name	Package Type	Pins	SPQ	L (mm)	W (mm)	T (μm)	B (mm)
LMZ12010TZ/NOPB	NDY	TO-PMOD	11	32	502	22	7500	13.1

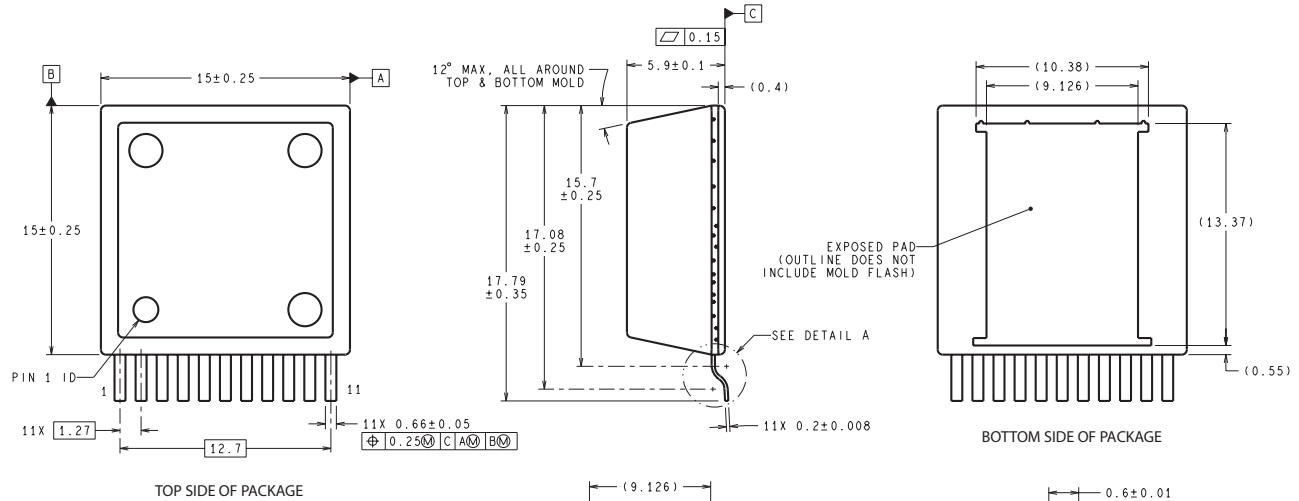
NDY0011A

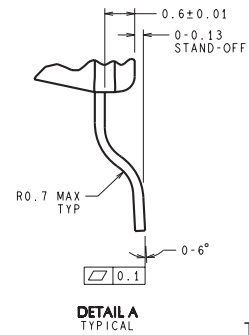
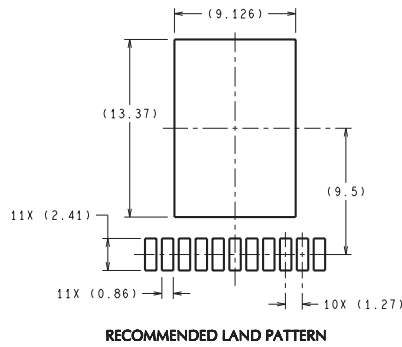

DIMENSIONS ARE IN MILLIMETERS  
DIMENSIONS IN ( ) FOR REFERENCE ONLY



TZA11A (Rev F)

## 重要声明和免责声明

TI“按原样”提供技术和可靠性数据（包括数据表）、设计资源（包括参考设计）、应用或其他设计建议、网络工具、安全信息和其他资源，不保证没有瑕疵且不做任何明示或暗示的担保，包括但不限于对适销性、某特定用途方面的适用性或不侵犯任何第三方知识产权的暗示担保。

这些资源可供使用 TI 产品进行设计的熟练开发人员使用。您将自行承担以下全部责任：(1) 针对您的应用选择合适的 TI 产品，(2) 设计、验证并测试您的应用，(3) 确保您的应用满足相应标准以及任何其他功能安全、信息安全、监管或其他要求。

这些资源如有变更，恕不另行通知。TI 授权您仅可将这些资源用于研发本资源所述的 TI 产品的应用。严禁对这些资源进行其他复制或展示。您无权使用任何其他 TI 知识产权或任何第三方知识产权。您应全额赔偿因在这些资源的使用中对 TI 及其代表造成的任何索赔、损害、成本、损失和债务，TI 对此概不负责。

TI 提供的产品受 [TI 的销售条款](#) 或 [ti.com](#) 上其他适用条款/TI 产品随附的其他适用条款的约束。TI 提供这些资源并不会扩展或以其他方式更改 TI 针对 TI 产品发布的适用的担保或担保免责声明。

TI 反对并拒绝您可能提出的任何其他或不同的条款。

邮寄地址：Texas Instruments, Post Office Box 655303, Dallas, Texas 75265

Copyright © 2022，德州仪器 (TI) 公司