

具有关断功能的 LP295x 100mA、30V 可调节电压稳压器

1 特性

- 宽输入电压范围
 - V_{IN} 范围：2V 至 30V
- 宽输出电压范围 V_{OUT}
 - 固定电压：3V (旧芯片)、3.3V、5.0V
 - 可调节电压：1.2V 至 29V
- 输出电流：100mA
- V_{OUT} 精度：
 - 根据线路、负载和温度 $\pm 2\%$ (旧芯片)
 - 根据线路、负载和温度 $\pm 1\%$ (新芯片)
- 静态电流 I_Q (新芯片)：50 μ A (典型值)
- 低压降 (新芯片)：340mV (典型值)
- 输出电流限制和热关断
- 在各种陶瓷输出电容值范围内可保持稳定
 - C_{OUT} 范围：1 μ F 至 100 μ F (新芯片)
 - ESR 范围：0 至 2 Ω (新芯片)
- 工作结温：-40°C 至 125°C
- 封装选项：
 - LP (3 引脚 TO-92)
 - D (8 引脚 SOIC)
 - DRG (8 引脚 WSON)

2 应用

- 电网基础设施
- 工厂自动化
- 电机驱动器
- 楼宇自动化



图 3-1. 压降电压与温度间的关系 (新芯片)

3 说明

LP2951 是一款具有宽输入范围的低压降稳压器 (LDO)，支持 2V 至 30V 的输入电压，可提供高达 100mA 的负载电流。LP2951 能够通过同一器件提供固定或可调输出。通过将 OUTPUT 和 SENSE 引脚连接在一起，以及将 FEEDBACK 和 V_{TAP} 引脚连接在一起，LP2951 输出可以提供 3.3V 或 5V 的固定输出。或者，将 SENSE 和 V_{TAP} 引脚保持在断开状态，同时将 FEEDBACK 连接至一个外部电阻分压器。此配置可以提供 1.2V 至 29V 之间的输出。

LP2951-Q1 具有可监控反馈引脚电压的 $\overline{\text{ERROR}}$ 输出，用于指示输出电压状态。SHUTDOWN 输入和 $\overline{\text{ERROR}}$ 输出用于对系统中的多个电源进行时序控制。

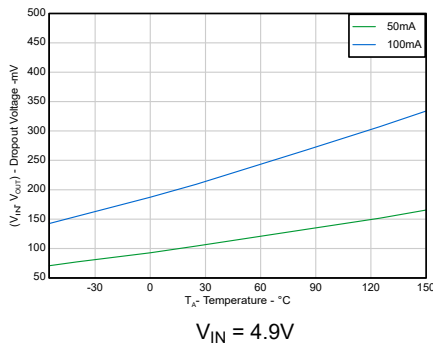
封装信息

器件型号	封装 ⁽¹⁾	封装尺寸 ⁽²⁾
LP2950	LP (TO-92, 3)	4.83mm × 4.83mm
LP2951	D (SOIC, 8)	4.90mm × 6.00mm
	DRG (SON, 8)	3.00mm × 3.00mm

(1) 如需了解所有可用封装，请参阅数据表末尾的可订购产品附录。

(2) 封装尺寸 (长 × 宽) 为标称值，并包括引脚 (如适用)。

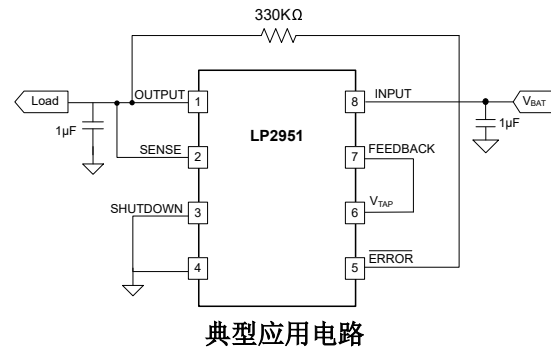

典型应用电路



Table of Contents

1 特性	1	7 Application and Implementation	23
2 应用	1	7.1 Application Information.....	23
3 说明	1	7.2 Typical Application.....	25
4 Pin Configuration and Functions	3	7.3 Power Supply Recommendations.....	29
5 Specifications	4	7.4 Layout.....	29
5.1 Absolute Maximum Ratings.....	4	8 Device and Documentation Support	29
5.2 ESD Ratings.....	4	8.1 Device Support.....	29
5.3 Recommended Operating Conditions.....	5	8.2 接收文档更新通知.....	29
5.4 Thermal Information.....	5	8.3 Device Nomenclature.....	29
5.5 Electrical Characteristics (Both Legacy and New Chip).....	5	8.4 Documentation Support.....	30
5.6 Timing Requirements (New Chip only).....	9	8.5 支持资源.....	30
5.7 Typical Characteristics.....	10	8.6 Trademarks.....	30
6 Detailed Description	21	8.7 静电放电警告.....	30
6.1 Overview.....	21	8.8 术语表.....	30
6.2 Functional Block Diagrams.....	21	9 Revision History	30
6.3 Feature Description.....	22	10 Mechanical, Packaging, and Orderable Information	31
6.4 Device Functional Modes.....	23		

4 Pin Configuration and Functions



表 4-1. Pin Functions

NAME	PIN		TYPE ⁽¹⁾	DESCRIPTION
	LP2950	LP2951		
ERROR	—	5	O	Active-low open-drain error output. Goes low when V_{OUT} drops by 6% of the nominal value.
FEEDBACK	—	7	I	Determines the output voltage. Connect to V_{TAP} (with OUTPUT tied to SENSE) for fixed output option, or connect to a resistor divider for adjustable output option.
GND	2	4	—	Ground
INPUT	3	8	I	Input supply pin. Use a capacitor with a value of 1 μ F or larger from this pin to ground is recommended. See the 节 7.1.2 section for more information.
OUTPUT	1	1	O	A capacitor is required from OUTPUT to GND for stability. For best transient response, use the nominal recommended value or larger ceramic capacitor from OUTPUT to GND ⁽²⁾ . Place the output capacitor as close to output of the device as possible. See the 节 7.1.2 for more details.
SENSE	—	2	I	Senses the output voltage. Connect to OUTPUT (with FEEDBACK tied to V_{TAP}) for fixed output option only. If using the device as adjustable output, this pin must be left floating.
SHUTDOWN	—	3	I	Active-high input. High signal disables the device; low signal enables the device.
V_{TAP}	—	6	I	Connect to FEEDBACK for fixed output option. If using the device as adjustable output, this pin must be left floating.

(1) I = Input; O = Output

(2) The nominal output capacitance must be greater than 1 μ F. Throughout this document, the nominal derating on these capacitors is 50%. Verify that the effective capacitance at the pin is greater than 1 μ F.

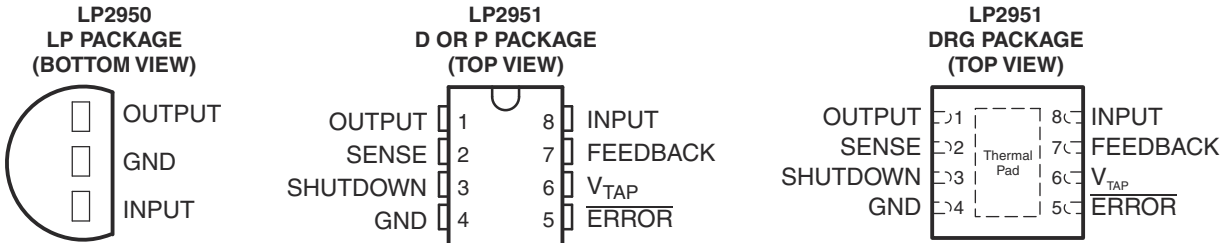
5 Specifications

5.1 Absolute Maximum Ratings

over operating free-air temperature range (unless otherwise noted)⁽¹⁾

		MIN	MAX	UNIT
V _{IN}	Continuous input voltage (Legacy chip)	- 0.3	30	V
	Continuous input voltage (New chip)	- 0.3	42	
V _{OUT}	Output voltage	- 0.3	V _{IN} +0.3 ⁽⁴⁾	
V _{SHDN}	SHUTDOWN input voltage (Legacy chip)	- 1.5	30	
	SHUTDOWN input voltage (New chip)	- 0.3	42	
V _{ERROR}	ERROR comparator output voltage (Legacy chip) ⁽²⁾	- 1.5	30	
	ERROR comparator output voltage (New chip) ⁽²⁾	- 0.3	39	
V _{FDBK}	FEEDBACK input voltage (Legacy chip) ^{(2) (3)}	- 1.5	30	
	FEEDBACK input voltage (New chip) ^{(2) (3)}	- 0.3	5	
V _{TAP}	Internal resistor divider (fixed voltage option only) (New Chip)	- 0.3	5	
V _{SENSE}	Output voltage sense (fixed voltage option only) (New Chip)	- 0.3	5	
T _{stg}	Storage temperature	- 65	150	°C

- (1) Operation outside the Absolute Maximum Ratings may cause permanent device damage. Absolute Maximum Ratings do not imply functional operation of the device at these or any other conditions beyond those listed under Recommended Operating Conditions. If used outside the Recommended Operating Conditions but within the Absolute Maximum Ratings, the device may not be fully functional, and this may affect device reliability, functionality, performance, and shorten the device lifetime.
- (2) Can exceed input supply voltage.
- (3) If load is returned to a negative power supply, the output must be diode clamped to GND.
- (4) The absolute maximum rating is V_{IN} + 0.3V or 39V, whichever is smaller.

5.2 ESD Ratings

			VALUE (Legacy Chip)	VALUE (New Chip)	UNIT
V _(ESD)	Electrostatic discharge	Human body model (HBM), per ANSI/ESDA/JEDEC JS-001, all pins ⁽¹⁾	±2500	±3000	V
		Charged device model (CDM), per JEDEC specification JESD22-C101, all pins ⁽²⁾	±1000	±1000	V

- (1) JEDEC document JEP155 states that 500V HBM allows safe manufacturing with a standard ESD control process.
- (2) JEDEC document JEP157 states that 250V CDM allows safe manufacturing with a standard ESD control process.

5.3 Recommended Operating Conditions

over operating free-air temperature range (unless otherwise noted)

		MIN	NOM	MAX	UNIT
V _{IN}	Input voltage	2.0		30	V
V _{EN}	Enable voltage	0		30	
V _{OUT}	Output voltage	1.2		30	
I _L	Output current	0		100	mA
C _{OUT}	Output capacitor ⁽¹⁾	1	2.2	100	μF
C _{OUT} ESR	Output capacitor ESR (Legacy chip)	30m		5	Ω
	Output capacitor ESR (New chip) ⁽³⁾	0		2	
C _{IN}	Input capacitor		1		μF
C _{FF}	Feed-forward capacitor (optional ⁽²⁾ , for adjustable device only)		10		pF
I _{FB_DIVIDER}	Feedback divider current ⁽²⁾ (adjustable device only)	12			μA
T _J	Junction temperature	-40		125	°C

(1) Effective output capacitance of 0.5μF minimum required for stability.

(2) C_{FF} required for stability if the feedback divider current < 12μA. Feedback divider current = V_{OUT} / (R₁ + R₂). See the *Feed-Forward Capacitor (C_{FF})* section for details.

(3) Maximum supported ESR range for new chip is 2 Ω. For output capacitor with higher ESR values, place a low ESR MLCC capacitor.

5.4 Thermal Information

THERMAL METRIC ^{(1) (2)}		Legacy Chip			New Chip			UNIT
		D	DRG	LP	D	DRG	LP	
		8 PINS	8 PINS	3 PINS	8 PINS	8 PINS	3 PINS	
R _{θJA}	Junction-to-ambient thermal resistance	97	52.44	140	123	48.5	132.6	°C/W
R _{θJC(top)}	Junction-to-case (top) thermal resistance	-	-	-	67.8	60.4	114.4	°C/W
R _{θJB}	Junction-to-board thermal resistance	-	-	-	70.7	22.4	94.9	°C/W
Ψ _{JT}	Junction-to-top characterization parameter	-	-	-	18.0	1.7	26.9	°C/W
Ψ _{JB}	Junction-to-board characterization parameter	-	-	-	69.8	22.4	94.9	°C/W
R _{θJC(bot)}	Junction-to-case (bottom) thermal resistance	-	-	-	n/a	3.3	n/a	°C/W

(1) The thermal data is based on the JEDEC standard high K profile, JESD 51-7. Two-signal, two-plane, four-layer board with 2-oz. copper. The copper pad is soldered to the thermal land pattern. Also, correct attachment procedure must be incorporated.

(2) For more information about traditional and new thermal metrics, see the [Semiconductor and IC Package Thermal Metrics](#) application note.

5.5 Electrical Characteristics (Both Legacy and New Chip)

V_{IN} = V_{OUT} (nominal) + 1V, I_L = 100μA, C_L = 1μF (for new chip) and C_L = 2.2μF (for legacy chip),

8-pin version: FEEDBACK tied to V_{TAP}, OUTPUT tied to SENSE, V_{SHUTDOWN} ≤ 0.7V

PARAMETER	TEST CONDITIONS	T _J	MIN	TYP	MAX	UNIT	
3.3-V VERSION (LP295x-33)							
Output voltage	I _L = 100μA	Legacy chip	25°C	3.267	3.3	3.333	V
			-40°C to 125°C	3.234	3.3	3.366	
		New chip	25°C	3.2868	3.3	3.3132	
			-40°C to 125°C	3.2736	3.3	3.3264	
5-V VERSION (LP295x-50)							

5.5 Electrical Characteristics (Both Legacy and New Chip) (续)

$V_{IN} = V_{OUT}(\text{nominal}) + 1V$, $I_L = 100\mu A$, $C_L = 1\mu F$ (for new chip) and $C_L = 2.2\mu F$ (for legacy chip),

8-pin version: FEEDBACK tied to V_{TAP} , OUTPUT tied to SENSE, $V_{SHUTDOWN} \leq 0.7V$

PARAMETER	TEST CONDITIONS	T_J	MIN	TYP	MAX	UNIT	
Output voltage	$I_L = 100\mu A$	Legacy chip	25°C	4.95	5	5.05	V
			- 40°C to 125°C	4.900	5	5.100	
		New chip	25°C	4.98	5	5.02	
			- 40°C to 125°C	4.96	5	5.04	
ALL VOLTAGE OPTIONS							
Output voltage accuracy	$V_{IN} = [V_{OUT(NOM)} + 1V]$ to 30V, $I_L = 100\mu A$ to 100mA	New chip	- 40°C to 125°C	- 1		1	%
	$V_{IN} = [V_{OUT(NOM)} + 1V]$ to 30V, $I_L = 100\mu A$ to 100mA, LP (TO-92) package			- 1.2		1.2	
Output voltage temperature coefficient ⁽¹⁾	$I_L = 100\mu A$	Legacy chip	- 40°C to 125°C		20	100	ppm/°C
		New chip			20	60	
Line regulation ⁽²⁾	$V_{IN} = [V_{OUT(NOM)} + 1V]$ to 30V	Legacy chip	25°C		0.03	0.2	%/ V
			- 40°C to 125°C			0.4	
		New chip	25°C		0.0006	0.01	
			- 40°C to 125°C			0.015	
Load regulation ⁽²⁾	$I_L = 100\mu A$ to 100mA	Legacy chip	25°C		0.04	0.2	%
			- 40°C to 125°C			0.3	
		New chip	25°C		0.04	0.1	
			- 40°C to 125°C			0.2	
Dropout voltage	$V_{IN} = 2V$, $I_L = 100\mu A$	Legacy chip	25°C		50	80	mV
			- 40°C to 125°C			150	
		New chip	25°C		1	4	
			- 40°C to 125°C			5	
	$V_{IN} = 2V$, $I_L = 100mA$	Legacy chip	25°C		380	450	
			- 40°C to 125°C			600	
		New chip	25°C		340	420	
			- 40°C to 125°C			570	

5.5 Electrical Characteristics (Both Legacy and New Chip) (续)

$V_{IN} = V_{OUT} \text{ (nominal)} + 1V$, $I_L = 100\mu A$, $C_L = 1\mu F$ (for new chip) and $C_L = 2.2\mu F$ (for legacy chip),
8-pin version: FEEDBACK tied to V_{TAP} , OUTPUT tied to SENSE, $V_{SHUTDOWN} \leq 0.7V$

PARAMETER	TEST CONDITIONS	T_J	MIN	TYP	MAX	UNIT	
GND current	$I_L = 100\mu A$	Legacy chip	25°C	75	120	μA	
			- 40°C to 125°C		140		
	New chip	25°C	50	65			
		- 40°C to 125°C		80			
$I_L = 100mA$	Legacy chip	25°C	8	12	mA		
		- 40°C to 125°C		14			
	New chip	25°C		0.8			
		- 40°C to 125°C		0.9			
Dropout ground current	$V_{IN} = V_{OUT(NOM)} - 0.5V$, $I_L = 100\mu A$	Legacy chip	25°C	110	170	μA	
			- 40°C to 125°C		200		
		New chip	25°C	78	120		
			- 40°C to 125°C		150		
UVLO V_{IN} rising	$I_L = 100\mu A$	New chip	- 40°C to 125°C	1.8	1.9	2.0	V
UVLO V_{IN} falling				1.7	1.8	1.9	
Hysteresis					100		
Current limit	$V_{OUT} = 0V$	Legacy chip	25°C	160	200	mA	
			- 40°C to 125°C		220		
		New chip	25°C	180	200		
			- 40°C to 125°C		230		
Thermal regulation ⁽³⁾	$I_L = 100\mu A$	Legacy chip	25°C	0.05	0.2	%/ W	
		New chip		0.05	0.2		
Output noise (RMS), 10Hz to 100KHz	$C_L = 1\mu F$ (5V only)	Legacy chip	25°C	430		μV	
		New chip		265			
	$C_L = 200\mu F$	Legacy chip	25°C	160			
		New chip		250			
	$C_L = 3.3\mu F$, $C_{Bypass} = 0.01\mu F$ between pins 1 and 7	Legacy chip	25°C	100			
New chip		100					
Power supply ripple rejection	$V_{IN} - V_{OUT} = 1V$, frequency = 100Hz, $I_{OUT} \geq 5mA$	New chip	25°C	80		dB	

(LP2951-xx) 8-PIN VERSION ONLY ADJ

5.5 Electrical Characteristics (Both Legacy and New Chip) (续)

$V_{IN} = V_{OUT} \text{ (nominal)} + 1V$, $I_L = 100\mu A$, $C_L = 1\mu F$ (for new chip) and $C_L = 2.2\mu F$ (for legacy chip),
8-pin version: FEEDBACK tied to V_{TAP} , OUTPUT tied to SENSE, $V_{SHUTDOWN} \leq 0.7V$

PARAMETER	TEST CONDITIONS	T_J	MIN	TYP	MAX	UNIT	
Reference voltage		Legacy chip	25°C	1.218	1.235	1.252	V
			- 40°C to 125°C	1.212		1.257	
		New chip	25°C	1.192	1.2	1.208	
			- 40°C to 125°C	1.189		1.211	
Reference voltage	$V_{IN} = 2.3V \text{ to } 30V$, $I_L = 100\mu A \text{ to } 100mA$	Legacy chip	- 40°C to 125°C	1.2		1.272	
		New chip	1.188		1.212		
Reference voltage temperature coefficient ⁽¹⁾		Legacy chip	25°C	20		ppm/°C	
		New chip		5			
FEEDBACK bias current		Legacy chip	25°C	20		nA	
			- 40°C to 125°C	60			
		New chip	25°C	10			
			- 40°C to 125°C	60			
FEEDBACK bias current temperature coefficient		Legacy chip	25°C	0.1		nA/°C	
		New chip		0.1			
ERROR COMPARATOR							
Output leakage current	$V_{OUT} = 30V$	Legacy chip	25°C	0.01		μA	
			- 40°C to 125°C	2			
		New chip	25°C	0.2			
			- 40°C to 125°C	1			
Output low voltage	$V_{IN} \geq 2V$ $I_{OL} = 400\mu A$	Legacy chip	25°C	150		mV	
			- 40°C to 125°C	400			
		New chip	25°C	180			
			- 40°C to 125°C	350			
Upper threshold voltage (ERROR output high) ⁽⁴⁾		Legacy chip	25°C	40		mV	
			- 40°C to 125°C	25			
		New chip	25°C	40			
			- 40°C to 125°C	25			
Lower threshold voltage (ERROR output low) ⁽⁴⁾		Legacy chip	25°C	75		mV	
			- 40°C to 125°C	140			
		New chip	25°C	75			
			- 40°C to 125°C	140			
Hysteresis ⁽⁴⁾		Legacy chip	25°C	15		mV	
		New chip		15			
SHUTDOWN INPUT							

5.5 Electrical Characteristics (Both Legacy and New Chip) (续)

$V_{IN} = V_{OUT} \text{ (nominal)} + 1V$, $I_L = 100\mu A$, $C_L = 1\mu F$ (for new chip) and $C_L = 2.2\mu F$ (for legacy chip),
8-pin version: FEEDBACK tied to V_{TAP} , OUTPUT tied to SENSE, $V_{SHUTDOWN} \leq 0.7V$

PARAMETER	TEST CONDITIONS	T_J	MIN	TYP	MAX	UNIT
Input logic voltage	Low (regulator ON)	Legacy chip	– 40°C to 125°C	0.7		V
		New chip		0.7		
	High (regulator OFF)	Legacy chip	– 40°C to 125°C	2		
		New chip		2		
SHUTDOWN input current	SHUTDOWN = 2.4V	Legacy chip	25°C	30	50	μA
			– 40°C to 125°C	100		
		New chip	25°C	0.2	0.5	
			– 40°C to 125°C	1		
	SHUTDOWN = 30V	Legacy chip	25°C	450	600	
			– 40°C to 125°C	750		
New chip	25°C	0.3	0.5			
	– 40°C to 125°C	1				
Regulator output current in shutdown	$V_{SHUTDOWN} \geq 2V$, $V_{IN} \geq 30V$, $V_{OUT} = 0$, FEEDBACK tied to V_{TAP}	Legacy chip	25°C	3	10	μA
			– 40°C to 125°C	20		
		New chip	25°C	4	6	
			– 40°C to 125°C	7.5		

- Output or reference voltage temperature coefficient is defined as the worst-case voltage change divided by the total temperature range.
- Regulation is measured at constant junction temperature, using pulse testing with a low duty cycle. Changes in output voltage due to heating effects are covered under the specification for thermal regulation.
- Thermal regulation is defined as the change in output voltage at a time (T) after a change in power dissipation is applied, excluding load or line regulation effects. Specifications are for a 50-mA load pulse at $V_{IN} = 30V$, $V_{OUT} = 5V$ (1.25W pulse) for $t = 10ms$.
- Comparator thresholds are expressed in terms of a voltage differential equal to the nominal reference voltage (measured at $V_{IN} - V_{OUT} = 1V$) minus FEEDBACK terminal voltage. To express these thresholds in terms of output voltage change, multiply by the error amplifier gain = $V_{OUT}/V_{REF} = (R1 + R2)/R2$. For example, at a programmed output voltage of 5V, the ERROR output is specified to go low when the output drops by $95mV \times 5V/1.2V = 395mV$. Thresholds remain constant as a percentage of V_{OUT} (as V_{OUT} is varied), with the low-output warning occurring at 6% below nominal (typ) and 7.7%(max).

5.6 Timing Requirements (New Chip only)

PARAMETER	TEST CONDITIONS	MIN	TYP	MAX	UNIT
t_{PGDH}	PG delay time rising, time from 92% V_{OUT} to 20% of PG ⁽¹⁾		40		μs
t_{PGDL}	PG delay time falling, time from 90% V_{OUT} to 80% of PG ⁽¹⁾		10		μs

- Output Overdrive = 10%.

5.7 Typical Characteristics

at $V_{IN} = V_{OUT} (\text{nominal}) + 1V$, $I_L = 100 \mu A$, $C_L = 1\mu F$ (for new chip) and $C_L = 2.2\mu F$ (for legacy chip) (unless otherwise noted)



图 5-1. Quiescent Current vs Load Current (Legacy Chip)



$V_{IN} = 6V, V_{OUT} = 5V$

图 5-2. Quiescent Current vs Load Current (New Chip)

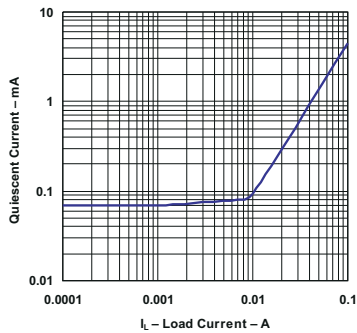
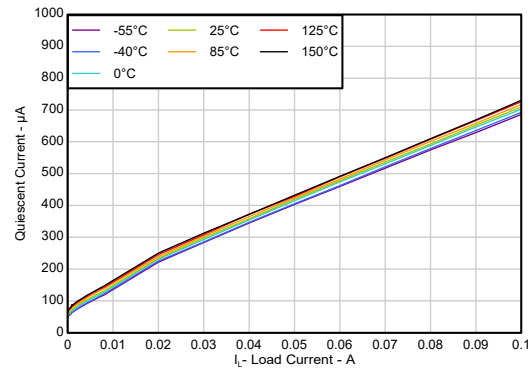

图 5-3. Input Current vs Input Voltage ($R_L = \text{OPEN}$) (Legacy Chip)



$V_{OUT} = 5V, I_L = 0mA$

图 5-4. Input Current vs Input Voltage ($R_L = \text{OPEN}$) (New Chip)

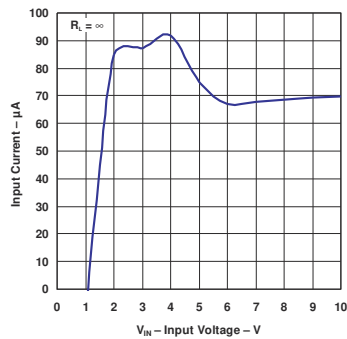
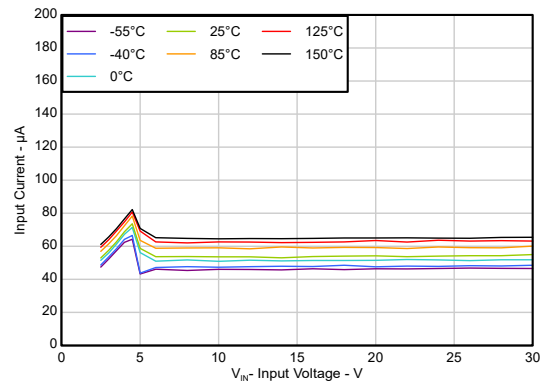

图 5-5. Input Current vs Input Voltage ($R_L = 50k \Omega$)



$V_{OUT} = 5V, I_L = 100 \mu A$

图 5-6. Input Current vs Input Voltage ($R_L = 50k \Omega$) (New Chip)

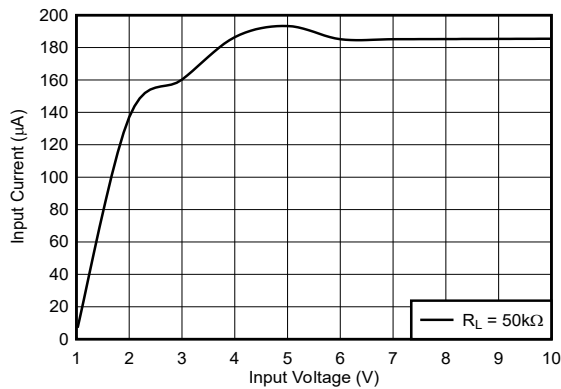
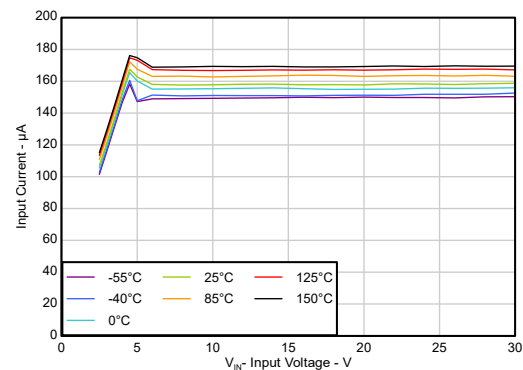
5.7 Typical Characteristics (continued)

at $V_{IN} = V_{OUT} (\text{nominal}) + 1V$, $I_L = 100 \mu A$, $C_L = 1\mu F$ (for new chip) and $C_L = 2.2\mu F$ (for legacy chip) (unless otherwise noted)



图 5-7. Input Current vs Input Voltage ($R_L = 50 \Omega$) (Legacy Chip)



$V_{OUT} = 5V$, $I_L = 100mA$

图 5-8. Input Current vs Input Voltage ($R_L = 50 \Omega$) (New Chip)

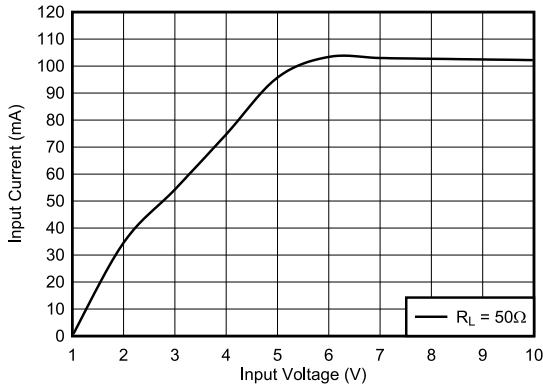
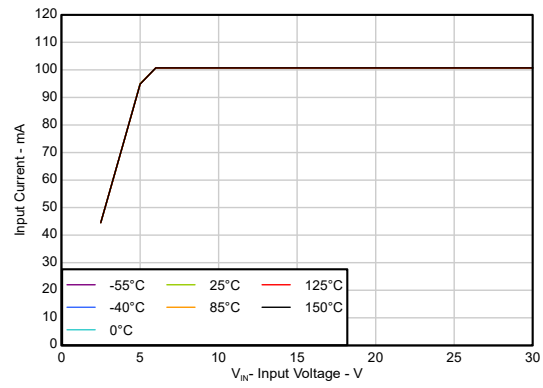

图 5-9. Output Voltage vs Temperature (Legacy Chip)



$V_{IN} = 6V$, $V_{OUT} = 5V$

图 5-10. Output Voltage vs Temperature (New Chip)

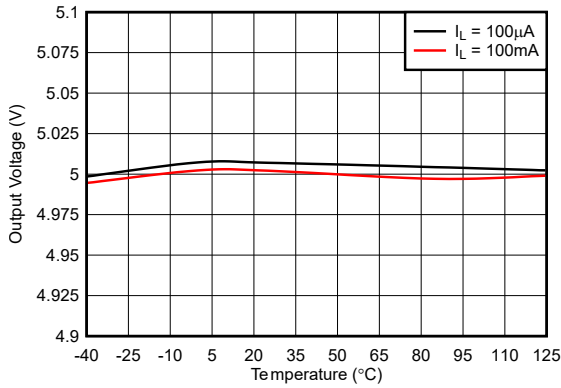
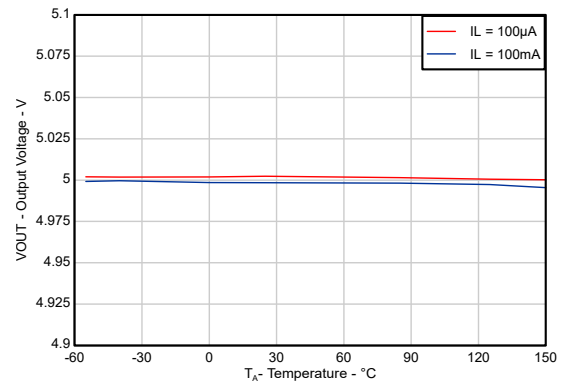

图 5-11. Quiescent Current vs Input Voltage ($I_L = 0$) (Legacy Chip)



$V_{OUT} = 5V$

图 5-12. Quiescent Current vs Input Voltage ($I_L = 0$) (New Chip)

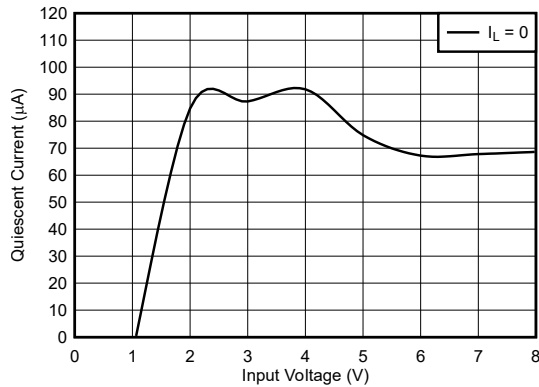
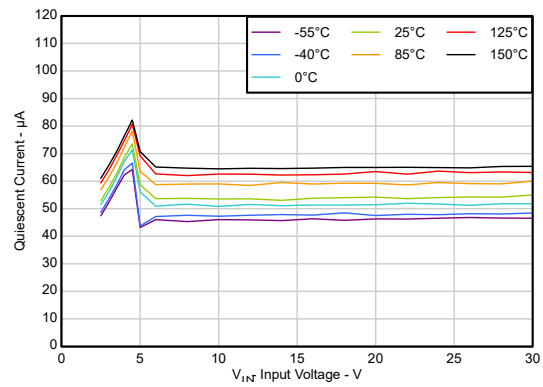
5.7 Typical Characteristics (continued)

at $V_{IN} = V_{OUT} (\text{nominal}) + 1V$, $I_L = 100 \mu A$, $C_L = 1\mu F$ (for new chip) and $C_L = 2.2\mu F$ (for legacy chip) (unless otherwise noted)



图 5-13. Quiescent Current vs Input Voltage ($I_L = 1mA$)(Legacy Chip)



$V_{OUT} = 5V$

图 5-14. Quiescent Current vs Input Voltage ($I_L = 1mA$)(New Chip)

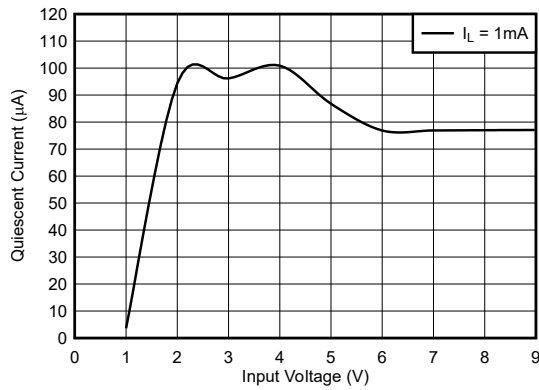
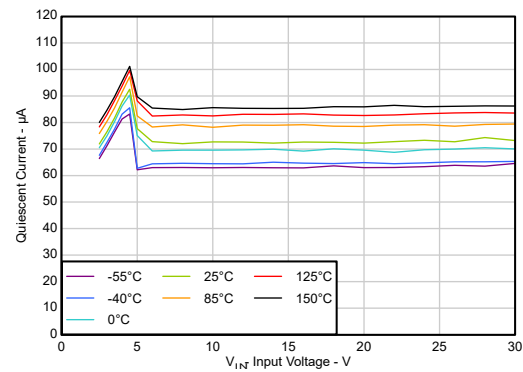

图 5-15. Quiescent Current vs Input Voltage ($I_L = 100mA$)(Legacy Chip)



$V_{OUT} = 5V$

图 5-16. Quiescent Current vs Input Voltage ($I_L = 100mA$)(New Chip)

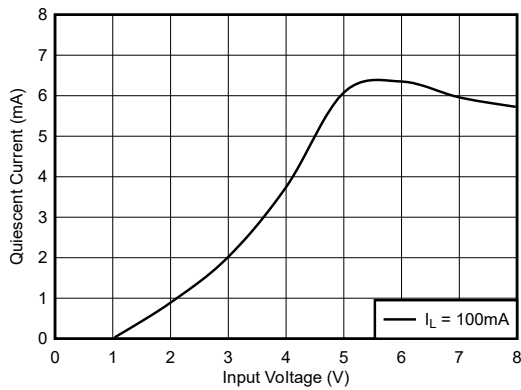
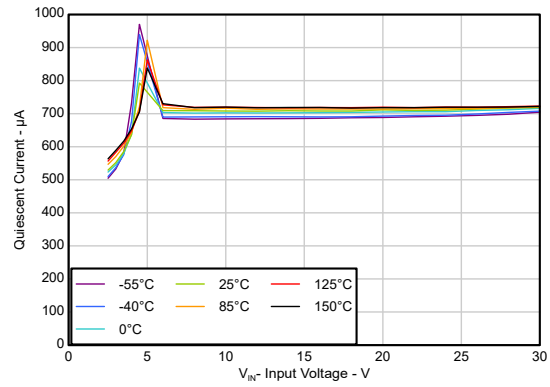

图 5-17. Quiescent Current vs Temperature ($I_L = 100mA$)(Legacy Chip)



$V_{IN} = 6V, V_{OUT} = 5V$

图 5-18. Quiescent Current vs Temperature ($I_L = 100mA$)(New Chip)

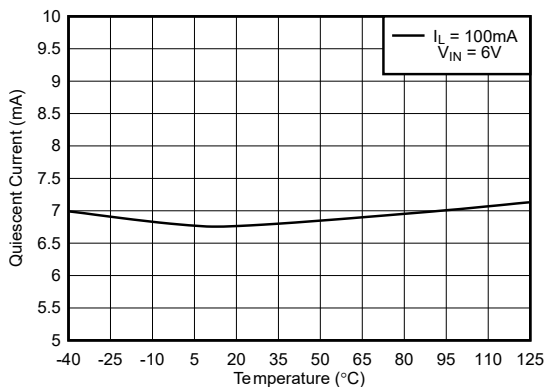
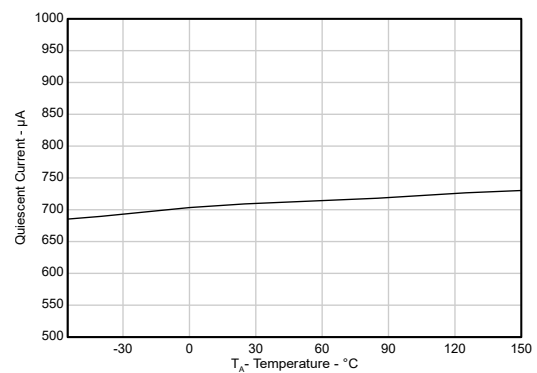
5.7 Typical Characteristics (continued)

at $V_{IN} = V_{OUT} (\text{nominal}) + 1V$, $I_L = 100 \mu A$, $C_L = 1\mu F$ (for new chip) and $C_L = 2.2\mu F$ (for legacy chip) (unless otherwise noted)



图 5-19. Quiescent Current vs Temperature ($I_L = 100 \mu A$)(Legacy Chip)



$V_{IN} = 6V, V_{OUT} = 5V$

图 5-20. Quiescent Current vs Temperature ($I_L = 100 \mu A$)(New Chip)

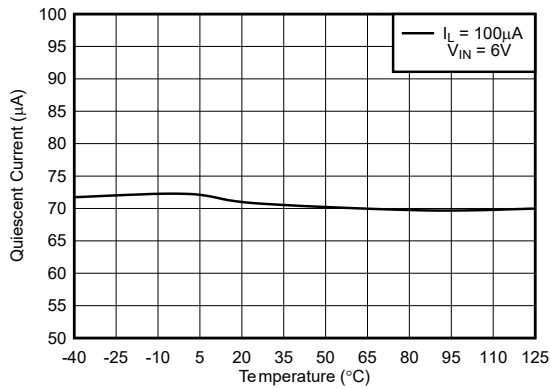
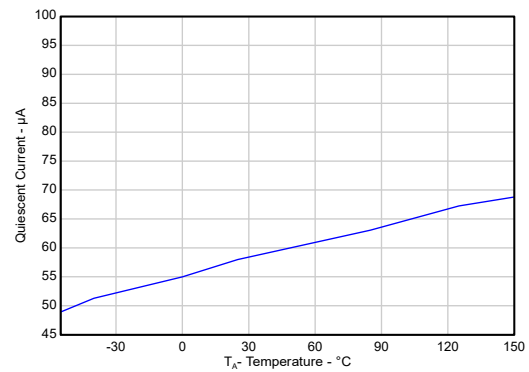

图 5-21. Short-Circuit Current vs Temperature (Legacy Chip)



$V_{IN} = 6V, V_{OUT} = 0V$

图 5-22. Short-Circuit Current vs Temperature (New Chip)

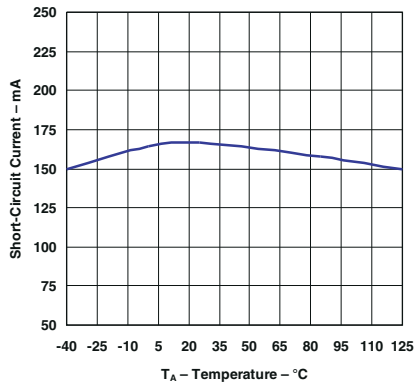
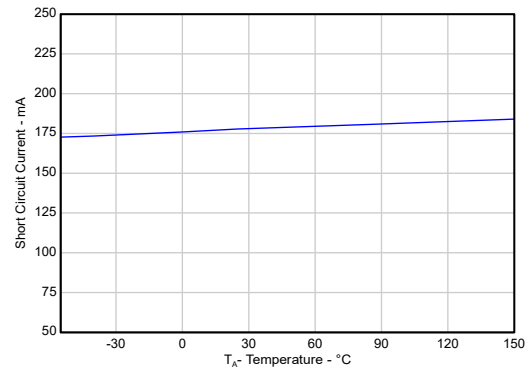

图 5-23. Dropout Voltage vs Temperature (Legacy Chip)



$V_{IN} = 4.9V$

图 5-24. Dropout Voltage vs Temperature (New Chip)

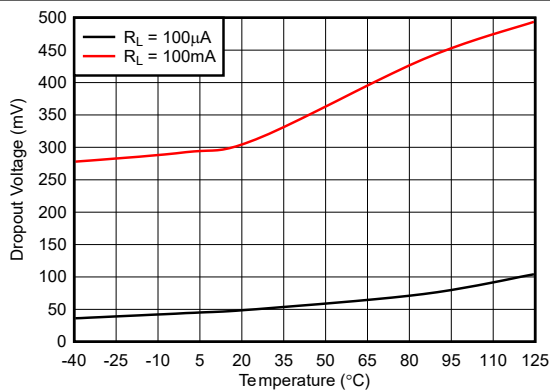
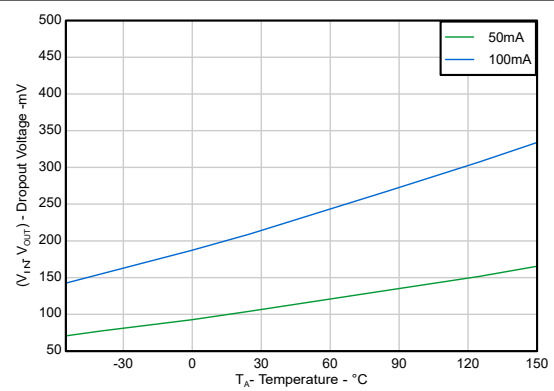
5.7 Typical Characteristics (continued)

at $V_{IN} = V_{OUT} (\text{nominal}) + 1V$, $I_L = 100 \mu A$, $C_L = 1\mu F$ (for new chip) and $C_L = 2.2\mu F$ (for legacy chip) (unless otherwise noted)



图 5-25. Dropout Voltage vs Dropout Current (Legacy Chip)



$V_{IN} = 4.9V$

图 5-26. Dropout Voltage vs Dropout Current (New Chip)

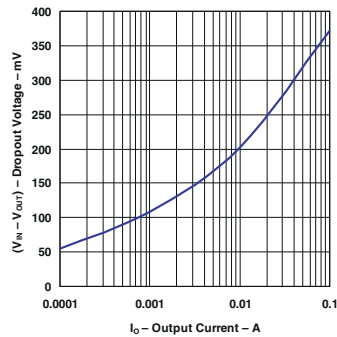
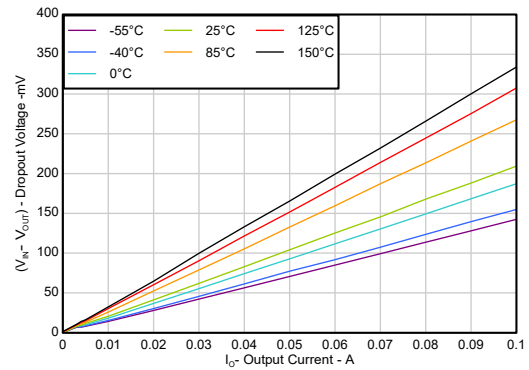

图 5-27. Minimum Operating Voltage vs Temperature (Legacy Chip)



图 5-28. Minimum Operating Voltage vs Temperature (New Chip)

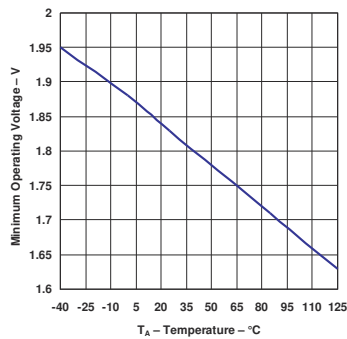

图 5-29. LP2951 FEEDBACK Bias Current vs Temperature (Legacy Chip)

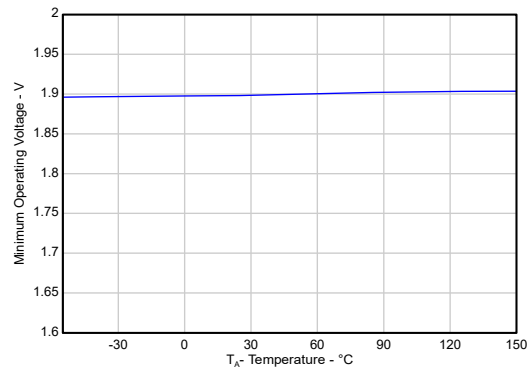

图 5-30. FEEDBACK Bias Current vs Temperature (New Chip)

5.7 Typical Characteristics (continued)

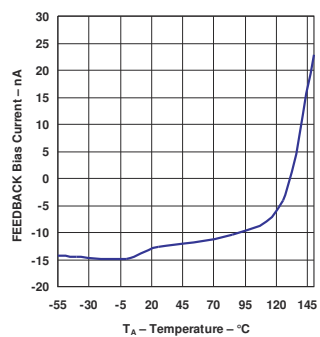
at $V_{IN} = V_{OUT} (\text{nominal}) + 1V$, $I_L = 100 \mu A$, $C_L = 1\mu F$ (for new chip) and $C_L = 2.2\mu F$ (for legacy chip) (unless otherwise noted)

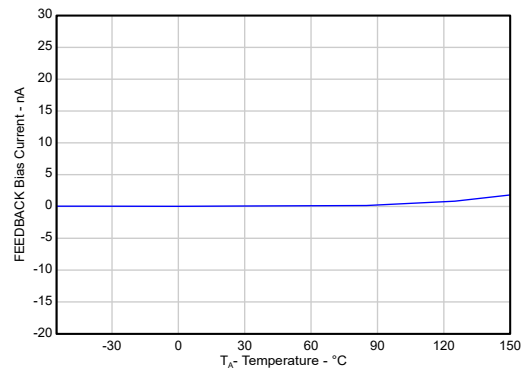

图 5-31. LP2951 $\overline{\text{ERROR}}$ Comparator Output vs Input Voltage (Legacy Chip)



图 5-32. $\overline{\text{ERROR}}$ Comparator Output vs Input Voltage (New Chip)

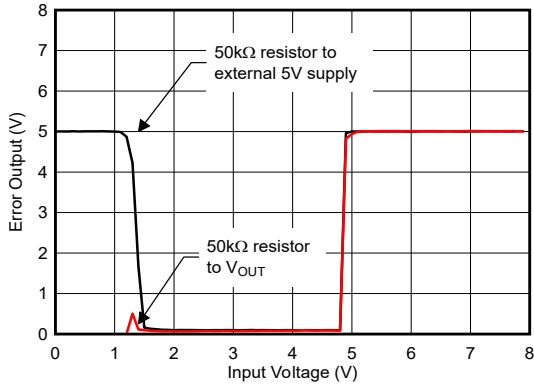

图 5-33. LP2951 $\overline{\text{ERROR}}$ Comparator Sink Current vs Output Low Voltage (Legacy Chip)

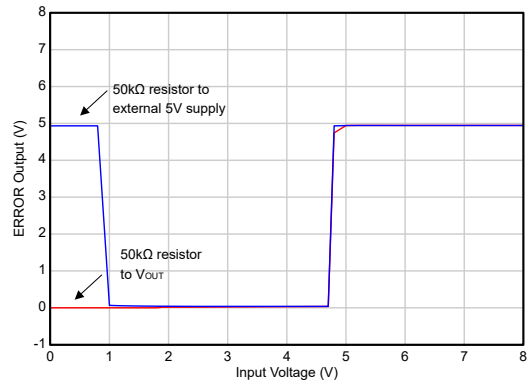

图 5-34. $\overline{\text{ERROR}}$ Comparator Sink Current vs Output Low Voltage (New Chip)

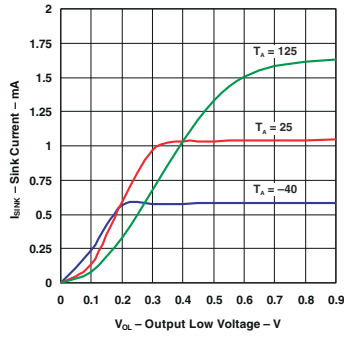

图 5-35. LP2951 Divider Resistance vs Temperature (Legacy Chip)

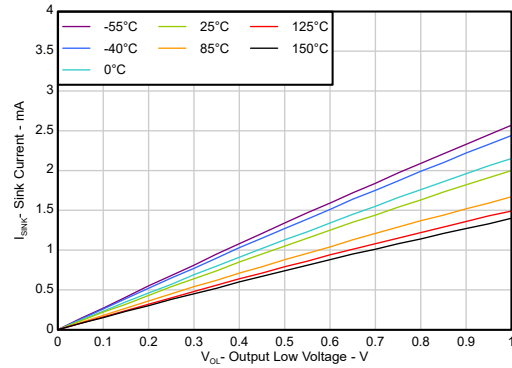

图 5-36. Shutdown Threshold Voltage (Off to On) vs Temperature (Legacy Chip)

5.7 Typical Characteristics (continued)

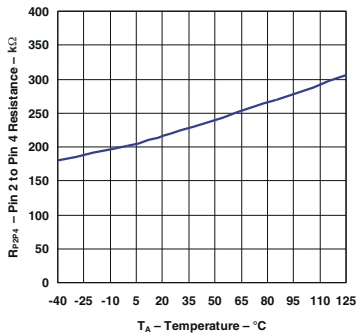
at $V_{IN} = V_{OUT} (\text{nominal}) + 1V$, $I_L = 100 \mu A$, $C_L = 1\mu F$ (for new chip) and $C_L = 2.2\mu F$ (for legacy chip) (unless otherwise noted)

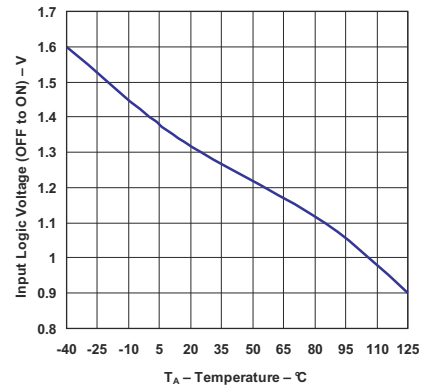

图 5-37. Shutdown Threshold Voltage (Off to On) vs Temperature (New Chip)



图 5-38. Shutdown Threshold Voltage (On to Off) vs Temperature (Legacy Chip)

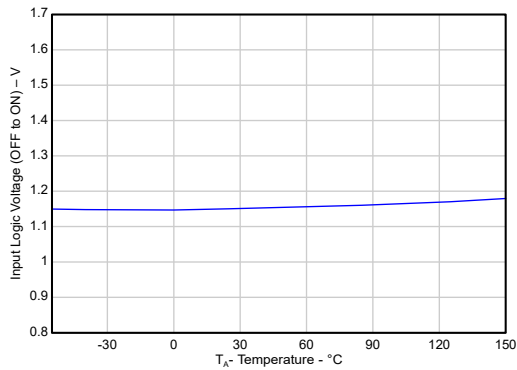

图 5-39. Shutdown Threshold Voltage (On to Off) vs Temperature (New Chip)

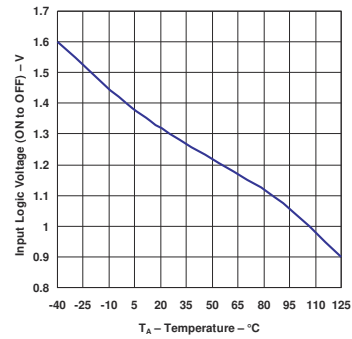

图 5-40. Line Regulation vs Input Voltage (Legacy Chip)

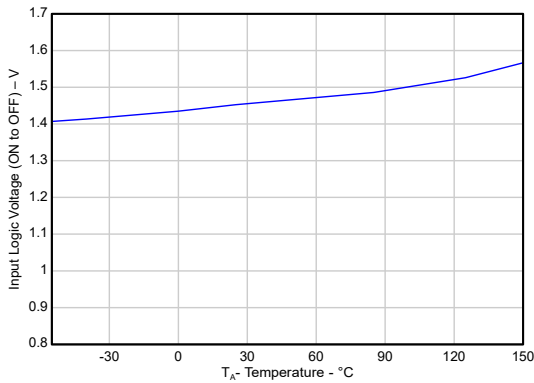

$V_{OUT} = 5V$, $I_{OUT} = 100 \mu A$

图 5-41. Line Regulation vs Input Voltage (New Chip)

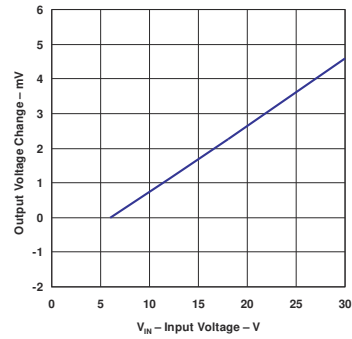
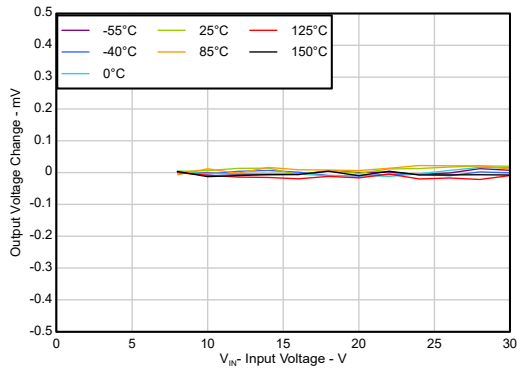
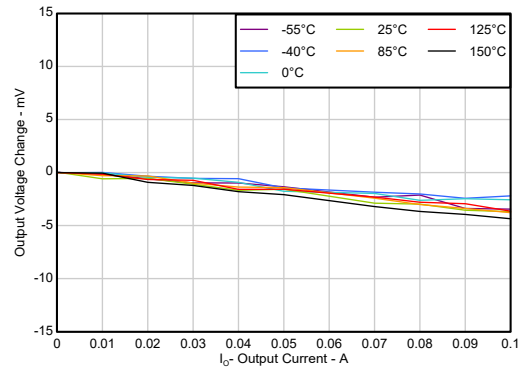

$V_{IN} = 6V$, $V_{OUT} = 5V$

图 5-42. Load Regulation vs Load Current (New Chip)

5.7 Typical Characteristics (continued)

at $V_{IN} = V_{OUT} (\text{nominal}) + 1V$, $I_L = 100 \mu A$, $C_L = 1\mu F$ (for new chip) and $C_L = 2.2\mu F$ (for legacy chip) (unless otherwise noted)



图 5-43. Output Voltage vs Input Voltage (New Chip)



图 5-44. SHUTDOWN Input Current vs SHUTDOWN Voltage (New Chip)

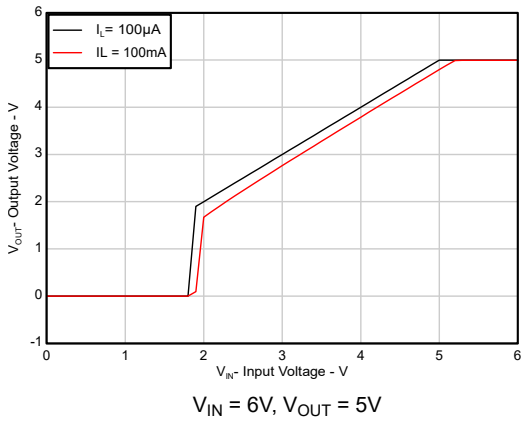

图 5-45. Line Transient Response vs Time (Legacy Chip)

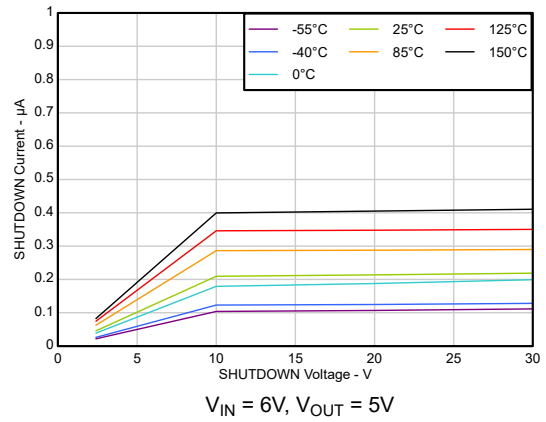

图 5-46. Line Transient Response vs Time (New Chip)

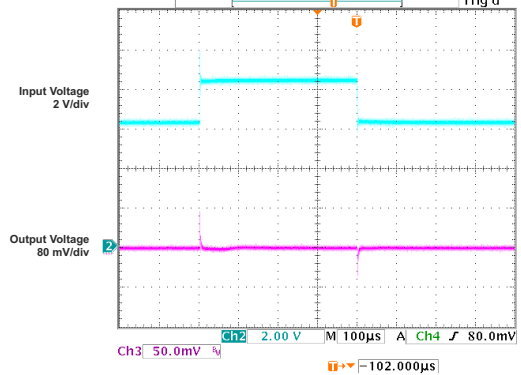

图 5-47. Load Transient Response vs Time ($V_{OUT} = 5V, C_L = 10\mu F$) (Legacy Chip)

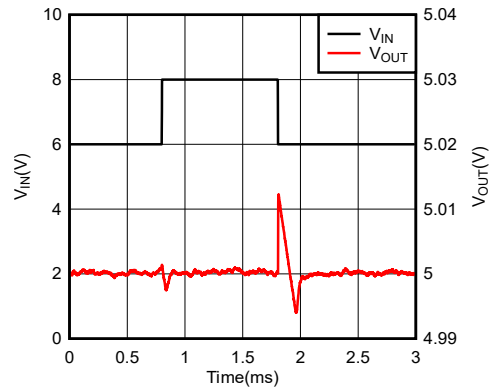

图 5-48. Load Transient Response vs Time (New Chip)

5.7 Typical Characteristics (continued)

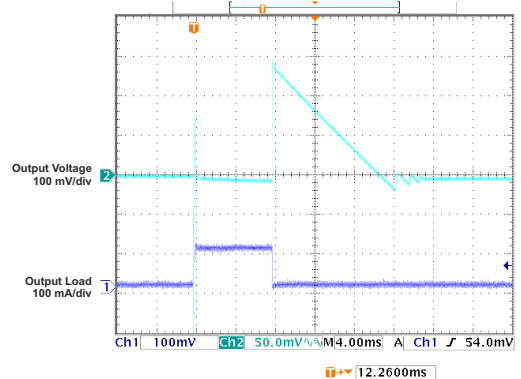
at $V_{IN} = V_{OUT} (\text{nominal}) + 1V$, $I_L = 100 \mu A$, $C_L = 1\mu F$ (for new chip) and $C_L = 2.2\mu F$ (for legacy chip) (unless otherwise noted)

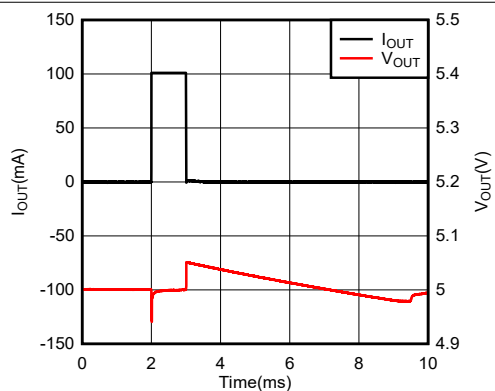
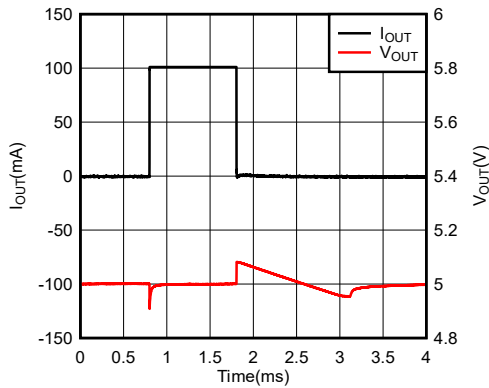

$V_{IN} = 6V$, $V_{OUT} = 5V$, $I_{OUT} = 0$ to 100mA , $C_{OUT} = 1 \mu F$

图 5-49. Load Transient Response vs Time (New Chip)



图 5-50. Enable Transient Response vs Time ($I_L = 1\text{mA}$, $C_L = 1\mu F$) (Legacy Chip)



$V_{IN} = 6V$, $V_{OUT} = 5V$, $C_{OUT} = 1 \mu F$, $I_{OUT} = 1\text{mA}$

图 5-51. Enable Transient Response vs Time (New Chip)

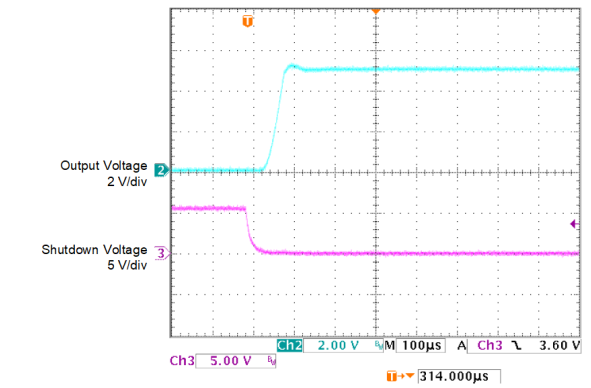
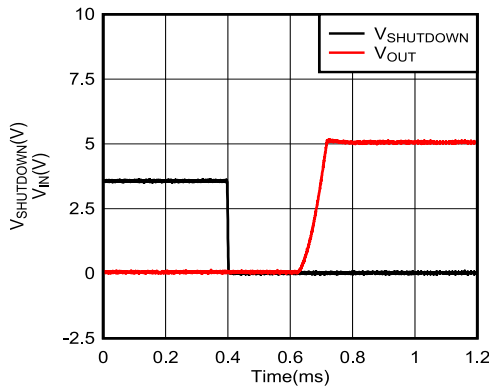

图 5-52. Enable Transient Response vs Time ($I_L = 1\text{mA}$, $C_L = 10\mu F$)



$V_{IN} = 6V$, $V_{OUT} = 5V$, $C_{OUT} = 10 \mu F$, $I_{OUT} = 1\text{mA}$

图 5-53. Enable Transient Response vs Time (New Chip)

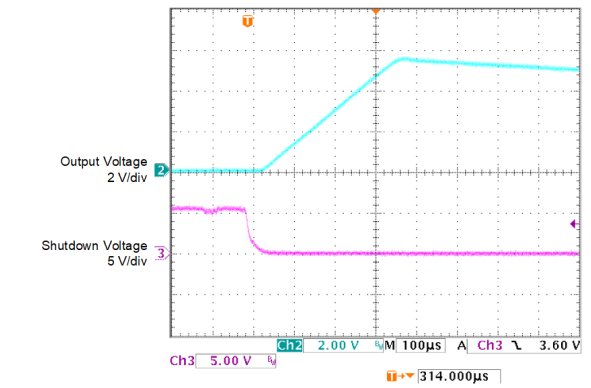
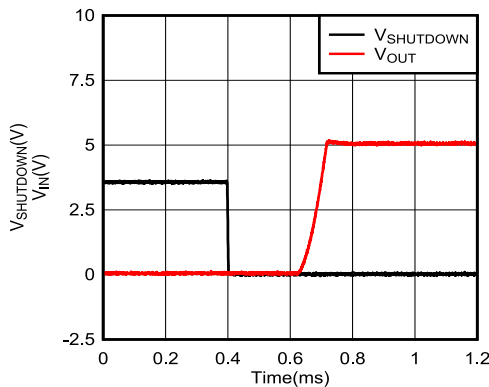

图 5-54. Output Impedance vs Frequency (Legacy Chip)

5.7 Typical Characteristics (continued)

at $V_{IN} = V_{OUT} (\text{nominal}) + 1V$, $I_L = 100 \mu A$, $C_L = 1 \mu F$ (for new chip) and $C_L = 2.2 \mu F$ (for legacy chip) (unless otherwise noted)

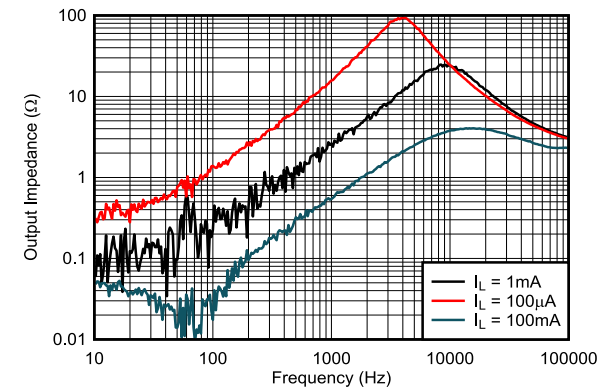

图 5-55. Ripple Rejection vs Frequency (Legacy Chip)



图 5-56. Ripple Rejection vs Frequency (Legacy Chip)

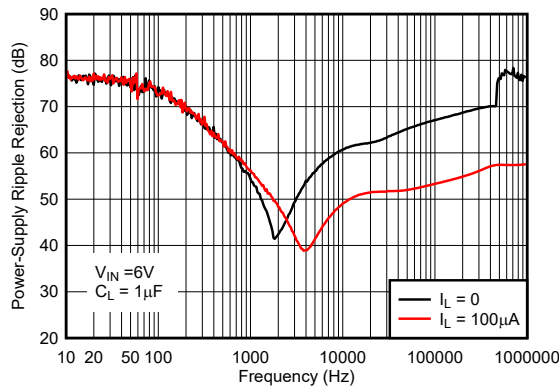

图 5-57. Ripple Rejection vs Frequency (Legacy Chip)

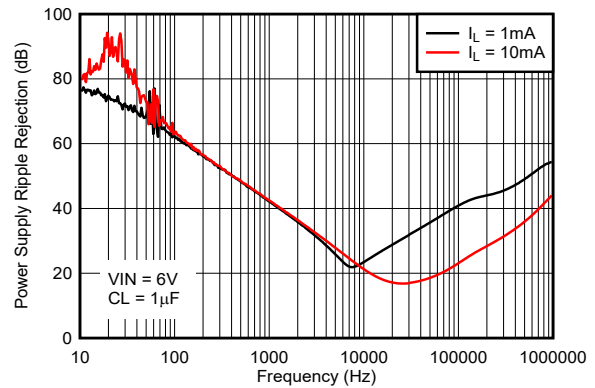

$V_{IN} = 6V, V_{OUT} = 5V, C_{OUT} = 1 \mu F$

图 5-58. Ripple Rejection vs Frequency (New Chip)

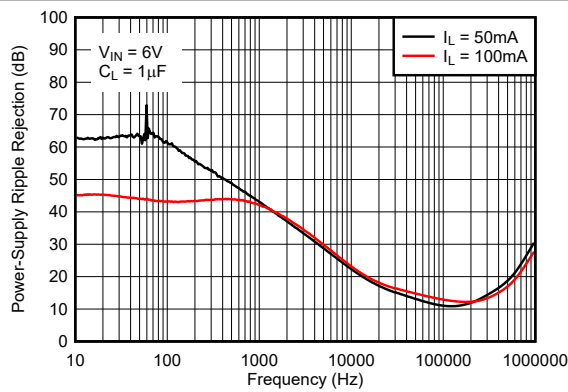
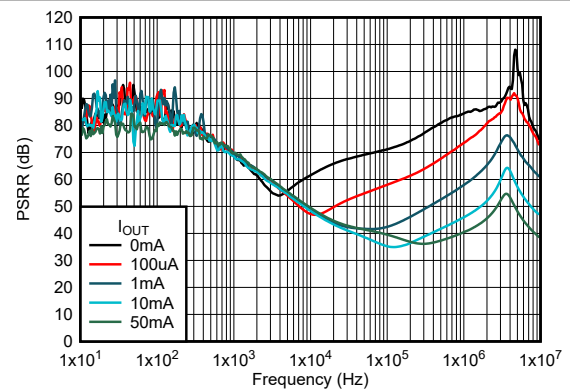
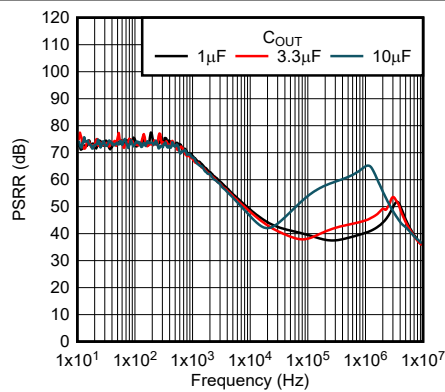

$V_{IN} = 6V, V_{OUT} = 5V, I_{OUT} = 100mA$

图 5-59. Ripple Rejection vs Frequency (New Chip)

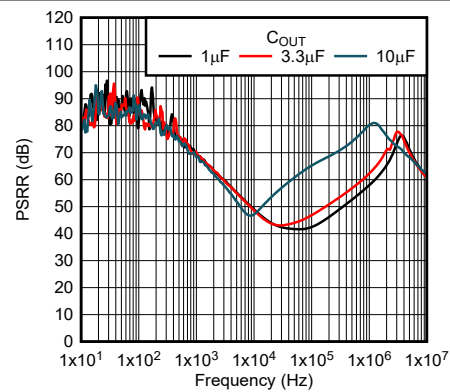

$V_{IN} = 6V, V_{OUT} = 5V, I_{OUT} = 1mA$

图 5-60. Ripple Rejection vs Frequency (New Chip)

5.7 Typical Characteristics (continued)

at $V_{IN} = V_{OUT} \text{ (nominal)} + 1V$, $I_L = 100 \mu A$, $C_L = 1\mu F$ (for new chip) and $C_L = 2.2\mu F$ (for legacy chip) (unless otherwise noted)



图 5-61. Output Noise vs Frequency (Legacy Chip)



$V_{IN} = 6V$, $V_{OUT} = 5V$, $I_{OUT} = 100 \mu A$

图 5-62. Output Noise vs Frequency (New Chip)

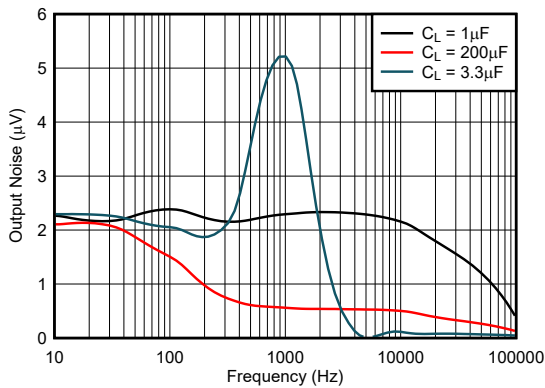
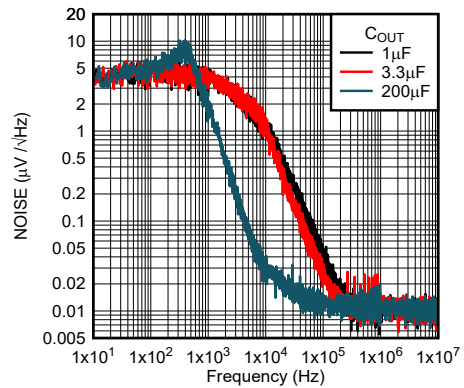
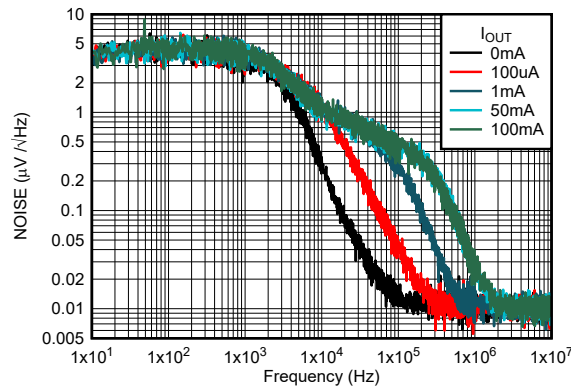

$V_{IN} = 6V$, $V_{OUT} = 5V$, $C_{OUT} = 1 \mu F$

图 5-63. Output Noise vs Frequency (New Chip)

6 Detailed Description

6.1 Overview

The LP2950 and LP2951 devices are low-dropout voltage regulators that accommodate a wide input supply-voltage range of up to 30V. The easy-to-use, 3-pin LP2950 is available in fixed-output voltages of 5V and 3.3V. However, the 8-pin LP2951 device outputs either a fixed or adjustable output from the same device. By tying the OUTPUT and SENSE pins together, and the FEEDBACK and V_{TAP} pins together, the LP2951 device outputs a fixed 5V or 3.3V (depending on the version). Alternatively, by leaving the SENSE and V_{TAP} pins unconnected and connecting FEEDBACK to an external resistor divider, the output can be set to any value between 1.2V to 30V.

The LP2951 has a error flag output ($\overline{\text{ERROR}}$) that monitors the voltage at the feedback pin to indicate the status of the output voltage. The SHUTDOWN input and $\overline{\text{ERROR}}$ output can be used for sequencing multiple power supplies in the system.

The LP295x devices are stable with small ceramic output capacitors, allowing for a small overall solution size. The LP295x devices has an output tolerance of 1% across line, load, and temperature variation (for the new chip) and is capable of delivering 100mA of continuous load current. This device includes integrated thermal shutdown, current limit, and undervoltage lockout (UVLO) features. These devices deliver excellent line and load transient performance. The operating ambient temperature range of the device is -40°C to 125°C .

6.2 Functional Block Diagrams



图 6-1. LP2951 Functional Block Diagram

6.3 Feature Description

6.3.1 Output Enable

The SHUTDOWN pin for the device is an active-high pin. The output voltage is enabled when the SHUTDOWN pin voltage is less than the low-level input voltage of the SHUTDOWN pin. The output voltage is disabled when the SHUTDOWN pin voltage is greater than the high-level input voltage of the SHUTDOWN pin. If independent control of the output voltage is not needed, connect the SHUTDOWN pin to the GND of the device.

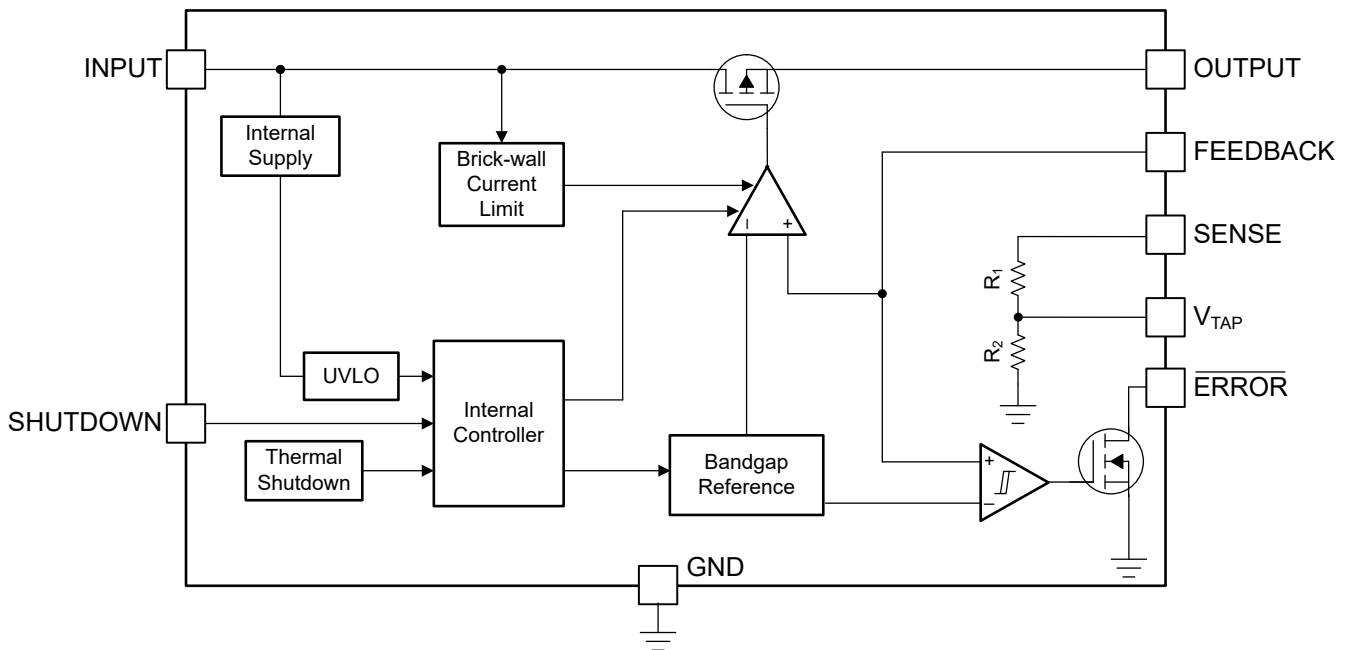
6.3.2 Dropout Voltage

Dropout voltage (V_{DO}) is defined as $V_{IN} - V_{OUT}$ at the rated output current (I_{RATED}), where the pass transistor is fully on. V_{IN} is the input voltage, V_{OUT} is the output voltage and I_{RATED} is the maximum I_{OUT} listed in the [# 5.3](#) table. At this operating point, the pass transistor is driven fully on. Dropout voltage indirectly specifies a minimum input voltage greater than the nominal programmed output voltage where the output voltage is expected to stay in regulation. If the input voltage falls to less than the nominal output regulation, then the output voltage falls as well.

For a CMOS regulator, the dropout voltage is determined by the drain-source on-state resistance ($R_{DS(ON)}$) of the pass transistor. Therefore, if the linear regulator operates at less than the rated current, the dropout voltage for that current scales accordingly. The following equation calculates the $R_{DS(ON)}$ of the device.

$$R_{DS(ON)} = \frac{V_{DO}}{I_{RATED}} \quad (1)$$

6.3.3 Current Limit

The device has an internal current limit circuit that protects the regulator during transient high-load current faults or shorting events. The current limit is a brick-wall scheme. In a high-load current fault, the brick-wall scheme limits the output current to the current limit (I_{CL}). I_{CL} is listed in the [# 5.5](#) table.

The output voltage is not regulated when the device is in current limit. When a current limit event occurs, the device begins to heat up because of the increase in power dissipation. When the device is in brick-wall current limit, the pass transistor dissipates power $[(V_{IN} - V_{OUT}) \times I_{CL}]$. If thermal shutdown is triggered, the device turns off. After the device cools down, the internal thermal shutdown circuit turns the device back on. If the output current fault condition continues, the device cycles between current limit and thermal shutdown. For more information on current limits, see the [Know Your Limits application note](#).

图 6-2 shows a diagram of the current limit.



图 6-2. Current Limit

6.3.4 Undervoltage Lockout (UVLO)

The device has an independent undervoltage lockout (UVLO) circuit that monitors the input voltage, allowing a controlled and consistent turn on and off of the output voltage. To prevent the device from turning off if the input drops during turn on, the UVLO has hysteresis as specified in the [# 5.5](#) table.

6.3.5 Thermal Shutdown

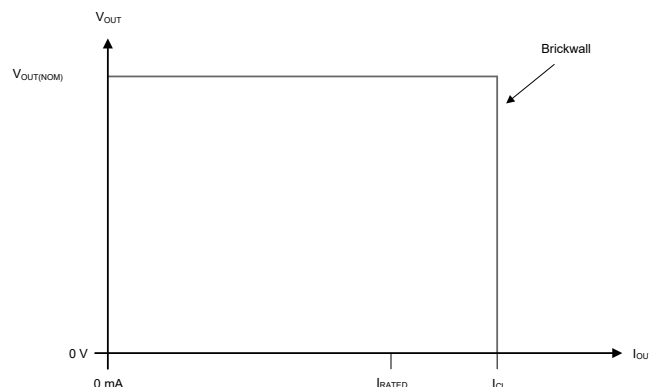
The device contains a thermal shutdown protection circuit to disable the device when the junction temperature (T_J) of the pass transistor rises to $T_{SD(shutdown)}$ (typical). Thermal shutdown hysteresis verifies that the device resets (turns on) when the temperature falls to $T_{SD(reset)}$ (typical).

The thermal time-constant of the semiconductor die is fairly short, thus the device cycles on and off when thermal shutdown is reached until power dissipation is reduced. Power dissipation during start up is potentially high from large $V_{IN} - V_{OUT}$ voltage drops across the device or from high inrush currents charging large output capacitors. Under some conditions, the thermal shutdown protection disables the device before start-up completes.

For reliable operation, limit the junction temperature to the maximum listed in the [# 5.3](#) table. Operation above this maximum temperature causes the device to exceed operational specifications. Although the internal protection circuitry of the device is designed to protect against thermal overall conditions, this circuitry is not intended to replace proper heat sinking. Continuously running the device into thermal shutdown or above the maximum recommended junction temperature reduces long-term reliability.

6.4 Device Functional Modes

6.4.1 Shutdown Mode

These devices can be placed in shutdown mode with a logic high at the SHUTDOWN pin. Return the logic level low to restore operation or tie SHUTDOWN to ground if the feature is not being used.

7 Application and Implementation

备注

以下应用部分中的信息不属于 TI 器件规格的范围，TI 不担保其准确性和完整性。TI 的客户应负责确定器件是否适用于其应用。客户应验证并测试其设计，以确保系统功能。

7.1 Application Information

The LP295x devices are used as low-dropout regulators with a wide range of input voltages.

7.1.1 Reverse Current

Excessive reverse current potentially damages this device. Reverse current flows through the intrinsic body diode of the pass transistor instead of the normal conducting channel. At high magnitudes, this current flow degrades the long-term reliability of the device.

Conditions where reverse current occurs are outlined in this section, all of which potentially exceed the absolute maximum rating of $V_{OUT} \leq V_{IN} + 0.3V$.

- If the device has a large C_{OUT} and the input supply collapses with little or no load current
- The output is biased when the input supply is not established
- The output is biased above the input supply

If reverse current flow is expected in the application, use external protection to protect the device. Reverse current is not limited in the device, so external limiting is required if extended reverse voltage operation is anticipated.

[图 7-1](#) shows one approach for protecting the device.



图 7-1. Example Circuit for Reverse Current Protection Using a Schottky Diode

7.1.2 Input and Output Capacitor Requirements

Although an input capacitor is not required for stability, good analog design practice is to connect a capacitor from IN to GND. This capacitor counteracts reactive input sources and improves transient response, input ripple, and PSRR. Use an input capacitor if the source impedance is more than $0.5\ \Omega$. A higher value capacitor can be necessary if large, fast rise-time load or line transients are anticipated or if the device is located several inches from the input power source.

Dynamic performance of the device is improved with the use of an output capacitor. Use an output capacitor within the range specified in the [§ 5.3](#) table for stability.

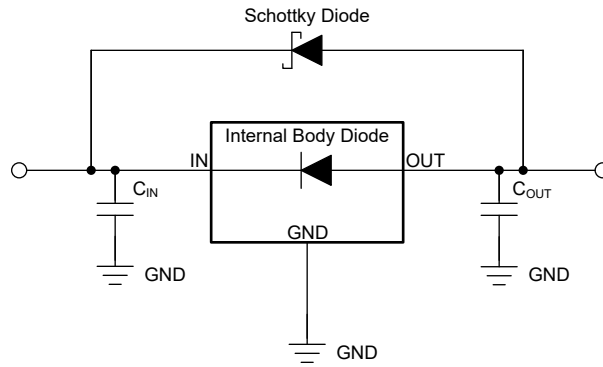
7.1.3 Estimating Junction Temperature

The JEDEC standard now recommends the use of psi (Ψ) thermal metrics to estimate the junction temperatures of the linear regulator when in-circuit on a typical PCB board application. These metrics are not thermal resistance parameters and instead offer a practical and relative way to estimate junction temperature. These psi metrics are determined to be significantly independent of the copper area available for heat-spreading. The [§ 5.4](#) table lists the primary thermal metrics, which are the junction-to-top characterization parameter (Ψ_{JT}) and junction-to-board characterization parameter (Ψ_{JB}). These parameters provide two methods for calculating the junction temperature (T_J), as described in the following equations. Use the junction-to-top characterization parameter (Ψ_{JT}) with the temperature at the center-top of device package (T_T) to calculate the junction temperature. Use the junction-to-board characterization parameter (Ψ_{JB}) with the PCB surface temperature 1mm from the device package (T_B) to calculate the junction temperature.

$$T_J = T_T + \Psi_{JT} \times P_D \quad (2)$$

where:

- P_D is the dissipated power
- T_T is the temperature at the center-top of the device package

$$T_J = T_B + \Psi_{JB} \times P_D \quad (3)$$

where:

- T_B is the PCB surface temperature measured 1mm from the device package and centered on the package edge

For detailed information on the thermal metrics and how to use the metrics, see the [Semiconductor and IC Package Thermal Metrics](#) application note.

7.1.4 Power Dissipation (P_D)

Circuit reliability requires consideration of the device power dissipation, location of the circuit on the printed circuit board (PCB), and correct sizing of the thermal plane. The PCB area around the regulator must have few or no other heat-generating devices that cause added thermal stress.

To first-order approximation, power dissipation in the regulator depends on the input-to-output voltage difference and load conditions. The following equation calculates power dissipation (P_D).

$$P_D = (V_{IN} - V_{OUT}) \times I_{OUT} \quad (4)$$

备注

Power dissipation is minimized, and therefore greater efficiency is achieved, by correct selection of the system voltage rails. For the lowest power dissipation use the minimum input voltage required for correct output regulation.

For devices with a thermal pad, the primary heat conduction path for the device package is through the thermal pad to the PCB. Solder the thermal pad to a copper pad area under the device. Make sure this pad area contains an array of plated vias that conduct heat to additional copper planes for increased heat dissipation.

The maximum power dissipation determines the maximum allowable ambient temperature (T_A) for the device. According to the following equation, power dissipation and junction temperature are most often related by the junction-to-ambient thermal resistance ($R_{\theta JA}$) of the combined PCB and device package and the temperature of the ambient air (T_A).

$$T_J = T_A + (R_{\theta JA} \times P_D) \quad (5)$$

Thermal resistance ($R_{\theta JA}$) is highly dependent on the heat-spreading capability built into the particular PCB design, and therefore varies according to the total copper area, copper weight, and location of the planes. The junction-to-ambient thermal resistance listed in the [表 5.4](#) table is determined by the JEDEC standard PCB and copper-spreading area. This thermal resistance is used as a relative measure of package thermal performance.

7.2 Typical Application



图 7-2. 12V to 5V Converter

7.2.1 Design Requirements

Minimum C_{OUT} value for stability (can be increased to 100 μ F for improved stability and transient response)

SHUTDOWN must be actively terminated. Connect to GND if shutdown feature is not used.

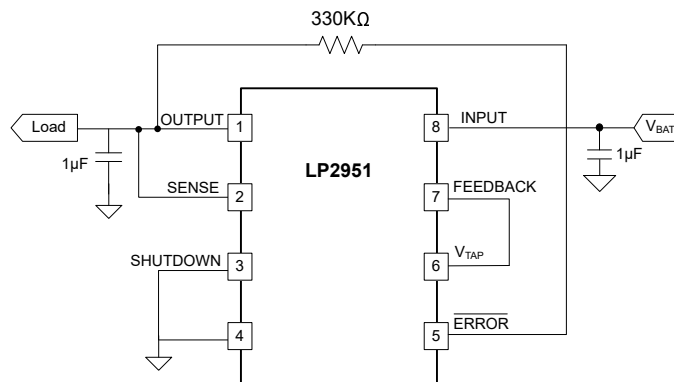
7.2.1.1 Recommended Capacitor Types

7.2.1.1.1 Recommended Capacitors for the Legacy Chip

Most tantalum or aluminum electrolytics are used at the input. Film-type capacitors also work but at higher cost. Ceramic capacitors are available for use at the output, but the low ESR (as low as $5\text{m}\Omega$ to $10\text{m}\Omega$) potentially causes the output to not meet the minimum ESR requirement. If a ceramic capacitor is used, add a series resistor between 0.1Ω to 2Ω to meet the minimum ESR requirement.

Ceramic capacitors can be used, but because of the low ESR (as low as $5\text{m}\Omega$ to $10\text{m}\Omega$), these capacitors can possibly not meet the minimum ESR requirement previously discussed. If a ceramic capacitor is used, a series resistor between 0.1Ω to 2Ω must be added to meet the minimum ESR requirement. In addition, ceramic capacitors have one glaring disadvantage that must be taken into account — a poor temperature coefficient, where the capacitance can vary significantly with temperature. For instance, a large-value ceramic capacitor ($\geq 2.2\ \mu\text{F}$) can lose more than half of the capacitance as temperature rises from 25°C to 85°C . Thus, a $2.2\ \mu\text{F}$ capacitor at 25°C drops well below the minimum C_L required for stability as ambient temperature rises. For this reason, select an output capacitor that maintains the minimum $2.2\ \mu\text{F}$ required for stability for the entire operating temperature range.

7.2.1.1.1.1 ESR Range (Legacy Chip)

The regulator control loop relies on the ESR of the output capacitor to provide a zero to add sufficient phase margin to provide unconditional regulator stability. This condition requires the closed-loop gain to intersect the open-loop response in a region where the open-loop gain rolls off at 20dB/decade . This roll off makes sure that the phase is always less than 180° (phase margin greater than 0°) at unity gain. Thus, a minimum-maximum range for the ESR must be observed.

The upper limit of this ESR range is established by the fact that an ESR that is too high can result in the zero occurring too soon, causing the gain to roll off too slowly. This effect, in turn, allows a third pole to appear before unity gain and introduces enough phase shift to cause instability. This phase shift typically limits the maximum ESR to approximately 5Ω .

Conversely, the lower limit of the ESR range is tied to the fact that an ESR that is too low shifts the zero too far out, past unity gain, which allows the gain to roll off at 40dB/decade at unity gain, resulting in a phase shift of greater than 180° . Typically, this limits the minimum ESR to approximately $20\text{m}\Omega$ to $30\text{m}\Omega$.

For specific ESR requirements, see the [§ 5.7](#) section.

7.2.1.1.2 Recommended Capacitors for the New Chip

The new chip requires an output capacitor of at least $1\ \mu\text{F}$ for stability and an equivalent series resistance (ESR) between $0\ \Omega$ and $2\ \Omega$. Without the output capacitor, the regulator oscillates. For best transient performance, use X5R- and X7R-type ceramic capacitors because these capacitors have minimal variation in value and ESR over temperature. When choosing a capacitor for a specific application, be mindful of the DC bias characteristics for the capacitor. Higher output voltages cause a significant derating of the capacitor. For best performance, the maximum recommended output capacitor is $100\ \mu\text{F}$. An input capacitor is not required for stability, however, good analog practice is to connect a capacitor (500nF or higher) between the GND and IN pin. Some input supplies have a high impedance, thus placing the input capacitor on the input supply helps reduce input impedance. This capacitor counteracts reactive input sources and improves transient response, input ripple, and PSRR. If the input supply has a high impedance over a large range of frequencies, use several input capacitors in parallel to lower the impedance over frequency. Use a higher-value capacitor if large, fast rise-time load transients are anticipated, or if the device is located several inches from the input power source.

7.2.2 Detailed Design Procedure

7.2.2.1 Feedback Resistor Selection

V_{OUT} is set by the external feedback resistors R_1 and R_2 according to the following equation:

$$V_{OUT} = V_{FB} \times \left(1 + \frac{R_1}{R_2}\right) \quad (6)$$

To ignore the FB pin current error term in the V_{OUT} equation, set the feedback divider current to 100 times the FB pin current listed in the [节 5.5](#) table. This setting provides the maximum feedback divider series resistance, as shown in the following equation:

$$R_1 + R_2 \leq \frac{V_{OUT}}{(I_{FB} \times 100)} \quad (7)$$

7.2.2.2 Feedforward Capacitor

Connect a feedforward capacitor (C_{FF}) between the OUT pin and the FB pin. C_{FF} improves transient, noise, and PSRR performance. A higher capacitance C_{FF} is possible, however, the start-up time increases. For a detailed description of C_{FF} tradeoffs, see the [Pros and Cons of Using a Feedforward Capacitor with a Low-Dropout Regulator application note](#).

As shown in [图 7-3](#), poor layout practices and using long traces at the FB pin results in the formation of a parasitic capacitor (C_{FB}).



图 7-3. Formation of Parasitic Capacitor at the FB Pin

C_{FB} , along with the feedback resistors R_1 and R_2 potentially result in the formation of an uncompensated pole in the transfer function of the loop gain. A C_{FB} value as small as 6pF potentially causes the parasitic pole frequency, given by [方程式 8](#), to fall within the bandwidth of the LDO and result in instability.

$$f_P = \frac{1}{(2 \times \pi \times C_{FB} \times (R_1 \parallel R_2))} \quad (8)$$

Adding a feedforward capacitor (C_{FF}), as shown in [图 7-4](#), creates a zero in the loop gain transfer function that can compensate for the parasitic pole created by C_{FB} . [方程式 9](#) and [方程式 10](#) calculate the pole and zero frequencies.

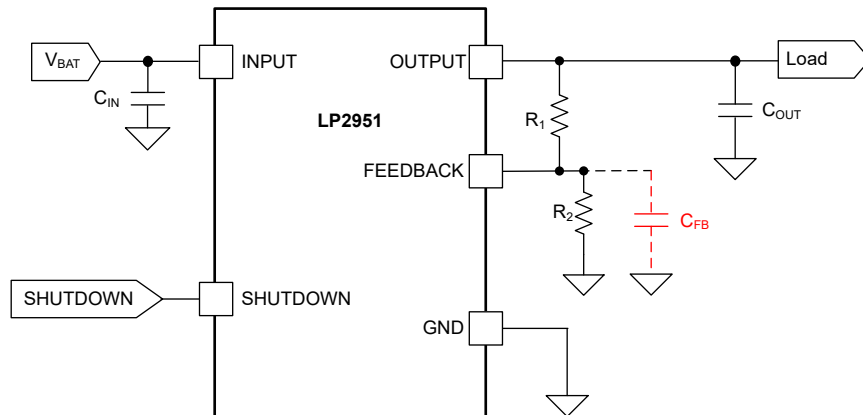

图 7-4. Feedforward Capacitor Can Compensate the Effects of the Parasitic Capacitor

$$f_p = \frac{1}{(2 \times \pi \times (R_1 \parallel R_2) \times (C_{FF} + C_{FB}))} \tag{9}$$

$$f_z = \frac{1}{(2 \times \pi \times C_{FF} \times R_1)} \tag{10}$$

The C_{FF} value that makes f_p equal to f_z , and result in a pole-zero cancellation, depends on the values of C_{FB} and the feedback resistors used in the application. Alternatively, if the feedforward capacitor is selected so that $C_{FF} \gg C_{FB}$, then the pole and zero frequencies given by 方程式 9 and 方程式 10 are related as:

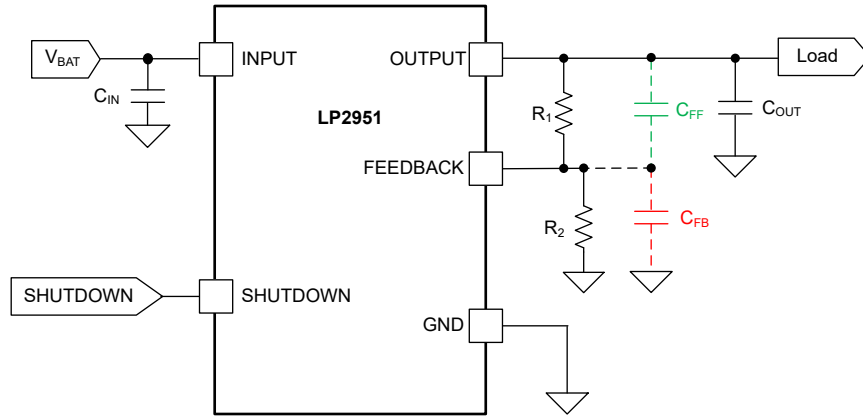
$$\frac{f_p}{f_z} \cong \left(1 + \frac{R_1}{R_2}\right) = \frac{V_{OUT}}{V_{FB}} \tag{11}$$

In most applications, particularly where a 3.3V or 5V V_{OUT} is generated, this ratio is not very large, implying that the frequencies are located close to each other and therefore the parasitic pole is compensated. Even for large V_{OUT} values, where this ratio can be as large as 20, a C_{FF} value in the range $100\text{pF} \leq C_{FF} \leq 10\text{nF}$ typically helps prevent instability caused by the parasitic capacitance on the feedback node.

7.2.3 Application Curve



图 7-5. Load Transient Response vs Time (Legacy Chip)



图 7-6. Load Transient Response vs Time (New Chip)
 $V_{IN} = 6V, V_{OUT} = 5V, I_{OUT} = 0 \text{ to } 100\text{mA}, C_{OUT} = 1 \mu\text{F}$

7.3 Power Supply Recommendations

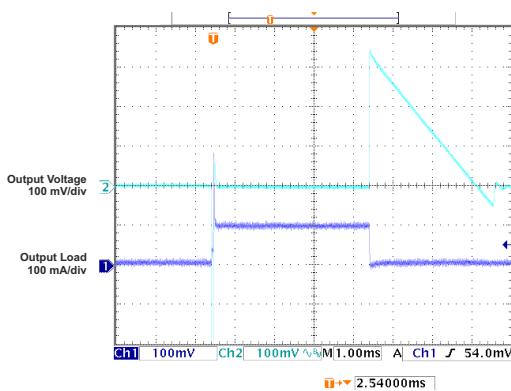
Maximum input voltage must be limited to 30V for proper operation. Place input and output capacitors as close to the device as possible to take advantage of the high frequency noise filtering properties.

7.4 Layout

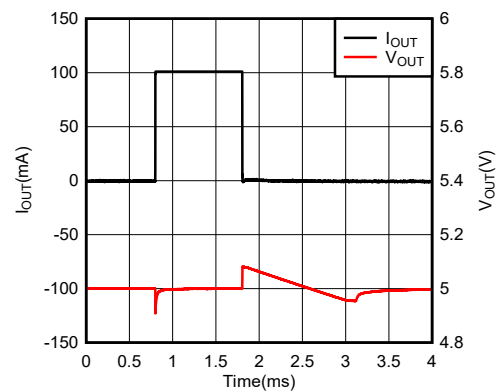
7.4.1 Layout Guidelines

Make sure that traces on the input and outputs of the device are wide enough to handle the desired currents. For this device, the output trace must be larger to accommodate the larger available current.

Place input and output capacitors as close to the device as possible to take advantage of the high-frequency, noise-filtering properties.

7.4.2 Layout Example



图 7-7. LP2951 Layout Example (D or P Package)

8 Device and Documentation Support

8.1 Device Support

8.1.1 Development Support

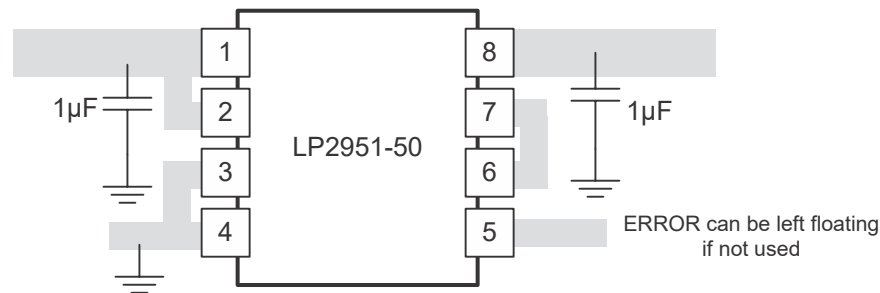
An evaluation module (EVM) is available to assist in the initial circuit performance evaluation. The [LP2951EVM](#) (and [related user guide](#)) can be requested at the Texas Instruments website through the product folders or purchased directly from the [TI eStore](#).

8.2 接收文档更新通知

要接收文档更新通知，请导航至 [ti.com](#) 上的器件产品文件夹。点击 [通知](#) 进行注册，即可每周接收产品信息更改摘要。有关更改的详细信息，请查看任何已修订文档中包含的修订历史记录。

8.3 Device Nomenclature

表 8-1. Device Nomenclature

PRODUCT ⁽¹⁾	V _{OUT}
LP2951- xx yyy z	<p>xx is the nominal output voltage (for example, 50 = 5.0V, 33 = 3.3V).</p> <p>yyy is the package designator.</p> <p>z is the package quantity.</p> <p>This device is able to output either a fixed or adjustable output from the same device. Devices can ship with the legacy chip (CSO: SHE) or the new chip (CSO: RFB). The reel packaging label provides CSO information to distinguish which chip is being used. Device performance for new and legacy chips is denoted throughout the data sheet.</p>
LP2951DR	<p>Adjustable option.</p> <p>Devices can ship with the legacy chip (CSO: SHE) or the new chip (CSO: RFB). The reel packaging label provides CSO information to distinguish which chip is being used. Device performance for new and legacy chips is denoted throughout the data sheet.</p>

表 8-1. Device Nomenclature (续)

PRODUCT ⁽¹⁾	V _{OUT}
LP2950- xx yyy z	<p>xx is the nominal output voltage (for example, 50 = 5.0V, 33 = 3.3V).</p> <p>yyy is the package designator.</p> <p>z is the package quantity.</p> <p>Devices can ship with the legacy chip (CSO: SHE) or the new chip (CSO: RFB). The reel packaging label provides CSO information to distinguish which chip is being used. Device performance for new and legacy chips is denoted throughout the data sheet.</p>

(1) For the most current package and ordering information see the Package Option Addendum at the end of this document, or see the TI website at www.ti.com.

8.4 Documentation Support

8.4.1 Related Documentation

- Texas Instruments, [LP2951EVM](#), EVM user's guide

8.5 支持资源

TI E2E™ 中文支持论坛是工程师的重要参考资料，可直接从专家处获得快速、经过验证的解答和设计帮助。搜索现有解答或提出自己的问题，获得所需的快速设计帮助。

链接的内容由各个贡献者“按原样”提供。这些内容并不构成 TI 技术规范，并且不一定反映 TI 的观点；请参阅 TI 的使用条款。

8.6 Trademarks

TI E2E™ is a trademark of Texas Instruments.

所有商标均为其各自所有者的财产。

8.7 静电放电警告



静电放电 (ESD) 会损坏这个集成电路。德州仪器 (TI) 建议通过适当的预防措施处理所有集成电路。如果不遵守正确的处理和安装程序，可能会损坏集成电路。

ESD 的损坏小至导致微小的性能降级，大至整个器件故障。精密的集成电路可能更容易受到损坏，这是因为非常细微的参数更改都可能会导致器件与其发布的规格不相符。

8.8 术语表

TI 术语表 本术语表列出并解释了术语、首字母缩略词和定义。

9 Revision History

注：以前版本的页码可能与当前版本的页码不同

Changes from Revision J (August 2024) to Revision K (December 2024)	Page
• 更新了整个文档中的表格、图和交叉参考的编号格式.....	1
• 更新了 LP 封装的精度和压降规格.....	1
• 添加了 LP 封装的热性能信息.....	1
• Updated and added corrections to the operating temperature range in Recommended Operating Conditions section.....	4

Changes from Revision I (November 2014) to Revision J (August 2024)	Page
• 更新了整个文档中的表格、图和交叉参考的编号格式.....	1
• 更改了整个文档以与当前系列格式保持一致.....	1
• 向文档添加了 M3 器件.....	1

- Added the *Device Support* section..... 29
- Changed the *Evaluation Module* section to the *Development Support* section..... 29
- Added the *Documentation Support* and *Related Documentation* sections..... 30

Changes from Revision H (March 2012) to Revision I (November 2014) Page

- 添加了应用、器件信息表、处理等级表、特性说明部分、器件功能模式、应用和实施部分、电源相关建议部分、布局部分、器件和文档支持部分以及机械、封装和可订购信息部分..... 1
- 删除了订购信息表..... 1

10 Mechanical, Packaging, and Orderable Information

The following pages include mechanical, packaging, and orderable information. This information is the most current data available for the designated devices. This data is subject to change without notice and revision of this document. For browser-based versions of this data sheet, refer to the left-hand navigation.

PACKAGING INFORMATION

Orderable Device	Status (1)	Package Type	Package Drawing	Pins	Package Qty	Eco Plan (2)	Lead finish/ Ball material (6)	MSL Peak Temp (3)	Op Temp (°C)	Device Marking (4/5)	Samples
LP2950-30LP	ACTIVE	TO-92	LP	3	1000	RoHS & Green	SN	N / A for Pkg Type	-40 to 125	KY5030	Samples
LP2950-30LPR	ACTIVE	TO-92	LP	3	2000	RoHS & Green	SN	N / A for Pkg Type	-40 to 125	KY5030	Samples
LP2950-30LPRE3	ACTIVE	TO-92	LP	3	2000	RoHS & Green	SN	N / A for Pkg Type	-40 to 125	KY5030	Samples
LP2950-33LPE3	ACTIVE	TO-92	LP	3	1000	RoHS & Non-Green	SN	N / A for Pkg Type	-40 to 125	KY5033	Samples
LP2950-33LPRE3	ACTIVE	TO-92	LP	3	2000	RoHS & Green	SN	N / A for Pkg Type	-40 to 125	KY5033	Samples
LP2950-50LPRE3	ACTIVE	TO-92	LP	3	2000	RoHS & Green	SN	N / A for Pkg Type	-40 to 125	KY5050	Samples
LP2951-30D	ACTIVE	SOIC	D	8	75	RoHS & Green	NIPDAU	Level-1-260C-UNLIM	-40 to 125	KY5130	Samples
LP2951-30DR	ACTIVE	SOIC	D	8	2500	RoHS & Green	NIPDAU	Level-1-260C-UNLIM	-40 to 125	KY5130	Samples
LP2951-30DRGR	ACTIVE	SON	DRG	8	3000	RoHS & Green	NIPDAU	Level-2-260C-1 YEAR	-40 to 125	ZUD	Samples
LP2951-33D	ACTIVE	SOIC	D	8	75	RoHS & Green	NIPDAU	Level-1-260C-UNLIM	-40 to 125	KY5133	Samples
LP2951-33DR	ACTIVE	SOIC	D	8	2500	RoHS & Green	NIPDAU	Level-1-260C-UNLIM	-40 to 125	KY5133	Samples
LP2951-33DRG4	ACTIVE	SOIC	D	8	2500	RoHS & Green	NIPDAU	Level-1-260C-UNLIM	-40 to 125	KY5133	Samples
LP2951-33DRGR	ACTIVE	SON	DRG	8	3000	RoHS & Green	NIPDAU	Level-2-260C-1 YEAR	-40 to 125	ZUE	Samples
LP2951-50D	ACTIVE	SOIC	D	8	75	RoHS & Green	NIPDAU	Level-1-260C-UNLIM	-40 to 125	KY5150	Samples
LP2951-50DR	ACTIVE	SOIC	D	8	2500	RoHS & Green	NIPDAU	Level-1-260C-UNLIM	-40 to 125	KY5150	Samples
LP2951-50DRG4	ACTIVE	SOIC	D	8	2500	RoHS & Green	NIPDAU	Level-1-260C-UNLIM	-40 to 125	KY5150	Samples
LP2951-50DRGR	ACTIVE	SON	DRG	8	3000	RoHS & Green	NIPDAU	Level-2-260C-1 YEAR	-40 to 125	ZUF	Samples
LP2951D	ACTIVE	SOIC	D	8	75	RoHS & Green	NIPDAU	Level-1-260C-UNLIM	-40 to 125	LP2951	Samples
LP2951DR	ACTIVE	SOIC	D	8	2500	RoHS & Green	NIPDAU	Level-1-260C-UNLIM	-40 to 125	LP2951	Samples
LP2951DRG4	ACTIVE	SOIC	D	8	2500	RoHS & Green	NIPDAU	Level-1-260C-UNLIM	-40 to 125	LP2951	Samples

(1) The marketing status values are defined as follows:

ACTIVE: Product device recommended for new designs.

LIFEBUY: TI has announced that the device will be discontinued, and a lifetime-buy period is in effect.

NRND: Not recommended for new designs. Device is in production to support existing customers, but TI does not recommend using this part in a new design.

PREVIEW: Device has been announced but is not in production. Samples may or may not be available.

OBSOLETE: TI has discontinued the production of the device.

(2) **RoHS:** TI defines "RoHS" to mean semiconductor products that are compliant with the current EU RoHS requirements for all 10 RoHS substances, including the requirement that RoHS substance do not exceed 0.1% by weight in homogeneous materials. Where designed to be soldered at high temperatures, "RoHS" products are suitable for use in specified lead-free processes. TI may reference these types of products as "Pb-Free".

RoHS Exempt: TI defines "RoHS Exempt" to mean products that contain lead but are compliant with EU RoHS pursuant to a specific EU RoHS exemption.

Green: TI defines "Green" to mean the content of Chlorine (Cl) and Bromine (Br) based flame retardants meet JS709B low halogen requirements of ≤ 1000 ppm threshold. Antimony trioxide based flame retardants must also meet the ≤ 1000 ppm threshold requirement.

(3) MSL, Peak Temp. - The Moisture Sensitivity Level rating according to the JEDEC industry standard classifications, and peak solder temperature.

(4) There may be additional marking, which relates to the logo, the lot trace code information, or the environmental category on the device.

(5) Multiple Device Markings will be inside parentheses. Only one Device Marking contained in parentheses and separated by a "~" will appear on a device. If a line is indented then it is a continuation of the previous line and the two combined represent the entire Device Marking for that device.

(6) Lead finish/Ball material - Orderable Devices may have multiple material finish options. Finish options are separated by a vertical ruled line. Lead finish/Ball material values may wrap to two lines if the finish value exceeds the maximum column width.

Important Information and Disclaimer:The information provided on this page represents TI's knowledge and belief as of the date that it is provided. TI bases its knowledge and belief on information provided by third parties, and makes no representation or warranty as to the accuracy of such information. Efforts are underway to better integrate information from third parties. TI has taken and continues to take reasonable steps to provide representative and accurate information but may not have conducted destructive testing or chemical analysis on incoming materials and chemicals. TI and TI suppliers consider certain information to be proprietary, and thus CAS numbers and other limited information may not be available for release.

In no event shall TI's liability arising out of such information exceed the total purchase price of the TI part(s) at issue in this document sold by TI to Customer on an annual basis.

OTHER QUALIFIED VERSIONS OF LP2951 :

- Automotive : [LP2951-Q1](#)

NOTE: Qualified Version Definitions:

- Automotive - Q100 devices qualified for high-reliability automotive applications targeting zero defects

TAPE AND REEL INFORMATION

QUADRANT ASSIGNMENTS FOR PIN 1 ORIENTATION IN TAPE

*All dimensions are nominal

Device	Package Type	Package Drawing	Pins	SPQ	Reel Diameter (mm)	Reel Width W1 (mm)	A0 (mm)	B0 (mm)	K0 (mm)	P1 (mm)	W (mm)	Pin1 Quadrant
LP2951-30DR	SOIC	D	8	2500	330.0	12.4	6.4	5.2	2.1	8.0	12.0	Q1
LP2951-30DRGR	SON	DRG	8	3000	330.0	12.4	3.3	3.3	1.1	8.0	12.0	Q2
LP2951-33DR	SOIC	D	8	2500	330.0	12.4	6.4	5.2	2.1	8.0	12.0	Q1
LP2951-33DRGR	SON	DRG	8	3000	330.0	12.4	3.3	3.3	1.1	8.0	12.0	Q2
LP2951-50DR	SOIC	D	8	2500	330.0	12.4	6.4	5.2	2.1	8.0	12.0	Q1
LP2951-50DR	SOIC	D	8	2500	330.0	12.4	6.4	5.2	2.1	8.0	12.0	Q1
LP2951-50DRGR	SON	DRG	8	3000	330.0	12.4	3.3	3.3	1.1	8.0	12.0	Q2
LP2951DR	SOIC	D	8	2500	330.0	12.4	6.4	5.2	2.1	8.0	12.0	Q1
LP2951DR	SOIC	D	8	2500	330.0	12.4	6.4	5.2	2.1	8.0	12.0	Q1

TAPE AND REEL BOX DIMENSIONS



*All dimensions are nominal

Device	Package Type	Package Drawing	Pins	SPQ	Length (mm)	Width (mm)	Height (mm)
LP2951-30DR	SOIC	D	8	2500	353.0	353.0	32.0
LP2951-30DRGR	SON	DRG	8	3000	367.0	367.0	35.0
LP2951-33DR	SOIC	D	8	2500	340.5	338.1	20.6
LP2951-33DRGR	SON	DRG	8	3000	367.0	367.0	35.0
LP2951-50DR	SOIC	D	8	2500	353.0	353.0	32.0
LP2951-50DR	SOIC	D	8	2500	340.5	338.1	20.6
LP2951-50DRGR	SON	DRG	8	3000	367.0	367.0	35.0
LP2951DR	SOIC	D	8	2500	340.5	338.1	20.6
LP2951DR	SOIC	D	8	2500	353.0	353.0	32.0

TUBE

*All dimensions are nominal

Device	Package Name	Package Type	Pins	SPQ	L (mm)	W (mm)	T (μm)	B (mm)
LP2951-30D	D	SOIC	8	75	507	8	3940	4.32
LP2951-33D	D	SOIC	8	75	507	8	3940	4.32
LP2951-50D	D	SOIC	8	75	507	8	3940	4.32
LP2951D	D	SOIC	8	75	507	8	3940	4.32



D0008A

PACKAGE OUTLINE

SOIC - 1.75 mm max height

SMALL OUTLINE INTEGRATED CIRCUIT



4214825/C 02/2019

NOTES:

- Linear dimensions are in inches [millimeters]. Dimensions in parenthesis are for reference only. Controlling dimensions are in inches. Dimensioning and tolerancing per ASME Y14.5M.
- This drawing is subject to change without notice.
- This dimension does not include mold flash, protrusions, or gate burrs. Mold flash, protrusions, or gate burrs shall not exceed $.006$ [0.15] per side.
- This dimension does not include interlead flash.
- Reference JEDEC registration MS-012, variation AA.

EXAMPLE BOARD LAYOUT

D0008A

SOIC - 1.75 mm max height

SMALL OUTLINE INTEGRATED CIRCUIT



LAND PATTERN EXAMPLE
EXPOSED METAL SHOWN
SCALE:8X



SOLDER MASK DETAILS

4214825/C 02/2019

NOTES: (continued)

- 6. Publication IPC-7351 may have alternate designs.
- 7. Solder mask tolerances between and around signal pads can vary based on board fabrication site.

EXAMPLE STENCIL DESIGN

D0008A

SOIC - 1.75 mm max height

SMALL OUTLINE INTEGRATED CIRCUIT



SOLDER PASTE EXAMPLE
BASED ON .005 INCH [0.125 MM] THICK STENCIL
SCALE:8X

4214825/C 02/2019

NOTES: (continued)

8. Laser cutting apertures with trapezoidal walls and rounded corners may offer better paste release. IPC-7525 may have alternate design recommendations.
9. Board assembly site may have different recommendations for stencil design.

DRG (S-PWSON-N8)

PLASTIC SMALL OUTLINE NO-LEAD



- NOTES:
- A. All linear dimensions are in millimeters. Dimensioning and tolerancing per ASME Y14.5M-1994.
 - B. This drawing is subject to change without notice.
 - C. SON (Small Outline No-Lead) package configuration.
 - D. The package thermal pad must be soldered to the board for thermal and mechanical performance. See the Product Data Sheet for details regarding the exposed thermal pad dimensions.
 - E. JEDEC MO-229 package registration pending.

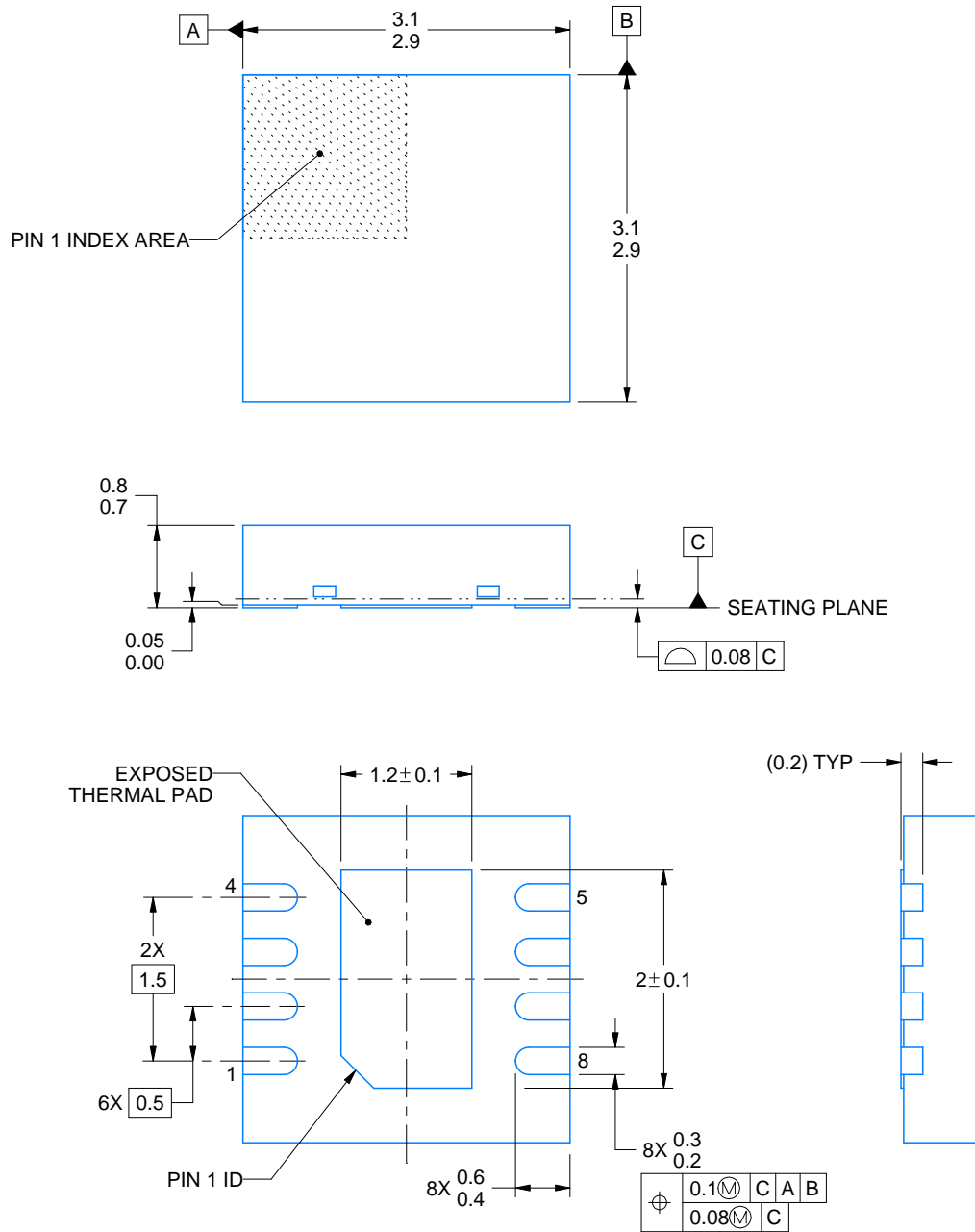
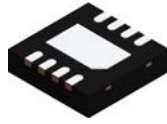

4218885/A 03/2020

NOTES:

1. All linear dimensions are in millimeters. Any dimensions in parenthesis are for reference only. Dimensioning and tolerancing per ASME Y14.5M.
2. This drawing is subject to change without notice.
3. The package thermal pad must be soldered to the printed circuit board for thermal and mechanical performance.

EXAMPLE BOARD LAYOUT

DRG0008A

WSON - 0.8 mm max height

PLASTIC SMALL OUTLINE - NO LEAD

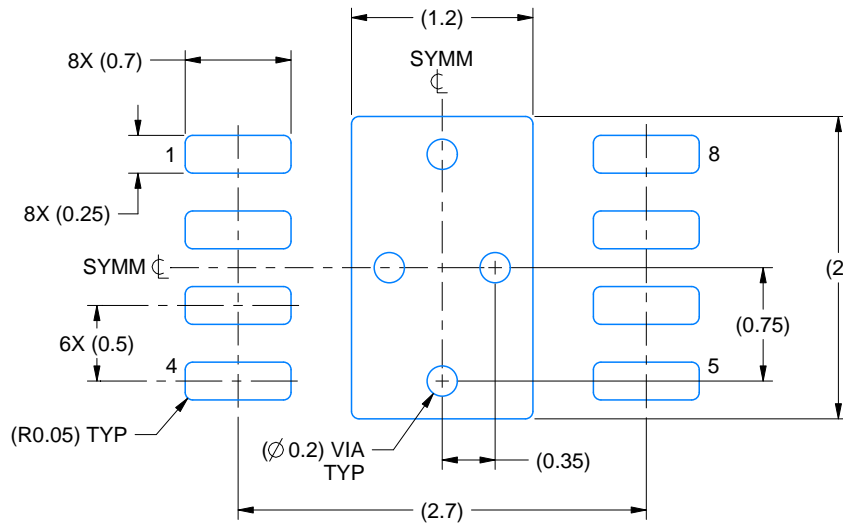

LAND PATTERN EXAMPLE
EXPOSED METAL SHOWN
SCALE:20X

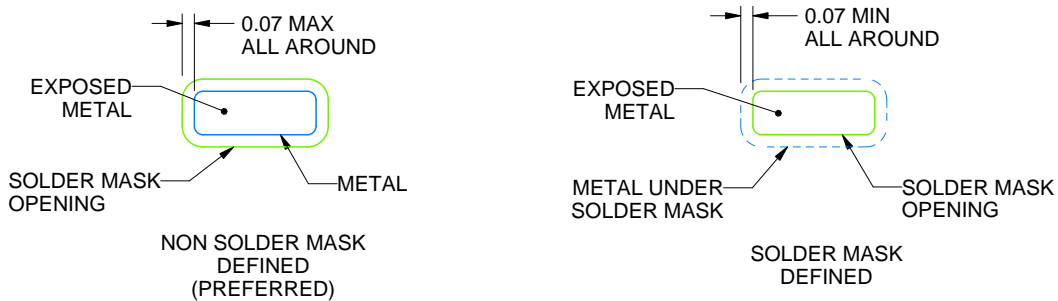

SOLDER MASK DETAILS

4218885/A 03/2020

NOTES: (continued)

4. This package is designed to be soldered to a thermal pad on the board. For more information, see Texas Instruments literature number SLUA271 (www.ti.com/lit/sluea271).
5. Vias are optional depending on application, refer to device data sheet. If any vias are implemented, refer to their locations shown on this view. It is recommended that vias under paste be filled, plugged or tented.

EXAMPLE STENCIL DESIGN

DRG0008A

WSO - 0.8 mm max height

PLASTIC SMALL OUTLINE - NO LEAD

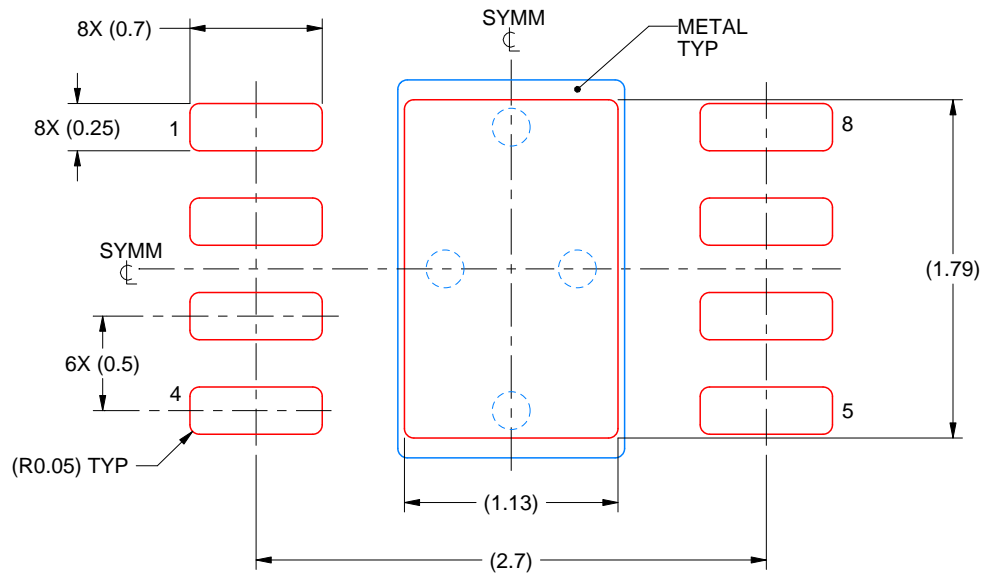

SOLDER PASTE EXAMPLE
BASED ON 0.125 mm THICK STENCIL

EXPOSED PAD
84% PRINTED SOLDER COVERAGE BY AREA
SCALE:25X

4218885/A 03/2020

NOTES: (continued)

6. Laser cutting apertures with trapezoidal walls and rounded corners may offer better paste release. IPC-7525 may have alternate design recommendations.

GENERIC PACKAGE VIEW

LP 3

TO-92 - 5.34 mm max height

TRANSISTOR OUTLINE

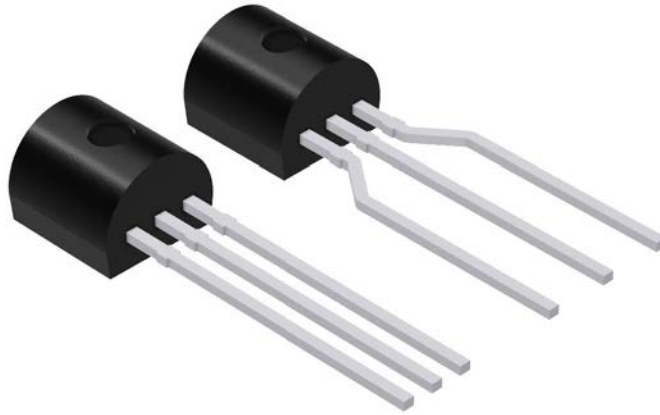

Images above are just a representation of the package family, actual package may vary.
Refer to the product data sheet for package details.

4040001-2/F

LP0003A



PACKAGE OUTLINE

TO-92 - 5.34 mm max height

TO-92

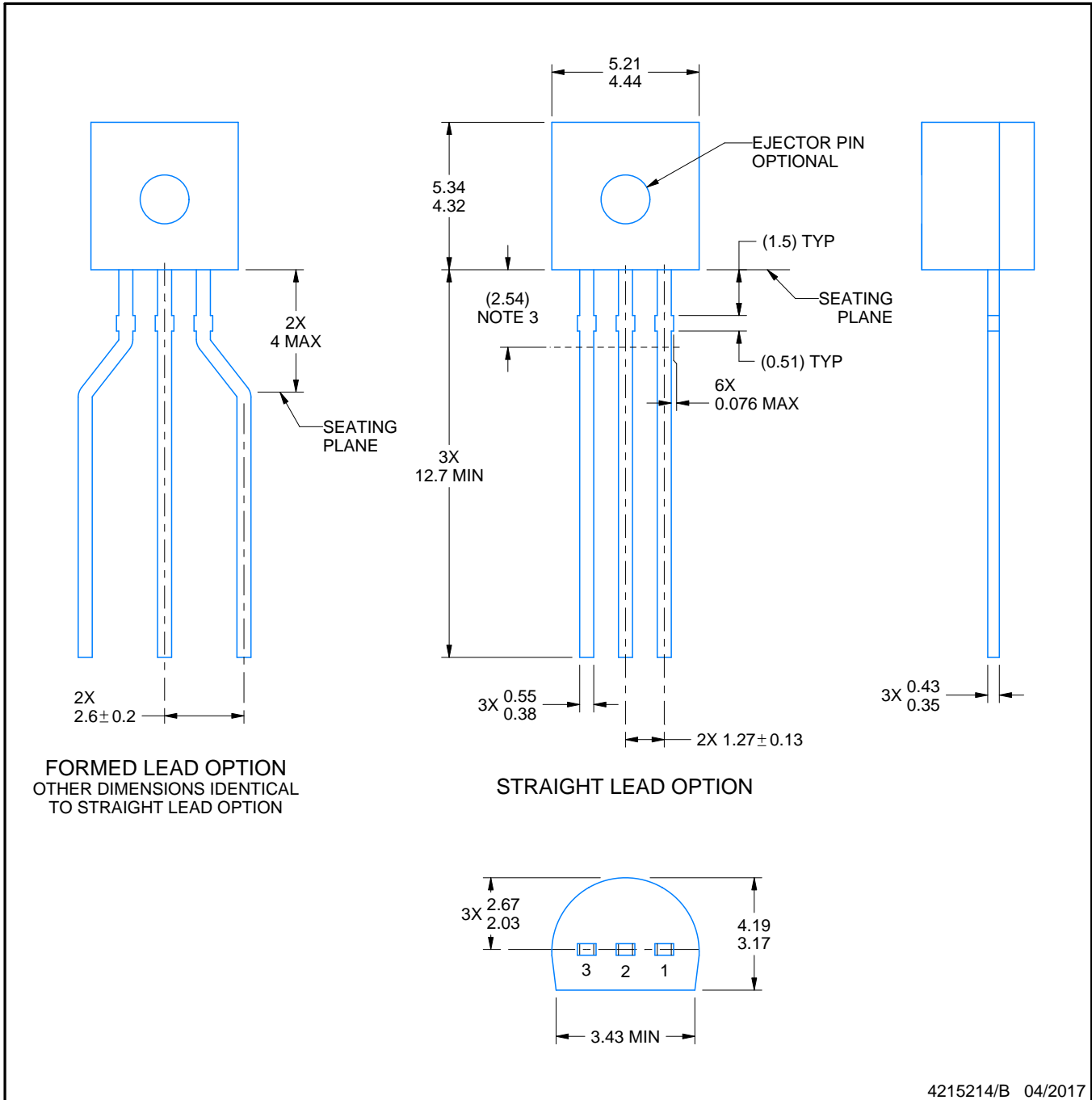

4215214/B 04/2017

NOTES:

1. All linear dimensions are in millimeters. Any dimensions in parenthesis are for reference only. Dimensioning and tolerancing per ASME Y14.5M.
2. This drawing is subject to change without notice.
3. Lead dimensions are not controlled within this area.
4. Reference JEDEC TO-226, variation AA.
5. Shipping method:
 - a. Straight lead option available in bulk pack only.
 - b. Formed lead option available in tape and reel or ammo pack.
 - c. Specific products can be offered in limited combinations of shipping medium and lead options.
 - d. Consult product folder for more information on available options.

EXAMPLE BOARD LAYOUT

LP0003A

TO-92 - 5.34 mm max height

TO-92



LAND PATTERN EXAMPLE
STRAIGHT LEAD OPTION
NON-SOLDER MASK DEFINED
SCALE:15X



LAND PATTERN EXAMPLE
FORMED LEAD OPTION
NON-SOLDER MASK DEFINED
SCALE:15X

4215214/B 04/2017

TAPE SPECIFICATIONS

LP0003A

TO-92 - 5.34 mm max height

TO-92



FOR FORMED LEAD OPTION PACKAGE

4215214/B 04/2017

重要通知和免责声明

TI“按原样”提供技术和可靠性数据（包括数据表）、设计资源（包括参考设计）、应用或其他设计建议、网络工具、安全信息和其他资源，不保证没有瑕疵且不做任何明示或暗示的担保，包括但不限于对适销性、某特定用途方面的适用性或不侵犯任何第三方知识产权的暗示担保。

这些资源可供使用 TI 产品进行设计的熟练开发人员使用。您将自行承担以下全部责任：(1) 针对您的应用选择合适的 TI 产品，(2) 设计、验证并测试您的应用，(3) 确保您的应用满足相应标准以及任何其他功能安全、信息安全、监管或其他要求。

这些资源如有变更，恕不另行通知。TI 授权您仅可将这些资源用于研发本资源所述的 TI 产品的相关应用。严禁以其他方式对这些资源进行复制或展示。您无权使用任何其他 TI 知识产权或任何第三方知识产权。您应全额赔偿因在这些资源的使用中对 TI 及其代表造成的任何索赔、损害、成本、损失和债务，TI 对此概不负责。

TI 提供的产品受 [TI 的销售条款](#) 或 [ti.com](#) 上其他适用条款/TI 产品随附的其他适用条款的约束。TI 提供这些资源并不会扩展或以其他方式更改 TI 针对 TI 产品发布的适用的担保或担保免责声明。

TI 反对并拒绝您可能提出的任何其他或不同的条款。

邮寄地址：Texas Instruments, Post Office Box 655303, Dallas, Texas 75265
版权所有 © 2025，德州仪器 (TI) 公司