

Isolated Multiple Output Flyback Converter Design Using TL494

Srivatsa Raghunath

ABSTRACT

The TL494 is one of the earliest pulse-width-modulation (PWM) controllers used in switched mode power supplies. It incorporates all the functions required in the construction of a PWM control circuit on a single chip. Designed primarily for power-supply control, this device offers the flexibility to tailor the power-supply control circuitry to a specific application. This application report discusses building a multiple-output low-cost isolated flyback converter with the TL494. Component selection and magnetics design is also shown. Before current mode control was successfully implemented, the TL494 PWM mode ensured low EMI and noise operation due to its trailing edge modulation technique. The power supply is designed for +5-, +15-, and +15-V outputs. It is self-contained with overcurrent and overvoltage protections, and the PI controller is designed to limit the highest power output. Each stage of the flyback converter design and component selection is explained. A MathCAD file is available along with this document, which helps in design calculation.

Topic	Page
1 Specifications.....	2
2 Transformer Design	3
3 Wire Gauge Selection	4
4 Window Area Check	5
5 Snubber Design	6
6 Output Capacitor Design	7
7 Soft Start Circuit	7
8 Compensator Design.....	8
9 Gate Drive	11
10 Current Limit	11
11 Final Circuit Diagram	12
12 Test Results	13
13 Conclusion	24

1 Specifications

1.1 User Specifications

- Nominal input voltage $V_{in_nom} = 325\text{ V}$
- Minimum input voltage $V_{in_min} = 260\text{ V}$
- Maximum input voltage $V_{in_max} = 390\text{ V}$
- Tolerance % = 20
- Output ripple voltage = 50 mV
- Output voltages $V_o = +15\text{ V}, +15\text{ V}, +5\text{ V}$
- Maximum load current $I_o = 0.5\text{ A}, 0.5\text{ A}, 3\text{ A}$
- Minimum load current $I_{o_min} = 0.1\text{ A}, 0.1\text{ A}, 0.3\text{ A}$
- Maximum output power $P_o = 30\text{ W}$

1.2 Designer Specifications

Switching frequency $f_{sw} = 40\text{ kHz}$

1.3 Switch Specifications

Switch specifications are known to start the flyback magnetics design switch selected is the 2SK2605 N-Channel enhancement type MOSFET 2SK2605 specifications:

- $V_{DS_max} = 800\text{ V}$
- $I_{DS_max} = 5\text{ A}$
- $t_r = 40\text{ ns}$
- $t_f = 40\text{ ns}$
- $R_{ds\ on} = 1.9\ \Omega$
- $Q_g\ \text{total} = 34\text{ nC}$
- $V_{GS} = 10\text{ V}$

2 Transformer Design

Detailed calculations are shown in the MathCAD file and summarized in the following:

Step 1: Calculate turns ratio 1:n.

Considering a safety margin of 8%:

$$V_{in_max} + \frac{V_o + V_d}{n} < V_{DS_max} - \frac{8}{100} V_{DS_max} \quad (1)$$

Step 2: Calculate maximum duty ratio D_{max} .

Considering the equivalent primary referred buck-boost circuit:

$$D_{max} = \frac{\left(\frac{V_o + V_d}{n}\right)}{\left(\frac{V_o + V_d}{n}\right) + V_{in_min}} \quad (2)$$

A more accurate estimate for D_{max} is calculated by considering a theoretical efficiency estimate of 70% as:

$$D_{max} = \frac{I_{in_max}}{I_{in_max} + n \times I_{o_max}} \quad (3)$$

Step 3: Calculate inductor ripple current rating.

Average inductor current in input referred buck-boost circuit is given by [Equation 4](#).

$$I_{Ldc} = \frac{n \times I_{o_max}}{1 - D_{max}} \quad (4)$$

This gives $\Delta i = r \times I_{Ldc}$, where r is the ripple factor, = 0.4 to 1.

Step 3a: CCM check at I_{o_min} (if:

$$I_{o_min} \geq \frac{\Delta i}{2}, \text{ then CCM ensured})$$

Step 3b: Flyback choke design

Inductance value in primary referred circuit:

$$L_p = \frac{V_{in_min} \times D_{max}}{\Delta i \times f_s} \quad (5)$$

Peak inductor current:

$$I_{PK} = I_{Ldc} + \frac{\Delta i}{2} \quad (6)$$

Core specifications: EE-42/21/15 core

- $A_c = 1.82 \times 10^{-4} \text{ m}^2$
- $A_w = 2.56 \times 10^{-4} \text{ m}^2$
- $l_m = 9.75 \times 10^{-2} \text{ m}$
- $A_p = 4.6592 \times 10^{-8} \text{ m}^4$
- $\mu_r = 2000$
- $B_m = 0.25 \text{ T}$

Air gap: Select air gap thickness l_g as per selected core. To store energy, the transformer core needs an air gap. This is the main difference in transformer design for a flyback versus a transformer design for forward converter types.

$$\wedge = \frac{\mu_o \times \mu_r \times A_c}{l_m + \mu_r \times l_g} \quad (7)$$

Number of primary and secondary turns:

Equation 8 shows the number of primary turns.

$$N_p = \sqrt{\frac{L_p}{\wedge}} \quad (8)$$

Equation 9 shows the number of secondary turns.

$$N_s = n \times N_p \quad (9)$$

Check for the possibility of core saturation. $B < B_m$ ensures that the core will not saturate.

$$B = \frac{L_m \times I_{PK}}{N_p \times A_c} \quad (10)$$

3 Wire Gauge Selection

3.1 Primary RMS Current

Equation 11 shows the equation for primary RMS current.

$$I_{p_rms} = \sqrt{\left[3 \times I_{Ldc}^2 + \left(\frac{\Delta i}{2} \right)^2 \right] \times \frac{D_{max}}{3}} \quad (11)$$

Required wire cross sectional area:

$$a_{pri} = \frac{I_{p_rms}}{J} \quad (12)$$

Choice of wire: SWG22

3.2 Secondary RMS Current

Equation 13 shows the equation for secondary RMS current.

$$I_{s_rms} = \frac{I_{o_max}}{\sqrt{1 - D_{max}}} \quad (13)$$

Required wire cross sectional area:

$$a_{sec} = \frac{I_{s_rms}}{J} \quad (14)$$

Choice of wire: SWG 30 / 28

4 Window Area Check

Choose a window utilization factor of $K_w = 0.3$.

Thus, the available window area is $A_w \times K_w = 0.0000768 \text{ m}^2$.

We need an area of $N_p \times a_{pri} + N_s \times a_{sec}$.

Thus $N_p \times a_{pri} + N_s \times a_{sec} < A_w \times K_w$.

Calculate the transformer magnetic details from the previously submitted MATLAB design file for EE4215 core.

To summarize:

- NP = 62T (split primary is used, 31T in one layer of 28 SWG wire gauge)
- NS1 (5 V) = 5T (22 SWG wire gauge)
- NS2 (15 V) = 17T (30 SWG wire gauge)
- NS3 (15 V) = 17T (30 SWG wire gauge)
- NBias (12 V) = 12T (30 SWG wire gauge)
- LP = 370 μH (leakage of < 5 μH)

Discontinuous mode of operation is chosen. Thus, the ripple factor $K_{RF} = 1$.

$$K_{RP} = \Delta I / 2I_{avg}$$

$$K_{RP} = 1 \text{ (DCM)}$$

$$K_{RP} < 1 \text{ (CCM)}$$

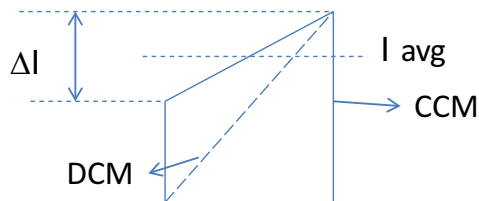

Figure 1. Inductor Current Ripple Factor

5 Snubber Design

By practical measurement, the leakage inductance for the flyback choke was found to be $L_{lk} = 10 \mu\text{H}$. The power dissipated in the snubber circuit is given by:

$$P_s = \frac{1}{2} \times V_s \times I_{PK} \times t_s \times f_s \quad (15)$$

where

$$t_s = \frac{L_{lk} \times I_{PK}}{\left(V_s - \frac{V_o}{n} \right)} \quad (16)$$

Figure 2 reveals a knee. The closer V_s is to V_o / n , the greater the power dissipation.

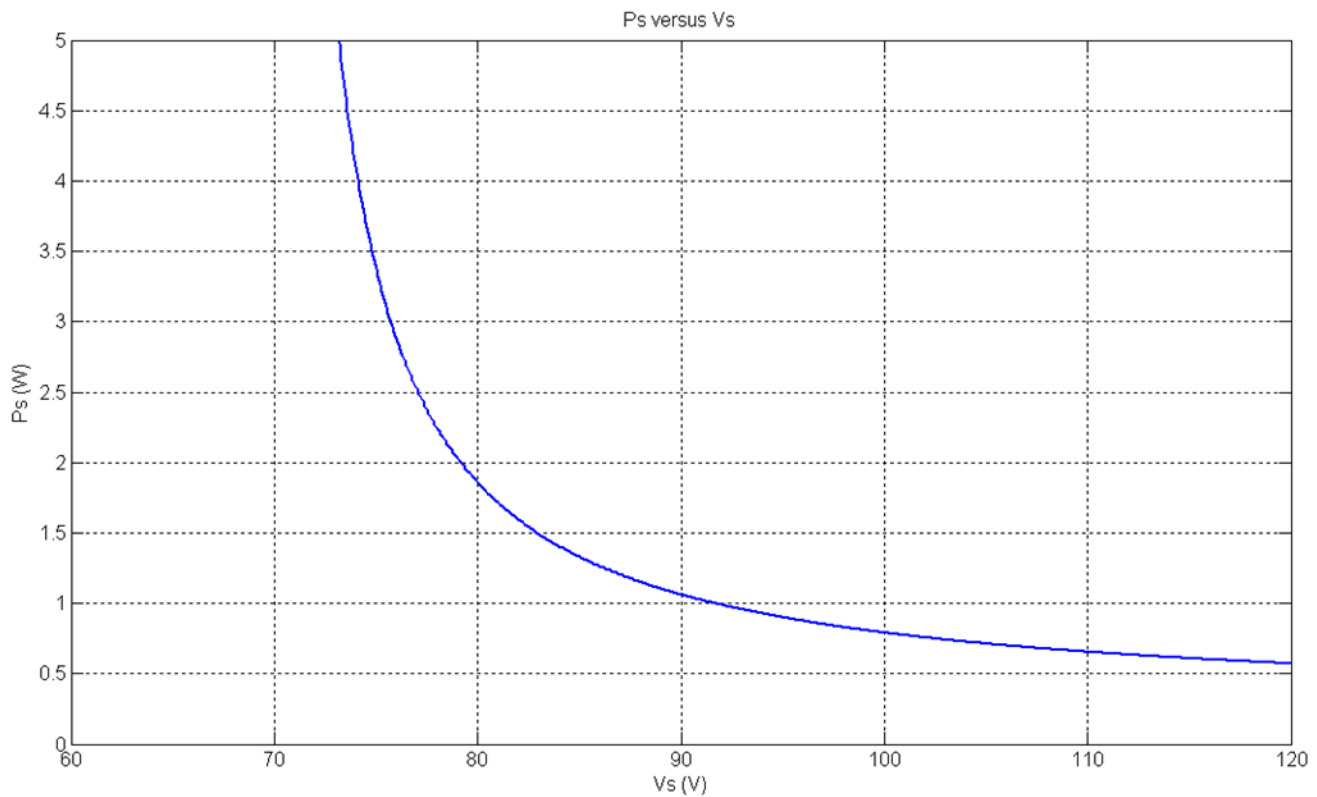

Figure 2. P_s vs V_s

V_s is constrained to be less than: $V_{DS_max} - V_{in_max} = 110 \text{ V}$.

Thus, select $V_s \approx 100 \text{ V}$.

Time to reset leakage inductance:

$$t_s = \frac{L_{lk} \times I_{PK}}{\left(V_s - \frac{V_o}{n} \right)} = 9.33661 \times 10^{-7} \text{ s} \quad (17)$$

Snubber resistance:

$$R_s = \frac{P_s^2}{V_s} = 15159.64612 \Omega \quad (18)$$

Snubber capacitance:

Allow a voltage ripple: $\Delta V_s = 8\%$ of $V_s = 8.3$ V

$$\text{Thus, } C_s = \frac{V_s}{R_s \times f_s \times \Delta V_s} = 20.6139 \text{ nF}$$

6 Output Capacitor Design

In the primary side referred buck-boost converter circuit, C_o reflects as $C_{op} = n^2 \times C_o$. An output ripple of $\Delta V_o = 50$ mV is equivalent to an input referred ripple of:

$$\Delta V_{op} = \frac{\Delta V_o}{n} = 0.2219 \text{ V} \quad (19)$$

$$\text{This gives: } C_{op} = \frac{n \times I_o \times D_{max}}{\Delta V_{op} \times f_s} = 6.7945 \times 10^{-6} \text{ F}$$

Output capacitors are designed as per the previously submitted MATLAB file.

To summarize:

- 5-V output capacitors: 1000 μ F (x3)
- 15-V output capacitors: 100 μ F (x2)
- 15-V output capacitors: 100 μ F (x2)
- 12-V bias output capacitors: 22 μ F (x1)

7 Soft Start Circuit

A soft start circuit is provided to reduce stress on switching transistors at startup.

8 Compensator Design

Open loop plant transfer function:

Effective inductance value in output LC filter:

$$L_e = \frac{L_p}{(1 - D_{\max})^2} = 0.02637 \text{ H} \quad (20)$$

This gives double pole location at:

$$f_p = \frac{1}{2\pi\sqrt{L_e \times C_o}} = 132.9 \text{ Hz} \quad (21)$$

Right half-plane zero location:

$$f_{z_RHP} = \frac{1}{2\pi \times L_e \times n^2 \times D_{\max}} = 6659.9 \text{ Hz} \quad (22)$$

ESR zero location:

$$f_{z_ESR} = \frac{1}{2\pi \times \text{ESR} \times C_o} = 2973.1 \text{ Hz} \quad (23)$$

$$G = \frac{V_{in} \times n}{V_{\text{ramp}} \times (1 - D)^2} = 54.66 \quad (24)$$

Plant transfer function:

$$P(s) = G \frac{\left(1 - \frac{s}{w_{\text{ESR}}}\right) \times \left(1 + \frac{s}{w_{\text{RHP}}}\right)}{\left(1 - \frac{s}{w_p}\right)^2} \quad (25)$$

Thus, compensator should add a 0 at f_p . Also, the user must limit the BW of the system with an open-loop crossover of:

$$f_{\text{cross}} = \frac{f_{z_RHP}}{8} \approx 800 \text{ Hz} \quad (26)$$

This is one of the major drawbacks of voltage mode control wherein the transient response of the system is poor for load and line transients.

The open loop bode plot is shown in [Figure 3](#).

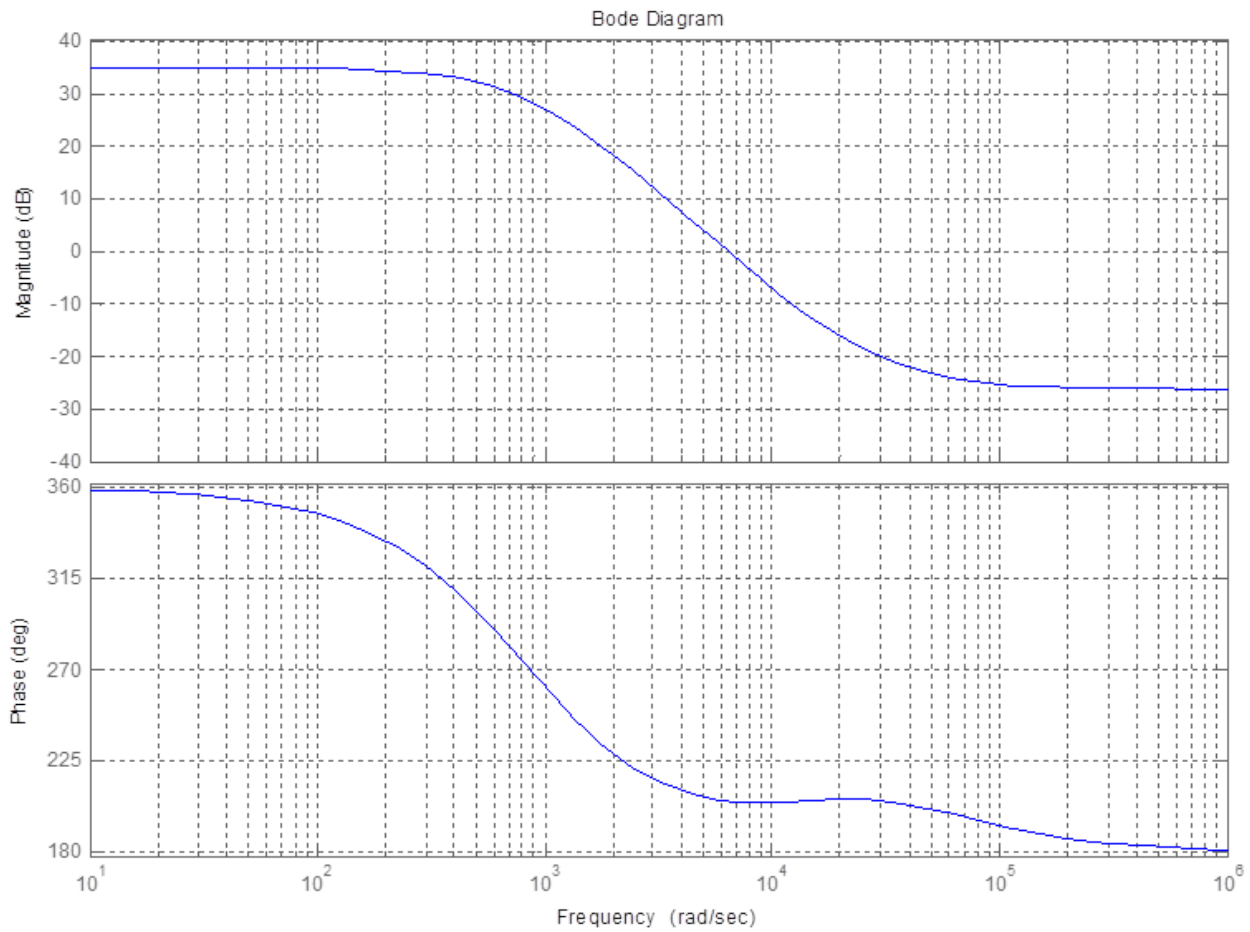

Figure 3. Open Loop Bode

The compensator circuit is shown in Figure 4:

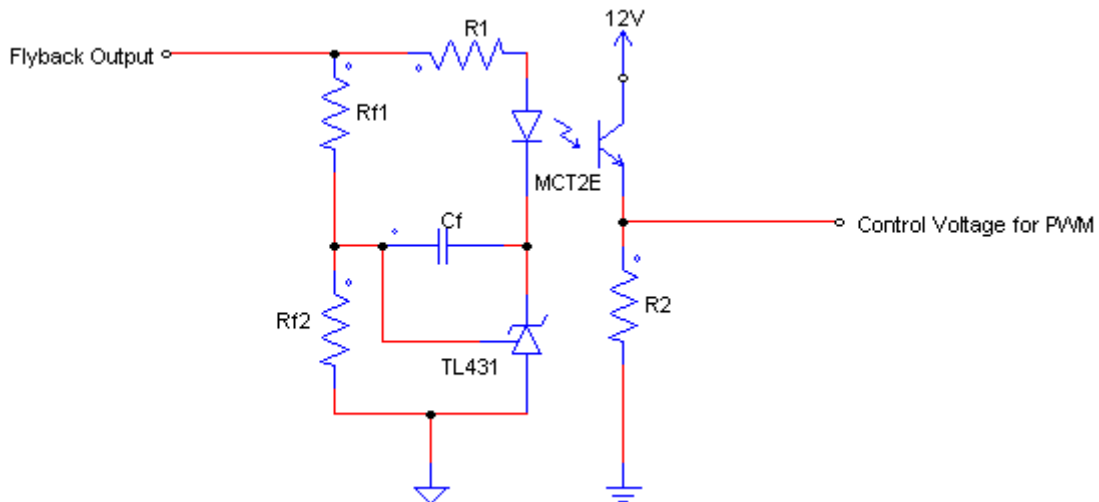

Figure 4. Compensator Circuit

The compensator zero is positioned to cancel one of the double poles at f_p .

Thus:

$$f_z = \frac{1}{2\pi \times R_{f1} \times C_f} = 132.9 \text{ Hz} \tag{27}$$

$R_{f1} = 50 \text{ k}\Omega$ and $R_{f2} = 10 \text{ k}\Omega$ in order to get 2.5 V from 15 V at the reference pin of TL431.

This gives 2.5 V at the reference pin of TL431.

This gives $C_f = 24.11 \text{ nF}$.

$R_1 = 4 \text{ k}\Omega$ is selected by taking into consideration the minimum bias current of TL431 and maximum forward diode current of MCT2E.

To achieve an open loop crossover frequency of $f_{\text{cross}} = 800 \text{ Hz}$, compensator gain is required to be equal $\frac{1}{A_O}$, where $A_O = 1.7782$ at 800 Hz from the previous plot.

Thus, Equation 28 gives $R_2 \approx 4 \text{ k}\Omega$ considering a CTR = 0.6 for the MCT2E.

$$\text{CTR} \frac{R_2}{R_1} = \frac{1}{A_O} \tag{28}$$

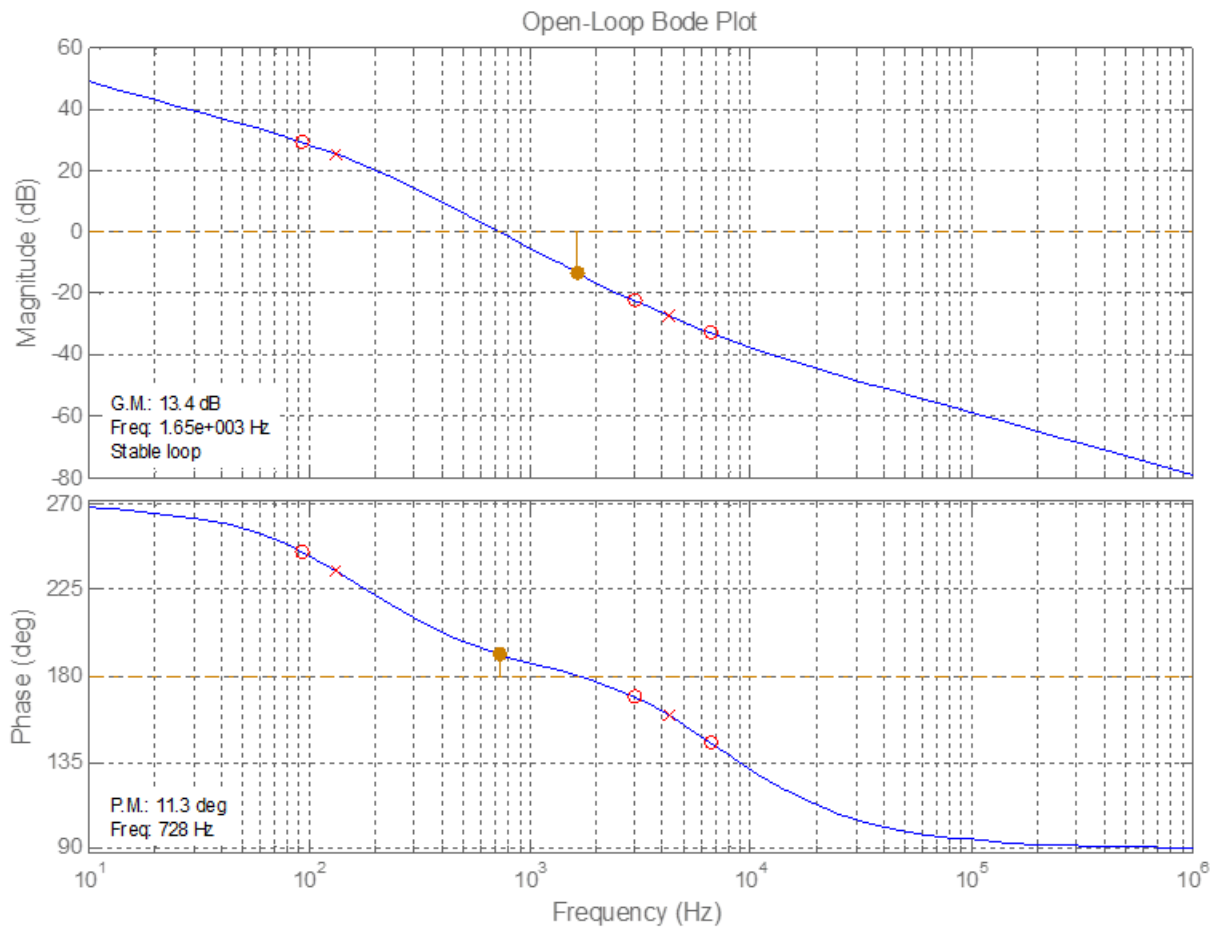

Figure 5.

9 Gate Drive

The PNP in drive circuit ensures primary MOSFET gate charge is removed for fast turn-off.

Calculation of resistance in MOSFET drive:

The total gate charge requirement = 63 nC.

The turn-on time should be at most 2% of total on-time duration.

Thus:

$$t = \frac{1}{100} \times \frac{D_{\min}}{f_s} \approx 100 \text{ ns} \quad (29)$$

$t_{d(\text{ON})} + t_r = 56 \text{ ns}$ is the maximum turn on time limit.

$\frac{1}{2} I_M t = Q_G$ provides the value of $I_M = 1.26 \text{ A}$.

2N3019 can source a maximum current of 1 A. Thus, connect a 20-Ω resistor in series with the MOSFET gate to satisfy the fast turn-on requirement.

10 Current Limit

A basic current limit circuit is provided to switch off the MOSFET if current exceeds I_{CLIM} , thus protecting the switch from damage. It consists of an operational-amplifier comparator driving a NPN to turn off the gate drive when current limit exceeds the set threshold.

11 Final Circuit Diagram

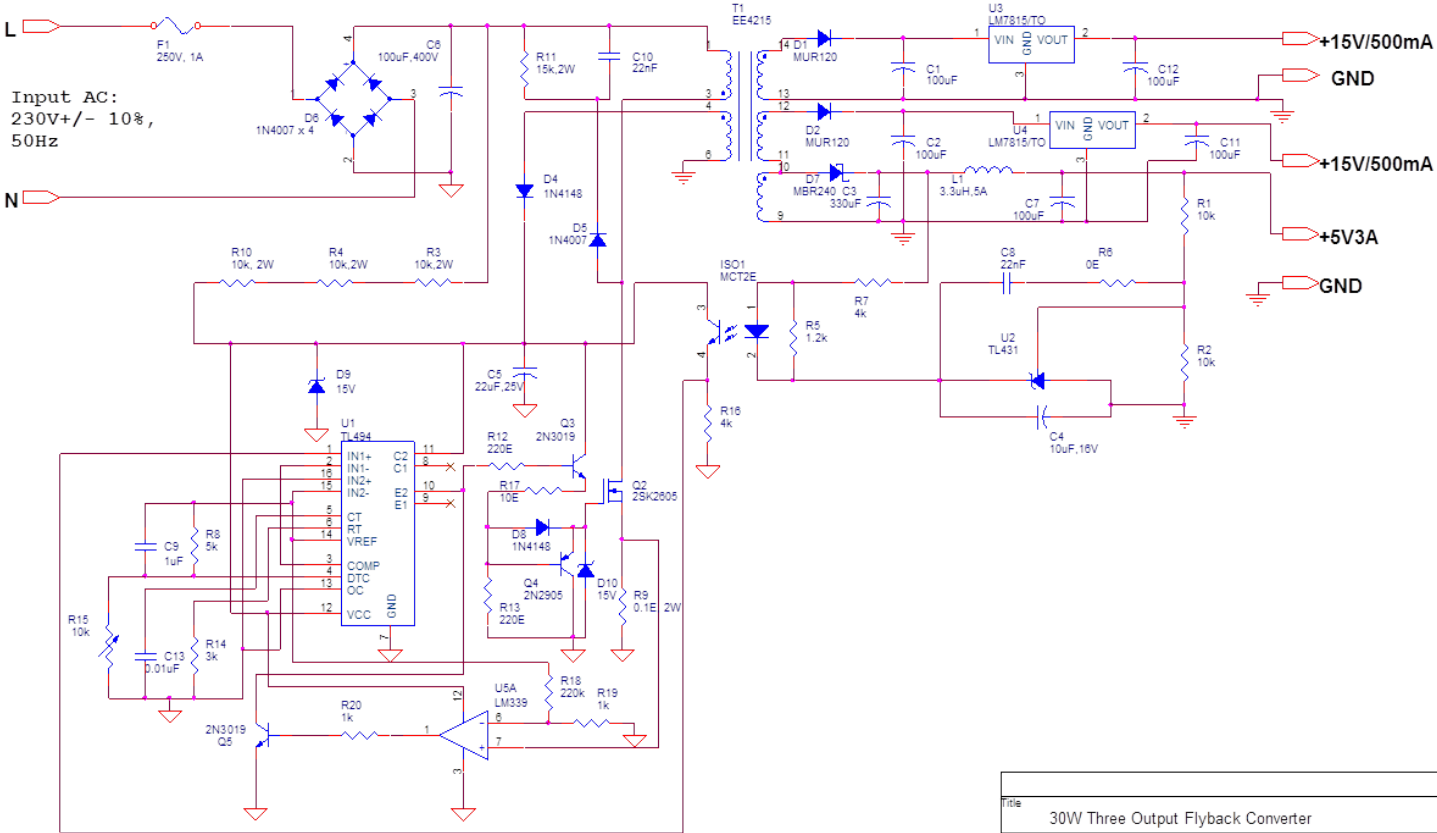

Title		
30W Three Output Flyback Converter		
Size	Document Number	Rev
	MULTFLY_CEDTVER1	A
Date:	12-25-11	Sheet 1 of 1

12 Test Results

Switch Voltage Waveform: The MOSEFT V_{DS} waveform is shown in Figure 6. Frequency was measured to be about 40 kHz and a duty cycle of 0.18.



Figure 6.

The simulated waveform is shown in Figure 7.

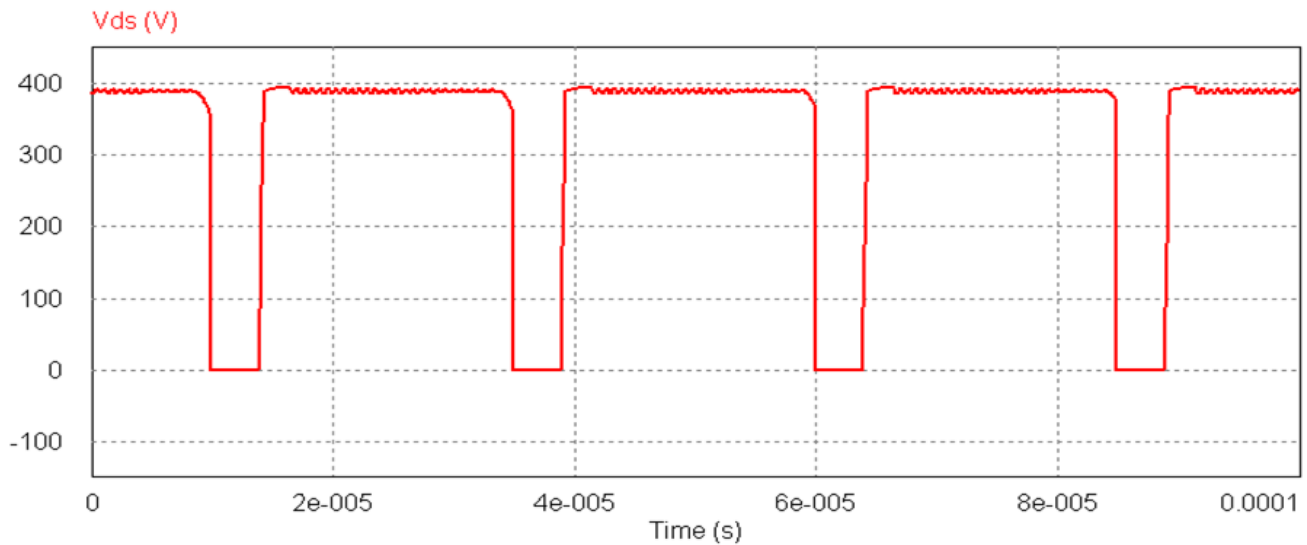

Figure 7.

12.1 Snubber Action

The actual V_{DS} waveform's leading edge is seen in [Figure 8](#). The snubber clamps this spike to a voltage below V_{DS_max} , thus preventing damage to the MOSFET.



Figure 8.

A simulation test reveals the possible waveform without the snubber circuit in place (see [Figure 9](#)). The leakage inductance, L_{lk} , and MOS parasitic capacitance, C_{DS} , are found to resonate at a very-high frequency. The peaks are seen to cross V_{DS_max} , thus possibly damaging the MOSFET.

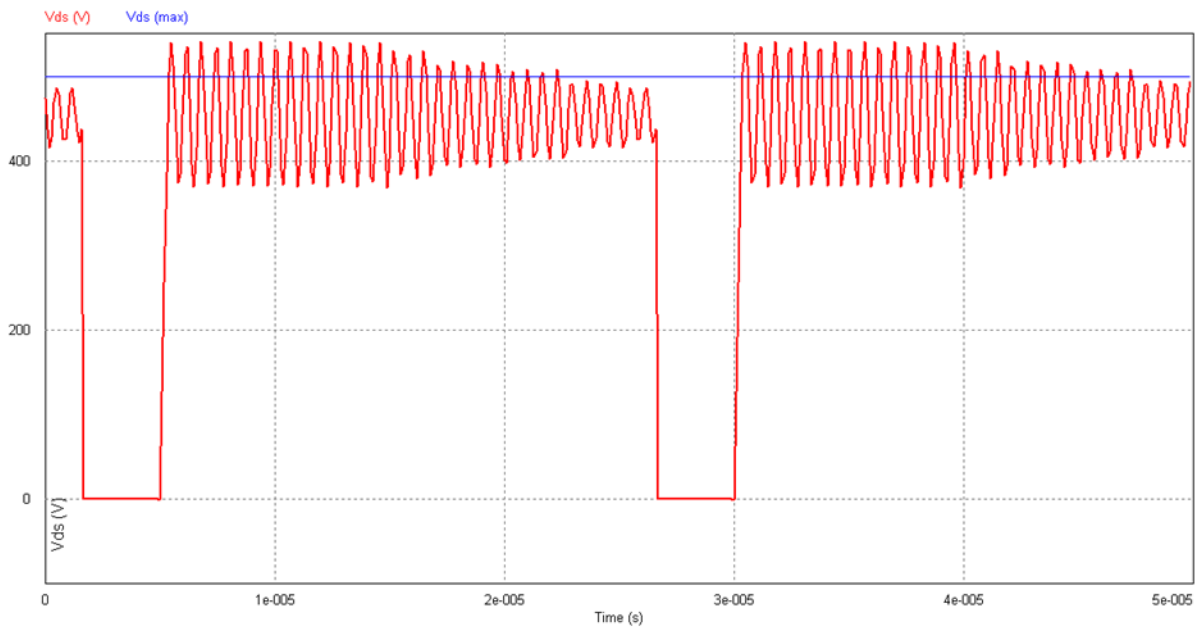

Figure 9.

With the snubber in place, the user gets the following clean wave shape (see [Figure 10](#)).

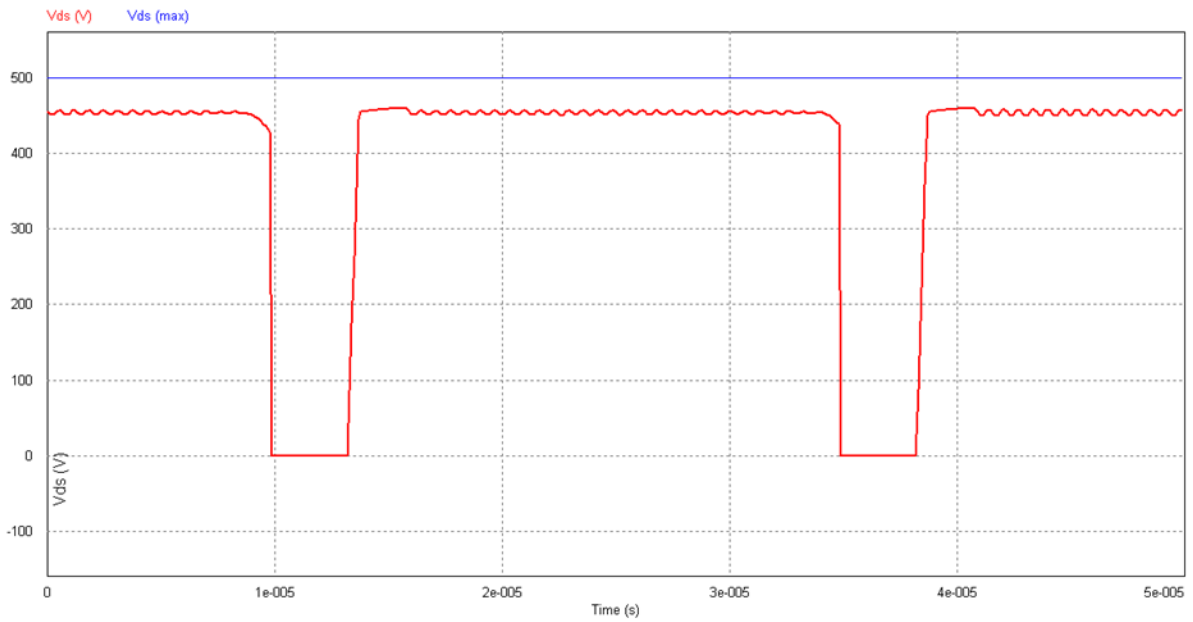

Figure 10.

The blue curve indicates the ripple voltage across the snubber capacitor in AC coupling mode. It is apparent that the capacitor charges as the initial voltage spike energy is diverted to the snubber circuit. The ripple voltage amplitude was kept at 8% of $V_S = 8.3\text{ V}$, as stated earlier.

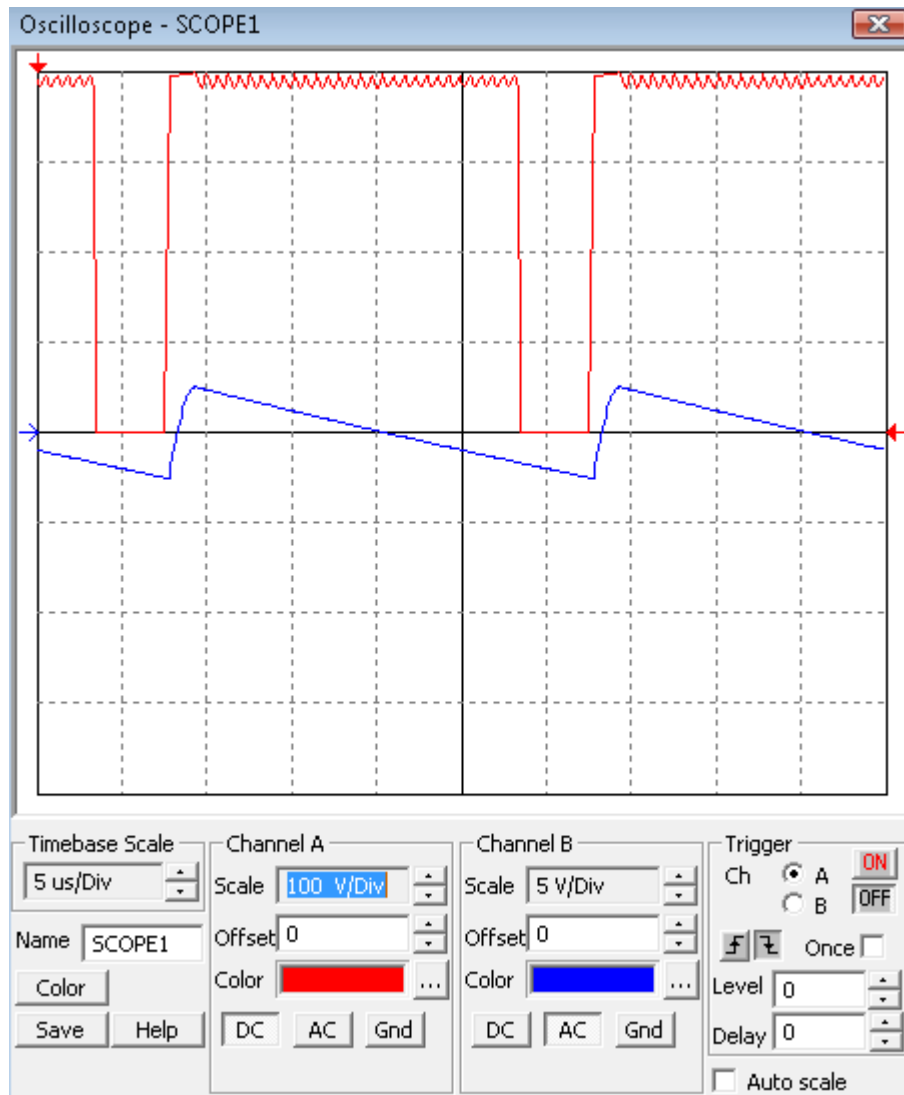

Figure 11.

12.2 Switch Current

A 0.1- Ω resistor was used in series with the MOSFET. The current is seen to ramp up linearly when the MOSFET turns on.



Figure 12.

12.2.1 First +15-V Load Regulation
Table 1. First +15-V Load Regulation

R_L (Ω)	V_o (V)
20	15.03
25	15.03
33.33	15.03
50	15.03

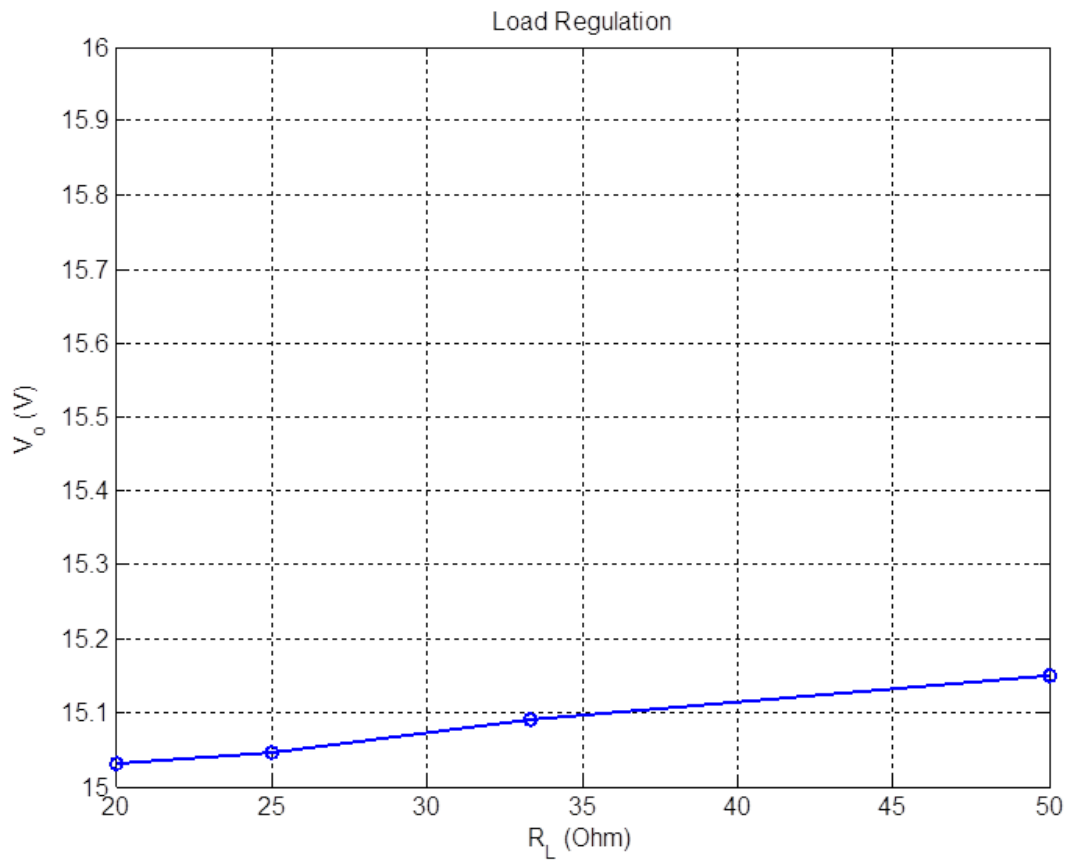
Figure 13.

12.2.2 Second +15-V Load Regulation

Table 2. Second +15-V Load Regulation

R _L (Ω)	V _o (V)
20	15.04
25	15.04
33.33	15.04
50	15.04

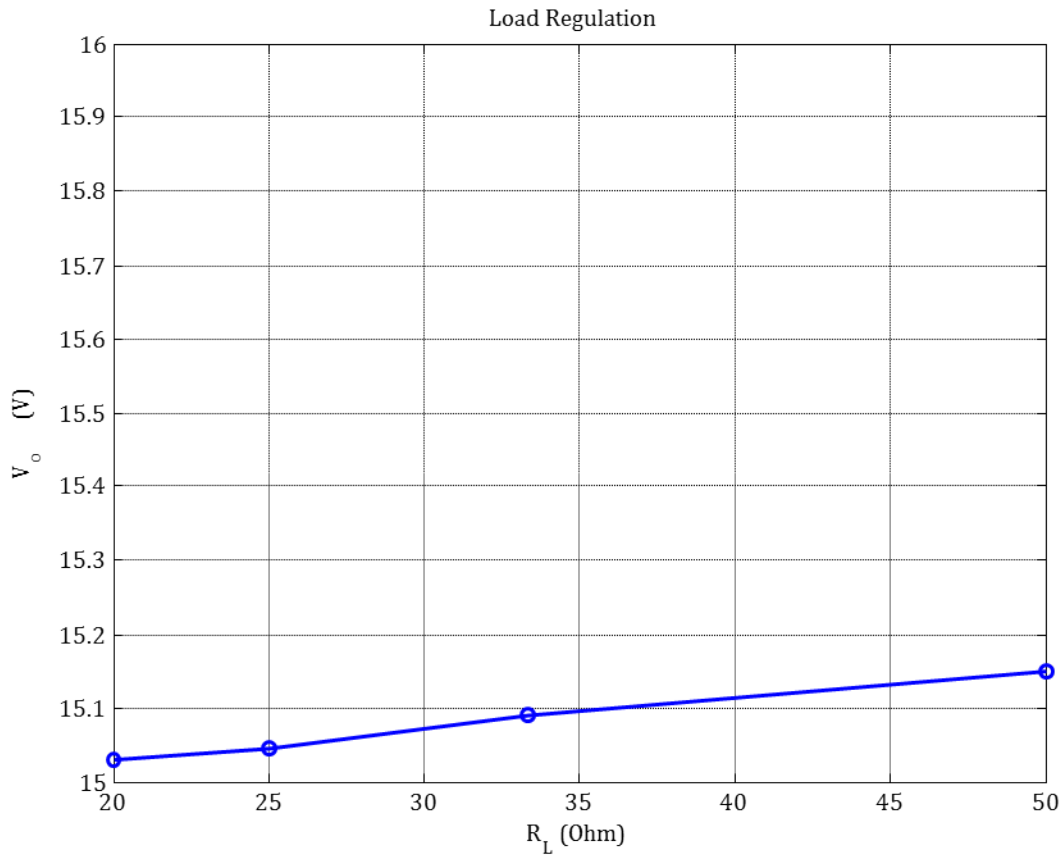
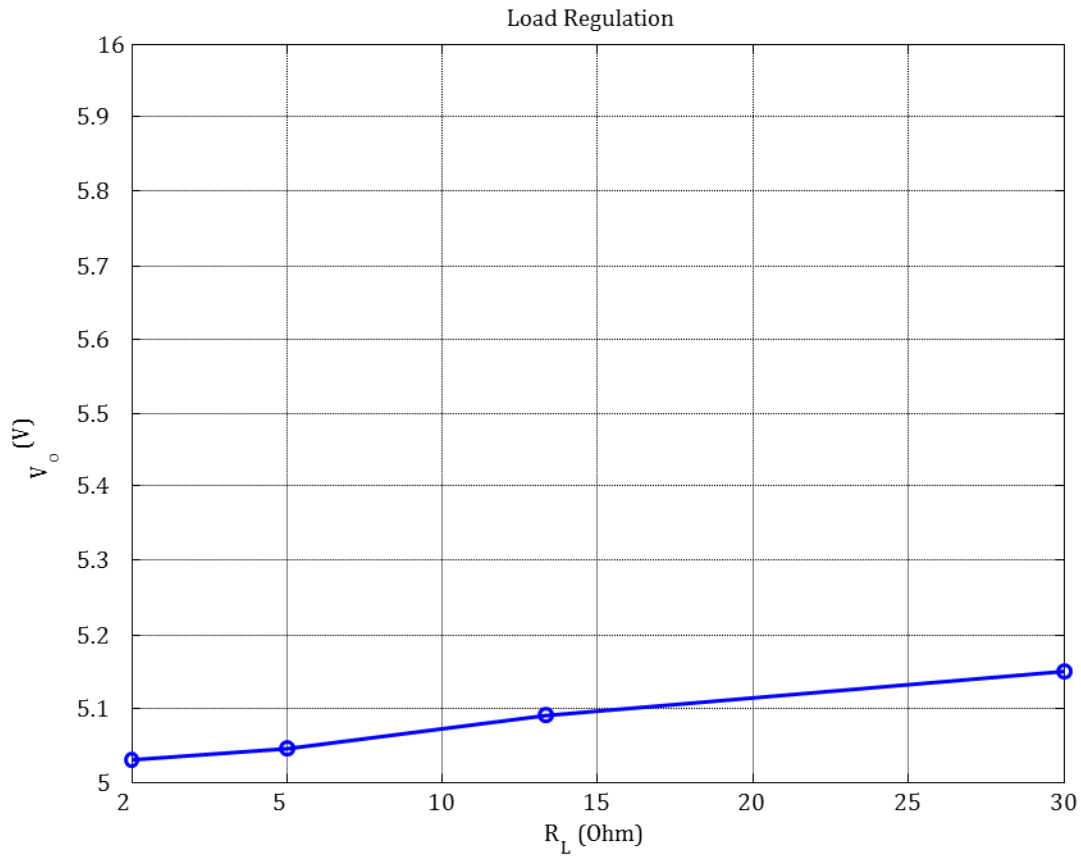

Figure 14.

12.2.3 5-V Load Regulation
Table 3. 5-V Load Regulation

R_L (Ω)	V_o (V)
20	5.05
10	5.04
5	5.02
2	5.00

Figure 15.

12.2.4 Line Regulation: First +15-V

Table 4. Line Regulation: First +15-V

$V_{in\ RMS}\ (V)$	$V_o\ (V)$
120	14.96
130	14.984
140	15.006
150	15.052
160	15.06
170	15.067
180	15.083
190	15.089
200	15.101
210	15.112
220	15.136
230	15.139
240	15.145
250	15.149
260	15.15

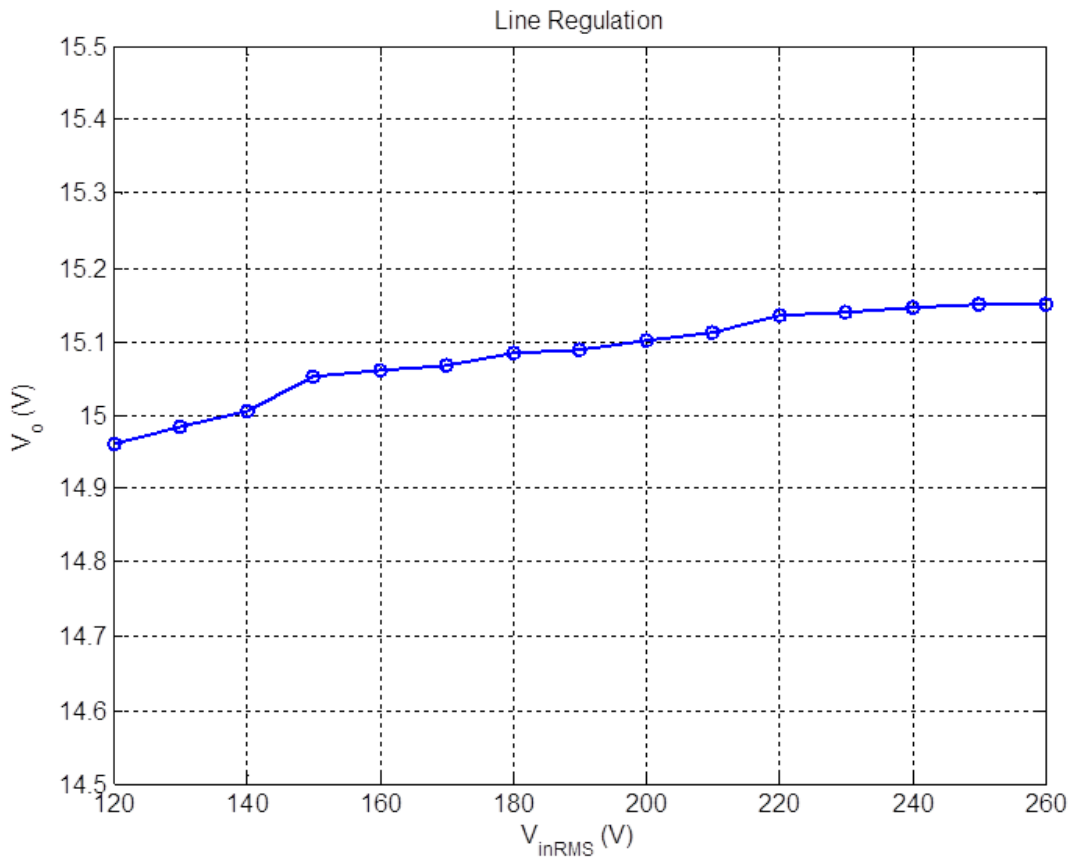
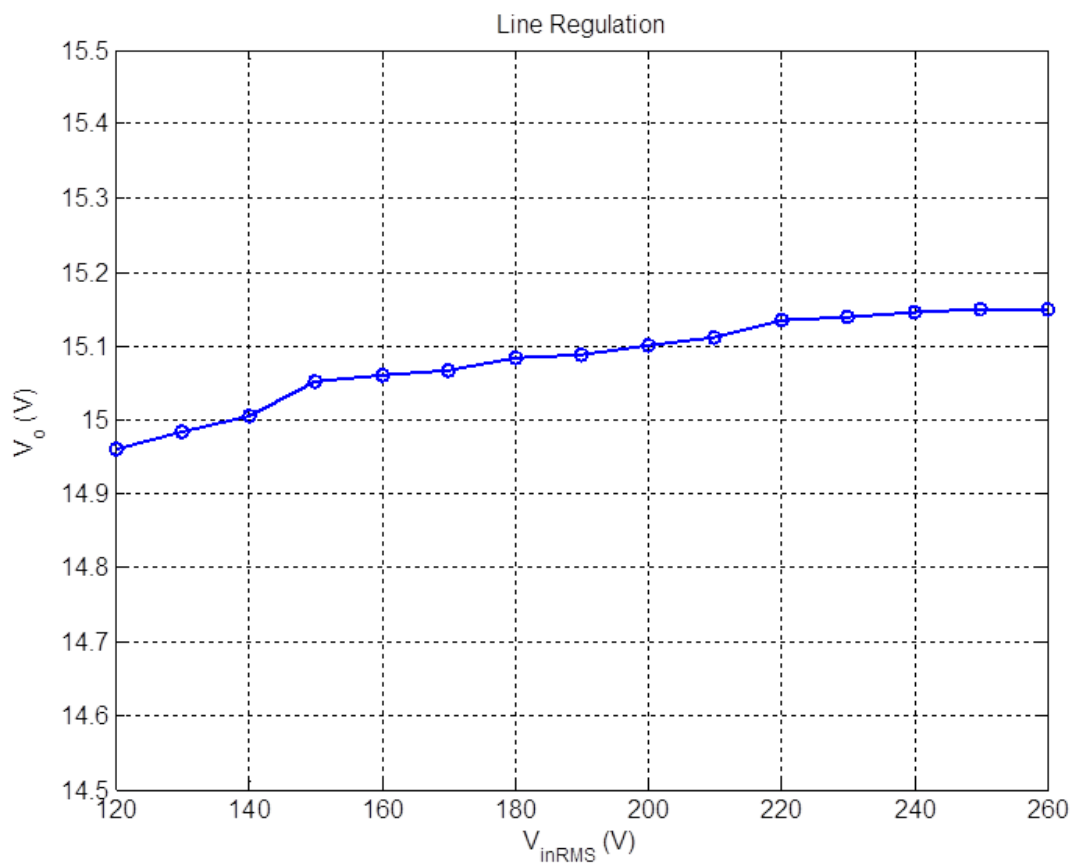

Figure 16.

12.2.5 Line Regulation: Second +15-V
Table 5. Line Regulation: Second +15-V

$V_{in\ RMS}$ (V)	V_o (V)
120	14.96
130	14.984
140	15.006
150	15.052
160	15.06
170	15.067
180	15.083
190	15.089
200	15.101
210	15.112
220	15.136
230	15.139
240	15.145
250	15.149
260	15.15

Figure 17.

12.2.6 Line Regulation: +5-V

Table 6. Line Regulation: +5-V

$V_{in\ RMS}\ (V)$	$V_o\ (V)$
120	4.96
130	4.984
140	5.006
150	5.052
160	5.06
170	5.067
180	5.083
190	5.089
200	5.101
210	5.112
220	5.136
230	5.139
240	5.145
250	5.149
260	5.15

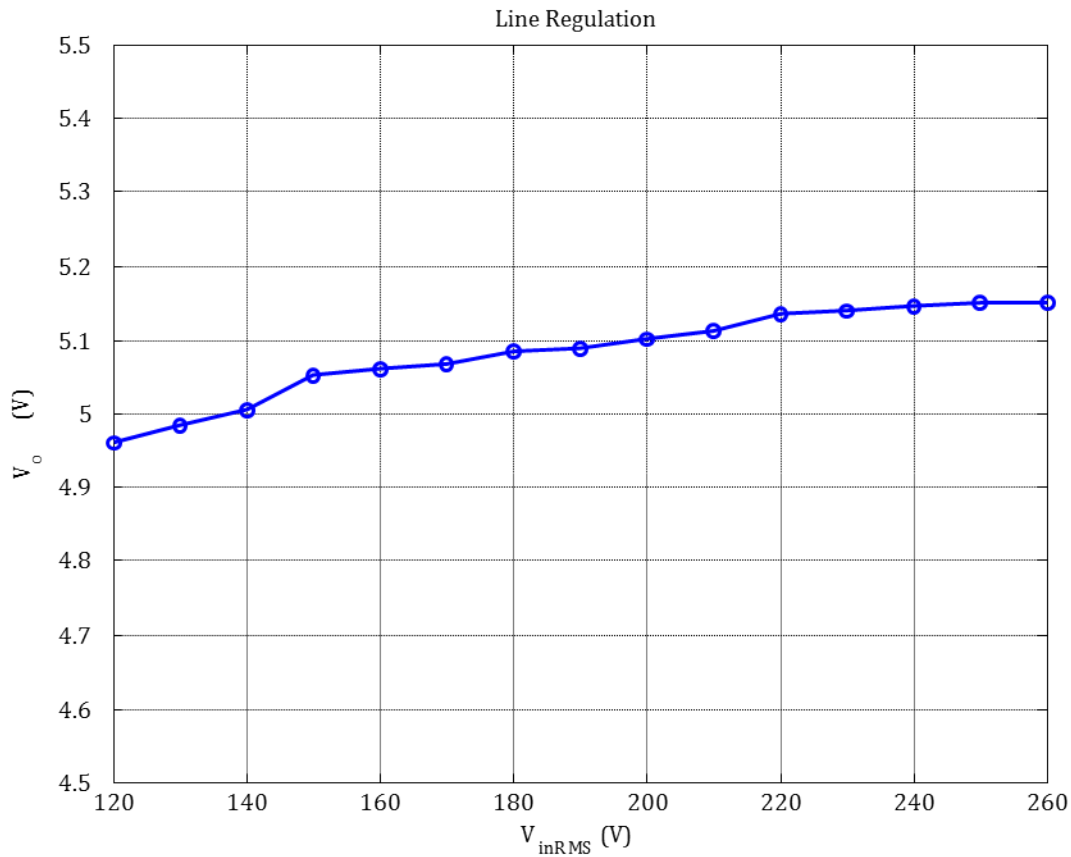

Figure 18.

13 Conclusion

This user's guide explained the design and selection of components for a multiple output flyback converter. The TL494 device was used for PWM control of this flyback converter. The 30-W three-output flyback converter was realized in a cost-efficient manner using simple components to provide the complete feature set of a standard flyback supply.

IMPORTANT NOTICE

Texas Instruments Incorporated and its subsidiaries (TI) reserve the right to make corrections, enhancements, improvements and other changes to its semiconductor products and services per JESD46, latest issue, and to discontinue any product or service per JESD48, latest issue. Buyers should obtain the latest relevant information before placing orders and should verify that such information is current and complete. All semiconductor products (also referred to herein as "components") are sold subject to TI's terms and conditions of sale supplied at the time of order acknowledgment.

TI warrants performance of its components to the specifications applicable at the time of sale, in accordance with the warranty in TI's terms and conditions of sale of semiconductor products. Testing and other quality control techniques are used to the extent TI deems necessary to support this warranty. Except where mandated by applicable law, testing of all parameters of each component is not necessarily performed.

TI assumes no liability for applications assistance or the design of Buyers' products. Buyers are responsible for their products and applications using TI components. To minimize the risks associated with Buyers' products and applications, Buyers should provide adequate design and operating safeguards.

TI does not warrant or represent that any license, either express or implied, is granted under any patent right, copyright, mask work right, or other intellectual property right relating to any combination, machine, or process in which TI components or services are used. Information published by TI regarding third-party products or services does not constitute a license to use such products or services or a warranty or endorsement thereof. Use of such information may require a license from a third party under the patents or other intellectual property of the third party, or a license from TI under the patents or other intellectual property of TI.

Reproduction of significant portions of TI information in TI data books or data sheets is permissible only if reproduction is without alteration and is accompanied by all associated warranties, conditions, limitations, and notices. TI is not responsible or liable for such altered documentation. Information of third parties may be subject to additional restrictions.

Resale of TI components or services with statements different from or beyond the parameters stated by TI for that component or service voids all express and any implied warranties for the associated TI component or service and is an unfair and deceptive business practice. TI is not responsible or liable for any such statements.

Buyer acknowledges and agrees that it is solely responsible for compliance with all legal, regulatory and safety-related requirements concerning its products, and any use of TI components in its applications, notwithstanding any applications-related information or support that may be provided by TI. Buyer represents and agrees that it has all the necessary expertise to create and implement safeguards which anticipate dangerous consequences of failures, monitor failures and their consequences, lessen the likelihood of failures that might cause harm and take appropriate remedial actions. Buyer will fully indemnify TI and its representatives against any damages arising out of the use of any TI components in safety-critical applications.

In some cases, TI components may be promoted specifically to facilitate safety-related applications. With such components, TI's goal is to help enable customers to design and create their own end-product solutions that meet applicable functional safety standards and requirements. Nonetheless, such components are subject to these terms.

No TI components are authorized for use in FDA Class III (or similar life-critical medical equipment) unless authorized officers of the parties have executed a special agreement specifically governing such use.

Only those TI components which TI has specifically designated as military grade or "enhanced plastic" are designed and intended for use in military/aerospace applications or environments. Buyer acknowledges and agrees that any military or aerospace use of TI components which have **not** been so designated is solely at the Buyer's risk, and that Buyer is solely responsible for compliance with all legal and regulatory requirements in connection with such use.

TI has specifically designated certain components as meeting ISO/TS16949 requirements, mainly for automotive use. In any case of use of non-designated products, TI will not be responsible for any failure to meet ISO/TS16949.

Products

Audio	www.ti.com/audio
Amplifiers	amplifier.ti.com
Data Converters	dataconverter.ti.com
DLP® Products	www.dlp.com
DSP	dsp.ti.com
Clocks and Timers	www.ti.com/clocks
Interface	interface.ti.com
Logic	logic.ti.com
Power Mgmt	power.ti.com
Microcontrollers	microcontroller.ti.com
RFID	www.ti-rfid.com
OMAP Applications Processors	www.ti.com/omap
Wireless Connectivity	www.ti.com/wirelessconnectivity

Applications

Automotive and Transportation	www.ti.com/automotive
Communications and Telecom	www.ti.com/communications
Computers and Peripherals	www.ti.com/computers
Consumer Electronics	www.ti.com/consumer-apps
Energy and Lighting	www.ti.com/energy
Industrial	www.ti.com/industrial
Medical	www.ti.com/medical
Security	www.ti.com/security
Space, Avionics and Defense	www.ti.com/space-avionics-defense
Video and Imaging	www.ti.com/video

TI E2E Community

e2e.ti.com