

## PROGRAMMABLE 27-BIT DISPLAY SERIAL INTERFACE TRANSMITTER

 Check for Samples: [SN65LVDS311](#)

### FEATURES

- 2.8 × 2.8mm package size
- 1.8V input signal swing
- 24-Bit RGB Data, 3 Control Bits, 1 Parity Bit and 2 Reserved Bits Transmitted over 1, 2 or 3 Differential Lines
- SubLVDS Differential Voltage Levels
- Three Operating Modes to Conserve Power
  - Active-Mode QVGA 17.4mW (typ)
  - Active-Mode VGA 28.8mW (typ)
  - Shutdown Mode ≈ 0.5μA (typ)
  - Standby Mode ≈ 0.5μA (typ)
- ESD Rating > 3kV (HBM)
- Pixel Clock Range of 4MHz–65MHz
- Failsafe on all CMOS Inputs
- Typical Application: Cameras, Embedded Computers

### DESCRIPTION

The SN65LVDS311 serializer transmits 27 parallel input data over 1, 2, or 3 serial output links. The device pinout is optimized to interface with the OMAP3630 application processor. The device loads a shift register with the 24 pixel bits and 3 control bits from the parallel CMOS input interface. The data are latched into the device by the pixel clock, PCLK. In addition to the 27 bits, the device adds a parity bit and two reserved bits for a total number of 30 serial bits. The parity bit allows a receiver to detect single-bit errors. Odd parity is implemented.

The serial shift register is uploaded through 1, 2, or 3 serial outputs at 30, 15, or 10 times the pixel clock data rate. A copy of the pixel clock is output on an additional differential output. The serial data and clock are transmitted via Sub Low-Voltage Differential Signaling (SubLVDS) lines. The SN65LVDS311 supports three power modes (Shutdown, Standby and Active) to conserve power.

When transmitting, the PLL locks to the incoming pixel clock PCLK and generates an internal high-speed clock at the line rate of the data lines. The parallel data is latched on the rising edge of PCLK. The serialized data is presented on the serial outputs D0, D1, D2 with a recreation of the Pixel clock PCLK generated from the internal high-speed clock and output on the CLK output. If the input clock PCLK stops, the device enters a standby mode to conserve power.

Two Link-Select lines LS0 and LS1 control whether 1, 2 or 3 serial links are used. The TXEN input may be used to put the SN65LVDS311 in a shutdown mode. The SN65LVDS311 enters an active Standby mode if the input clock PCLK stops. This minimizes power consumption without the need for controlling an external pin. The SN65LVDS311 is characterized for operation over ambient air temperatures of -40°C to 85°C. All CMOS inputs offer failsafe to protect the input from damage during power-up and to avoid current flow into the device inputs during power-up.

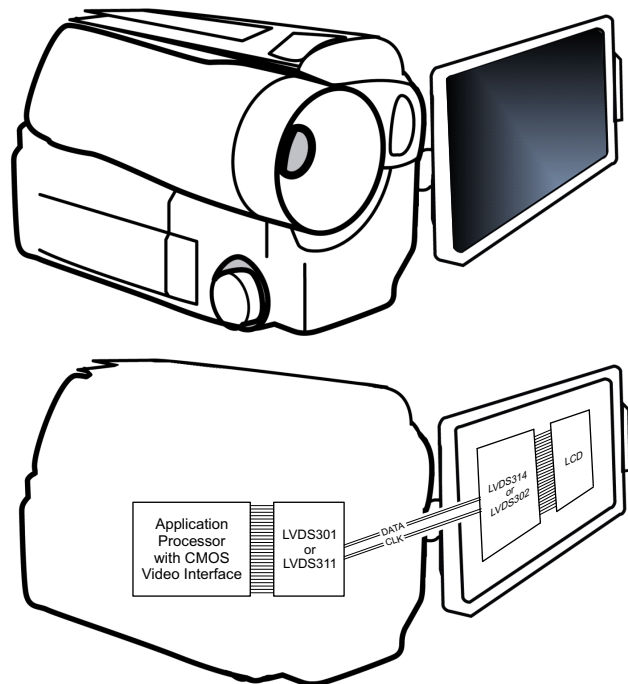

Please be aware that an important notice concerning availability, standard warranty, and use in critical applications of Texas Instruments semiconductor products and disclaimers thereto appears at the end of this data sheet.



This integrated circuit can be damaged by ESD. Texas Instruments recommends that all integrated circuits be handled with appropriate precautions. Failure to observe proper handling and installation procedures can cause damage.

ESD damage can range from subtle performance degradation to complete device failure. Precision integrated circuits may be more susceptible to damage because very small parametric changes could cause the device not to meet its published specifications.

### Functional Block Diagram

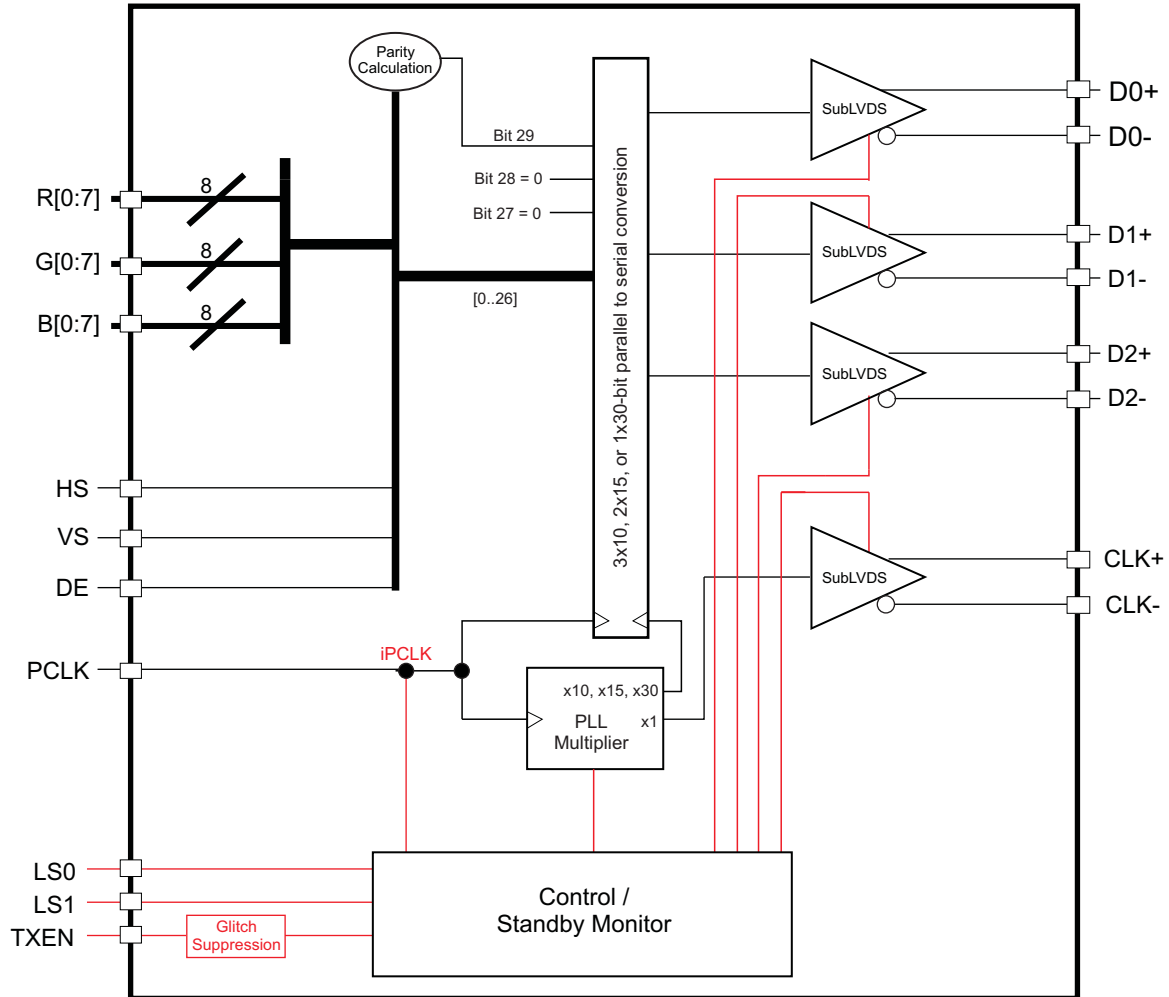

### PINOUT

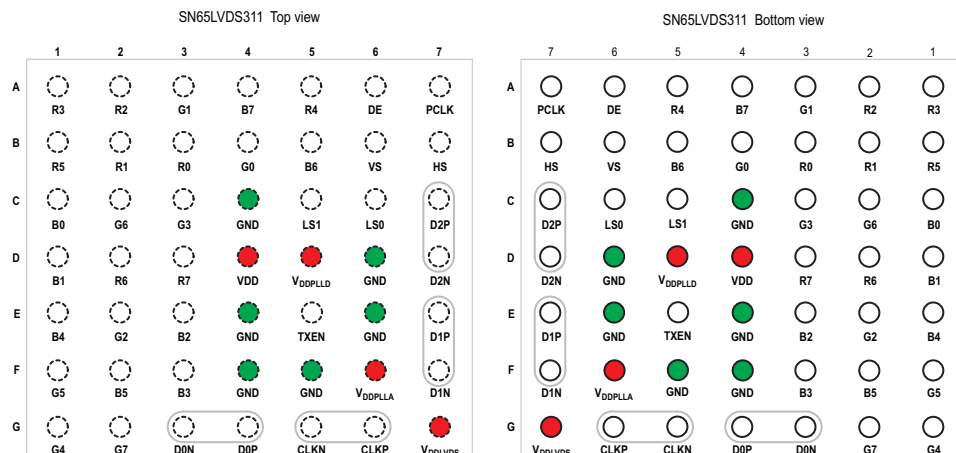

**Table 1. SIGNAL LIST**

SIGNAL	PIN	SIGNAL	PIN	SIGNAL	PIN	SIGNAL	PIN
R0	B3	G0	B4	B0	C1	PCLK	A7
R1	B2	G1	A3	B1	D1	HS	B7
R2	A2	G2	E2	B2	E3	VS	B6
R3	A1	G3	C3	B3	F3	DE	A6
R4	A5	G4	G1	B4	E1	TXEN	E5
R5	B1	G5	F1	B5	F2	LS0	C6
R6	D2	G6	C2	B6	B5	LS1	C5
R7	D3	G7	G2	B7	A4		
D0P	G4	D1P	E7	D2P	C7	CLKP	G6
D0N	G3	D1N	F7	D2N	D7	CLKN	G5
V <sub>DD</sub>	D4	V <sub>DDPLL</sub>	D5	V <sub>DDPLLA</sub>	F6	V <sub>DDLVD</sub>	G7
GND	C4, D6, E6, E4, F4, F5						

**Table 2. TERMINAL FUNCTIONS**

NAME	I/O	DESCRIPTION	
D0+, D0–	SubLVDS Out	SubLVDS Data Link (active during normal operation)	
D1+, D1–		SubLVDS Data Link (active during normal operation when LS0 = high and LS1 = low, or LS0 = low and LS1=high; high impedance if LS0 = LS1 = low)	
D2+, D2–		SubLVDS Data Link (active during normal operation when LS0 = low and LS1 = high, high-impedance when LS1 = low)	
CLK+, CLK–		SubLVDS output Clock; clock polarity is fixed	
R0–R7	CMOS IN	Red Pixel Data (8); pin assignment depends on SWAP pin setting	
G0–G7		Green Pixel Data (8); pin assignment depends on SWAP pin setting	
B0–B7		Blue Pixel Data (8); pin assignment depends on SWAP pin setting	
HS		Horizontal Sync	
VS		Vertical Sync	
DE		Data Enable	
PCLK		Input Pixel Clock; data are latched on rising input clock edge	
LS0, LS1		Link Select (Determines active SubLVDS Data Links and PLL Range) See <a href="#">Table 3</a>	
TXEN		Disables the CMOS Drivers and Turns Off the PLL, putting device in shutdown mode 1 – Transmitter enabled 0 – Transmitter disabled (Shutdown)	
		Note: The TXEN input incorporates glitch-suppression logic to avoid device malfunction on short input spikes. It is necessary to pull TXEN high for longer than 10 μs to enable the transmitter. It is necessary to pull the TXEN input low for longer than 10 μs to disable the transmitter. At power up, the transmitter is enabled immediately if TXEN = 1 and disabled if TXEN = 0	
V <sub>DD</sub>		Power Supply <sup>(1)</sup>	Supply Voltage
GND			Supply Ground
V <sub>DDLVD</sub>			SubLVDS I/O supply Voltage
GND <sub>LVDS</sub>	SubLVDS Ground		
V <sub>DDPLLA</sub>	PLL analog supply Voltage		
GND <sub>PLLA</sub>	PLL analog GND		
V <sub>DDPLLD</sub>	PLL digital supply Voltage		
GND <sub>PLLD</sub>	PLL digital GND		

(1) For a multilayer pcb, it is recommended to keep one common GND layer underneath the device and connect all ground terminals directly to this plane.

## FUNCTIONAL DESCRIPTION

### Serialization Modes

The SN65LVDS311 transmitter has three modes of operation controlled by link-select pins LS0 and LS1. [Table 3](#) shows the serializer modes of operation.

**Table 3. Logic Table: Link Select Operating Modes**

LS1	LS0		Mode of Operation	Data Links Status
0	0	1ChM	1-channel mode (30-bit serialization rate)	D0 active; D1, D2 high-impedance
0	1	2ChM	2-channel mode (15-bit serialization rate)	D0, D1 active; D2 high-impedance
1	0	3ChM	3-channel mode (10-bit serialization rate)	D0, D1, D2 active
1	1		Reserved	Reserved

### 1-Channel Mode

While LS0 and LS1 are held low, the SN65LVDS311 transmits payload data over a single SubLVDS data pair, D0. The PLL locks to PCLK and internally multiplies the clock by a factor of 30. The internal high-speed clock is used to serialize (shift out) the data payload on D0. Two reserved bits and the parity bit are added to the data frame. [Figure 1](#) illustrates the timing and the mapping of the data payload into the 30-bit frame. The internal high-speed clock is divided by a factor of 30 to recreate the pixel clock, and presented on the SubLVDS CLK output. While in this mode, the PLL can lock to a clock that is in the range of 4MHz through 15MHz. This mode is intended for smaller video display formats (e.g. QVGA to HVGA) that do not require the full bandwidth capabilities of the SN65LVDS311.



**Figure 1. Data and Clock Output in 1-Channel Mode (LS0 and LS1 = low).**

### 2-Channel Mode

While LS0 is held high and LS1 is held low, the SN65LVDS311 transmits payload data over two SubLVDS data pairs, D0 and D1. The PLL locks to PCLK and internally multiplies it by a factor of 15. The internal high-speed clock is used to serialize the data payload on D0, and D1. Two reserved bits and the parity bit are added to the data frame. [Figure 2](#) illustrates the timing and the mapping of the data payload into the 30-bit frame and how the frame becomes split into the two output channels. The internal high-speed clock is divided by 15 to recreate the pixel clock, and presented on SubLVDS CLK. The PLL can lock to a clock that is in the range of 8MHz through 30MHz in this mode. Typical applications for using the 2-channel mode are HVGA and VGA displays.

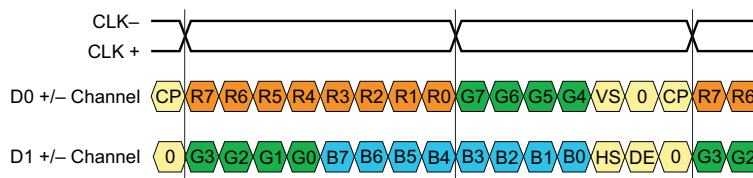

**Figure 2. Data and Clock Output in 2-Channel Mode (LS0 = high; LS1 = low).**

### 3-Channel Mode

While LS0 is held low and LS1 is held high, the SN65LVDS311 transmits payload data over three SubLVDS data pairs D0, D1, and D2. The PLL locks to PCLK, and internally multiplies it by 10. The internal high-speed clock is used to serialize the data payload on D0, D1, and D2. Two reserved bits and the parity bit are added to the data frame. Figure 3 illustrates the timing and the mapping of the data payload into the 30-bit frame and how the frame becomes split over the three output channels. The internal high speed clock is divided back down by a factor of 10 to recreate the pixel clock and presented on SubLVDS CLK output. While in this mode, the PLL can lock to a clock in the range of 20MHz through 65MHz. The 3-channel mode supports applications with very large display resolutions such as VGA or XGA.

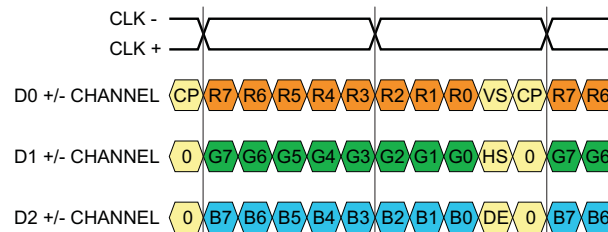

Figure 3. Data and Clock Output in 3-Channel Mode (LS0 = low; LS1 = high).

### Powerdown Modes

The SN65LVDS311 Transmitter has two powerdown modes to facilitate efficient power management.

#### Shutdown Mode

The SN65LVDS311 enters Shutdown mode when the TXEN pin is asserted low. This turns off all transmitter circuitry, including the CMOS input, PLL, serializer, and SubLVDS transmitter output stage. All outputs are high-impedance. Current consumption in Shutdown mode is nearly zero.

#### Standby Mode

The SN65LVDS311 enters the Standby mode if TXEN is high and the PCLK input frequency is less than 500kHz. All circuitry except the PCLK input monitor is shut down, and all outputs enter high-impedance mode. The current consumption in Standby mode is very low. When the PCLK input signal is completely stopped, the  $I_{DD}$  current consumption is less than 10  $\mu$ A. The PCLK input must not be left floating.

#### NOTE

A floating (left open) CMOS input allows leakage currents to flow from  $V_{DD}$  to GND. To prevent large leakage current, a CMOS gate must be kept at a valid logic level, either  $V_{IH}$  or  $V_{IL}$ . This can be achieved by applying an external voltage of  $V_{IH}$  or  $V_{IL}$  to all SN65LVDS311 inputs.

## Active Modes

When TXEN is high and the PCLK input clock signal is faster than 3MHz, the SN65LVDS311 enters Active mode. Current consumption in Active mode depends on operating frequency and the number of data transitions in the data payload.

## Acquire Mode (PLL approaches lock)

The PLL is enabled and attempts to lock to the input Clock. All outputs remain in high-impedance mode. When the PLL monitor detects stable PLL operation, the device switches from Acquire to Transmit mode. For proper device operation, the pixel clock frequency must fall within the valid  $f_{PCLK}$  range specified under recommended operating conditions. If the pixel clock frequency is larger than 3MHz but smaller than  $f_{PCLK}(\text{min})$ , the SN65LVDS311 PLL is enabled. Under such conditions, it is possible for the PLL to lock temporarily to the pixel clock, causing the PLL monitor to release the device into transmit mode. If this happens, the PLL may or may not be properly locked to the pixel clock input, potentially causing data errors, frequency oscillation, and PLL deadlock (loss of VCO oscillation).

## Transmit Mode

After the PLL achieves lock, the device enters the normal transmit mode. The CLK pin outputs a copy of PCLK. Based on the selected mode of operation, the D0, D1, and D2 outputs carry the serialized data. In 1-channel mode, outputs D1 and D2 remain high-impedance. In the 2-channel mode, output D2 remains high-impedance.

## Parity Bit Generation

The SN65LVDS311 transmitter calculates the parity of the transmit data word and sets the parity bit accordingly. The parity bit covers the 27 bit data payload consisting of 24 bits of pixel data plus VS, HS and DE. The two reserved bits are not included in the parity generation. ODD Parity bit signaling is used. The transmitter sets the Parity bit if the sum of the 27 data bits result in an even number of ones. The Parity bit is cleared otherwise. This allows the receiver to verify Parity and detect single bit errors.

## Status Detect and Operating Modes Flow diagram

The SN65LVDS311 switches between the power saving and active modes in the following way:

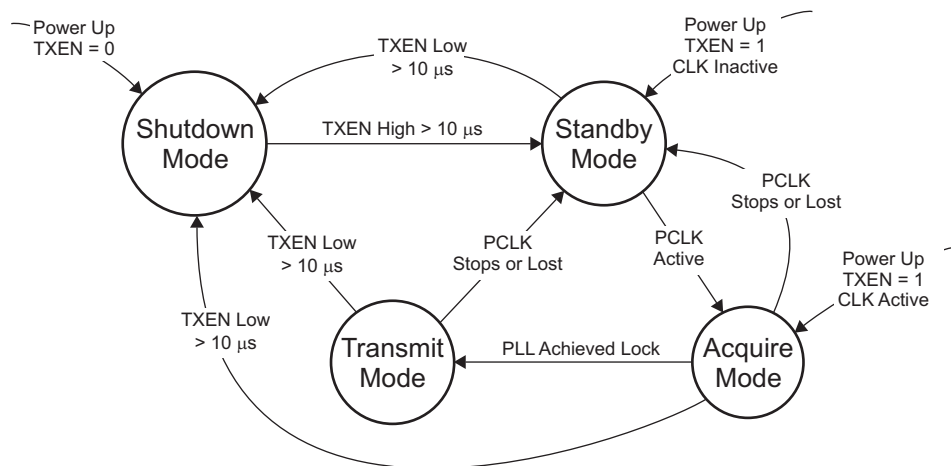

**Figure 4. Status Detect and Operating Modes Flow Diagram**

**Table 4. Status Detect and Operating Modes Descriptions**

Mode	Characteristics	Conditions
Shutdown Mode	Least amount of power consumption <sup>(1)</sup> (most circuitry turned off); All outputs are high-impedance	TXEN is low <sup>(1)</sup> <sup>(2)</sup>
Standby Mode	Low power consumption (only clock activity circuit active; PLL is disabled to conserve power); All outputs are high-impedance	TXEN is high; PCLK input signal is missing or inactive <sup>(2)</sup>
Acquire Mode	PLL tries to achieve lock; All outputs are high-impedance	TXEN is high; PCLK input monitor detected input activity
Transmit Mode	Data transfer (normal operation); Transmitter serializes data and transmits data on serial output; unused outputs remain high-impedance	TXEN is high and PLL is locked to incoming clock

- (1) In Shutdown Mode, all SN65LVDS311 internal switching circuits (e.g., PLL, serializer, etc.) are turned off to minimize power consumption. The input stage of any input pin remains active.
- (2) Leaving inputs unconnected can cause random noise to toggle the input stage and potentially harm the device. All inputs must be tied to a valid logic level  $V_{IL}$  or  $V_{IH}$  during Shutdown or Standby Mode.

**Table 5. Operating Mode Transitions**

MODE TRANSITION	USE CASE	TRANSITION SPECIFICS
Shutdown → Standby	Drive TXEN high to enable transmitter	<ol style="list-style-type: none"> <li>1. TXEN high &gt; 10 <math>\mu</math>s</li> <li>2. Transmitter enters standby mode               <ol style="list-style-type: none"> <li>a. All outputs are high-impedance</li> <li>b. Transmitter turns on clock input monitor</li> </ol> </li> </ol>
Standby → Acquire	Transmitter activity detected	<ol style="list-style-type: none"> <li>1. PCLK input monitor detects clock input activity;</li> <li>2. Outputs remain high-impedance;</li> <li>3. PLL circuit is enabled</li> </ol>
Acquire → Transmit	Link is ready to transfer data	<ol style="list-style-type: none"> <li>1. PLL is active and approaches lock</li> <li>2. PLL achieved lock within 2 ms</li> <li>3. Parallel Data input latches into shift register</li> <li>4. CLK output turns on</li> <li>5. selected Data outputs turn on and send out first serial data bit</li> </ol>
Transmit → Standby	Request Transmitter to enter Standby mode by stopping PCLK	<ol style="list-style-type: none"> <li>1. PCLK Input monitor detects missing PCLK</li> <li>2. Transmitter indicates standby, putting all outputs into high-impedance;</li> <li>3. PLL shuts down;</li> <li>4. PCLK activity input monitor remains active</li> </ol>
Transmit/Standby → Shutdown	Turn off Transmitter	<ol style="list-style-type: none"> <li>1. TXEN pulled low for longer than 10<math>\mu</math>s</li> <li>2. Transmitter indicates standby, putting output CLK+ and CLK– into high-impedance state;</li> <li>3. Transmitter puts all other outputs into high-impedance state</li> <li>4. Most IC circuitry is shut down for least power consumption</li> </ol>

**ORDERING INFORMATION<sup>(1)</sup>**

PART NUMBER	PACKAGE	SHIPPING METHOD
SN65LVDS311YFF	YFF	Tray
SN65LVDS311YFFR		Reel

(1) Updated ordering information is found in the orderable addendum at the end of this document.

**ABSOLUTE MAXIMUM RATINGS<sup>(1)</sup>**

over operating free-air temperature range (unless otherwise noted)

	VALUE	UNIT
Supply voltage range, $V_{DD}$ <sup>(2)</sup> , $V_{DDPLLA}$ , $V_{DDPLLD}$ , $V_{DDLVDs}$	-0.3 to 2.175	V
Voltage range at any input or output terminal	When $V_{DDx} > 0$ V	-0.5 to 2.175
	When $V_{DDx} \leq 0$ V	-0.5 to $V_{DD} + 2.175$
Electrostatic discharge	Human Body Model <sup>(3)</sup> (all Pins)	±3
	Charged-Device Mode <sup>(4)</sup> (all Pins)	±500
	Machine Model <sup>(5)</sup> (all pins)	±200
Continuous power dissipation	See Dissipation Rating Table	

- (1) Stresses beyond those listed under *absolute maximum ratings* may cause permanent damage to the device. These are stress ratings only and functional operation of the device at these or any other conditions beyond those indicated under *recommended operating conditions* is not implied. Exposure to absolute maximum-rated conditions for extended periods may affect device reliability.
- (2) All voltage values are with respect to the GND terminals.
- (3) In accordance with JEDEC Standard 22, Test Method A114-A.
- (4) In accordance with JEDEC Standard 22, Test Method C101.
- (5) In accordance with JEDEC Standard 22, Test Method A115-A

**DISSIPATION RATINGS**

PACKAGE	CIRCUIT BOARD MODEL	$\theta_{JA} < 25^{\circ}\text{C}$	DERATING FACTOR <sup>(1)</sup> ABOVE $T_A = 25^{\circ}\text{C}$	$T_A = 85^{\circ}\text{C}$ POWER RATING
YFF	Low-K <sup>(2)</sup>	692mW	7.69 mW/°C	148 mW

- (1) This is the inverse of the junction-to-ambient thermal resistance when board-mounted and with no air flow.
- (2) In accordance with the Low-K thermal metric definitions of EIA/JESD51-2.

**THERMAL CHARACTERISTICS**

PARAMETER	TEST CONDITIONS		VALUE	UNIT
$P_D$ Device Power Dissipation	Typical	$V_{DDx} = 1.8$ V, $T_A = 25^{\circ}\text{C}$	PCLK at 4MHz	14.4
			PCLK at 65MHz	44.5
	Maximum	$V_{DDx} = 1.95$ V, $T_A = -40^{\circ}\text{C}$	PCLK at 4MHz	22.3
			PCLK=65MHz	71.8



**RECOMMENDED OPERATING CONDITIONS<sup>(1)</sup>**

		MIN	NOM	MAX	UNIT
$V_{DD}$ $V_{DDPLLA}$ $V_{DDPLLD}$ $V_{DDLVDs}$	Supply voltages	1.65	1.8	1.95	V
$V_{DDn(PP)}$	Supply voltage noise magnitude (all supplies)	Test set-up see <a href="#">Figure 10</a> $f(PCLK) \leq 50MHz$ ; $f(noise) = 1 Hz$ to 2 GHz		100	mV
		$f(PCLK) > 50MHz$ ; $f(noise) = 1 Hz$ to 1MHz		100	
		$f(PCLK) > 50MHz$ ; $f(noise) > 1MHz$		40	
$f_{PCLK}$	Pixel clock frequency	1-Channel transmit mode, see <a href="#">Figure 1</a>		4	MHz
		2-Channel transmit mode, see <a href="#">Figure 2</a>		8	
		3-Channel transmit mode, see <a href="#">Figure 3</a>		20	
		Frequency threshold Standby mode to active mode <sup>(2)</sup> , see <a href="#">Figure 14</a>		0.5	
$t_H \times f_{PCLK}$	PCLK input duty cycle			0.33	0.67
$T_A$	Operating free-air temperature			-40	85 °C
$t_{jit(per)PCLK}$	PCLK RMS period jitter <sup>(3)</sup>	Measured on PCLK input			5 ps-rms
$t_{jit(TJ)PCLK}$	PCLK total jitter				$0.05/f_{PCLK}$ s
$t_{jit(CC)PCLK}$	PCLK peak cycle-to-cycle jitter <sup>(4)</sup>				$0.02/f_{PCLK}$ s
<b>PCLK, R[0:7], G[0:7], B[0:7], VS, HS, DE, PCLK, LS[1:0], TXEN, SWAP</b>					
$V_{IH}$	High-level input voltage	$0.7 \times V_{DD}$		$V_{DD}$	V
$V_{IL}$	Low-level input voltage			$0.3 \times V_{DD}$	V
$t_{DS}$	Data set up time prior to PCLK transition	2.0			ns
$t_{DH}$	Data hold time after PCLK transition	2.0			ns

(1) Unused single-ended inputs must be held high or low to prevent them from floating.

(2) PCLK input frequencies lower than 500kHz force the SN65LVDS311 into standby mode. Input frequencies between 500kHz and 3MHz may or may not activate the SN65LVDS311. Input frequencies beyond 3MHz activate the SN65LVDS311.

(3) Period jitter is the deviation in cycle time of a signal with respect to the ideal period over a random sample of 100,000 cycles.

(4) Cycle-to-cycle jitter is the variation in cycle time of a signal between adjacent cycles; over a random sample of 1,000 adjacent cycle pairs.

## DEVICE ELECTRICAL CHARACTERISTICS

over recommended operating conditions (unless otherwise noted)

PARAMETER	TEST CONDITIONS	MIN	TYP <sup>(1)</sup>	MAX	UNIT
$I_{DD}$	1ChM $V_{DD} = V_{DDPLLA} = V_{DDPLL D} = V_{DDL VDS}$ , $R_{L(PCLK)} = R_{L(D0)} = 100 \Omega$ , $V_{IH} = V_{DD}$ , $V_{IL} = 0 V$ , TXEN at $V_{DD}$ , alternating 1010 serial bit pattern	$f_{PCLK} = 4MHz$	9.0	11.4	mA
		$f_{PCLK} = 6MHz$	10.6	12.6	
		$f_{PCLK} = 15MHz$	16	18.8	
	2ChM $V_{DD} = V_{DDPLLA} = V_{DDPLL D} = V_{DDL VDS}$ , $R_{L(PCLK)} = R_{L(D0)} = 100 \Omega$ , $V_{IH} = V_{DD}$ , $V_{IL} = 0 V$ , TXEN at $V_{DD}$ , typical power test pattern (see Table 7)	$f_{PCLK} = 4MHz$	8.0		mA
		$f_{PCLK} = 6MHz$	8.9		
		$f_{PCLK} = 15MHz$	14.0		
	2ChM $V_{DD} = V_{DDPLLA} = V_{DDPLL D} = V_{DDL VDS}$ , $R_{L(PCLK)} = R_{L(Dx)} = 100 \Omega$ , $V_{IH} = V_{DD}$ , $V_{IL} = 0 V$ , TXEN at $V_{DD}$ , alternating 1010 serial bit pattern;	$f_{PCLK} = 8MHz$	13.7	15.9	mA
		$f_{PCLK} = 22MHz$	18.4	22.0	
		$f_{PCLK} = 30MHz$	21.4	25.8	
	3ChM $V_{DD} = V_{DDPLLA} = V_{DDPLL D} = V_{DDL VDS}$ , $R_{L(PCLK)} = R_{L(D0)} = 100 \Omega$ , $V_{IH} = V_{DD}$ , $V_{IL} = 0 V$ , TXEN at $V_{DD}$ , alternating 1010 serial bit pattern	$f_{PCLK} = 8MHz$	11.5		mA
$f_{PCLK} = 22MHz$		16.0			
$f_{PCLK} = 30MHz$		19.1			
3ChM $V_{DD} = V_{DDPLLA} = V_{DDPLL D} = V_{DDL VDS}$ , $R_{L(PCLK)} = R_{L(D0)} = 100 \Omega$ , $V_{IH} = V_{DD}$ , $V_{IL} = 0 V$ , TXEN at $V_{DD}$ , alternating 1010 serial bit pattern	$f_{PCLK} = 20MHz$	20.0	22.5	mA	
	$f_{PCLK} = 65MHz$	29.1	36.8		
3ChM $V_{DD} = V_{DDPLLA} = V_{DDPLL D} = V_{DDL VDS}$ , $R_{L(PCLK)} = R_{L(D0)} = 100 \Omega$ , $V_{IH} = V_{DD}$ , $V_{IL} = 0 V$ , TXEN at $V_{DD}$ , typical power test pattern (see Table 9)	$f_{PCLK} = 20MHz$	15.9		mA	
	$f_{PCLK} = 65MHz$	24.7			
Standby Mode	$V_{DD} = V_{DDPLLA} = V_{DDPLL D} = V_{DDL VDS}$		0.61	10	$\mu A$
Shutdown Mode	$R_{L(PCLK)} = R_{L(D0)} = 100 \Omega$ , $V_{IH} = V_{DD}$ , $V_{IL} = 0 V$ , all inputs held static high or static low		0.55	10	$\mu A$

(1) All typical values are at 25°C and with 1.8 V supply unless otherwise noted.

## OUTPUT ELECTRICAL CHARACTERISTICS

over operating free-air temperature range (unless otherwise noted)

PARAMETER	TEST CONDITIONS	MIN	TYP <sup>(1)</sup>	MAX	UNIT
<b>subLVDS output (D0+, D0-, D1+, D1-, D2+, D1-, CLK+, and CLK-)</b>					
$V_{OCM(SS)}$ Steady-state common-mode output voltage	Output load see Figure 8	0.8	0.9	1.0	V
$V_{OCM(SS)}$ Change in steady-state common-mode output voltage		-10		10	mV
$V_{OCM(PP)}$ Peak-to-peak common mode output voltage				75	mV
$ V_{OD} $ Differential output voltage magnitude $ V_{Dx+} - V_{Dx-} $ , $ V_{CLK+} - V_{CLK-} $		100	150	200	mV
$\Delta V_{OD} $ Change in differential output voltage between logic states		-10		10	mV
$Z_{OD(CLK)}$ Differential small-signal output impedance	TXEN at $V_{DD}$		210		$\Omega$
$I_{OSD}$ Differential short-circuit output current	$V_{OD} = 0 V$ , $f_{PCLK} = 28MHz$			10	mA
$I_{OS}$ Short circuit output current <sup>(2)</sup>	$V_O = 0 V$ or $V_{DD}$		5		
$I_{OZ}$ High-impedance state output current	$V_O = 0 V$ or $V_{DD(max)}$ , TXEN at GND	-3		3	$\mu A$

(1) All typical values are at 25°C and with 1.8 V supply unless otherwise noted.

(2) All SN65LVDS311 outputs tolerate shorts to GND or  $V_{DD}$  without permanent device damage.

## INPUT ELECTRICAL CHARACTERISTICS

over operating free-air temperature range (unless otherwise noted)

PARAMETER	TEST CONDITIONS	MIN	TYP <sup>(1)</sup>	MAX	UNIT
<b>PCLK, R[0:7], G[0:7], B[0:7], VS, HS, DE, PCLK, LS[1:0], TXEN, SWAP</b>					
I <sub>IH</sub>	High-level input current	V <sub>IN</sub> = 0.7 × V <sub>DD</sub>	-200	200	nA
I <sub>IL</sub>	Low-level input current	V <sub>IN</sub> = 0.3 × V <sub>DD</sub>	-200	200	
C <sub>IN</sub>	Input capacitance		1.5		pF

(1) All typical values are at 25°C and with 1.8 V supply unless otherwise noted.

## SWITCHING CHARACTERISTICS

over recommended operating conditions (unless otherwise noted)

PARAMETER	TEST CONDITIONS	MIN	TYP <sup>(1)</sup>	MAX	UNIT		
t <sub>r</sub>	20%-to-80% differential output signal rise time	See Figure 7 and Figure 8	250	500	ps		
t <sub>f</sub>	20%-to-80% differential output signal fall time	See Figure 7 and Figure 8	250	500			
f <sub>BW</sub>	PLL bandwidth (3dB cutoff frequency)	Tested from PCLK input to CLK output, See Figure 5 <sup>(2)</sup>	f <sub>PCLK</sub> = 22MHz f <sub>PCLK</sub> = 65MHz	0.082 × f <sub>PCLK</sub> 0.07 × f <sub>PCLK</sub>	MHz		
t <sub>pd(L)</sub>	Propagation delay time, input to serial output (data latency Figure 9)	TXEN at V <sub>DD</sub> , V <sub>IH</sub> =V <sub>DD</sub> , V <sub>IL</sub> =GND, R <sub>L</sub> =100 Ω	1-channel mode 2-channel mode 3-channel mode	0.8/f <sub>PCLK</sub> 1.0/f <sub>PCLK</sub> 1.1/f <sub>PCLK</sub>	1/f <sub>PCLK</sub> 1.21/f <sub>PCLK</sub> 1.31/f <sub>PCLK</sub>	1.2/f <sub>PCLK</sub> 1.5/f <sub>PCLK</sub> 1.6/f <sub>PCLK</sub>	s
t <sub>H</sub> × f <sub>CLK0</sub>	Output CLK duty cycle		1-channel and 3-channel mode 2-channel mode	0.45 0.49	0.50 0.53	0.55 0.58	
t <sub>GS</sub>	TXEN Glitch suppression pulse width <sup>(3)</sup>	V <sub>IH</sub> =V <sub>DD</sub> , V <sub>IL</sub> =GND, TXEN toggles between V <sub>IL</sub> and V <sub>IH</sub> , see Figure 12 and Figure 13	3.8		10	μs	
t <sub>pwrup</sub>	Enable time from power down (↑TXEN)	Time from TXEN pulled high to CLK and Dx outputs enabled and transmit valid data; see Figure 13		0.24	2	ms	
t <sub>pwrdn</sub>	Disable time from active mode (↓TXEN)	TXEN is pulled low during transmit mode; time measurement until output is disabled and PLL is Shutdown; see Figure 13		0.5	11	μs	
t <sub>wakup</sub>	Enable time from Standby (↑PCLK)	TXEN at V <sub>DD</sub> ; device in standby; time measurement from PCLK starts switching to CLK and Dx outputs enabled and transmit valid data; see Figure 13		0.23	2	ms	
t <sub>sleep</sub>	Disable time from Active mode (PCLK stopping)	TXEN at V <sub>DD</sub> ; device is transmitting; time measurement from PCLK input signal stops until CLK + Dx outputs are disabled and PLL is disabled; see Figure 13		0.4	100	μs	

(1) All typical values are at 25°C and with 1.8 V supply unless otherwise noted.

(2) The Maximum Limit is based on statistical analysis of the device performance over process, voltage, and temp ranges. This parameter is functionality tested only on Automatic Test Equipment (ATE).

(3) The TXEN input incorporates glitch-suppression circuitry to disregard short input pulses. t<sub>GS</sub> is the duration of either a high-to-low or low-to-high transition that is suppressed.

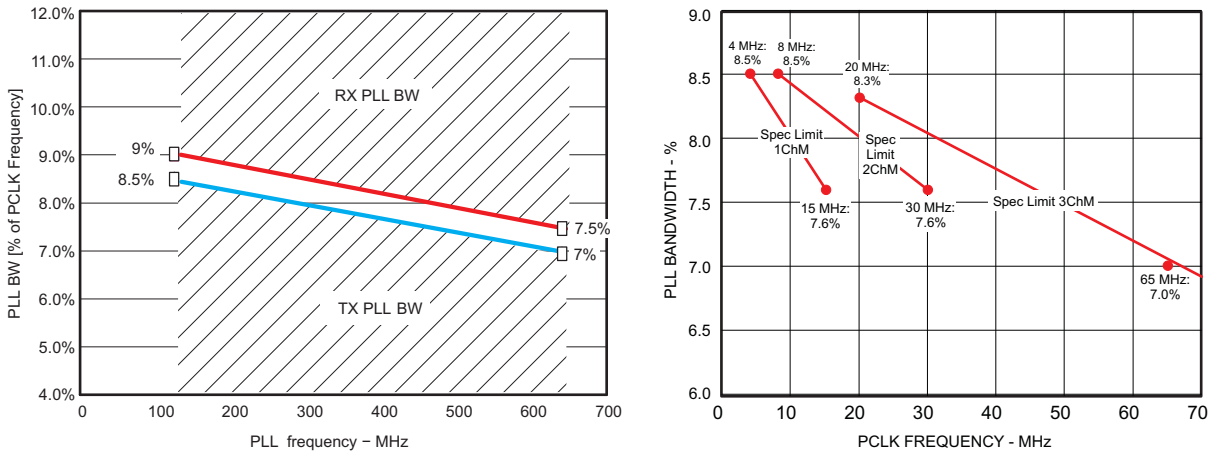

Figure 5. LVDS311 PLL Bandwidth (also showing the LVDS302 PLL bandwidth)

**TIMING CHARACTERISTICS**

PARAMETER	TEST CONDITIONS	MIN	TYP	MAX	UNIT
t <sub>PPOSX</sub> Output Pulse Position, ↑serial data to ↑CLK; see (1) (2) and Figure 11	1ChM: x=0..29, f <sub>PCLK</sub> =15MHz; TXEN at V <sub>DD</sub> , V <sub>IH</sub> =V <sub>DD</sub> , V <sub>IL</sub> =GND, R <sub>L</sub> =100 Ω, test pattern as in Table 12 (3)	$\frac{x}{30 \cdot f_{PCLK}} - 330 \text{ ps}$		$\frac{x}{30 \cdot f_{PCLK}} + 330 \text{ ps}$	ps
	1ChM: x=0..29, f <sub>PCLK</sub> =4MHz to 15MHz (4)	$\frac{x - 0.1845}{30 \cdot f_{PCLK}}$		$\frac{x + 0.1845}{30 \cdot f_{PCLK}}$	
	2ChM: x = 0..14, f <sub>PCLK</sub> = 30MHz TXEN at V <sub>DD</sub> , V <sub>IH</sub> =V <sub>DD</sub> , V <sub>IL</sub> =GND, R <sub>L</sub> =100 Ω, test pattern as in Table 13 (3)	$\frac{x}{15 \cdot f_{PCLK}} - 330 \text{ ps}$		$\frac{x}{15 \cdot f_{PCLK}} + 330 \text{ ps}$	
	2ChM: x=0..14, f <sub>PCLK</sub> = 8MHz to 30MHz (4)	$\frac{x - 0.1845}{15 \cdot f_{PCLK}}$		$\frac{x + 0.1845}{15 \cdot f_{PCLK}}$	
	3ChM: x=0..9, f <sub>PCLK</sub> =65MHz, TXEN at V <sub>DD</sub> , V <sub>IH</sub> =V <sub>DD</sub> , V <sub>IL</sub> =GND, R <sub>L</sub> =100 Ω, test pattern as in Table 14 (3)	$\frac{x}{10 \cdot f_{PCLK}} - 210 \text{ ps}$		$\frac{x}{10 \cdot f_{PCLK}} + 210 \text{ ps}$	
	3ChM: x=0..9, f <sub>PCLK</sub> =20MHz to 65MHz (4)	$\frac{x - 0.153}{10 \cdot f_{PCLK}}$		$\frac{x + 0.153}{10 \cdot f_{PCLK}}$	

- (1) This number also includes the high-frequency random and deterministic PLL clock jitter that is not traceable by the SN65LVDS302 receiver PLL; t<sub>PPOSX</sub> represents the total timing uncertainty of the transmitter necessary to calculate the jitter budget when combined with the SN65LVDS302 receiver;
- (2) The pulse position min/max variation is given with a bit error rate target of 10<sup>-12</sup>; The measurement estimates the random jitter contribution to the total jitter contribution by multiplying the random RMS jitter by the factor 14; Measurements of the total jitter are taken over a sample amount of > 10<sup>-12</sup> samples.
- (3) The Minimum and Maximum Limits are based on statistical analysis of the device performance over process, voltage, and temp ranges. This parameter is functionality tested only on Automatic Test Equipment (ATE).
- (4) These Minimum and Maximum Limits are simulated only.

## PARAMETER MEASUREMENT INFORMATION

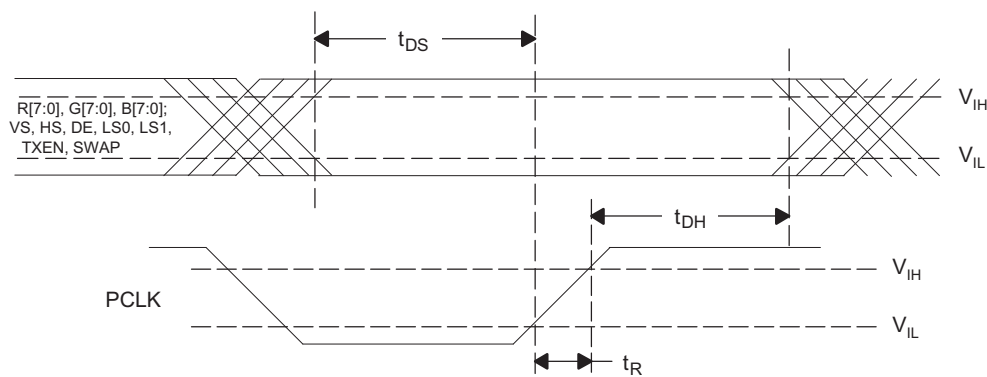

Figure 6. Setup/Hold Time

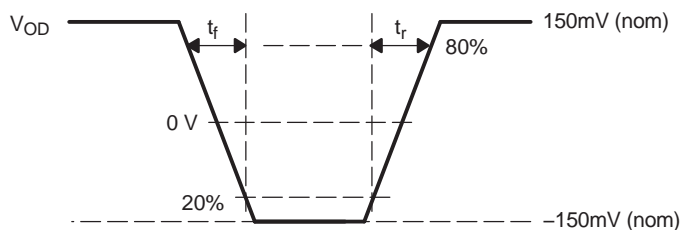
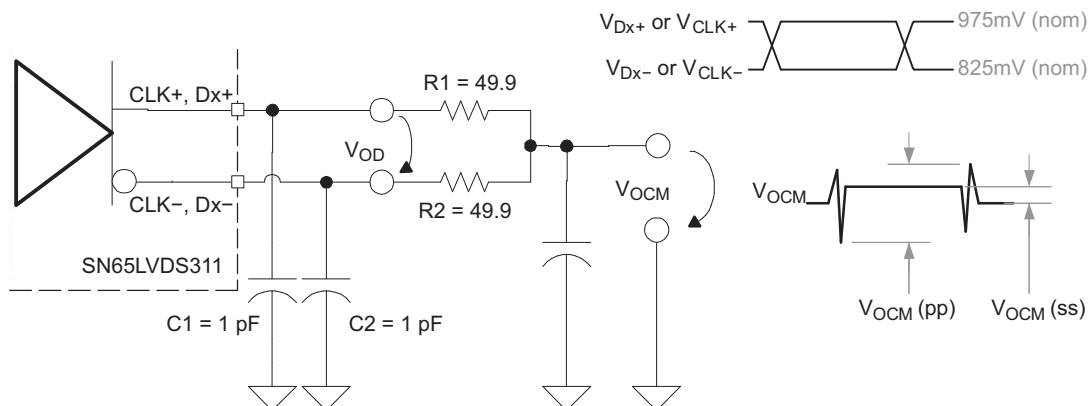

Figure 7. Rise and Fall Time Definitions



NOTES:

- A. 20 MHz output test pattern on all differential outputs (CLK, D0, D1, and D2):  
this is achieved by:
  1. Device is set to 3-channel-mode;
  2.  $f_{PCLK} = 20$  MHz
  3. Inputs R[7:3] = B[7:3] connected to  $V_{DD}$ , all other data inputs set to GND.
- B. C1, C2 and C3 includes instrumentation and fixture capacitance; tolerance  $\pm 20\%$ ; C, R1 and R2 tolerance  $\pm 1\%$ .
- C. The measurement of  $V_{ODM(pp)}$  and  $V_{ODM(ss)}$  are taken with test equipment bandwidth  $>1$  GHz.

Figure 8. Driver Output Voltage Test Circuit and Definitions

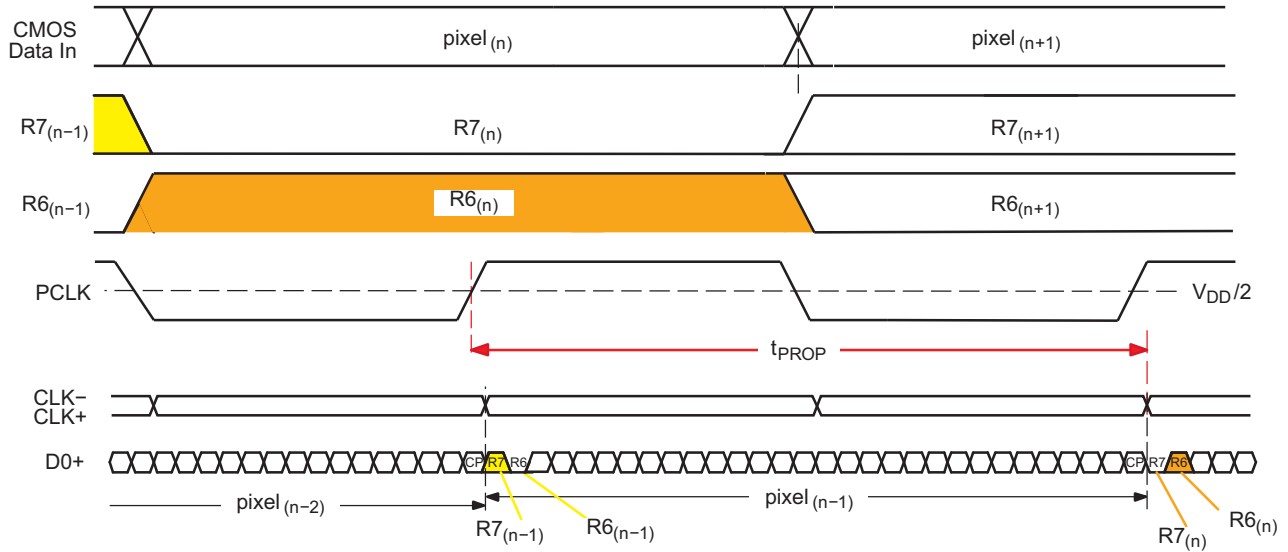

Figure 9.  $t_{pd(L)}$  Propagation Delay Input to Output (LS0 = LS1 = 0)

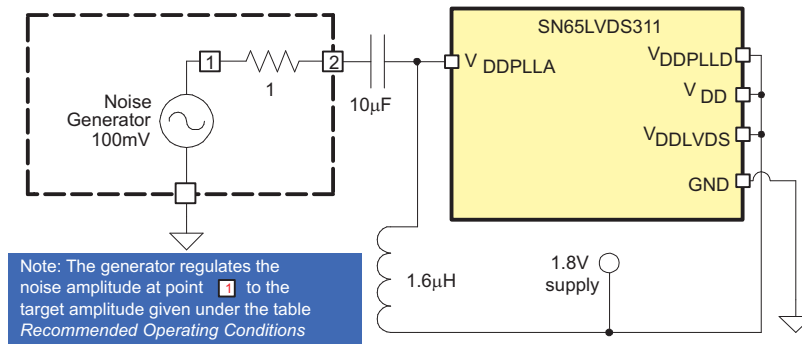

Figure 10. Power Supply Noise Test Set-Up

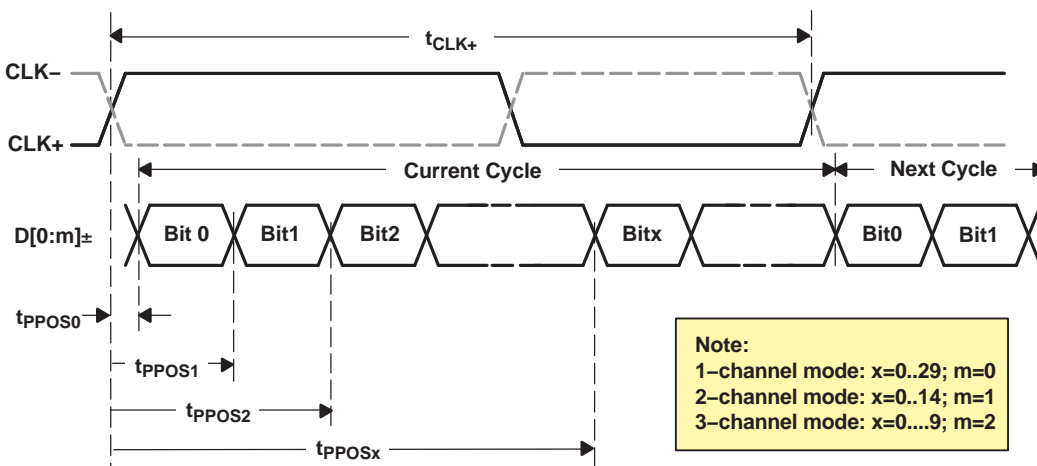

Figure 11.  $t_{SK(0)}$  SubLVDS Output Pulse Position Measurement

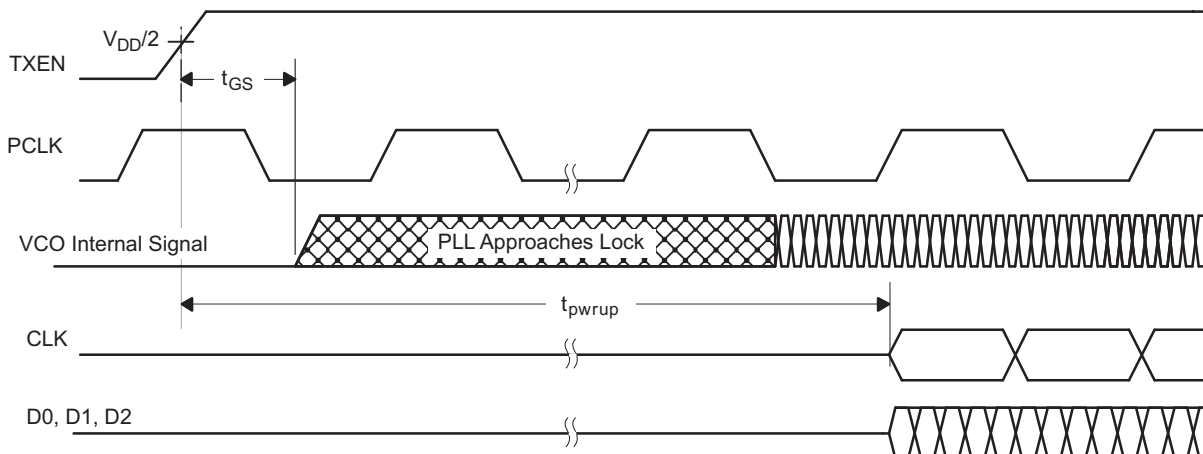

Figure 12. Transmitter Behavior While Approaching Sync

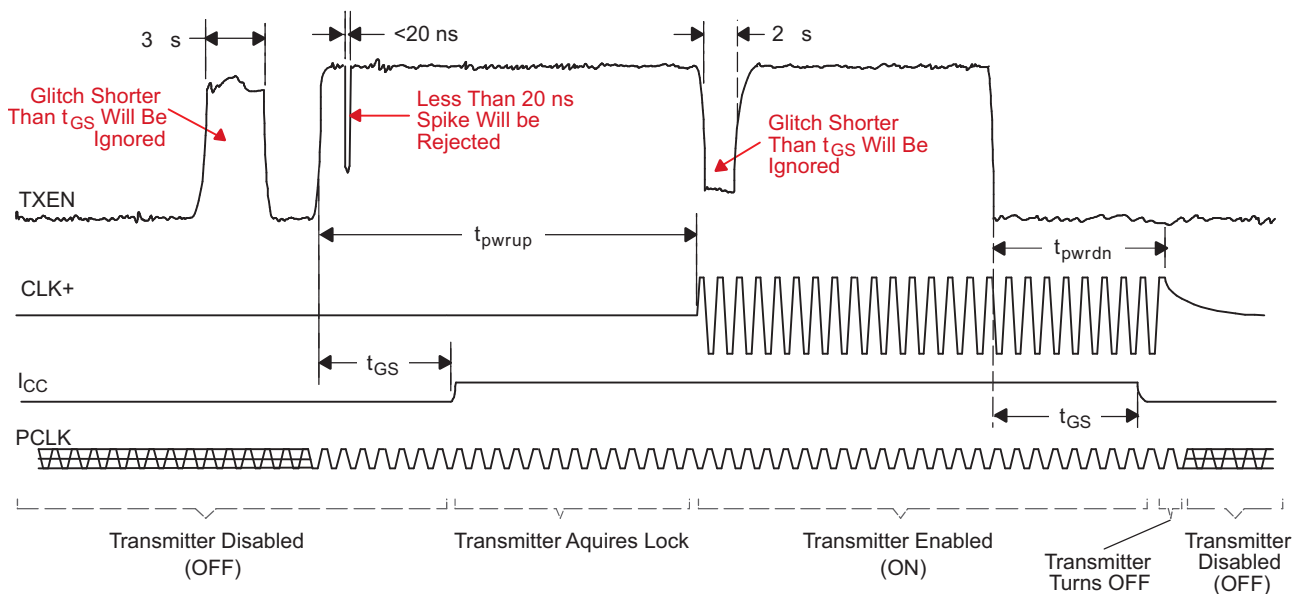

Figure 13. Transmitter Enable Glitch Suppression Time

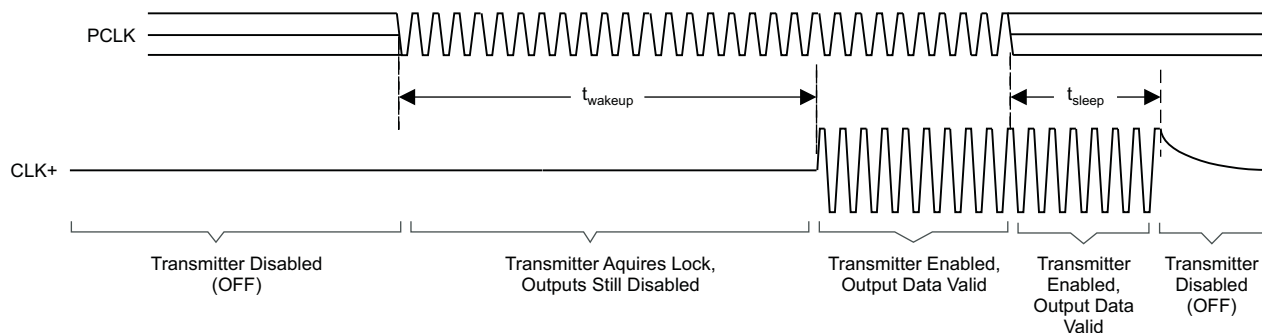

Figure 14. Standby Detection

Power Consumption Tests

Table 6 shows an example test pattern word.

**Table 6. Example Test Pattern Word**

Word	R[7:4], R[3:0], G[7:4], G[3:0], B[7-4], B[3-0], 0,VS,HS,DE
1	0x7C3E1E7

7				C				3				E				1				E				7			
R7	R6	R5	R4	R3	R2	R1	R0	G7	G6	G5	G4	G3	G2	G1	G0	B7	B6	B5	B4	B3	B2	B1	B0	0	VS	HS	DE
0	1	1	1	1	1	0	0	0	0	1	1	1	1	1	0	0	0	0	1	1	1	1	0	0	1	1	1

**Typical IC Power Consumption Test Pattern**

The typical power consumption test patterns consists of sixteen 30-bit transmit words in 1-channel mode, eight 30-bit transmit words in 2-channel mode and five 30-bit transmit words in 3-channel mode. The pattern repeats itself throughout the entire measurement. It is assumed that every possible transmit code on RGB inputs has the same probability to occur during typical device operation.

**Table 7. Typical IC Power Consumption Test Pattern, 1-Channel Mode**

Word	Test Pattern: R[7:4], R[3:0], G[7:4], G[3:0], B[7-4], B[3-0], 0,VS,HS,DE
1	0x0000007
2	0xFFFF007
3	0x01FFF47
4	0xF0E07F7
5	0x7C3E1E7
6	0xE707C37
7	0xE1CE6C7
8	0xF1B9237
9	0x91BB347
10	0xD4CCC67
11	0xAD53377
12	0xACB2207
13	0xAAB2697
14	0x5556957
15	0xAAAAAB3
16	0xAAAAAA5



**Table 8. Typical IC Power Consumption Test Pattern, 2-Channel Mode**

Word	Test Pattern: R[7:4], R[3:0], G[7:4], G[3:0], B[7-4], B[3-0], 0,VS,HS,DE
1	0x0000001
2	0x03F03F1
3	0xBFFBFF1
4	0x1D71D71
5	0x4C74C71
6	0xC45C451
7	0xA3aA3A5
8	0x5555553

**Table 9. Typical IC Power Consumption Test Pattern, 3-Channel Mode**

Word	Test Pattern: R[7:4], R[3:0], G[7:4], G[3:0], B[7-4], B[3-0], 0,VS,HS,DE
1	0xFFFFFFFF1
2	0x0000001
3	0xF0F0F01
4	0xCCCCCC1
5	0xAAAAAA7

### Maximum Power Consumption Test Pattern

The maximum (or worst-case) power consumption of the SN65LVDS311 is tested using the two different test patterns shown in [Table 10](#) and [Table 11](#). The test patterns consist of sixteen 30-bit transmit words in 1-channel mode, eight 30-bit transmit words in 2-channel mode and five 30-bit transmit words in 3-channel mode. The pattern repeats itself throughout the entire measurement. It is assumed that every possible transmit code on RGB inputs has the same probability to occur during typical device operation.

**Table 10. Worst-Case Power Consumption Test Pattern**

Word	Test Pattern: R[7:4], R[3:0], G[7:4], G[3:0], B[7-4], B[3-0], 0,VS,HS,DE
1	0xAAAAAA5
2	0x5555555

**Table 11. Worst-Case Power Consumption Test Pattern**

Word	Test Pattern: R[7:4], R[3:0], G[7:4], G[3:0], B[7-4], B[3-0], 0,VS,HS,DE
1	0x0000000
2	0xFFFFFFFF7

## Output Skew Pulse Position & Jitter Performance

The following test patterns are used to measure the output-skew pulse position and the jitter performance of the SN65LVDS311. The jitter test pattern stresses the interconnect, particularly to test for ISI. Very long run-lengths of consecutive bits incorporate very high and low data rates, maximizing switching noise. Each pattern is self-repeating for the duration of the test.

**Table 12. Transmit Jitter Test Pattern, 1-Channel Mode**

Word	Test Pattern: R[7:4], R[3:0], G[7:4], G[3:0], B[7-4], B[3-0], 0,VS,HS,DE
1	0x0000001
2	0x0000031
3	0x00000F1
4	0x00003F1
5	0x0000FF1
6	0x0003FF1
7	0x000FFF1
8	0x0F0F0F1
9	0x0C30C31
10	0x0842111
11	0x1C71C71
12	0x18C6311
13	0x1111111
14	0x3333331
15	0x2452413
16	0x22A2A25
17	0x5555553
18	0xDB6DB65
19	0xCCCCCC1
20	0xEEEEEE1
21	0xE739CE1
22	0xE38E381
23	0xF7BDEE1
24	0xF3CF3C1
25	0xF0F0F01
26	0xFFFF001
27	0xFFFC001
28	0xFFFF001
29	0xFFFC01
30	0xFFFF01
31	0xFFFC1
32	0xFFFF1

**Table 13. Transmit Jitter Test Pattern, 2-Channel Mode**

Word	Test Pattern: R[7:4], R[3:0], G[7:4], G[3:0], B[7-4], B[3-0], 0,VS,HS,DE
1	0x0000001
2	0x000FFF3
3	0x8008001
4	0x0030037
5	0xE00E001
6	0x00FF001
7	0x007E001
8	0x003C001
9	0x0018001
10	0x1C7E381
11	0x3333331
12	0x555AAA5
13	0x6DBDB61
14	0x7777771
15	0x555AAA3
16	0xAAAAAA5
17	0x5555553
18	0xAAA5555
19	0x8888881
20	0x9242491
21	0xAAA5571
22	0xCCCCC1
23	0xE3E1C71
24	0xFFE7FF1
25	0xFFC3FF1
26	0xFF81FF1
27	0xFE00FF1
28	0x1FF1FF1
29	0xFFCFFC3
30	0x7FF7FF1
31	0xFFF0007
32	0xFFFFFFFF1

**Table 14. Transmit Jitter Test Pattern, 3-Channel Mode**

Word	Test Pattern: R[7:4], R[3:0], G[7:4], G[3:0], B[7-4], B[3-0], 0,VS,HS,DE
1	0x0000001
2	0x0000001
3	0x0000003
4	0x0101013
5	0x0303033
6	0x0707073
7	0x1818183
8	0xE7E7E71
9	0x3535351
10	0x0202021
11	0x5454543
12	0xA5A5A51
13	0xADADAD1
14	0x5555551
15	0xA6A2AA3
16	0xA6A2AA5
17	0x5555553
18	0x5555555
19	0xAAAAAA1
20	0x5252521
21	0x5A5A5A1
22	0xABABAB1
23	0xFDFCFD1
24	0xCAAACA1
25	0x1818181
26	0xE7E7E71
27	0xF8F8F81
28	0xFCFCFC1
29	0xFEFEFE1
30	0xFFFFFFFF1
31	0xFFFFFFFF5
32	0xFFFFFFFF5

TYPICAL CHARACTERISTICS

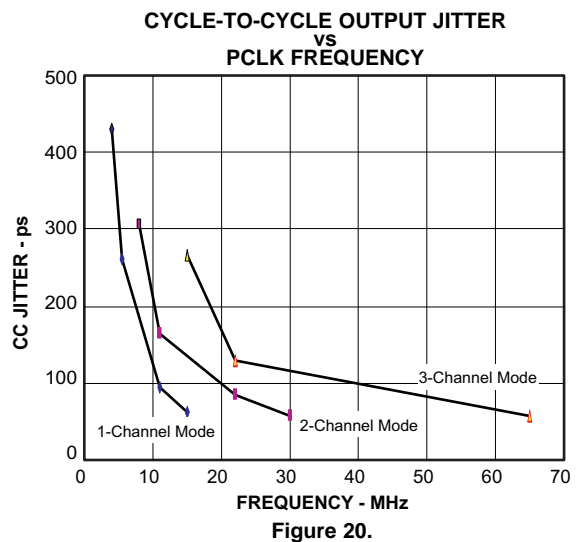
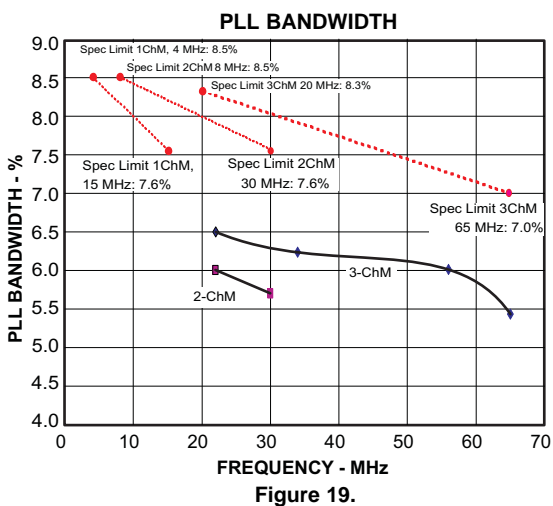
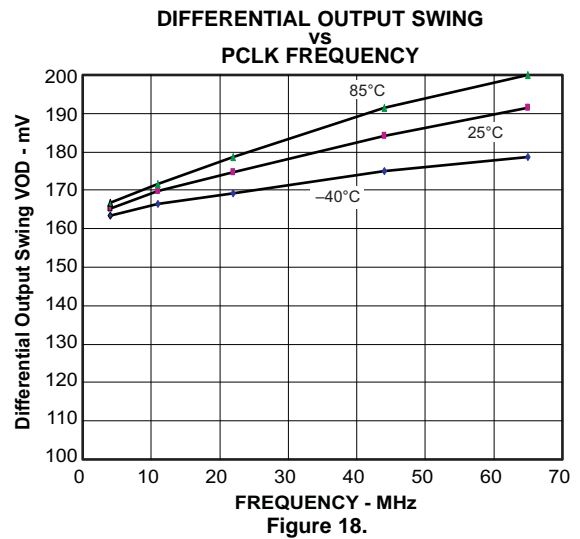
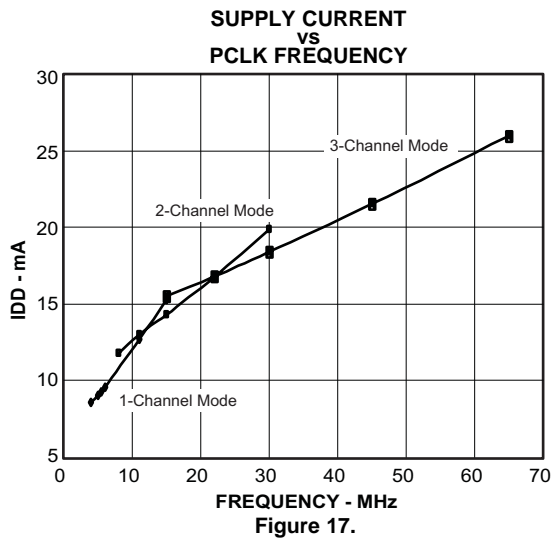
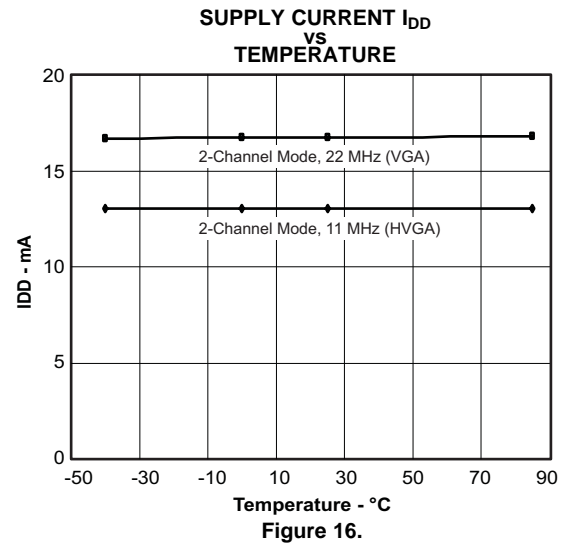
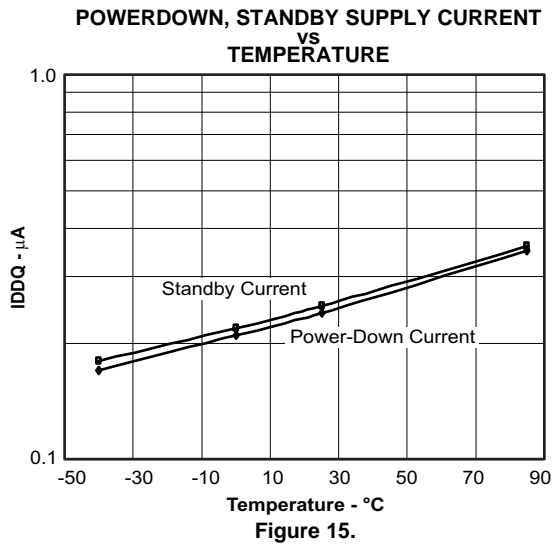

**TYPICAL CHARACTERISTICS (continued)**

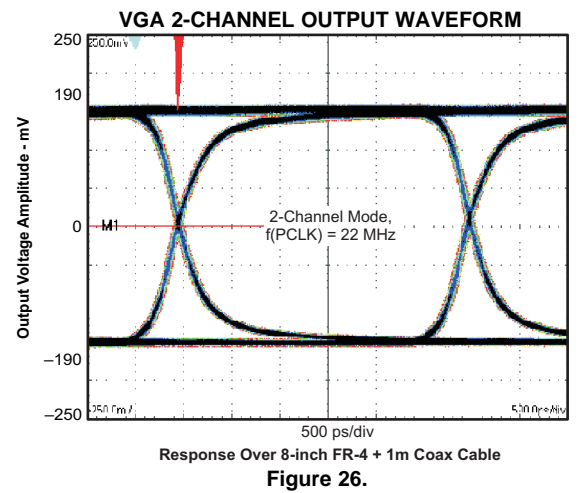
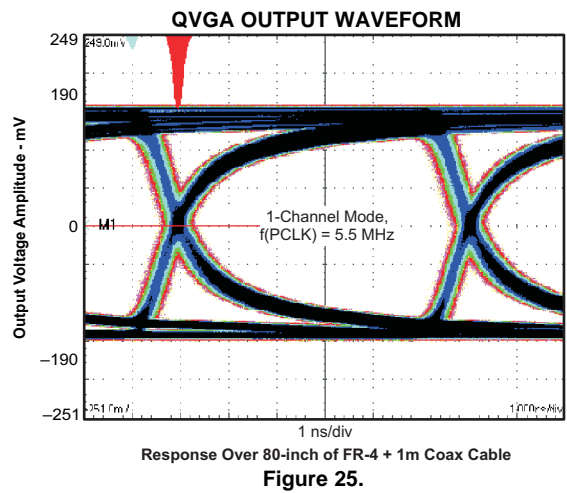
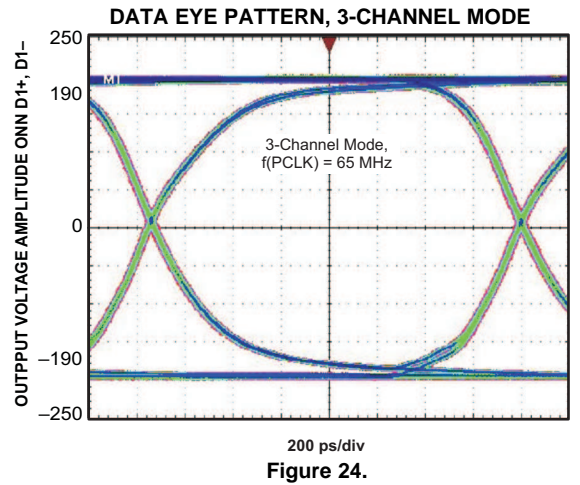
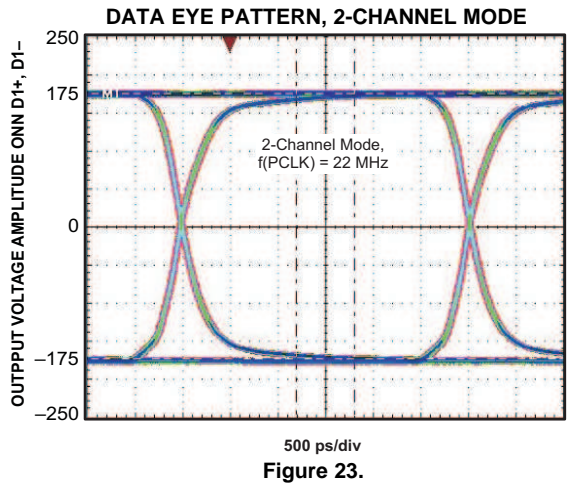
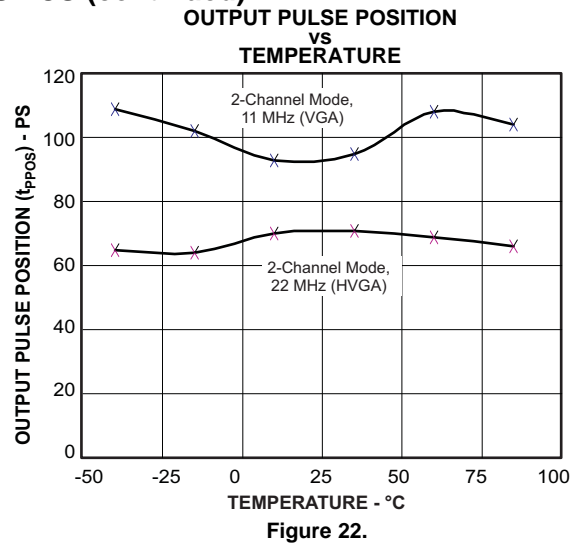
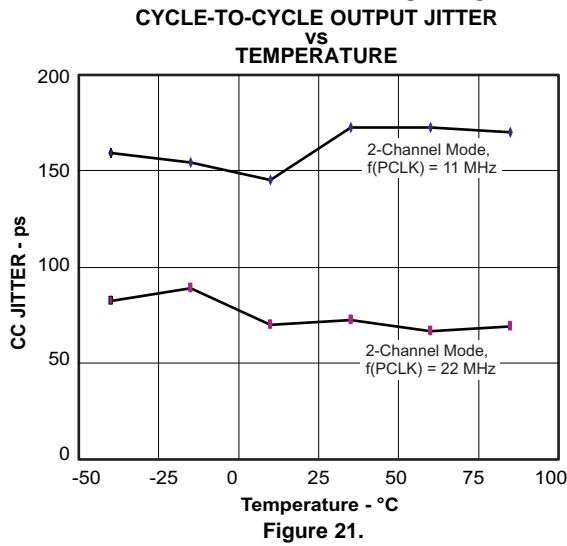

TYPICAL CHARACTERISTICS (continued)

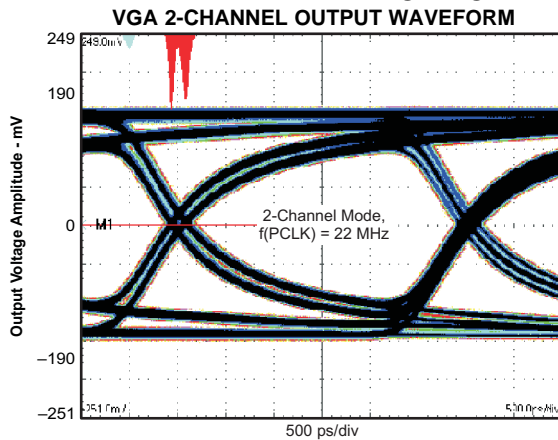

Response Over 80-inch FR-4 + 1m Coax Cable  
Figure 27.

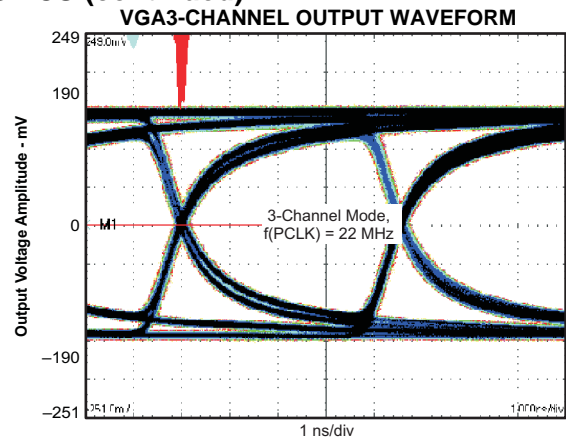

Response Over 80-inch FR-4 + 1m Coax Cable  
Figure 28.

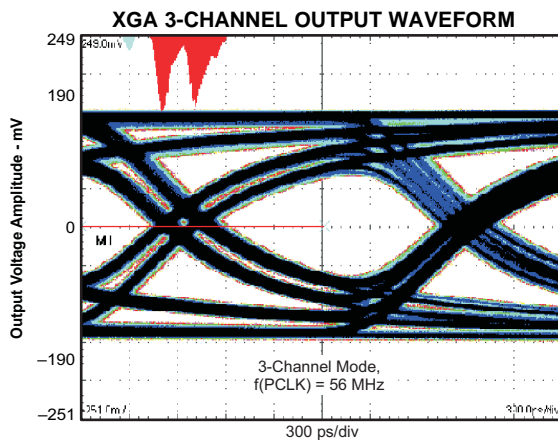

Response Over 80-inch FR-4 + 1m Coax Cable  
Figure 29.

XGA 3-CHANNEL OUTPUT WAVEFORM ON THE SN65LVDS302 WHEN DRIVEN BY THE SN65LVDS311

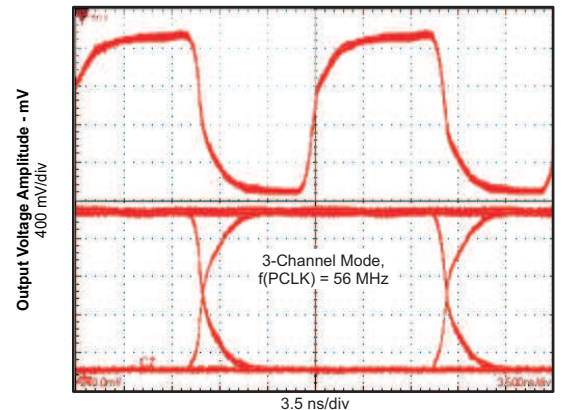

Response With 10-pF Load  
Figure 30.

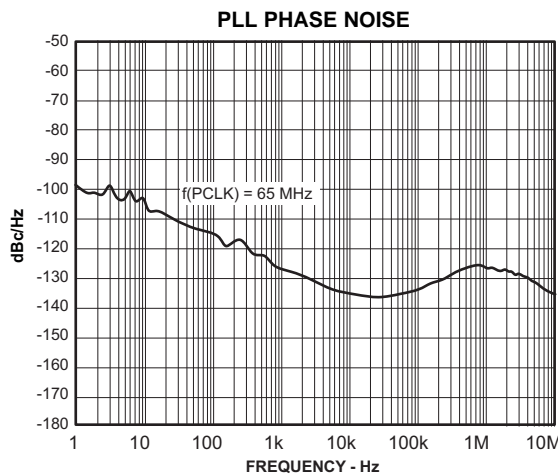

Figure 31.

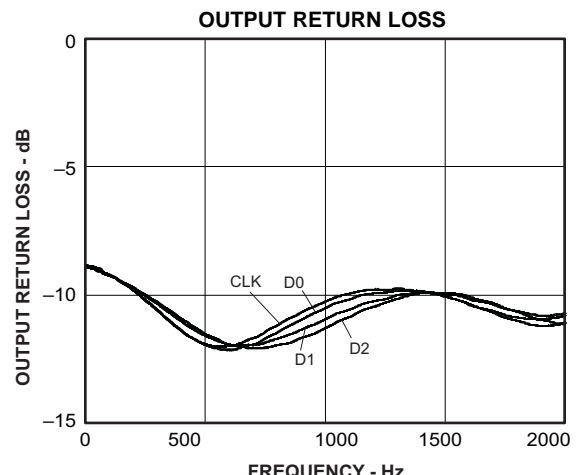

Figure 32.

**TYPICAL CHARACTERISTICS (continued)**

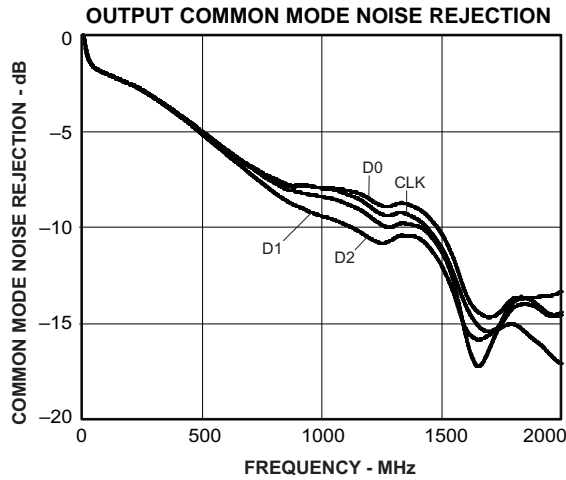

Figure 33.

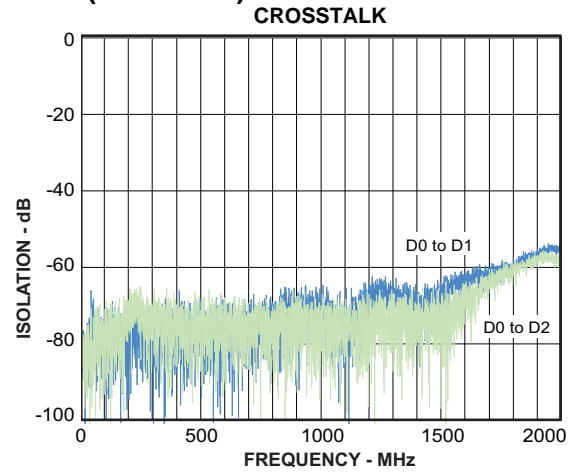

Figure 34.

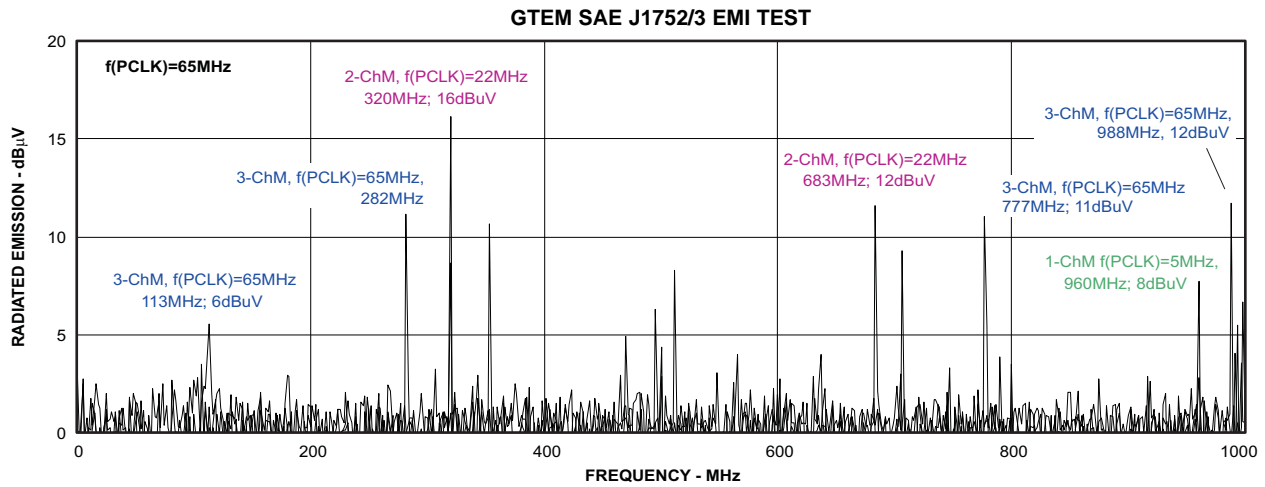

Figure 35.

- A. **Figure 35** shows a superimposed image of three EMI measurements with the device operating at  $f(\text{PCLK}) = 5\text{MHz}$ ,  $f(\text{PCLK}) = 22\text{MHz}$ , and  $f(\text{PCLK}) = 65\text{MHz}$ . This excellent EMI performance meets the system requirements of dense, mobile designs with a noise floor of  $\sim 2\text{ dB}\mu\text{V}$  ( $\sim 105\text{ dBm}$ ) and all spurs being smaller than  $16\text{ dB}\mu\text{V}$  ( $\sim 101\text{ dBm}$ ). The test was performed in compliance with the SAE J1752/3 EMI test guidelines.



## APPLICATION INFORMATION

### Preventing Increased Leakage Currents in Control Inputs

A floating (left open) CMOS input allows leakage currents to flow from  $V_{DD}$  to GND. Do not leave any CMOS Input unconnected or floating. Every input must be connected to a valid logic level  $V_{IH}$  or  $V_{OL}$  while power is supplied to  $V_{DD}$ . This also minimizes the power consumption of standby and power down mode.

### Power Supply Design Recommendation

For a multilayer pcb, it is recommended to keep one common GND layer underneath the device and connect all ground terminals directly to this plane.

### Decoupling Recommendation

The SN65LVDS311 was designed to operate reliably in a constricted environment with other digital switching ICs. In many designs, the SN65LVDS311 often shares a power supply with the application processor. The SN65LVDS311 can operate with power supply noise as specified in *Recommend Device Operating Conditions*. To minimize the power supply noise floor, provide good decoupling near the SN65LVDS311 power pins. The use of four ceramic capacitors ( $2 \times 0.01 \mu\text{F}$  and  $2 \times 0.1 \mu\text{F}$ ) provides good performance. At the very least, it is recommended to install one  $0.1 \mu\text{F}$  and one  $0.01 \mu\text{F}$  capacitor near the SN65LVDS311. To avoid large current loops and trace inductance, the trace length between decoupling capacitor and IC power inputs pins must be minimized. Placing the capacitor underneath the SN65LVDS311 on the bottom of the pcb is often a good choice.

### VGA Application

Figure 36 shows a possible implementation of a VGA display.

The LVDS311 interfaces directly to a LCD driver with integrated FlatLink3G receiver. The SPI interface is used to configure the display. The pixel clock rate of 22MHz assumes  $\approx 10\%$  blanking overhead and 60Hz display refresh rate. The application assumes 24-bit color resolution.

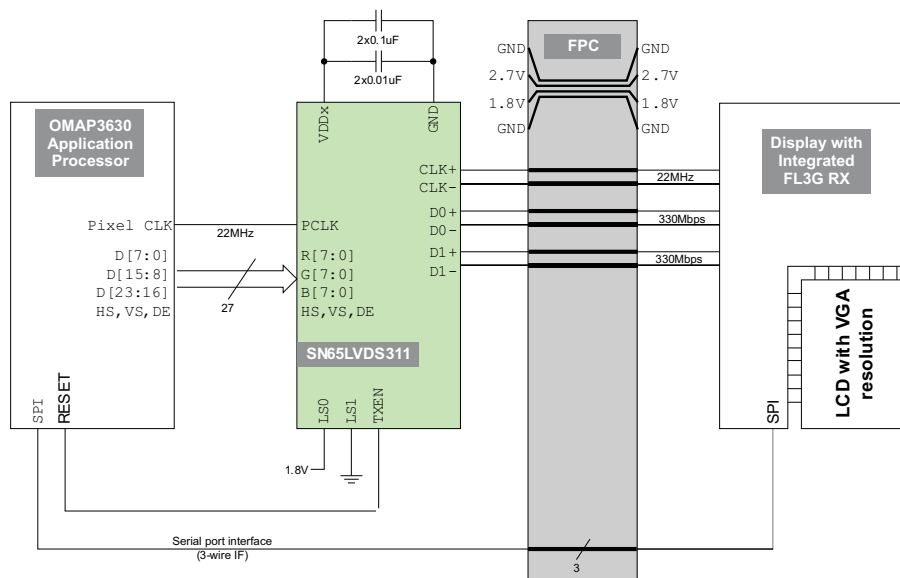

Figure 36. Typical VGA Display Application

### Dual LCD-Display Application

The example in Figure 37 shows a possible application setup driving two video mode displays from one application processor. The data rate of 330 Mbps at a pixel clock rate of 5.5 MHz corresponds to QVGA resolution at 60 Hz refresh rate and 10% blanking overhead.

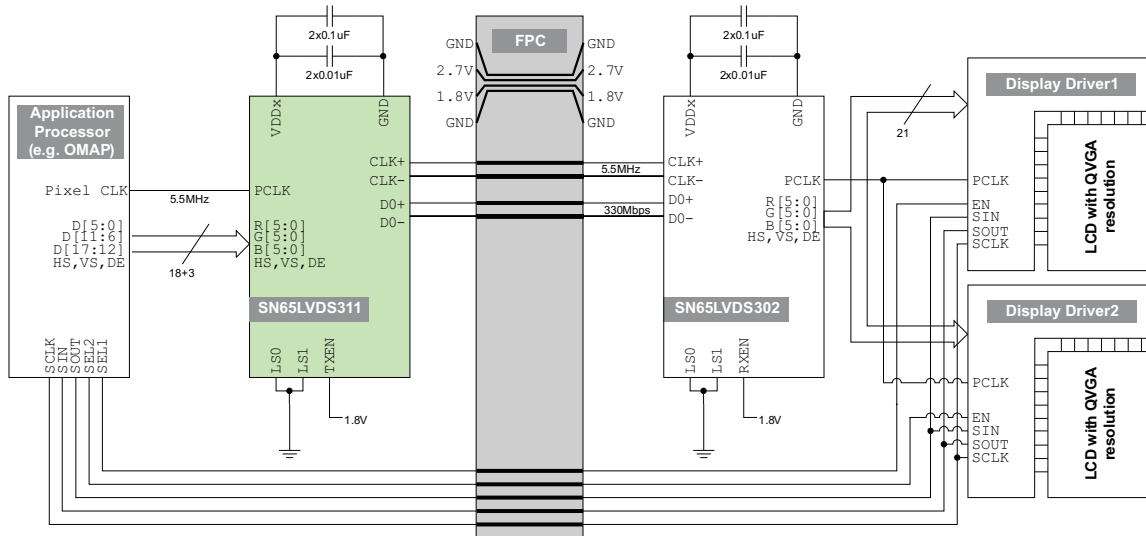

Figure 37. Example Dual-QVGA Display Application

### Typical Application Frequencies

The SN65LVDS311 supports pixel clock frequencies from 4MHz to 65MHz over 1, 2, or 3 data lanes. Table 15 provides a few typical display resolution examples and shows the number of data lanes necessary to connect the LVDS311 with the display. The blanking overhead is assumed to be 20%. Often, blanking overhead is smaller, resulting in a lower data rate. Furthermore, the examples in the table assumes a display frame refresh rate of 60 Hz or 90 Hz. The actual refresh rate may differ depending on the application-processor clock implementation.

Table 15. Typical Application Data Rates & Serial Lane Usage

Display Screen Resolution	Visible Pixel Count	Blanking Overhead	Display Refresh Rate	Pixel Clock Frequency [MHz]	Serial Data Rate Per Lane			
					1-ChM	2-ChM	3-ChM	
176x220 (QCIF+)	38,720	20%	90 Hz	4.2MHz	125 Mbps			
240x320 (QVGA)	76,800			5.5MHz	166 Mbps			
640x200	128,000		60 Hz	9.2MHz	276 Mbps	138 Mbps		
352x416 (CIF+)	146,432			10.5MHz	316 Mbps	158 Mbps		
352x440	154,880			11.2MHz	335 Mbps	167 Mbps		
320x480 (HVGA)	153,600			11.1MHz	332 Mbps	166 Mbps		
800x250	200,000			14.4MHz	432 Mbps	216 Mbps		
640x320	204,800			14.7MHz	442 Mbps	221 Mbps		
640x480 (VGA)	307,200			22.1MHz		332 Mbps	221 Mbps	
1024x320	327,680			23.6MHz		354 Mbps	236 Mbps	
854x480 (WVGA)	409,920			29.5MHz		443 Mbps	295 Mbps	
800x600 (SVGA)	480,000			34.6MHz				346 Mbps
1024x768 (XGA)	786,432		56.6MHz				566 Mbps	

### Calculation Example: HVGA Display

This example calculation shows a typical Half-VGA display with these parameters:

Display Resolution:	480 x 320
Frame Refresh Rate:	58.4 Hz
Horizontal Visible Pixel:	480 columns
Horizontal Front Porch:	20 columns
Horizontal Sync:	5 columns
Horizontal Back Porch:	3 columns
Vertical Visible Pixel:	320 lines
Vertical Front Porch:	10 lines
Vertical Sync:	5 lines
Vertical Back Porch:	3 lines

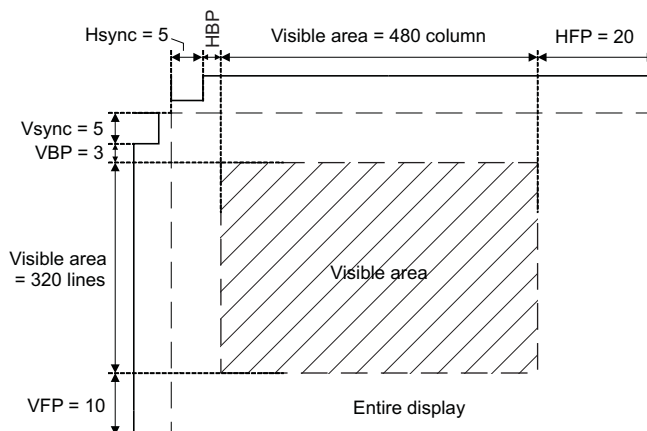

Figure 38. HVGA Display Parameters

Calculation of the total number of pixel and Blanking overhead:

Visible Area Pixel Count:	$480 \times 320 = 153600$ pixel
Total Frame Pixel Count:	$(480+20+5+3) \times (320+10+5+3) = 171704$ pixel
Blanking Overhead:	$(171704-153600) \div 153600 = 11.8 \%$

The application requires following serial-link parameters:

Pixel Clk Frequency:	$171704 \times 58.4 \text{ Hz} = 10.0\text{MHz}$
Serial Data Rate:	1-channel mode: $10.0\text{MHz} \times 30 \text{ bit/channel} = 300 \text{ Mbps}$
	2-channel mode: $10.0\text{MHz} \times 15 \text{ bit/channel} = 150 \text{ Mbps}$

**PACKAGING INFORMATION**

Orderable Device	Status (1)	Package Type	Package Drawing	Pins	Package Qty	Eco Plan (2)	Lead finish/ Ball material (6)	MSL Peak Temp (3)	Op Temp (°C)	Device Marking (4/5)	Samples
SN65LVDS311YFFR	ACTIVE	DSBGA	YFF	49	3000	RoHS & Green	SNAGCU	Level-1-260C-UNLIM	-40 to 85	LVDS311	<b>Samples</b>
SN65LVDS311YFFT	ACTIVE	DSBGA	YFF	49	250	RoHS & Green	SNAGCU	Level-1-260C-UNLIM	-40 to 85	LVDS311	<b>Samples</b>

(1) The marketing status values are defined as follows:

**ACTIVE:** Product device recommended for new designs.

**LIFEBUY:** TI has announced that the device will be discontinued, and a lifetime-buy period is in effect.

**NRND:** Not recommended for new designs. Device is in production to support existing customers, but TI does not recommend using this part in a new design.

**PREVIEW:** Device has been announced but is not in production. Samples may or may not be available.

**OBSOLETE:** TI has discontinued the production of the device.

(2) **RoHS:** TI defines "RoHS" to mean semiconductor products that are compliant with the current EU RoHS requirements for all 10 RoHS substances, including the requirement that RoHS substance do not exceed 0.1% by weight in homogeneous materials. Where designed to be soldered at high temperatures, "RoHS" products are suitable for use in specified lead-free processes. TI may reference these types of products as "Pb-Free".

**RoHS Exempt:** TI defines "RoHS Exempt" to mean products that contain lead but are compliant with EU RoHS pursuant to a specific EU RoHS exemption.

**Green:** TI defines "Green" to mean the content of Chlorine (Cl) and Bromine (Br) based flame retardants meet JS709B low halogen requirements of <=1000ppm threshold. Antimony trioxide based flame retardants must also meet the <=1000ppm threshold requirement.

(3) MSL, Peak Temp. - The Moisture Sensitivity Level rating according to the JEDEC industry standard classifications, and peak solder temperature.

(4) There may be additional marking, which relates to the logo, the lot trace code information, or the environmental category on the device.

(5) Multiple Device Markings will be inside parentheses. Only one Device Marking contained in parentheses and separated by a "~" will appear on a device. If a line is indented then it is a continuation of the previous line and the two combined represent the entire Device Marking for that device.

(6) Lead finish/Ball material - Orderable Devices may have multiple material finish options. Finish options are separated by a vertical ruled line. Lead finish/Ball material values may wrap to two lines if the finish value exceeds the maximum column width.

**Important Information and Disclaimer:**The information provided on this page represents TI's knowledge and belief as of the date that it is provided. TI bases its knowledge and belief on information provided by third parties, and makes no representation or warranty as to the accuracy of such information. Efforts are underway to better integrate information from third parties. TI has taken and continues to take reasonable steps to provide representative and accurate information but may not have conducted destructive testing or chemical analysis on incoming materials and chemicals. TI and TI suppliers consider certain information to be proprietary, and thus CAS numbers and other limited information may not be available for release.

In no event shall TI's liability arising out of such information exceed the total purchase price of the TI part(s) at issue in this document sold by TI to Customer on an annual basis.



**TAPE AND REEL INFORMATION**

**QUADRANT ASSIGNMENTS FOR PIN 1 ORIENTATION IN TAPE**

\*All dimensions are nominal

Device	Package Type	Package Drawing	Pins	SPQ	Reel Diameter (mm)	Reel Width W1 (mm)	A0 (mm)	B0 (mm)	K0 (mm)	P1 (mm)	W (mm)	Pin1 Quadrant
SN65LVDS311YFFR	DSBGA	YFF	49	3000	180.0	8.4	2.93	2.93	0.81	4.0	8.0	Q1
SN65LVDS311YFFT	DSBGA	YFF	49	250	180.0	8.4	2.93	2.93	0.81	4.0	8.0	Q1

**TAPE AND REEL BOX DIMENSIONS**

\*All dimensions are nominal

Device	Package Type	Package Drawing	Pins	SPQ	Length (mm)	Width (mm)	Height (mm)
SN65LVDS311YFFR	DSBGA	YFF	49	3000	182.0	182.0	20.0
SN65LVDS311YFFT	DSBGA	YFF	49	250	182.0	182.0	20.0

YFF (R-XBGA-N49)

DIE-SIZE BALL GRID ARRAY

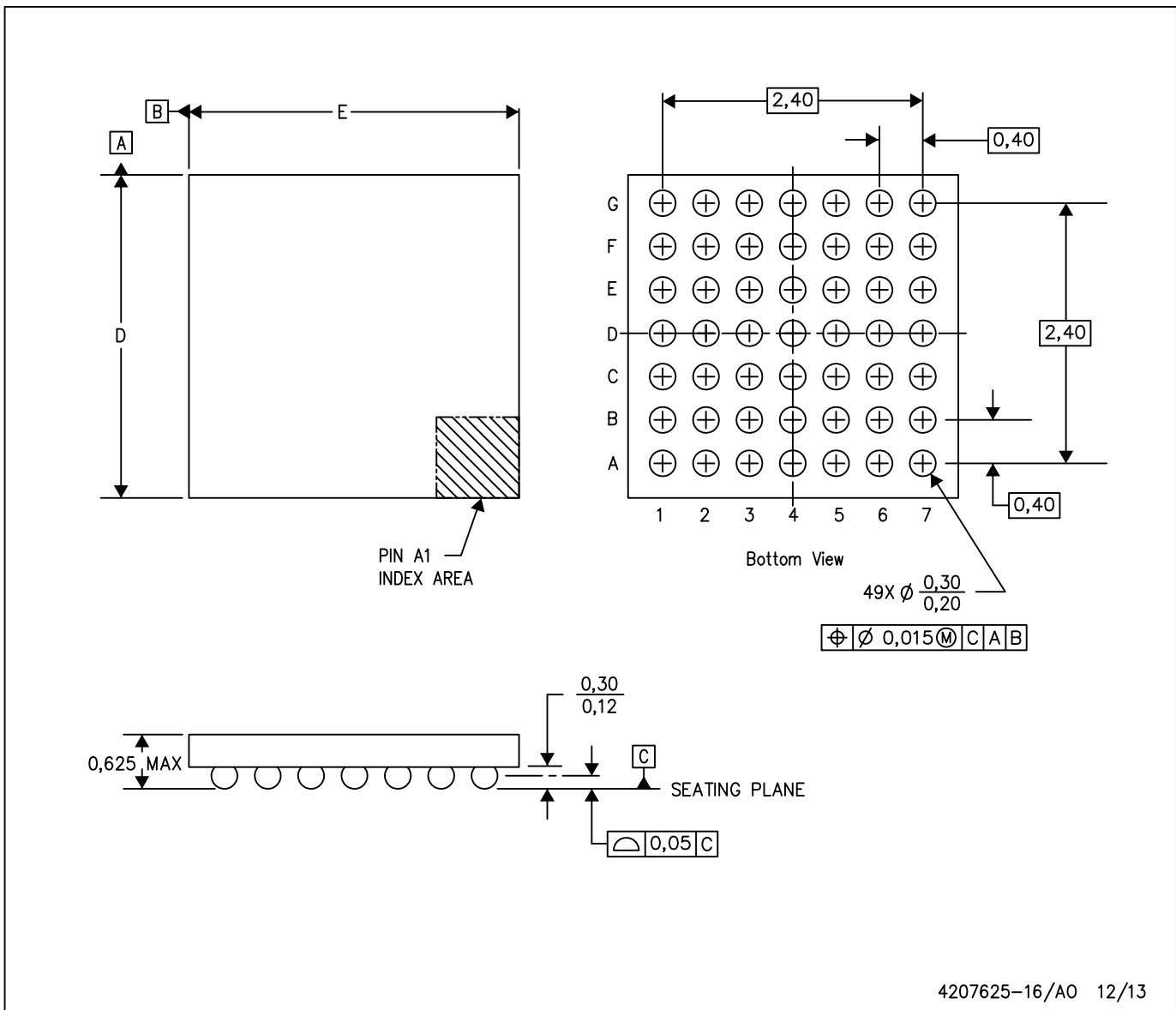

- NOTES: A. All linear dimensions are in millimeters. Dimensioning and tolerancing per ASME Y14.5M-1994.  
 B. This drawing is subject to change without notice.  
 C. NanoFree™ package configuration.

NanoFree is a trademark of Texas Instruments.



## IMPORTANT NOTICE AND DISCLAIMER

TI PROVIDES TECHNICAL AND RELIABILITY DATA (INCLUDING DATA SHEETS), DESIGN RESOURCES (INCLUDING REFERENCE DESIGNS), APPLICATION OR OTHER DESIGN ADVICE, WEB TOOLS, SAFETY INFORMATION, AND OTHER RESOURCES "AS IS" AND WITH ALL FAULTS, AND DISCLAIMS ALL WARRANTIES, EXPRESS AND IMPLIED, INCLUDING WITHOUT LIMITATION ANY IMPLIED WARRANTIES OF MERCHANTABILITY, FITNESS FOR A PARTICULAR PURPOSE OR NON-INFRINGEMENT OF THIRD PARTY INTELLECTUAL PROPERTY RIGHTS.

These resources are intended for skilled developers designing with TI products. You are solely responsible for (1) selecting the appropriate TI products for your application, (2) designing, validating and testing your application, and (3) ensuring your application meets applicable standards, and any other safety, security, regulatory or other requirements.

These resources are subject to change without notice. TI grants you permission to use these resources only for development of an application that uses the TI products described in the resource. Other reproduction and display of these resources is prohibited. No license is granted to any other TI intellectual property right or to any third party intellectual property right. TI disclaims responsibility for, and you will fully indemnify TI and its representatives against, any claims, damages, costs, losses, and liabilities arising out of your use of these resources.

TI's products are provided subject to [TI's Terms of Sale](#) or other applicable terms available either on [ti.com](https://www.ti.com) or provided in conjunction with such TI products. TI's provision of these resources does not expand or otherwise alter TI's applicable warranties or warranty disclaimers for TI products.

TI objects to and rejects any additional or different terms you may have proposed.

Mailing Address: Texas Instruments, Post Office Box 655303, Dallas, Texas 75265  
Copyright © 2024, Texas Instruments Incorporated