

TLV2211, TLV2211Y

Advanced LinCMOS™ RAIL-TO-RAIL MICROPOWER SINGLE OPERATIONAL AMPLIFIERS

SLOS156E – MAY 1996 – REVISED SEPTEMBER 2006

- Output Swing Includes Both Supply Rails
- Low Noise . . . 21 nV/√Hz Typ at f = 1 kHz
- Low Input Bias Current . . . 1 pA Typ
- Very Low Power . . . 11 μA Per Channel Typ
- Common-Mode Input Voltage Range Includes Negative Rail
- Wide Supply Voltage Range 2.7 V to 10 V
- Available in the SOT-23 Package
- Macromodel Included

description

The TLV2211 is a single low-voltage operational amplifier available in the SOT-23 package. It consumes only 11 μA (typ) of supply current and is ideal for battery-power applications. Looking at Figure 1, the TLV2211 has a 3-V noise level of 22 nV/√Hz at 1kHz; 5 times lower than competitive SOT-23 micropower solutions. The device exhibits rail-to-rail output performance for increased dynamic range in single- or split-supply applications. The TLV2211 is fully characterized at 3 V and 5 V and is optimized for low-voltage applications.

The TLV2211, exhibiting high input impedance and low noise, is excellent for small-signal conditioning for high-impedance sources, such as piezoelectric transducers. Because of the micropower dissipation levels combined with 3-V operation, these devices work well in hand-held monitoring and remote-sensing applications. In addition, the rail-to-rail output feature with single or split supplies makes this family a great choice when interfacing with analog-to-digital converters (ADCs).

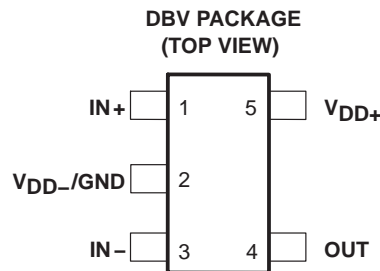

EQUIVALENT INPUT NOISE VOLTAGE†
VS
FREQUENCY

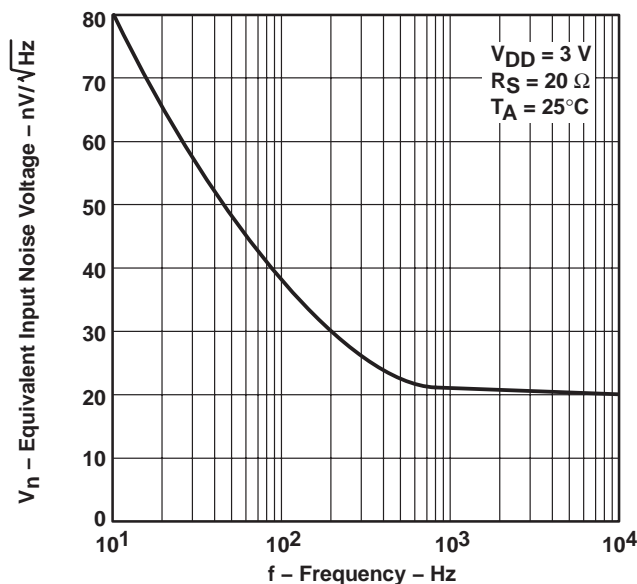

† All loads are referenced to 1.5 V.

Figure 1. Equivalent Input Noise Voltage Versus Frequency

AVAILABLE OPTIONS

T _A	V _{IOMax} AT 25°C	PACKAGED DEVICES	SYMBOL	CHIP FORM‡ (Y)
		SOT-23 (DBV)†		
0°C to 70°C	3 mV	TLV2211CDBV	VACC	TLV2211Y
-40°C to 85°C	3 mV	TLV2211IDBV	VACI	

† The DBV package available in tape and reel only.

‡ Chip forms are tested at T_A = 25°C only.



Please be aware that an important notice concerning availability, standard warranty, and use in critical applications of Texas Instruments semiconductor products and disclaimers thereto appears at the end of this data sheet.

Advanced LinCMOS is a trademark of Texas Instruments.

PRODUCTION DATA information is current as of publication date. Products conform to specifications per the terms of Texas Instruments standard warranty. Production processing does not necessarily include testing of all parameters.



POST OFFICE BOX 655303 • DALLAS, TEXAS 75265

Copyright © 2001–2006, Texas Instruments Incorporated

TLV2211, TLV2211Y

Advanced LinCMOS™ RAIL-TO-RAIL

MICROPOWER SINGLE OPERATIONAL AMPLIFIERS

SLOS156E – MAY 1996 – REVISED SEPTEMBER 2006

description (continued)

With a total area of 5.6mm², the SOT-23 package only requires one-third the board space of the standard 8-pin SOIC package. This ultra-small package allows designers to place single amplifiers very close to the signal source, minimizing noise pick-up from long PCB traces. TI has also taken special care to provide a pinout that is optimized for board layout (see Figure 2). Both inputs are separated by GND to prevent coupling or leakage paths. The OUT and IN– terminals are on the same end of the board to provide negative feedback. Finally, gain setting resistors and decoupling capacitor are easily placed around the package.

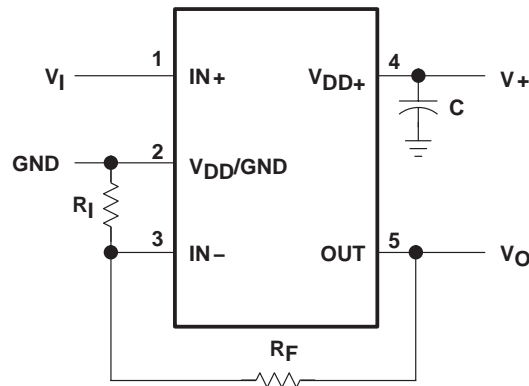
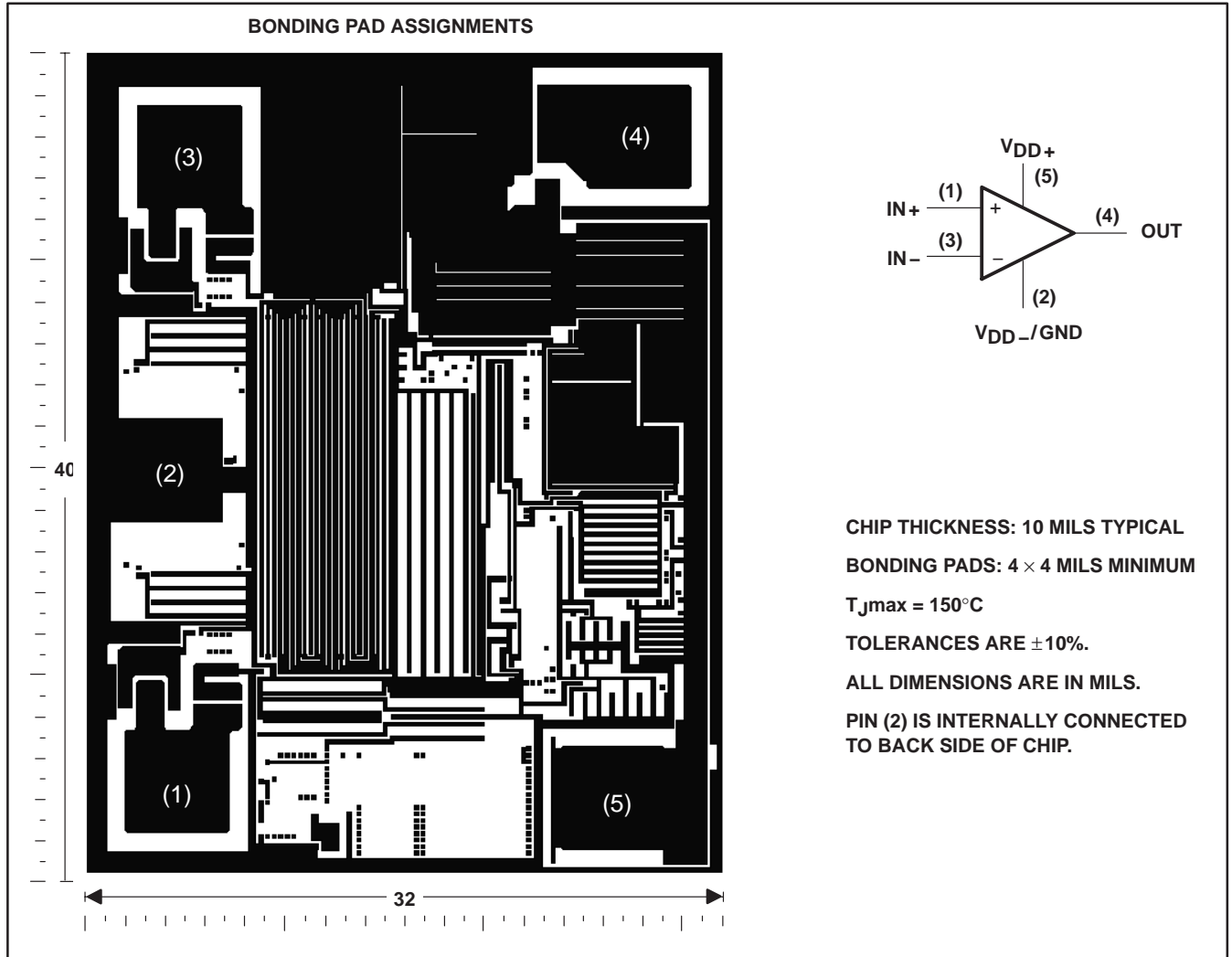

Figure 2. Typical Surface Mount Layout for a Fixed-Gain Noninverting Amplifier

TLV2211Y chip information

This chip, when properly assembled, displays characteristics similar to the TLV2211C. Thermal compression or ultrasonic bonding may be used on the doped-aluminum bonding pads. This chip may be mounted with conductive epoxy or a gold-silicon preform.



TLV2211, TLV2211Y
Advanced LinCMOS™ RAIL-TO-RAIL
MICROPOWER SINGLE OPERATIONAL AMPLIFIERS

SLOS156E – MAY 1996 – REVISED SEPTEMBER 2006

equivalent schematic

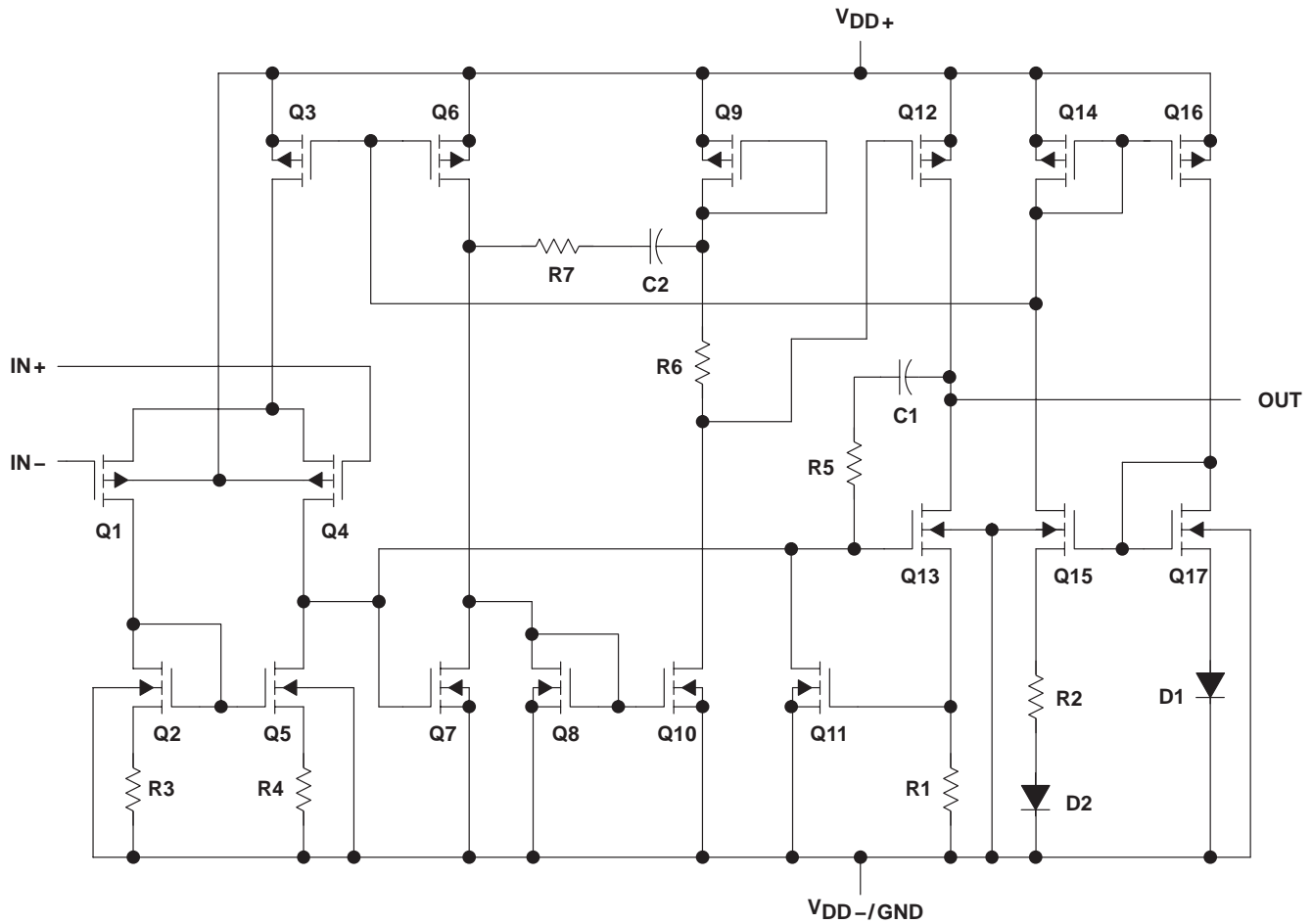

COMPONENT COUNT†	
Transistors	23
Diodes	6
Resistors	11
Capacitors	2

† Includes both amplifiers and all ESD, bias, and trim circuitry

TLV2211, TLV2211Y
Advanced LinCMOS™ RAIL-TO-RAIL
MICROPOWER SINGLE OPERATIONAL AMPLIFIERS

SLOS156E – MAY 1996 – REVISED SEPTEMBER 2006

absolute maximum ratings over operating free-air temperature range (unless otherwise noted)†

Supply voltage, V_{DD} (see Note 1)	12 V
Differential input voltage, V_{ID} (see Note 2)	$\pm V_{DD}$
Input voltage range, V_I (any input, see Note 1)	-0.3 V to V_{DD}
Input current, I_I (each input)	± 5 mA
Output current, I_O	± 50 mA
Total current into V_{DD+}	± 50 mA
Total current out of V_{DD-}	± 50 mA
Duration of short-circuit current (at or below) 25°C (see Note 3)	unlimited
Continuous total power dissipation	See Dissipation Rating Table
Operating free-air temperature range, T_A : TLV2211C	0°C to 70°C
TLV2211I	-40°C to 85°C
Storage temperature range, T_{stg}	-65°C to 150°C
Lead temperature 1,6 mm (1/16 inch) from case for 10 seconds: DBV package	260°C

† Stresses beyond those listed under “absolute maximum ratings” may cause permanent damage to the device. These are stress ratings only, and functional operation of the device at these or any other conditions beyond those indicated under “recommended operating conditions” is not implied. Exposure to absolute-maximum-rated conditions for extended periods may affect device reliability.

- NOTES:
1. All voltage values, except differential voltages, are with respect to V_{DD-} .
 2. Differential voltages are at the noninverting input with respect to the inverting input. Excessive current flows when input is brought below $V_{DD-} - 0.3$ V.
 3. The output may be shorted to either supply. Temperature and/or supply voltages must be limited to ensure that the maximum dissipation rating is not exceeded.

DISSIPATION RATING TABLE

PACKAGE	$T_A \leq 25^\circ\text{C}$ POWER RATING	DERATING FACTOR ABOVE $T_A = 25^\circ\text{C}$	$T_A = 70^\circ\text{C}$ POWER RATING	$T_A = 85^\circ\text{C}$ POWER RATING
DBV	150 mW	1.2 mW/°C	96 mW	78 mW

recommended operating conditions

	TLV2211C		TLV2211I		UNIT
	MIN	MAX	MIN	MAX	
Supply voltage, V_{DD} (see Note 1)	2.7	10	2.7	10	V
Input voltage range, V_I	V_{DD-}	$V_{DD+} - 1.3$	V_{DD-}	$V_{DD+} - 1.3$	V
Common-mode input voltage, V_{IC}	V_{DD-}	$V_{DD+} - 1.3$	V_{DD-}	$V_{DD+} - 1.3$	V
Operating free-air temperature, T_A	0	70	-40	85	°C

NOTE 1: All voltage values, except differential voltages, are with respect to V_{DD-} .



TLV2211, TLV2211Y

Advanced LinCMOS™ RAIL-TO-RAIL

MICROPOWER SINGLE OPERATIONAL AMPLIFIERS

SLOS156E – MAY 1996 – REVISED SEPTEMBER 2006

electrical characteristics at specified free-air temperature, $V_{DD} = 3\text{ V}$ (unless otherwise noted)

PARAMETER	TEST CONDITIONS	T_A †	TLV2211C			TLV2211I			UNIT		
			MIN	TYP	MAX	MIN	TYP	MAX			
V_{IO} Input offset voltage	$V_{DD\pm} = \pm 1.5\text{ V}$, $V_O = 0$, $V_{IC} = 0$, $R_S = 50\ \Omega$	Full range	0.47		3	0.47		3	mV		
α_{VIO} Temperature coefficient of input offset voltage			1		1		$\mu\text{V}/^\circ\text{C}$				
Input offset voltage long-term drift (see Note 4)			25°C		0.003		0.003		$\mu\text{V}/\text{mo}$		
I_{IO} Input offset current			Full range		0.5		60	0.5		60	pA
I_{IB} Input bias current			Full range		1		60	1		60	pA
V_{ICR} Common-mode input voltage range	$ V_{IO} \leq 5\text{ mV}$, $R_S = 50\ \Omega$	25°C	0 to 2	-0.3 to 2.2		0 to 2	-0.3 to 2.2		V		
		Full range	0 to 1.7		0 to 1.7						
V_{OH} High-level output voltage	$I_{OH} = -100\ \mu\text{A}$ $I_{OH} = -250\ \mu\text{A}$	25°C	2.94		2.94				V		
		25°C	2.85		2.85						
		Full range	2.5		2.5						
V_{OL} Low-level output voltage	$V_{IC} = 1.5\text{ V}$, $I_{OL} = 50\ \mu\text{A}$ $V_{IC} = 1.5\text{ V}$, $I_{OL} = 500\ \mu\text{A}$	25°C	15		15				mV		
		25°C	150		150						
		Full range	500		500						
A_{VD} Large-signal differential voltage amplification	$V_{IC} = 1.5\text{ V}$, $V_O = 1\text{ V to } 2\text{ V}$	25°C	3	7	3	7			V/mV		
							Full range	1		1	
		25°C	600		600						
$r_{i(d)}$ Differential input resistance		25°C	10^{12}		10^{12}				Ω		
$r_{i(c)}$ Common-mode input resistance		25°C	10^{12}		10^{12}				Ω		
$C_{i(c)}$ Common-mode input capacitance	$f = 10\text{ kHz}$	25°C	5		5				pF		
z_o Closed-loop output impedance	$f = 7\text{ kHz}$, $A_V = 1$	25°C	200		200				Ω		
CMRR Common-mode rejection ratio	$V_{IC} = 0\text{ to } 1.7\text{ V}$, $R_S = 50\ \Omega$, $V_O = 1.5\text{ V}$	25°C	65	83	65	83			dB		
		Full range	60		60						
k_{SVR} Supply voltage rejection ratio ($\Delta V_{DD} / \Delta V_{IO}$)	$V_{DD} = 2.7\text{ V to } 8\text{ V}$, No load, $V_{IC} = V_{DD}/2$	25°C	80	95	80	95			dB		
		Full range	80		80						
I_{DD} Supply current	$V_O = 1.5\text{ V}$, No load	25°C	11	25	11	25			μA		
		Full range	30		30						

† Full range for the TLV2211C is 0°C to 70°C. Full range for the TLV2211I is -40°C to 85°C.

‡ Referenced to 1.5 V

NOTE 4: Typical values are based on the input offset voltage shift observed through 500 hours of operating life test at $T_A = 150^\circ\text{C}$ extrapolated to $T_A = 25^\circ\text{C}$ using the Arrhenius equation and assuming an activation energy of 0.96 eV.



TLV2211, TLV2211Y
Advanced LinCMOS™ RAIL-TO-RAIL
MICROPOWER SINGLE OPERATIONAL AMPLIFIERS

SLOS156E – MAY 1996 – REVISED SEPTEMBER 2006

operating characteristics at specified free-air temperature, $V_{DD} = 3\text{ V}$ (unless otherwise noted)

PARAMETER	TEST CONDITIONS	T_A †	TLV2211C			TLV2211I			UNIT	
			MIN	TYP	MAX	MIN	TYP	MAX		
SR	Slew rate at unity gain $V_O = 1.1\text{ V to }1.9\text{ V}, R_L = 10\text{ k}\Omega^\ddagger,$ $C_L = 100\text{ pF}^\ddagger$	25°C	0.01	0.025		0.01	0.025		V/ μ s	
		Full range	0.005			0.005				
V_n	Equivalent input noise voltage	f = 10 Hz	80			80			nV/ $\sqrt{\text{Hz}}$	
		f = 1 kHz	22			22				
$V_{N(PP)}$	Peak-to-peak equivalent input noise voltage	f = 0.1 Hz to 1 Hz	660			660			nV	
		f = 0.1 Hz to 10 Hz	880			880				
I_n	Equivalent input noise current	25°C	0.6			0.6			fA/ $\sqrt{\text{Hz}}$	
	Gain-bandwidth product	f = 10 kHz, $C_L = 100\text{ pF}^\ddagger$	$R_L = 10\text{ k}\Omega^\ddagger,$	25°C			56			kHz
BOM	Maximum output-swing bandwidth	$V_{O(PP)} = 1\text{ V},$ $R_L = 10\text{ k}\Omega^\ddagger,$	$A_V = 1,$ $C_L = 100\text{ pF}^\ddagger$	25°C			7			kHz
ϕ_m	Phase margin at unity gain	$R_L = 10\text{ k}\Omega^\ddagger,$	$C_L = 100\text{ pF}^\ddagger$	25°C			56°			
				25°C			20			20
	Gain margin	25°C			20			20	dB	

† Full range is -40°C to 85°C .

‡ Referenced to 1.5 V

TLV2211, TLV2211Y

Advanced LinCMOS™ RAIL-TO-RAIL

MICROPOWER SINGLE OPERATIONAL AMPLIFIERS

SLOS156E – MAY 1996 – REVISED SEPTEMBER 2006

electrical characteristics at specified free-air temperature, $V_{DD} = 5\text{ V}$ (unless otherwise noted)

PARAMETER	TEST CONDITIONS	T_A †	TLV2211C			TLV2211I			UNIT
			MIN	TYP	MAX	MIN	TYP	MAX	
V_{IO} Input offset voltage	$V_{DD\pm} = \pm 2.5\text{ V}$, $V_O = 0$, $V_{IC} = 0$, $R_S = 50\ \Omega$	Full range	0.45 3			0.45 3			mV
$\alpha_{V_{IO}}$ Temperature coefficient of input offset voltage			0.5			0.5			$\mu\text{V}/^\circ\text{C}$
Input offset voltage long-term drift (see Note 5)		25°C	0.003			0.003			$\mu\text{V}/\text{mo}$
I_{IO} Input offset current		25°C	0.5 60			0.5 60			pA
		Full range	150			150			
I_{IB} Input bias current		25°C	1 60			1 60			pA
	Full range	150			150				
V_{ICR} Common-mode input voltage range	$ V_{IO} \leq 5\text{ mV}$ $R_S = 50\ \Omega$	25°C	0 to 4 –0.3 to 4.2		0 to 4 –0.3 to 4.2		V		
		Full range	0 to 3.5		0 to 3.5				
V_{OH} High-level output voltage	$I_{OH} = -100\ \mu\text{A}$ $I_{OH} = -250\ \mu\text{A}$	25°C	4.95			4.95			V
		25°C	4.875			4.875			
		Full range	4.5			4.5			
V_{OL} Low-level output voltage	$V_{IC} = 2.5\text{ V}$, $I_{OL} = 50\ \mu\text{A}$ $V_{IC} = 2.5\text{ V}$, $I_{OL} = 500\ \mu\text{A}$	25°C	12			12			mV
		25°C	120			120			
		Full range	500			500			
A_{VD} Large-signal differential voltage amplification	$V_{IC} = 2.5\text{ V}$, $V_O = 1\text{ V to }4\text{ V}$	25°C	$R_L = 10\text{ k}\Omega$ ‡		6 12		6 12		V/mV
			Full range		3		3		
		25°C	$R_L = 1\text{ M}\Omega$ ‡		800		800		
$r_{i(d)}$ Differential input resistance		25°C	10 ¹²			10 ¹²			Ω
$r_{i(c)}$ Common-mode input resistance		25°C	10 ¹²			10 ¹²			Ω
$C_{i(c)}$ Common-mode input capacitance	$f = 10\text{ kHz}$,	25°C	5			5			pF
z_o Closed-loop output impedance	$f = 7\text{ kHz}$, $A_V = 1$	25°C	200			200			Ω
CMRR Common-mode rejection ratio	$V_{IC} = 0\text{ to }2.7\text{ V}$, $R_S = 50\ \Omega$, $V_O = 2.5\text{ V}$	25°C	70 83			70 83			dB
		Full range	70			70			
k_{SVR} Supply voltage rejection ratio ($\Delta V_{DD} / \Delta V_{IO}$)	$V_{DD} = 4.4\text{ V to }8\text{ V}$, No load, $V_{IC} = V_{DD}/2$	25°C	80 95			80 95			dB
		Full range	80			80			
I_{DD} Supply current	$V_O = 2.5\text{ V}$, No load	25°C	13 25			13 25			μA
		Full range	30			30			

† Full range for the TLV2211C is 0°C to 70°C. Full range for the TLV2211I is –40°C to 85°C.

‡ Referenced to 1.5 V

NOTE 5: Typical values are based on the input offset voltage shift observed through 500 hours of operating life test at $T_A = 150^\circ\text{C}$ extrapolated to $T_A = 25^\circ\text{C}$ using the Arrhenius equation and assuming an activation energy of 0.96 eV.



TLV2211, TLV2211Y
Advanced LinCMOS™ RAIL-TO-RAIL
MICROPOWER SINGLE OPERATIONAL AMPLIFIERS

SLOS156E – MAY 1996 – REVISED SEPTEMBER 2006

operating characteristics at specified free-air temperature, $V_{DD} = 5\text{ V}$ (unless otherwise noted)

PARAMETER	TEST CONDITIONS	T_A †	TLV2211C			TLV2211I			UNIT
			MIN	TYP	MAX	MIN	TYP	MAX	
SR	Slew rate at unity gain $V_O = 1.5\text{ V to }3.5\text{ V}, R_L = 10\text{ k}\Omega^\ddagger, C_L = 100\text{ pF}^\ddagger$	25°C	0.01	0.025		0.01	0.025		V/ μs
		Full range	0.005			0.005			
V_n	Equivalent input noise voltage	f = 10 Hz	72			72			nV/ $\sqrt{\text{Hz}}$
		f = 1 kHz	21			21			
$V_{N(PP)}$	Peak-to-peak equivalent input noise voltage	f = 0.1 Hz to 1 Hz	600			600			nV
		f = 0.1 Hz to 10 Hz	800			800			
I_n	Equivalent input noise current	25°C	0.6			0.6			fA/ $\sqrt{\text{Hz}}$
	Gain-bandwidth product	f = 10 kHz, $R_L = 10\text{ k}\Omega^\ddagger, C_L = 100\text{ pF}^\ddagger$	65			65			kHz
BOM	Maximum output-swing bandwidth	$V_{O(PP)} = 2\text{ V}, R_L = 10\text{ k}\Omega^\ddagger, A_V = 1, C_L = 100\text{ pF}^\ddagger$	7			7			kHz
ϕ_m	Phase margin at unity gain	$R_L = 10\text{ k}\Omega^\ddagger, C_L = 100\text{ pF}^\ddagger$	56°			56°			
			22			22			
	Gain margin	25°C	22			22			dB

† Full range is -40°C to 85°C .

‡ Referenced to 1.5 V

electrical characteristics at $V_{DD} = 3\text{ V}, T_A = 25^\circ\text{C}$ (unless otherwise noted)

PARAMETER	TEST CONDITIONS	TLV2211Y			UNIT
		MIN	TYP	MAX	
V_{IO}	Input offset voltage	0.47			mV
I_{IO}	Input offset current	0.5			pA
I_{IB}	Input bias current	1			
V_{ICR}	Common-mode input voltage range	-0.3 to 2.2			V
V_{OH}	High-level output voltage	$I_{OH} = -100\text{ }\mu\text{A}$			V
		$I_{OH} = -200\text{ }\mu\text{A}$			
V_{OL}	Low-level output voltage	$V_{IC} = 0, I_{OL} = 50\text{ }\mu\text{A}$			mV
		$V_{IC} = 0, I_{OL} = 500\text{ }\mu\text{A}$			
A_{VD}	Large-signal differential voltage amplification	$V_{IC} = 1.5\text{ V}, V_O = 1\text{ V to }2\text{ V}$	$R_L = 10\text{ k}\Omega^\ddagger$		V/mV
			$R_L = 1\text{ M}\Omega^\ddagger$		
$r_{i(d)}$	Differential input resistance	10^{12}			Ω
$r_{i(c)}$	Common-mode input resistance	10^{12}			Ω
$c_{i(c)}$	Common-mode input capacitance	f = 10 kHz			pF
z_o	Closed-loop output impedance	f = 7 kHz, $A_V = 1$			Ω
CMRR	Common-mode rejection ratio	$V_{IC} = 0\text{ to }1.7\text{ V}, V_O = 1.5\text{ V}, R_S = 50\text{ }\Omega$			dB
k_{SVR}	Supply voltage rejection ratio ($\Delta V_{DD}/\Delta V_{IO}$)	$V_{DD} = 2.7\text{ V to }8\text{ V}, V_{IC} = V_{DD}/2, \text{ No load}$			dB
I_{DD}	Supply current	$V_O = 1.5\text{ V}, \text{ No load}$			μA

† Referenced to 1.5 V



TLV2211, TLV2211Y
Advanced LinCMOS™ RAIL-TO-RAIL
MICROPOWER SINGLE OPERATIONAL AMPLIFIERS

SLOS156E – MAY 1996 – REVISED SEPTEMBER 2006

electrical characteristics at $V_{DD} = 5\text{ V}$, $T_A = 25^\circ\text{C}$ (unless otherwise noted)

PARAMETER	TEST CONDITIONS	TLV2211Y			UNIT
		MIN	TYP	MAX	
V_{IO} Input offset voltage	$V_{DD} \pm \pm 2.5\text{ V}$, $R_S = 50\ \Omega$ $V_{IC} = 0$, $V_O = 0$,	0.45			mV
I_{IO} Input offset current		0.5	60		pA
I_{IB} Input bias current		1	60		pA
V_{ICR} Common-mode input voltage range	$ V_{IO} \leq 5\text{ mV}$, $R_S = 50\ \Omega$	-0.3 to 4.2			V
V_{OH} High-level output voltage	$I_{OH} = -100\ \mu\text{A}$	4.95			V
	$I_{OH} = -250\ \mu\text{A}$	4.875			
V_{OL} Low-level output voltage	$V_{IC} = 2.5\text{ V}$, $I_{OL} = 50\ \mu\text{A}$	12			mV
	$V_{IC} = 2.5\text{ V}$, $I_{OL} = 500\ \mu\text{A}$	120			
A_{VD} Large-signal differential voltage amplification	$V_{IC} = 2.5\text{ V}$, $V_O = 1\text{ V to }4\text{ V}$	$R_L = 10\text{ k}\Omega^\dagger$	12		V/mV
		$R_L = 1\text{ M}\Omega^\dagger$	800		
$r_{i(d)}$ Differential input resistance		10^{12}			Ω
$r_{i(c)}$ Common-mode input resistance		10^{12}			Ω
$c_{i(c)}$ Common-mode input capacitance	$f = 10\text{ kHz}$	5			pF
z_o Closed-loop output impedance	$f = 7\text{ kHz}$, $A_V = 1$	200			Ω
CMRR Common-mode rejection ratio	$V_{IC} = 0\text{ to }2.7\text{ V}$, $V_O = 2.5\text{ V}$, $R_S = 50\ \Omega$	83			dB
k_{SVR} Supply voltage rejection ratio ($\Delta V_{DD}/\Delta V_{IO}$)	$V_{DD} = 4.4\text{ V to }8\text{ V}$, $V_{IC} = V_{DD}/2$, No load	95			dB
I_{DD} Supply current	$V_O = 2.5\text{ V}$, No load	13			μA

† Referenced to 1.5 V

TYPICAL CHARACTERISTICS

Table of Graphs

		FIGURE
V_{IO}	Input offset voltage	Distribution vs Common-mode input voltage
		3, 4 5, 6
α_{VIO}	Input offset voltage temperature coefficient	Distribution
		7, 8
I_{IB}/I_{IO}	Input bias and input offset currents	vs Free-air temperature
		9
V_I	Input voltage	vs Supply voltage vs Free-air temperature
		10 11
V_{OH}	High-level output voltage	vs High-level output current
		12, 15
V_{OL}	Low-level output voltage	vs Low-level output current
		13, 14, 16
$V_{O(PP)}$	Maximum peak-to-peak output voltage	vs Frequency
		17
I_{OS}	Short-circuit output current	vs Supply voltage vs Free-air temperature
		18 19
V_O	Output voltage	vs Differential input voltage
		20, 21
A_{VD}	Differential voltage amplification	vs Load resistance vs Frequency vs Free-air temperature
		22 23, 24 25, 26
z_o	Output impedance	vs Frequency
		27, 28
CMRR	Common-mode rejection ratio	vs Frequency vs Free-air temperature
		29 30
k_{SVR}	Supply-voltage rejection ratio	vs Frequency vs Free-air temperature
		31, 32 33
I_{DD}	Supply current	vs Supply voltage
		34
SR	Slew rate	vs Load capacitance vs Free-air temperature
		35 36
V_O	Large-signal pulse response	vs Time
		37, 38, 39, 40
V_O	Small-signal pulse response	vs Time
		41, 42, 43, 44
V_n	Equivalent input noise voltage	vs Frequency
		45, 46
	Noise voltage (referred to input)	Over a 10-second period
		47
THD + N	Total harmonic distortion plus noise	vs Frequency
		48
	Gain-bandwidth product	vs Free-air temperature vs Supply voltage
		49 50
ϕ_m	Phase margin	vs Frequency vs Load capacitance
		23, 24 51
	Gain margin	vs Load capacitance
		52
B_1	Unity-gain bandwidth	vs Load capacitance
		53

TYPICAL CHARACTERISTICS

**DISTRIBUTION OF TLV2211
 INPUT OFFSET VOLTAGE**

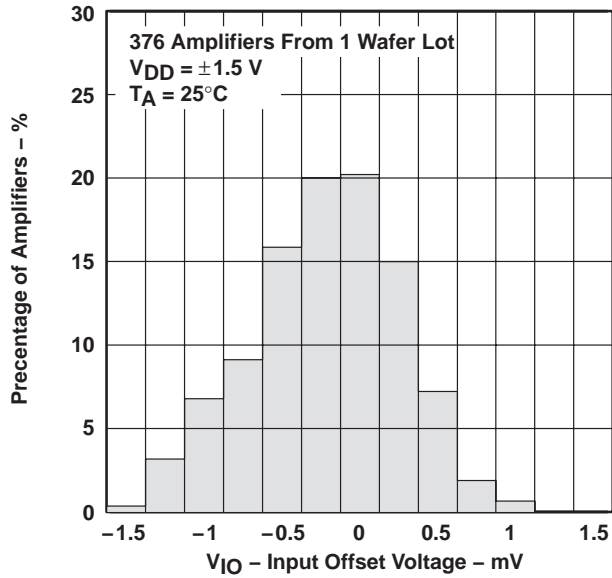

Figure 3

**DISTRIBUTION OF TLV2211
 INPUT OFFSET VOLTAGE**

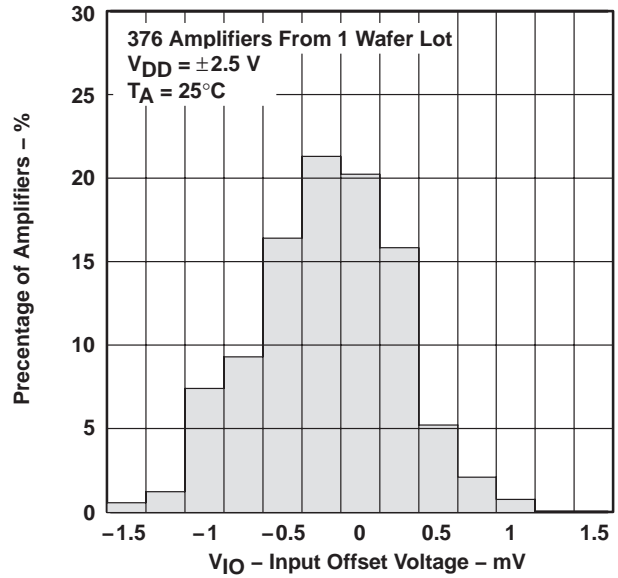

Figure 4

**INPUT OFFSET VOLTAGE†
 vs
 COMMON-MODE INPUT VOLTAGE**

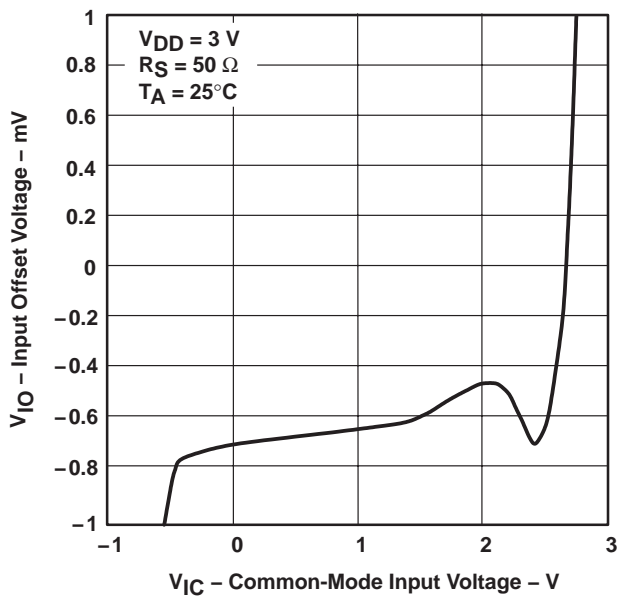

Figure 5

**INPUT OFFSET VOLTAGE†
 vs
 COMMON-MODE INPUT VOLTAGE**

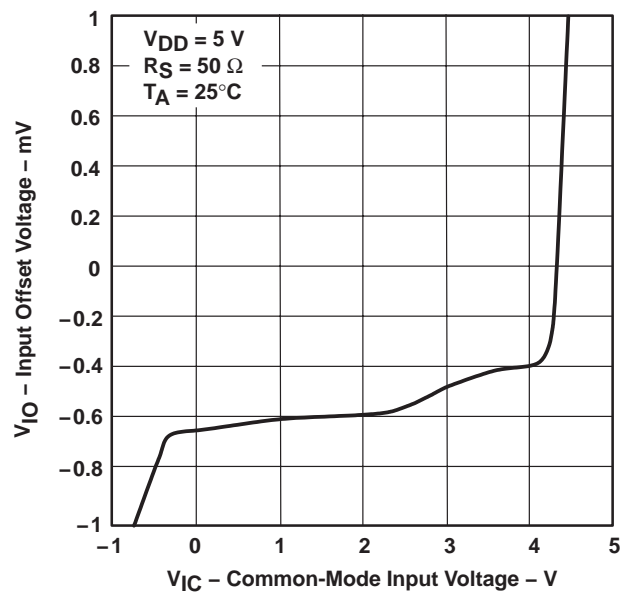

Figure 6

† For all curves where $V_{DD} = 5\text{ V}$, all loads are referenced to 2.5 V. For all curves where $V_{DD} = 3\text{ V}$, all loads are referenced to 1.5 V.

TYPICAL CHARACTERISTICS

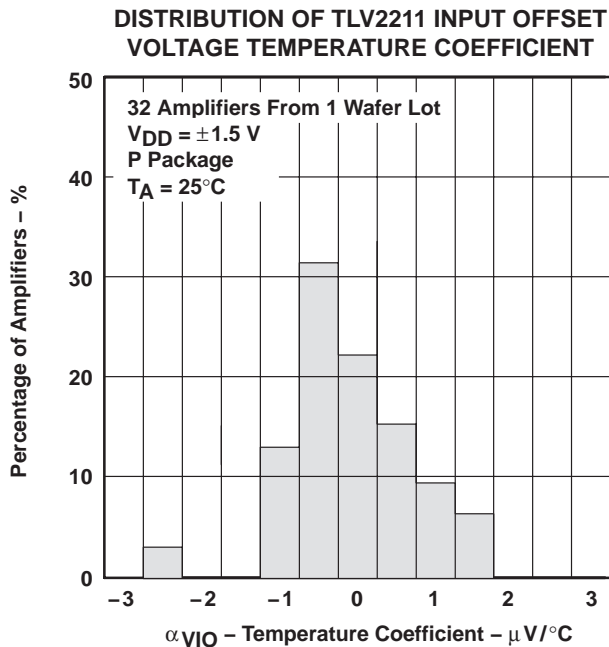

Figure 7

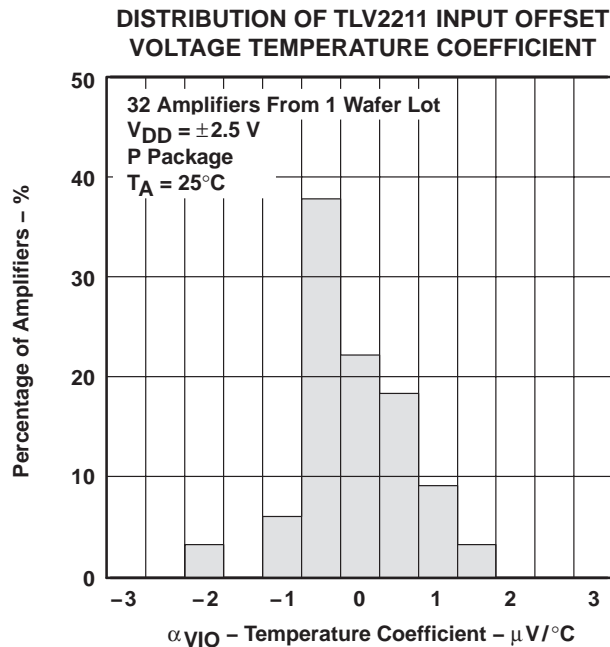

Figure 8

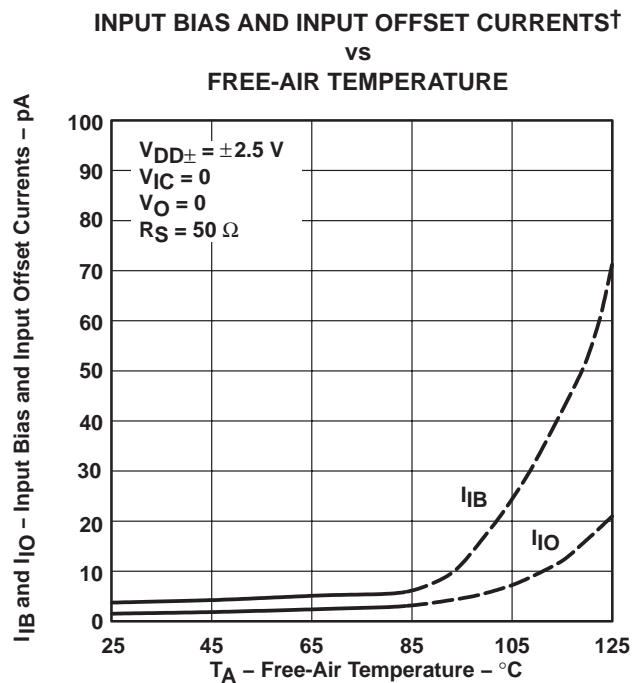

Figure 9

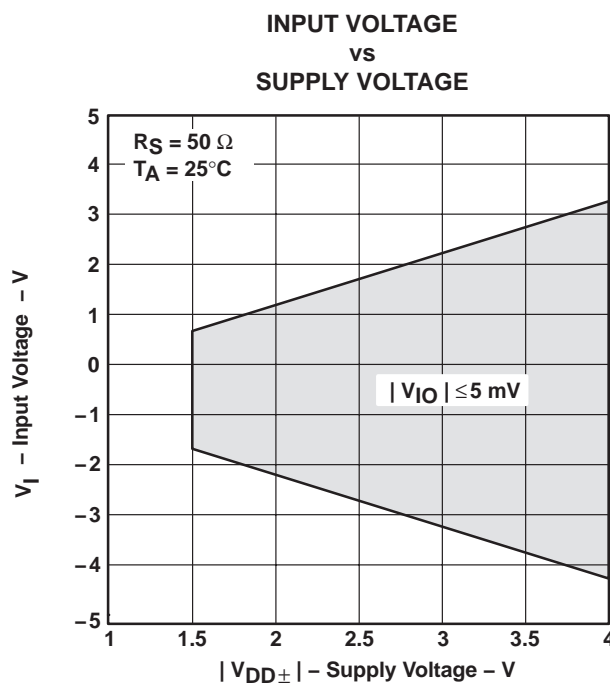

Figure 10

† Data at high and low temperatures are applicable only within the rated operating free-air temperature ranges of the various devices.

TYPICAL CHARACTERISTICS

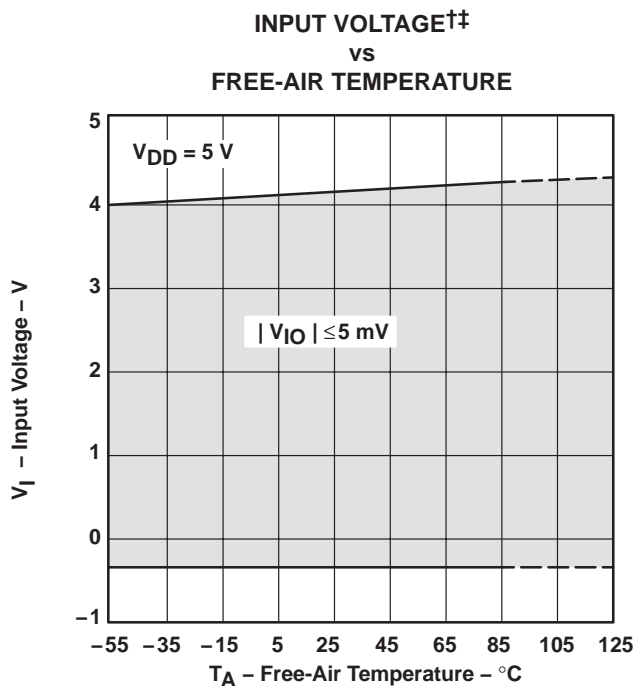

Figure 11

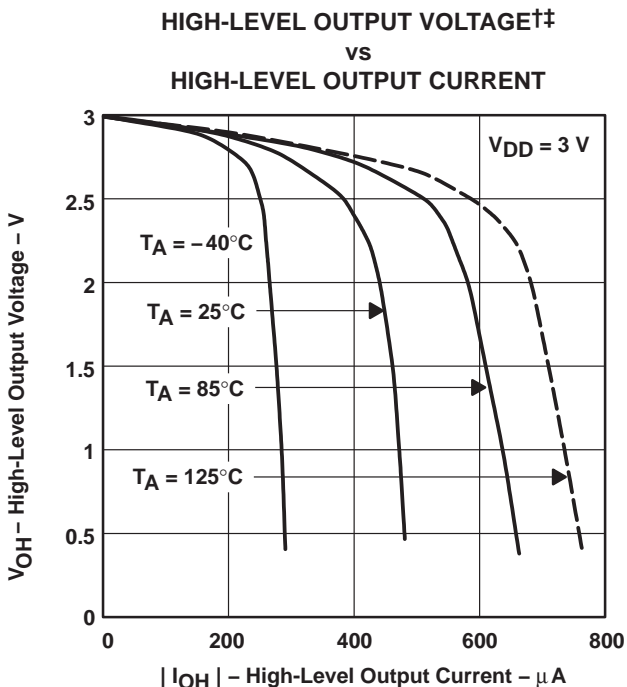

Figure 12

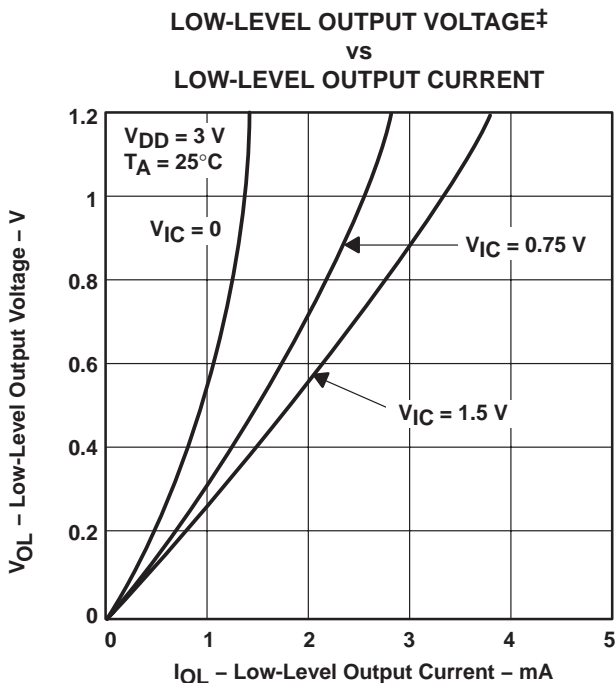

Figure 13

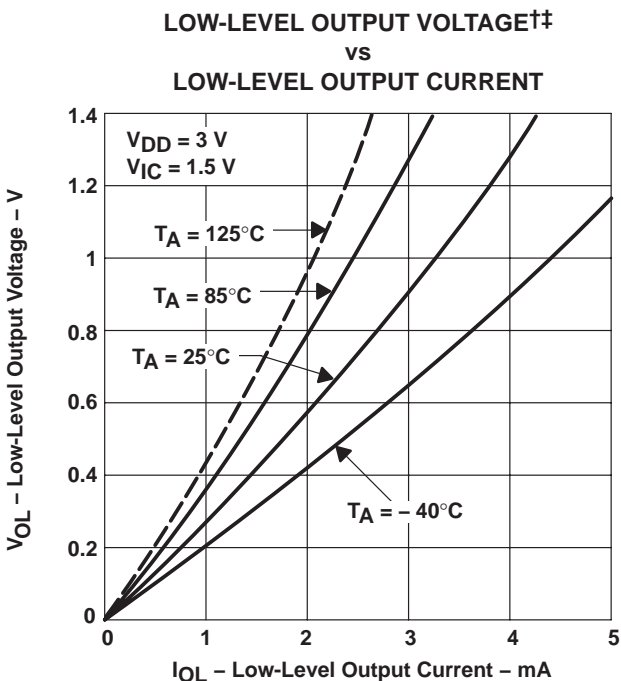

Figure 14

† Data at high and low temperatures are applicable only within the rated operating free-air temperature ranges of the various devices.
 ‡ For all curves where $V_{DD} = 5\text{ V}$, all loads are referenced to 2.5 V. For all curves where $V_{DD} = 3\text{ V}$, all loads are referenced to 1.5 V.

TYPICAL CHARACTERISTICS

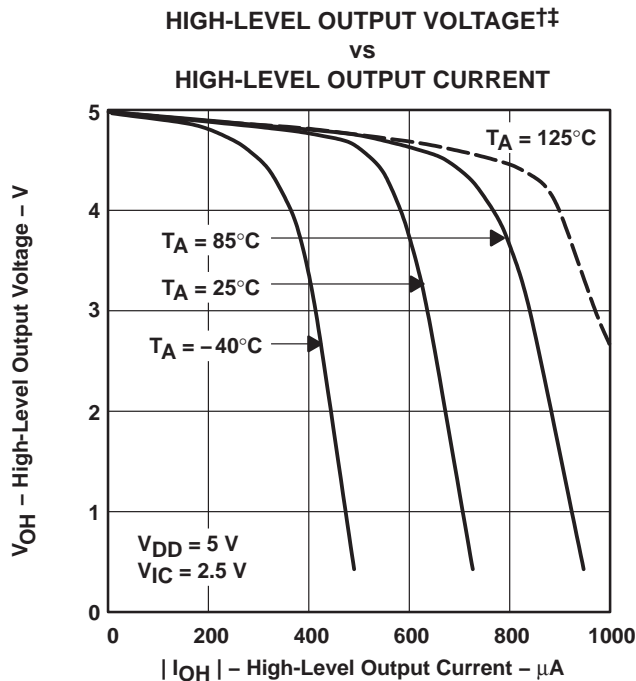

Figure 15

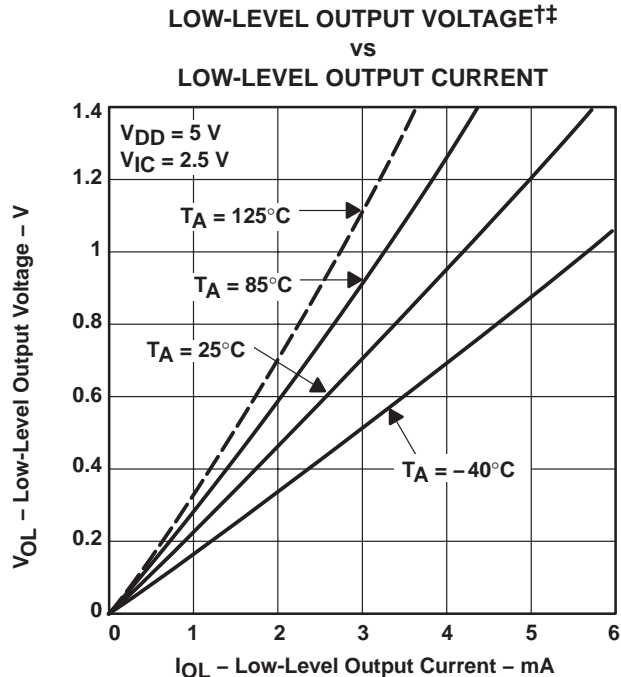

Figure 16

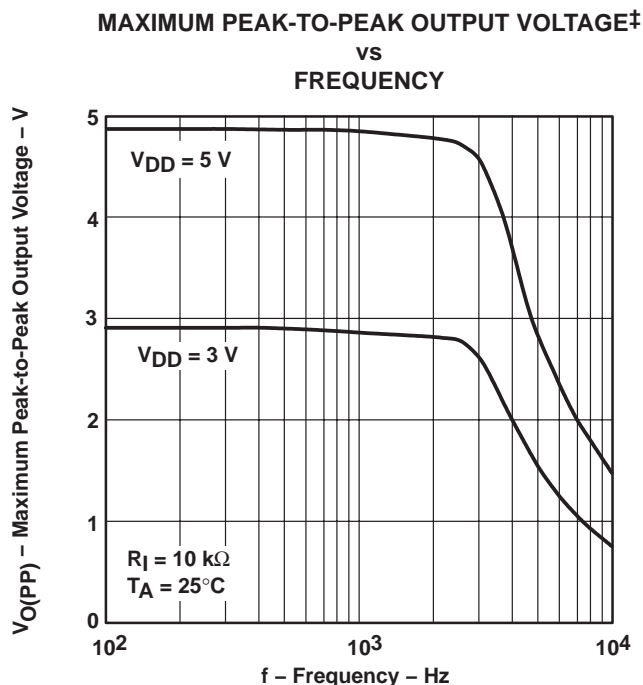

Figure 17

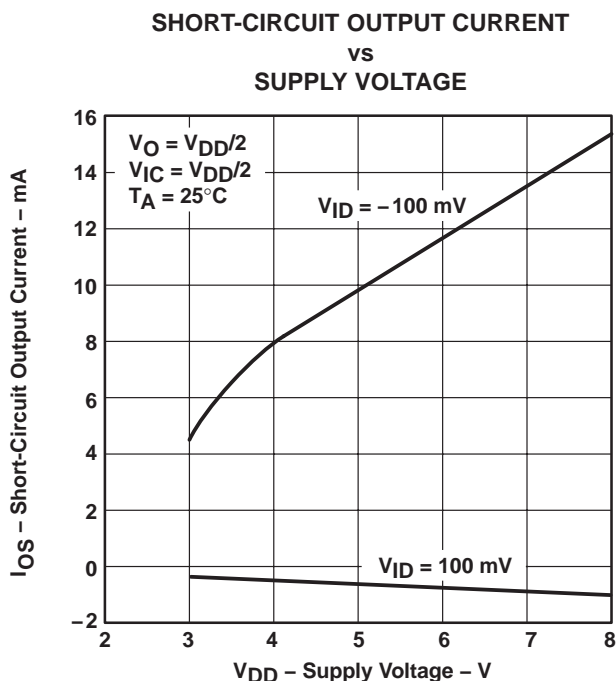
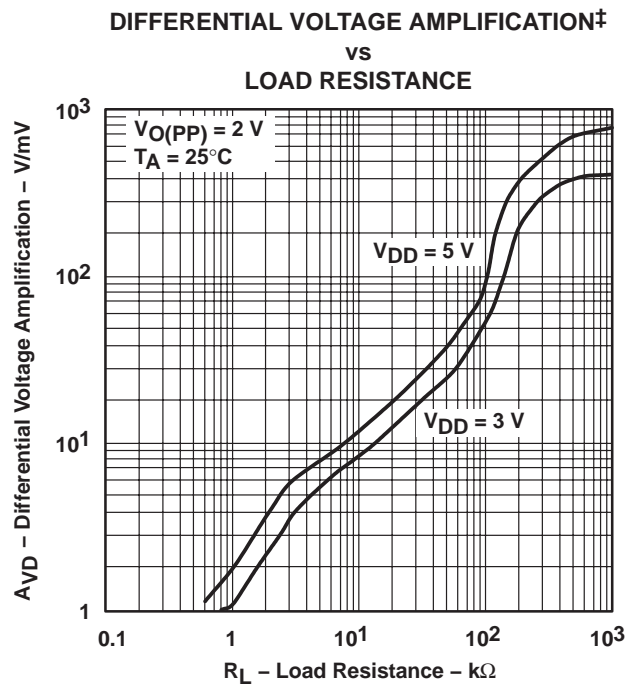
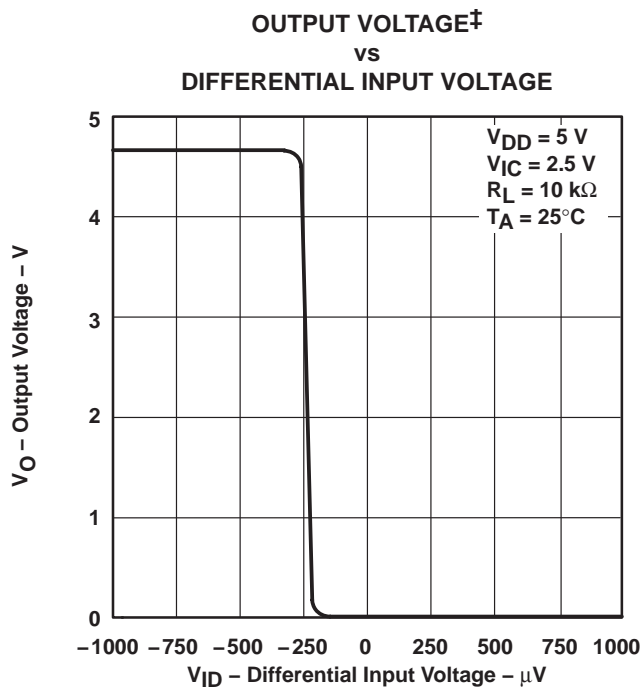
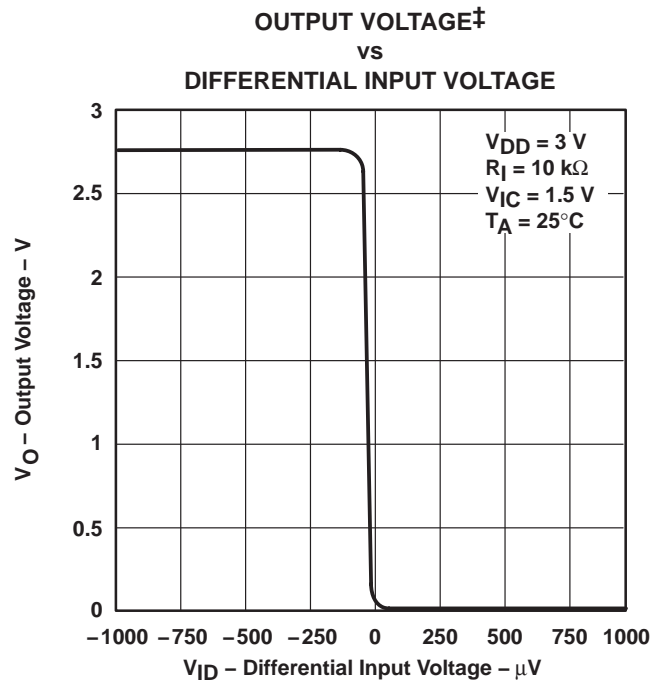
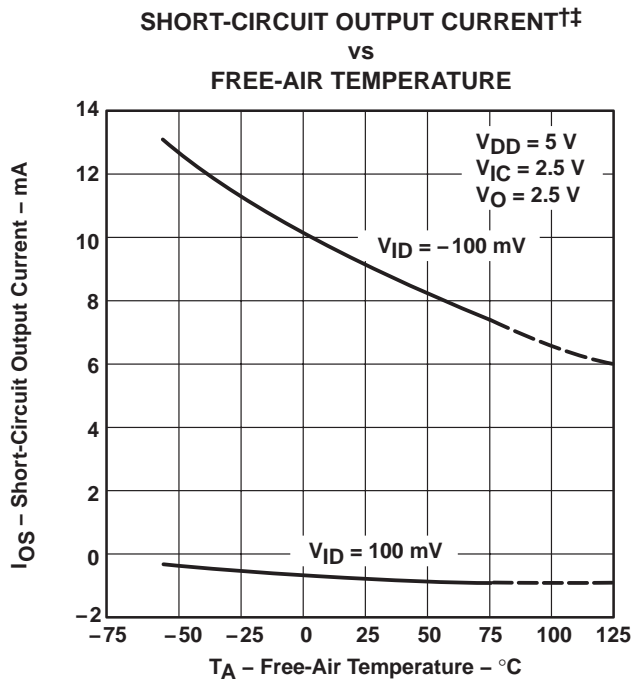

Figure 18

† Data at high and low temperatures are applicable only within the rated operating free-air temperature ranges of the various devices.
 ‡ For all curves where $V_{DD} = 5 V$, all loads are referenced to 2.5 V. For all curves where $V_{DD} = 3 V$, all loads are referenced to 1.5 V.

TYPICAL CHARACTERISTICS



† Data at high and low temperatures are applicable only within the rated operating free-air temperature ranges of the various devices.
 ‡ For all curves where $V_{DD} = 5\text{ V}$, all loads are referenced to 2.5 V. For all curves where $V_{DD} = 3\text{ V}$, all loads are referenced to 1.5 V.

TYPICAL CHARACTERISTICS

LARGE-SIGNAL DIFFERENTIAL VOLTAGE AMPLIFICATION AND PHASE MARGIN†

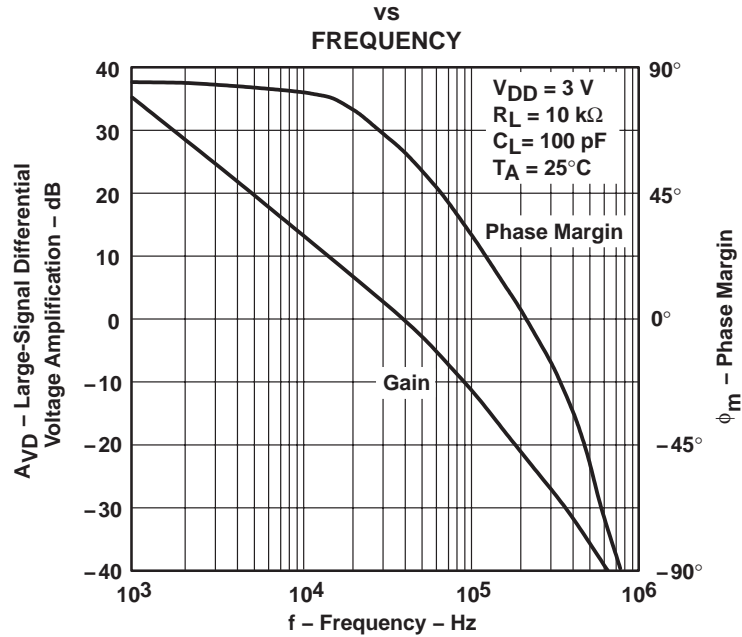

Figure 23

LARGE-SIGNAL DIFFERENTIAL VOLTAGE AMPLIFICATION AND PHASE MARGIN†

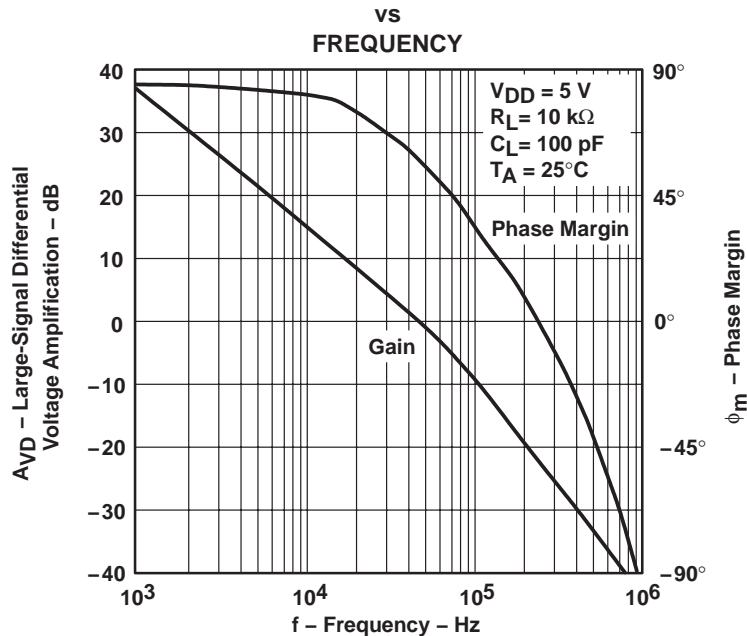
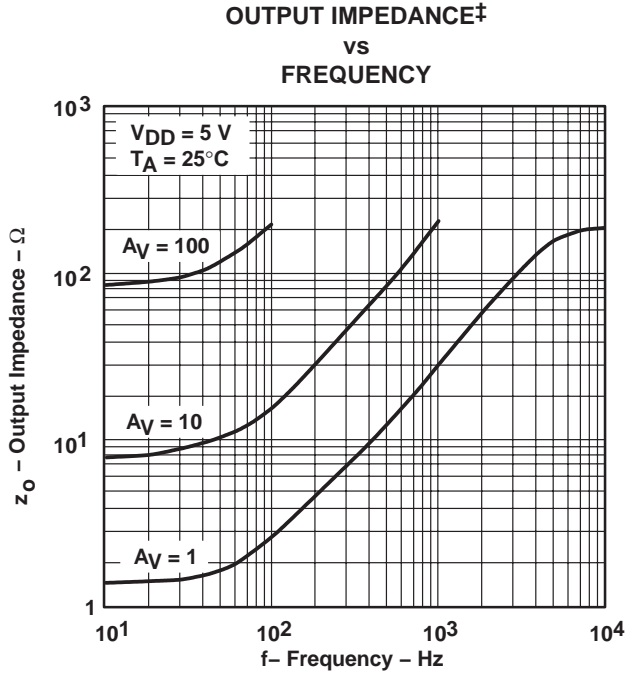
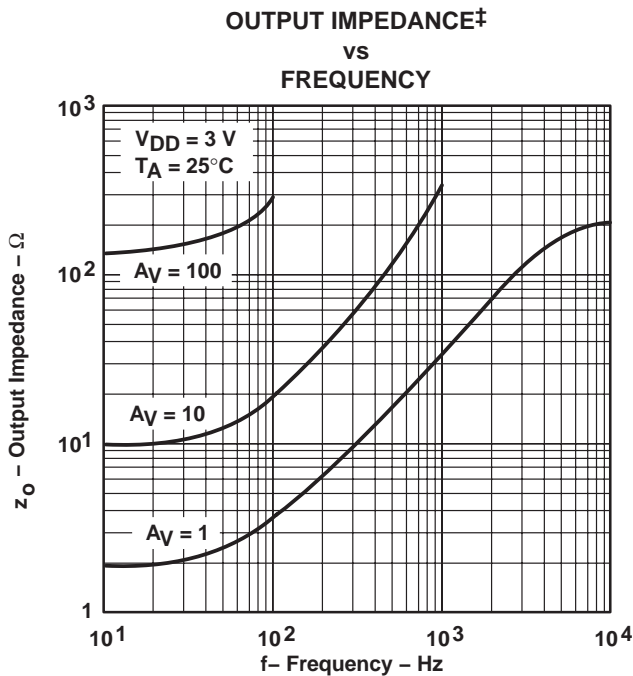
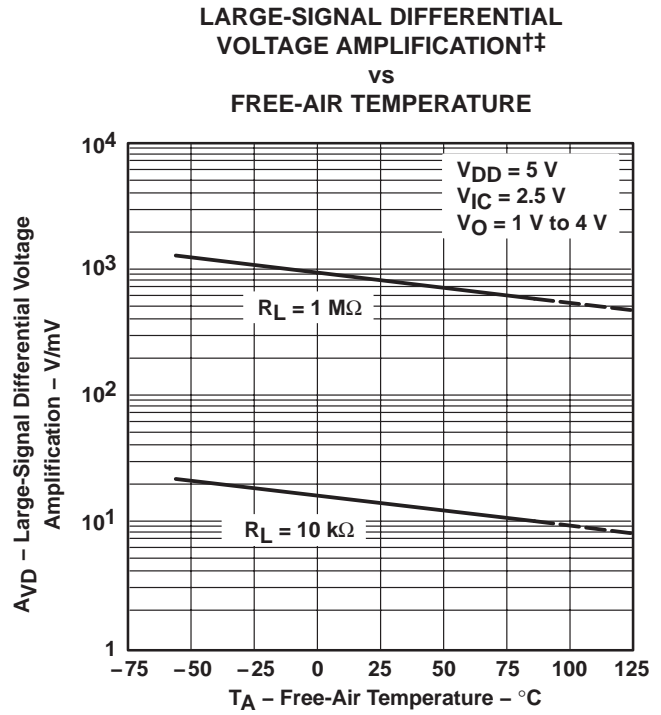
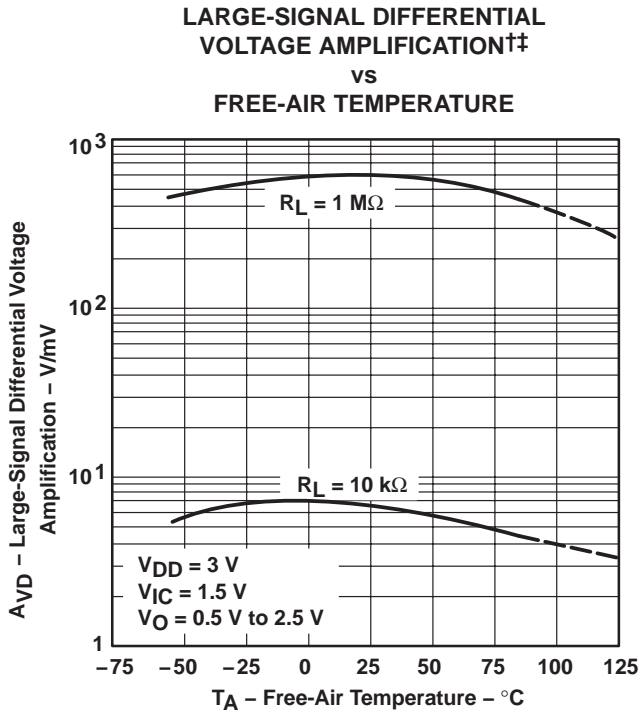

Figure 24

† For all curves where $V_{DD} = 5\text{ V}$, all loads are referenced to 2.5 V. For all curves where $V_{DD} = 3\text{ V}$, all loads are referenced to 1.5 V.

TYPICAL CHARACTERISTICS



† Data at high and low temperatures are applicable only within the rated operating free-air temperature ranges of the various devices.
 ‡ For all curves where $V_{DD} = 5\text{ V}$, all loads are referenced to 2.5 V. For all curves where $V_{DD} = 3\text{ V}$, all loads are referenced to 1.5 V.

TYPICAL CHARACTERISTICS

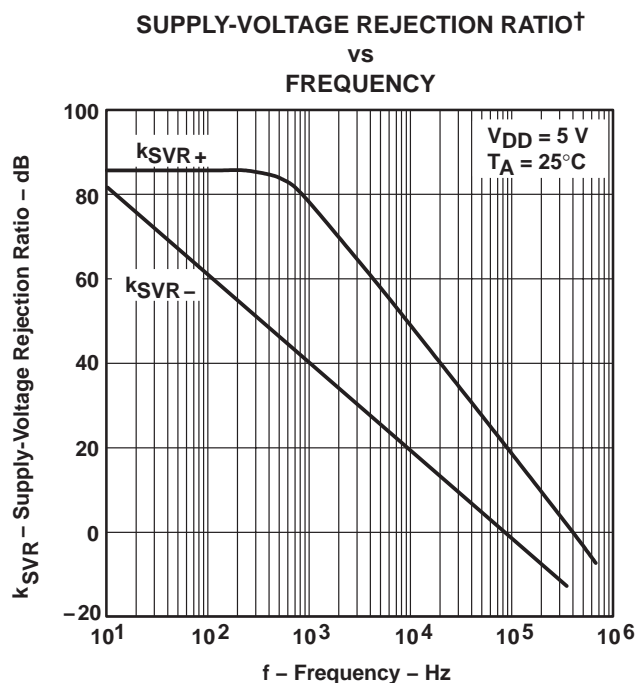
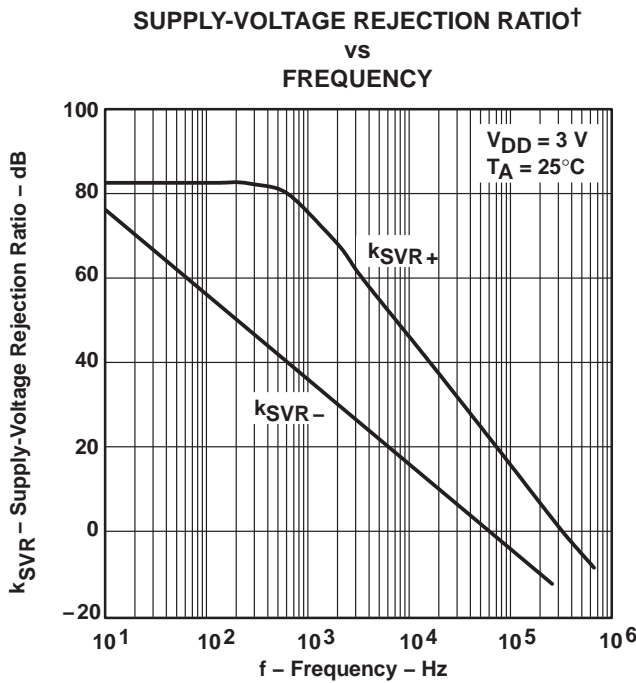
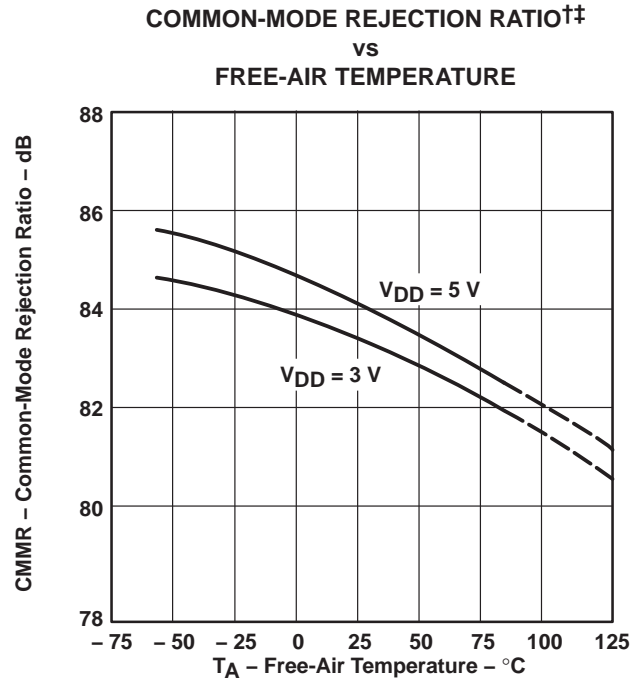
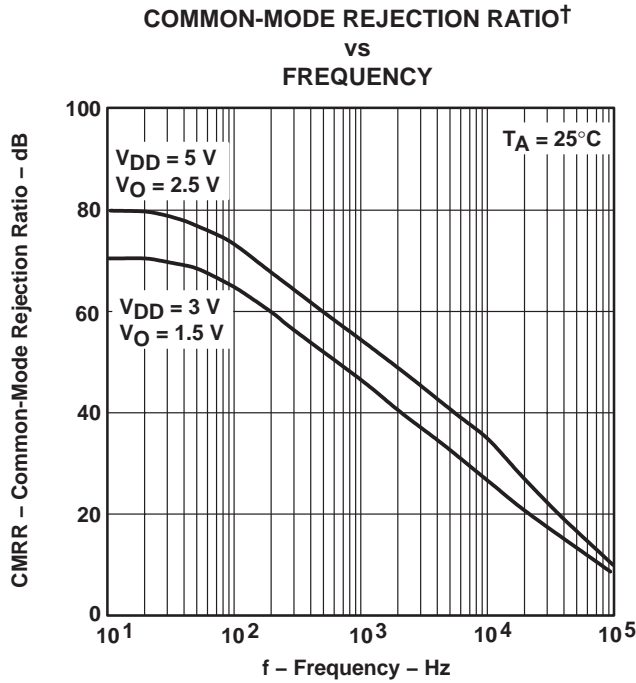

† For all curves where $V_{DD} = 5\text{ V}$, all loads are referenced to 2.5 V. For all curves where $V_{DD} = 3\text{ V}$, all loads are referenced to 1.5 V.
 †† Data at high and low temperatures are applicable only within the rated operating free-air temperature ranges of the various devices.

TLV2211, TLV2211Y
Advanced LinCMOS™ RAIL-TO-RAIL
MICROPOWER SINGLE OPERATIONAL AMPLIFIERS

SLOS156E – MAY 1996 – REVISED SEPTEMBER 2006

TYPICAL CHARACTERISTICS

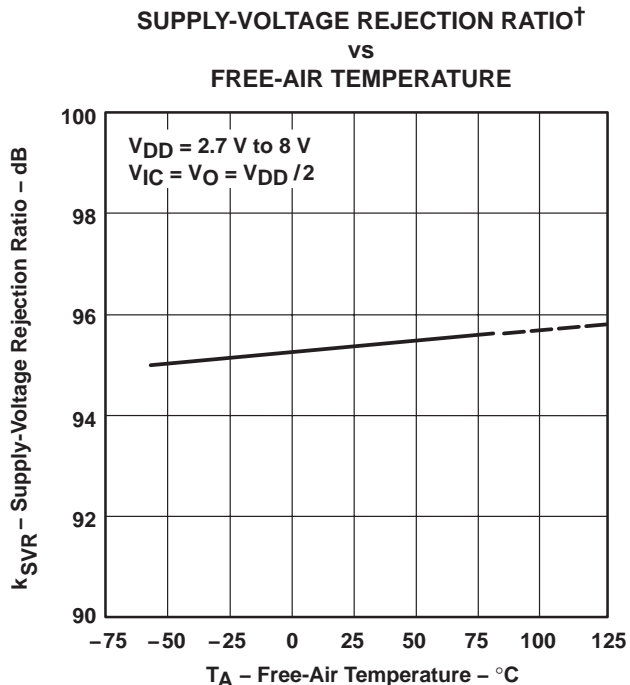

Figure 33

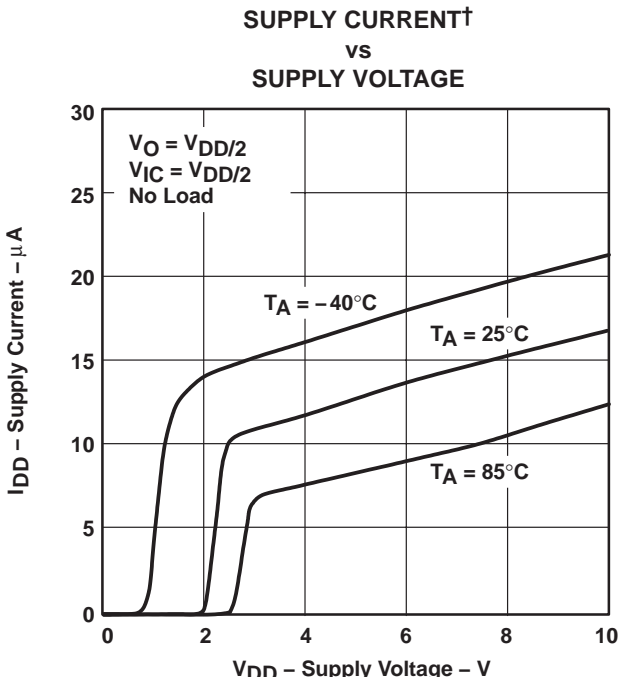

Figure 34

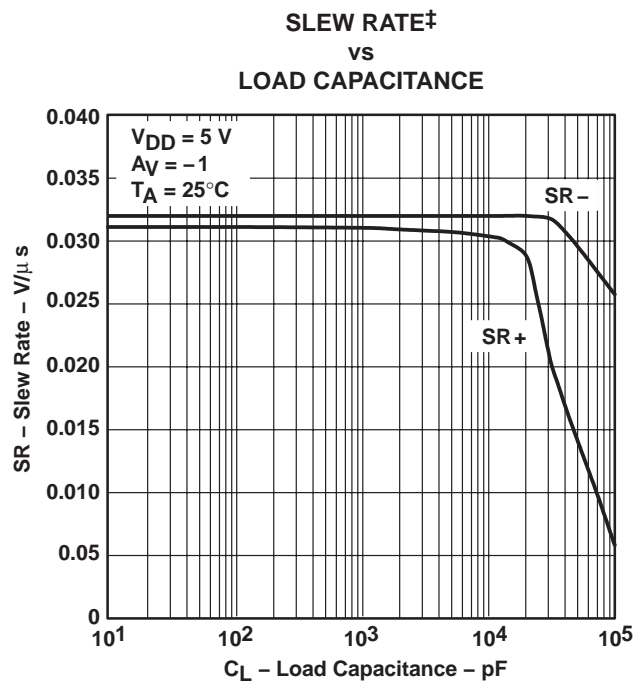

Figure 35

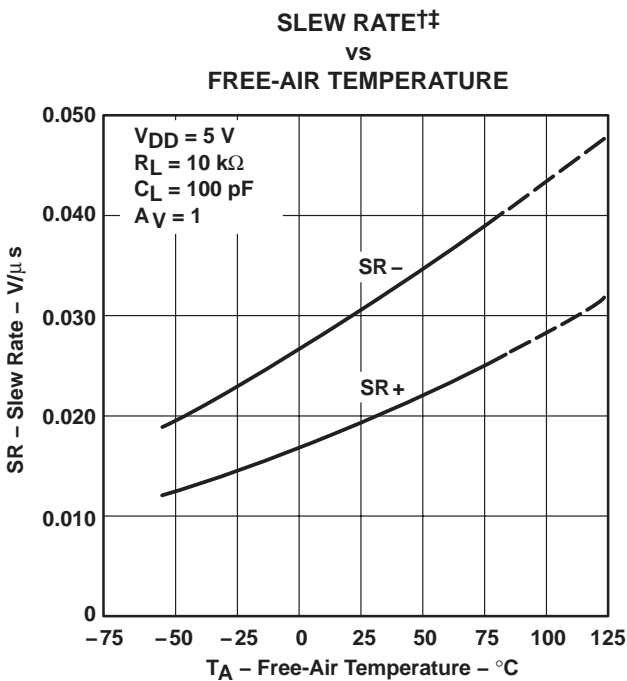

Figure 36

† Data at high and low temperatures are applicable only within the rated operating free-air temperature ranges of the various devices.

‡ For all curves where $V_{DD} = 5 \text{ V}$, all loads are referenced to 2.5 V. For all curves where $V_{DD} = 3 \text{ V}$, all loads are referenced to 1.5 V.



TYPICAL CHARACTERISTICS

INVERTING LARGE-SIGNAL PULSE RESPONSE†

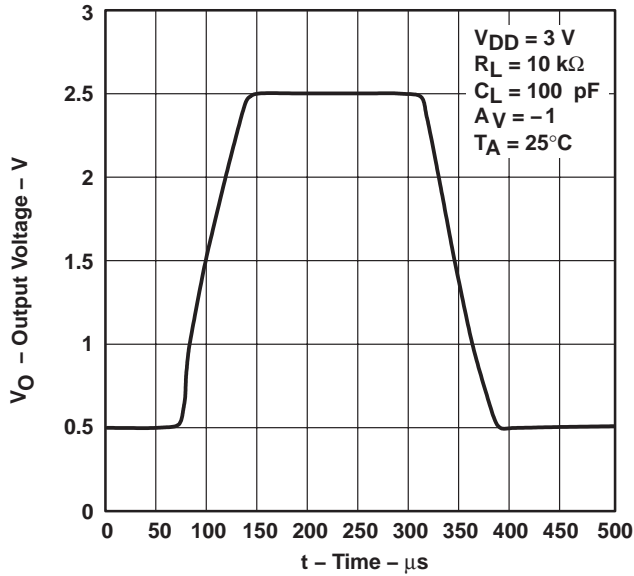

Figure 37

INVERTING LARGE-SIGNAL PULSE RESPONSE†

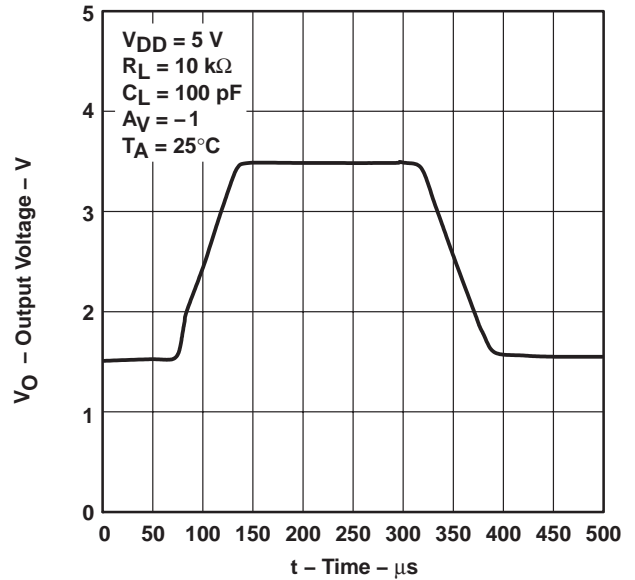

Figure 38

VOLTAGE-FOLLOWER LARGE-SIGNAL PULSE RESPONSE†

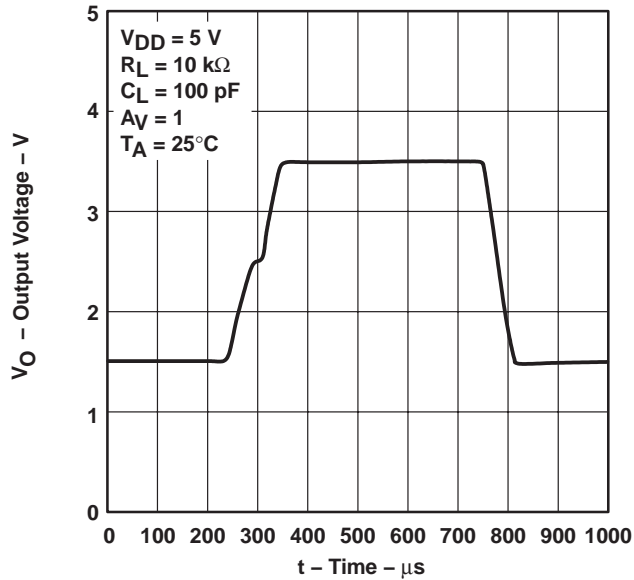

Figure 39

VOLTAGE-FOLLOWER LARGE-SIGNAL PULSE RESPONSE†

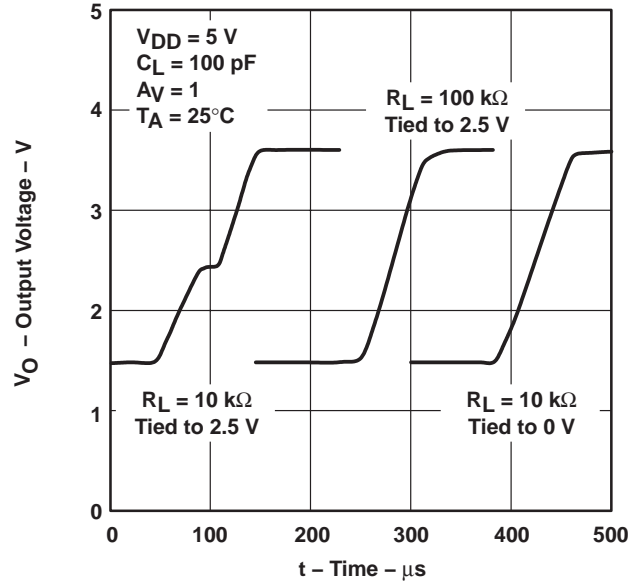

Figure 40

† For all curves where $V_{DD} = 5\text{ V}$, all loads are referenced to 2.5 V. For all curves where $V_{DD} = 3\text{ V}$, all loads are referenced to 1.5 V.

TYPICAL CHARACTERISTICS

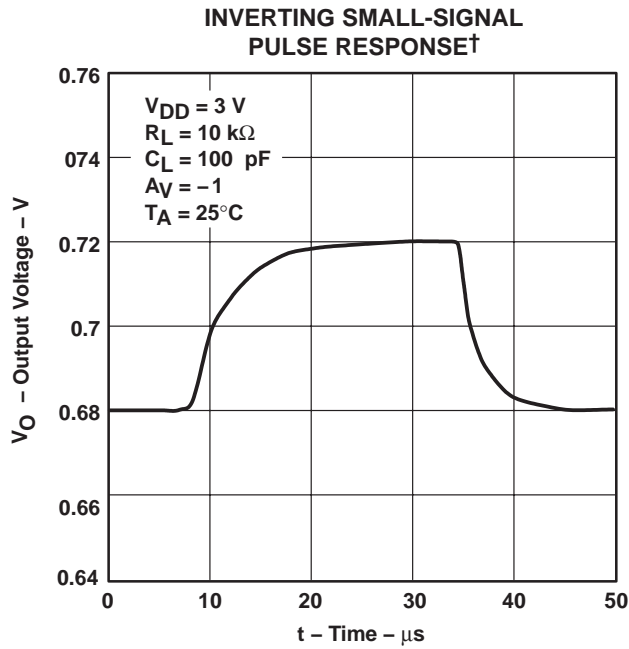

Figure 41

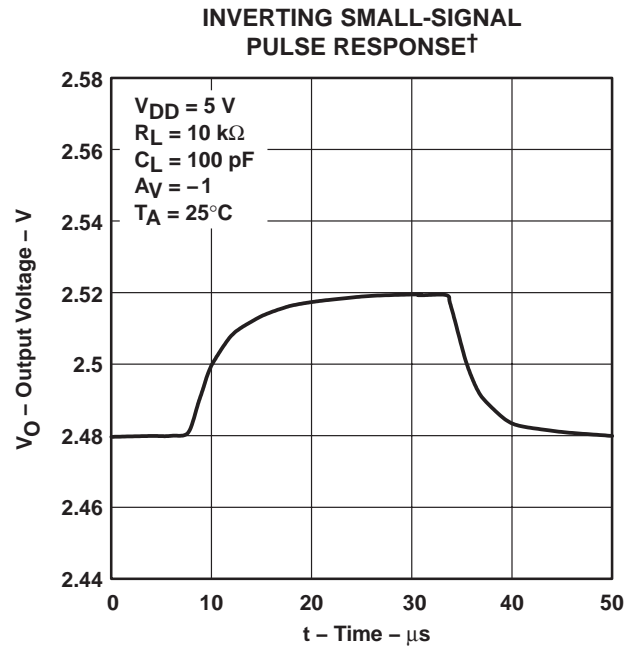

Figure 42

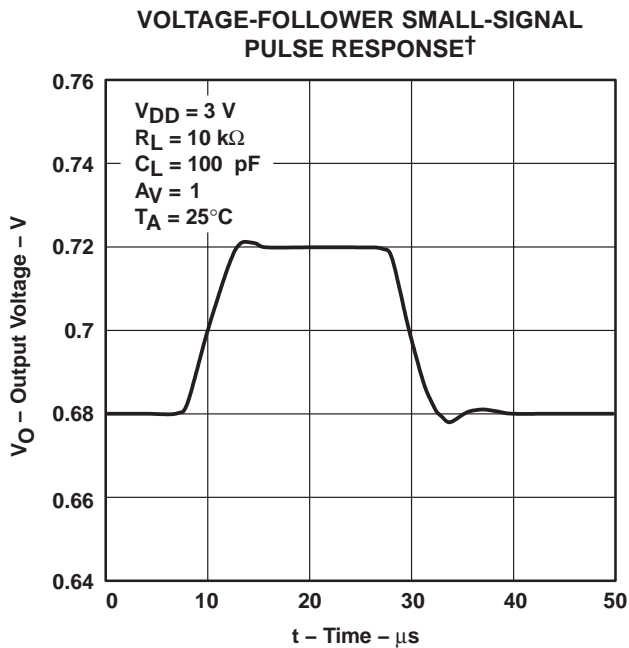

Figure 43

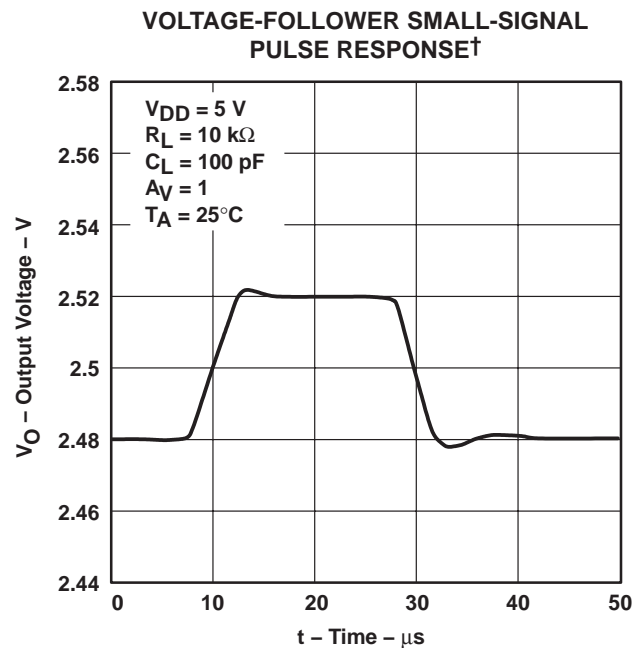
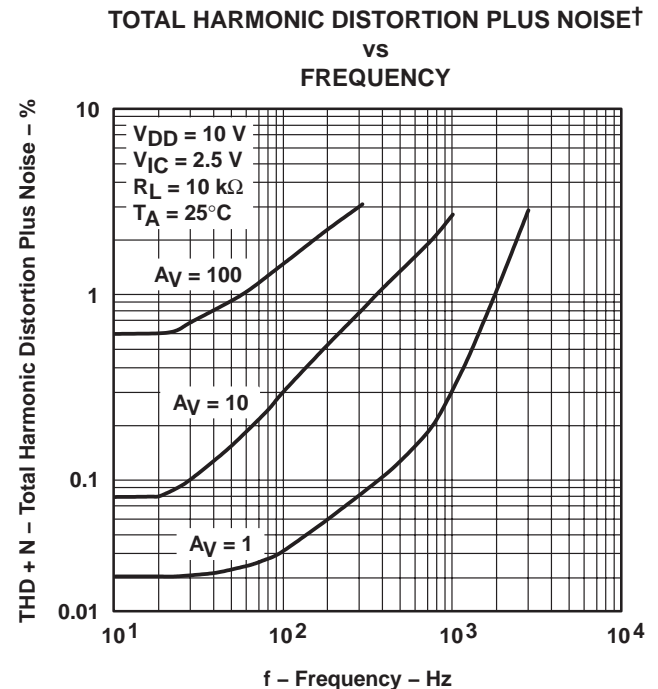
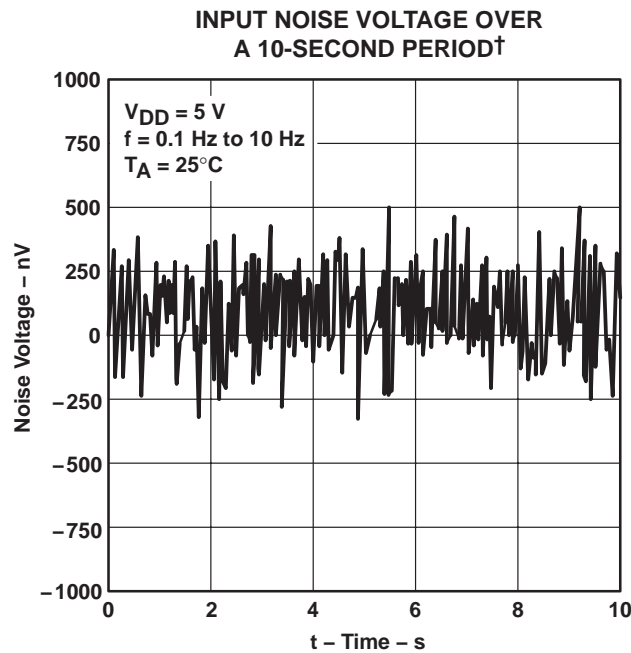
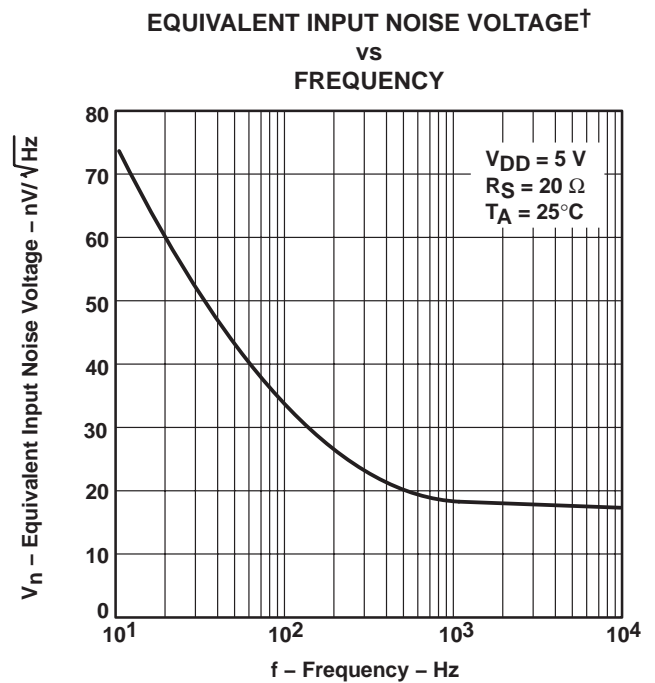
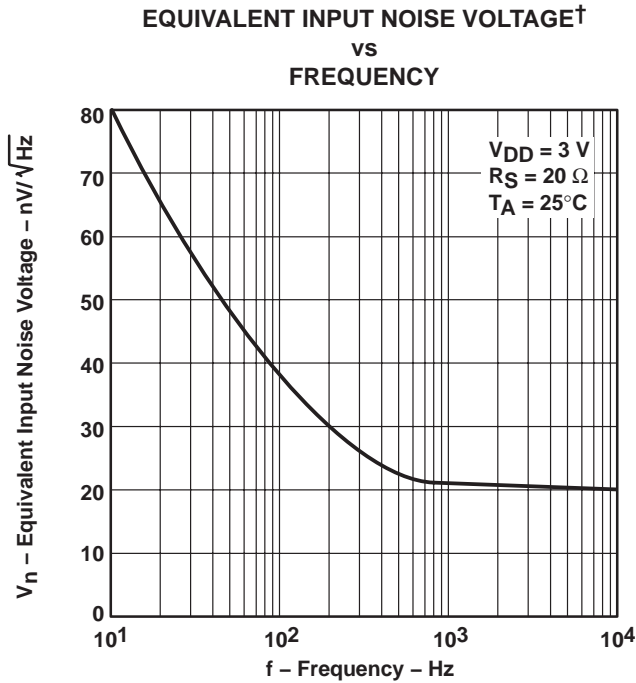

Figure 44

† For all curves where $V_{DD} = 5\text{ V}$, all loads are referenced to 2.5 V. For all curves where $V_{DD} = 3\text{ V}$, all loads are referenced to 1.5 V.

TYPICAL CHARACTERISTICS



† For all curves where $V_{DD} = 5\text{ V}$, all loads are referenced to 2.5 V. For all curves where $V_{DD} = 3\text{ V}$, all loads are referenced to 1.5 V.

TYPICAL CHARACTERISTICS

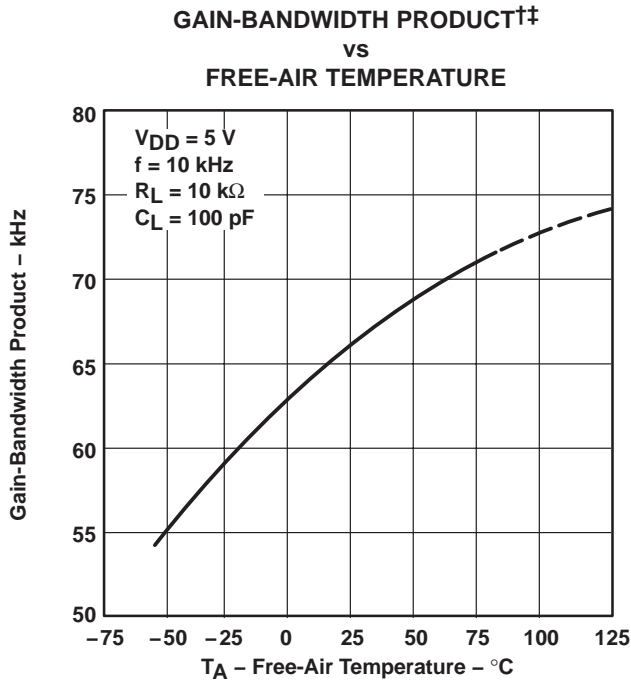

Figure 49

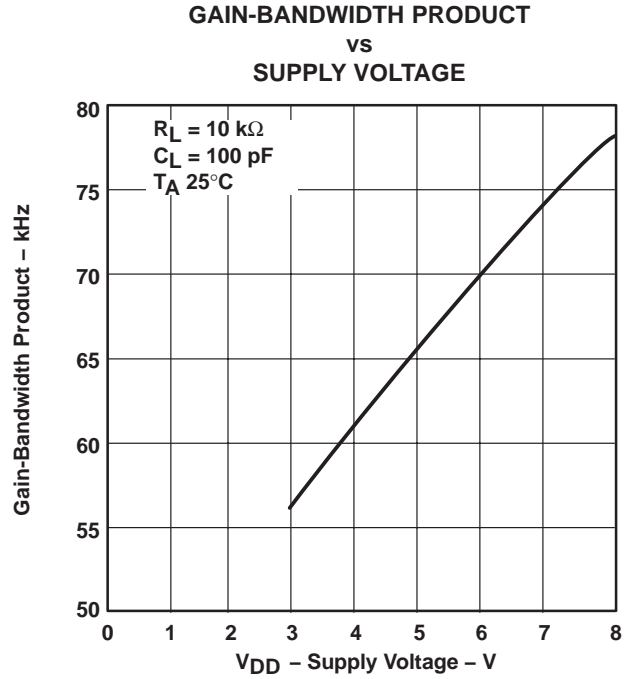

Figure 50

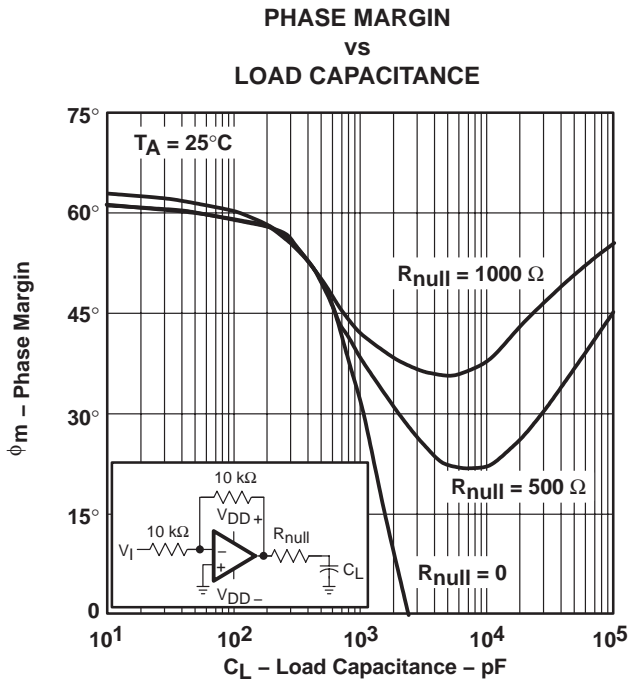

Figure 51

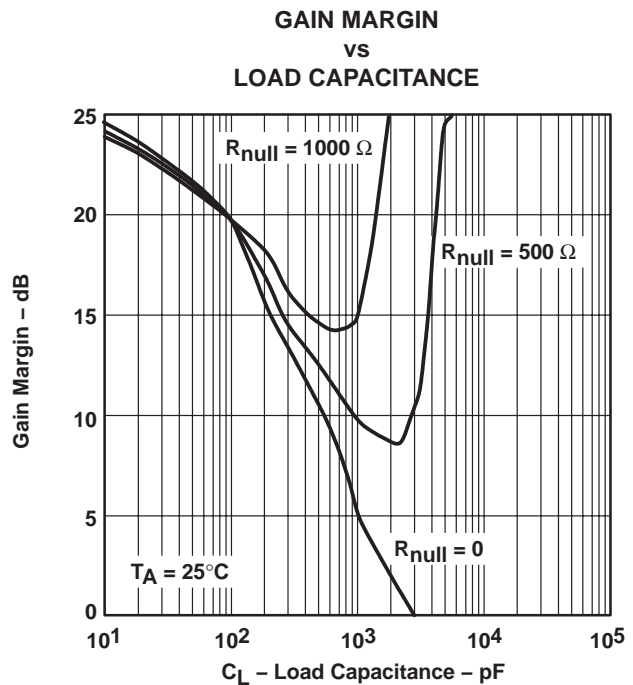

Figure 52

† Data at high and low temperatures are applicable only within the rated operating free-air temperature ranges of the various devices.
 ‡ For all curves where $V_{DD} = 5\text{ V}$, all loads are referenced to 2.5 V. For all curves where $V_{DD} = 3\text{ V}$, all loads are referenced to 1.5 V.

TYPICAL CHARACTERISTICS

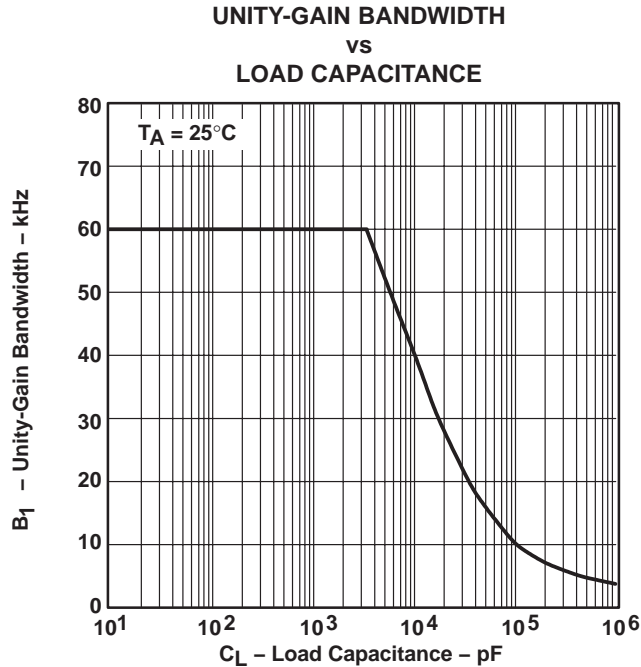

Figure 53

APPLICATION INFORMATION

driving large capacitive loads

The TLV2211 is designed to drive larger capacitive loads than most CMOS operational amplifiers. Figures 51 and 52 illustrate its ability to drive loads up to 600 pF while maintaining good gain and phase margins ($R_{null} = 0$).

A smaller series resistor (R_{null}) at the output of the device (see Figure 54) improves the gain and phase margins when driving large capacitive loads. Figures 51 and 52 show the effects of adding series resistances of 500 Ω and 1000 Ω . The addition of this series resistor has two effects: the first is that it adds a zero to the transfer function and the second is that it reduces the frequency of the pole associated with the output load in the transfer function.

The zero introduced to the transfer function is equal to the series resistance times the load capacitance. To calculate the improvement in phase margin, equation 1 can be used.

$$\Delta\phi_{m1} = \tan^{-1} \left(2 \times \pi \times \text{UGBW} \times R_{null} \times C_L \right) \quad (1)$$

Where :

$\Delta\phi_{m1}$ = improvement in phase margin

UGBW = unity-gain bandwidth frequency

R_{null} = output series resistance

C_L = load capacitance

APPLICATION INFORMATION

driving large capacitive loads (continued)

The unity-gain bandwidth (UGBW) frequency decreases as the capacitive load increases (see Figure 54). To use equation 1, UGBW must be approximated from Figure 54.

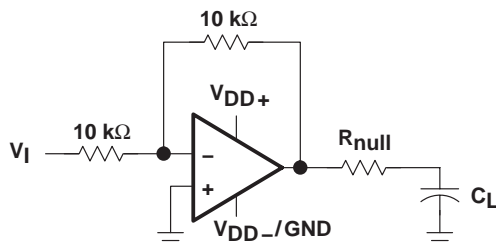

Figure 54. Series-Resistance Circuit

driving heavy dc loads

The TLV2211 is designed to provide better sinking and sourcing output currents than earlier CMOS rail-to-rail output devices. This device is specified to sink 500 μA and source 250 μA at $V_{\text{DD}} = 3\text{ V}$ and $V_{\text{DD}} = 5\text{ V}$ at a maximum quiescent I_{DD} of 25 μA . This provides a greater than 90% power efficiency.

When driving heavy dc loads, such as 10 k Ω , the positive edge can experience some distortion under slewing conditions. This condition can be seen in Figure 39. This condition is affected by three factors:

- Where the load is referenced. When the load is referenced to either rail, this condition does not occur. The distortion occurs only when the output signal swings through the point where the load is referenced. Figure 40 illustrates two 10-k Ω load conditions. The first load condition shows the distortion seen for a 10-k Ω load tied to 2.5 V. The third load condition shows no distortion for a 10-k Ω load tied to 0 V.
- Load resistance. As the load resistance increases, the distortion seen on the output decreases. Figure 40 illustrates the difference seen on the output for a 10-k Ω load and a 100-k Ω load with both tied to 2.5 V.
- Input signal edge rate. Faster input edge rates for a step input result in more distortion than with slower input edge rates.

APPLICATION INFORMATION

macromodel information

Macromodel information provided was derived using Microsim *Parts*™, the model generation software used with Microsim *PSpice*™. The Boyle macromodel (see Note 6) and subcircuit in Figure 54 are generated using the TLV2211 typical electrical and operating characteristics at $T_A = 25^\circ\text{C}$. Using this information, output simulations of the following key parameters can be generated to a tolerance of 20% (in most cases):

- Maximum positive output voltage swing
- Maximum negative output voltage swing
- Slew rate
- Quiescent power dissipation
- Input bias current
- Open-loop voltage amplification
- Unity-gain frequency
- Common-mode rejection ratio
- Phase margin
- DC output resistance
- AC output resistance
- Short-circuit output current limit

NOTE 6: G. R. Boyle, B. M. Cohn, D. O. Pederson, and J. E. Solomon, "Macromodeling of Integrated Circuit Operational Amplifiers", *IEEE Journal of Solid-State Circuits*, SC-9, 353 (1974).

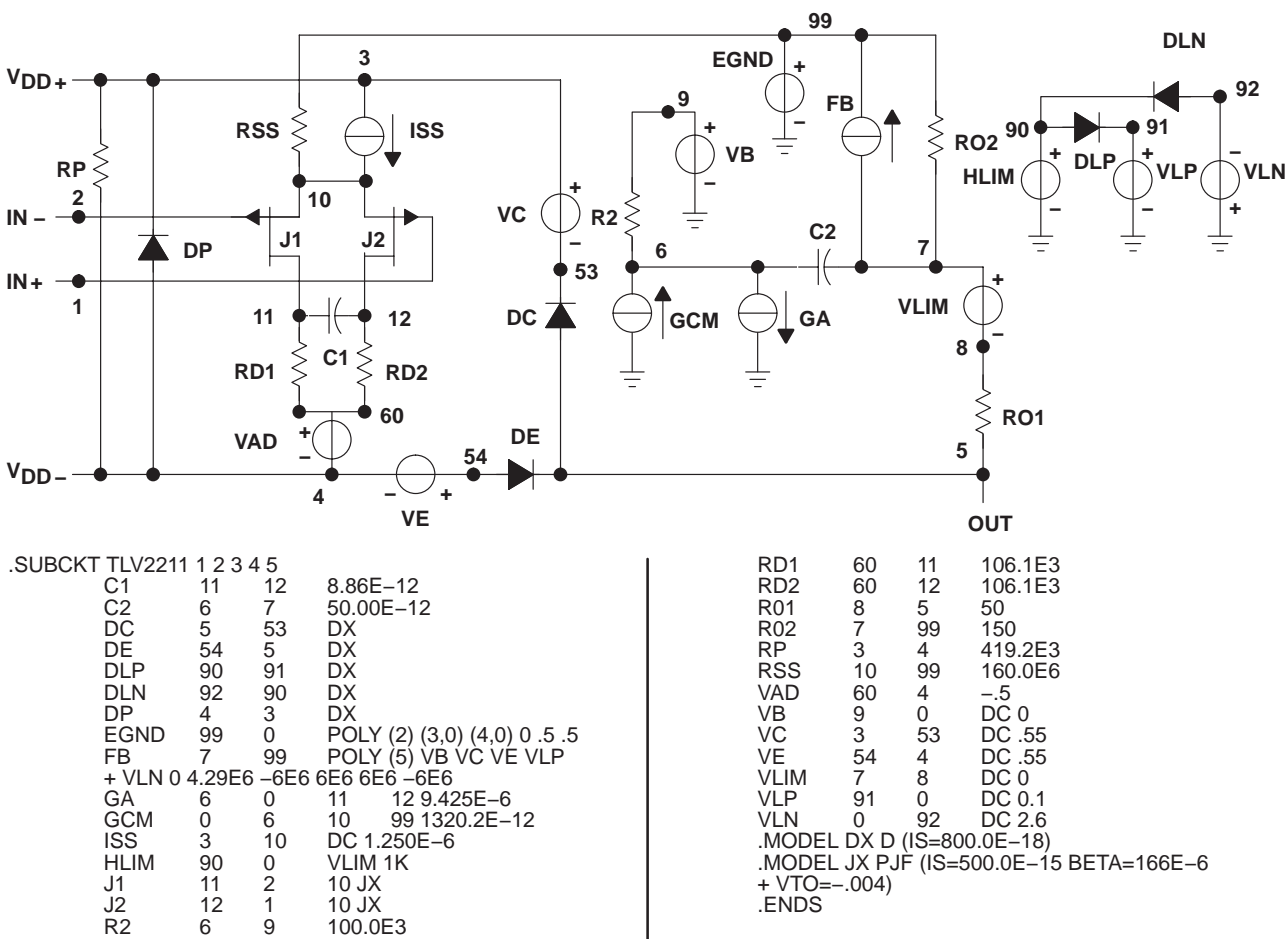

Figure 55. Boyle Macromodel and Subcircuit

PSpice and *Parts* are trademark of MicroSim Corporation.

Macromodels, simulation models, or other models provided by TI, directly or indirectly, are not warranted by TI as fully representing all of the specification and operating characteristics of the semiconductor product to which the model relates.



TAPE AND REEL INFORMATION

QUADRANT ASSIGNMENTS FOR PIN 1 ORIENTATION IN TAPE

*All dimensions are nominal

Device	Package Type	Package Drawing	Pins	SPQ	Reel Diameter (mm)	Reel Width W1 (mm)	A0 (mm)	B0 (mm)	K0 (mm)	P1 (mm)	W (mm)	Pin1 Quadrant
TLV2211CDBVR	SOT-23	DBV	5	3000	180.0	9.0	3.15	3.2	1.4	4.0	8.0	Q3
TLV2211CDBVT	SOT-23	DBV	5	250	180.0	9.0	3.15	3.2	1.4	4.0	8.0	Q3
TLV2211IDBVR	SOT-23	DBV	5	3000	178.0	9.0	3.3	3.2	1.4	4.0	8.0	Q3
TLV2211IDBVT	SOT-23	DBV	5	250	178.0	9.0	3.3	3.2	1.4	4.0	8.0	Q3

TAPE AND REEL BOX DIMENSIONS

*All dimensions are nominal

Device	Package Type	Package Drawing	Pins	SPQ	Length (mm)	Width (mm)	Height (mm)
TLV2211CDBVR	SOT-23	DBV	5	3000	182.0	182.0	20.0
TLV2211CDBVT	SOT-23	DBV	5	250	182.0	182.0	20.0
TLV2211IDBVR	SOT-23	DBV	5	3000	180.0	180.0	18.0
TLV2211IDBVT	SOT-23	DBV	5	250	180.0	180.0	18.0

DBV0005A



PACKAGE OUTLINE

SOT-23 - 1.45 mm max height

SMALL OUTLINE TRANSISTOR

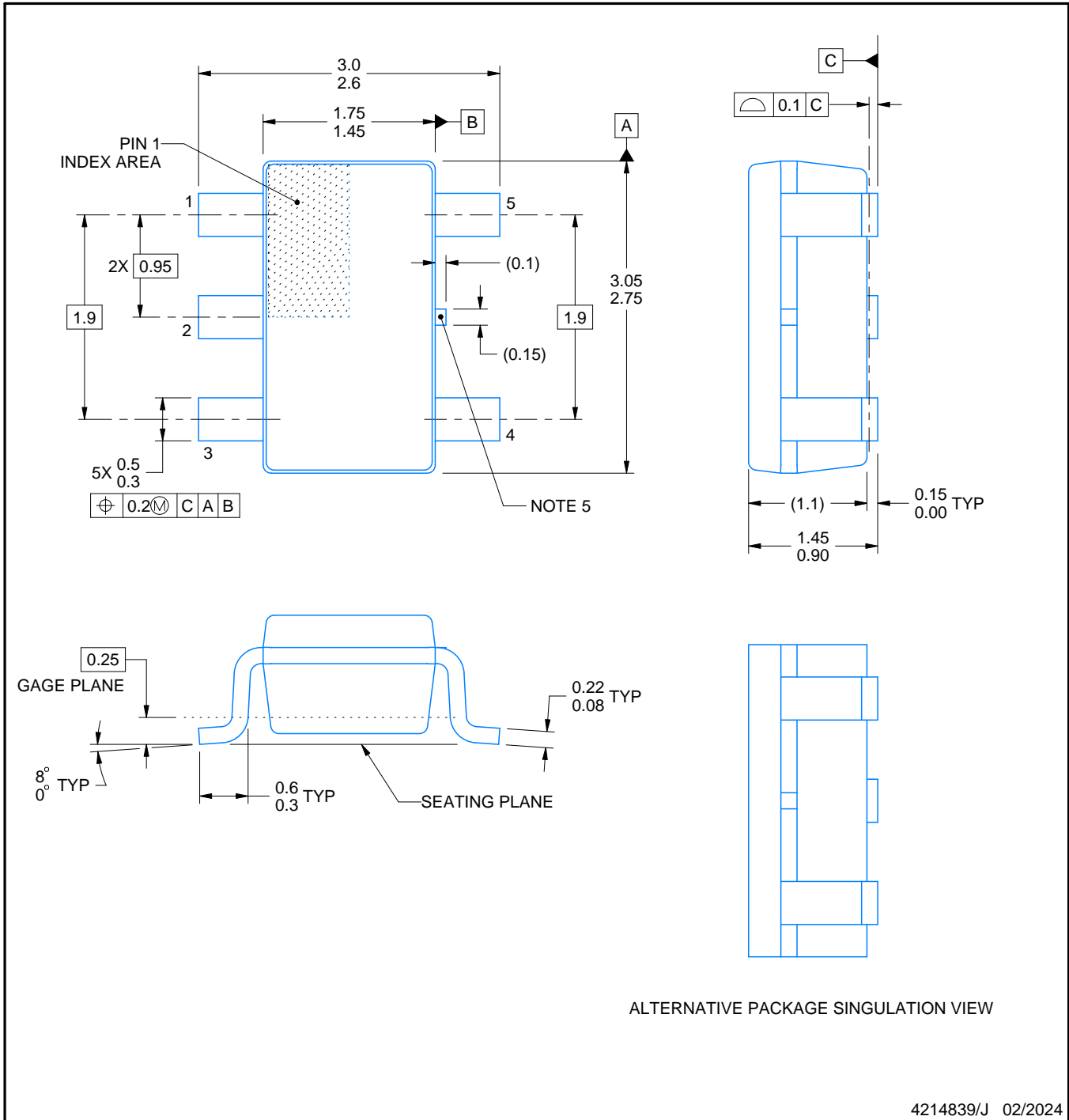

NOTES:

1. All linear dimensions are in millimeters. Any dimensions in parenthesis are for reference only. Dimensioning and tolerancing per ASME Y14.5M.
2. This drawing is subject to change without notice.
3. Reference JEDEC MO-178.
4. Body dimensions do not include mold flash, protrusions, or gate burrs. Mold flash, protrusions, or gate burrs shall not exceed 0.25 mm per side.
5. Support pin may differ or may not be present.

4214839/J 02/2024

EXAMPLE BOARD LAYOUT

DBV0005A

SOT-23 - 1.45 mm max height

SMALL OUTLINE TRANSISTOR



LAND PATTERN EXAMPLE
EXPOSED METAL SHOWN
SCALE:15X

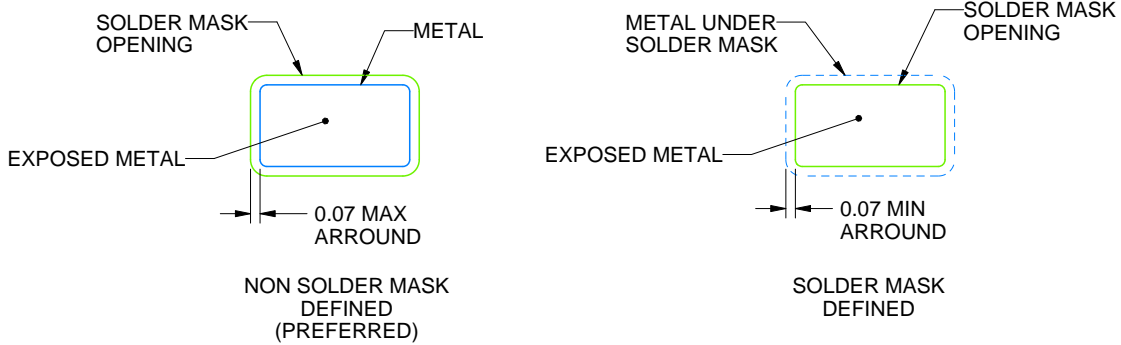

SOLDER MASK DETAILS

4214839/J 02/2024

NOTES: (continued)

- 6. Publication IPC-7351 may have alternate designs.
- 7. Solder mask tolerances between and around signal pads can vary based on board fabrication site.

EXAMPLE STENCIL DESIGN

DBV0005A

SOT-23 - 1.45 mm max height

SMALL OUTLINE TRANSISTOR



SOLDER PASTE EXAMPLE
BASED ON 0.125 mm THICK STENCIL
SCALE:15X

4214839/J 02/2024

NOTES: (continued)

8. Laser cutting apertures with trapezoidal walls and rounded corners may offer better paste release. IPC-7525 may have alternate design recommendations.
9. Board assembly site may have different recommendations for stencil design.

IMPORTANT NOTICE AND DISCLAIMER

TI PROVIDES TECHNICAL AND RELIABILITY DATA (INCLUDING DATA SHEETS), DESIGN RESOURCES (INCLUDING REFERENCE DESIGNS), APPLICATION OR OTHER DESIGN ADVICE, WEB TOOLS, SAFETY INFORMATION, AND OTHER RESOURCES "AS IS" AND WITH ALL FAULTS, AND DISCLAIMS ALL WARRANTIES, EXPRESS AND IMPLIED, INCLUDING WITHOUT LIMITATION ANY IMPLIED WARRANTIES OF MERCHANTABILITY, FITNESS FOR A PARTICULAR PURPOSE OR NON-INFRINGEMENT OF THIRD PARTY INTELLECTUAL PROPERTY RIGHTS.

These resources are intended for skilled developers designing with TI products. You are solely responsible for (1) selecting the appropriate TI products for your application, (2) designing, validating and testing your application, and (3) ensuring your application meets applicable standards, and any other safety, security, regulatory or other requirements.

These resources are subject to change without notice. TI grants you permission to use these resources only for development of an application that uses the TI products described in the resource. Other reproduction and display of these resources is prohibited. No license is granted to any other TI intellectual property right or to any third party intellectual property right. TI disclaims responsibility for, and you will fully indemnify TI and its representatives against, any claims, damages, costs, losses, and liabilities arising out of your use of these resources.

TI's products are provided subject to [TI's Terms of Sale](#) or other applicable terms available either on [ti.com](https://www.ti.com) or provided in conjunction with such TI products. TI's provision of these resources does not expand or otherwise alter TI's applicable warranties or warranty disclaimers for TI products.

TI objects to and rejects any additional or different terms you may have proposed.

Mailing Address: Texas Instruments, Post Office Box 655303, Dallas, Texas 75265
Copyright © 2024, Texas Instruments Incorporated