

## ADC12QS065 Quad 12-Bit 65 MSPS A/D Converter with LVDS Serialized Outputs

Check for Samples: [ADC12QS065](#)

### FEATURES

- **Single +3.3V Supply Operation**
- **Internal Sample-and-Hold and Internal Reference**
- **Low Power Consumption**
- **Power Down Mode**
- **Clock and Data Frame Timing**
- **780 Mbps Serial LVDS Data Rate (at 65 MHz Clock)**
- **LVDS Serial Output Rated for 100 Ohm Load**

### KEY SPECIFICATIONS

- **Resolution: 12 Bits**
- **DNL:  $\pm 0.3$  LSB (Typ)**
- **SNR ( $f_{IN} = 5$  MHz): 69 dB (Typ)**
- **SFDR ( $f_{IN} = 5$  MHz): 83 dB (Typ)**
- **ENOB (at Nyquist): 11 Bits (Typ)**
- **Power Consumption**
  - **Operating, 65 MSPS, per ADC: 200 mW (Typ)**
  - **Power Down Mode: < 3 mW (Typ)**

### APPLICATIONS

- **Ultrasound**
- **Medical Imaging**
- **Communications**
- **Portable Instrumentation**
- **Digital Video**

### DESCRIPTION

The ADC12QS065 is a low power, high performance CMOS 4-channel analog-to-digital converter with LVDS serialized outputs. The ADC12QS065 digitizes signals to 12 bits resolution at sampling rates up to 65 MSPS while consuming a typical 200 mW/ADC from a single 3.3V supply. Sampled data is transformed into high speed serial LVDS output data streams. Clock and frame LVDS pairs aid in data capture. The ADC12QS065's six differential pairs transmit data over backplanes or cable and also make PCB design easier. In addition, the reduced cable, PCB trace count, and connector size tremendously reduce cost.

No missing codes performance is ensured over the full operating temperature range. The pipeline ADC architecture achieves 11 Effective Bits over the entire Nyquist band at 65 MSPS.

When not converting, power consumption can be reduced by pulling the PD (Power Down) pin high, placing the converter into a low power state where it typically consumes less than 3 mW total, and from which recovery is less than 5 ms. The ADC12QS065's speed, resolution and single supply operation makes it well suited for a variety of applications in ultrasound, imaging, video and communications. Operating over the industrial (-40°C to +85°C) temperature range, the ADC12QS065 is available in a 60-pin WQFN package with exposed pad (9x9x0.8mm, 0.5mm pin pitch).



Please be aware that an important notice concerning availability, standard warranty, and use in critical applications of Texas Instruments semiconductor products and disclaimers thereto appears at the end of this data sheet.

All trademarks are the property of their respective owners.

Connection Diagram

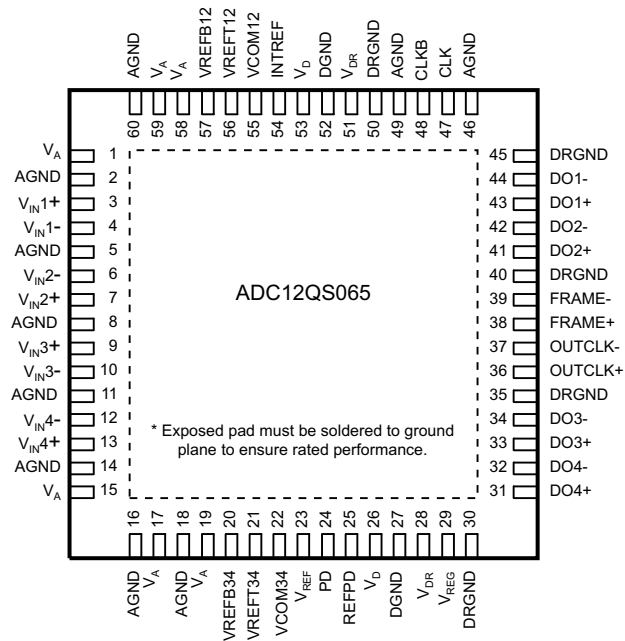
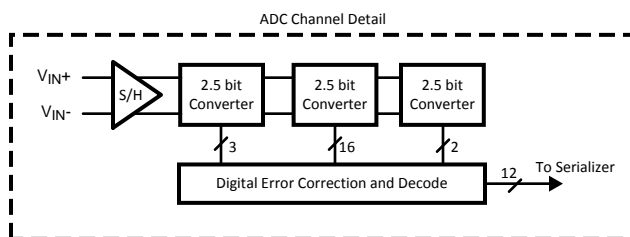
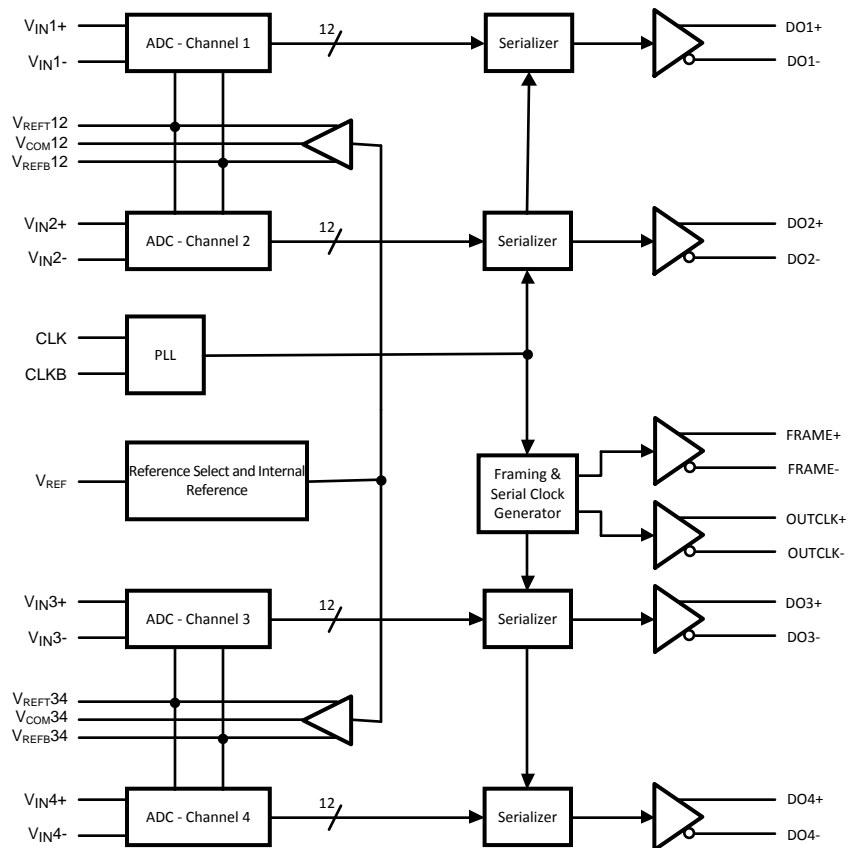

Figure 1. 60-Lead WQFN  
See NKA0060A Package

Block Diagram



## PIN DESCRIPTIONS

| Pin No.              | Symbol   | Description  |
|----------------------|--|--|
| <b>ANALOG I/O</b>    |  |  |
| 3<br>7<br>9<br>13    | $V_{IN1+}$<br>$V_{IN2+}$<br>$V_{IN3+}$<br>$V_{IN4+}$ | Differential analog input pins. With a 1.0V reference voltage the differential full-scale input signal level is 2.0 $V_{P-P}$ with each input pin voltage centered on a common mode voltage, $V_{COM}$ . The negative input pins may be connected to $V_{COM}$ for single-ended operation, but a differential input signal is required for best performance.   |
| 4<br>6<br>10<br>12   | $V_{IN1-}$<br>$V_{IN2-}$<br>$V_{IN3-}$<br>$V_{IN4-}$ |  |
| 23                   | $V_{REF}$  | This pin is the reference select pin and the external reference input, used in conjunction with the INTREF pin.<br>If the INTREF pin is set to $V_A$ , this pin is used as an internal reference select. With $V_{REF} = V_A$ , the internal 1.0V reference is selected. With $V_{REF}=AGND$ , the internal 0.5V reference is selected.<br>If the INTREF pin is set to AGND, then this pin is the input for an external reference. A voltage in the range of 0.8 to 1V may be applied to this pin. $V_{REF}$ should be bypassed to AGND with a 1.0 $\mu F$ capacitor when an external reference is used. |
| 56<br>21             | VREFT12<br>VREFT34                                   | Top ADC Reference. This pin has to be driven to 1.9V if REFPD is high.<br>If REFPD is low, bypass this pin with a 0.1 $\mu F$ low ESR capacitor to AGND and a 10 $\mu F$ low ESR capacitor to VREFB. These pins should not be loaded.  |
| 55<br>22             | VCOM12<br>VCOM34                                     | This is an analog output which can be used as a common mode voltage for the inputs. It should be bypassed to AGND with a minimum of a 1.0 $\mu F$ low ESR capacitor in parallel with a 0.1 $\mu F$ capacitor. These pins may also be used as a 1.5V temperature stable reference voltage with a maximum load of 1mA.   |
| 57<br>20             | VREFB12<br>VREFB34                                   | Bottom ADC Reference. This pin has to be driven to 0.9V if REFPD is high.<br>If REFPD is low, bypass this pin with a 0.1 $\mu F$ low ESR capacitor to AGND and a 10 $\mu F$ low ESR capacitor to VREFT. These pins should not be loaded.   |
| 29                   | VREG   | This is the bypass pin for the internal 1.8V regulator. This pin should be bypassed to AGND with a 1.0 $\mu F$ capacitor   |
| <b>DIGITAL I/O</b>   |  |  |
| 47                   | CLK  | This pin acts as either a Non-Inverting Differential Clock input or a CMOS clock input. If CLKB is used as the Inverting Clock input, CLK will act as the Non-Inverting Clock input. If CLKB is tied to AGND, CLK will act as a CMOS clock input. ADC power consumption will increase by about 40mW if a Differential Clock is used.   |
| 48                   | CLKB   | Inverting Differential Clock input. If tied to AGND, CLK acts as a CMOS clock input.   |
| 54                   | INTREF   | Internal reference enable input. When this pin is high, two internal reference choices are selectable through the $V_{REF}$ pin. When this pin is low, an external reference must be applied to $V_{REF}$ (pin 23).  |
| 24                   | PD   | Power Down pin that, when high, puts the converter into the Power Down mode.   |
| 25                   | REFPD  | With REFPD high, user must drive VREFT12, VREFT34 and VREFB12 & VREFB34 externally. With REFPD low, VREFT12, VREFT34 and VREFB12 & VREFB34 are driven internally.  |
| 43<br>41<br>33<br>31 | DO1+<br>DO2+<br>DO3+<br>DO4+                         | + Serial Data Output. Non-inverting LVDS differential output.  |
| 44<br>42<br>34<br>32 | DO1-<br>DO2-<br>DO3-<br>DO4-                         | - Serial Data Output. Inverting LVDS differential output.  |
| 38<br>39             | FRAME+<br>FRAME-                                     | LVDS output, it's rising edge corresponds to the first serial bit of the output streams. FRAME clock frequency is the same as the CLK frequency.   |
| 36<br>37             | OUTCLK+<br>OUTCLK-                                   | LVDS output clock. The data is valid on an output transition. Successive data bits are captured on both edges of this clock. OUTCLK frequency is 6X the CLK frequency.   |

**PIN DESCRIPTIONS (continued)**

| Pin No.                            | Symbol   | Description  |
|------------------------------------|----------|--|
| <b>ANALOG POWER</b>                |          |  |
| 1,15,17,19,<br>58,59               | $V_A$    | Positive analog supply pins. These pins should be connected to a quiet +3.3V source and bypassed to AGND with 0.1 $\mu$ F capacitors located near these power pins, and with a 10 $\mu$ F capacitor.   |
| 2,5,8,11,<br>14,16,18,<br>46,49,60 | AGND     | The ground return for the analog supply.<br>NOTE: The exposed pad on the WQFN package must be soldered to AGND.  |
| <b>DIGITAL POWER</b>               |          |  |
| 26,53                              | $V_D$    | Positive digital supply pin. This pin should be connected to the same quiet +3.3V source as is $V_A$ and be bypassed to DGND with a 0.1 $\mu$ F capacitor located near the power pin and with a 10 $\mu$ F capacitor.  |
| 27, 52                             | DGND     | The ground return for the digital supply.  |
| 28, 51                             | $V_{DR}$ | Positive driver supply pin for the ADC12QS065's output drivers. This pin should be connected to a voltage source of +2.5V to $V_D$ and be bypassed to DR GND with a 0.1 $\mu$ F capacitor. If the supply for this pin is different from the supply used for $V_A$ and $V_D$ , it should also be bypassed with a 10 $\mu$ F capacitor. $V_{DR}$ should never exceed the voltage on $V_D$ . All bypass capacitors should be located near the supply pin. |
| 30,35,40, 45,50                    | DRGND    | The ground return for the ADC12QS065's output drivers.   |



These devices have limited built-in ESD protection. The leads should be shorted together or the device placed in conductive foam during storage or handling to prevent electrostatic damage to the MOS gates.

**Absolute Maximum Ratings<sup>(1)(2)(3)(4)</sup>**

|   |                                   |                                  |
|---|-----------------------------------|----------------------------------|
| $V_A, V_D, V_{DR}$                              |                                   | 3.8V                             |
| $ V_A - V_D $                                   |                                   | $\leq 100$ mV                    |
| Voltage on any pin (excludes pins 29 to 45)     |                                   | -0.3V to ( $V_A$ or $V_D$ +0.3V) |
| Voltage on any pin (pins 29 to 45)              |                                   | -0.3V to 2V                      |
| Input Current at Any Pin <sup>(5)</sup>         |                                   | $\pm 25$ mA                      |
| Package Input Current <sup>(5)</sup>            |                                   | $\pm 50$ mA                      |
| Package Dissipation at $T_A = 25^\circ\text{C}$ |                                   | See <sup>(6)</sup>               |
| ESD Susceptibility                              | Human Body Model <sup>(7)</sup>   | 2500V                            |
|   | Machine Model <sup>(7)</sup>      | 250V                             |
| Soldering Temperature                           | Infrared (10 sec.) <sup>(8)</sup> | 235°C                            |
| Storage Temperature                             |                                   | -65°C to +150°C                  |

- (1) All voltages are measured with respect to GND = AGND = DGND = 0V, unless otherwise specified.
- (2) Absolute Maximum Ratings indicate limits beyond which damage to the device may occur. Operating Ratings indicate conditions for which the device is ensured to be functional, but do not ensure specific performance limits. For ensured specifications and test conditions, see the Electrical Characteristics. The ensured specifications apply only for the test conditions listed. Some performance characteristics may degrade when the device is not operated under the listed test conditions. Operation of the device beyond the maximum Operating Ratings is not recommended.
- (3) Soldering process must comply with Texas Instruments' Reflow Temperature Profile specifications. Refer to [www.ti.com/packaging](http://www.ti.com/packaging).
- (4) If Military/Aerospace specified devices are required, please contact the Texas Instruments Sales Office/Distributors for availability and specifications.
- (5) When the input voltage at any pin exceeds the power supplies (that is,  $V_{IN} < \text{AGND}$ , or  $V_{IN} > V_A$ ), the current at that pin should be limited to 25 mA. The 50 mA maximum package input current rating limits the number of pins that can safely exceed the power supplies with an input current of 25 mA to two.
- (6) The absolute maximum junction temperature ( $T_{Jmax}$ ) for this device is 150°C. The maximum allowable power dissipation is dictated by  $T_{Jmax}$ , the junction-to-ambient thermal resistance ( $\theta_{JA}$ ), and the ambient temperature, ( $T_A$ ), and can be calculated using the formula  $P_{DMAX} = (T_{Jmax} - T_A) / \theta_{JA}$ . In the 60-pin WQFN,  $\theta_{JA}$  is 20°C/W with the exposed pad soldered to a ground plane, so  $P_{DMAX} = 2$  W at the maximum operating ambient temperature of 85°C. Note that the power consumption of this device under normal operation will typically be about 900 mW. The values for maximum power dissipation listed above will be reached only when the device is operated in a severe fault condition (e.g. when input or output pins are driven beyond the power supply voltages, or the power supply polarity is reversed). Obviously, such conditions should always be avoided.
- (7) Human body model is 100 pF capacitor discharged through a 1.5 k $\Omega$  resistor. Machine model is 220 pF discharged through 0 $\Omega$ .
- (8) Reflow Reflow temperature profiles are different for lead-free and non-lead-free packages.

**Operating Ratings<sup>(1)(2)</sup>**

|  |   |
|--|---|
| Operating Temperature  | -40°C ≤ T <sub>A</sub> ≤ +85°C                                |
| Supply Voltage (V <sub>A</sub> , V <sub>D</sub> )            | +3.0V to +3.6V  |
| Output Driver Supply (V <sub>DR</sub> )                      | +2.4V to V <sub>D</sub>                                       |
| V <sub>IN</sub> Differential Input Range                     | ±V <sub>REF</sub>   |
| V <sub>CM</sub> Input Common Mode Range (Differential Input) | V <sub>REF</sub> /2 to (V <sub>A</sub> - V <sub>REF</sub> /2) |
| External V <sub>REF</sub> Voltage Range                      | 0.8V to 1V  |
| Digital Input Pins Voltage Range (excludes pins 31 to 50)    | -0.3V to (V <sub>A</sub> + 0.3V)                              |
| AGND–DGND  | ≤100mV  |
| Clock Duty Cycle   | 30% to 70%  |

- (1) Absolute Maximum Ratings indicate limits beyond which damage to the device may occur. Operating Ratings indicate conditions for which the device is ensured to be functional, but do not ensure specific performance limits. For ensured specifications and test conditions, see the Electrical Characteristics. The ensured specifications apply only for the test conditions listed. Some performance characteristics may degrade when the device is not operated under the listed test conditions. Operation of the device beyond the maximum Operating Ratings is not recommended.
- (2) All voltages are measured with respect to GND = AGND = DGND = 0V, unless otherwise specified.

**Converter Electrical Characteristics**

Unless otherwise specified, the following specifications apply for AGND = DGND = DRGND = 0V, V<sub>A</sub> = V<sub>D</sub> = +3.3V, V<sub>DR</sub> = +2.5V, Internal V<sub>REF</sub> = +1.0V, f<sub>CLK</sub> = 65 MHz, f<sub>IN</sub> = 5 KHZ, C<sub>L</sub> = 15 pF/pin. **Boldface limits apply for T<sub>J</sub> = T<sub>MIN</sub> to T<sub>MAX</sub>**: all other limits T<sub>J</sub> = 25°C<sup>(1)(2)(3)(4)</sup>

| Symbol                                  | Parameter   | Conditions                     | Typical <sup>(5)</sup> | Limits <sup>(5)</sup> | Units (Limits) |
|---|---|--------------------------------|------------------------|-----------------------|----------------|
| <b>STATIC CONVERTER CHARACTERISTICS</b> |   |                                |                        |                       |                |
|   | Resolution with No Missing Codes                    |                                |                        | <b>12</b>             | Bits (min)     |
| INL                                     | Integral Non Linearity                              |                                | ±0.7                   | <b>±1.4</b>           | LSB (max)      |
| DNL                                     | Differential Non Linearity                          |                                | ±0.3                   | <b>±0.7</b>           | LSB (max)      |
| PGE                                     | Positive Gain Error                                 |                                | ±1.5                   | <b>±3.5</b>           | %FS (max)      |
| NGE                                     | Negative Gain Error                                 |                                | ±1.1                   | <b>±3.5</b>           | %FS (max)      |
| TC GE                                   | Gain Error Tempco                                   | -40°C ≤ T <sub>A</sub> ≤ +85°C | 7.5                    |                       | ppm/°C         |
| V <sub>OFF</sub>                        | Offset Error (V <sub>IN+</sub> = V <sub>IN-</sub> ) |                                | ±0.06                  | <b>±0.75</b>          | %FS (max)      |
| TC V <sub>OFF</sub>                     | Offset Error Tempco                                 | -40°C ≤ T <sub>A</sub> ≤ +85°C | 4.4                    |                       | ppm/°C         |
|   | Under Range Output Code                             |                                | 0                      | <b>0</b>              |                |
|   | Over Range Output Code                              |                                | 4095                   | <b>4095</b>           |                |

- (1) The inputs are protected as shown below. Input voltage magnitudes above V<sub>A</sub> or below GND will not damage this device, provided current is limited per. However, errors in the A/D conversion can occur if the input goes above V<sub>A</sub> or below GND by more than 100 mV. As an example, if V<sub>A</sub> is +3.3V, the full-scale input voltage must be ≤+3.4V to ensure accurate conversions.

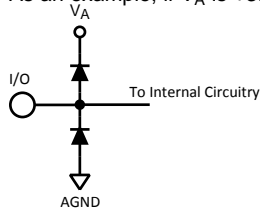

- (2) To ensure accuracy, it is required that |V<sub>A</sub>-V<sub>D</sub>| ≤ 100 mV and separate bypass capacitors are used at each power supply pin.
- (3) With the test condition for V<sub>REF</sub> = +1.0V (2V<sub>P-P</sub> differential input), the 12-bit LSB is 488 μV.
- (4) When the input voltage at any pin exceeds the power supplies (that is, V<sub>IN</sub> < AGND, or V<sub>IN</sub> > V<sub>A</sub>), the current at that pin should be limited to 25 mA. The 50 mA maximum package input current rating limits the number of pins that can safely exceed the power supplies with an input current of 25 mA to two.
- (5) Typical figures are at T<sub>A</sub> = 25°C, and represent most likely parametric norms at the time of product characterization. The typical specifications are not ensured.

## Converter Electrical Characteristics (continued)

Unless otherwise specified, the following specifications apply for AGND = DGND = DRGND = 0V,  $V_A = V_D = +3.3V$ ,  $V_{DR} = +2.5V$ , Internal  $V_{REF} = +1.0V$ ,  $f_{CLK} = 65\text{ MHz}$ ,  $f_{IN} = 5\text{ KHz}$ ,  $C_L = 15\text{ pF/pin}$ . **Boldface limits apply for  $T_J = T_{MIN}$  to  $T_{MAX}$** : all other limits  $T_J = 25^\circ\text{C}^{(1)(2)(3)(4)}$

| Symbol  | Parameter                                     | Conditions  | Typical <sup>(5)</sup> | Limits <sup>(5)</sup> | Units (Limits)   |
|---|---|---|------------------------|-----------------------|------------------|
| <b>REFERENCE AND ANALOG INPUT CHARACTERISTICS</b> |   |   |                        |                       |                  |
| $V_{CM}$  | Common Mode Input Voltage                     |   | 1.5                    | <b>0.5</b>            | V (min)          |
|   |   |   |                        | <b>2.0</b>            | V (max)          |
| $V_{IN}$  | Analog Differential Input Range               |   |                        | <b>2.0</b>            | $V_{P-P}$        |
| $C_{IN}$  | $V_{IN}$ Input Capacitance (each pin to GND)  | $V_{IN} = 2.5\text{ Vdc} + 0.7\text{ V}_{rms}$                    | (CLK LOW)              | 8                     | pF               |
|   |   |   | (CLK HIGH)             | 3                     | pF               |
| $V_{REF}$   | External Reference Voltage <sup>(6)</sup>     |   | 1.00                   | <b>0.8</b>            | V (min)          |
|   |   |   |                        | <b>1</b>              | V (max)          |
|   | Reference Input Resistance                    |   | 1                      |                       | M $\Omega$ (min) |
| <b>DYNAMIC CONVERTER CHARACTERISTICS</b>          |   |   |                        |                       |                  |
| FPBW  | Full Power Bandwidth                          | 0 dBFS Input, Output at -3 dB                                     | 300                    |                       | MHz              |
| SNR   | Signal-to-Noise Ratio <sup>(7)</sup>          | $f_{IN} = 5\text{ MHz}$ , $V_{IN} = -1\text{ dBFS}$               | 69.3                   | <b>68.4</b>           | dBFS (min)       |
|   |   | $f_{IN} = 33\text{ MHz}$ , $V_{IN} = -1\text{ dBFS}$              | 68.5                   |                       | dBFS             |
| SINAD   | Signal-to-Noise and Distortion <sup>(7)</sup> | $f_{IN} = 5\text{ MHz}$ , $V_{IN} = -1\text{ dBFS}$               | 69                     | <b>68</b>             | dBFS (min)       |
|   |   | $f_{IN} = 33\text{ MHz}$ , $V_{IN} = -1\text{ dBFS}$              | 68                     |                       | dBFS             |
| ENOB  | Effective Number of Bits <sup>(7)</sup>       | $f_{IN} = 5\text{ MHz}$ , $V_{IN} = -1\text{ dBFS}$               | 11.2                   | <b>11</b>             | Bits (min)       |
|   |   | $f_{IN} = 33\text{ MHz}$ , $V_{IN} = -1\text{ dBFS}$              | 11                     |                       | Bits             |
| THD   | Total Harmonic Distortion                     | $f_{IN} = 5\text{ MHz}$ , $V_{IN} = -1\text{ dBFS}$               | -82                    | <b>-74.5</b>          | dBc (min)        |
|   |   | $f_{IN} = 33\text{ MHz}$ , $V_{IN} = -1\text{ dBFS}$              | -78                    |                       | dBc              |
| H2  | Second Harmonic Distortion                    | $f_{IN} = 5\text{ MHz}$ , $V_{IN} = -1\text{ dBFS}$               | -92.5                  | <b>-79</b>            | dBc              |
|   |   | $f_{IN} = 33\text{ MHz}$ , $V_{IN} = -1\text{ dBFS}$              | -83                    |                       | dBc              |
| H3  | Third Harmonic Distortion                     | $f_{IN} = 5\text{ MHz}$ , $V_{IN} = -1\text{ dBFS}$               | -83.3                  | <b>-75.5</b>          | dBc              |
|   |   | $f_{IN} = 33\text{ MHz}$ , $V_{IN} = -1\text{ dBFS}$              | -80                    |                       | dBc              |
| SFDR  | Spurious Free Dynamic Range                   | $f_{IN} = 5\text{ MHz}$ , $V_{IN} = -1\text{ dBFS}$               | 83.3                   | <b>75.5</b>           | dBc              |
|   |   | $f_{IN} = 33\text{ MHz}$ , $V_{IN} = -1\text{ dBFS}$              | 80                     |                       | dBc              |
| IMD   | Intermodulation Distortion                    | $f_{IN} = 19.6\text{ MHz}$ and $20.2\text{ MHz}$ , each = -7 dBFS | -78                    |                       | dBFS             |
| FPBW  | Full Power Bandwidth                          |   |                        | 300                   | MHz              |
| <b>INTER-CHANNEL CHARACTERISTICS</b>              |   |   |                        |                       |                  |
|   | Channel—Channel Offset Match                  |   | $\pm 0.3$              |                       | %FS              |
|   | Channel—Channel Gain Match                    |   | $\pm 4$                |                       | %FS              |
|   | Crosstalk (between any two channels)          | 10 MHz Tested, Channel;<br>20 MHz Other Channel                   | 85                     |                       | dBc              |

(6) Optimum performance will be obtained by keeping the reference input in the 0.8V to 1V range. The LM4051CIM3-ADJ (SOT-23 package) is recommended for external reference applications.

(7) This parameter is specified in dBFS - indicating the value that would be attained with a full-scale input signal.

## DC and Logic Electrical Characteristics

Unless otherwise specified, the following specifications apply for AGND = DGND = DRGND = 0V,  $V_A = V_D = +3.3V$ ,  $V_{DR} = +2.5V$ , External  $V_{REF} = +1.0V$ ,  $f_{CLK} = 65\text{ MHz}$ ,  $f_{IN} = 5\text{ MHz}$ ,  $C_L = 15\text{ pF/pin}$ . **Boldface limits apply for  $T_J = T_{MIN}$  to  $T_{MAX}$** : all other limits  $T_J = 25^\circ\text{C}$  <sup>(1)(2)(3)(4)</sup>

| Symbol                               | Parameter  | Conditions  | Typical <sup>(5)</sup> | Limits <sup>(5)</sup> | Units (Limits) |
|--------------------------------------|--|---|------------------------|-----------------------|----------------|
| <b>DIGITAL INPUT CHARACTERISTICS</b> |  |   |                        |                       |                |
| $V_{IN(1)}$                          | Logical "1" Input Voltage                        | $V_D = 3.6V$  |                        | <b>2.0</b>            | V (min)        |
| $V_{IN(0)}$                          | Logical "0" Input Voltage                        | $V_D = 3.0V$  |                        | <b>0.5</b>            | V (max)        |
| $I_{IN(1)}$                          | Logical "1" Input Current                        | $V_{IN} = 3.3V$   | 1                      |                       | $\mu\text{A}$  |
| $I_{IN(0)}$                          | Logical "0" Input Current                        | $V_{IN} = 0V$   | -1                     |                       | $\mu\text{A}$  |
| <b>POWER SUPPLY CHARACTERISTICS</b>  |  |   |                        |                       |                |
| $I_A$                                | Analog Supply Current                            | PD Pin = DGND<br>PD Pin = $V_D$                               | 168<br>0.5             | <b>200</b>            | mA (max)<br>mA |
| $I_D$                                | Digital Supply Current                           | PD Pin = DGND<br>PD Pin = $V_D$                               | 48<br>0.2              | <b>53</b>             | mA (max)<br>mA |
| $I_{DR}$                             | LVDS Output Supply Current                       | PD Pin = DGND, $f_{IN} = 33\text{ MHz}$                       | 46                     | <b>62</b>             | mA (max)       |
| PWR                                  | Total Power Consumption (includes driver supply) | PD Pin = DGND, $C_L = 5\text{ pF}$<br>PD Pin = $V_D$          | 828<br>3               | <b>990</b>            | mW (max)<br>mW |
| PSRR                                 | Power Supply Rejection Ratio                     | Rejection of Full-Scale Error with<br>$V_A = 3.0V$ vs. $3.6V$ | 53                     |                       | dB             |

- (1) The inputs are protected as shown below. Input voltage magnitudes above  $V_A$  or below GND will not damage this device, provided current is limited per. However, errors in the A/D conversion can occur if the input goes above  $V_A$  or below GND by more than 100 mV. As an example, if  $V_A$  is +3.3V, the full-scale input voltage must be  $\leq +3.4V$  to ensure accurate conversions.

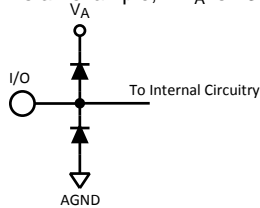

- (2) To ensure accuracy, it is required that  $|V_A - V_D| \leq 100\text{ mV}$  and separate bypass capacitors are used at each power supply pin.
- (3) With the test condition for  $V_{REF} = +1.0V$  ( $2V_{P-P}$  differential input), the 12-bit LSB is  $488\ \mu\text{V}$ .
- (4) When the input voltage at any pin exceeds the power supplies (that is,  $V_{IN} < \text{AGND}$ , or  $V_{IN} > V_A$ ), the current at that pin should be limited to 25 mA. The 50 mA maximum package input current rating limits the number of pins that can safely exceed the power supplies with an input current of 25 mA to two.
- (5) Typical figures are at  $T_A = 25^\circ\text{C}$ , and represent most likely parametric norms at the time of product characterization. The typical specifications are not ensured.



## AC Electrical Characteristics

Unless otherwise specified, the following specifications apply for AGND = DGND = DRGND = 0V,  $V_A = V_D = +3.3V$ ,  $V_{DR} = +2.5V$ , External  $V_{REF} = +1.0V$ ,  $f_{CLK} = 65\text{ MHz}$ ,  $f_{IN} = 5\text{ MHz}$ ,  $C_L = 15\text{ pF/pin}$ . **Boldface limits apply for  $T_J = T_{MIN}$  to  $T_{MAX}$** ; all other limits  $T_J = 25^\circ\text{C}$  (1)(2)(3)(4)

| Symbol      | Parameter                  | Conditions  | Typical <sup>(5)</sup> | Limits <sup>(5)</sup> | Units (Limits) |
|-------------|----------------------------|---|------------------------|-----------------------|----------------|
| $f_{CLK}^1$ | Maximum Clock Frequency    |   |                        | <b>65</b>             | MHz (min)      |
| $f_{CLK}^2$ | Minimum Clock Frequency    |   | 20                     |                       | MHz            |
|             | Clock Duty Cycle           |   | 50                     | 30<br>70              | % min<br>% max |
| $t_{CONV}$  | Conversion Latency         | Input Sample(N) to LSB of Sample(N)<br>Data valid |                        | <b>9</b>              | Clock Cycles   |
| $t_{AD}$    | Aperture Delay             |   | 2                      |                       | ns             |
| $t_{AJ}$    | Aperture Jitter            |   | 1                      |                       | ps rms         |
| $t_{PD}$    | Power Down Mode Exit Cycle |   | <5                     |                       | ms             |

- (1) The inputs are protected as shown below. Input voltage magnitudes above  $V_A$  or below GND will not damage this device, provided current is limited per. However, errors in the A/D conversion can occur if the input goes above  $V_A$  or below GND by more than 100 mV. As an example, if  $V_A$  is +3.3V, the full-scale input voltage must be  $\leq +3.4V$  to ensure accurate conversions.

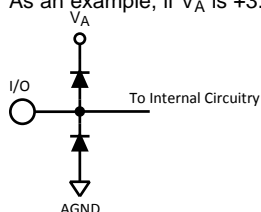

- (2) To ensure accuracy, it is required that  $|V_A - V_D| \leq 100\text{ mV}$  and separate bypass capacitors are used at each power supply pin.
- (3) With the test condition for  $V_{REF} = +1.0V$  ( $2V_{P-P}$  differential input), the 12-bit LSB is 488  $\mu\text{V}$ .
- (4) When the input voltage at any pin exceeds the power supplies (that is,  $V_{IN} < \text{AGND}$ , or  $V_{IN} > V_A$ ), the current at that pin should be limited to 25 mA. The 50 mA maximum package input current rating limits the number of pins that can safely exceed the power supplies with an input current of 25 mA to two.
- (5) Typical figures are at  $T_A = 25^\circ\text{C}$ , and represent most likely parametric norms at the time of product characterization. The typical specifications are not ensured.

### LVDS Electrical Characteristics

Unless otherwise specified, the following specifications apply for AGND = DGND = DRGND = 0V,  $V_A = V_D = +3.3V$ ,  $V_{DR} = +2.5V$ , External  $V_{REF} = +1.0V$ ,  $f_{CLK} = 65\text{ MHz}$ ,  $f_{IN} = 5\text{ MHz}$ ,  $C_L = 15\text{ pF/pin}$ . **Boldface limits apply for  $T_J = T_{MIN}$  to  $T_{MAX}$** : all other limits  $T_J = 25^\circ\text{C}$  <sup>(1)(2)(3)(4)</sup>

| Symbol  | Parameter                                  | Conditions                                       | Typical <sup>(5)</sup> | Limits <sup>(5)</sup> | Units (Limits)       |
|---|--|--|------------------------|-----------------------|----------------------|
| <b>LVDS DC CHARACTERISTICS</b>                          |  |  |                        |                       |                      |
| $V_{OD}$  | Output Differential Voltage (DO+) - (DO-)  | $R_L = 100\Omega$                                | 290                    | 230<br>450            | mV (min)<br>mV (max) |
| $\Delta V_{OD}$   | Output Differential Voltage Unbalance      | $R_L = 100\Omega$                                | $\pm 1$                | $\pm 15$              | mV (max)             |
| $V_{OS}$  | Offset Voltage                             | $R_L = 100\Omega$                                | 1.25                   | 1.125<br>1.375        | V (min)<br>V (max)   |
| $\Delta V_{OS}$   | Offset Voltage Unbalance                   | $R_L = 100\Omega$                                | $\pm 7$                | $\pm 25$              | mV (max)             |
| IOS   | Output Short Circuit Current               | DO = 0V, $V_{IN} = 1.1V$                         | -10                    |                       | mA (max)             |
| <b>LVDS OUTPUT TIMING AND SWITCHING CHARACTERISTICS</b> |  |  |                        |                       |                      |
| $t_{OCP}$   | Output Clock Period                        | 50% to 50%                                       | 2.56                   |                       | ns                   |
| $t_{OCD}$   | Output Clock Duty Cycle                    | See <sup>(6)</sup>                               | 50                     | 35<br>65              | % (min)<br>% (max)   |
| $t_H$   | Data Edge to Output Clock Edge Hold Time   | 50% to 50% <sup>(6)</sup>                        | 625                    | 300                   | ps                   |
| $t_S$   | Data Edge to Output Clock Edge Set-Up Time | 50% to 50% <sup>(6)</sup>                        | 600                    | 300                   | ps                   |
| $t_{FP}$  | Frame Period                               | 50% to 50%                                       | 15.38                  |                       | ns                   |
| $t_{FDC}$   | Frame Clock Duty Cycle                     | See <sup>(6)</sup>                               | 50                     | 45<br>55              | % (min)<br>% (max)   |
| $t_{DFS}$   | Data Edge to Frame Edge Skew               | 50% to 50%                                       | 60                     | 160                   | ps (max)             |
| $t_R, t_F$  | LVDS Rise/Fall Time                        | $C_L = 5\text{pF}$ to GND, $R_{OUT} = 100\Omega$ | 360                    | 700                   | ps (max)             |
| $t_{PLD}$   | Serializer PLL Lock Time                   |  | 50                     |                       | $\mu\text{s}$        |
| $t_{SD}$  | Serializer Delay                           | $R_L = 100\Omega$                                | 2.76                   |                       | ns                   |

- (1) The inputs are protected as shown below. Input voltage magnitudes above  $V_A$  or below GND will not damage this device, provided current is limited per. However, errors in the A/D conversion can occur if the input goes above  $V_A$  or below GND by more than 100 mV. As an example, if  $V_A$  is +3.3V, the full-scale input voltage must be  $\leq +3.4V$  to ensure accurate conversions.

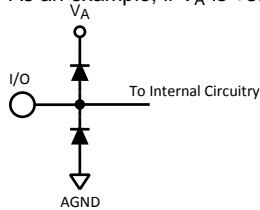

- (2) To ensure accuracy, it is required that  $|V_A - V_D| \leq 100\text{ mV}$  and separate bypass capacitors are used at each power supply pin.  
 (3) With the test condition for  $V_{REF} = +1.0V$  (2V<sub>P-P</sub> differential input), the 12-bit LSB is 488  $\mu\text{V}$ .  
 (4) When the input voltage at any pin exceeds the power supplies (that is,  $V_{IN} < \text{AGND}$ , or  $V_{IN} > V_A$ ), the current at that pin should be limited to 25 mA. The 50 mA maximum package input current rating limits the number of pins that can safely exceed the power supplies with an input current of 25 mA to two.  
 (5) Typical figures are at  $T_A = 25^\circ\text{C}$ , and represent most likely parametric norms at the time of product characterization. The typical specifications are not ensured.  
 (6) This parameter is ensured by design and/or qualification and is not tested in production.

## Specification Definitions

**APERTURE DELAY** is the time after the rising edge of the clock to when the input signal is acquired or held for conversion.

**APERTURE JITTER (APERTURE UNCERTAINTY)** is the variation in aperture delay from sample to sample. Aperture jitter manifests itself as noise in the output.

**CLOCK DUTY CYCLE** is the ratio of the time during one cycle that a repetitive digital waveform is high to the total time of one period. The specification here refers to the ADC clock input signal.

**COMMON MODE VOLTAGE ( $V_{CM}$ )** is the common d.c. voltage applied to both input terminals of the ADC.

**CONVERSION LATENCY** is the number of clock cycles between initiation of conversion and when that data is presented to the output driver stage. Data for any given sample is available at the output pins the Pipeline Delay plus the Output Delay after the sample is taken. New data is available at every clock cycle, but the data lags the conversion by the pipeline delay.

**CROSSTALK** is coupling of energy from one channel into the other channel.

**DIFFERENTIAL NON-LINEARITY (DNL)** is the measure of the maximum deviation from the ideal step size of 1 LSB.

**EFFECTIVE NUMBER OF BITS (ENOB, or EFFECTIVE BITS)** is another method of specifying Signal-to-Noise and Distortion or SINAD. ENOB is defined as  $(\text{SINAD} - 1.76) / 6.02$  and says that the converter is equivalent to a perfect ADC of this (ENOB) number of bits.

**FULL POWER BANDWIDTH** is a measure of the frequency at which the reconstructed output fundamental drops 3 dB below its low frequency value for a full scale input.

**GAIN ERROR** is the deviation from the ideal slope of the transfer function. It can be calculated as:

$$\text{Gain Error} = \text{Positive Full Scale Error} - \text{Negative Full Scale Error} \quad (1)$$

Gain Error can also be separated into Positive Gain Error and Negative Gain Error, which are:

$$\text{PGE} = \text{Positive Full Scale Error} - \text{Offset Error} \quad (2)$$

$$\text{NGE} = \text{Offset Error} - \text{Negative Full Scale Error} \quad (3)$$

**GAIN ERROR MATCHING** is the difference in gain errors between the two converters divided by the average gain of the converters.

**INTEGRAL NON LINEARITY (INL)** is a measure of the deviation of each individual code from a line drawn from negative full scale ( $\frac{1}{2}$  LSB below the first code transition) through positive full scale ( $\frac{1}{2}$  LSB above the last code transition). The deviation of any given code from this straight line is measured from the center of that code value.

**INTERMODULATION DISTORTION (IMD)** is the creation of additional spectral components as a result of two sinusoidal frequencies being applied to the ADC input at the same time. It is defined as the ratio of the power in the intermodulation products to the total power in the original frequencies. IMD is usually expressed in dBFS.

**LSB (LEAST SIGNIFICANT BIT)** is the bit that has the smallest value or weight of all bits. This value is  $V_{REF}/2^n$ , where “n” is the ADC resolution in bits, which is 12 in the case of the ADC12QS065.

**LVDS Differential Output Voltage ( $V_{OD}$ )** is the absolute value of the difference between the differential output pair voltages ( $V_{D+}$  and  $V_{D-}$ ), each measured with respect to ground.

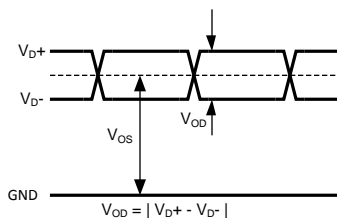

(4)

**LVDS Output Offset Voltage ( $V_{OS}$ )** is the midpoint between the differential output pair voltages.

**MISSING CODES** are those output codes that will never appear at the ADC outputs. The ADC12QS065 is ensured not to have any missing codes.

**MSB (MOST SIGNIFICANT BIT)** is the bit that has the largest value or weight. Its value is one half of full scale.

**NEGATIVE FULL SCALE ERROR** is the difference between the actual first code transition and its ideal value of ½ LSB above negative full scale.

**OFFSET ERROR** is the difference between the two input voltages  $[(V_{IN+}) - (V_{IN-})]$  required to cause a transition from code 2047 to 2048.

**OUTPUT DELAY** is the time delay after the rising edge of the clock before the data update is presented at the output pins.

**OVER RANGE RECOVERY TIME** is the time required after  $V_{IN}$  goes from a specified voltage out of the normal input range to a specified voltage within the normal input range and the converter makes a conversion with its rated accuracy.

**PIPELINE DELAY (LATENCY)** See CONVERSION LATENCY.

**POSITIVE FULL SCALE ERROR** is the difference between the actual last code transition and its ideal value of 1½ LSB below positive full scale.

**POWER SUPPLY REJECTION RATIO (PSRR)** is a measure of how well the ADC rejects a change in the power supply voltage. For the ADC12QS065, PSRR is the ratio of the change in Full-Scale Error that results from a change in the d.c. power supply voltage, expressed in dB.

**SIGNAL TO NOISE RATIO (SNR)** is the ratio, expressed in dB, of the rms value of the input signal to the rms value of the sum of all other spectral components below one-half the sampling frequency, not including harmonics or d.c.

**SIGNAL TO NOISE PLUS DISTORTION (S/N+D or SINAD)** Is the ratio, expressed in dB, of the rms value of the input signal to the rms value of all of the other spectral components below half the clock frequency, including harmonics but excluding d.c.

**SPURIOUS FREE DYNAMIC RANGE (SFDR)** is the difference, expressed in dB, between the desired signal amplitude to the amplitude of the peak spurious spectral component, where a spurious spectral component is any signal present in the output spectrum that is not present at the input and may or may not be a harmonic.

**TOTAL HARMONIC DISTORTION (THD)** is the ratio, expressed in dB, of the rms total of the first nine harmonic levels at the output to the level of the fundamental at the output. THD is calculated as

$$\text{THD} = 20 \times \log \sqrt{\frac{A_{f_2}^2 + \dots + A_{f_{10}}^2}{A_{f_1}^2}} \quad (5)$$

where  $f_1$  is the RMS power of the fundamental (output) frequency and  $f_2$  through  $f_{10}$  are the RMS power of the first 9 harmonic frequencies in the output spectrum.

**SECOND HARMONIC DISTORTION (2ND HARM)** is the difference expressed in dB, between the RMS power in the input frequency at the output and the power in its 2nd harmonic level at the output.

**THIRD HARMONIC DISTORTION (3RD HARM)** is the difference, expressed in dB, between the RMS power in the input frequency at the output and the power in its 3rd harmonic level at the output.

### Timing Diagram

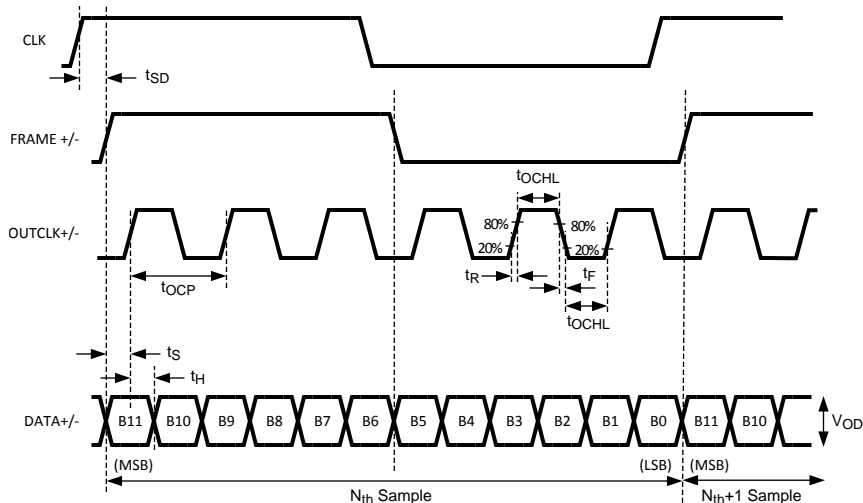

Figure 2. LVDS Output Timing

### Transfer Characteristic

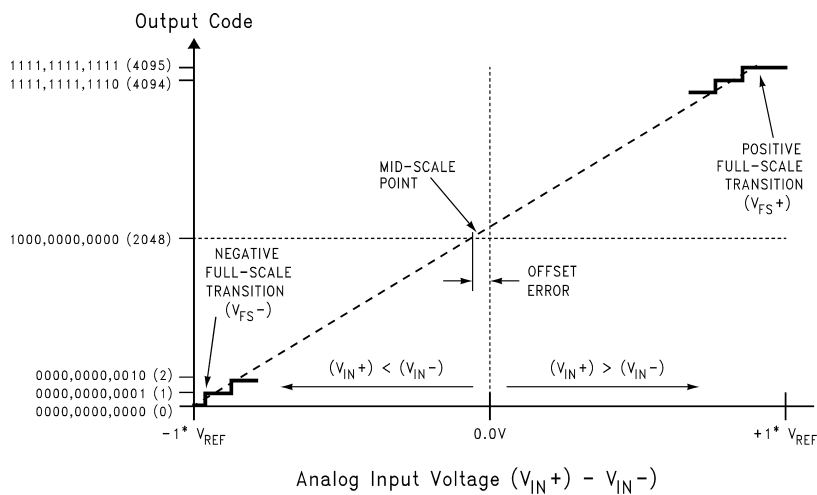

Figure 3. Transfer Characteristic

### Typical Performance Characteristics DNL, INL

Unless otherwise specified, the following specifications apply for AGND = DGND = DRGND = 0V,  $V_A = V_D = +3.3V$ ,  $V_{DR} = +2.5V$ , Internal  $V_{REF} = +1.0V$ ,  $f_{CLK} = 65\text{ MHz}$ ,  $f_{IN} = 5\text{ KHz}$ ,  $C_L = 15\text{ pF/pin}$ .

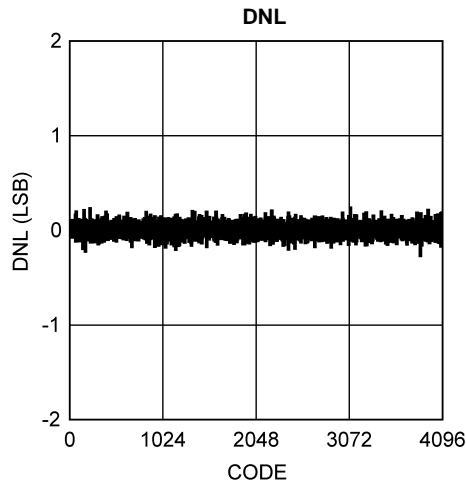

Figure 4.

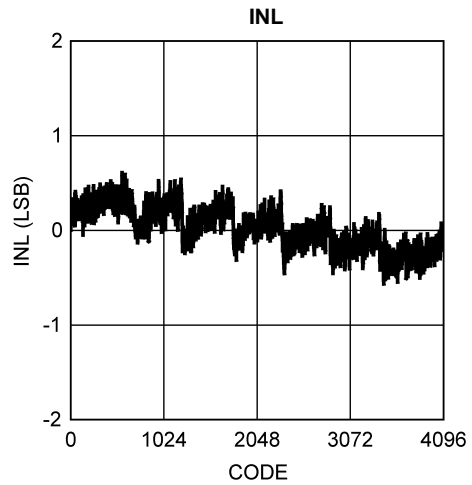

Figure 5.

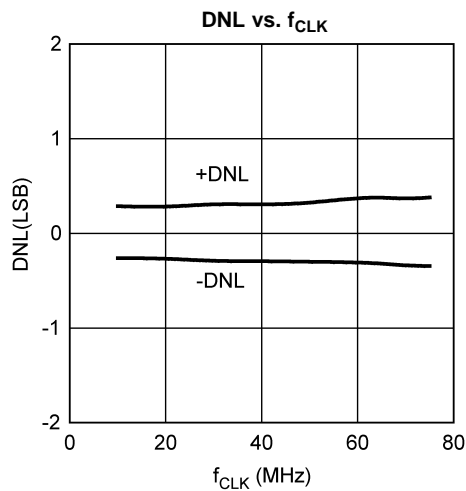

Figure 6.

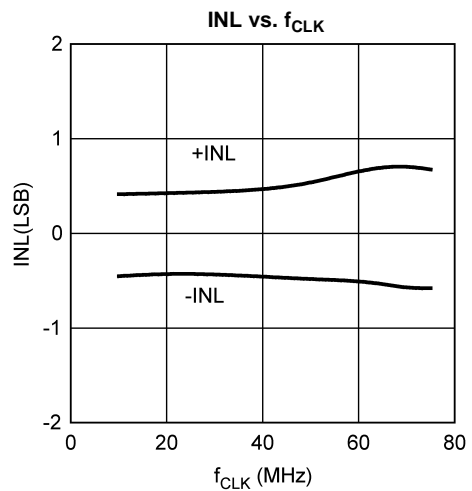

Figure 7.

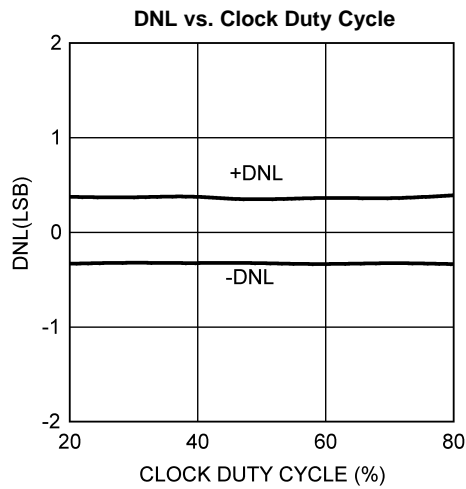

Figure 8.

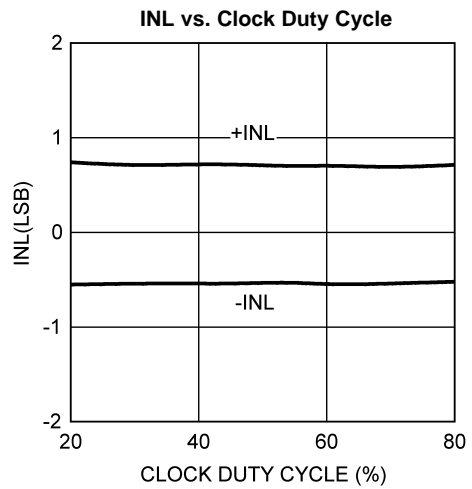

Figure 9.

**Typical Performance Characteristics DNL, INL (continued)**

Unless otherwise specified, the following specifications apply for AGND = DGND = DRGND = 0V,  $V_A = V_D = +3.3V$ ,  $V_{DR} = +2.5V$ , Internal  $V_{REF} = +1.0V$ ,  $f_{CLK} = 65\text{ MHz}$ ,  $f_{IN} = 5\text{ KHz}$ ,  $C_L = 15\text{ pF/pin}$ .

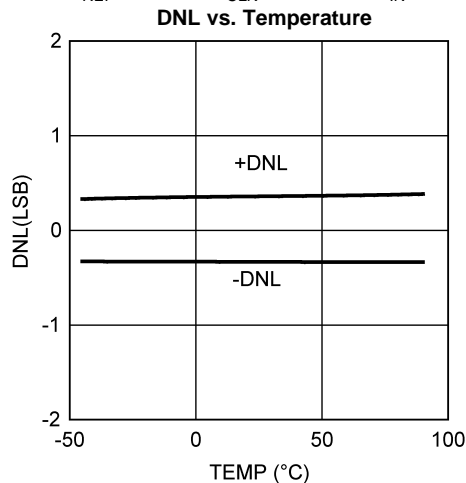

Figure 10.

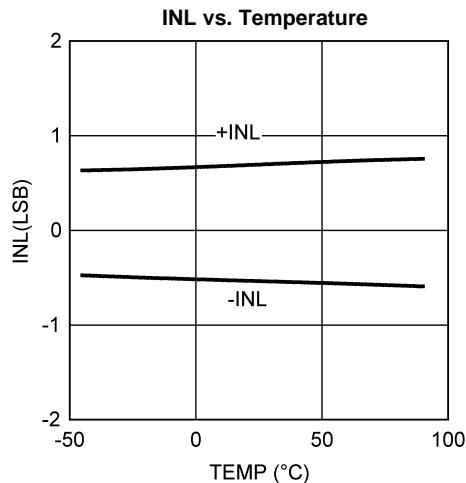

Figure 11.

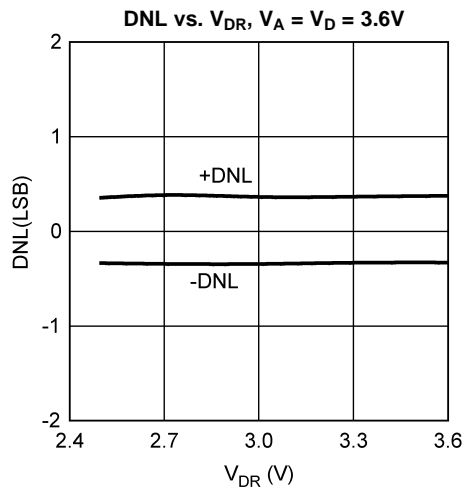

Figure 12.

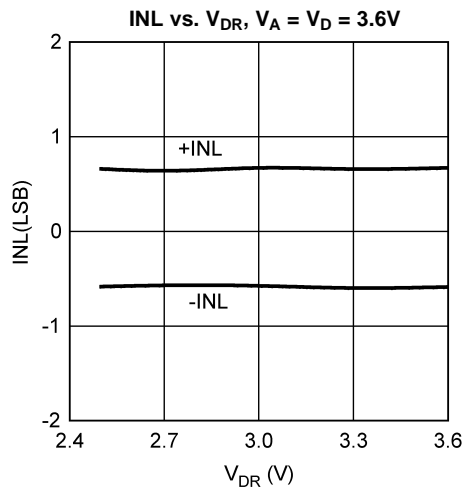

Figure 13.

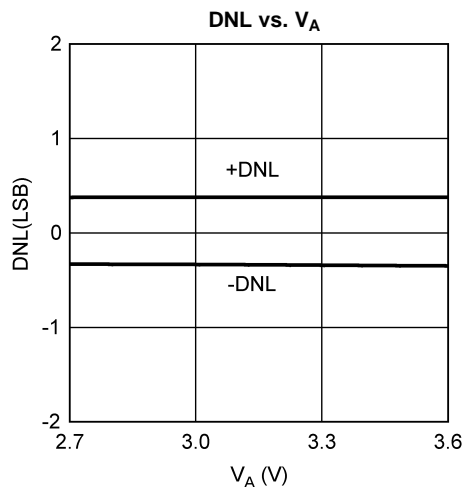

Figure 14.

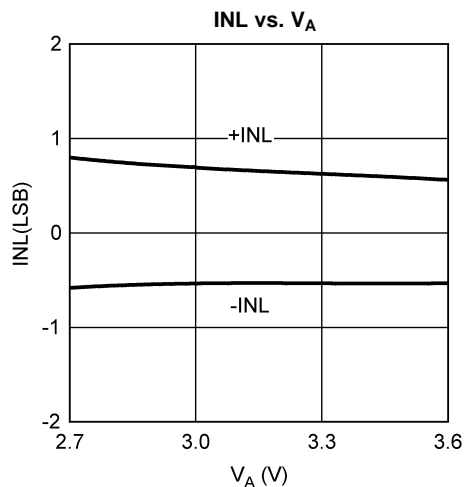

Figure 15.

### Typical Performance Characteristics

Unless otherwise specified, the following specifications apply for AGND = DGND = DR GND = 0V,  $V_A = V_D = +3.3V$ ,  $V_{DR} = +2.5V$ ,  $V_{PD} = 0V$ , External  $V_{REF} = +1.0V$ ,  $f_{CLK} = 65$  MHz,  $f_{IN} = 5$  MHz,  $C_L = 15$  pF/pin. Units for SNR and SINAD are dBFS. Units for SFDR and Distortion are dBc.

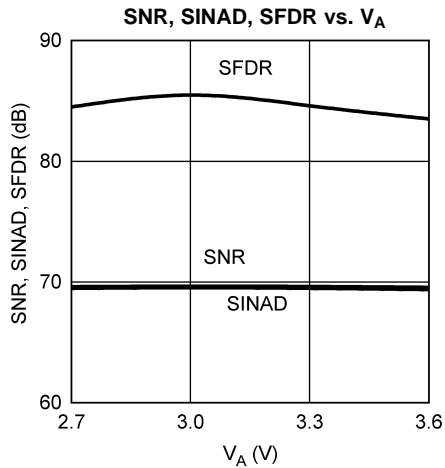

Figure 16.

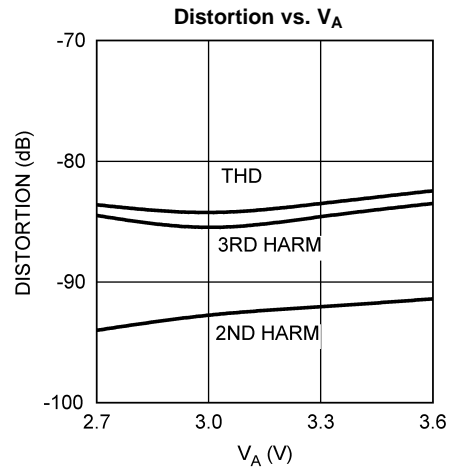

Figure 17.

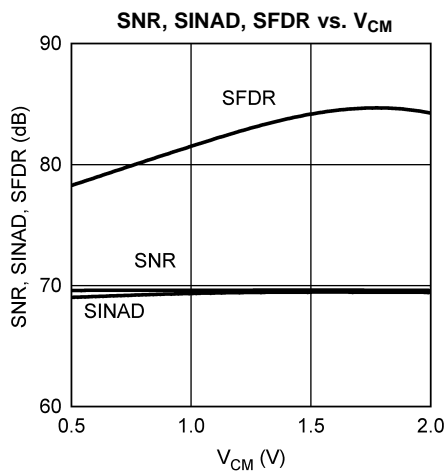

Figure 18.

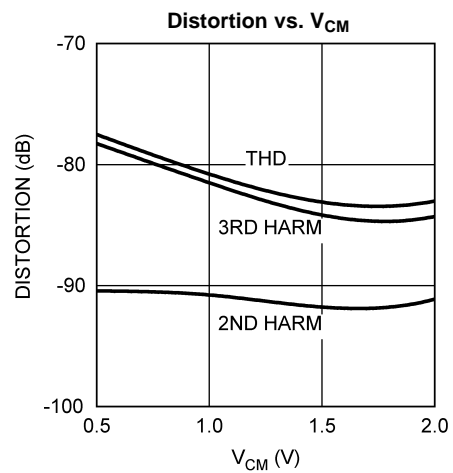

Figure 19.

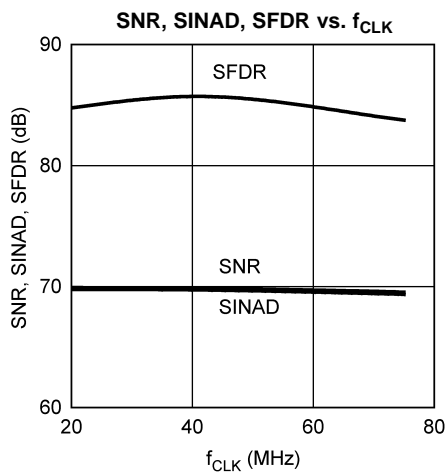

Figure 20.

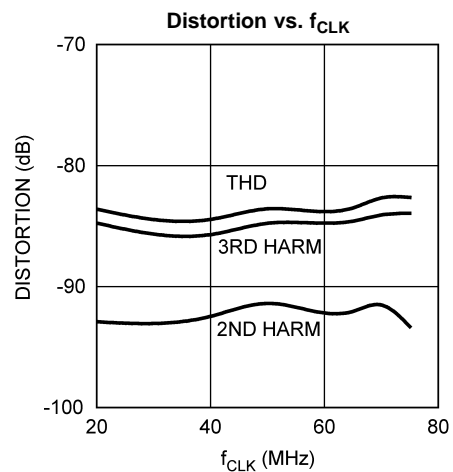

Figure 21.



**Typical Performance Characteristics (continued)**

Unless otherwise specified, the following specifications apply for AGND = DGND = DR GND = 0V,  $V_A = V_D = +3.3V$ ,  $V_{DR} = +2.5V$ , PD = 0V, External  $V_{REF} = +1.0V$ ,  $f_{CLK} = 65\text{ MHz}$ ,  $f_{IN} = 5\text{ MHz}$ ,  $C_L = 15\text{ pF/pin}$ . Units for SNR and SINAD are dBFS. Units for SFDR and Distortion are dBc.

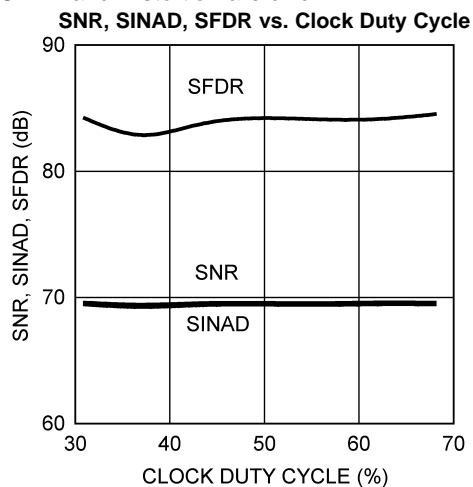

Figure 22.

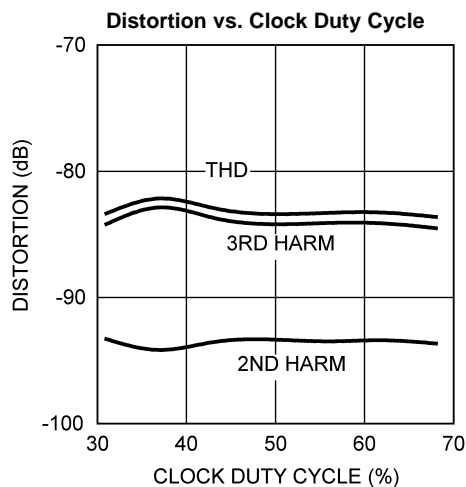

Figure 23.

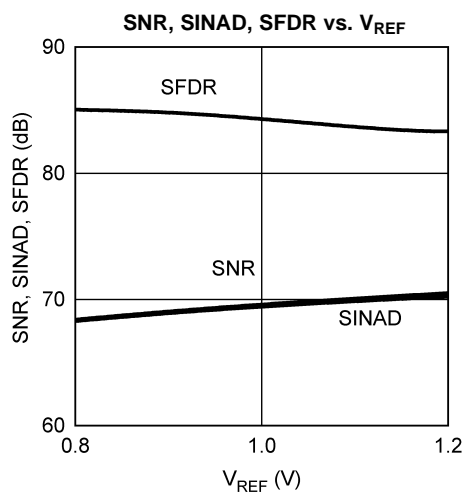

Figure 24.

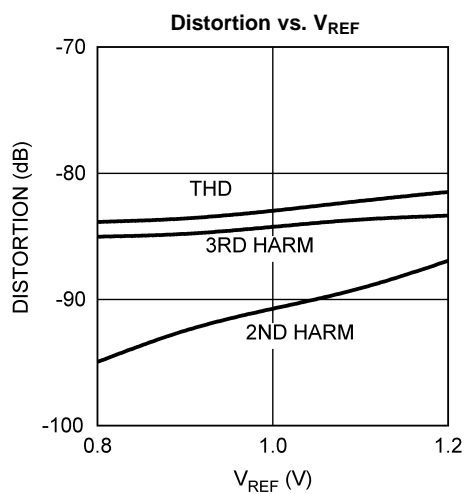

Figure 25.

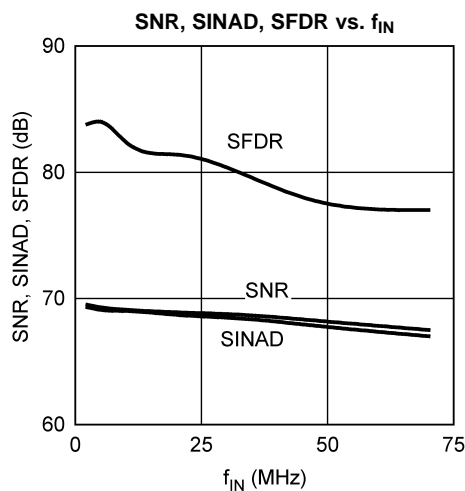

Figure 26.

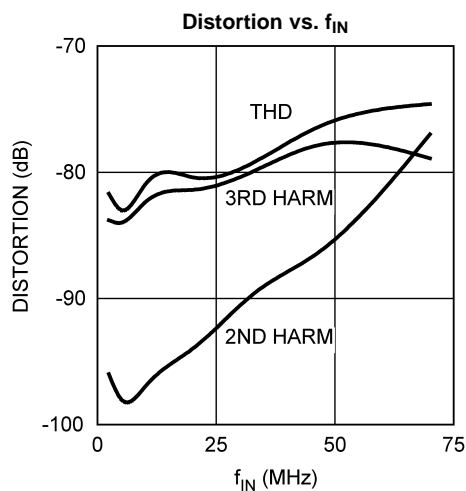

Figure 27.

**Typical Performance Characteristics (continued)**

Unless otherwise specified, the following specifications apply for AGND = DGND = DR GND = 0V,  $V_A = V_D = +3.3V$ ,  $V_{DR} = +2.5V$ , PD = 0V, External  $V_{REF} = +1.0V$ ,  $f_{CLK} = 65\text{ MHz}$ ,  $f_{IN} = 5\text{ MHz}$ ,  $C_L = 15\text{ pF/pin}$ . Units for SNR and SINAD are dBFS. Units for SFDR and Distortion are dBc.

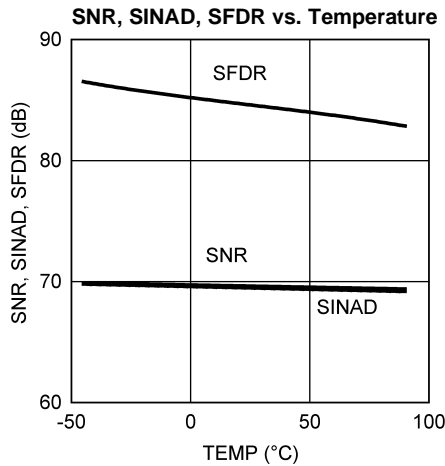

Figure 28.

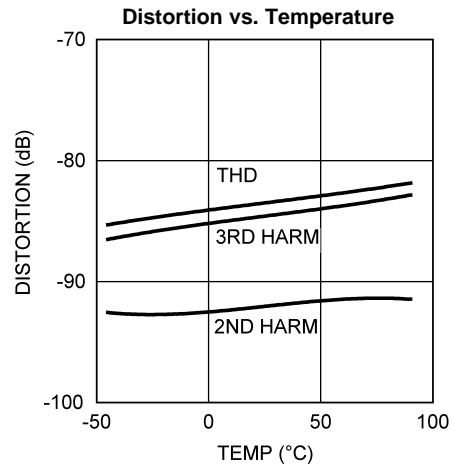

Figure 29.

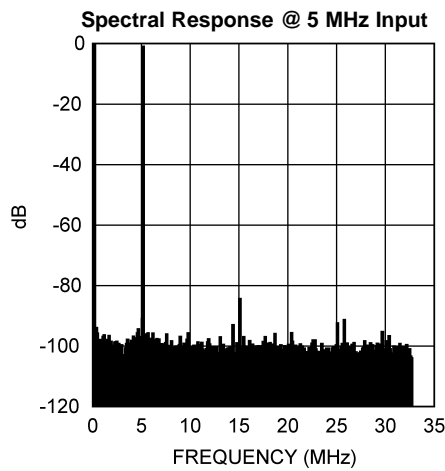

Figure 30.

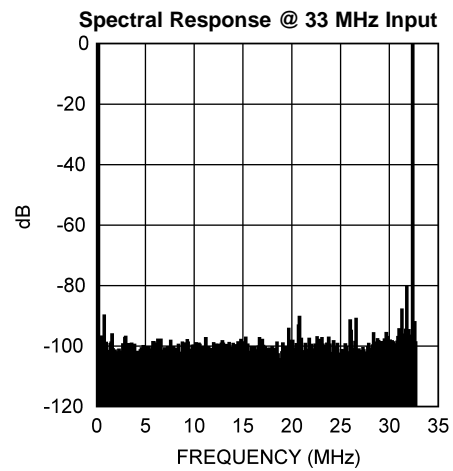

Figure 31.

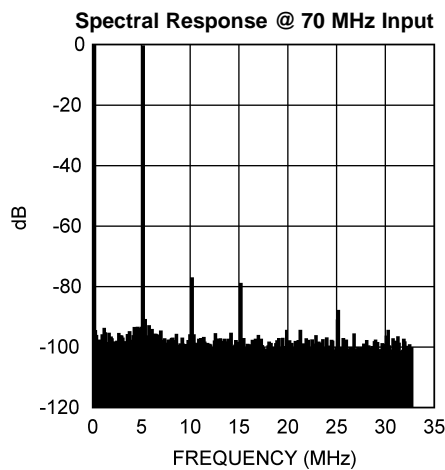

Figure 32.

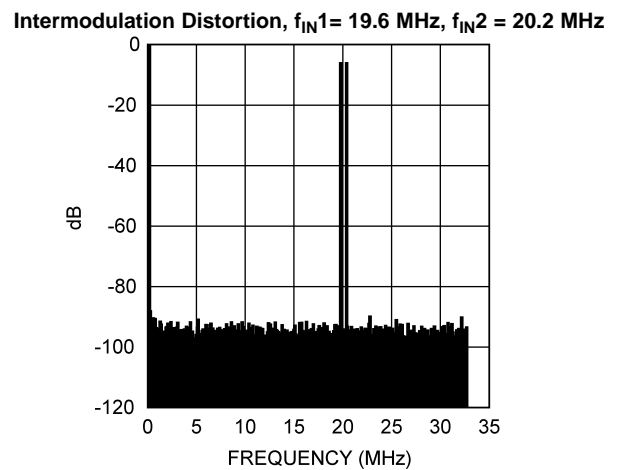

Figure 33.

## FUNCTIONAL DESCRIPTION

Operating on a single +3.3V supply, the ADC12QS065 uses a pipeline architecture and has error correction circuitry to help ensure maximum performance. The differential analog input signal is digitized to 12 bits. The user has the choice of using an internal 1.0 Volt or 0.5 Volt stable reference, or using an external reference. Any external reference is buffered on-chip to ease the task of driving that pin.

Sampled data is transformed into high speed serial output LVDS data streams. Clock and frame LVDS pairs aid in data capture. The ADC12QS065's six differential pairs transmit data over backplanes or cable and also make PCB design easier.

The output word rate is the same as the clock frequency, which can be between 20 MSPS and 65 MSPS (typical) with fully specified performance at 65 MSPS. The analog input for all channels are acquired at the rising edge of the clock and the digital data for a given sample is delayed by the pipeline for 9 clock cycles.

## APPLICATIONS INFORMATION

### OPERATING CONDITIONS

We recommend that the following conditions be observed for operation of the ADC12QS065:

$$3.0V \leq V_A \leq 3.6V$$

$$V_D = V_A$$

$$V_{DR} = 2.5V$$

$$20 \text{ MHz} \leq f_{CLK} \leq 65 \text{ MHz}$$

$$0.8V \leq V_{REF} \leq 1V \text{ (for an external reference)}$$

$$0.5V \leq V_{CM} \leq 2.0V$$

### ANALOG INPUTS

There is one reference input pin,  $V_{REF}$ , which is used to select an internal reference, or to supply an external reference. The ADC12QS065 has four analog signal input pairs,  $V_{IN} 1+$  and  $V_{IN} 1-$ ,  $V_{IN} 2+$  and  $V_{IN} 2-$ ,  $V_{IN} 3+$  and  $V_{IN} 3-$ ,  $V_{IN} 4+$  and  $V_{IN} 4-$ . Each pair of pins forms a differential input pair. There is a VREG pin for decoupling the internal 1.8V regulator.

#### Reference Pins

The ADC12QS065 is designed to operate with an internal 1.0V or 0.5V reference, or an external 1.0V reference, but performs well with external reference voltages in the range of 0.8V to 1V. Lower reference voltages will decrease the signal-to-noise ratio (SNR) of the ADC12QS065. Increasing the reference voltage (and the input signal swing) beyond 1V may degrade THD for a full-scale input, especially at higher input frequencies.

It is important that all grounds associated with the reference voltage and the analog input signal make connection to the ground plane at a single, quiet point to minimize the effects of noise currents in the ground path.

The six Reference Bypass Pins (VREFT12, VREFB12, VCOM12, VREFT34, VREFB34 and VCOM34) are made available for bypass purposes. All these pins should each be bypassed to ground with a 0.1  $\mu$ F capacitor. A 10  $\mu$ F capacitor should be placed between the VREFT12 and VREFB12 pins and between the VREFT34 and VREFB34 pins, as shown in [Figure 36](#). This configuration is necessary to avoid reference oscillation, which could result in reduced SFDR and/or SNR.

Smaller capacitor values than those specified will allow faster recovery from the power down mode, but may result in degraded noise performance.

The VCOM pins may be loaded to 1 mA. The remaining reference bypass pins should not be loaded.

The nominal voltages for the reference bypass pins are as follows:

$$V_{COM} = 1.5 \text{ V}$$

$$V_{REFT} = V_{COM} + V_{REF} / 2$$

$$V_{REFB} = V_{COM} - V_{REF} / 2$$

User choice of an on-chip or external reference voltage is provided. When INTREF is high, the  $V_{REF}$  pin selects the internal reference voltage. The internal 1.0 Volt reference is in use when the the  $V_{REF}$  pin is connected to  $V_A$ . When the  $V_{REF}$  pin is connected to AGND, the internal 0.5 Volt reference is in use. When INTREF is low, a voltage in the range of 0.8V to 1V is applied to the  $V_{REF}$  pin and that is used for the voltage reference. When an external reference is used, the  $V_{REF}$  pin should be bypassed to ground with a 0.1  $\mu\text{F}$  capacitor close to the reference input pin. There is no need to bypass the  $V_{REF}$  pin when the internal reference is used.

### Signal Inputs

The ADC12QS065 has 4 input channels. They are labelled  $V_{IN} 1+$  and  $V_{IN} 1-$ ,  $V_{IN} 2+$  and  $V_{IN} 2-$ ,  $V_{IN} 3+$  and  $V_{IN} 3-$ ,  $V_{IN} 4+$  and  $V_{IN} 4-$ . The input signal,  $V_{IN}$ , is defined as

$$V_{IN} = (V_{IN+}) - (V_{IN-}) \quad (6)$$

Figure 34 shows the expected input signal range. Note that the common mode input voltage,  $V_{CM}$ , should be in the range of 0.5V to 2.0V with a typical value of 1.5V.

The peaks of the individual input signals should each never exceed 2.6V to maintain THD and SINAD performance.

The ADC12QS065 performs best with a differential input signal with each input centered around a common mode voltage,  $V_{CM}$ . The peak-to-peak voltage swing at each analog input pin should not exceed the value of the reference voltage or the output data will be clipped.

The two input signals should be exactly 180° out of phase from each other and of the same amplitude. For single frequency inputs, angular errors result in a reduction of the effective full scale input. For complex waveforms, however, angular errors will result in distortion.

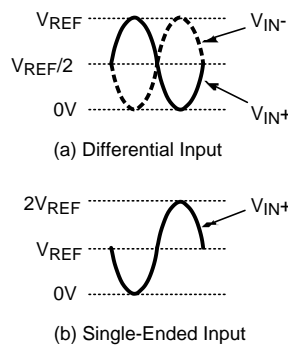

**Figure 34. Expected Input Signal Range**

For single frequency sine waves the full scale error in LSB can be described as approximately

$$E_{FS} = 4096 (1 - \sin(90^\circ + \text{dev}))$$

where

- dev is the angular difference in degrees between the two signals having a 180° relative phase relationship to each other (see Figure 35). (7)

Drive the analog inputs with a source impedance less than 100 $\Omega$ .

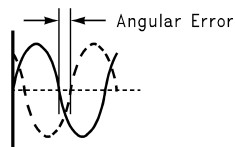

**Figure 35. Angular Errors Between the Two Input Signals Will Reduce the Output Level or Cause Distortion**

For differential operation, each analog input pin of the differential pair should have a peak-to-peak voltage just below the reference voltage,  $V_{REF}$ , be 180 degrees out of phase with each other and be centered around  $V_{CM}$ .

### Single-Ended Operation

Performance with differential input signals is better than with single-ended signals. For this reason, single-ended operation is not recommended. However, if single ended-operation is required and the resulting performance degradation is acceptable, one of the analog inputs should be connected to the d.c. mid point voltage of the driven input. The peak-to-peak differential input signal at the driven input pin should be twice the reference voltage to maximize SNR and SINAD performance (Figure 34). For example, set  $V_{REF}$  to 0.5V, bias  $V_{IN-}$  to 1.0V and drive  $V_{IN+}$  with a signal range of 0.5V to 1.5V.

Because very large input signal swings can degrade distortion performance, better performance with a single-ended input can be obtained by reducing the reference voltage when maintaining a full-range output. Table 1 and Table 2 indicate the input to output relationship of the ADC12QS065.

**Table 1. Input to Output Relationship – Differential Input**

| $V_{IN+}$              | $V_{IN-}$              | Binary Output  |
|------------------------|------------------------|----------------|
| $V_{CM} - V_{REF} / 2$ | $V_{CM} + V_{REF} / 2$ | 0000 0000 0000 |
| $V_{CM} - V_{REF} / 4$ | $V_{CM} + V_{REF} / 4$ | 0100 0000 0000 |
| $V_{CM}$               | $V_{CM}$               | 1000 0000 0000 |
| $V_{CM} + V_{REF} / 4$ | $V_{CM} - V_{REF} / 4$ | 1100 0000 0000 |
| $V_{CM} + V_{REF} / 2$ | $V_{CM} - V_{REF} / 2$ | 1111 1111 1111 |

**Table 2. Input to Output Relationship – Single-Ended Input**

| $V_{IN+}$              | $V_{IN-}$ | Binary Output  |
|------------------------|-----------|----------------|
| $V_{CM} - V_{REF}$     | $V_{CM}$  | 0000 0000 0000 |
| $V_{CM} - V_{REF} / 2$ | $V_{CM}$  | 0100 0000 0000 |
| $V_{CM}$               | $V_{CM}$  | 1000 0000 0000 |
| $V_{CM} + V_{REF} / 2$ | $V_{CM}$  | 1100 0000 0000 |
| $V_{CM} + V_{REF}$     | $V_{CM}$  | 1111 1111 1111 |

### Driving the Analog Inputs

The  $V_{IN+}$  and the  $V_{IN-}$  inputs of the ADC12QS065 consist of an analog switch followed by a switched-capacitor amplifier. As the internal sampling switch opens and closes, current pulses occur at the analog input pins, resulting in voltage spikes at the signal input pins. As a driving source attempts to counteract these voltage spikes, it may add noise to the signal at the ADC analog input. To help isolate the pulses at the ADC input from the amplifier output, use RCs at the inputs, as can be seen in Figure 36 and Figure 37. These components should be placed close to the ADC inputs because the input pins of the ADC is the most sensitive part of the system and this is the last opportunity to filter that input.

For Nyquist applications the RC pole should be at the ADC sample rate. The ADC input capacitance in the sample mode should be considered when setting the RC pole. For wideband undersampling applications, the RC pole should be set at about 1.5 to 2 times the maximum input frequency to maintain a linear delay response.

### Input Common Mode Voltage

The input common mode voltage,  $V_{CM}$ , should be in the range of 0.5V to 2.0V and be a value such that the peak excursions of the analog signal does not go more negative than ground or more positive than 2.6V. The nominal  $V_{CM}$  should generally be about 1.5V. VCOM12 or VCOM34 can be used as a  $V_{CM}$  source.

### Internal Regulator

The ADC12QS065 has an internal 1.8V regulator. The VREG pin (pin 29) should be bypassed to AGND with a 1.0  $\mu$ F capacitor.

## DIGITAL INPUTS

Digital TTL/CMOS compatible inputs consist of CLK, PD, REFPD, and INTREF.

### CLK

The **CLK** signal controls the timing of the sampling process. Drive the clock input with a stable, low jitter clock signal in the range of 20 MHz to 65 MHz. The trace carrying the clock signal should be as short as possible and should not cross any other signal line, analog or digital, not even at 90°.

The **CLK** signal also drives an internal state machine. If the **CLK** is interrupted, or its frequency too low, the charge on internal capacitors can dissipate to the point where the accuracy of the output data will degrade. This is what limits the minimum sample rate.

The ADC12QS065 can operate with a CMOS or LVDS clock signal.

For a CMOS clock, connect CLKB (pin 48) to AGND and apply the clock signal to CLK (pin 47.) The clock line should be terminated at its source in the characteristic impedance of that line. Take care to maintain a constant clock line impedance throughout the length of the line. Refer to Application Note AN-905 ([SNLA035](#)) for information on setting characteristic impedance. It is highly desirable that the the source driving the ADC **CLK** pin only drive that pin. However, if that source is used to drive other things, each driven pin should be a.c. terminated with a series RC to ground, such that the resistor value is equal to the characteristic impedance of the clock line and the capacitor value is

$$C \geq \frac{4 \times t_{PD} \times L}{Z_0}$$

where

- $t_{PD}$  is the signal propagation rate down the clock line
  - "L" is the line length
  - $Z_0$  is the characteristic impedance of the clock line
- (8)

This termination should be as close as possible to the ADC clock pin but beyond it as seen from the clock source. Typical  $t_{PD}$  is about 150 ps/inch (60 ps/cm) on FR-4 board material. The units of "L" and  $t_{PD}$  should be the same (inches or centimeters).

For an LVDS clock, drive the CLK and CLKB pins with an ac-coupled differential clock signal. The pair should be terminated with a 100 $\Omega$  resistor near the pins.

### PD

The PD pin, when high, holds the ADC12QS065 in a power-down mode to conserve power when the converter is not being used. The power consumption in this state is 3 mW with a 65MHz clock.. The output data pins are undefined and the data in the pipeline is corrupted while in the power down mode.

The Power Down Mode Exit Cycle time is determined by the value of the components on the reference bypass pins 55-57, and 20-22, and is as listed in the Electrical Tables with the recommended components on the VREFT, VREFB and VCOM reference bypass pins. These capacitors loose their charge in the Power Down mode and must be recharged by on-chip circuitry before conversions can be accurate. Smaller capacitor values allow slightly faster recovery from the power down mode, but can result in a reduction in SNR, SINAD and ENOB performance.

## REFPD

When high, the REFPD pin will power down the internal reference. With REFPD high, user must drive VREFT12, VREFT34 and VREFB12 & VREFB34 externally. With REFPD low, VREFT12, VREFT34, VREFB12 and VREFB34 are driven internally.

## INTREF

When INTREF is connected to  $V_D$ , two internal reference choices are selectable through the  $V_{REF}$  pin (pin 23). When INTREF is connected to DGND, an external reference must be applied to  $V_{REF}$ . (See [Reference Pins](#)).

## OUTPUTS

The ADC12QS065 has four Low Voltage Differential Signaling (LVDS) Data Output pairs. Valid data is present at these outputs while the PD pin is low. The OUTCLK and FRAME pins aid in data capture.

LVDS signals provide a high level of immunity to common mode noise. The differential data signals consist of two 350mVpp (typical) signals that are 180 degrees out of phase. The PCB traces for these signals should be treated as transmission lines. Each signal pair should have closely coupled traces designed with 100Ω differential impedance and should be terminated with a 100Ω resistor near the receiver.

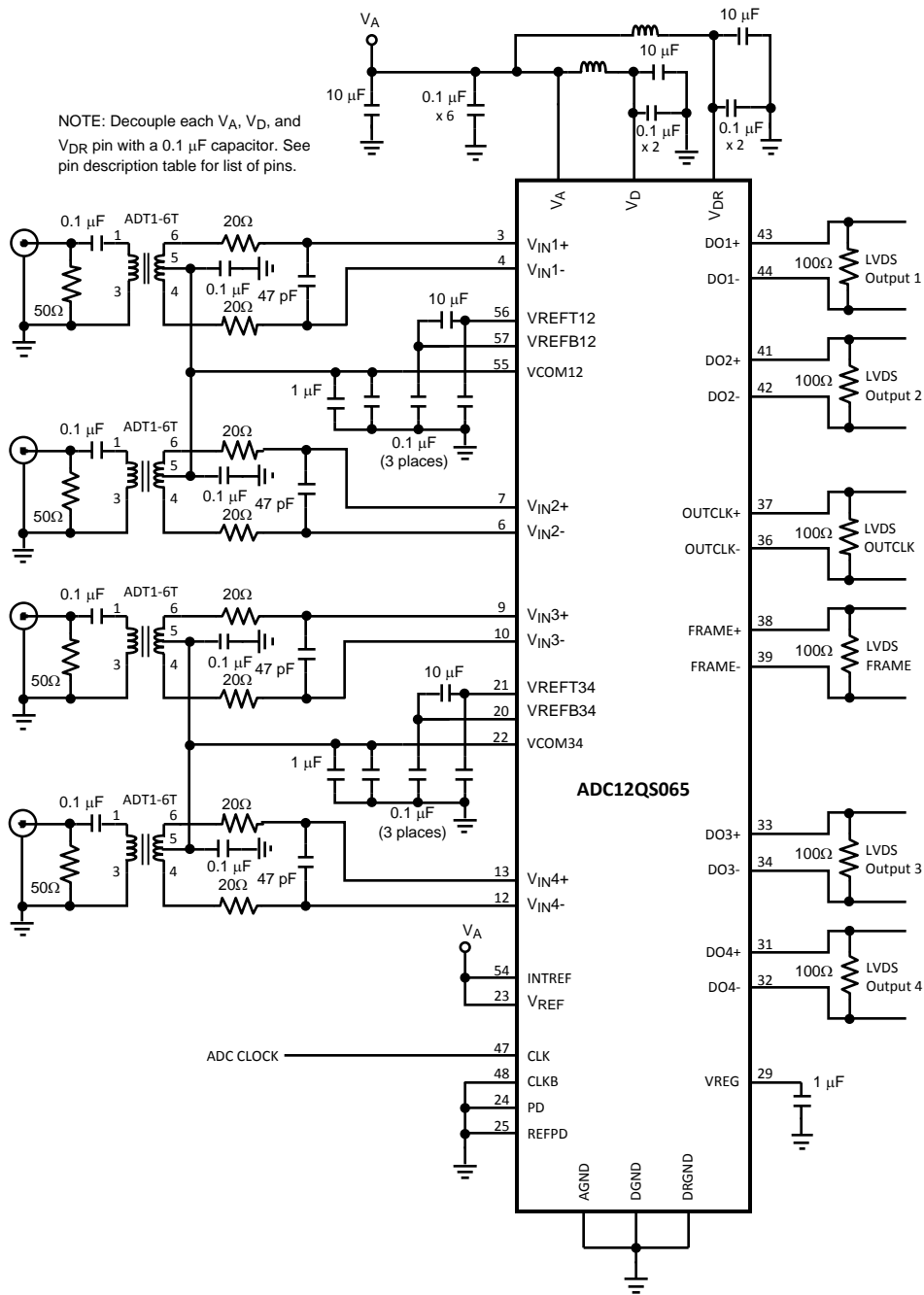

Figure 36. Application Circuit using Transformer Drive Circuit



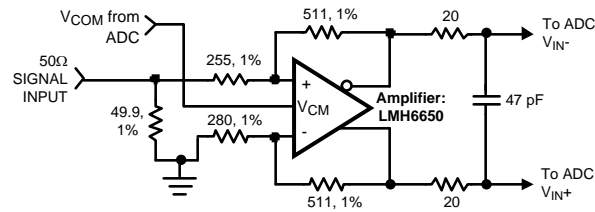

Figure 37. Differential Op-Amp Drive Circuit of Figure 36

## POWER SUPPLY CONSIDERATIONS

The power supply pins should be bypassed with a 10  $\mu\text{F}$  capacitor and with a 0.1  $\mu\text{F}$  ceramic chip capacitor close to each power pin. Leadless chip capacitors are preferred because they have low series inductance.

As is the case with all high-speed converters, the ADC12QS065 is sensitive to power supply noise. Accordingly, the noise on the analog supply pin should be kept below 100 mV<sub>P-P</sub>.

No pin should ever have a voltage on it that is in excess of the supply voltages, not even on a transient basis. Be especially careful of this during power turn on and turn off.

## LAYOUT AND GROUNDING

Proper grounding and proper routing of all signals are essential to ensure accurate conversion. Maintaining separate analog and digital areas of the board, with the ADC12QS065 between these areas, is required to achieve specified performance.

The package of the ADC12QS065 has an exposed pad on its back that provides the primary heat removal path as well as electrical grounding to the printed circuit board. The exposed pad must be attached to the board to remove the maximum amount of heat from the package, as well as to ensure best product parametric performance.

To maximize the removal of heat from the package, a thermal land pattern must be incorporated on the PCB board within the footprint of the package. The land pattern for this exposed pad should be at least as large as the exposed pad of the package and be located such that the exposed pad of the device is entirely over that thermal land pattern. This thermal land pattern should be electrically connected to ground.

To minimize junction temperature, it is recommended that a simple heat sink be built into the PCB. This is done by including a copper area on the opposite side of the PCB. This copper area may be plated or solder coated to prevent corrosion, but should not have a conformal coating, which could provide some thermal insulation. Thermal vias should be used to connect these top and bottom copper areas. These thermal vias act as "heat pipes" to carry the thermal energy from the device side of the board to the opposite side of the board where it can be more effectively dissipated. The use of 9 to 16 thermal vias is recommended. The thermal vias should be placed on a 1.2 mm grid spacing and have a diameter of 0.30 to 0.33 mm. These vias should be barrel plated to avoid solder wicking into the vias during the soldering process.

The ground return for the data outputs (DRGND) carries the ground current for the output drivers. The output current can exhibit high transients that could add noise to the conversion process. To prevent this from happening, the DRGND pins should NOT be connected to system ground in close proximity to any of the ADC12QS065's other ground pins.

Capacitive coupling between the typically noisy digital circuitry and the sensitive analog circuitry can lead to poor performance. The solution is to keep the analog circuitry separated from the digital circuitry, and to keep the clock line as short as possible.

The LVDS output pairs should be routed with a 100 $\Omega$  differential impedance trace, and should be terminated at the receiver with a 100 $\Omega$  resistor.

Since digital switching transients are composed largely of high frequency components, total ground plane copper weight will have little effect upon the logic-generated noise. This is because of the skin effect. Total surface area is more important than is total ground plane volume.

Generally, analog and digital lines should cross each other at 90° to avoid crosstalk. To maximize accuracy in high speed, high resolution systems, however, avoid crossing analog and digital lines altogether. It is important to keep clock lines as short as possible and isolated from ALL other lines, including other digital lines. Even the generally accepted 90° crossing should be avoided with the clock line as even a little coupling can cause problems at high frequencies. This is because other lines can introduce jitter into the clock line, which can lead to degradation of SNR. Also, the high speed clock can introduce noise into the analog chain.

Best performance at high frequencies and at high resolution is obtained with a straight signal path. That is, the signal path through all components should form a straight line wherever possible.

Be especially careful with the layout of inductors. Mutual inductance can change the characteristics of the circuit in which they are used. Inductors should *not* be placed side by side, even with just a small part of their bodies beside each other.

The analog input should be isolated from noisy signal traces to avoid coupling of spurious signals into the input. Any external component (e.g., a filter capacitor) connected between the converter's input pins and ground or to the reference input pin and ground should be connected to a very clean point in the ground plane. Traces for the input channels should be routed away from each other as much as possible, with Ground plane between channels, to help minimize crosstalk.

## DYNAMIC PERFORMANCE

To achieve the best dynamic performance, the clock source driving the CLK input must be free of jitter. Isolate the ADC clock from any digital circuitry with buffers, as with the clock tree shown in [Figure 38](#). The gates used in the clock tree must be capable of operating at frequencies much higher than those used if added jitter is to be prevented.

Best performance will be obtained with a differential input drive, compared with a single-ended drive, as discussed in [Single-Ended Operation](#) and [Driving the Analog Inputs](#).

As mentioned in the [CLK](#) section, it is good practice to keep the ADC clock line as short as possible and to keep it well away from any other signals. Other signals can introduce jitter into the clock signal, which can lead to reduced SNR performance, and the clock can introduce noise into other lines. Even lines with 90° crossings have capacitive coupling, so try to avoid even these 90° crossings of the clock line.

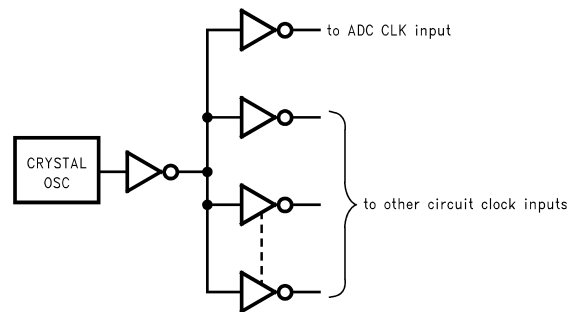

**Figure 38. Isolating the ADC Clock from other Circuitry with a Clock Tree**

## COMMON APPLICATION PITFALLS

**Driving the inputs (analog or digital) beyond the power supply rails.** For proper operation, all inputs should not go more than 100 mV beyond the supply rails (more than 100 mV below the ground pins or 100 mV above the supply pins). Exceeding these limits on even a transient basis may cause faulty or erratic operation. It is not uncommon for high speed digital components (e.g., 74F and 74AC devices) to exhibit overshoot or undershoot that goes above the power supply or below ground. A resistor of about 47Ω to 100Ω in series with any offending digital input, close to the signal source, will eliminate the problem.

Do not allow input voltages to exceed the supply voltage, even on a transient basis. Not even during power up or power down.

Be careful not to overdrive the inputs of the ADC12QS065 with a device that is powered from supplies outside the range of the ADC12QS065 supply. Such practice may lead to conversion inaccuracies and even to device damage.

**Using an inadequate amplifier to drive the analog input.** As explained, the capacitance seen at the input alternates between two values depending upon the phase of the clock. This dynamic load is more difficult to drive than is a fixed capacitance.

If the amplifier exhibits overshoot, ringing, or any evidence of instability, even at a very low level, it will degrade performance. A small series resistor at each amplifier output and a capacitor at the analog inputs (as shown in [Figure 36](#) and [Figure 37](#)) will improve performance. The LMH6550 is an example of an amplifier that may be used to drive the analog inputs of the ADC12QS065.

Also, it is important that the signals at the two inputs have exactly the same amplitude and be exactly 180° out of phase with each other. Board layout, especially equality of the length of the two traces to the input pins, will affect the effective phase between these two signals. Remember that an operational amplifier operated in the non-inverting configuration will exhibit more time delay than will the same device operating in the inverting configuration.

**Operating with the reference pins outside of the specified range.** As mentioned,  $V_{REF}$  should be in the range of

$$0.8V \leq V_{REF} \leq 1V \quad (9)$$

Operating outside of these limits could lead to performance degradation.

**Inadequate network on Reference Bypass pins (VREFT12, VREFB12, VCOM12, VREFT34, VREFB34 and VCOM34).** These pins should be bypassed as mentioned in [Reference Pins](#) for best performance.

**Using a clock source with excessive jitter, using excessively long clock signal trace, or having other signals coupled to the clock signal trace.** This will cause the sampling interval to vary, causing excessive output noise and a reduction in SNR and SINAD performance.

---

## REVISION HISTORY

| Changes from Revision H (April 2013) to Revision I         | Page               |
|--|--------------------|
| • Changed layout of National Data Sheet to TI format ..... | <a href="#">27</a> |

---

**PACKAGING INFORMATION**

| Orderable Device    | Status<br>(1) | Package Type | Package Drawing | Pins | Package Qty | Eco Plan<br>(2) | Lead finish/<br>Ball material<br>(6) | MSL Peak Temp<br>(3) | Op Temp (°C) | Device Marking<br>(4/5) | Samples |
|---------------------|---------------|--------------|-----------------|------|-------------|-----------------|--------------------------------------|----------------------|--------------|-------------------------|---------|
| ADC12QS065CISQ/NOPB | ACTIVE        | WQFN         | NKA             | 60   | 250         | RoHS & Green    | SN                                   | Level-3-260C-168 HR  | -40 to 85    | 12QS065<br>CISQ         | Samples |

(1) The marketing status values are defined as follows:

**ACTIVE:** Product device recommended for new designs.

**LIFEBUY:** TI has announced that the device will be discontinued, and a lifetime-buy period is in effect.

**NRND:** Not recommended for new designs. Device is in production to support existing customers, but TI does not recommend using this part in a new design.

**PREVIEW:** Device has been announced but is not in production. Samples may or may not be available.

**OBSELETE:** TI has discontinued the production of the device.

(2) **RoHS:** TI defines "RoHS" to mean semiconductor products that are compliant with the current EU RoHS requirements for all 10 RoHS substances, including the requirement that RoHS substance do not exceed 0.1% by weight in homogeneous materials. Where designed to be soldered at high temperatures, "RoHS" products are suitable for use in specified lead-free processes. TI may reference these types of products as "Pb-Free".

**RoHS Exempt:** TI defines "RoHS Exempt" to mean products that contain lead but are compliant with EU RoHS pursuant to a specific EU RoHS exemption.

**Green:** TI defines "Green" to mean the content of Chlorine (Cl) and Bromine (Br) based flame retardants meet JS709B low halogen requirements of <=1000ppm threshold. Antimony trioxide based flame retardants must also meet the <=1000ppm threshold requirement.

(3) MSL, Peak Temp. - The Moisture Sensitivity Level rating according to the JEDEC industry standard classifications, and peak solder temperature.

(4) There may be additional marking, which relates to the logo, the lot trace code information, or the environmental category on the device.

(5) Multiple Device Markings will be inside parentheses. Only one Device Marking contained in parentheses and separated by a "-" will appear on a device. If a line is indented then it is a continuation of the previous line and the two combined represent the entire Device Marking for that device.

(6) Lead finish/Ball material - Orderable Devices may have multiple material finish options. Finish options are separated by a vertical ruled line. Lead finish/Ball material values may wrap to two lines if the finish value exceeds the maximum column width.

**Important Information and Disclaimer:**The information provided on this page represents TI's knowledge and belief as of the date that it is provided. TI bases its knowledge and belief on information provided by third parties, and makes no representation or warranty as to the accuracy of such information. Efforts are underway to better integrate information from third parties. TI has taken and continues to take reasonable steps to provide representative and accurate information but may not have conducted destructive testing or chemical analysis on incoming materials and chemicals. TI and TI suppliers consider certain information to be proprietary, and thus CAS numbers and other limited information may not be available for release.

In no event shall TI's liability arising out of such information exceed the total purchase price of the TI part(s) at issue in this document sold by TI to Customer on an annual basis.

**TAPE AND REEL INFORMATION**

**QUADRANT ASSIGNMENTS FOR PIN 1 ORIENTATION IN TAPE**

\*All dimensions are nominal

| Device              | Package Type | Package Drawing | Pins | SPQ | Reel Diameter (mm) | Reel Width W1 (mm) | A0 (mm) | B0 (mm) | K0 (mm) | P1 (mm) | W (mm) | Pin1 Quadrant |
|---------------------|--------------|-----------------|------|-----|--------------------|--------------------|---------|---------|---------|---------|--------|---------------|
| ADC12QS065CISQ/NOPB | WQFN         | NKA             | 60   | 250 | 178.0              | 16.4               | 9.3     | 9.3     | 1.3     | 12.0    | 16.0   | Q1            |

**TAPE AND REEL BOX DIMENSIONS**



\*All dimensions are nominal

| Device              | Package Type | Package Drawing | Pins | SPQ | Length (mm) | Width (mm) | Height (mm) |
|---------------------|--------------|-----------------|------|-----|-------------|------------|-------------|
| ADC12QS065CISQ/NOPB | WQFN         | NKA             | 60   | 250 | 208.0       | 191.0      | 35.0        |

NKA0060A

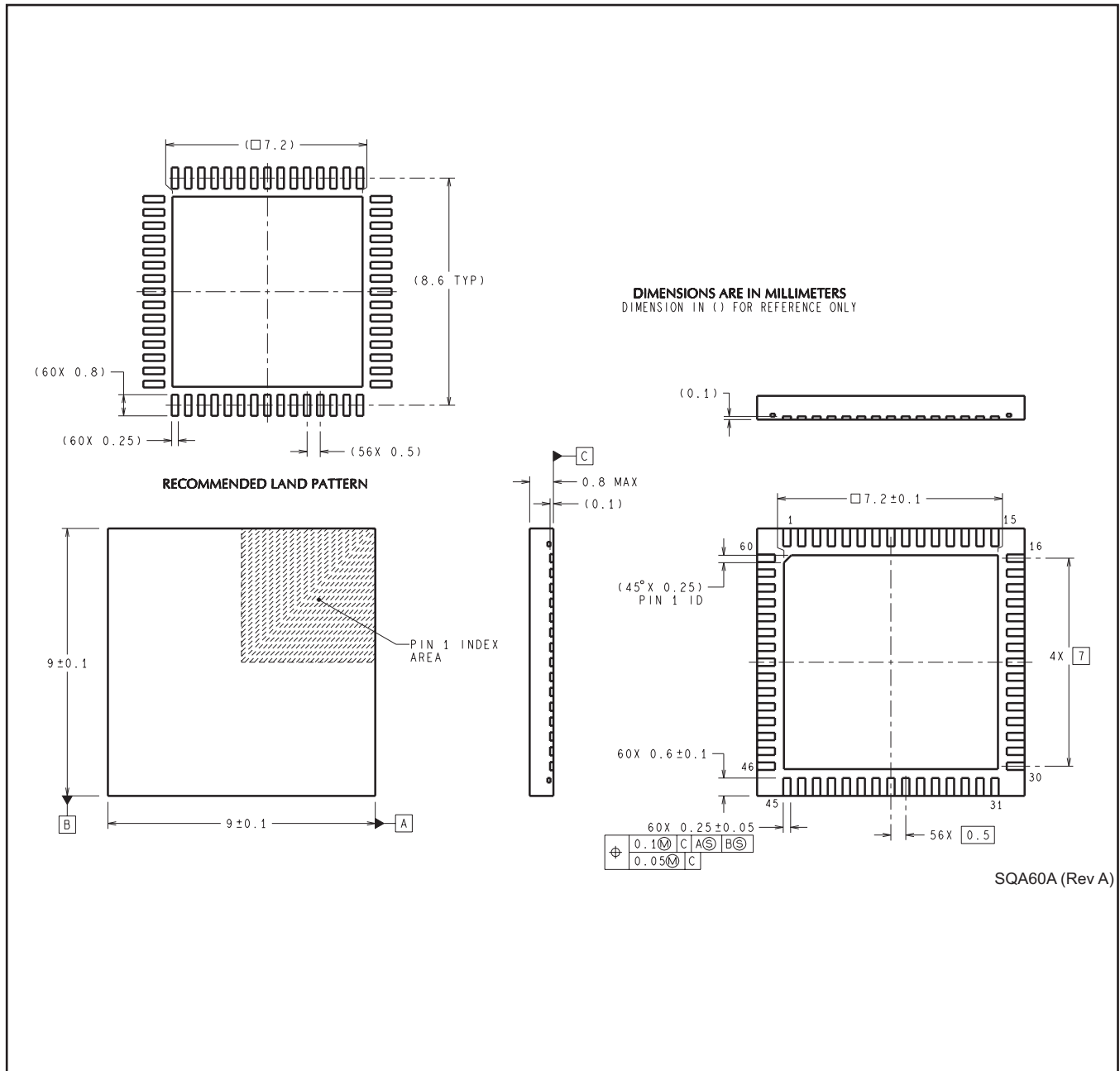

SQA60A (Rev A)



## IMPORTANT NOTICE AND DISCLAIMER

TI PROVIDES TECHNICAL AND RELIABILITY DATA (INCLUDING DATA SHEETS), DESIGN RESOURCES (INCLUDING REFERENCE DESIGNS), APPLICATION OR OTHER DESIGN ADVICE, WEB TOOLS, SAFETY INFORMATION, AND OTHER RESOURCES "AS IS" AND WITH ALL FAULTS, AND DISCLAIMS ALL WARRANTIES, EXPRESS AND IMPLIED, INCLUDING WITHOUT LIMITATION ANY IMPLIED WARRANTIES OF MERCHANTABILITY, FITNESS FOR A PARTICULAR PURPOSE OR NON-INFRINGEMENT OF THIRD PARTY INTELLECTUAL PROPERTY RIGHTS.

These resources are intended for skilled developers designing with TI products. You are solely responsible for (1) selecting the appropriate TI products for your application, (2) designing, validating and testing your application, and (3) ensuring your application meets applicable standards, and any other safety, security, regulatory or other requirements.

These resources are subject to change without notice. TI grants you permission to use these resources only for development of an application that uses the TI products described in the resource. Other reproduction and display of these resources is prohibited. No license is granted to any other TI intellectual property right or to any third party intellectual property right. TI disclaims responsibility for, and you will fully indemnify TI and its representatives against, any claims, damages, costs, losses, and liabilities arising out of your use of these resources.

TI's products are provided subject to [TI's Terms of Sale](#) or other applicable terms available either on [ti.com](https://www.ti.com) or provided in conjunction with such TI products. TI's provision of these resources does not expand or otherwise alter TI's applicable warranties or warranty disclaimers for TI products.

TI objects to and rejects any additional or different terms you may have proposed.

Mailing Address: Texas Instruments, Post Office Box 655303, Dallas, Texas 75265  
Copyright © 2024, Texas Instruments Incorporated