

CSD25310Q2 20 V P-Channel NexFET™ Power MOSFETs

1 Features

- Ultra-Low Q_g and Q_{gd}
- Low On Resistance
- Low Thermal Resistance
- Pb-Free
- RoHS Compliant
- Halogen Free
- SON 2-mm x 2-mm Plastic Package

2 Applications

- Battery Management
- Load Management
- Battery Protection

3 Description

This 19.9 m Ω , –20 V P-Channel device is designed to deliver the lowest on resistance and gate charge in the smallest outline possible with excellent thermal characteristics in an ultra-low profile. Its low on resistance coupled with an extremely small footprint in a SON 2 mm x 2 mm plastic package make the device ideal for battery operated space constrained operations.

Top View

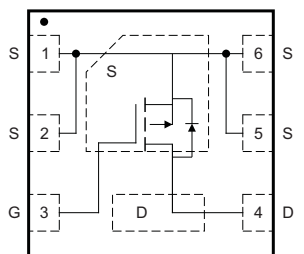

P0112-01

$R_{DS(on)}$ vs V_{GS}

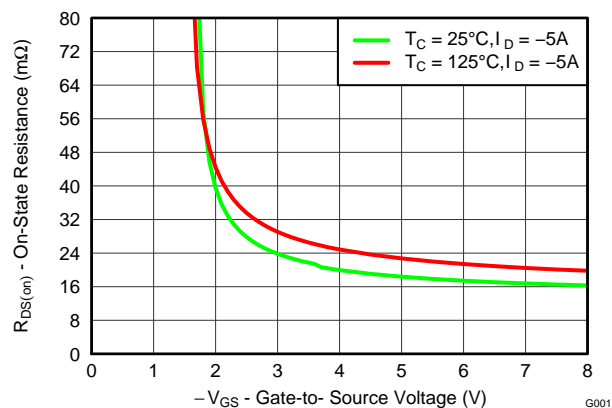

G001

Gate Charge

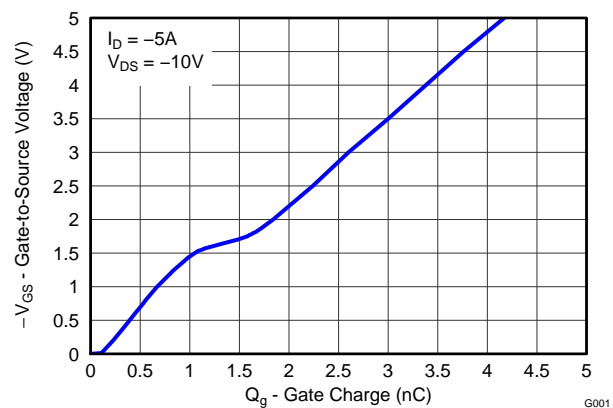

G001

Product Summary

$T_A = 25^\circ\text{C}$		TYPICAL VALUE		UNIT
V_{DS}	Drain-to-Source Voltage	–20		V
Q_g	Gate Charge Total (–4.5 V)	3.6		nC
Q_{gd}	Gate Charge Gate to Drain	0.5		nC
$R_{DS(on)}$	Drain-to-Source On Resistance	$V_{GS} = -1.8\text{ V}$	59.0	m Ω
		$V_{GS} = -2.5\text{ V}$	27.0	m Ω
		$V_{GS} = -4.5\text{ V}$	19.9	m Ω
$V_{GS(th)}$	Threshold Voltage	–0.85		V

Ordering Information⁽¹⁾

Device	Media	Qty	Package	Ship
CSD25310Q2	7-Inch Reel	3000	SON 2 x 2 mm Plastic Package	Tape and Reel
CSD25310Q2T	7-Inch Reel	250		

(1) For all available packages, see the orderable addendum at the end of the data sheet.

Absolute Maximum Ratings

$T_A = 25^\circ\text{C}$		VALUE	UNIT
V_{DS}	Drain-to-Source Voltage	–20	V
V_{GS}	Gate-to-Source Voltage	± 8	V
I_D	Continuous Drain Current (Package Limit)	–20	A
	Continuous Drain Current ⁽¹⁾	–9.6	A
I_{DM}	Pulsed Drain Current ⁽²⁾	48	A
P_D	Power Dissipation ⁽¹⁾	2.9	W
$T_{J, stg}$	Operating Junction and Storage Temperature Range	–55 to 150	$^\circ\text{C}$

(1) $R_{\theta JA} = 43^\circ\text{C/W}$ on 1 in² Cu (2 oz.) on .060-inch thick FR4 PCB.

(2) Pulse duration 10 μs , duty cycle $\leq 2\%$



Table of Contents

1 Features 1 2 Applications 1 3 Description 1 4 Revision History 2 5 Specifications 3 5.1 Electrical Characteristics..... 3 5.2 Thermal Information 3 5.3 Typical MOSFET Characteristics..... 4 6 Device and Documentation Support 7	6.1 Trademarks 7 6.2 Electrostatic Discharge Caution 7 6.3 Glossary 7 7 Mechanical, Packaging, and Orderable Information 8 7.1 Q2 Package Dimensions 9 7.2 Recommended PCB Pattern..... 10 7.3 Recommended Stencil Pattern 10 7.4 Q2 Tape and Reel Information..... 11
--	--

4 Revision History

Changes from Original (January 2014) to Revision A	Page
• Revised "Pb-Free Terminal Plating" to Only State "Pb-Free"	1
• Added small reel option to the Ordering Information Table	1

5 Specifications

5.1 Electrical Characteristics

 $T_A = 25^\circ\text{C}$, unless otherwise specified

PARAMETER		TEST CONDITIONS	MIN	TYP	MAX	UNIT
STATIC CHARACTERISTICS						
V_{DSS}	Drain-to-Source Voltage	$V_{GS} = 0\text{ V}, I_D = -250\ \mu\text{A}$	-20			V
I_{DSS}	Drain-to-Source Leakage Current	$V_{GS} = 0\text{ V}, V_{DS} = -16\text{ V}$			-1	μA
I_{GSS}	Gate-to-Source Leakage Current	$V_{DS} = 0\text{ V}, V_{GS} = -8\text{ V}$			-100	nA
$V_{GS(th)}$	Gate-to-Source Threshold Voltage	$V_{DS} = V_{GS}, I_{DS} = -250\ \mu\text{A}$	-0.55	-0.85	-1.10	V
$R_{DS(on)}$	Drain-to-Source On Resistance	$V_{GS} = -1.8\text{ V}, I_{DS} = -5\text{ A}$		59.0	89.0	m Ω
		$V_{GS} = -2.5\text{ V}, I_{DS} = -5\text{ A}$		27.0	32.5	m Ω
		$V_{GS} = -4.5\text{ V}, I_{DS} = -5\text{ A}$		19.9	23.9	m Ω
g_{fs}	Transconductance	$V_{DS} = -16\text{ V}, I_{DS} = -5\text{ A}$		34		S
DYNAMIC CHARACTERISTICS						
C_{ISS}	Input Capacitance	$V_{GS} = 0\text{ V}, V_{DS} = -10\text{ V}, f = 1\text{ MHz}$		504	655	pF
C_{OSS}	Output Capacitance			281	365	pF
C_{RSS}	Reverse Transfer Capacitance			16.7	21.7	pF
R_g	Series Gate Resistance			1.9		Ω
Q_g	Gate Charge Total (-4.5 V)	$V_{DS} = -10\text{ V}, I_{DS} = -5\text{ A}$		3.6	4.7	nC
Q_{gd}	Gate Charge Gate to Drain			0.5		nC
Q_{gs}	Gate Charge Gate to Source			1.1		nC
$Q_{g(th)}$	Gate Charge at V_{th}			0.6		nC
Q_{OSS}	Output Charge	$V_{DS} = -10\text{ V}, V_{GS} = 0\text{ V}$		5.0		nC
$t_{d(on)}$	Turn On Delay Time	$V_{DS} = -10\text{ V}, V_{GS} = -4.5\text{ V}, I_{DS} = -5\text{ A}$ $R_G = 2\ \Omega$		8		ns
t_r	Rise Time			15		ns
$t_{d(off)}$	Turn Off Delay Time			15		ns
t_f	Fall Time			5		ns
DIODE CHARACTERISTICS						
V_{SD}	Diode Forward Voltage	$I_{DS} = -5\text{ A}, V_{GS} = 0\text{ V}$		-0.8	-1.0	V
Q_{rr}	Reverse Recovery Charge	$V_{DD} = -10\text{ V}, I_F = -5\text{ A}, di/dt = 200\text{ A}/\mu\text{s}$		9.2		nC
t_{rr}	Reverse Recovery Time			13		ns

5.2 Thermal Information

 $(T_A = 25^\circ\text{C}$ unless otherwise stated)

THERMAL METRIC		MIN	TYP	MAX	UNIT
$R_{\theta JC}$	Thermal Resistance Junction to Case ⁽¹⁾			4.5	$^\circ\text{C}/\text{W}$
$R_{\theta JA}$	Thermal Resistance Junction to Ambient ⁽¹⁾⁽²⁾			55	

- (1) $R_{\theta JC}$ is determined with the device mounted on a 1-inch² (6.45-cm²), 2-oz. (0.071-mm thick) Cu pad on a 1.5-inch x 1.5-inch (3.81-cm x 3.81-cm), 0.06-inch (1.52-mm) thick FR4 PCB. $R_{\theta JC}$ is specified by design, whereas $R_{\theta JA}$ is determined by the user's board design.
- (2) Device mounted on FR4 material with 1-inch² (6.45-cm²), 2-oz. (0.071-mm thick) Cu.

CSD25310Q2

SLPS459A – JANUARY 2014 – REVISED JUNE 2014

www.ti.com



Max $R_{\theta JA} = 55$ when mounted on 1 inch² (6.45 cm²) of 2-oz. (0.071-mm thick) Cu.

M0161-01



Max $R_{\theta JA} = 215$ when mounted on minimum pad area of 2-oz. (0.071-mm thick) Cu.

M0161-02

5.3 Typical MOSFET Characteristics

($T_A = 25^\circ\text{C}$ unless otherwise stated)

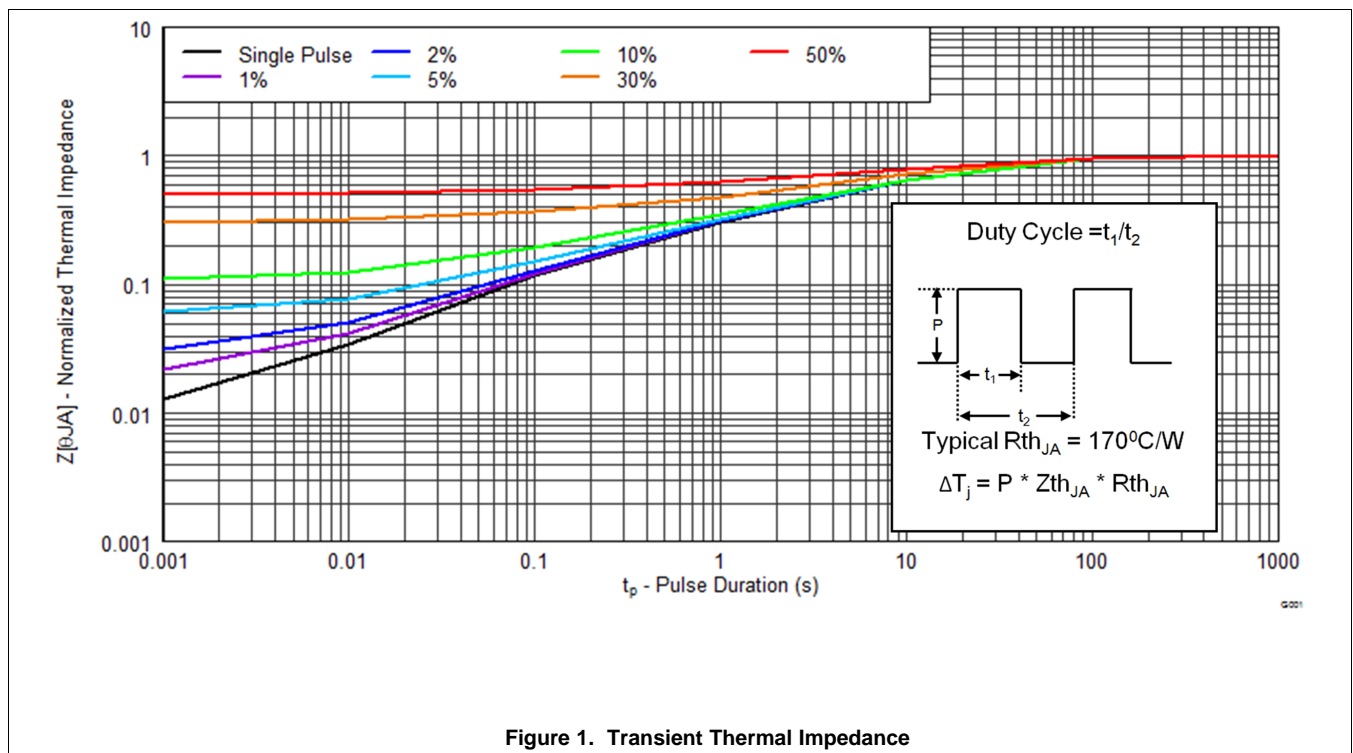

Figure 1. Transient Thermal Impedance

Typical MOSFET Characteristics (continued)

($T_A = 25^\circ\text{C}$ unless otherwise stated)

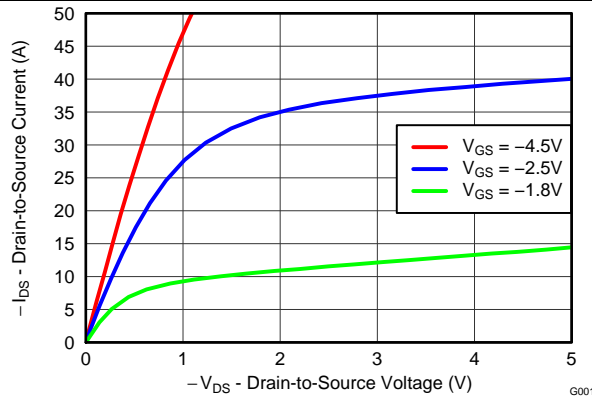

Figure 2. Saturation Characteristics

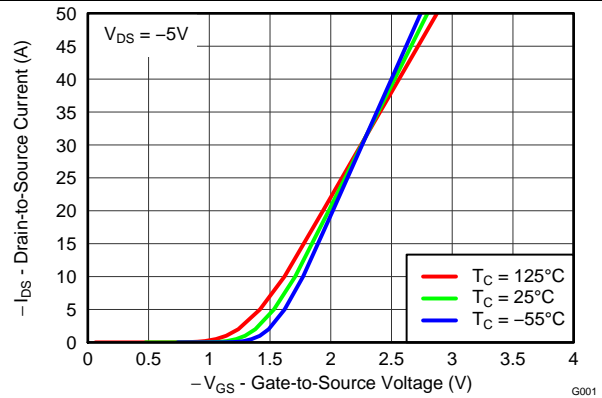

Figure 3. Transfer Characteristics

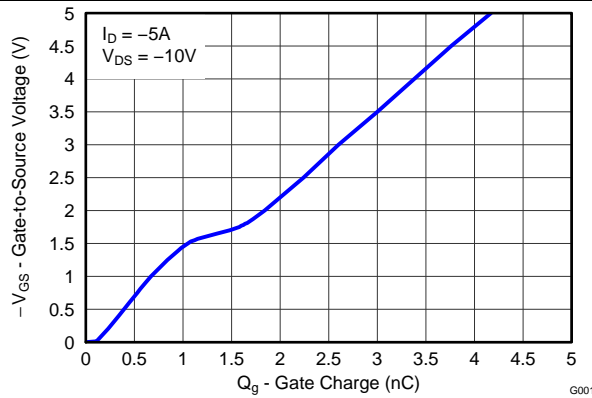

Figure 4. Gate Charge

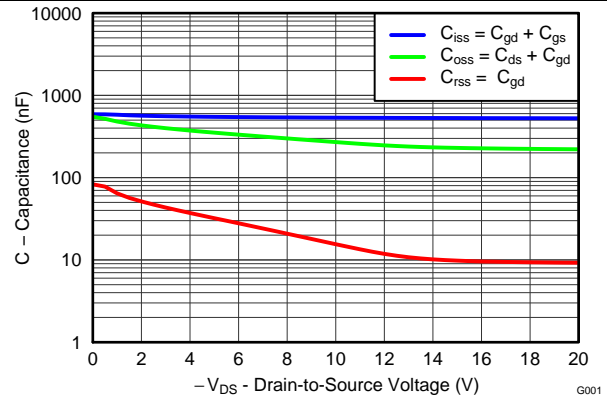

Figure 5. Capacitance

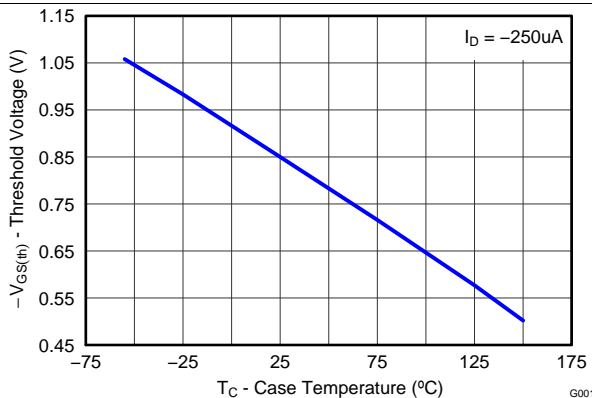

Figure 6. Threshold Voltage vs Temperature

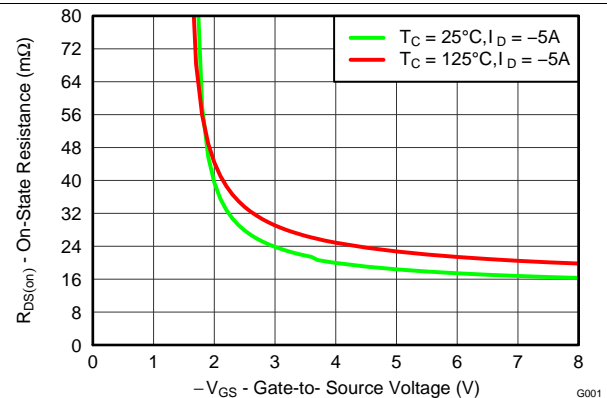

Figure 7. On-State Resistance vs Gate-to-Source Voltage

Typical MOSFET Characteristics (continued)

($T_A = 25^\circ\text{C}$ unless otherwise stated)

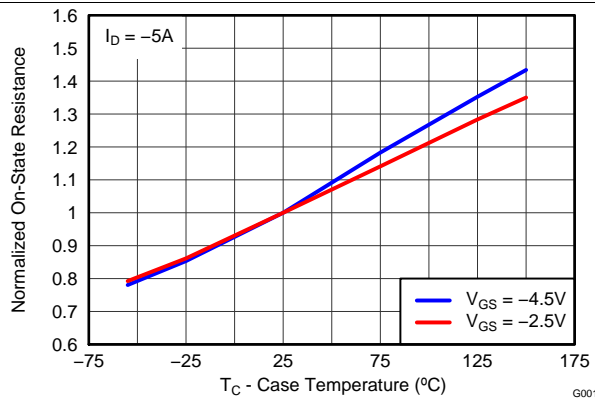

Figure 8. Normalized On-State Resistance vs Temperature

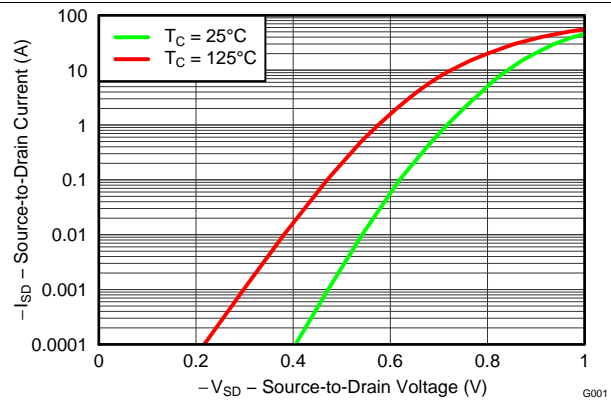

Figure 9. Typical Diode Forward Voltage

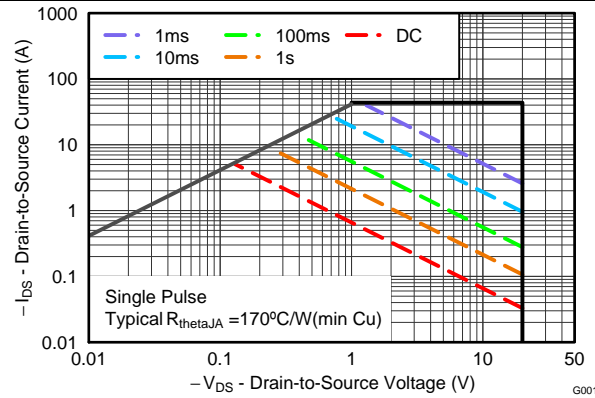

Figure 10. Maximum Safe Operating Area

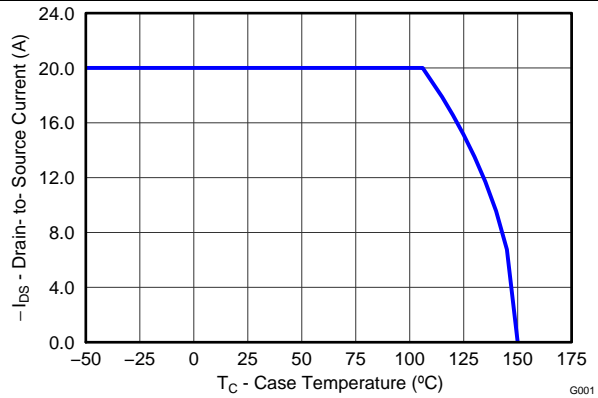

Figure 11. Maximum Drain Current vs Temperature

6 Device and Documentation Support

6.1 Trademarks

NexFET is a trademark of Texas Instruments.
All other trademarks are the property of their respective owners.

6.2 Electrostatic Discharge Caution



These devices have limited built-in ESD protection. The leads should be shorted together or the device placed in conductive foam during storage or handling to prevent electrostatic damage to the MOS gates.

6.3 Glossary

[SLYZ022](#) — *TI Glossary*.

This glossary lists and explains terms, acronyms and definitions.

7 Mechanical, Packaging, and Orderable Information

The following pages include mechanical packaging and orderable information. This information is the most current data available for the designated devices. This data is subject to change without notice and revision of this document. For browser-based versions of this data sheet, refer to the left-hand navigation.

7.1 Q2 Package Dimensions

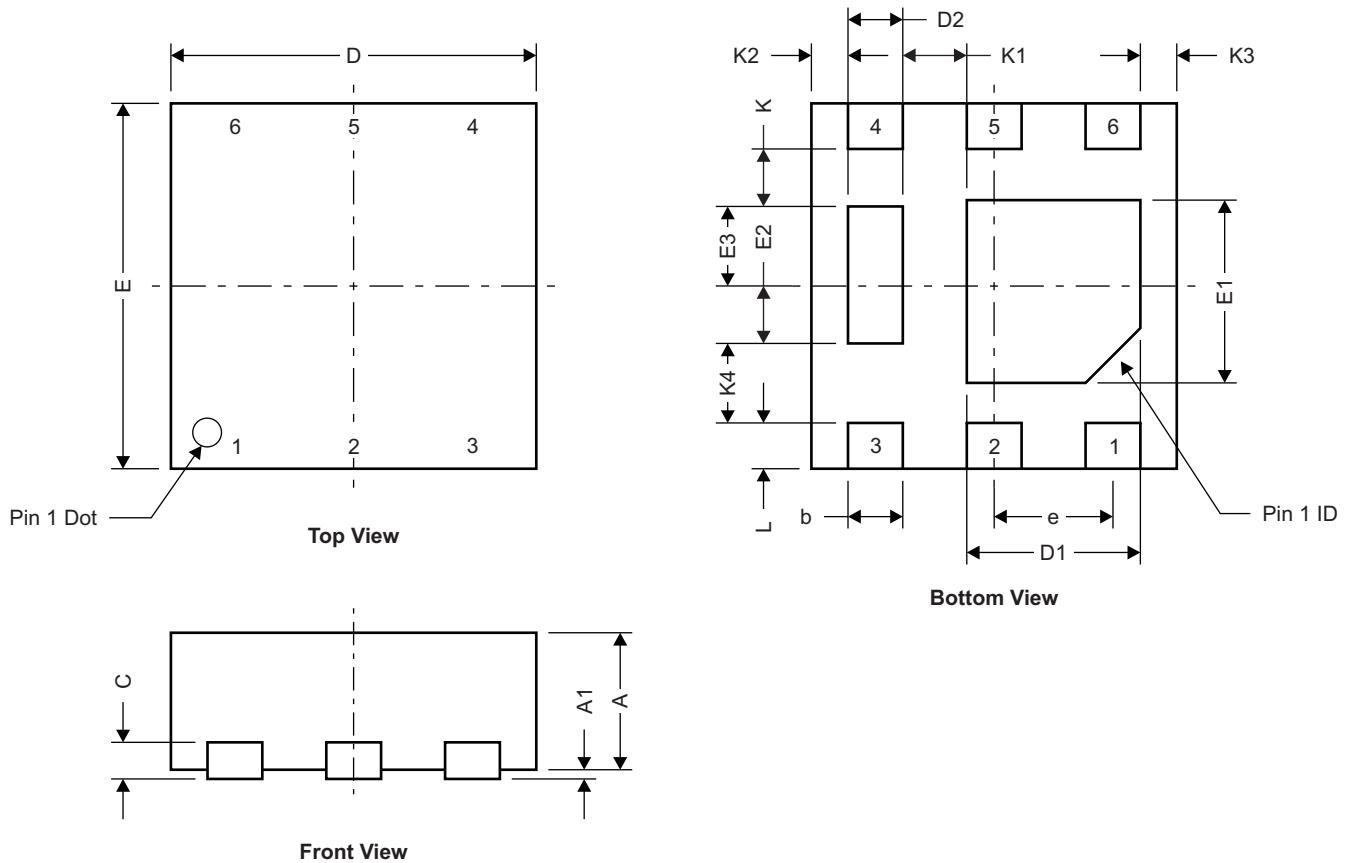

M0165-01

DIM	MILLIMETERS			INCHES		
	MIN	NOM	MAX	MIN	NOM	MAX
A	0.700	0.750	0.800	0.028	0.030	0.032
A1	0.000		0.050	0.000		0.002
b	0.250	0.300	0.350	0.010	0.012	0.014
C	0.203 TYP			0.008 TYP		
D	2.000 TYP			0.080 TYP		
D1	0.900	0.950	1.000	0.036	0.038	0.040
D2	0.300 TYP			0.012 TYP		
E	2.000 TYP			0.080 TYP		
E1	0.900	1.000	1.100	0.036	0.040	0.044
E2	0.280 TYP			0.0112 TYP		
E3	0.470 TYP			0.0188 TYP		
e	0.650 TYP			0.026 TYP		
K	0.280 TYP			0.0112 TYP		
K1	0.350 TYP			0.014 TYP		
K2	0.200 TYP			0.008 TYP		
K3	0.200 TYP			0.008 TYP		
K4	0.470 TYP			0.0188 TYP		
L	0.200	0.25	0.300	0.008	0.010	0.012

7.2 Recommended PCB Pattern

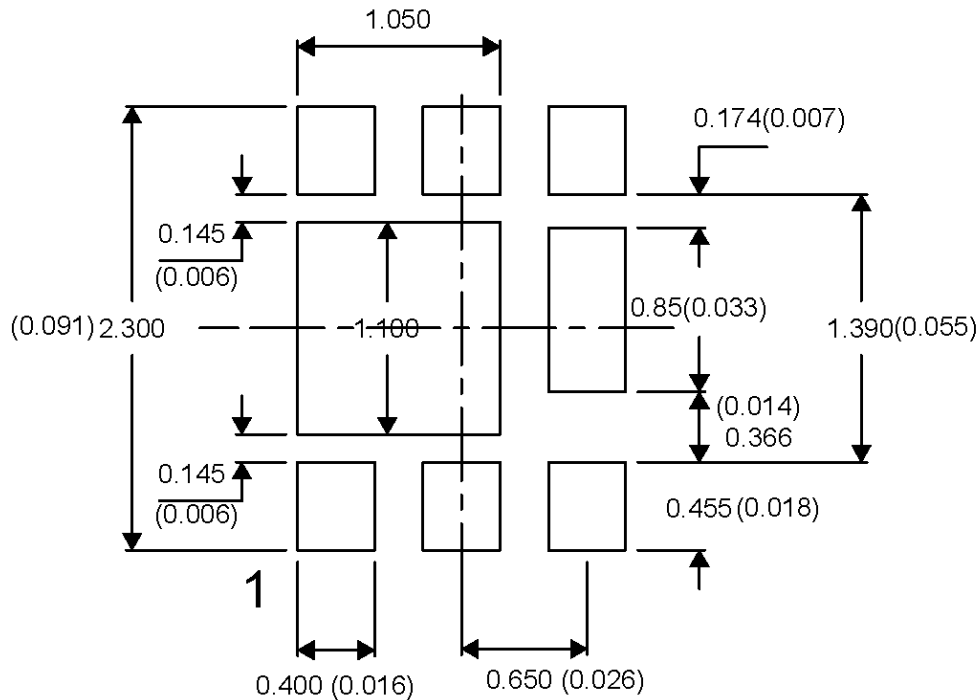

For recommended circuit layout for PCB designs, see application note [SLPA005 – Reducing Ringing Through PCB Layout Techniques](#).

7.3 Recommended Stencil Pattern

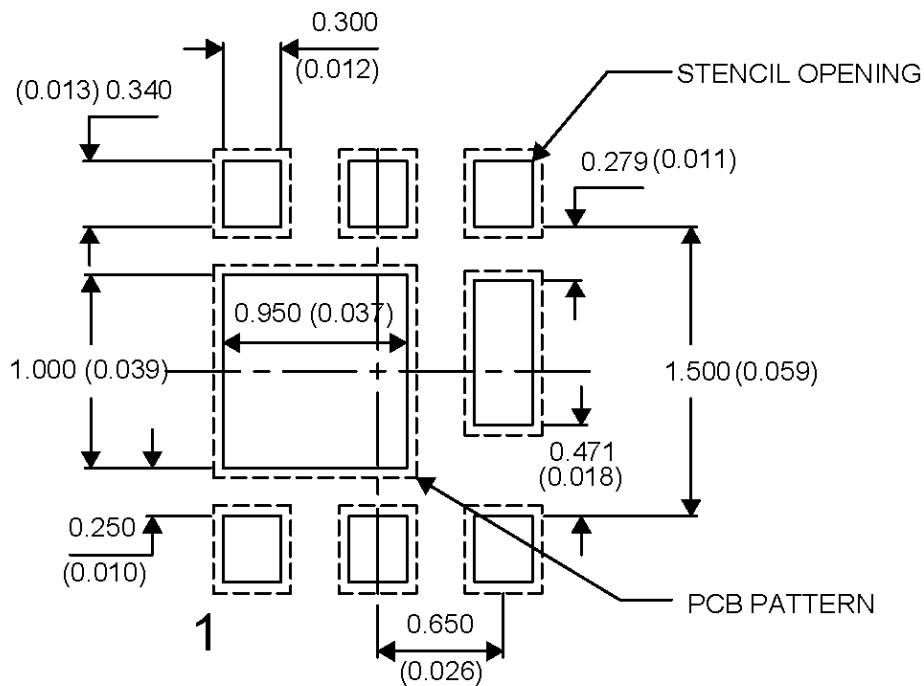

Note: All dimensions are in mm, unless otherwise specified.

7.4 Q2 Tape and Reel Information

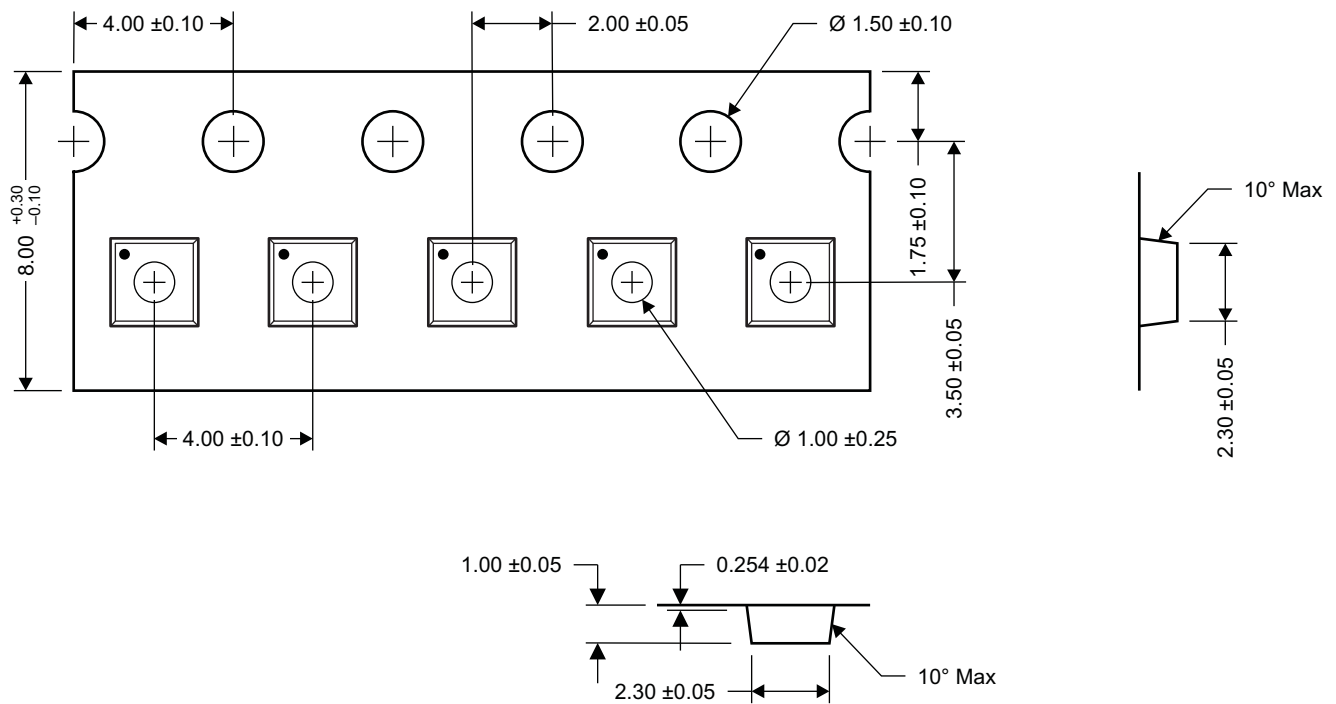

- Notes:
1. Measured from centerline of sprocket hole to centerline of pocket
 2. Cumulative tolerance of 10 sprocket holes is ± 0.20
 3. Other material available
 4. Typical SR of form tape Max 10^9 OHM/SQ
 5. All dimensions are in mm, unless otherwise specified.

M0168-01

PACKAGING INFORMATION

Orderable Device	Status (1)	Package Type	Package Drawing	Pins	Package Qty	Eco Plan (2)	Lead finish/ Ball material (6)	MSL Peak Temp (3)	Op Temp (°C)	Device Marking (4/5)	Samples
CSD25310Q2	ACTIVE	WSON	DQK	6	3000	RoHS & Green	NIPDAU SN	Level-1-260C-UNLIM	-55 to 150	2530	Samples
CSD25310Q2T	ACTIVE	WSON	DQK	6	250	RoHS & Green	NIPDAU	Level-1-260C-UNLIM	-55 to 150	2530	Samples

(1) The marketing status values are defined as follows:

ACTIVE: Product device recommended for new designs.

LIFEBUY: TI has announced that the device will be discontinued, and a lifetime-buy period is in effect.

NRND: Not recommended for new designs. Device is in production to support existing customers, but TI does not recommend using this part in a new design.

PREVIEW: Device has been announced but is not in production. Samples may or may not be available.

OBSOLETE: TI has discontinued the production of the device.

(2) **RoHS:** TI defines "RoHS" to mean semiconductor products that are compliant with the current EU RoHS requirements for all 10 RoHS substances, including the requirement that RoHS substance do not exceed 0.1% by weight in homogeneous materials. Where designed to be soldered at high temperatures, "RoHS" products are suitable for use in specified lead-free processes. TI may reference these types of products as "Pb-Free".

RoHS Exempt: TI defines "RoHS Exempt" to mean products that contain lead but are compliant with EU RoHS pursuant to a specific EU RoHS exemption.

Green: TI defines "Green" to mean the content of Chlorine (Cl) and Bromine (Br) based flame retardants meet JS709B low halogen requirements of <=1000ppm threshold. Antimony trioxide based flame retardants must also meet the <=1000ppm threshold requirement.

(3) MSL, Peak Temp. - The Moisture Sensitivity Level rating according to the JEDEC industry standard classifications, and peak solder temperature.

(4) There may be additional marking, which relates to the logo, the lot trace code information, or the environmental category on the device.

(5) Multiple Device Markings will be inside parentheses. Only one Device Marking contained in parentheses and separated by a "~" will appear on a device. If a line is indented then it is a continuation of the previous line and the two combined represent the entire Device Marking for that device.

(6) Lead finish/Ball material - Orderable Devices may have multiple material finish options. Finish options are separated by a vertical ruled line. Lead finish/Ball material values may wrap to two lines if the finish value exceeds the maximum column width.

Important Information and Disclaimer:The information provided on this page represents TI's knowledge and belief as of the date that it is provided. TI bases its knowledge and belief on information provided by third parties, and makes no representation or warranty as to the accuracy of such information. Efforts are underway to better integrate information from third parties. TI has taken and continues to take reasonable steps to provide representative and accurate information but may not have conducted destructive testing or chemical analysis on incoming materials and chemicals. TI and TI suppliers consider certain information to be proprietary, and thus CAS numbers and other limited information may not be available for release.

In no event shall TI's liability arising out of such information exceed the total purchase price of the TI part(s) at issue in this document sold by TI to Customer on an annual basis.

IMPORTANT NOTICE AND DISCLAIMER

TI PROVIDES TECHNICAL AND RELIABILITY DATA (INCLUDING DATA SHEETS), DESIGN RESOURCES (INCLUDING REFERENCE DESIGNS), APPLICATION OR OTHER DESIGN ADVICE, WEB TOOLS, SAFETY INFORMATION, AND OTHER RESOURCES "AS IS" AND WITH ALL FAULTS, AND DISCLAIMS ALL WARRANTIES, EXPRESS AND IMPLIED, INCLUDING WITHOUT LIMITATION ANY IMPLIED WARRANTIES OF MERCHANTABILITY, FITNESS FOR A PARTICULAR PURPOSE OR NON-INFRINGEMENT OF THIRD PARTY INTELLECTUAL PROPERTY RIGHTS.

These resources are intended for skilled developers designing with TI products. You are solely responsible for (1) selecting the appropriate TI products for your application, (2) designing, validating and testing your application, and (3) ensuring your application meets applicable standards, and any other safety, security, regulatory or other requirements.

These resources are subject to change without notice. TI grants you permission to use these resources only for development of an application that uses the TI products described in the resource. Other reproduction and display of these resources is prohibited. No license is granted to any other TI intellectual property right or to any third party intellectual property right. TI disclaims responsibility for, and you will fully indemnify TI and its representatives against, any claims, damages, costs, losses, and liabilities arising out of your use of these resources.

TI's products are provided subject to [TI's Terms of Sale](#) or other applicable terms available either on [ti.com](https://www.ti.com) or provided in conjunction with such TI products. TI's provision of these resources does not expand or otherwise alter TI's applicable warranties or warranty disclaimers for TI products.

TI objects to and rejects any additional or different terms you may have proposed.

Mailing Address: Texas Instruments, Post Office Box 655303, Dallas, Texas 75265
Copyright © 2023, Texas Instruments Incorporated