

LMC8101 Rail-to-Rail Input and Output, 2.7V Op Amp in DSBGA Package With Shutdown

Check for Samples: [LMC8101](#)

FEATURES

- $V_S = 2.7V$, $T_A = 25^\circ C$, R_L to $V^+/2$, Typical Values Unless Specified.
- Rail-to-Rail Inputs
- Rail-to-Rail Output Swing Within 35mV of Supplies ($R_L = 2k\Omega$)
- Packages Offered:
 - DSBGA package 1.39mm x 1.41mm
 - VSSOP package 3.0mm x 4.9mm
- Low Supply Current <1mA (max)
- Shutdown Current 1 μ A (Max)
- Versatile Shutdown Feature 10 μ s Turn-On
- Output Short Circuit Current 10mA
- Offset Voltage ± 5 mV (max)
- Gain-Bandwidth 1MHz
- Supply Voltage Range 2.7V-10V
- THD 0.18%
- Voltage Noise 36nv/ \sqrt{Hz}

APPLICATIONS

- Portable Communication (Voice, Data)
- Cellular Phone Power Amp Control Loop
- Buffer AMP
- Active Filters
- Battery Sense
- VCO Loop

DESCRIPTION

The LMC8101 is a Rail-to-Rail Input and Output high performance CMOS operational amplifier. The LMC8101 is ideal for low voltage (2.7V to 10V) applications requiring Rail-to-Rail inputs and output. The LMC8101 is supplied in the die sized DSBGA as well as the 8 pin VSSOP packages. The DSBGA package requires 75% less board space as compared to the SOT-23 package. The LMC8101 is an upgrade to the industry standard LMC7101.

The LMC8101 incorporates a simple user controlled methodology for shutdown. This allows ease of use while reducing the total supply current to 1nA typical. This extends battery life where power saving is mandated. The shutdown input threshold can be set relative to either V^+ or V^- using the SL pin (see [Application Notes](#) section for details).

Other enhancements include improved offset voltage limit, three times the output current drive and lower 1/f noise when compared to the industry standard LMC7101 Op Amp. This makes the LMC8101 ideal for use in many battery powered, wireless communication and Industrial applications.



Please be aware that an important notice concerning availability, standard warranty, and use in critical applications of Texas Instruments semiconductor products and disclaimers thereto appears at the end of this data sheet.

All trademarks are the property of their respective owners.

Connection Diagrams

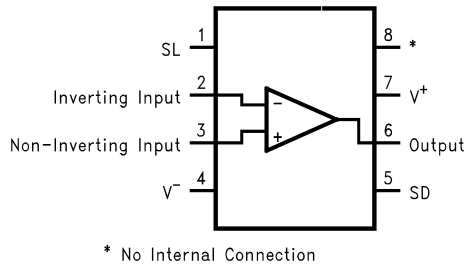

Figure 1. 8-Pin VSSOP Top View

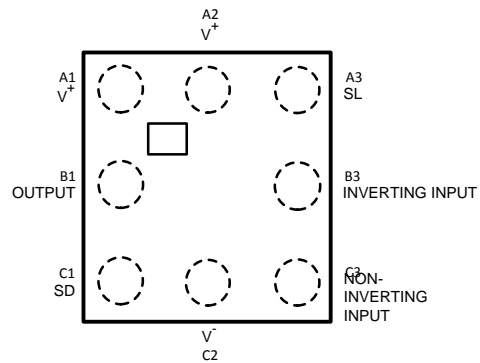

Figure 2. DSBGA Top View



These devices have limited built-in ESD protection. The leads should be shorted together or the device placed in conductive foam during storage or handling to prevent electrostatic damage to the MOS gates.

Absolute Maximum Ratings⁽¹⁾⁽²⁾

ESD Tolerance		2kV ⁽³⁾ 200V ⁽⁴⁾
V _{IN} differential		±Supply Voltage
Output Short Circuit Duration		See ⁽⁵⁾⁽⁶⁾
Supply Voltage (V ⁺ – V ⁻)		12V
Voltage at Input/Output pins		V ⁺ +0.8V, V ⁻ -0.8V
Current at Input Pin		±10mA
Current at Output Pin ⁽⁵⁾⁽⁶⁾		±80mA
Current at Power Supply pins		±80mA
Storage Temperature Range		-65°C to +150°C
Junction Temperature ⁽⁷⁾		+150°C
Soldering Information	Infrared or Convection (20 sec.)	235°C
	Wave Soldering (10 sec.)	260°C

- (1) Absolute Maximum Ratings indicate limits beyond which damage to the device may occur. Operating Ratings indicate conditions for which the device is intended to be functional, but specific performance is not specified. For ensured specifications and the test conditions, see the Electrical Characteristics.
- (2) If Military/Aerospace specified devices are required, please contact the Texas Instruments Sales Office/ Distributors for availability and specifications.
- (3) Human body model, 1.5kΩ in series with 100pF.
- (4) Machine Model, 0Ω in series with 200pF.
- (5) Applies to both single-supply and split-supply operation. Continuous short circuit operation at elevated ambient temperature can result in exceeding the maximum allowed junction temperature at 150°C. Output currents in excess of 40mA over long term may adversely affect reliability.
- (6) Short circuit test is a momentary test. Output short circuit duration is infinite for V_S < 6V. Otherwise, extended period output short circuit may damage the device.
- (7) The maximum power dissipation is a function of T_{J(MAX)}, θ_{JA} and T_A. The maximum allowable power dissipation at any ambient temperature is P_D = (T_{J(MAX)} – T_A)/θ_{JA}. All numbers apply for packages soldered directly onto a PC board.

Operating Ratings

Supply Voltage ($V^+ - V^-$)		2.7V to 10V
Junction Temperature Range ⁽²⁾		-40°C to +85°C
Package Thermal Resistance (θ_{JA}) ⁽²⁾	DSBGA	220°C/W
	VSSOP package 8 pin Surface Mount	230°C/W

- (1) Absolute Maximum Ratings indicate limits beyond which damage to the device may occur. Operating Ratings indicate conditions for which the device is intended to be functional, but specific performance is not specified. For ensured specifications and the test conditions, see the Electrical Characteristics.
- (2) The maximum power dissipation is a function of $T_{J(MAX)}$, θ_{JA} and T_A . The maximum allowable power dissipation at any ambient temperature is $P_D = (T_{J(MAX)} - T_A)/\theta_{JA}$. All numbers apply for packages soldered directly onto a PC board.

2.7V Electrical Characteristics

Unless otherwise specified, all limits specified for $T_J = 25^\circ\text{C}$, $V^+ = 2.7\text{V}$, $V^- = 0\text{V}$, $V_{CM} = V_O = V^+/2$ and $R_L > 1\text{M}\Omega$ to $V^+/2$.

Boldface limits apply at the temperature extremes.

Symbol	Parameter	Conditions	Typ ⁽¹⁾	Limit ⁽²⁾	Units
V_{OS}	Input Offset Voltage		± 0.70	± 5 ± 7	mV max
TCV_{OS}	Input Offset Voltage Average Drift		4		$\mu\text{V}/^\circ\text{C}$
I_B	Input Bias Current	See ⁽³⁾	± 1	± 64	pA max
I_{OS}	Input Offset Current		0.5	32	pA max
$R_{in\ CM}$	Input Common Mode Resistance		10		G Ω
$C_{in\ CM}$	Input Common Mode Capacitance		10		pF
CMRR	Common Mode Rejection Ratio	$0\text{V} \leq V_{CM} \leq 2.7\text{V}$	78	60	dB min
		$V_S = 3\text{V}$ $0\text{V} \leq V_{CM} \leq 3\text{V}$	78	64 60	
PSRR	Power Supply Rejection Ratio	$V_S = 2.7\text{V}$ to 3V	57	50 48	dB min
CMVR	Input Common-Mode Voltage Range	$V_S = 2.7\text{V}$ CMRR > = 50dB	0.0	0.0	V max
			3.0	2.7	V min
		$V_S = 3\text{V}$ CMRR > = 50dB	-0.2	-0.1	V max
			3.2	3.1	V min
A_{VOL}	Large Signal Voltage Gain	Sourcing $R_L = 2\text{k}\Omega$ to $V^+/2$ $V_O = 1.35\text{V}$ to 2.45V	3162	1000 562	V/V min
		Sinking $R_L = 2\text{k}\Omega$ to $V^+/2$ $V_O = 1.35\text{V}$ to 0.25V	3162	804 562	
		Sourcing $R_L = 10\text{k}\Omega$ to $V^+/2$ $V_O = 1.35\text{V}$ to 2.65V	4000	1778 1000	V/V min
		Sinking $R_L = 10\text{k}\Omega$ to $V^+/2$ $V_O = 1.35\text{V}$ to 0.05V	4000	1778 1000	
V_O	Output Swing High	$R_L = 2\text{k}\Omega$ to $V^+/2$ $V_{ID} = 100\text{mV}$	2.67	2.64 2.62	V min
		$R_L = 10\text{k}\Omega$ to $V^+/2$ $V_{ID} = 100\text{mV}$	2.69	2.68 2.67	V min
	Output Swing Low	$R_L = 2\text{k}\Omega$ to $V^+/2$ $V_{ID} = -100\text{mV}$	32	100 150	mV max
		$R_L = 10\text{k}\Omega$ to $V^+/2$ $V_{ID} = -100\text{mV}$	10	30 70	mV max

(1) Typical Values represent the most likely parametric norm.

(2) All limits are specified by testing or statistical analysis.

(3) Positive current corresponds to current flowing into the device.

2.7V Electrical Characteristics (continued)

Unless otherwise specified, all limits specified for $T_J = 25^\circ\text{C}$, $V^+ = 2.7\text{V}$, $V^- = 0\text{V}$, $V_{\text{CM}} = V_O = V^+/2$ and $R_L > 1\text{M}\Omega$ to $V^+/2$.

Boldface limits apply at the temperature extremes.

Symbol	Parameter	Conditions	Typ ⁽¹⁾	Limit ⁽²⁾	Units
I_{SC}	Output Short Circuit Current	Sourcing to $V^+/2$ $V_{\text{ID}} = 100\text{mV}^{(4)}$	20	14 6	mA min
		Sinking to $V^+/2$ $V_{\text{ID}} = -100\text{mV}^{(4)}$	10	5 4	mA min
I_{S}	Supply Current	No load, normal operation	0.70	1.0 1.2	mA max
		Shutdown mode	0.001	1	μA max
T_{on}	Shutdown Turn-on time	See ⁽⁵⁾	10	15	μs
T_{off}	Shutdown Turn-off time	See ⁽⁵⁾	1		μs
I_{in}	"SL" and "SD" Input Current ⁽⁶⁾		± 1	± 64	pA max
SR	Slew Rate ⁽⁷⁾	$A_V = +1$, $R_L = 10\text{k}\Omega$ to $V^+/2$ $V_I = 1\text{V}_{\text{PP}}$	1	0.8	$\text{V}/\mu\text{s}$ min
f_u	Unity Gain-Bandwidth	$V_I = 10\text{mV}$, $R_L = 2\text{k}\Omega$ to $V^+/2$	750		KHz
GBW	Gain Bandwidth Product	$f = 100\text{KHz}$	1		MHz
e_n	Input-Referred Voltage Noise	$f = 10\text{KHz}$, $R_S = 50\Omega$	36		$\text{nV}/\sqrt{\text{Hz}}$
i_n	Input-Referred Current Noise	$f = 10\text{KHz}$	1.5		$\text{fA}/\sqrt{\text{Hz}}$
THD	Total Harmonic Distortion	$f = 1\text{KHz}$, $A_V = +1$, $V_O = 2.2\text{V}_{\text{pp}}$, $R_L = 600\Omega$ to $V^+/2$	0.18		%

(4) Short circuit test is a momentary test. Output short circuit duration is infinite for $V_S < 6\text{V}$. Otherwise, extended period output short circuit may damage the device.

(5) Shutdown Turn-on and Turn-off times are defined as the time required for the output to reach 90% and 10%, respectively, of its final peak to peak swing when set for Rail to Rail output swing with a 100KHz sine wave, 2K Ω load, and $A_V = +10$.

(6) Limiting input pin current is only necessary for input voltages that exceed absolute maximum input voltage ratings.

(7) Slew rate is the slower of the rising and falling slew rates.

$\pm 5\text{V}$ Electrical Characteristics

Unless otherwise specified, all limits specified for $T_J = 25^\circ\text{C}$, $V^+ = 5\text{V}$, $V^- = -5\text{V}$, $V_{\text{CM}} = V_O = 0\text{V}$, and $R_L > 1\text{M}\Omega$ to gnd.

Boldface limits apply at the temperature extremes.

Symbol	Parameter	Conditions	Typ ⁽¹⁾	Limit ⁽²⁾	Units
V_{OS}	Input Offset Voltage		± 0.7	± 5 ± 7	mV max
TCV_{OS}	Input Offset Voltage Average Drift		4		$\mu\text{V}/^\circ\text{C}$
I_{B}	Input Bias Current	See ⁽³⁾	± 1	± 64	pA max
I_{OS}	Input Offset Current		0.5	32	pA max
$R_{\text{in CM}}$	Input Common Mode Resistance		10		G Ω
$C_{\text{in CM}}$	Input Common Mode Capacitance		10		pF
CMRR	Common-Mode Rejection Ratio	$-5\text{V} < V_{\text{CM}} < 5\text{V}$	87	70 67	dB min
PSRR	Power Supply Rejection Ratio	$V_S = 5\text{V}$ to 10V	80	76 72	dB min
CMVR	Input Common-Mode Voltage Range	CMRR $\geq 50\text{ dB}$	-5.3	-5.2 -5.0	V max
			5.3	5.2 5.0	V min

(1) Typical Values represent the most likely parametric norm.

(2) All limits are specified by testing or statistical analysis.

(3) Positive current corresponds to current flowing into the device.

±5V Electrical Characteristics (continued)

 Unless otherwise specified, all limits specified for $T_J = 25^\circ\text{C}$, $V^+ = 5\text{V}$, $V^- = -5\text{V}$, $V_{\text{CM}} = V_O = 0\text{V}$, and $R_L > 1\text{M}\Omega$ to gnd.

Boldface limits apply at the temperature extremes.

Symbol	Parameter	Conditions	Typ ⁽¹⁾	Limit ⁽²⁾	Units
A_{VOL}	Large Signal Voltage Gain	Sourcing $R_L = 600\Omega$ $V_O = 0\text{V to } 4\text{V}$	34.5	17.8 10	V/mV min
		Sinking $R_L = 600\Omega$ $V_O = 0\text{V to } -4\text{V}$	34.5	17.8 3.16	
		Sourcing $R_L = 2\text{k}\Omega$ $V_O = 0\text{V to } 4.6\text{V}$	138	31.6 17.8	V/mV min
		Sinking $R_L = 2\text{k}\Omega$ $V_O = 0\text{V to } -4.6\text{V}$	138	31.6 10	
V_O	Output Swing High	$R_L = 600\Omega$ $V_{\text{ID}} = 100\text{mV}$	4.73	4.60 4.54	V min
		$R_L = 2\text{k}\Omega$ $V_{\text{ID}} = 100\text{mV}$	4.90	4.85 4.83	V min
	Output Swing Low	$R_L = 600\Omega$ $V_{\text{ID}} = -100\text{mV}$	-4.85	-4.75 -4.65	V max
		$R_L = 2\text{k}\Omega$ $V_{\text{ID}} = -100\text{mV}$	-4.95	4.90 -4.84	V max
I_{SC}	Output Short Circuit Current	Sourcing, $V_{\text{ID}} = 100\text{mV}$ ⁽⁴⁾⁽⁵⁾	49	30 25	mA min
		Sinking, $V_{\text{ID}} = -100\text{mV}$ ⁽⁴⁾⁽⁵⁾	90	60 52	mA min
I_{S}	Supply Current	No load, normal operation	1.1	1.7 1.9	mA max
		Shutdown mode	0.001	1	μA
T_{on}	Shutdown Turn-on time	See ⁽⁶⁾	10	15	μs
T_{off}	Shutdown Turn-off time	See ⁽⁶⁾	1		μs
I_{in}	"SL" and "SD" Input Current		± 1	± 64	pA max
SR	Slew Rate ⁽⁷⁾	$A_V = +10$, $R_L = 10\text{k}\Omega$, $V_O = 10\text{Vpp}$, $C_L = 1000\text{pF}$	1.2		V/ μs
f_u	Unity Gain-Bandwidth	$V_I = 10\text{mV}$ $R_L = 2\text{k}\Omega$	840		KHz
GBW	Gain Bandwidth Product	$f = 10\text{KHz}$	1.3		MHz
e_n	Input-Referred Voltage Noise	$f = 10\text{KHz}$, $R_s = 50\Omega$	33		nV/ $\sqrt{\text{Hz}}$
i_n	Input-Referred Current Noise	$f = 10\text{KHz}$	1.5		fA/ $\sqrt{\text{Hz}}$
THD	Total Harmonic Distortion	$f = 10\text{KHz}$, $A_V = +1$, $V_O = 8\text{Vpp}$, $R_L = 600\Omega$	0.2		%

(4) Applies to both single-supply and split-supply operation. Continuous short circuit operation at elevated ambient temperature can result in exceeding the maximum allowed junction temperature at 150°C . Output currents in excess of 40mA over long term may adversely affect reliability.

(5) Short circuit test is a momentary test. Output short circuit duration is infinite for $V_S < 6\text{V}$. Otherwise, extended period output short circuit may damage the device.

(6) Shutdown Turn-on and Turn-off times are defined as the time required for the output to reach 90% and 10%, respectively, of its final peak to peak swing when set for Rail to Rail output swing with a 100KHz sine wave, 2K Ω load, and $A_V = +10$.

(7) Slew rate is the slower of the rising and falling slew rates.

Typical Performance Characteristics

$V_S = 2.7V$, Single Supply, $V_{CM} = V^+/2$, $T_A = 25^\circ C$ unless specified

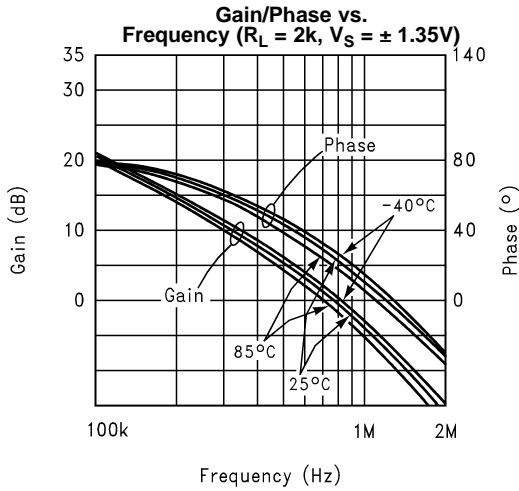

Figure 3.

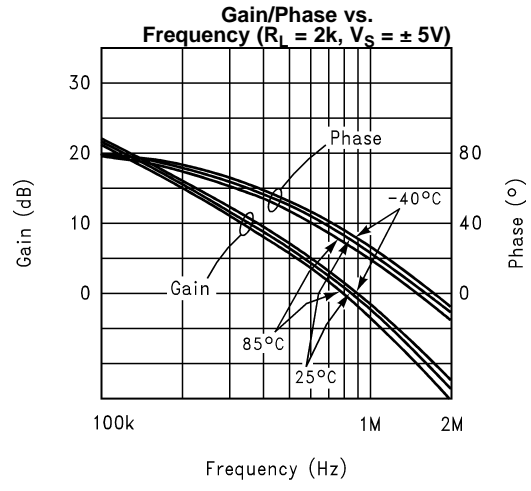

Figure 4.

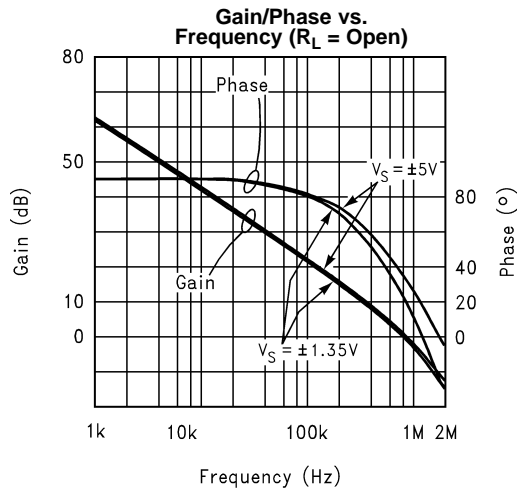

Figure 5.

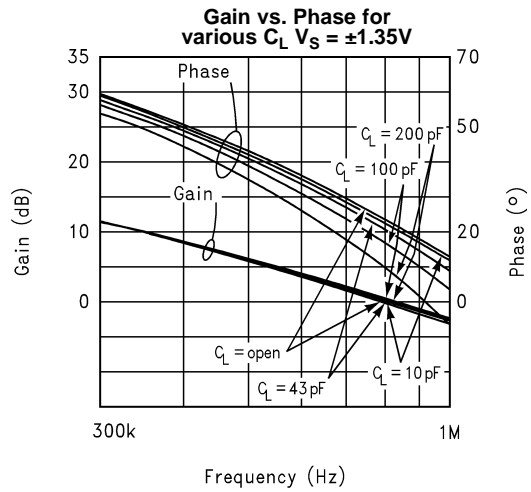

Figure 6.

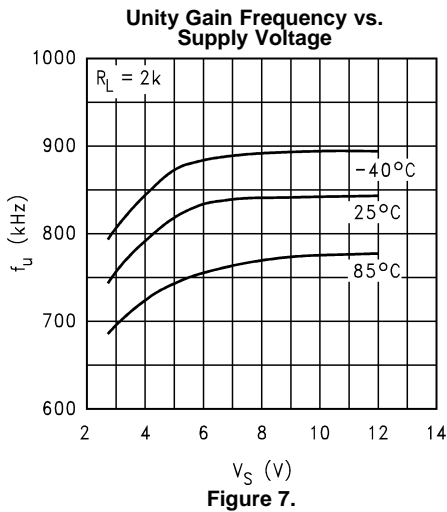

Figure 7.

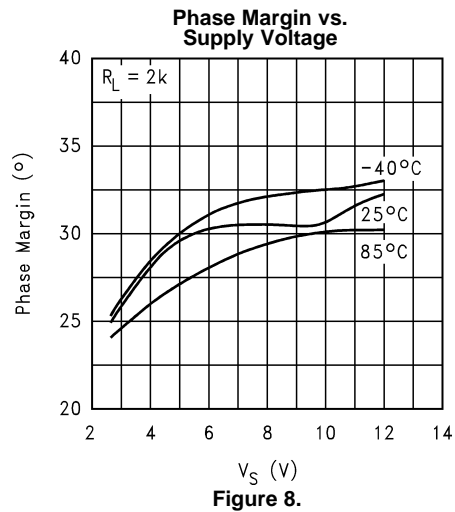

Figure 8.

Typical Performance Characteristics (continued)

$V_S = 2.7V$, Single Supply, $V_{CM} = V^+/2$, $T_A = 25^\circ C$ unless specified

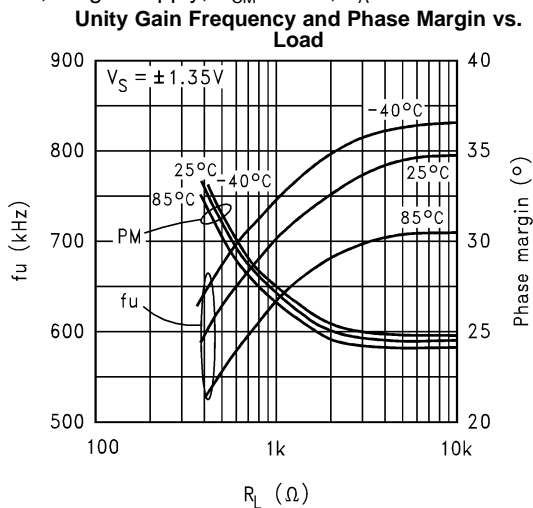

Figure 9.

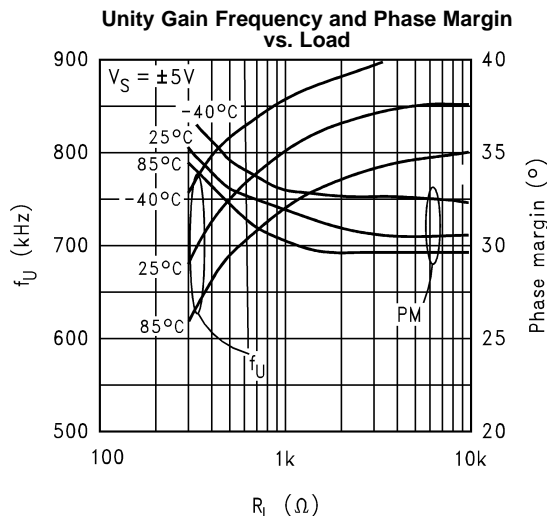

Figure 10.

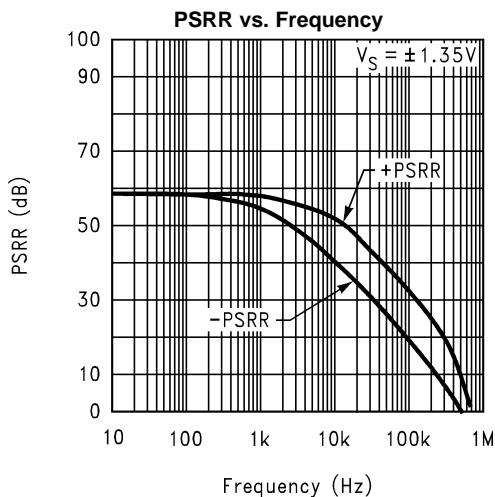

Figure 11.

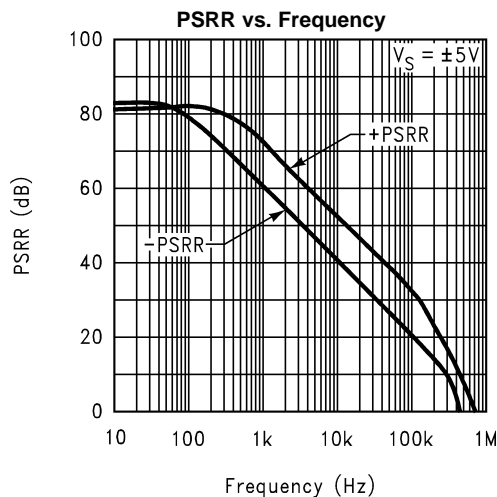

Figure 12.

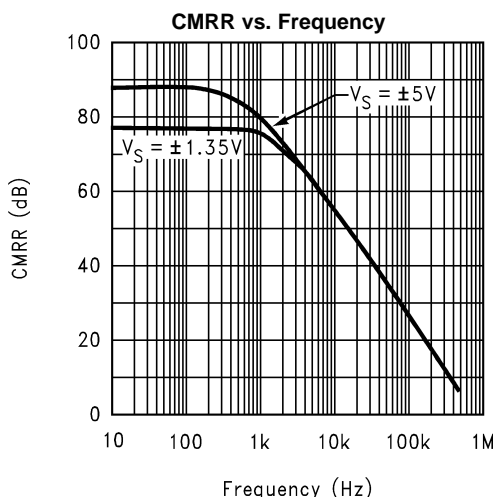

Figure 13.

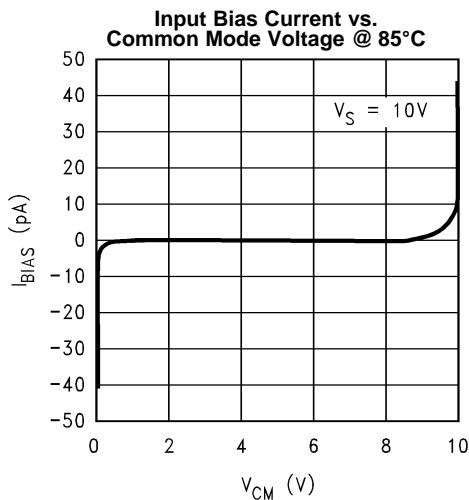

Figure 14.

Typical Performance Characteristics (continued)

$V_S = 2.7V$, Single Supply, $V_{CM} = V^+/2$, $T_A = 25^\circ C$ unless specified

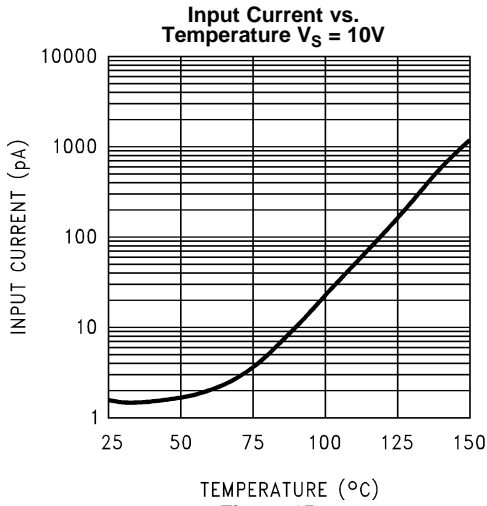

Figure 15.

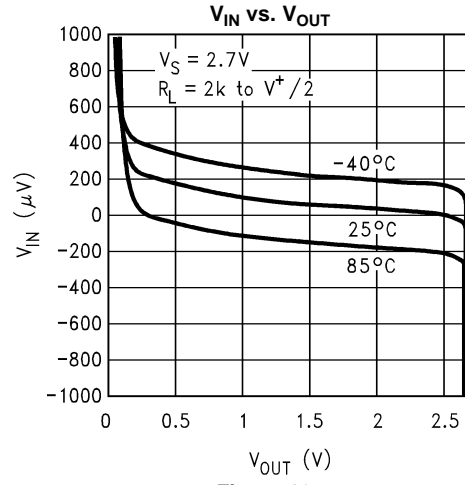

Figure 16.

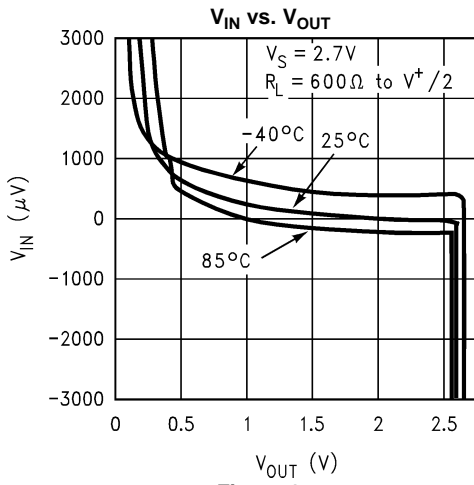

Figure 17.

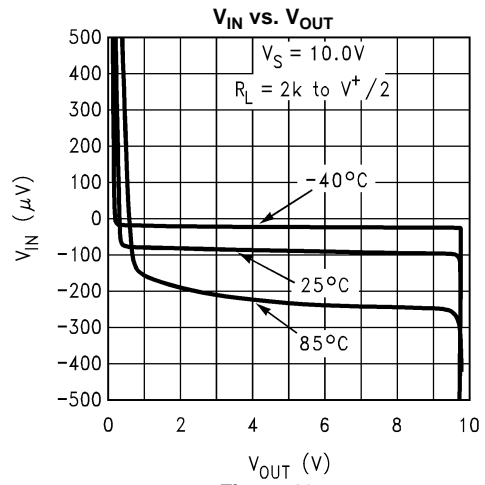

Figure 18.

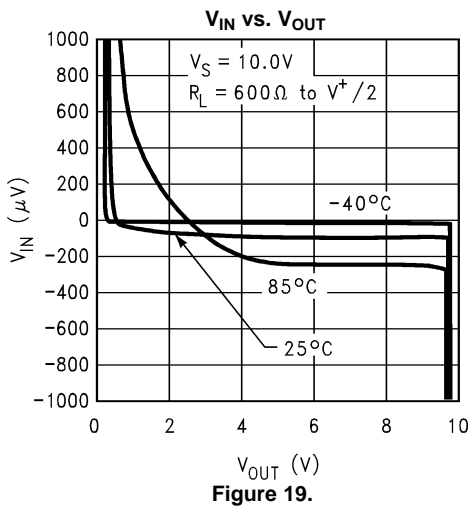

Figure 19.

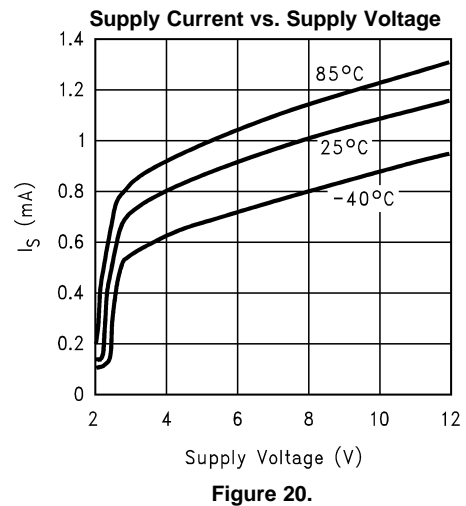

Figure 20.

Typical Performance Characteristics (continued)

$V_S = 2.7V$, Single Supply, $V_{CM} = V^+/2$, $T_A = 25^\circ C$ unless specified

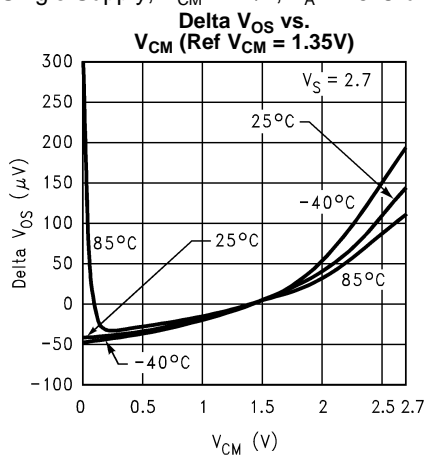

Figure 21.

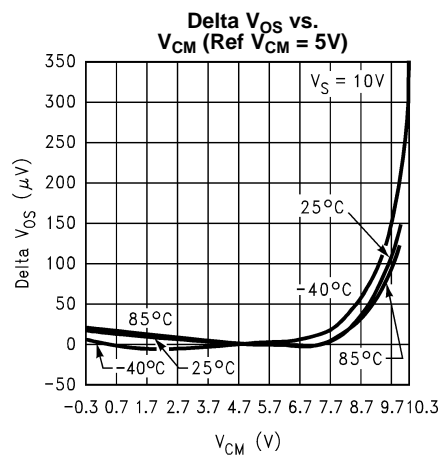

Figure 22.

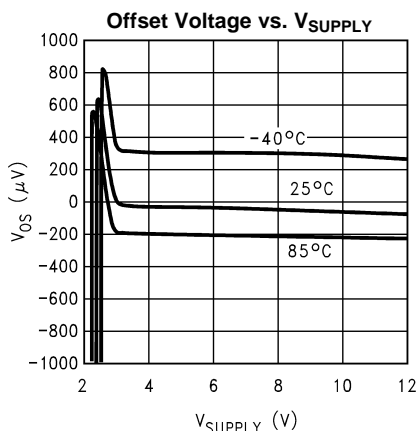

Figure 23.

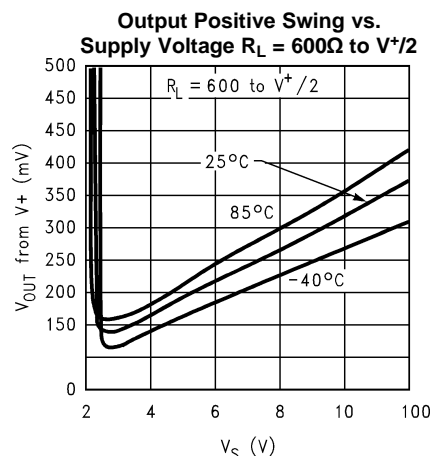

Figure 24.

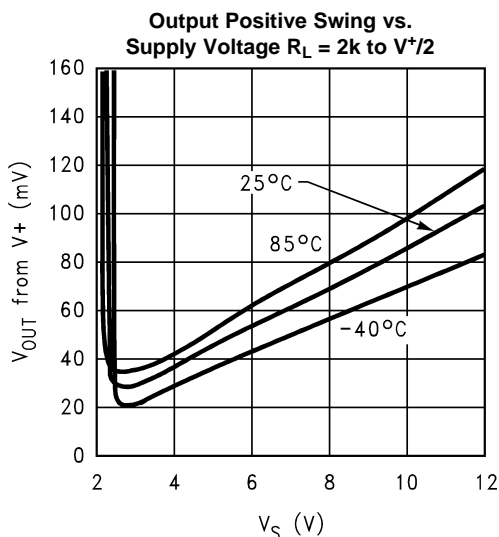

Figure 25.

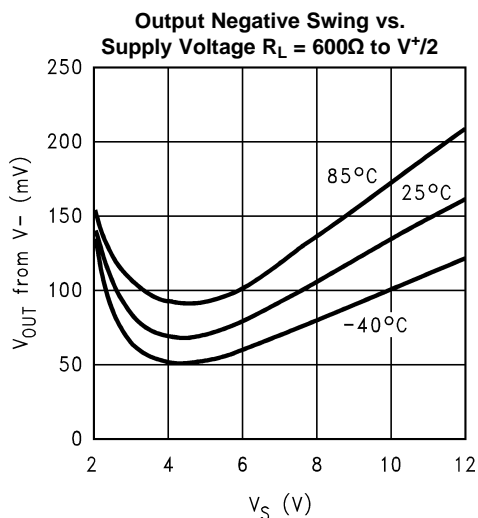

Figure 26.

Typical Performance Characteristics (continued)

$V_S = 2.7V$, Single Supply, $V_{CM} = V^+/2$, $T_A = 25^\circ C$ unless specified

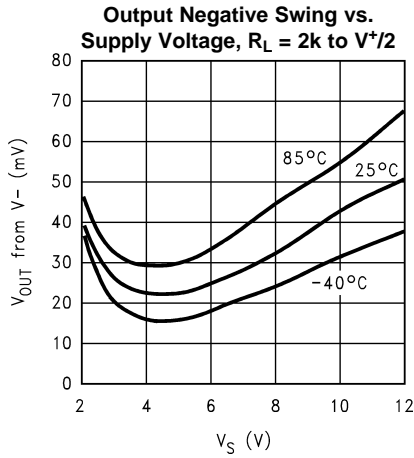

Figure 27.

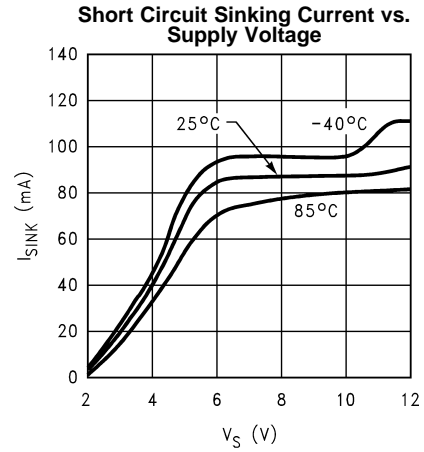

Figure 28.

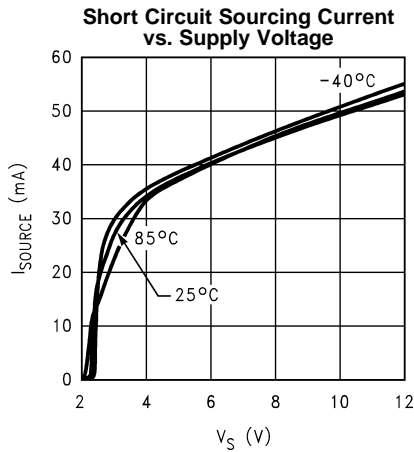

Figure 29.

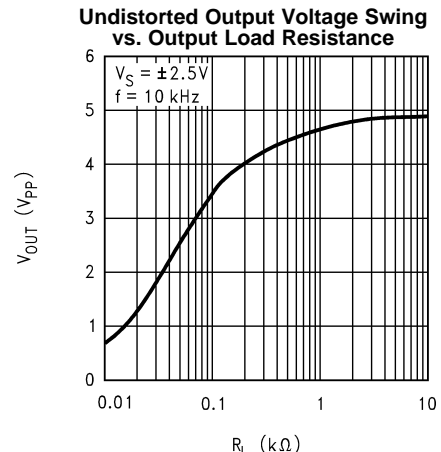

Figure 30.

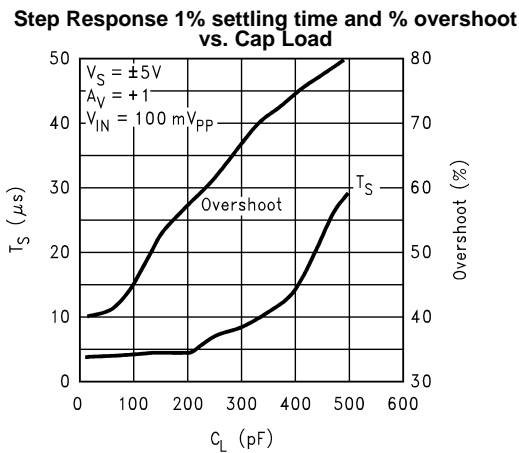

Figure 31.

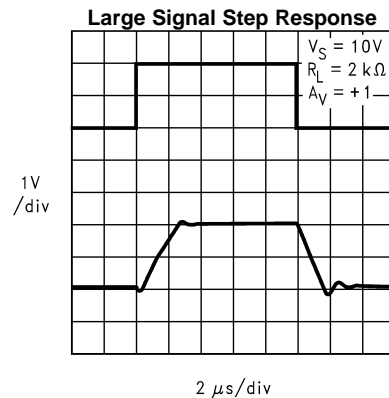
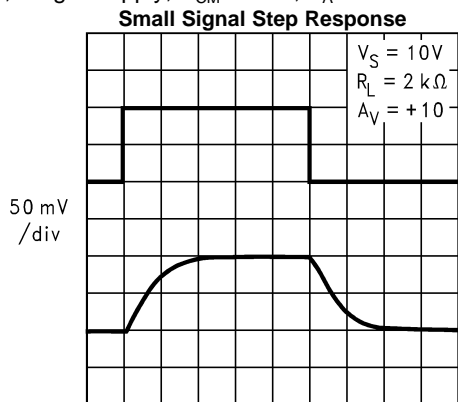

Figure 32.

Typical Performance Characteristics (continued)

$V_S = 2.7V$, Single Supply, $V_{CM} = V^+/2$, $T_A = 25^\circ C$ unless specified



2 μs /div
Figure 33.

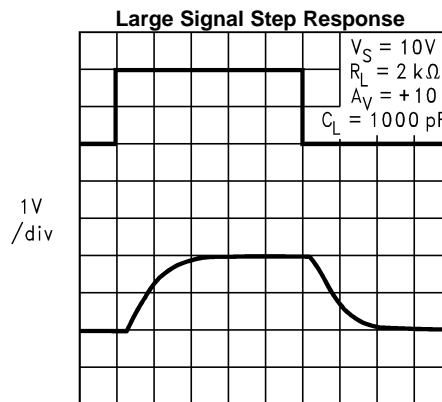

2 μs /div
Figure 34.

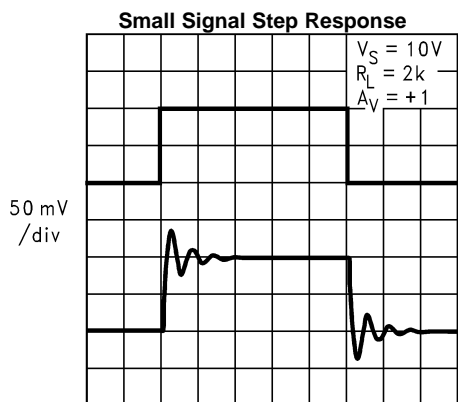

2 μs /div
Figure 35.

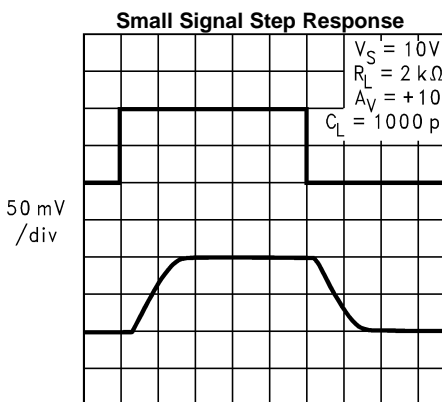

2 μs /div
Figure 36.

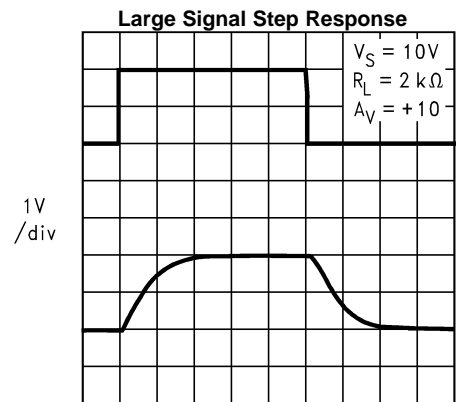

2 μs /div
Figure 37.

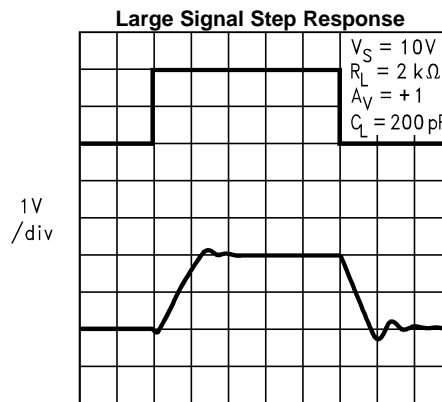

2 μs /div
Figure 38.

Typical Performance Characteristics (continued)

$V_S = 2.7V$, Single Supply, $V_{CM} = V^+/2$, $T_A = 25^\circ C$ unless specified

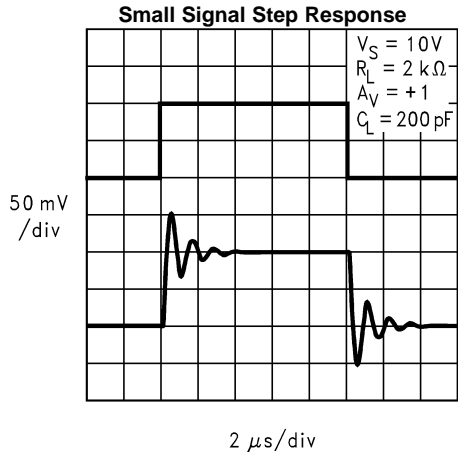

Figure 39.

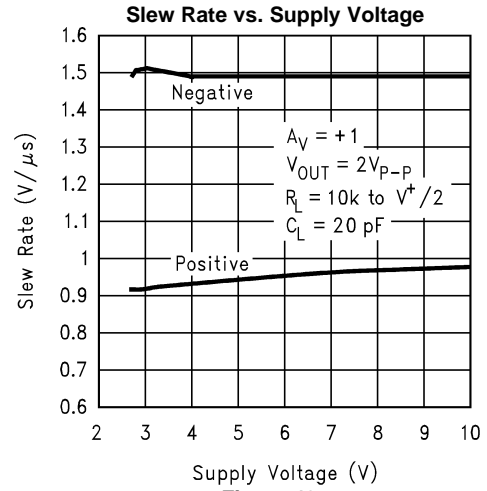

Figure 40.

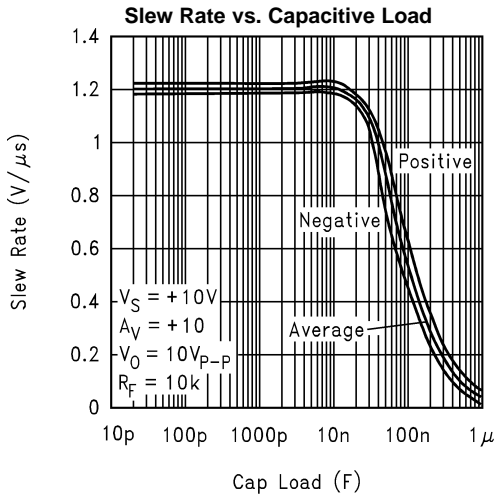

Figure 41.

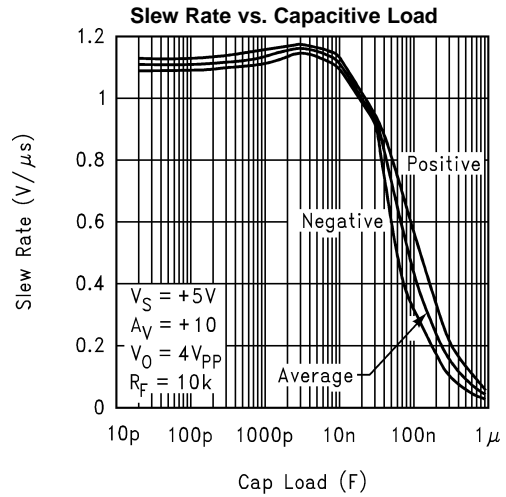

Figure 42.

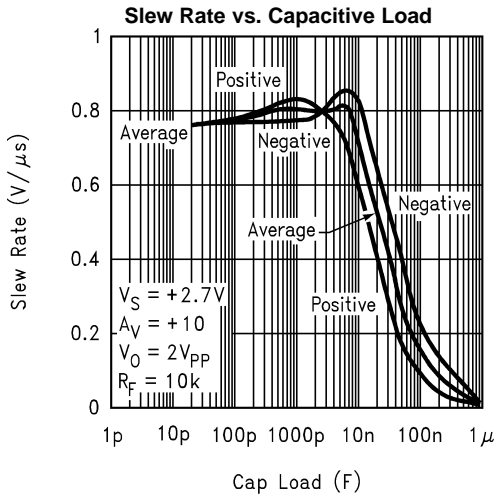

Figure 43.

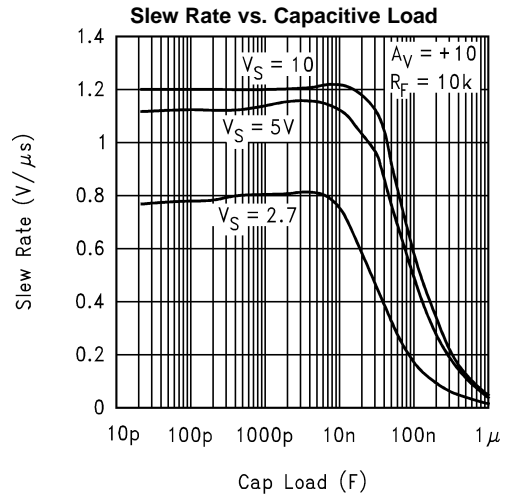

Figure 44.

Typical Performance Characteristics (continued)

$V_S = 2.7V$, Single Supply, $V_{CM} = V^+/2$, $T_A = 25^\circ C$ unless specified

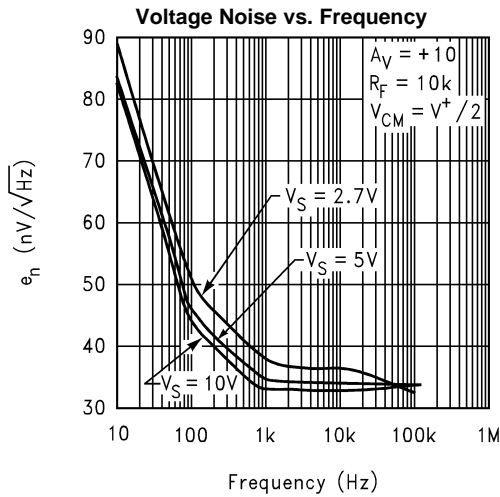

Figure 45.

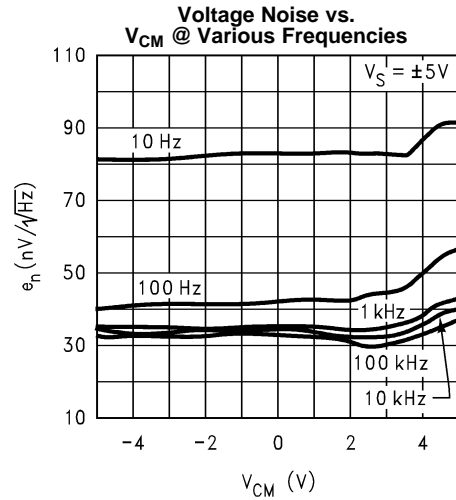

Figure 46.

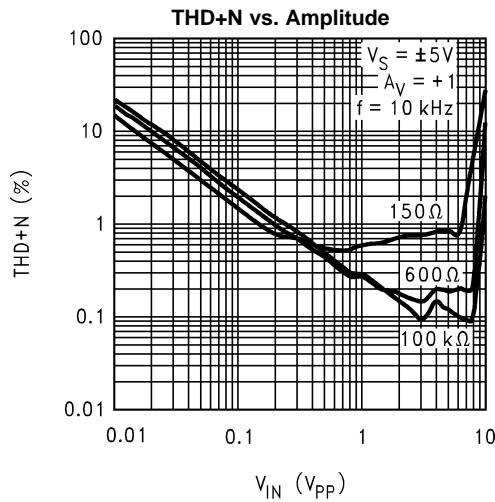

Figure 47.

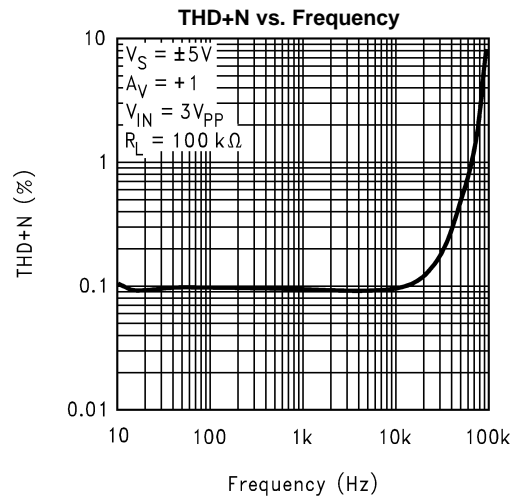

Figure 48.

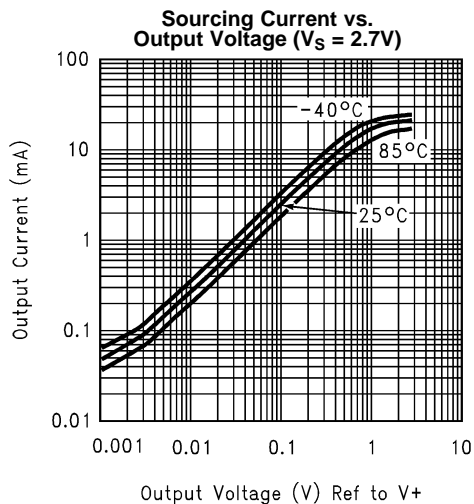

Figure 49.

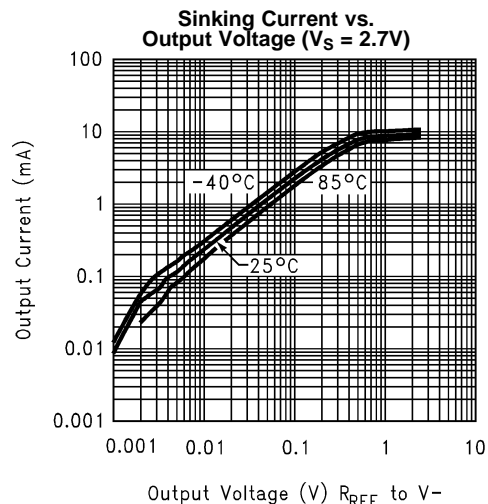

Figure 50.

Typical Performance Characteristics (continued)

$V_S = 2.7V$, Single Supply, $V_{CM} = V^+/2$, $T_A = 25^\circ C$ unless specified

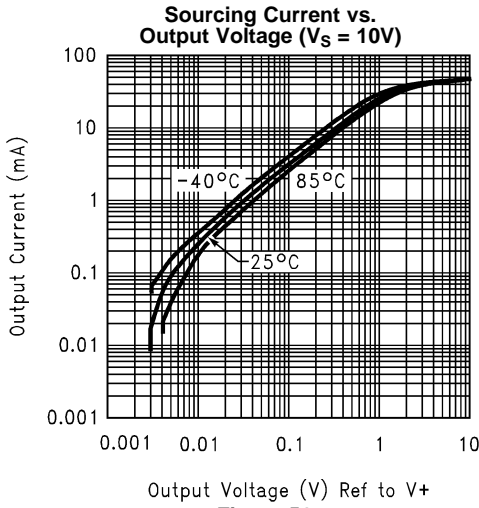

Figure 51.

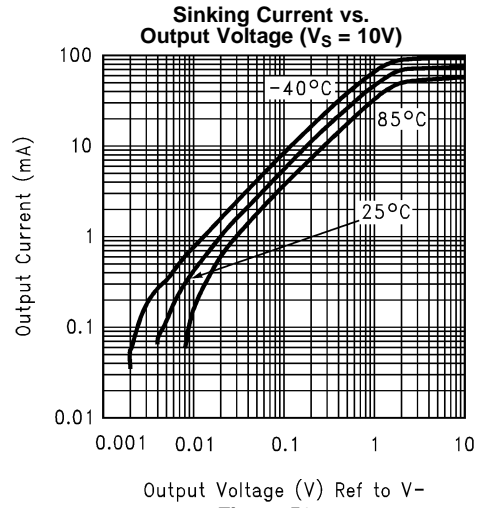

Figure 52.

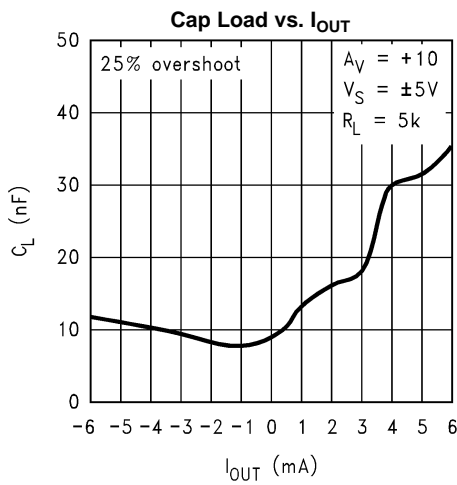

Figure 53.

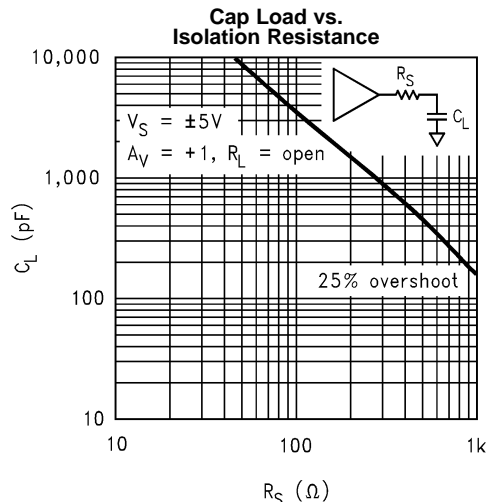

Figure 54.

APPLICATION NOTES

SHUTDOWN FEATURES

The LMC8101 is capable of being turned off in order to conserve power. Once in shutdown, the device supply current is drastically reduced (1 μ A maximum) and the output will be "Tri-stated".

The shutdown feature of the LMC8101 is designed for flexibility. The threshold level of the SD input can be referenced to either V^- or V^+ by setting the level on the SL input. When the SL input is connected to V^- , the SD threshold level is referenced to V^- and vice versa. This threshold will be about 1.5V from the supply tied to the SL pin. So, for this example, the device will be in shutdown as long as the SD pin voltage is within 1V of V^- . In order to ensure that the device would not "chatter" between active and shutdown states, hysteresis is built into the SD pin transition (see Figure 55 for an illustration of this feature). The shutdown threshold and hysteresis level are independent of the supply voltage. Figure 55 illustration applies equally well to the case when SL is tied to V^+ and the horizontal axis is referenced to V^+ instead. The SD pin should not be set within the voltage range from 1.1V to 1.9V of the selected supply voltage since this is a transition region and the device status will be undetermined.

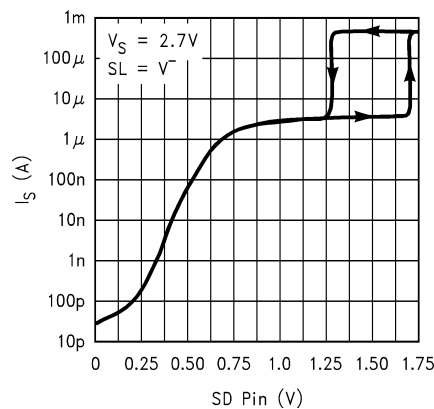

Figure 55. Supply Current vs. "SD" Voltage

Table 1 summarizes the status of the device when the SL and SD pins are connected directly to V^- or V^+ :

Table 1. LMC8101 Status Summary

SL	SD	LMC8101 Status
V^-	V^-	Shutdown
V^-	V^+	Active
V^+	V^+	Shutdown
V^+	V^-	Active

In case shutdown operation is not needed, as can be seen above, the two pins SL and SD can simply be connected to opposite supply nodes to achieve "Active" operation. The SL and SD should always be tied to a node; if left unconnected, these high impedance inputs will float to an undetermined state and the device status will be undetermined as well.

With the device in shutdown, once "Active" operation is initiated, there will be a finite amount of time required before the device output is settled to its final value. This time is less than 15 μ s. In addition, there may be some output spike during this time while the device is transitioning into a fully operational state. Some applications may be sensitive to this output spike and proper precautions should be taken in order to ensure proper operation at all times.

TINY PACKAGE

The LMC8101 is available in the DSBGA package as well the 8 pin VSSOP package. The DSBGA package requires approximately 1/4 the board area of a SOT-23. This package is less than 1mm in height allowing it to be placed in absolute minimum height clearance areas such as cellular handsets, LCD panels, PCMCIA cards, etc. More information about the DSBGA package can be found at: <http://www.ti.com/packaing>.

CONVERSION BOARDS

In order to ease the evaluation of tiny packages such as the DSBGA, there is a conversion board (LMC8101CONV) available to board designers. This board converts a DSBGA device into an 8 pin DIP package (see [Figure 56](#)) for easier handling and evaluation. This board can be ordered from Texas Instruments by contacting <http://www.ti.com>.

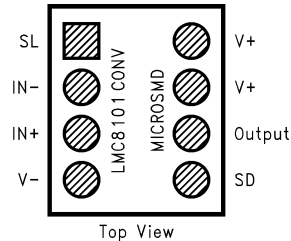

Figure 56. DSBGA Conversion Board pin-out

INCREASED OUTPUT CURRENT

Compared to the LMC7101, the LMC8101 has an improved output stage capable of up to three times larger output sourcing and sinking current. This improvement would allow a larger output voltage swing range compared to the LMC7101 when connected to relatively heavy loads. For lower supply voltages this is an added benefit since it increases the output swing range. For example, the LMC8101 can typically swing 2.5Vpp with 2mA sourcing and sinking output current ($V_s = 2.7V$) whereas the LMC7101 output swing would be limited to 1.9Vpp under the same conditions. Also, compared to the LMC7101 in the SOT-23 package, the LMC8101 can dissipate more power because both the VSSOP and the DSBGA packages have 40% better heat dissipation capability.

LOWER 1/f NOISE

The dominant input referred noise term for the LMC8101 is the input noise voltage. Input noise current for this device is of no practical significance unless the equivalent resistance it looks into is 5M Ω or higher.

The LMC8101's low frequency noise is significantly lower than that of the LMC7101. For example, at 10Hz, the input referred spot noise voltage density is 85 nV \sqrt{Hz} as compared to about 200nV \sqrt{Hz} for the LMC7101. Over a frequency range of 0.1Hz to 100Hz, the total noise of the LMC8101 will be approximately 60% less than that of the LMC7101.

LOWER THD

When connected to heavier loads, the LMC8101 has lower THD compared to the LMC7101. For example, with 5V supply at 10KHz and 2Vpp swing ($A_v = -2$), the LMC8101 THD (0.2%) is 60% less than the LMC7101's. The LMC8101 THD can be kept below 0.1% with 3Vpp at the output for up to 10KHz (refer to the [Typical Performance Characteristics](#) plots).

IMPROVING THE CAP LOAD DRIVE CAPABILITY

This can be accomplished in several ways:

- Output resistive loading increase:

The Phase Margin increases with increasing load (refer to the [Typical Performance Characteristics](#) plots). When driving capacitive loads, stability can generally be improved by allowing some output current to flow through a load. For example, the cap load drive capability can be increased from 8200pF to 16000pF if the output load is increased from 5k Ω to 600 Ω ($A_v = +10$, 25% overshoot limit, 10V supply).

- Isolation resistor between output and cap load:

This resistor will isolate the feedback path (where excessive phase shift due to output capacitance can cause instability) from the capacitive load. With a 10V supply, a 100 Ω isolation resistor allows unlimited capacitive load without oscillation compared to only 300pF without this resistor ($A_V = +1$).

- Higher supply voltage:

Operating the LMC8101 at higher supply voltages allows higher cap load tolerance. At 10V, the LMC8101's low supply voltage cap load limit of 300pF improves to about 600pF ($A_V = +1$).



- Closed loop gain increase:

As with all Op Amps, the capacitive load tolerance of the LMC8101 increases with increasing closed loop gain. In applications where the load is mostly capacitive and the resistive loading is light, stability increases when the LMC8101 is operated at a closed loop gain larger than +1.

REVISION HISTORY

Changes from Revision E (March 2013) to Revision F	Page
• Changed layout of National Data Sheet to TI format	17

PACKAGING INFORMATION

Orderable Device	Status (1)	Package Type	Package Drawing	Pins	Package Qty	Eco Plan (2)	Lead finish/ Ball material (6)	MSL Peak Temp (3)	Op Temp (°C)	Device Marking (4/5)	Samples
LMC8101TP/NOPB	ACTIVE	DSBGA	YPB	8	250	RoHS & Green	SNAGCU	Level-1-260C-UNLIM	-40 to 85	A 08	
LMC8101TPX/NOPB	ACTIVE	DSBGA	YPB	8	3000	RoHS & Green	SNAGCU	Level-1-260C-UNLIM	-40 to 85	A 08	

(1) The marketing status values are defined as follows:

ACTIVE: Product device recommended for new designs.

LIFEBUY: TI has announced that the device will be discontinued, and a lifetime-buy period is in effect.

NRND: Not recommended for new designs. Device is in production to support existing customers, but TI does not recommend using this part in a new design.

PREVIEW: Device has been announced but is not in production. Samples may or may not be available.

OBSOLETE: TI has discontinued the production of the device.

(2) **RoHS:** TI defines "RoHS" to mean semiconductor products that are compliant with the current EU RoHS requirements for all 10 RoHS substances, including the requirement that RoHS substance do not exceed 0.1% by weight in homogeneous materials. Where designed to be soldered at high temperatures, "RoHS" products are suitable for use in specified lead-free processes. TI may reference these types of products as "Pb-Free".

RoHS Exempt: TI defines "RoHS Exempt" to mean products that contain lead but are compliant with EU RoHS pursuant to a specific EU RoHS exemption.

Green: TI defines "Green" to mean the content of Chlorine (Cl) and Bromine (Br) based flame retardants meet JS709B low halogen requirements of <=1000ppm threshold. Antimony trioxide based flame retardants must also meet the <=1000ppm threshold requirement.

(3) MSL, Peak Temp. - The Moisture Sensitivity Level rating according to the JEDEC industry standard classifications, and peak solder temperature.

(4) There may be additional marking, which relates to the logo, the lot trace code information, or the environmental category on the device.

(5) Multiple Device Markings will be inside parentheses. Only one Device Marking contained in parentheses and separated by a "~" will appear on a device. If a line is indented then it is a continuation of the previous line and the two combined represent the entire Device Marking for that device.

(6) Lead finish/Ball material - Orderable Devices may have multiple material finish options. Finish options are separated by a vertical ruled line. Lead finish/Ball material values may wrap to two lines if the finish value exceeds the maximum column width.

Important Information and Disclaimer:The information provided on this page represents TI's knowledge and belief as of the date that it is provided. TI bases its knowledge and belief on information provided by third parties, and makes no representation or warranty as to the accuracy of such information. Efforts are underway to better integrate information from third parties. TI has taken and continues to take reasonable steps to provide representative and accurate information but may not have conducted destructive testing or chemical analysis on incoming materials and chemicals. TI and TI suppliers consider certain information to be proprietary, and thus CAS numbers and other limited information may not be available for release.

In no event shall TI's liability arising out of such information exceed the total purchase price of the TI part(s) at issue in this document sold by TI to Customer on an annual basis.

TAPE AND REEL INFORMATION

QUADRANT ASSIGNMENTS FOR PIN 1 ORIENTATION IN TAPE

*All dimensions are nominal

Device	Package Type	Package Drawing	Pins	SPQ	Reel Diameter (mm)	Reel Width W1 (mm)	A0 (mm)	B0 (mm)	K0 (mm)	P1 (mm)	W (mm)	Pin1 Quadrant
LMC8101TP/NOPB	DSBGA	YPB	8	250	178.0	8.4	1.57	1.57	0.76	4.0	8.0	Q1
LMC8101TPX/NOPB	DSBGA	YPB	8	3000	178.0	8.4	1.57	1.57	0.76	4.0	8.0	Q1

TAPE AND REEL BOX DIMENSIONS

*All dimensions are nominal

Device	Package Type	Package Drawing	Pins	SPQ	Length (mm)	Width (mm)	Height (mm)
LMC8101TP/NOPB	DSBGA	YPB	8	250	208.0	191.0	35.0
LMC8101TPX/NOPB	DSBGA	YPB	8	3000	208.0	191.0	35.0

YPB0008

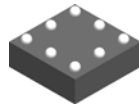

PACKAGE OUTLINE

DSBGA - 0.575 mm max height

DIE SIZE BALL GRID ARRAY

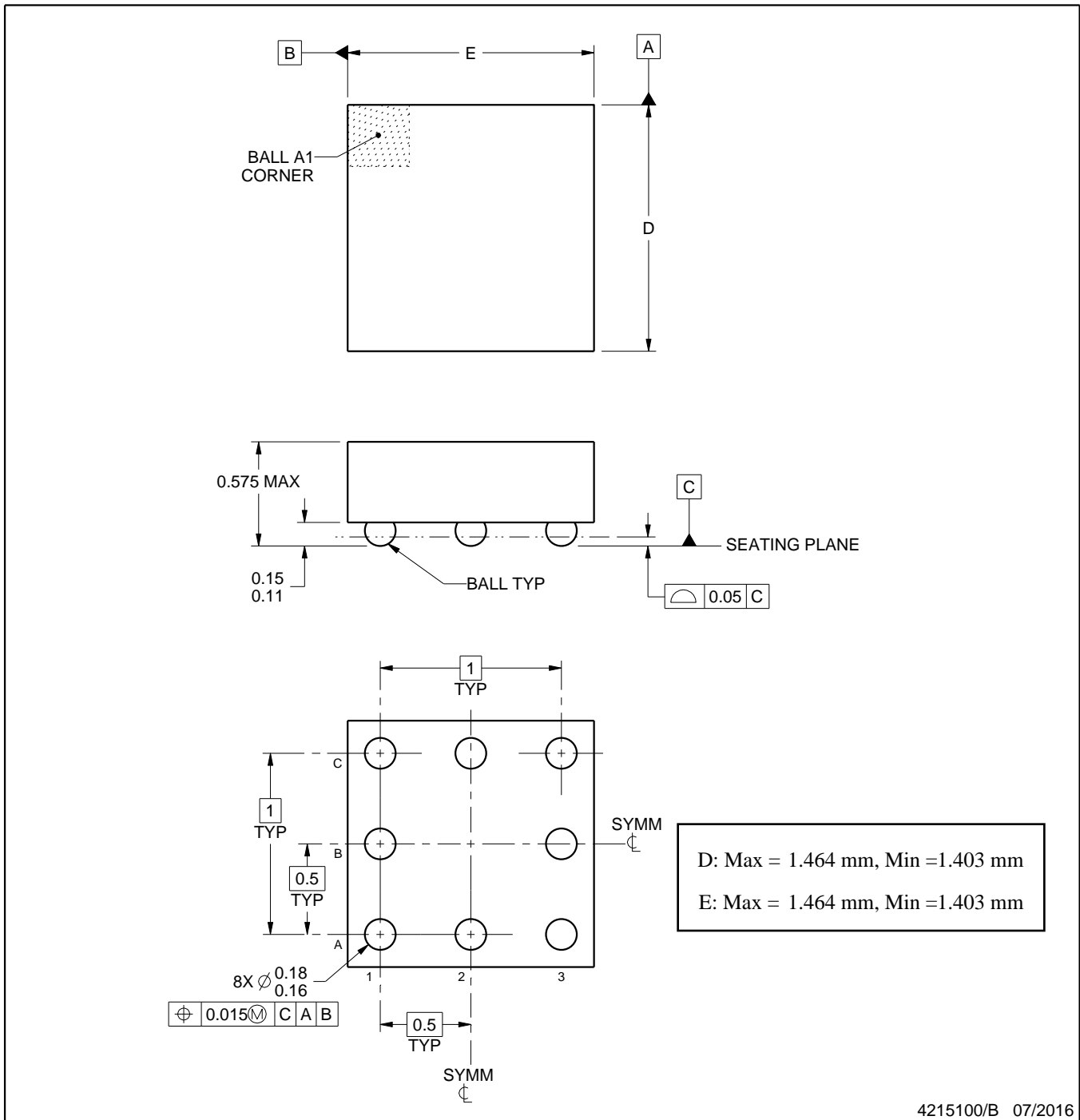

NOTES:

1. All linear dimensions are in millimeters. Any dimensions in parenthesis are for reference only. Dimensioning and tolerancing per ASME Y14.5M.
2. This drawing is subject to change without notice.

EXAMPLE BOARD LAYOUT

YPB0008

DSBGA - 0.575 mm max height

DIE SIZE BALL GRID ARRAY

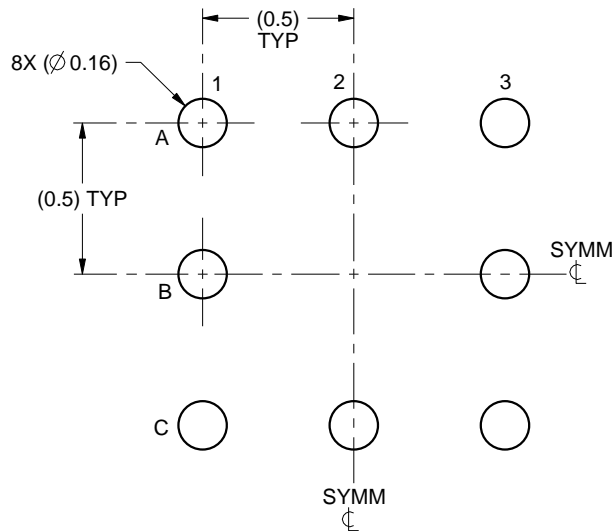

LAND PATTERN EXAMPLE
SCALE:40X

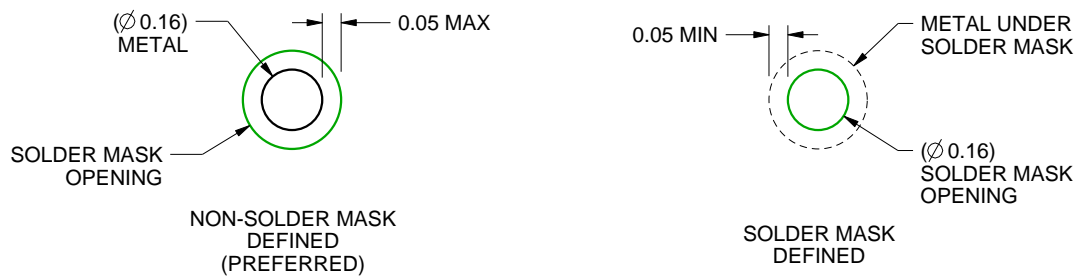

SOLDER MASK DETAILS
NOT TO SCALE

4215100/B 07/2016

NOTES: (continued)

- Final dimensions may vary due to manufacturing tolerance considerations and also routing constraints. See Texas Instruments Literature No. SNVA009 (www.ti.com/lit/snva009).

EXAMPLE STENCIL DESIGN

YPB0008

DSBGA - 0.575 mm max height

DIE SIZE BALL GRID ARRAY

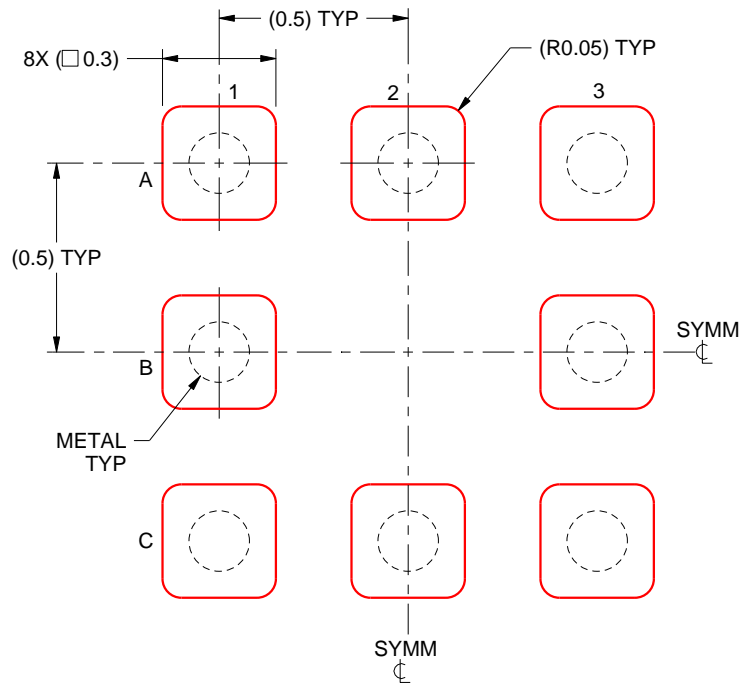

SOLDER PASTE EXAMPLE
BASED ON 0.125mm THICK STENCIL
SCALE:50X

4215100/B 07/2016

NOTES: (continued)

4. Laser cutting apertures with trapezoidal walls and rounded corners may offer better paste release.

IMPORTANT NOTICE AND DISCLAIMER

TI PROVIDES TECHNICAL AND RELIABILITY DATA (INCLUDING DATA SHEETS), DESIGN RESOURCES (INCLUDING REFERENCE DESIGNS), APPLICATION OR OTHER DESIGN ADVICE, WEB TOOLS, SAFETY INFORMATION, AND OTHER RESOURCES "AS IS" AND WITH ALL FAULTS, AND DISCLAIMS ALL WARRANTIES, EXPRESS AND IMPLIED, INCLUDING WITHOUT LIMITATION ANY IMPLIED WARRANTIES OF MERCHANTABILITY, FITNESS FOR A PARTICULAR PURPOSE OR NON-INFRINGEMENT OF THIRD PARTY INTELLECTUAL PROPERTY RIGHTS.

These resources are intended for skilled developers designing with TI products. You are solely responsible for (1) selecting the appropriate TI products for your application, (2) designing, validating and testing your application, and (3) ensuring your application meets applicable standards, and any other safety, security, regulatory or other requirements.

These resources are subject to change without notice. TI grants you permission to use these resources only for development of an application that uses the TI products described in the resource. Other reproduction and display of these resources is prohibited. No license is granted to any other TI intellectual property right or to any third party intellectual property right. TI disclaims responsibility for, and you will fully indemnify TI and its representatives against, any claims, damages, costs, losses, and liabilities arising out of your use of these resources.

TI's products are provided subject to [TI's Terms of Sale](#) or other applicable terms available either on [ti.com](https://www.ti.com) or provided in conjunction with such TI products. TI's provision of these resources does not expand or otherwise alter TI's applicable warranties or warranty disclaimers for TI products.

TI objects to and rejects any additional or different terms you may have proposed.

Mailing Address: Texas Instruments, Post Office Box 655303, Dallas, Texas 75265
Copyright © 2024, Texas Instruments Incorporated