

FEATURES

- Qualified for Automotive Applications
- 150-mA Low-Dropout (LDO) Voltage Regulator
- Dropout Voltage to 85 mV (Typ) at 150 mA (TPS76550)
- Ultra-Low 35- μ A (Typ) Quiescent Current
- 3% Tolerance Over Specified Conditions for Fixed-Output Versions
- Open-Drain Power Good Output
- Thermal Shutdown Protection

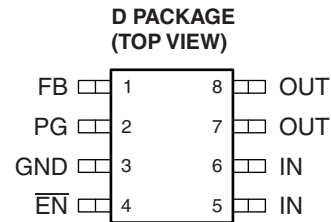

DESCRIPTION/ORDERING INFORMATION

This device is designed to have an ultra-low quiescent current and be stable with a 4.7- μ F capacitor. This combination provides high performance at a reasonable cost.

Because the PMOS device behaves as a low-value resistor, the dropout voltage is very low (typically 85 mV at an output current of 150 mA for the TPS76550) and is directly proportional to the output current. Additionally, since the PMOS pass element is a voltage-driven device, the quiescent current is very low and independent of output loading (typically 35 μ A over the full range of output current, 0 mA to 150 mA). These two key specifications yield a significant improvement in operating life for battery-powered systems. This LDO also features a sleep mode; applying a TTL high signal to EN (enable) shuts down the regulator, reducing the quiescent current to less than 1 μ A (typ).

Power good (PG) is an active-high output, which can be used to implement a power-on reset or a low-battery indicator.

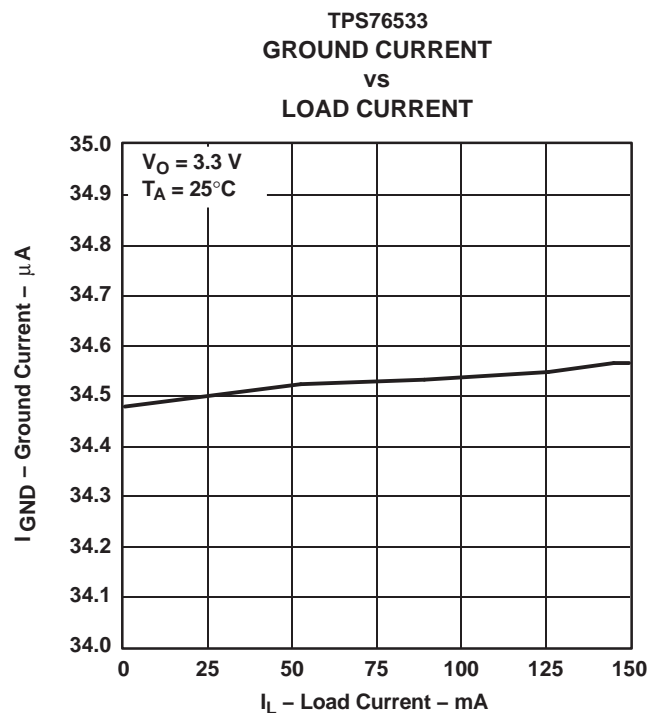
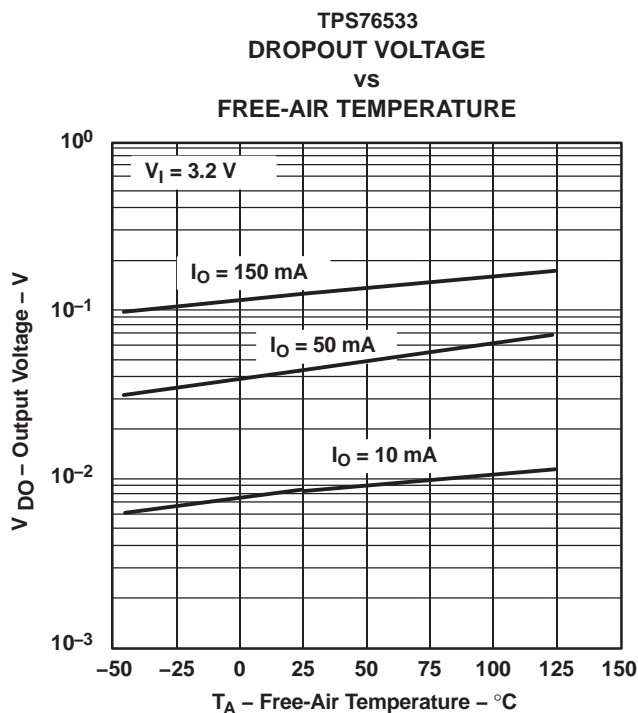

Please be aware that an important notice concerning availability, standard warranty, and use in critical applications of Texas Instruments semiconductor products and disclaimers thereto appears at the end of this data sheet.

TPS76501-Q1 ULTRALOW QUIESCENT CURRENT 150-mA LOW-DROPOUT VOLTAGE REGULATOR

SLVS800–DECEMBER 2007

The TPS765xx is offered in 1.5-V, 1.8-V, 2.5-V, 2.7-V, 2.8-V, 3-V, 3.3-V and 5-V fixed-voltage versions and in an adjustable version (programmable over the range of 1.25 V to 5.5 V). Output voltage tolerance is specified as a maximum of 3% over line, load, and temperature ranges. The TPS765xx family is available in an 8-pin SOIC package.

ORDERING INFORMATION⁽¹⁾

T _A	V _O (TYP)	PACKAGE ⁽²⁾		ORDERABLE PART NUMBER	TOP-SIDE MARKING
-40°C to 125°C	Adjustable	SOIC – D	Reel of 2500	TPS76501QDRQ1	76501Q

- (1) For the most current package and ordering information, see the Package Option Addendum at the end of this document, or see the TI web site at www.ti.com.
 (2) Package drawings, thermal data, and symbolization are available at www.ti.com/packaging.

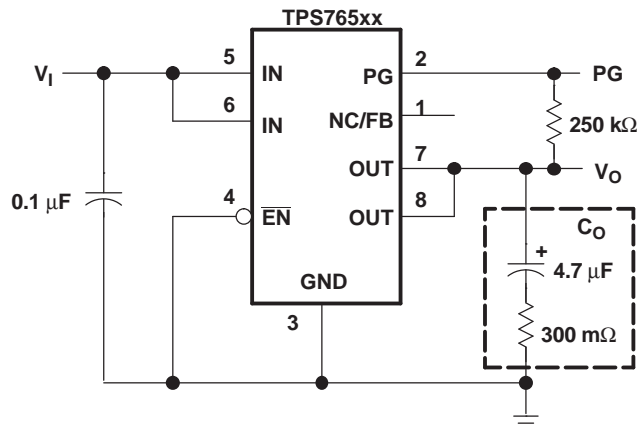
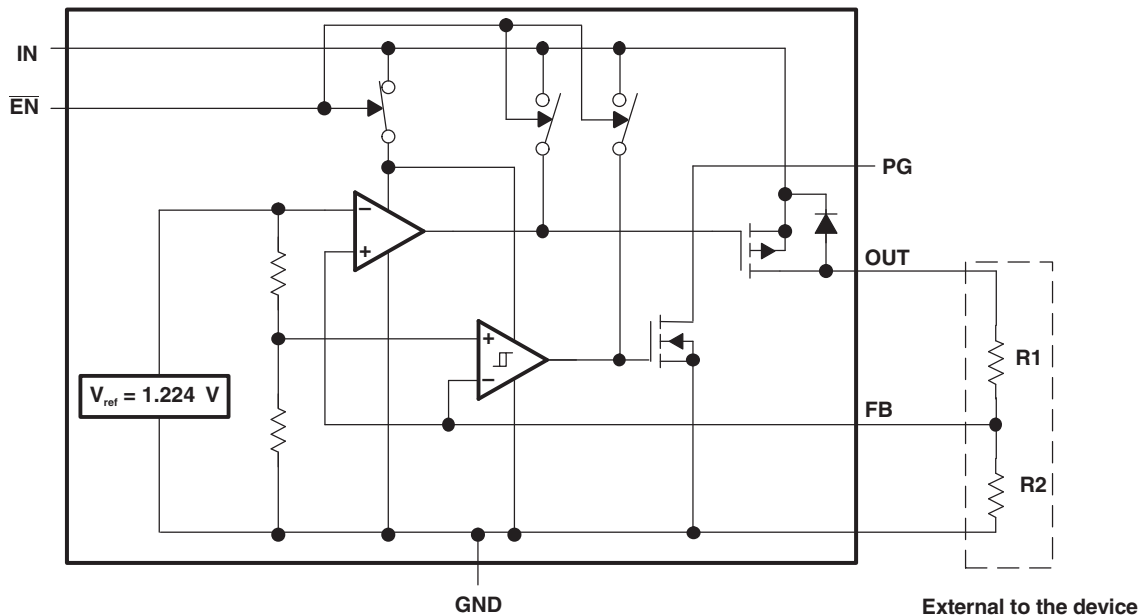
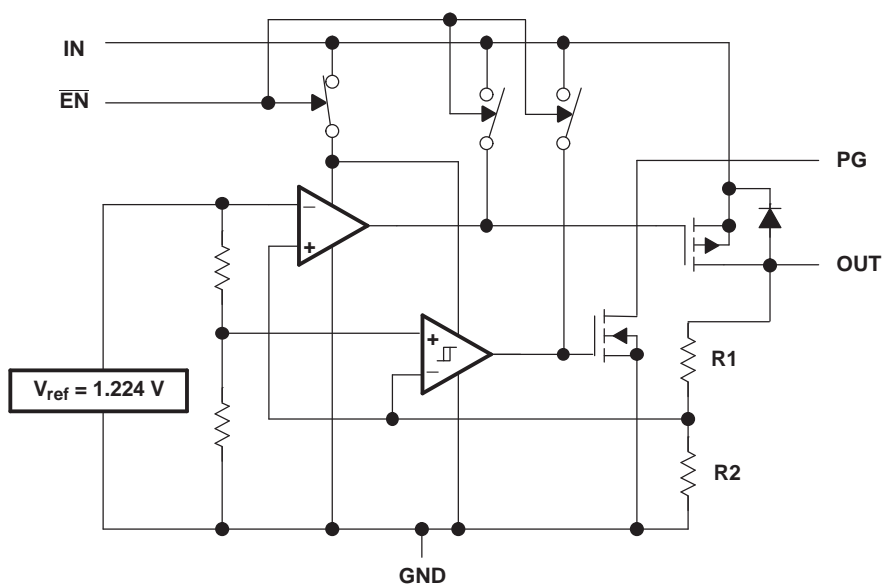

Figure 1. Typical Application Configuration for Fixed Output Options

FUNCTIONAL BLOCK DIAGRAM – ADJUSTABLE-VOLTAGE VERSION



FUNCTIONAL BLOCK DIAGRAM – FIXED-VOLTAGE VERSION



TERMINAL FUNCTIONS

TERMINAL		I/O	DESCRIPTION
NAME	NO.		
EN	1	I	Enable
FB	2	I	Feedback voltage
GND	3		Regulator ground
IN	4, 5	I	Input voltage
OUT	6, 7	O	Regulated output voltage
PG	8	O	Power good output

TPS76501-Q1

ULTRALOW QUIESCENT CURRENT 150-mA LOW-DROPOUT VOLTAGE REGULATOR

SLVS800–DECEMBER 2007

ABSOLUTE MAXIMUM RATINGS⁽¹⁾⁽²⁾

over operating free-air temperature range (unless otherwise noted)

		VALUE	
V_I	Input voltage range	–0.3 V to 13.5 V	
	Voltage range at \overline{EN}	–0.3 V to 16.5 V	
	Maximum PG voltage	16.5 V	
I_O	Peak output current	Internally limited	
P_D	Continuous total power dissipation	See <i>Dissipation Ratings</i>	
V_O	Output voltage (OUT, FB)	7 V	
T_J	Operating virtual junction temperature range	–40°C to 125°C	
T_{stg}	Storage temperature range	–65°C to 150°C	
ESD	Electrostatic discharge rating	Human-Body Model	2000 V
		Machine Model	200 V
		Charged-Device Model	1500 V

- (1) Stresses beyond those listed under *absolute maximum ratings* may cause permanent damage to the device. These are stress ratings only, and functional operation of the device at these or any other conditions beyond those indicated under *recommended operating conditions* is not implied. Exposure to absolute-maximum-rated conditions for extended periods may affect device reliability.
- (2) All voltage values are with respect to network terminal ground.

DISSIPATION RATINGS

PACKAGE	AIR FLOW (CFM)	POWER RATING $T_A < 25^\circ\text{C}$	DERATING FACTOR $T_A \geq 25^\circ\text{C}$	POWER RATING $T_A = 70^\circ\text{C}$	POWER RATING $T_A = 85^\circ\text{C}$
D	0	568 mW	5.68 mW/°C	312 mW	227 mW
	250	904 mW	9.04 mW/°C	497 mW	361 mW

RECOMMENDED OPERATING CONDITIONS

		MIN	MAX	UNIT
V_I	Input voltage ⁽¹⁾	2.7	10	V
V_O	Output voltage	1.2	5.5	V
I_O	Output current ⁽²⁾	0	150	mA
T_J	Operating virtual junction temperature	–40	125	°C

- (1) To calculate the minimum input voltage for your maximum output current, use the following equation: $V_{I(\min)} = V_{O(\max)} + V_{DO(\max \text{ load})}$.
- (2) Continuous current and operating junction temperature are limited by internal protection circuitry, but it is not recommended that the device operate under conditions beyond those specified in this table for extended periods of time.

ELECTRICAL CHARACTERISTICS
 $V_I = V_{O(\text{typ})} + 1 \text{ V}$, $I_O = 10 \text{ } \mu\text{A}$, $\overline{\text{EN}} = 0 \text{ V}$, $C_O = 4.7 \text{ } \mu\text{F}$ (unless otherwise noted)

PARAMETER		TEST CONDITIONS	T _J	MIN	TYP	MAX	UNIT
Output voltage ⁽¹⁾	TPS76501	5.5 V ≥ V _O ≥ 1.25 V	25°C	V _O			V
			–40°C to 125°C	0.97V _O	1.03V _O		
	TPS76515	2.7 V < V _{IN} < 10 V	25°C	1.5			
			–40°C to 125°C	1.455	1.545		
	TPS76518	2.8 V < V _{IN} < 10 V	25°C	1.8			
			–40°C to 125°C	1.746	1.854		
	TPS76525	3.5 V < V _{IN} < 10 V	25°C	2.5			
			–40°C to 125°C	2.425	2.575		
	TPS76527	3.7 V < V _{IN} < 10 V	25°C	2.7			
			–40°C to 125°C	2.619	2.781		
	TPS76528	3.8 V < V _{IN} < 10 V	25°C	2.8			
			–40°C to 125°C	2.716	2.884		
	TPS76530	4 V < V _{IN} < 10 V	25°C	3			
			–40°C to 125°C	2.910	3.090		
TPS76533	4.3 V < V _{IN} < 10 V	25°C	3.3				
		–40°C to 125°C	3.201	3.399			
TPS76550	6 V < V _{IN} < 10 V	25°C	5				
		–40°C to 125°C	4.850	5.150			
Quiescent current (GND current) ⁽¹⁾		10 μA < I _O < 150 mA	25°C	35			μA
		I _O = 150 mA	–40°C to 125°C	50			
Output voltage line regulation ⁽¹⁾⁽²⁾ (ΔV _O /V _O)		V _O + 1 V < V _I ≤ 10 V	25°C	0.01			%/V
Load regulation		I _O = 10 μA to 150 mA	–40°C to 125°C	0.3			%
Output noise voltage		BW = 300 Hz to 50 kHz, C _O = 4.7 μF	25°C	200			μVrms
Output current limit		V _O = 0 V	–40°C to 125°C	0.8		1.2	A
Thermal shutdown junction temperature				150			°C
Standby current		$\overline{\text{EN}} = V_I$, 2.7 V < V _I < 10 V	25°C	1			μA
			–40°C to 125°C	10			
FB input current	TPS76501	FB = 1.5 V	–40°C to 125°C	2			nA
High-level $\overline{\text{EN}}$ input voltage			–40°C to 125°C	2			V
Low-level $\overline{\text{EN}}$ input voltage			–40°C to 125°C	0.8			V
Power-supply ripple rejection ⁽¹⁾		f = 1 kHz, C _O = 4.7 μF, I _O = 10 mA	25°C	63			dB
PG	Minimum input voltage for valid PG	I _{O(PG)} = 300 μA	–40°C to 125°C	1.1			V
	Trip threshold voltage	V _O decreasing	–40°C to 125°C	92	98		%V _O
	Hysteresis voltage	Measured at V _O	–40°C to 125°C	0.5			%V _O
	Output low voltage	V _I = 2.7 V, I _{O(PG)} = 1 mA	–40°C to 125°C	0.15	0.4		V
	Leakage current	V _(PG) = 5 V	–40°C to 125°C			1	μA
$\overline{\text{EN}}$ input current		$\overline{\text{EN}} = 0 \text{ V}$	–40°C to 125°C	–1	0	1	μA
		$\overline{\text{EN}} = V_I$		–1		1	

(1) Minimum IN operating voltage is 2.7 V or V_{O(typ)} + 1 V, whichever is greater. Maximum IN voltage 10 V.

(2) If V_O ≤ 1.8 V then V_{I(min)} = 2.7 V, V_{I(max)} = 10 V:

$$\text{Line Regulation (mV)} = (\%/\text{V}) \times \frac{V_O(V_{I(\text{max})} - 2.7 \text{ V})}{100} \times 1000$$

If V_O ≥ 2.5 V then V_{I(min)} = V_O + 1 V, V_{I(max)} = 10 V:

$$\text{Line Regulation (mV)} = (\%/\text{V}) \times \frac{V_O(V_{I(\text{max})} - (V_O + 1 \text{ V}))}{100} \times 1000$$

TPS76501-Q1
ULTRALOW QUIESCENT CURRENT 150-mA LOW-DROPOUT
VOLTAGE REGULATOR

SLVS800–DECEMBER 2007

ELECTRICAL CHARACTERISTICS (continued)

$V_I = V_{O(\text{typ})} + 1 \text{ V}$, $I_O = 10 \mu\text{A}$, $\overline{\text{EN}} = 0 \text{ V}$, $C_O = 4.7 \mu\text{F}$ (unless otherwise noted)

PARAMETER		TEST CONDITIONS	T _J	MIN	TYP	MAX	UNIT
Dropout voltage ⁽³⁾	TPS76528	$I_O = 150 \text{ mA}$	25°C		190		mV
			–40°C to 125°C			330	
	TPS76530		25°C		160		
			–40°C to 125°C			280	
	TPS76533		25°C		140		
			–40°C to 125°C			240	
	TPS76550		25°C		85		
			–40°C to 125°C			150	

(3) IN voltage equals $V_{O(\text{typ})} - 100 \text{ mV}$ with output voltage set to 3.3 V nominal with external resistor divider. TPS76515, TPS76518, TPS76525, and TPS76527 dropout voltage limited by input voltage range limitations (i.e., TPS76530 input voltage must drop to 2.9 V for purpose of this test).

TYPICAL CHARACTERISTICS
Table of Graphs

		FIGURE
Output voltage	vs Load current	2, 3
	vs Free-air temperature	4, 5
Ground current	vs Load current	6, 7
	vs Free-air temperature	8, 9
Power-supply ripple rejection	vs Frequency	10
Output spectral noise density	vs Frequency	11
Output impedance	vs Frequency	12
Dropout voltage	vs Free-air temperature	13, 14
Line transient response		15, 17
Load transient response		16, 18
Output voltage	vs Time	19
Dropout voltage	vs Input voltage	20
Equivalent series resistance (ESR) ⁽¹⁾	vs Output current	21 through 24
Equivalent series resistance (ESR) ⁽¹⁾	vs Added ceramic capacitance	25, 26

(1) Equivalent series resistance (ESR) refers to the total series resistance, including the ESR of the capacitor, any series resistance added externally, and PWB trace resistance to C_O .

TPS76501-Q1
ULTRALOW QUIESCENT CURRENT 150-mA LOW-DROPOUT
VOLTAGE REGULATOR

SLVS800–DECEMBER 2007

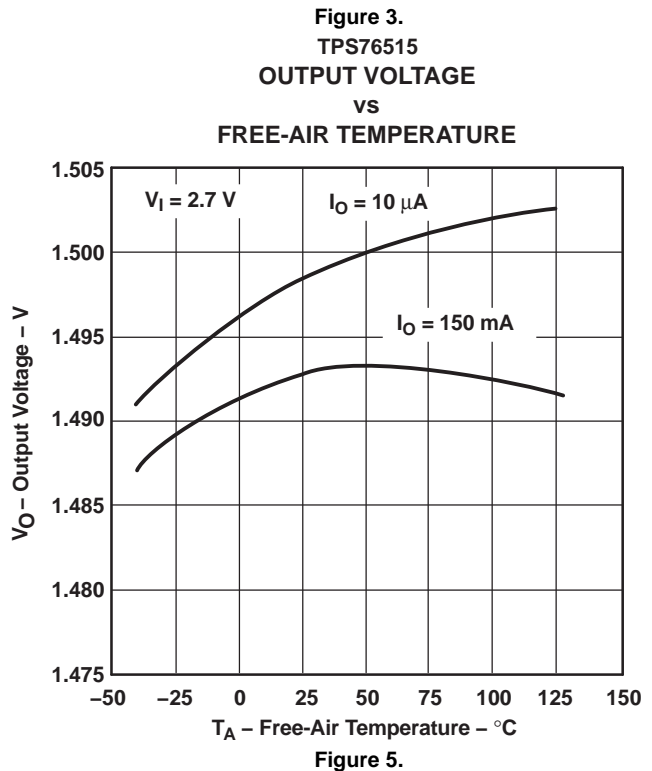
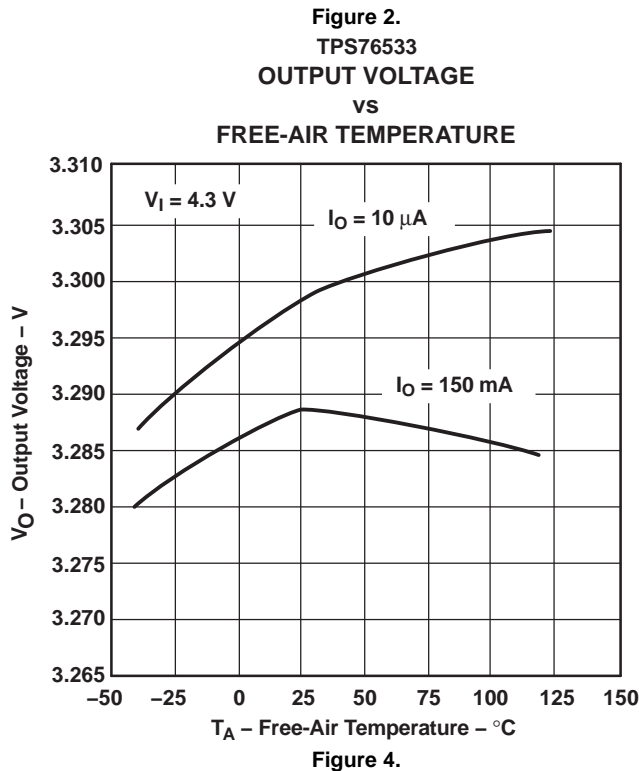
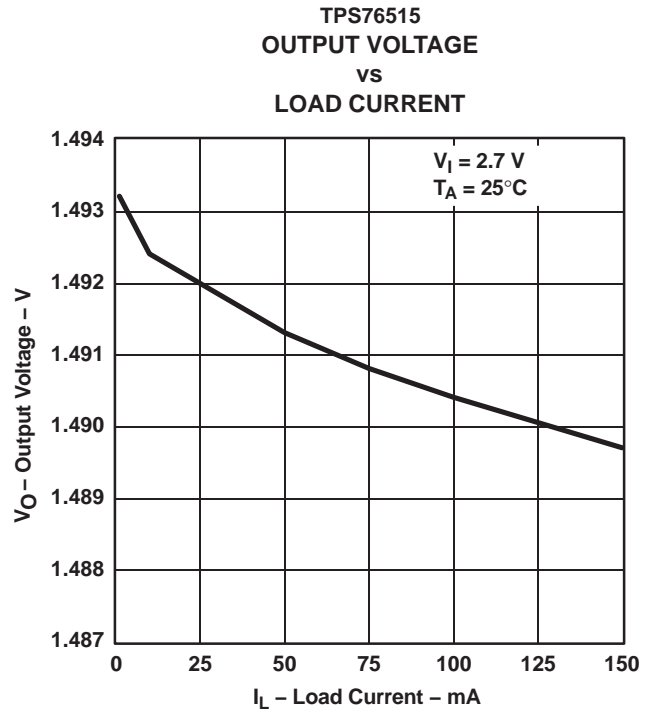
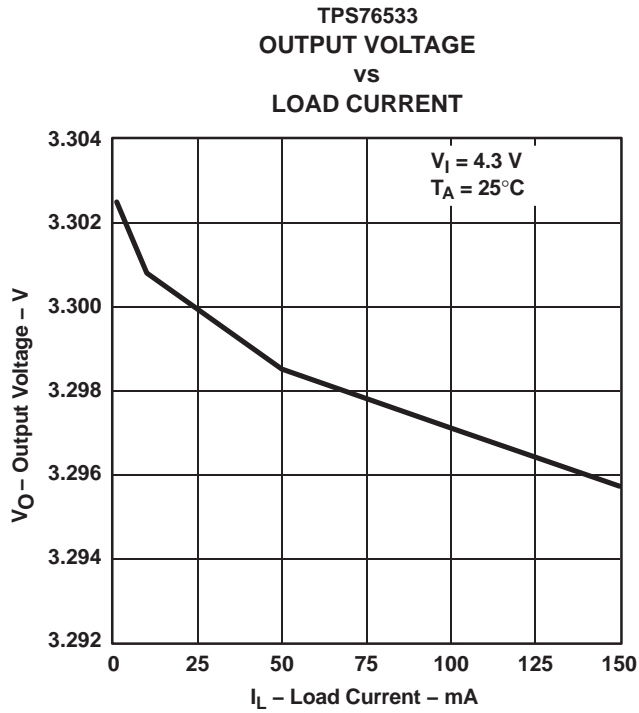

TPS76533
GROUND CURRENT
vs
LOAD CURRENT

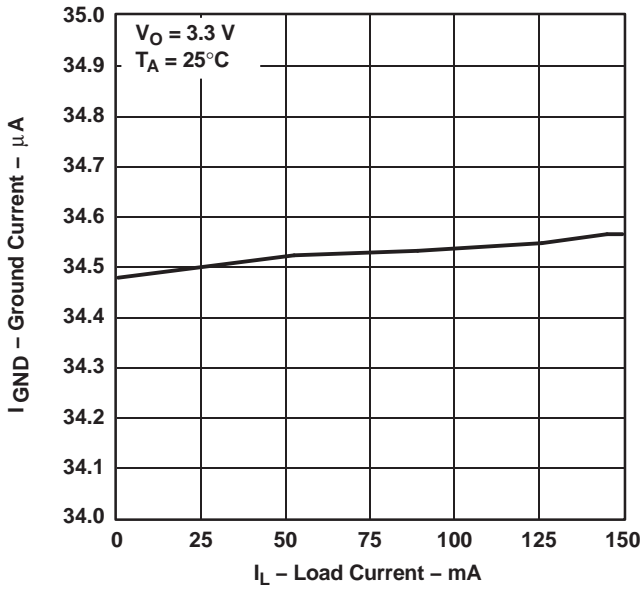

Figure 6.

TPS76533
GROUND CURRENT
vs
FREE-AIR TEMPERATURE

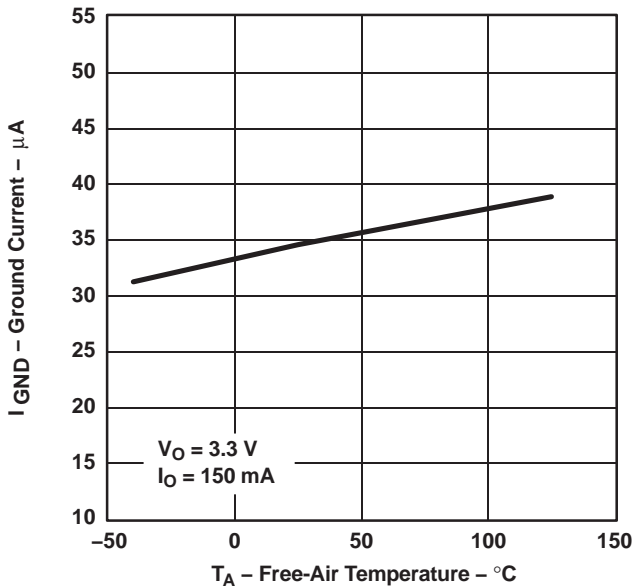

Figure 8.

TPS76515
GROUND CURRENT
vs
LOAD CURRENT

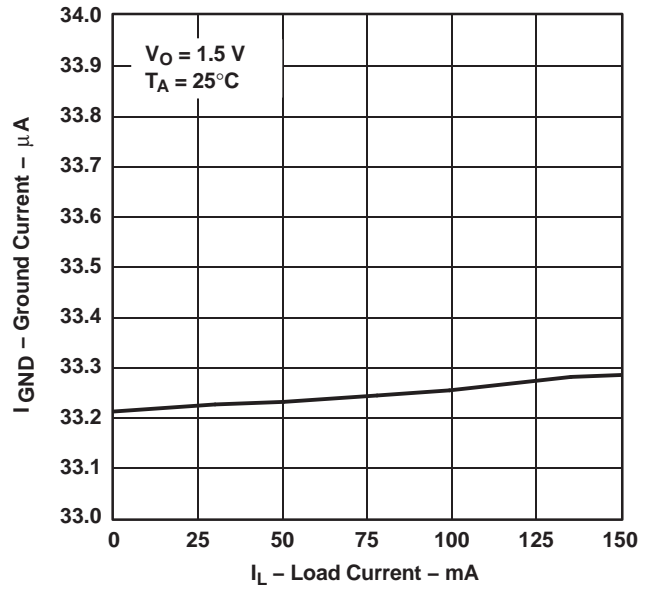

Figure 7.

TPS76515
GROUND CURRENT
vs
FREE-AIR TEMPERATURE

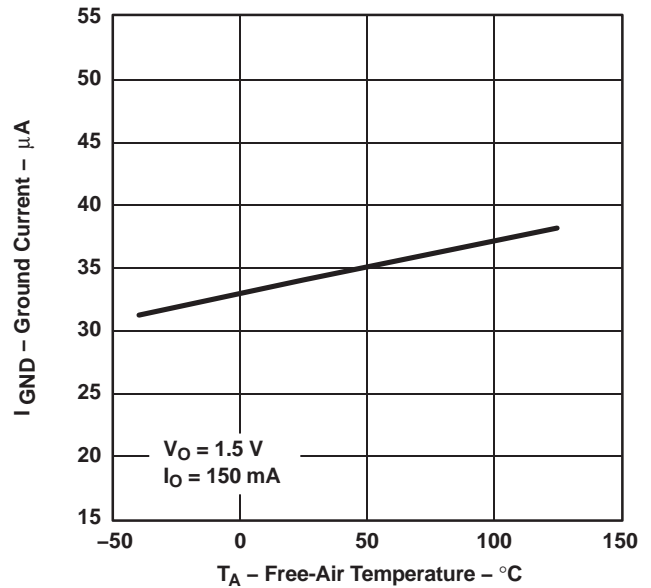
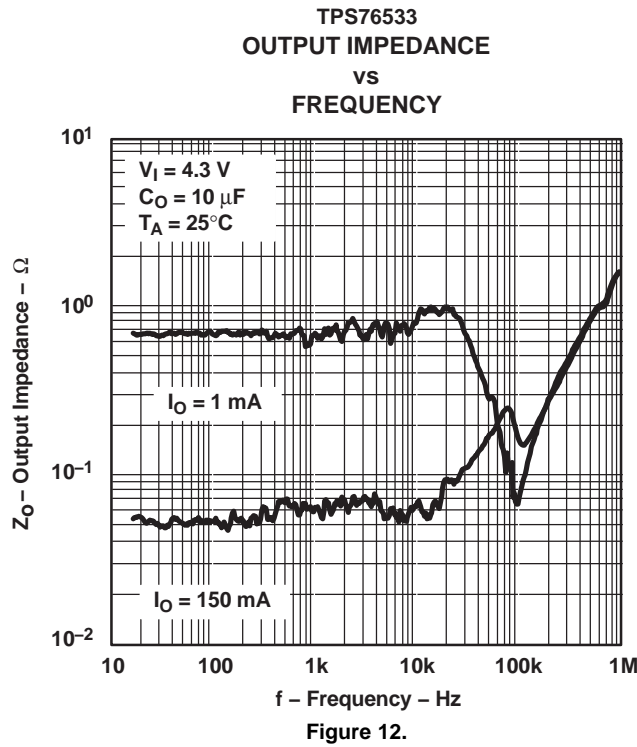
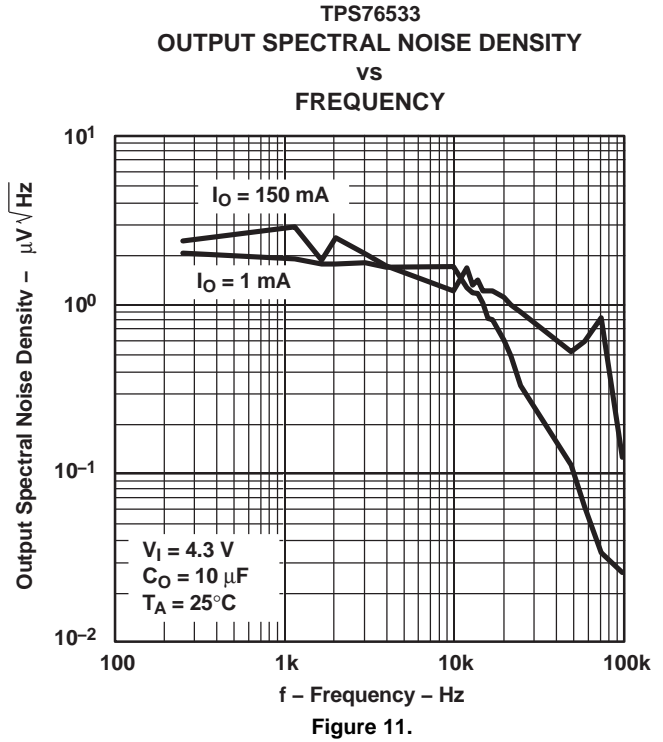
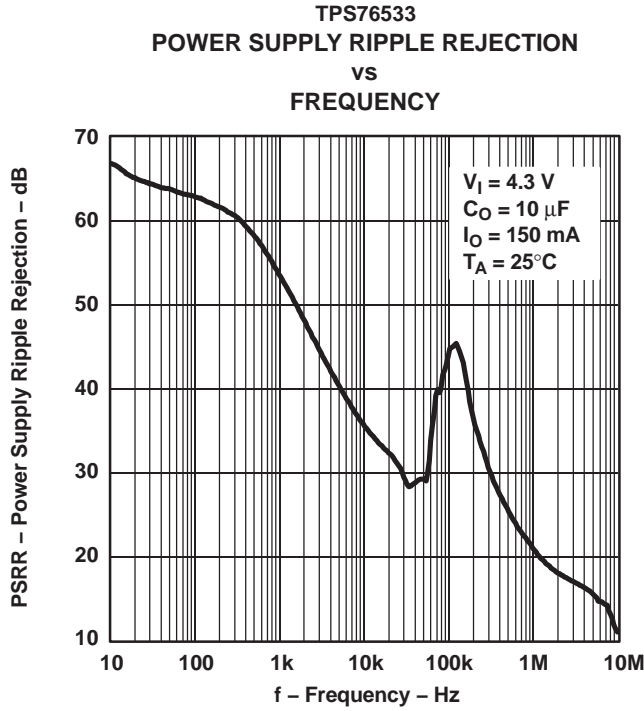

Figure 9.

TPS76501-Q1
ULTRALOW QUIESCENT CURRENT 150-mA LOW-DROPOUT
VOLTAGE REGULATOR

SLVS800–DECEMBER 2007



TPS76550
DROPOUT VOLTAGE
vs
FREE-AIR TEMPERATURE

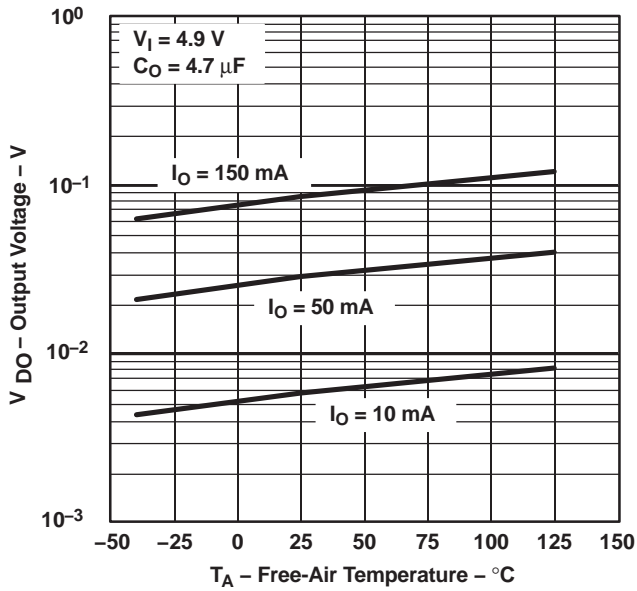

Figure 13.

TPS76515

TPS76533
DROPOUT VOLTAGE
vs
FREE-AIR TEMPERATURE

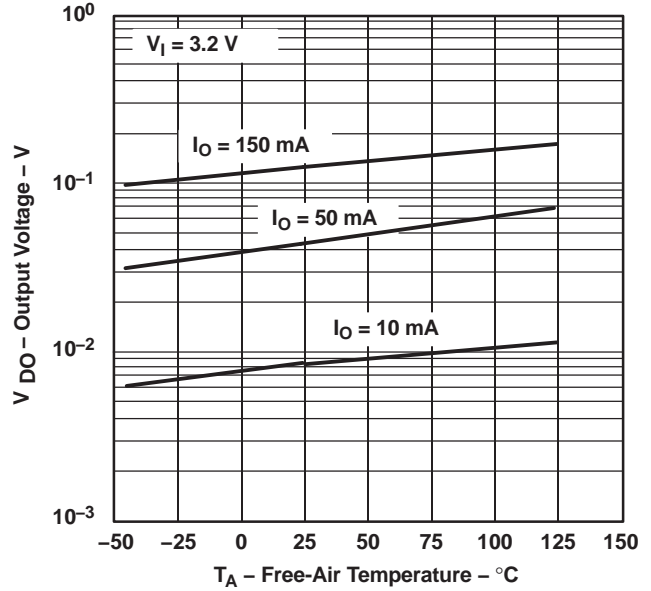

Figure 14.

TPS76515

LINE TRANSIENT RESPONSE

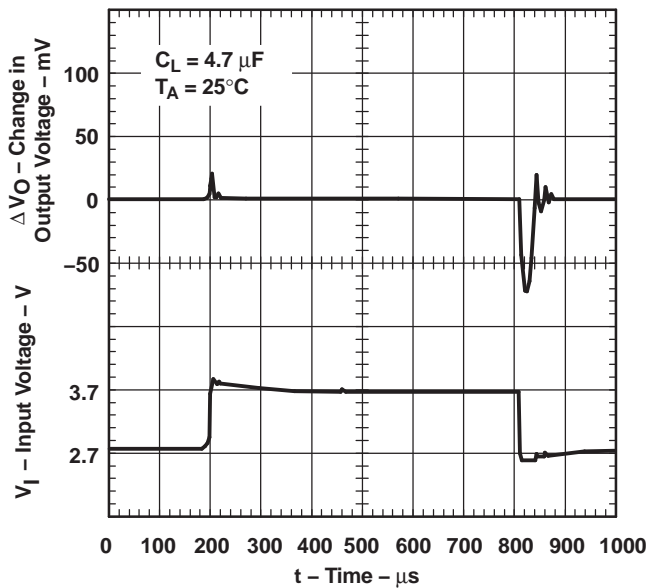

Figure 15.

LOAD TRANSIENT RESPONSE

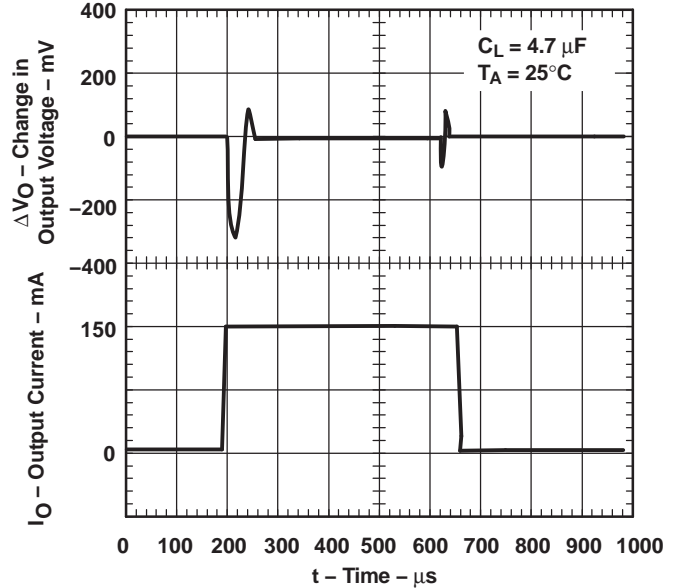

Figure 16.

TPS76501-Q1 ULTRALOW QUIESCENT CURRENT 150-mA LOW-DROPOUT VOLTAGE REGULATOR

SLVS800-DECEMBER 2007



TPS76533
LINE TRANSIENT RESPONSE

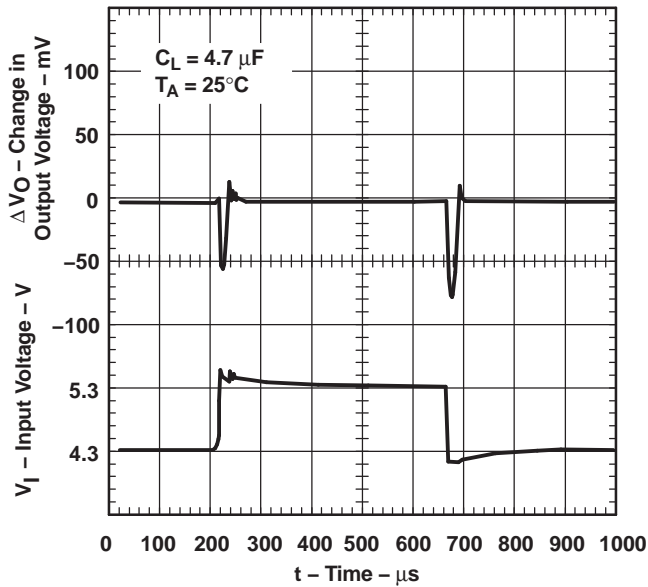

Figure 17.

TPS76533

TPS76533
LOAD TRANSIENT RESPONSE

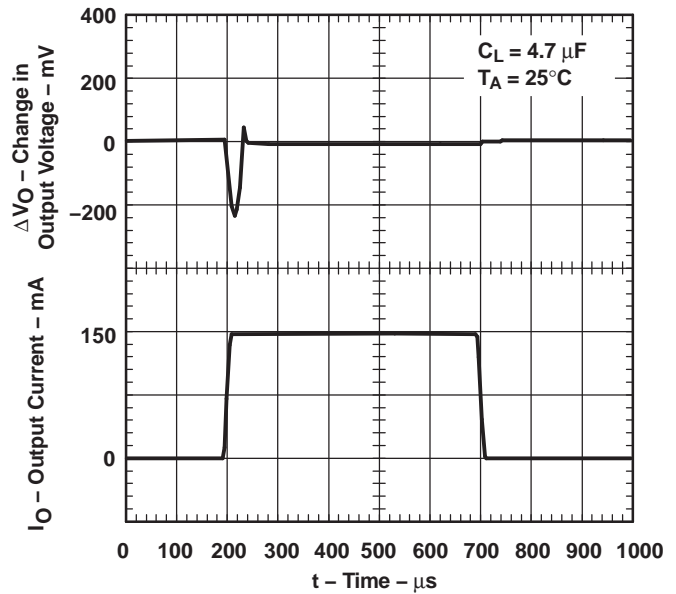

Figure 18.

TPS76501

OUTPUT VOLTAGE
vs
TIME (AT STARTUP)

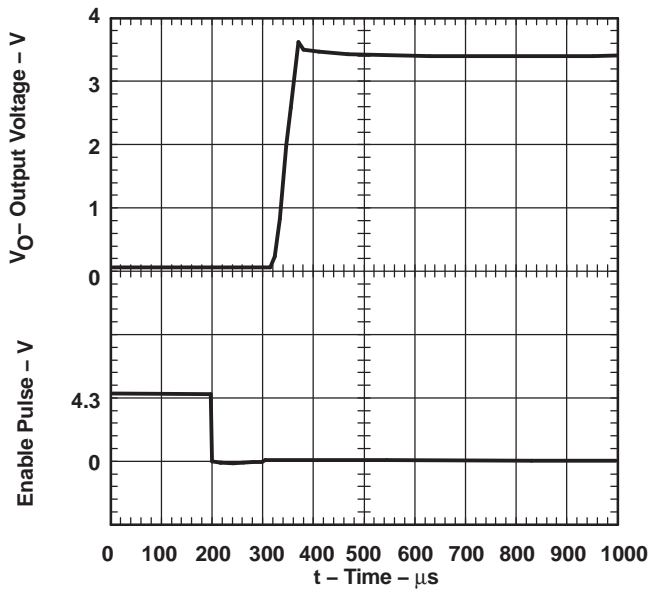

Figure 19.

DROPOUT VOLTAGE
vs
INPUT VOLTAGE

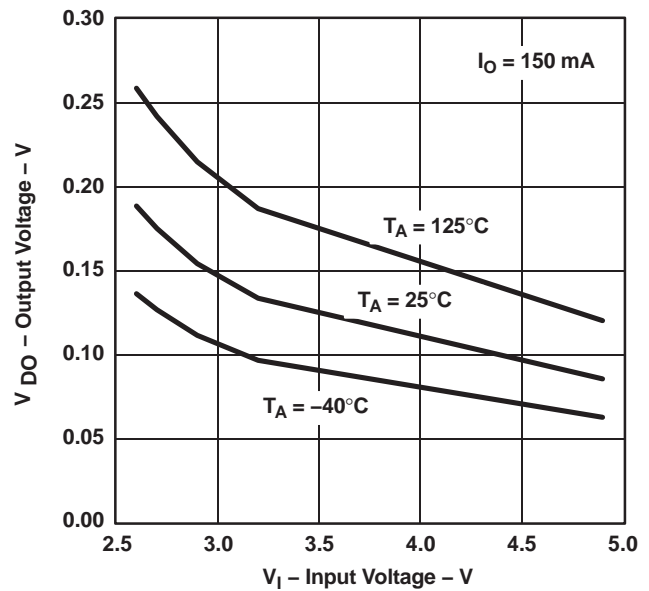

Figure 20.

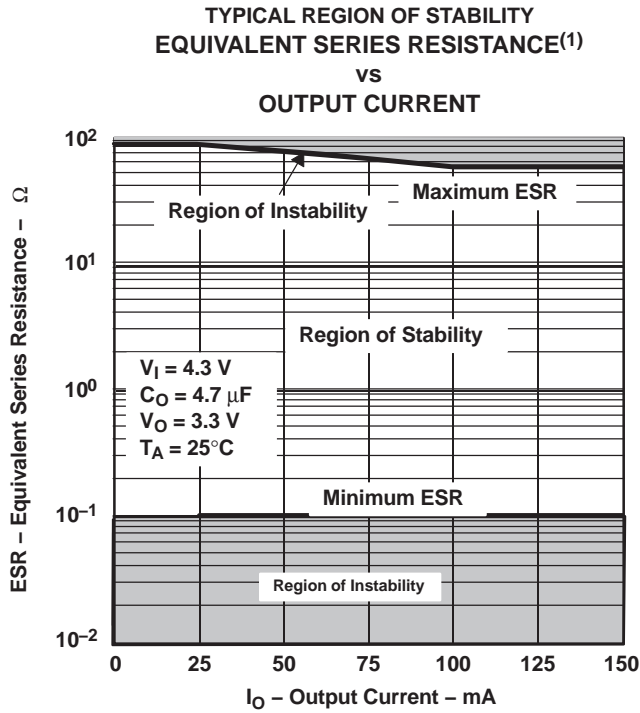

Figure 21.

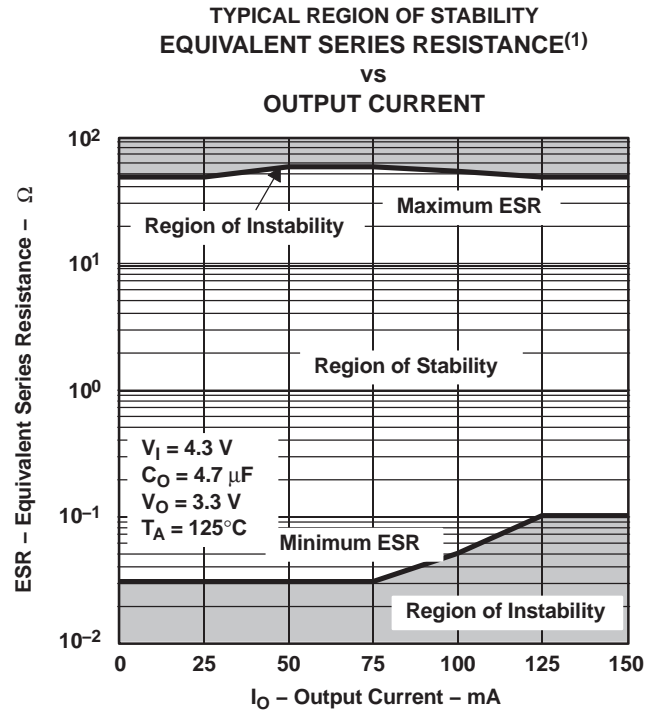

Figure 22.

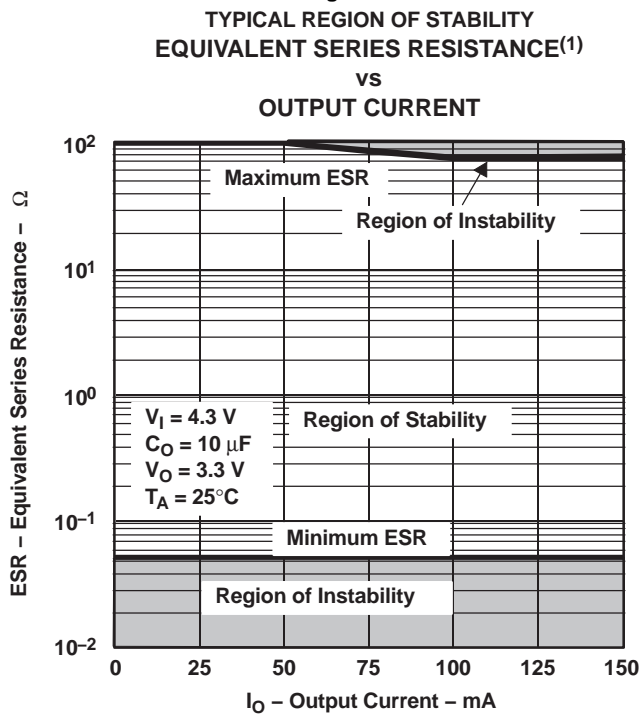

Figure 23.

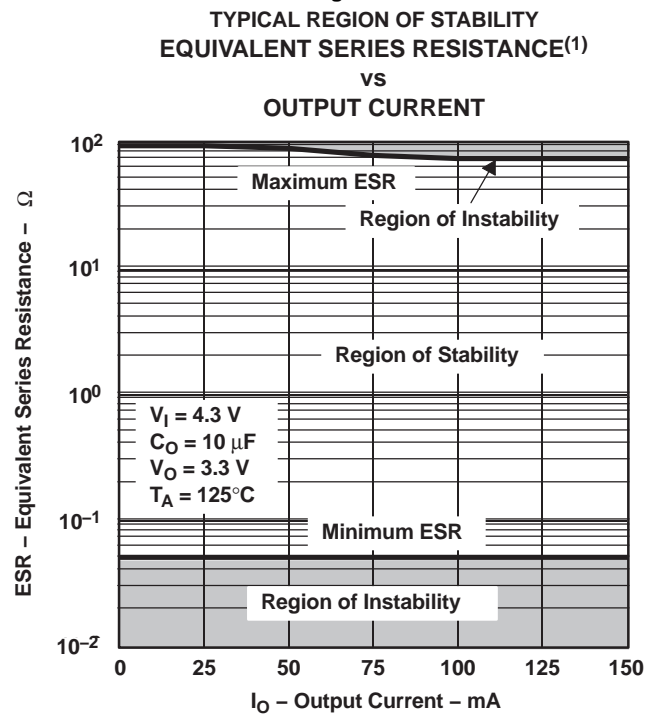
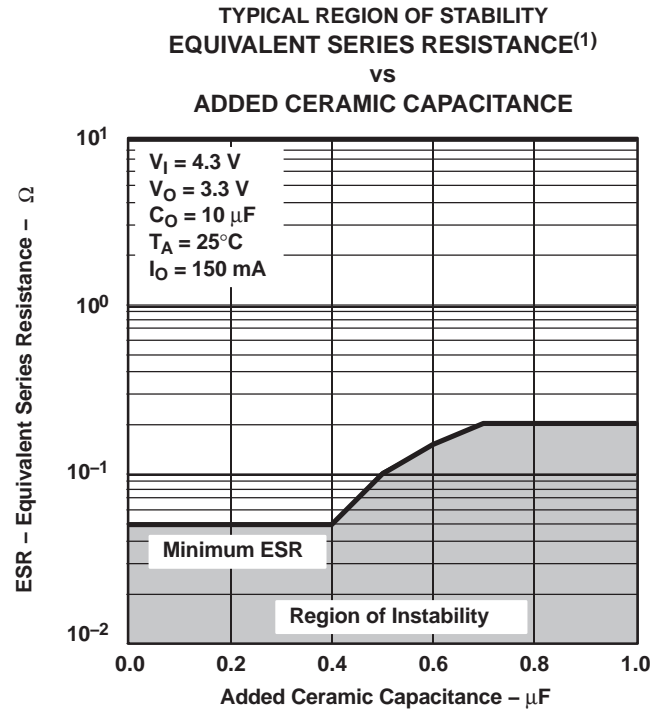
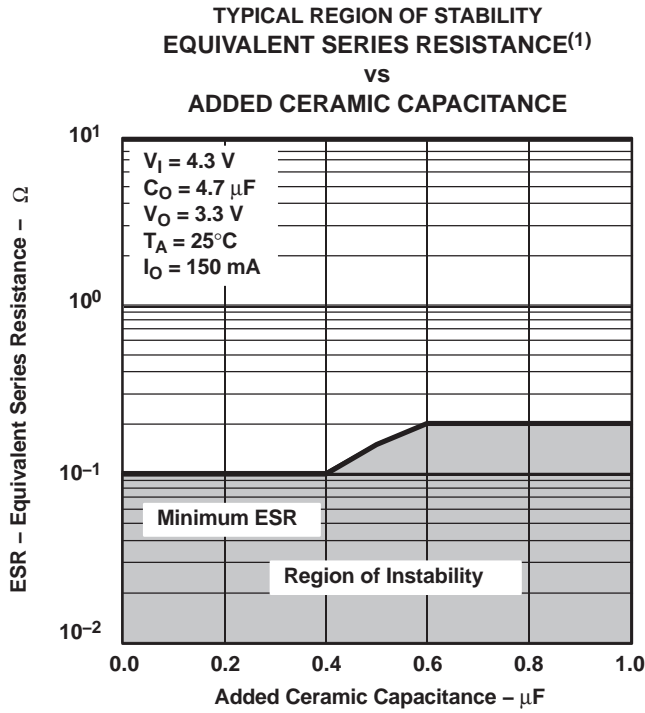

Figure 24.

(1) Equivalent series resistance (ESR) refers to the total series resistance, including the ESR of the capacitor, any series resistance added externally, and PWB trace resistance to C_O .

TPS76501-Q1
ULTRALOW QUIESCENT CURRENT 150-mA LOW-DROPOUT
VOLTAGE REGULATOR

SLVS800–DECEMBER 2007



(1) Equivalent series resistance (ESR) refers to the total series resistance, including the ESR of the capacitor, any series resistance added externally, and PWB trace resistance to C_O .

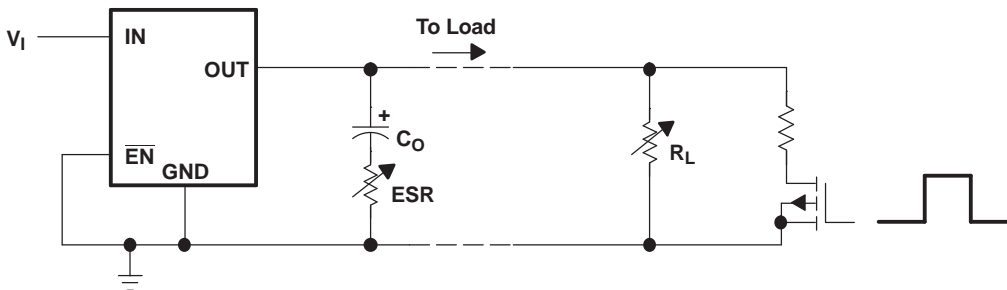

Figure 27. Test Circuit for Typical Regions of Stability (Figure 21 through Figure 24) (Fixed-Output Options)

APPLICATION INFORMATION

The TPS765xx family includes eight fixed-output voltage regulators (1.5 V, 1.8 V, 2.5 V, 2.7 V, 2.8 V, 3 V, 3.3 V, and 5 V), and an adjustable regulator, the TPS76501 (adjustable from 1.25 V to 5.5 V).

Device Operation

The TPS765xx features very low quiescent current, which remains virtually constant even with varying loads. Conventional LDO regulators use a pnp pass element, the base current of which is directly proportional to the load current through the regulator ($I_B = I_C/\beta$). The TPS765xx uses a PMOS transistor to pass current; because the gate of the PMOS is voltage driven, operating current is low and invariable over the full load range.

Another pitfall associated with the pnp-pass element is its tendency to saturate when the device goes into dropout. The resulting drop in β forces an increase in I_B to maintain the load. During power up, this translates to large start-up currents. Systems with limited supply current may fail to start up. In battery-powered systems, it means rapid battery discharge when the voltage decays below the minimum required for regulation. The TPS765xx quiescent current remains low even when the regulator drops out, eliminating both problems.

The TPS765xx also features a shutdown mode that places the output in the high-impedance state (essentially equal to the feedback-divider resistance) and reduces quiescent current to 1 μ A (typ). If the shutdown feature is not used, \overline{EN} should be tied to ground. Response to an enable transition is quick; regulated output voltage is reestablished in typically 160 μ s.

Minimum Load Requirements

The TPS765xx is stable even at zero load; no minimum load is required for operation.

FB Pin Connection

The FB pin is an input pin to sense the output voltage and close the loop for the adjustable voltage. The output voltage is sensed through a resistor divider network to close the loop as it is shown in [Figure 29](#). Normally, this connection should be as short as possible; however, the connection can be made near a critical circuit to improve performance at that point. Internally, FB connects to a high-impedance wide-bandwidth amplifier and noise pickup feeds through to the regulator output. Routing the FB connection to minimize/avoid noise pickup is essential.

External Capacitor Requirements

An input capacitor is not usually required; however, a ceramic bypass capacitor (0.047 μ F or larger) improves load transient response and noise rejection if the TPS765xx is located more than a few inches from the power supply. A higher-capacitance electrolytic capacitor may be necessary if large (hundreds of milliamps) load transients with fast rise times are anticipated.

Like all LDO regulators, the TPS765xx requires an output capacitor connected between OUT and GND to stabilize the internal control loop. The minimum recommended capacitance value is 4.7 μ F and the ESR must be between 300 m Ω and 20 Ω . Capacitor values 4.7 μ F or larger are acceptable, provided the ESR is less than 20 Ω . Solid tantalum electrolytic, aluminum electrolytic, and multilayer ceramic capacitors are all suitable, provided they meet the requirements described previously.

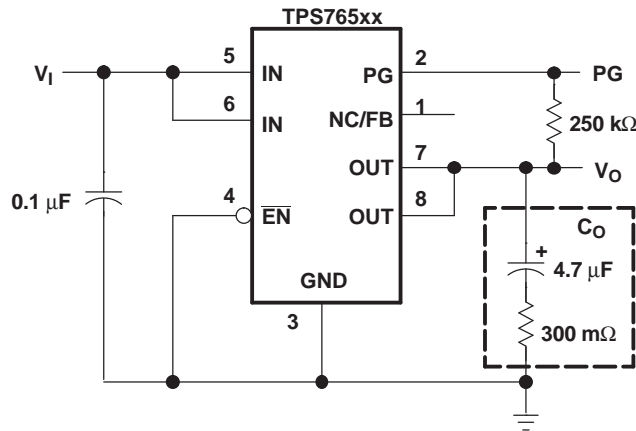

Figure 28. Typical Application Circuit (Fixed Versions)

Programming the TPS76501 Adjustable LDO Regulator

The output voltage of the TPS76501 adjustable regulator is programmed using an external resistor divider as shown in [Figure 29](#). The output voltage is calculated using [Equation 1](#):

$$V_O = V_{ref} \times \left(1 + \frac{R1}{R2}\right) \tag{1}$$

Where

$$V_{ref} = 1.224 \text{ V (typ) (the internal reference voltage)}$$

Resistors R1 and R2 should be chosen for approximately 7-μA divider current. Lower-value resistors can be used but offer no inherent advantage and waste more power. Higher values should be avoided as leakage currents at FB increase the output voltage error. The recommended design procedure is to choose R2 = 169 kΩ to set the divider current at 7 μA and then calculate R1 using [Equation 2](#):

$$R1 = \left(\frac{V_O}{V_{ref}} - 1\right) \times R2 \tag{2}$$

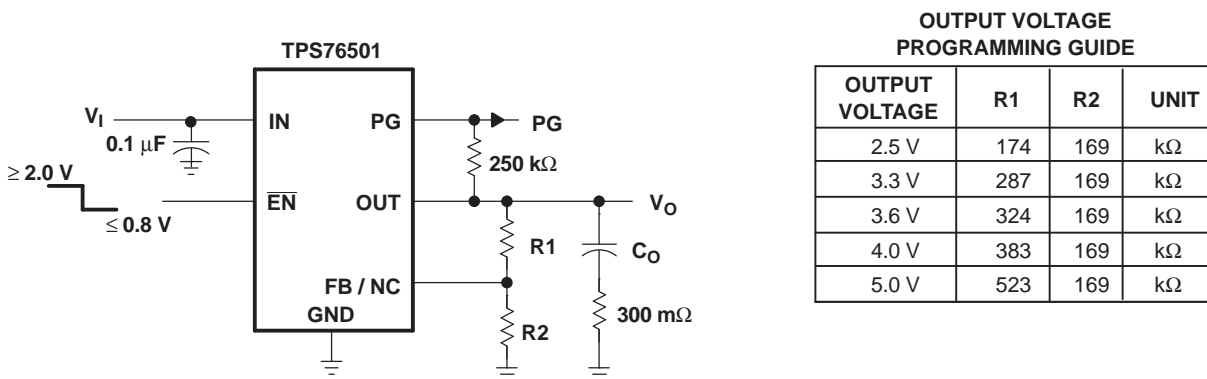

Figure 29. TPS76501 Adjustable LDO Regulator Programming

Power-Good Indicator (PG)

The TPS765xx features a power-good output that can be used to monitor the status of the regulator. The internal comparator monitors the output voltage: when the output drops to between 92% and 98% of its nominal regulated value, the PG output transistor turns on, taking the signal low. The open-drain output requires a pullup resistor. If not used, it can be left floating. PG can be used to drive power-on reset circuitry or used as a low-battery indicator.

Regulator Protection

The TPS765xx PMOS-pass transistor has a built-in back diode that conducts reverse currents when the input voltage drops below the output voltage (e.g., during power down). Current is conducted from the output to the input and is not internally limited. When extended reverse voltage is anticipated, external limiting may be appropriate.

The TPS765xx also features internal current limiting and thermal protection. During normal operation, the TPS765xx limits output current to approximately 0.8 A. When current limiting engages, the output voltage scales back linearly until the overcurrent condition ends. While current limiting is designed to prevent gross device failure, care should be taken not to exceed the power dissipation ratings of the package. If the temperature of the device exceeds 150°C (typical), thermal-protection circuitry shuts it down. Once the device has cooled below 130°C (typical), regulator operation resumes.

Power Dissipation and Junction Temperature

Specified regulator operation is assured to a junction temperature of 125°C; the maximum junction temperature should be restricted to 125°C under normal operating conditions. This restriction limits the power dissipation the regulator can handle in any given application. To ensure the junction temperature is within acceptable limits, calculate the maximum allowable dissipation, $P_{D(max)}$, and the actual dissipation, P_D , which must be less than or equal to $P_{D(max)}$.

The maximum-power-dissipation limit is determined using the following equation:

$$P_{D(max)} = \frac{T_{Jmax} - T_A}{R_{\theta JA}}$$

Where

T_{Jmax} is the maximum allowable junction temperature.

$R_{\theta JA}$ is the thermal resistance junction-to-ambient for the package.

T_A is the ambient temperature.

The regulator dissipation is calculated using:

$$P_D = (V_I - V_O) \times I_O$$

Power dissipation resulting from quiescent current is negligible. Excessive power dissipation triggers the thermal protection circuit.

PACKAGING INFORMATION

Orderable Device	Status (1)	Package Type	Package Drawing	Pins	Package Qty	Eco Plan (2)	Lead finish/ Ball material (6)	MSL Peak Temp (3)	Op Temp (°C)	Device Marking (4/5)	Samples
TPS76501QDRQ1	ACTIVE	SOIC	D	8	2500	RoHS & Green	NIPDAU	Level-1-260C-UNLIM	-40 to 125	76501Q	Samples

(1) The marketing status values are defined as follows:

ACTIVE: Product device recommended for new designs.

LIFEBUY: TI has announced that the device will be discontinued, and a lifetime-buy period is in effect.

NRND: Not recommended for new designs. Device is in production to support existing customers, but TI does not recommend using this part in a new design.

PREVIEW: Device has been announced but is not in production. Samples may or may not be available.

OBSOLETE: TI has discontinued the production of the device.

(2) **RoHS:** TI defines "RoHS" to mean semiconductor products that are compliant with the current EU RoHS requirements for all 10 RoHS substances, including the requirement that RoHS substance do not exceed 0.1% by weight in homogeneous materials. Where designed to be soldered at high temperatures, "RoHS" products are suitable for use in specified lead-free processes. TI may reference these types of products as "Pb-Free".

RoHS Exempt: TI defines "RoHS Exempt" to mean products that contain lead but are compliant with EU RoHS pursuant to a specific EU RoHS exemption.

Green: TI defines "Green" to mean the content of Chlorine (Cl) and Bromine (Br) based flame retardants meet JS709B low halogen requirements of <=1000ppm threshold. Antimony trioxide based flame retardants must also meet the <=1000ppm threshold requirement.

(3) MSL, Peak Temp. - The Moisture Sensitivity Level rating according to the JEDEC industry standard classifications, and peak solder temperature.

(4) There may be additional marking, which relates to the logo, the lot trace code information, or the environmental category on the device.

(5) Multiple Device Markings will be inside parentheses. Only one Device Marking contained in parentheses and separated by a "-" will appear on a device. If a line is indented then it is a continuation of the previous line and the two combined represent the entire Device Marking for that device.

(6) Lead finish/Ball material - Orderable Devices may have multiple material finish options. Finish options are separated by a vertical ruled line. Lead finish/Ball material values may wrap to two lines if the finish value exceeds the maximum column width.

Important Information and Disclaimer: The information provided on this page represents TI's knowledge and belief as of the date that it is provided. TI bases its knowledge and belief on information provided by third parties, and makes no representation or warranty as to the accuracy of such information. Efforts are underway to better integrate information from third parties. TI has taken and continues to take reasonable steps to provide representative and accurate information but may not have conducted destructive testing or chemical analysis on incoming materials and chemicals. TI and TI suppliers consider certain information to be proprietary, and thus CAS numbers and other limited information may not be available for release.

In no event shall TI's liability arising out of such information exceed the total purchase price of the TI part(s) at issue in this document sold by TI to Customer on an annual basis.

TAPE AND REEL INFORMATION

QUADRANT ASSIGNMENTS FOR PIN 1 ORIENTATION IN TAPE

*All dimensions are nominal

Device	Package Type	Package Drawing	Pins	SPQ	Reel Diameter (mm)	Reel Width W1 (mm)	A0 (mm)	B0 (mm)	K0 (mm)	P1 (mm)	W (mm)	Pin1 Quadrant
TPS76501QDRQ1	SOIC	D	8	2500	330.0	12.4	6.4	5.2	2.1	8.0	12.0	Q1

TAPE AND REEL BOX DIMENSIONS

*All dimensions are nominal

Device	Package Type	Package Drawing	Pins	SPQ	Length (mm)	Width (mm)	Height (mm)
TPS76501QDRQ1	SOIC	D	8	2500	350.0	350.0	43.0



D0008A

PACKAGE OUTLINE

SOIC - 1.75 mm max height

SMALL OUTLINE INTEGRATED CIRCUIT



4214825/C 02/2019

NOTES:

1. Linear dimensions are in inches [millimeters]. Dimensions in parenthesis are for reference only. Controlling dimensions are in inches. Dimensioning and tolerancing per ASME Y14.5M.
2. This drawing is subject to change without notice.
3. This dimension does not include mold flash, protrusions, or gate burrs. Mold flash, protrusions, or gate burrs shall not exceed $.006$ [0.15] per side.
4. This dimension does not include interlead flash.
5. Reference JEDEC registration MS-012, variation AA.

EXAMPLE BOARD LAYOUT

D0008A

SOIC - 1.75 mm max height

SMALL OUTLINE INTEGRATED CIRCUIT



LAND PATTERN EXAMPLE
 EXPOSED METAL SHOWN
 SCALE:8X



SOLDER MASK DETAILS

4214825/C 02/2019

NOTES: (continued)

- 6. Publication IPC-7351 may have alternate designs.
- 7. Solder mask tolerances between and around signal pads can vary based on board fabrication site.

EXAMPLE STENCIL DESIGN

D0008A

SOIC - 1.75 mm max height

SMALL OUTLINE INTEGRATED CIRCUIT



SOLDER PASTE EXAMPLE
BASED ON .005 INCH [0.125 MM] THICK STENCIL
SCALE:8X

4214825/C 02/2019

NOTES: (continued)

8. Laser cutting apertures with trapezoidal walls and rounded corners may offer better paste release. IPC-7525 may have alternate design recommendations.
9. Board assembly site may have different recommendations for stencil design.

IMPORTANT NOTICE AND DISCLAIMER

TI PROVIDES TECHNICAL AND RELIABILITY DATA (INCLUDING DATA SHEETS), DESIGN RESOURCES (INCLUDING REFERENCE DESIGNS), APPLICATION OR OTHER DESIGN ADVICE, WEB TOOLS, SAFETY INFORMATION, AND OTHER RESOURCES "AS IS" AND WITH ALL FAULTS, AND DISCLAIMS ALL WARRANTIES, EXPRESS AND IMPLIED, INCLUDING WITHOUT LIMITATION ANY IMPLIED WARRANTIES OF MERCHANTABILITY, FITNESS FOR A PARTICULAR PURPOSE OR NON-INFRINGEMENT OF THIRD PARTY INTELLECTUAL PROPERTY RIGHTS.

These resources are intended for skilled developers designing with TI products. You are solely responsible for (1) selecting the appropriate TI products for your application, (2) designing, validating and testing your application, and (3) ensuring your application meets applicable standards, and any other safety, security, regulatory or other requirements.

These resources are subject to change without notice. TI grants you permission to use these resources only for development of an application that uses the TI products described in the resource. Other reproduction and display of these resources is prohibited. No license is granted to any other TI intellectual property right or to any third party intellectual property right. TI disclaims responsibility for, and you will fully indemnify TI and its representatives against, any claims, damages, costs, losses, and liabilities arising out of your use of these resources.

TI's products are provided subject to [TI's Terms of Sale](#) or other applicable terms available either on [ti.com](https://www.ti.com) or provided in conjunction with such TI products. TI's provision of these resources does not expand or otherwise alter TI's applicable warranties or warranty disclaimers for TI products.

TI objects to and rejects any additional or different terms you may have proposed.

Mailing Address: Texas Instruments, Post Office Box 655303, Dallas, Texas 75265
Copyright © 2023, Texas Instruments Incorporated