

## **DAC53401EVM**

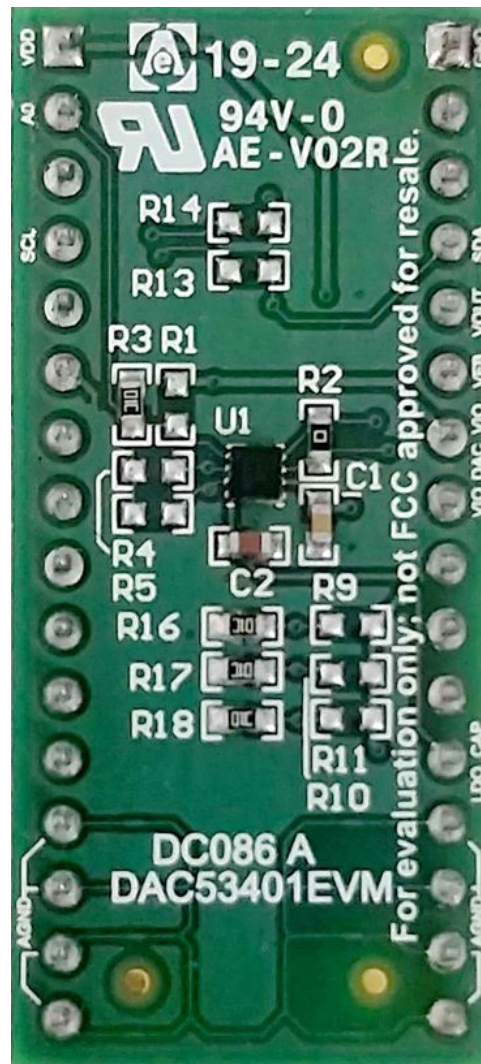

This user's guide describes the characteristics, operation, and use of the DAC53401EVM evaluation module (EVM). This EVM is designed to evaluate the performance of the [DAC53401](#) buffered voltage output DAC in a variety of configurations. Throughout this document, the terms evaluation board, evaluation module, and EVM are synonymous with the DAC53401EVM. This document includes a schematic, reference printed-circuit board (PCB) layouts, and a complete bill of materials.

### **Contents**

1	Overview .....	3
2	System Setup .....	4
3	Detailed Description .....	8
4	Schematic, PCB Layout, and Bill of Materials .....	22

### List of Figures

1	DAC53401EVM Software Setup .....	4
2	Software Installation Path .....	4
3	TI Cloud Agent Installation .....	5
4	Analog EVM Controller Setup .....	5
5	Hardware Setup .....	6
6	Hardware Setup Guidelines .....	7
7	BOOSTXL-DAC-PORT Hardware Block Diagram.....	8
8	DAC53401EVM Hardware Block Diagram .....	11
9	DAC53401EVM GUI Location .....	13
10	DAC53401EVM GUI Connection Detection .....	13
11	Software Home Page .....	14
12	Setup Page.....	15
13	DAC Quick-Start Page: Basic DAC Tab .....	16
14	DAC Quick-Start Page: Margining Tab.....	17
15	DAC Quick Start Page: Function Generation.....	18
16	DAC Quick-Start Page: Alarms Tab .....	19
17	Register Map Page .....	20
18	Register Page Options .....	20
19	Collateral Page .....	21
20	BOOSTXL-DAC-PORT Schematic Page 1 .....	22
21	BOOSTXL-DAC-PORT Schematic Page 2 .....	23
22	DAC53401EVM Schematic .....	24
23	BOOSTXL-DAC-PORT PCB Components Layout.....	25
24	BOOSTXL-DAC-PORT Top Layer .....	25
25	BOOSTXL-DAC-PORT Bottom Layer .....	26
26	DAC53401EVM PCB Components Layout .....	26
27	DAC53401EVM Layers .....	27

### List of Tables

1	Contents of DAC53401EVM Kit.....	3
2	Required Components Not Included With Kit .....	3
3	Related Documentation .....	3
4	DAC53401EVM Power Supply Inputs .....	6
5	BOOSTXL-DAC-PORT Jumper Settings .....	6
6	BOOSTXL-DAC-PORT J13 Pin Definitions .....	9
7	BOOSTXL-DAC-PORT J14 Pin Definitions .....	9
8	BOOSTXL-DAC-PORT J4 Pin Definitions .....	10
9	BOOSTXL-DAC-PORT J5 Pin Definitions .....	10
10	BOOSTXL-DAC-PORT J12 Pin Definitions.....	10
11	DAC53401EVM J2 Pin Definitions .....	12
12	DAC53401EVM J1 Pin Definitions .....	12
13	BOOSTXL-DAC-PORT Bill of Materials.....	28
14	DAC53401EVM Bill of Materials.....	30

### Trademarks

Windows is a trademark of Microsoft Corporation.  
 PMBus is a trademark of SMIF, Inc.  
 All other trademarks are the property of their respective owners.

## 1 Overview

The DAC53401EVM is an easy-to-use platform to evaluate the functionality and performance of the DAC53401 device. The 10-bit DAC53401 and 8-bit DAC43401 (DACx3401) are a pin-compatible family of buffered voltage-output digital-to-analog converters (DACs). These devices have nonvolatile memory (NVM), an internal reference, and a PMBus™ compatible I<sup>2</sup>C interface. The DACx3401 operates with either an internal reference or the power supply as a reference, and provides full-scale output of 1.8 V to 5.5 V. The devices communicate through the I<sup>2</sup>C interface. These devices support I<sup>2</sup>C standard mode (100 kbps), fast mode (400 kbps), and fast mode plus (1 Mbps). The DACx3401 are feature rich, and include features such as PMBus voltage margin commands (for example, Turn On/Off, Margin High/Low, and more), digital slew rate control, user-programmable power up to high impedance, a standalone waveform generator (square, ramp, and sawtooth), a medical alarm tone generator (low, medium, and high priority), and a dedicated feedback pin. The EVM provides the GPIO and I<sup>2</sup>C programming interface using a PC-based graphical user interface (GUI).

### 1.1 Kit Contents

Table 1 details the contents of the EVM kit. Contact the TI Product Information Center nearest you if any component is missing. TI highly recommends that the user verify latest versions of the related software at the TI website, [www.ti.com](http://www.ti.com).

**Table 1. Contents of DAC53401EVM Kit**

Item	Quantity
DAC53401EVM evaluation board PCB	1

**Table 2. Required Components Not Included With Kit**

Item	Quantity
BOOSTXL-DAC-PORT	1
MSP-EXP432E401Y Launchpad (Analog EVM Controller)	1

The Analog EVM Controller can be purchased from [the MSP432E401Y tool folder](#) on [www.ti.com](http://www.ti.com).

### 1.2 Related Documentation from Texas Instruments

The following document provides information regarding Texas Instruments integrated circuits used in the assembly of the DAC53401EVM. This user's guide is available from the TI web site under literature number SLAU805. Any letter appended to the literature number corresponds to the document revision that is current at the time of the writing of this document. Newer revisions may be available from the TI web site at <http://www.ti.com/>, or call the Texas Instruments Literature Response Center at (800) 477-8924 or the Product Information Center at (972) 644-5580. When ordering, identify the document by both title and literature number.

**Table 3. Related Documentation**

Document	Literature Number
<a href="#">DAC53401</a> product data sheet	<a href="#">SLASES7</a>

## 2 System Setup

### 2.1 Software Setup

This section provides the procedure for EVM software installation.

#### 2.1.1 Operating Systems

The EVM software is compatible with the Windows™ 7, 8, and 10 operating systems.

#### 2.1.2 Software Installation

The software is available on the product folder, and can also be found in the [GUI Composer Gallery](#). Search for *DAC53401EVM* in the GUI Composer Gallery. Use the down arrow symbol to download the software. There are two downloads: *DAC53401EVM GUI* and *GUI Composer Runtime*. Either download both, or just download the EVM GUI; the runtime can be downloaded through the EVM GUI during installation. The software can also be run online by clicking; however, only after the firmware and driver are upgraded. After the software is downloaded onto the PC, navigate to the download folder, and run the DAC53401EVM software executable, as shown in [Figure 1](#). When the DAC53401EVM software is launched, an installation dialog window opens and prompts the user to select an installation directory. If left unchanged, the software location defaults to *C:\Program Files (x86)\Texas Instruments\DAC53401 EVM* as shown in [Figure 2](#). If there is no previous installation of the *GUI Composer Runtime* application, the installer also requests for an automatic download from the web. Select either *Install from Web* to download and install from the web, or *Install from PC* and provide the path to the local file that is already downloaded. The runtime also installs the USB drivers, unless the drivers are already installed.

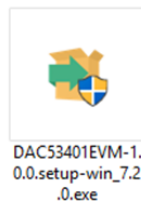

**Figure 1. DAC53401EVM Software Setup**

The software installation automatically copies the required files and drivers to the local machine.

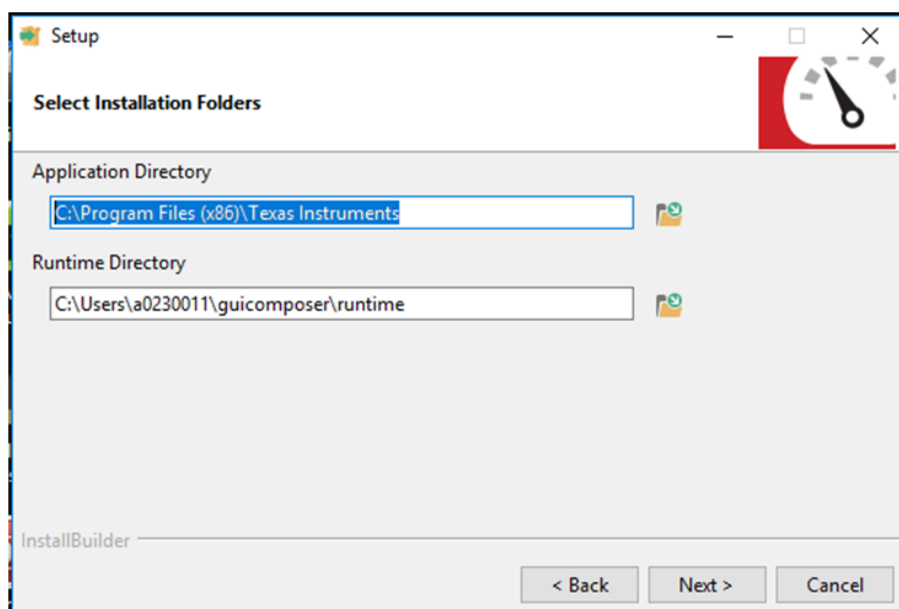

**Figure 2. Software Installation Path**

### 2.1.3 Analog EVM Controller Firmware Upgrade

The firmware for the Analog EVM Controller must be upgraded for the first time before using the software. A jumper must be modified, and the USB cable must be connected to the XDS110 port of the Analog EVM Controller to download firmware. The firmware can be programmed to the Analog EVM Controller using the online tool [UniFlash](#). This link is also provided on the *Setup* page of the GUI. The firmware bin file can be found at <Download

*Directory>\DAC53401EVM\_1.0.1\_installer\_win\install\_image\_DAC53401EVM\dac53401EVMfirmware\lacctrl.0.3.0.3b.bin* after unzipping the file *install\_image\_DAC53401EVM.zip*.

Follow the step-by-step procedure below to upgrade the firmware and install the device drivers successfully:

1. Remove jumper JP6 on the Analog EVM Controller as shown in step 1 of [Figure 4](#).
2. Mount jumper on 5V-OTG. Retain the jumper on 5V-XDS as shown in step 1 of [Figure 4](#).
3. Connect the USB cable to the port on the XDS110 side of the board as shown in step 2 of [Figure 4](#).
4. Connect the USB cable to PC and open [UniFlash](#). Click on *Start Now* in the *Detect Device* section.
5. If the GUI Composer framework is being installed for the first time on the PC, the browser extension and the *TI Cloud Agent* must be installed. Follow the 2-step installation flow prompted on the web page, as shown in [Figure 3](#)

## TI Cloud Agent Installation

Hardware interaction requires additional one time set up. Please perform the actions listed below and try your operation again.(What's this?)

- Step 1: **INSTALL** browser extension
- Step 2: **DOWNLOAD** and install the TI Cloud Agent Application
- Help. I already did this

**FINISH**

**Figure 3. TI Cloud Agent Installation**

6. Press the *Refresh* or *Finish* button after the installation is complete. This action should detect the Launchpad.
7. Press *Start* and browse for <Download  
*Directory>\DAC53401EVM\_1.0.1\_installer\_win\install\_image\_DAC53401EVM\dac53401EVMfirmware\lacctrl.0.3.0.3b.bin*. Press *Load Image* followed by *Verify Image*.

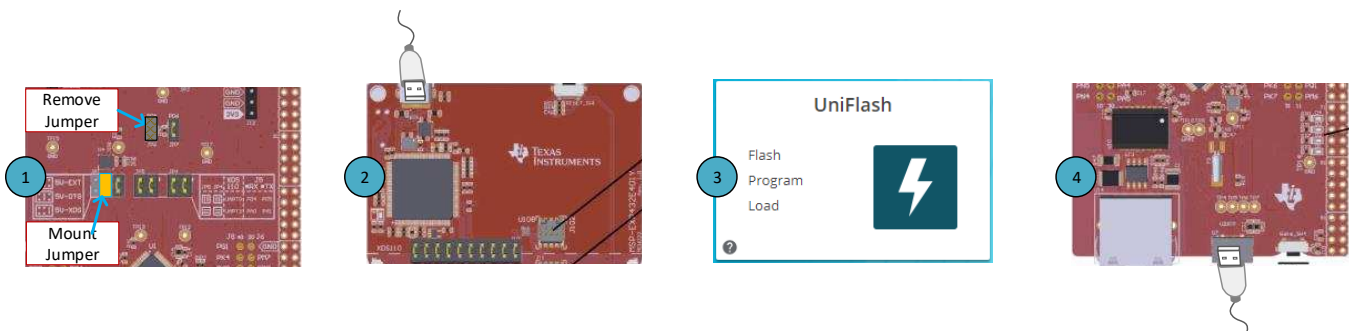

**Figure 4. Analog EVM Controller Setup**

## 2.2 Hardware Setup

This section provides the overall system setup for the EVM. The hardware setup contains the Analog EVM Controller (MSP-EXP432E401Y Launchpad), BOOSTXL-DAC-PORT, and DAC53401EVM. A PC runs software that provides an interface to the DAC53401EVM through the Analog EVM Controller.

The Analog EVM Controller generates 5 V of power that can be used as VDD for the DAC. Analog EVM Controller also generates 3.3 V of power that can be used for I<sup>2</sup>C pull-ups. The IO ports of the Analog EVM Controller and level translators used on the BOOSTXL-DAC-PORT and DAC53401EVM can withstand a maximum of 3.6-V IO levels. The Analog EVM Controller also generates digital signals used to communicate with the EVM board.

The BOOSTXL-DAC-PORT is a generic platform used for catalog DACs that provides a predefined interface to connect a DAC evaluation module. The BOOSTXL-DAC-PORT also provides various options for power supply, reference, and digital signals. A connector is provided on the BOOSTXL-DAC-PORT for external power supplies. This platform is designed to host additional boards stacked up on the BOOSTXL-DAC-PORT in order to provide extended functions. Figure 5 displays the system setup.

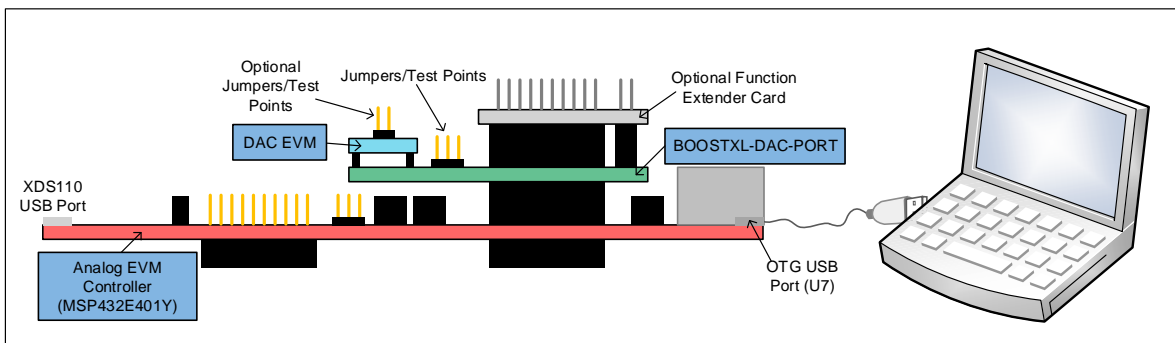

Figure 5. Hardware Setup

### 2.2.1 Power Configurations and Jumper Settings

The DAC53401EVM provides electrical connections to the device supply pins. The connectors and optional configurations are shown in Table 4. The jumper settings on the BOOSTXL-DAC-PORT are crucial to the proper functioning of the DAC53401EVM. Table 5 provides the details of the possible jumper settings on the BOOSTXL-DAC-PORT.

Table 4. DAC53401EVM Power Supply Inputs

DAC53401EVM Connector	Supply Name	Voltage Range
J2.1	VDD	1.8 V to 5.5 V (5 V Available on Analog EVM Controller), Jumper J9.1-2 on BOOSTXL-DAC-PORT
J1.8	VIO	1.8 V to 3.6 V (3.3 V Available on Analog EVM Controller), Jumper J10.1-2 on BOOSTXL-DAC-PORT
J1.7	DAC_VIO	1.8 V to 3.6 V, Jumper J11.1-2 on BOOSTXL-DAC-PORT
J1.1	GND	0 V

Table 5. BOOSTXL-DAC-PORT Jumper Settings

Jumper	Default Position	Available Option	Description
J3	1-2: Onboard reference	2-3: External reference	External or onboard reference selection
J6	2-3: Zener reference	1-2: VDD reference	Zener or VDD reference
J7	2-3: 2.5-V reference	1-2: 5-V reference	2.5-V or 5-V reference selection
J8	2-3: Unused on DAC53401	1-2: Unused on DAC53401	External or onboard LDAC selection
J9	1-2: 5 V from Launchpad	2-3: External VDD	5-V or external VDD
J10	1-2: 3.3 V from Launchpad	2-3: External VIO	3.3-V or external VIO
J11	Closed: DAC_VIO is connected to VIO	Open: DAC_VIO off	DAC_VIO on/off



### 2.2.2 Connecting the Hardware

After the Analog EVM Controller firmware is upgraded as described in [Section 2.1.3](#), and power and jumper configurations done as per [Section 2.2.1](#), the BOOSTXL-DAC-PORT and DAC53401EVM can be connected as shown in [Figure 6](#). Connect the USB cable from the Analog EVM Controller OTG USB Port (U7) to the PC.

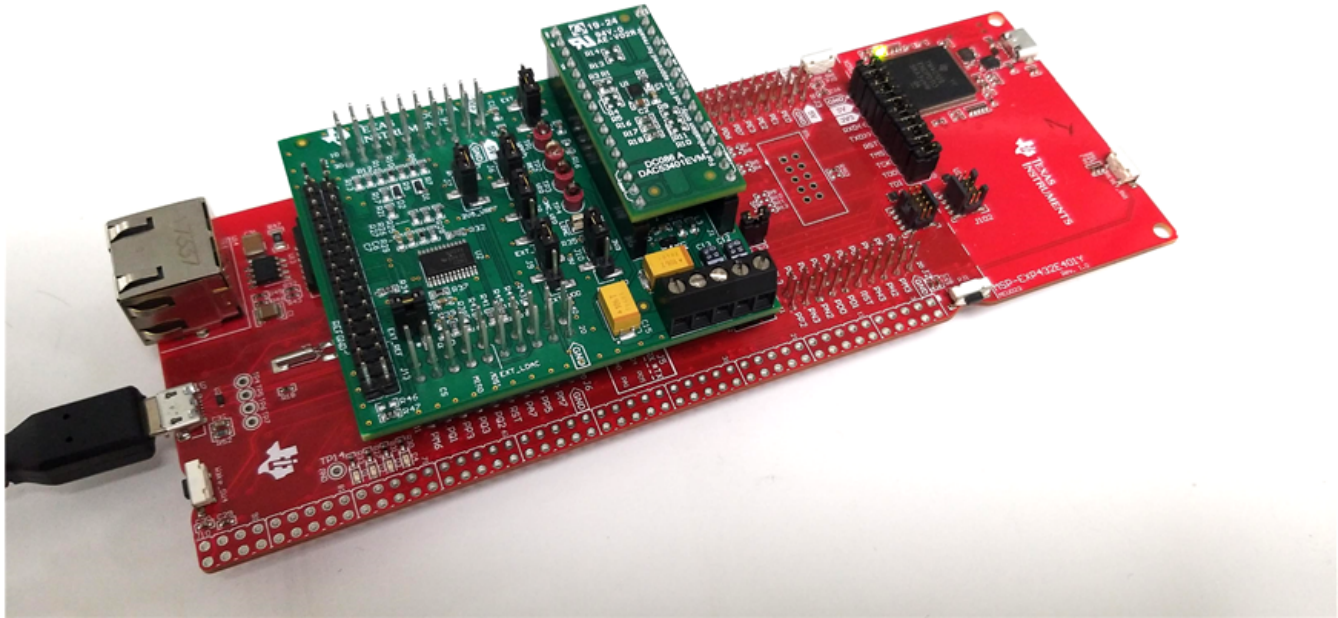

**Figure 6. Hardware Setup Guidelines**

### 2.2.3 Electrostatic Discharge Warning

Many of the components on the DAC53401EVM are susceptible to damage by electrostatic discharge (ESD). Observe proper ESD handling precautions when unpacking and handling the EVM, including the use of a grounded wrist strap at an approved ESD workstation.

### 3 Detailed Description

#### 3.1 Hardware Description

The following sections provide detailed information on the EVM hardware and jumper configuration settings.

##### 3.1.1 Theory of Operation for the BOOSTXL-DAC-PORT

The BOOSTXL-DAC-PORT is a generic evaluation platform for catalog DACs that provides various options for power supply, reference, communication interfaces, and GPIO for a DAC EVM. The DAC EVM interfaces with a predefined set of signals common to a precision DAC. The block diagram of this board is shown in [Figure 7](#).

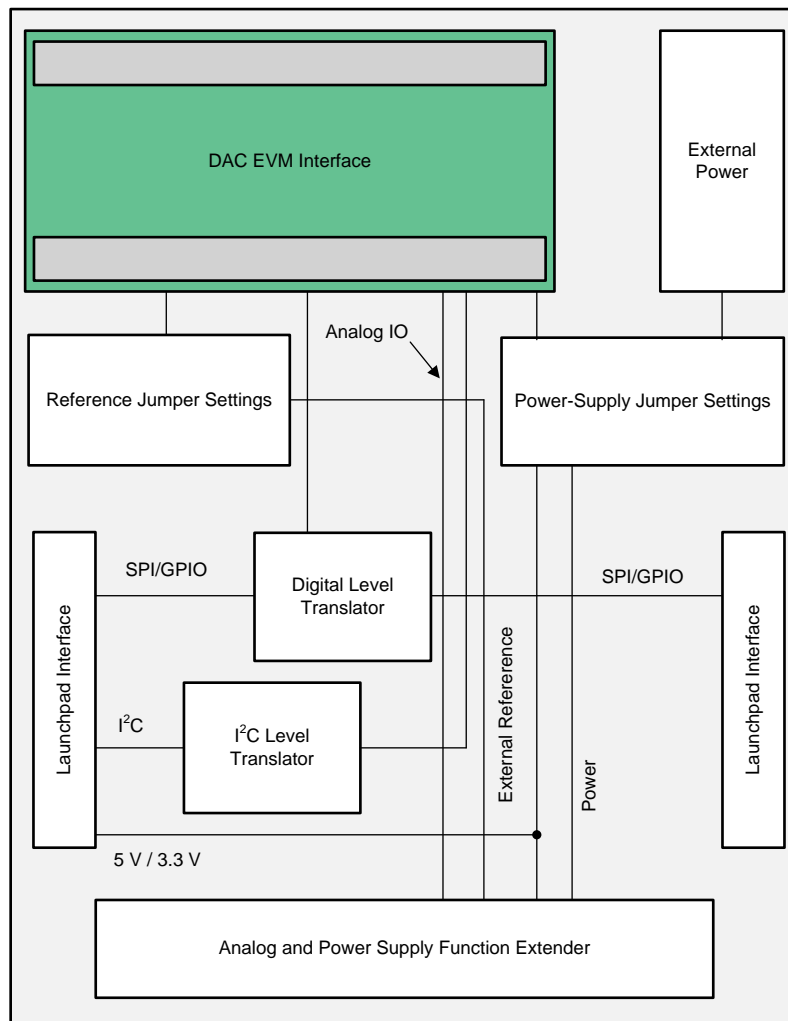

**Figure 7. BOOSTXL-DAC-PORT Hardware Block Diagram**

##### 3.1.2 Signal Definition of the BOOSTXL-DAC-PORT

The BOOSTXL-DAC-PORT provides hardware connectors for the Analog EVM Controller (J13, J14), external power (J12), the DAC53401EVM (J1, J2), and the external function extender (J4, J5). The descriptions are provided in [Table 6](#) through [Table 10](#).



**Table 6. BOOSTXL-DAC-PORT J13 Pin Definitions**

Pin#	Signal	Description
11	GPIO	General-purpose I/O
12	$\overline{CS}$	SPI $\overline{CS}$ or general-purpose I/O
13	GPIO	SPI
14	MISO	SPI MISO
15	MOSI	SPI MOSI
16	$\overline{RST}$	MCU reset output
17	GPIO	General-purpose I/O
18	GPIO	General-purpose I/O
19	GPIO	General-purpose I/O
20	GND	Ground
31	GPIO	General-purpose I/O
32	GPIO	General-purpose I/O
33	GPIO	General-purpose I/O
34	GPIO	General-purpose I/O
35	EXT_LDAC	External LDAC I/O
36	EXT_LDAC	External LDAC I/O
37	SPI_BUF_EN	Digital, SPI buffer enable
38	GPIO	General-purpose I/O
39	GPIO	General-purpose I/O
40	GPIO	General-purpose I/O

**Table 7. BOOSTXL-DAC-PORT J14 Pin Definitions**

Pin#	Signal	Description
1	+3.3V	3.3-V power supply
2	GPIO	General-purpose I/O
3	GPIO	General-purpose I/O
4	GPIO	General-purpose I/O
5	GPIO	General-purpose I/O
6	GPIO	General-purpose I/O
7	SCLK_A0	SPI SCLK or I <sup>2</sup> C A0
8	GPIO	General-purpose I/O
9	SCL	I <sup>2</sup> C SCL
10	SDA	I <sup>2</sup> C SDA
21	+5V	5-V power supply
22	GND	Ground
23	GPIO	General-purpose I/O
24	GPIO	General-purpose I/O
25	VDD_SENSE	Sense Input for VDD
26	VIO_SENSE	Sense Input for VIO
27	GPIO	General-purpose I/O
28	GPIO	General-purpose I/O
29	GPIO	General-purpose I/O
30	GPIO	General-purpose I/O

**Table 8. BOOSTXL-DAC-PORT J4 Pin Definitions**

Pin#	Signal	Description
1	AIO0	Analog I/O
2	AGND	Analog ground
3	AIO2	Analog I/O
4	AIO4	Analog I/O
5	AGND	Analog ground
6	AIO6	Analog I/O
7	AIO8	Analog I/O
8	AGND	Analog ground
9	AIO10	Analog I/O
10	AIO12	Analog I/O
11	AGND	Analog ground
12	AIO14	Analog I/O
13	EXT_REF	External reference input
14	GND	Ground
15	VCC	VCC output
16	VDD	VDD output

**Table 9. BOOSTXL-DAC-PORT J5 Pin Definitions**

Pin#	Signal	Description
1	AIO1	Analog I/O
2	AGND	Analog Ground
3	AIO3	Analog I/O
4	AIO5	Analog I/O
5	AGND	Analog Ground
6	AIO7	Analog I/O
7	AIO9	Analog I/O
8	AGND	Analog Ground
9	AIO11	Analog I/O
10	AIO13	Analog I/O
11	AGND	Analog Ground
12	AIO15	Analog I/O
13	REFGND	External Reference Ground
14	GND	Ground
15	VSS	VSS Output
16	VIO or DAC_VIO	VIO or DAC_VIO Output

**Table 10. BOOSTXL-DAC-PORT J12 Pin Definitions**

Pin#	Signal	Description
1	VCC	High-voltage positive power supply
2	VSS	High-voltage negative power supply
3	GND	Ground
4	EXT_VDD	External VDD
5	EXT_VIO	External VIO

### 3.1.3 Theory of Operation for the DAC53401EVM Hardware

The block diagram of the DAC53401EVM board is displayed in Figure 8. The EVM board connects to BOOSTXL-DAC-PORT with two 16-pin connectors. These headers provide access to all DAC pins. The EVM board also houses an EEPROM and an I<sup>2</sup>C buffer.

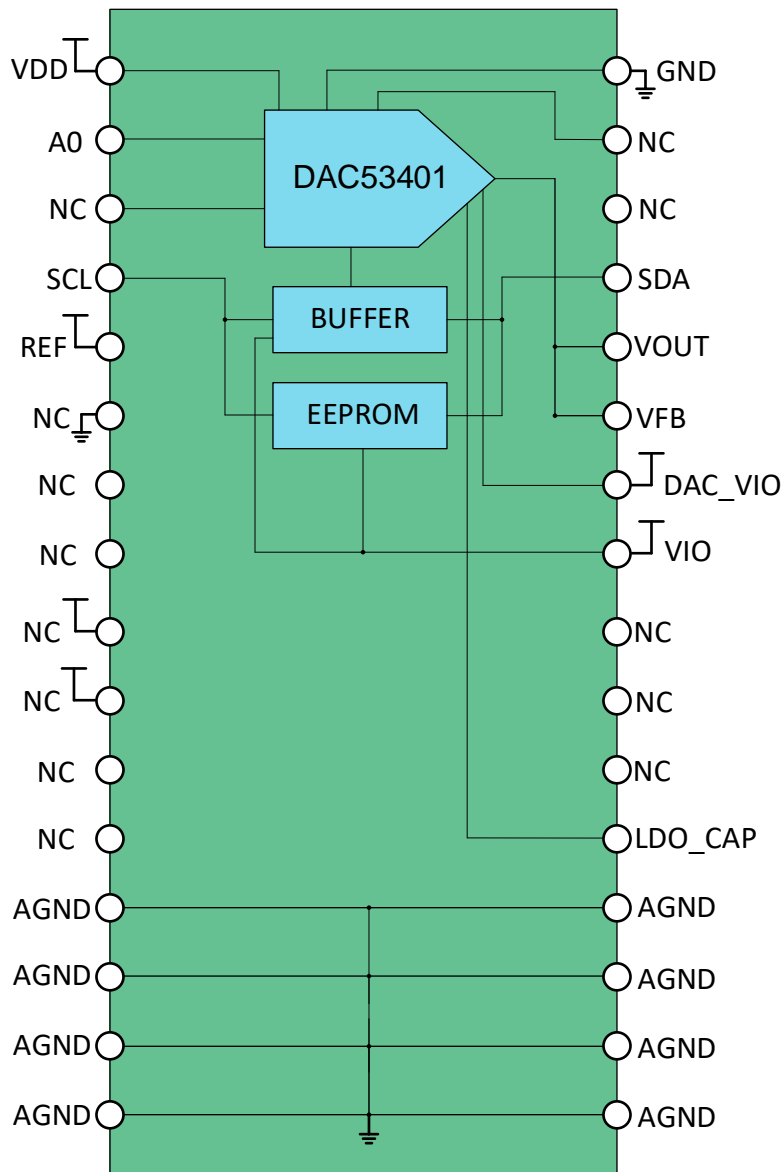

**Figure 8. DAC53401EVM Hardware Block Diagram**

### 3.1.4 Signal Definition of the DAC53401EVM

The DAC53401EVM provides access to all DAC pins through connection J1 and J2, as listed in [Table 11](#) and [Table 12](#).

**Table 11. DAC53401EVM J2 Pin Definitions**

Pin#	Signal	Description
1	VDD	VDD power supply
2	A0	I <sup>2</sup> C address select
3	NC	Not connected
4	SCL	I <sup>2</sup> C SCL
5	REF	Reference input
6	NC	Not connected
7	NC	Not connected
8	NC	Not connected
9	NC	Not connected
10	NC	Not connected
11	NC	Not connected
12	NC	Not connected
13	AGND	Analog ground
14	AGND	Analog ground
15	AGND	Analog ground
16	AGND	Analog ground

**Table 12. DAC53401EVM J1 Pin Definitions**

Pin#	Signal	Description
1	GND	PCB ground
2	NC	Not connected
3	NC	Not connected
4	SDA	I <sup>2</sup> C SDA
5	VOUT	DAC output
6	VFB	DAC feedback pin
7	DAC_VIO	Pull-up for DAC I <sup>2</sup> C signals
8	VIO	Power supply for EEPROM
9	NC	Not connected
10	NC	Not connected
11	NC	Not connected
12	LDO_CAP	LDO bypass capacitor
13	AGND	Analog ground
14	AGND	Analog ground
15	AGND	Analog ground
16	AGND	Analog ground

### 3.2 Software Description

This section describes the features of the DAC53401 EVM software, and discusses how to use these features. The software provides basic control of all the registers and functions to the DAC53401 device.

#### 3.2.1 Starting the Software

To launch the software, locate the Texas Instruments folder in the *All Programs* menu, and select the *DAC53401 EVM* icon.

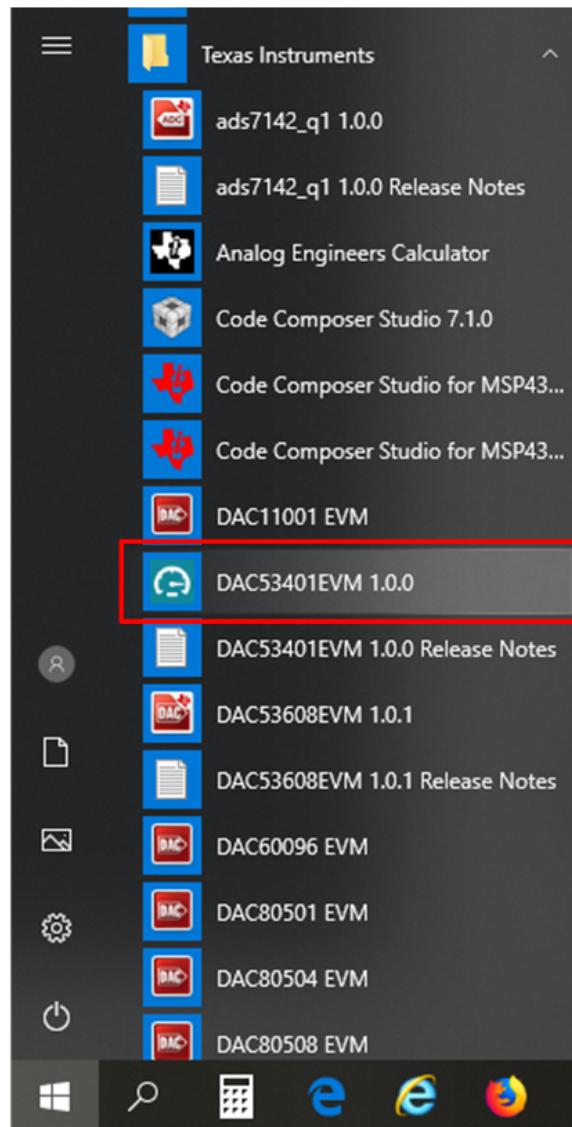

Figure 9. DAC53401EVM GUI Location

Figure 10 shows that if the Analog EVM Connector is connected correctly, the status bar at the bottom of the screen displays *Hardware Connected*. If the Analog EVM Controller is not properly connected or not connected at all, the status bar displays *Hardware not connected*. In case the *Hardware not connected* status persists even after the hardware is connected, go to *Options* → *Serial Port*, and change the port to the other available port with the *(Texas Instruments)* or *ACCtrl* tag. Out of the two ports with these tags, one port should connect.



Figure 10. DAC53401EVM GUI Connection Detection

### 3.2.2 Software Features

The DAC53401 EVM incorporates interactive functions that help configure the DAC53401 device. These functions are built into several GUI pages, as shown in the following sections. The *Menu* allows the user to switch between the pages, with each page representing a feature of the software.

#### 3.2.2.1 Home Page

This page, shown in [Figure 11](#), provides the basic information and navigation to other pages. Click on [Learn More...](#) to get more information on the device.

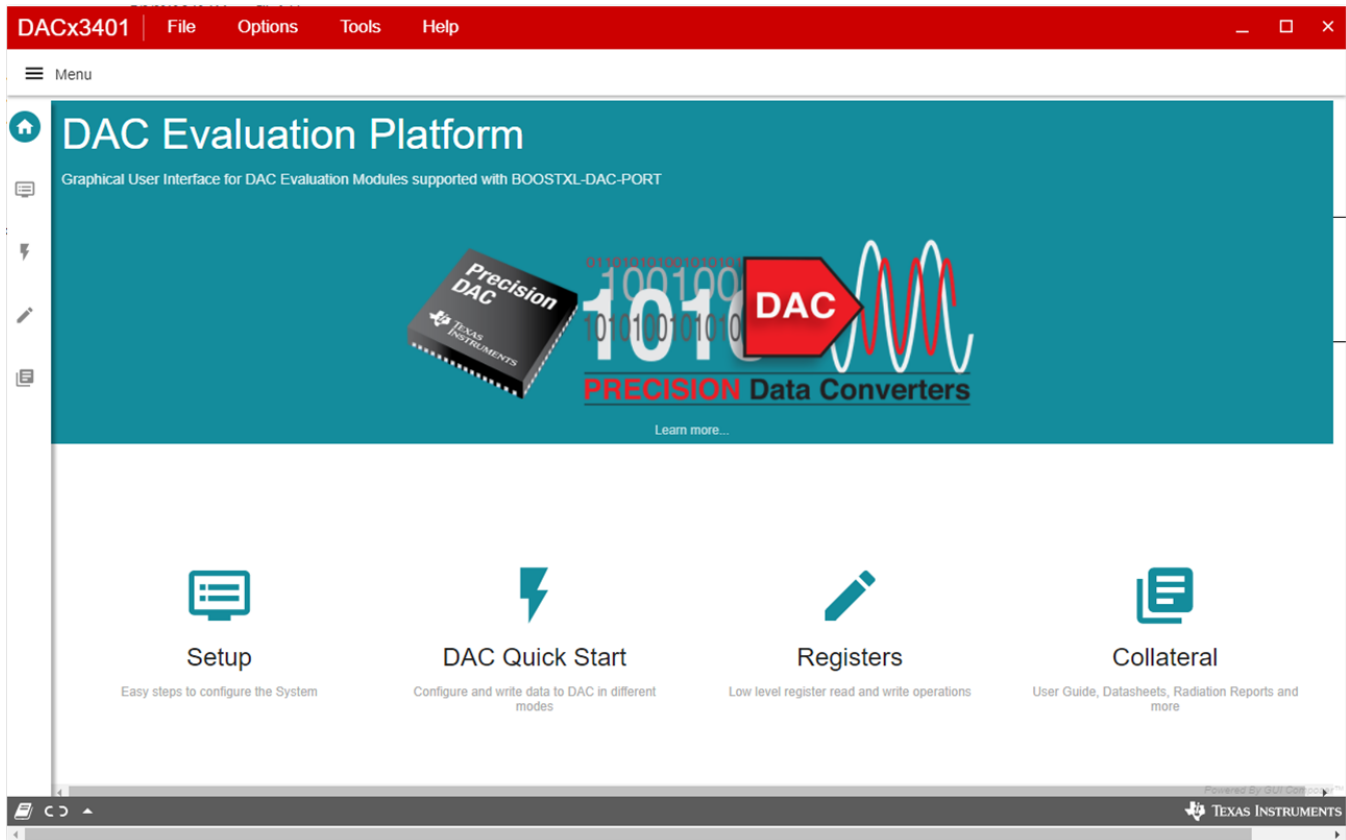

Figure 11. Software Home Page



### 3.2.2.2 Setup Page

This page, shown in [Figure 12](#), guides the user to perform a one-time firmware upgrade for the Analog EVM Controller, and details how the Analog EVM Controller, BOOSTXL-DAC-PORT, and DAC53401EVM are stacked. This page also shows the default jumper settings for the BOOSTXL-DAC-PORT.

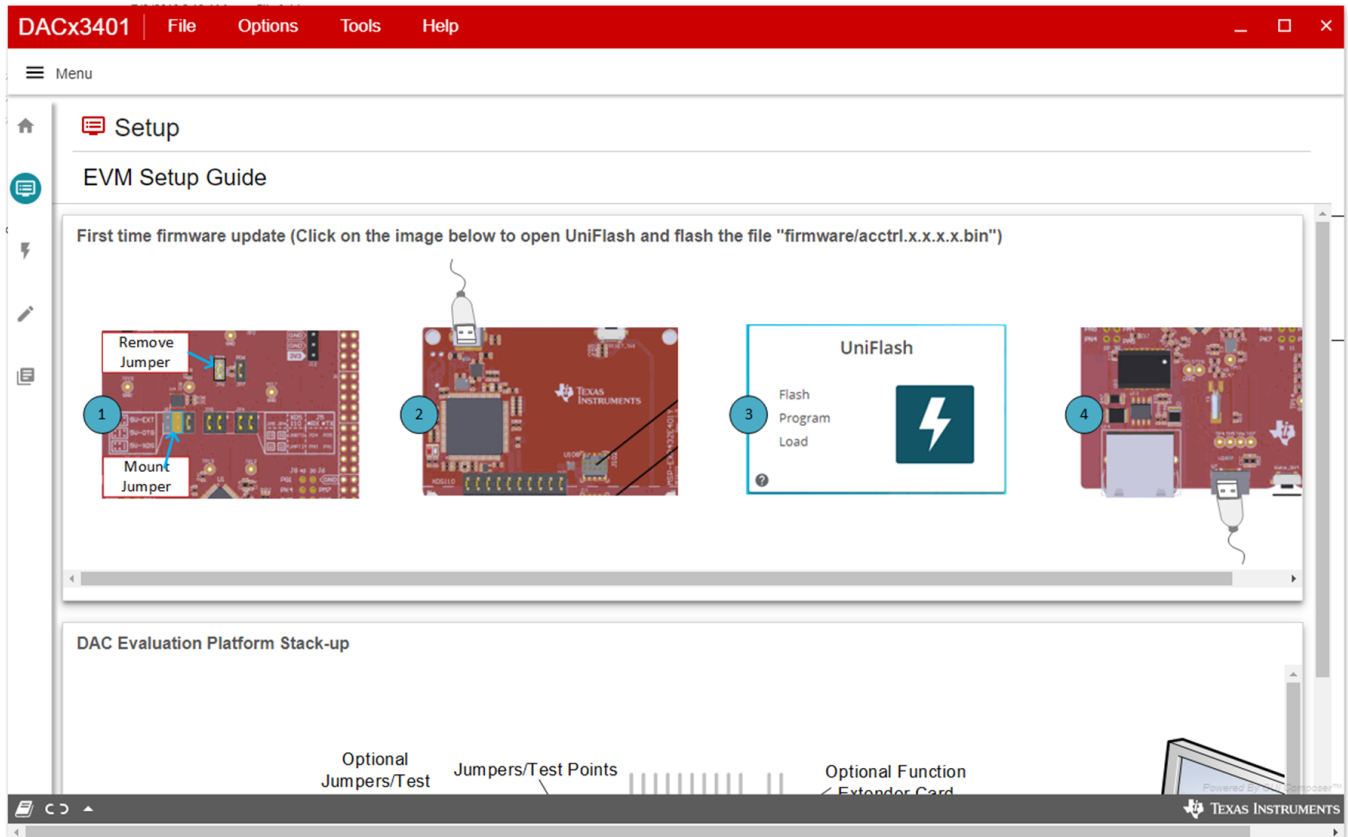

Figure 12. Setup Page

### 3.2.2.3 DAC Quick-Start Page

This page is divided into four tabs: basic DAC, margining, functions, and alarms. The following subsections describe each tab.

#### 3.2.2.3.1 Basic DAC Tab

The *Basic DAC* setup tab is shown in [Figure 15](#) provides an interface to quickly power up, select the reference and output span, and program the output voltage (decimal) for the DAC53401. The DAC53401 comes in Hi-Z power-down mode by default.

**NOTE:** The basic DAC setup for power up, reference selection, and output span selection available in this tab is common to all the tab functions.

The EEPROM *PROGRAM* button is used to write the latest register settings to the EEPROM. The *RELOAD* button is used to retrieve the settings stored in the EEPROM. The A0 pin programming has not been provided in this version of the software, although the hardware has options for all four possible configurations.

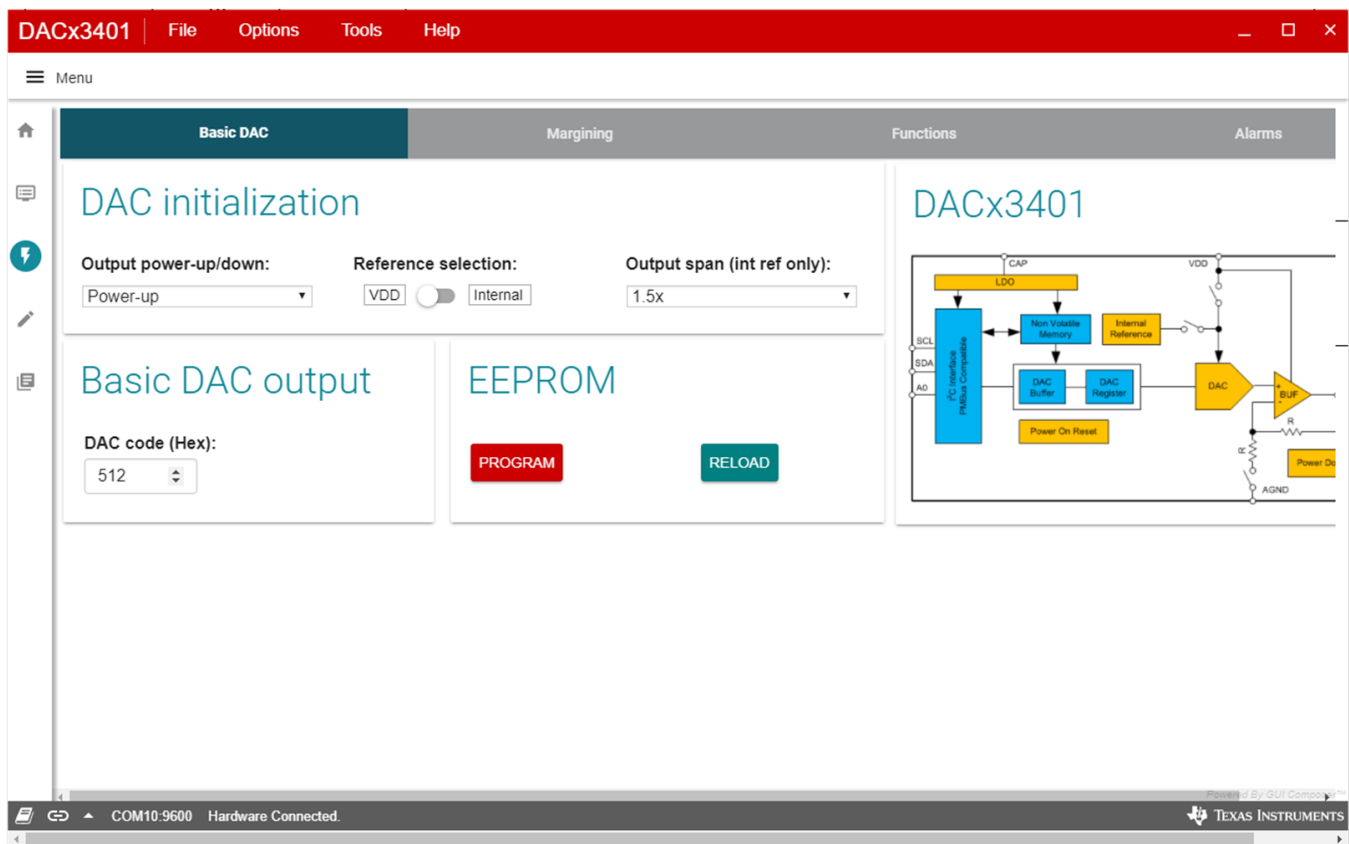

Figure 13. DAC Quick-Start Page: Basic DAC Tab

### 3.2.2.3.2 Margining Tab

The second tab on the quick-start page is Margining, as shown in Figure 14. This page provides the settings for margin-low, margin-high, and nominal DAC outputs along with code-step and slew-rate for the ramp generation. The margin-low and the margin-high triggers are by the respective buttons. The register settings are programmed or retrieved using the EEPROM *PROGRAM* or *RELOAD* buttons, respectively. The trigger bits are not loaded to the EEPROM because they are edge sensitive.

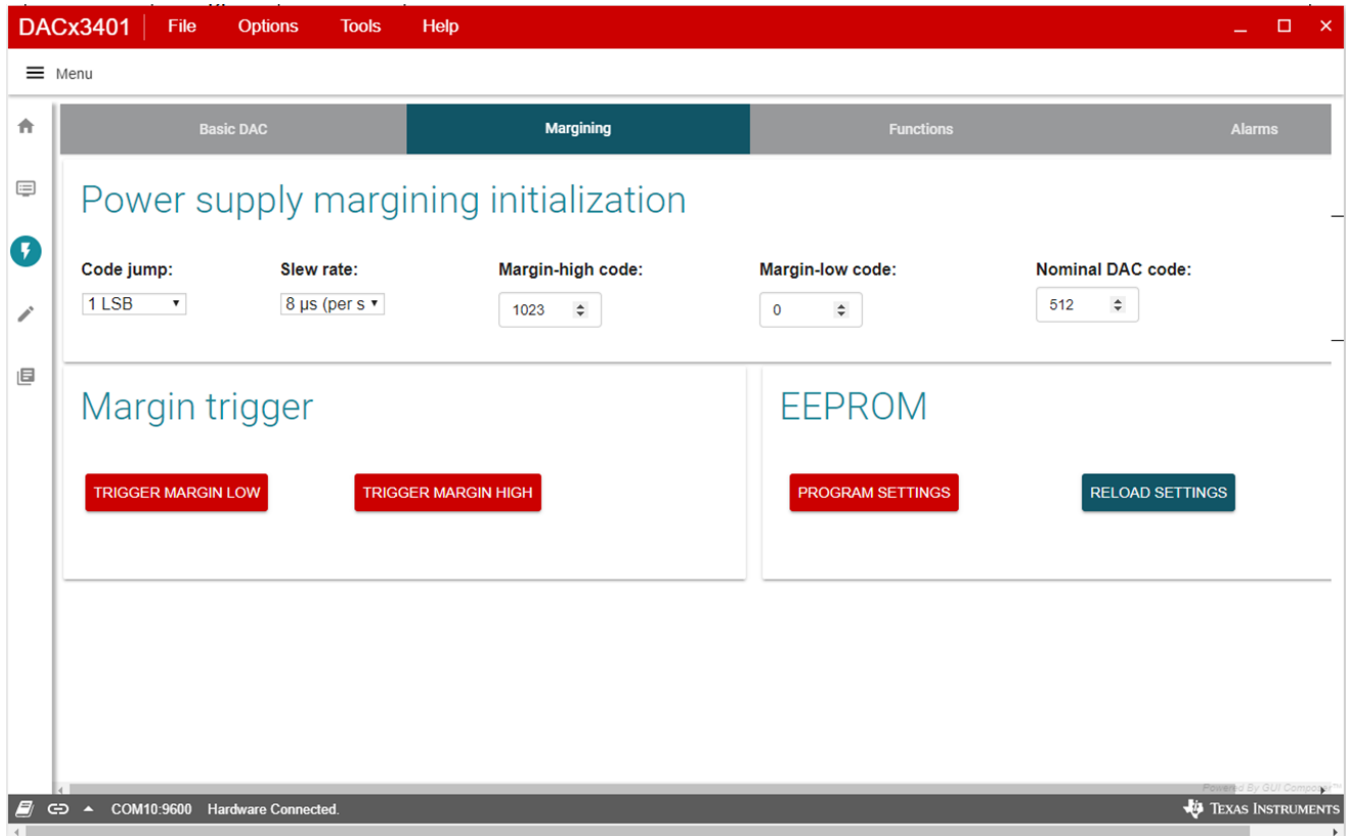

Figure 14. DAC Quick-Start Page: Margining Tab

### 3.2.2.3.3 Functions Tab

The next tab on the quick-start page is Functions, for function generation as shown in [Figure 15](#). This page provides the ramp programming done through code-step and slew-rate settings. The most basic setting for this functionality is the function selection: triangular wave, saw-tooth wave, reverse saw-tooth wave, and square wave. The margin-low and margin-high settings define the lower and the upper bounds of the waveform, respectively. The toggle button starts or stops the defined function generation. Any change to the function settings can only be done when the function is off. The register settings can be programmed or retrieved using the EEPROM *PROGRAM* or *RELOAD* buttons, respectively.

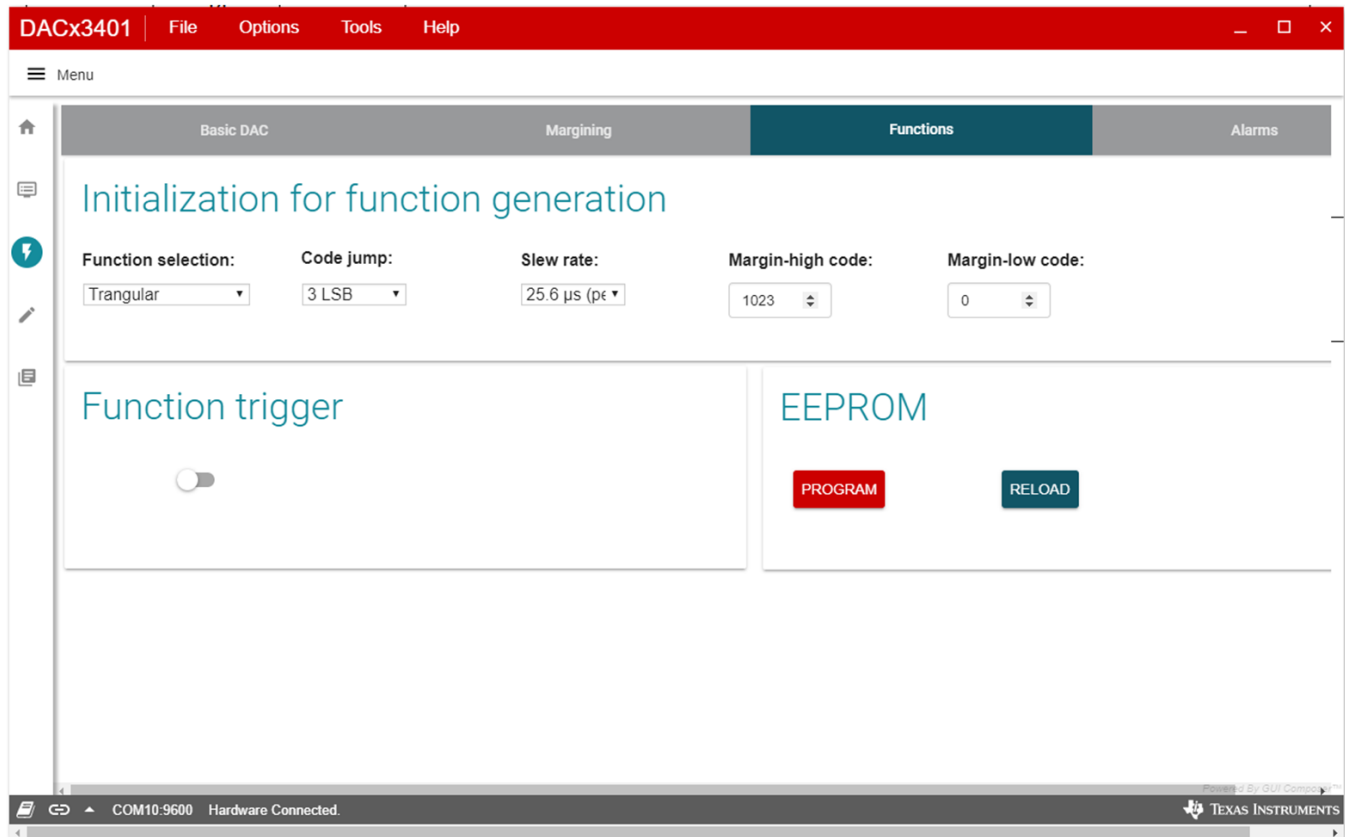

Figure 15. DAC Quick Start Page: Function Generation

### 3.2.2.3.4 Alarms Tab

The Alarm tab on the quick-start page is a special medical alarm function provided by DACx3401. The settings for this function are as shown in Figure 16. The ramp generation settings are similar to that of function generation: code-step, slew-rate, margin-low, and margin-high. In addition to these settings, the medical alarms have three more settings: interburst time, pulse-off time, and pulse-on time. These settings have four common settings that take different values depending on the type of alarm selected. Refer to the [DAC53401 data sheet](#) for these timing details. There are three types of alarms: low-priority, medium-priority, and high-priority. The radio buttons are used to trigger any one of the alarms. The register settings are programmed or retrieved using the EEPROM *PROGRAM* or *RELOAD* buttons, respectively.

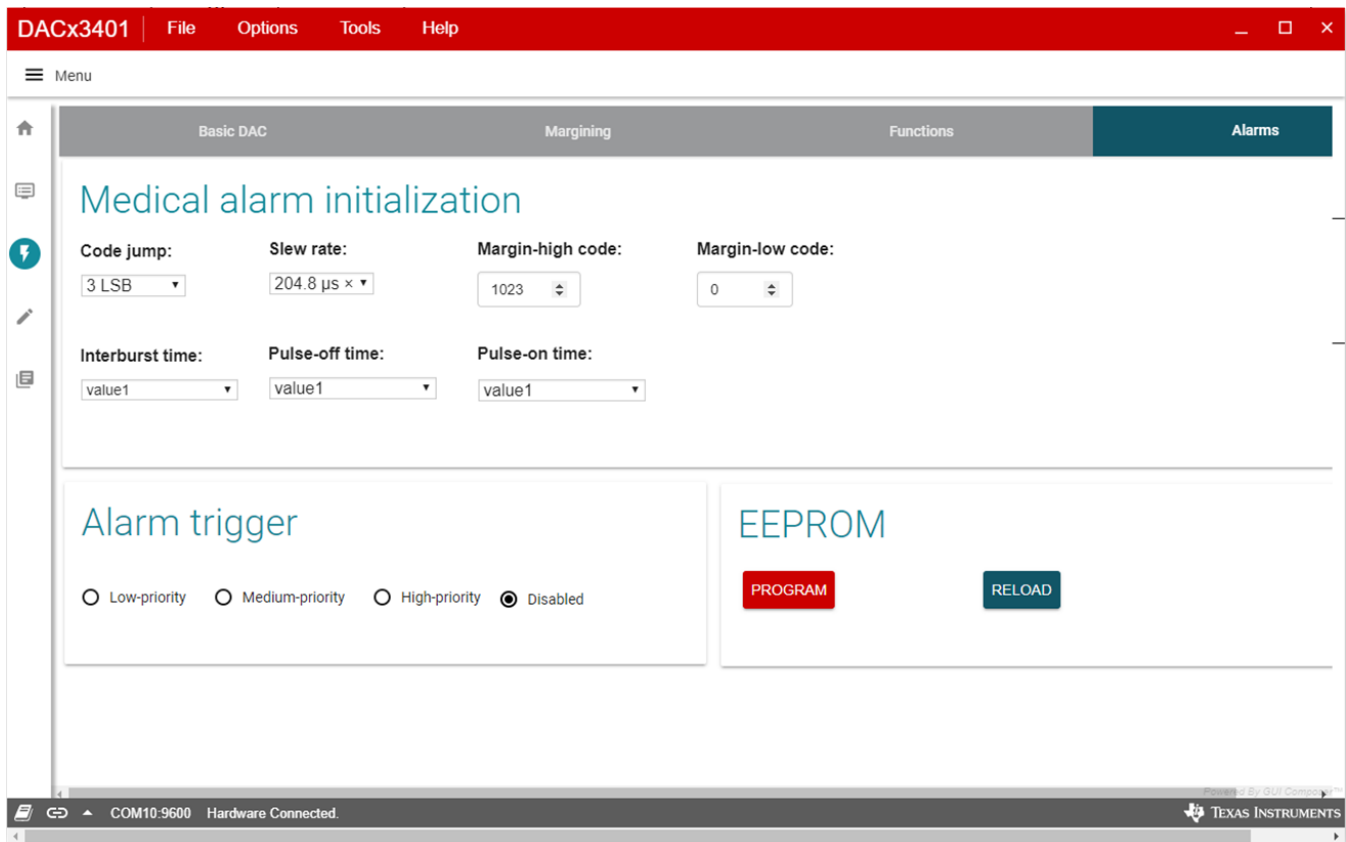

Figure 16. DAC Quick-Start Page: Alarms Tab

### 3.2.2.4 Register Map Page

The DAC53401 EVM *Register Map* page, shown in Figure 17, allows the user to access low level communication directly with the DAC53401 registers. Selecting a register on the *Register Map* list shows a description of the values in that register, as well as information on the register address, default value, size, and current value. Values are read from and written to the registers by writing to the *Value* or bit field of the GUI.

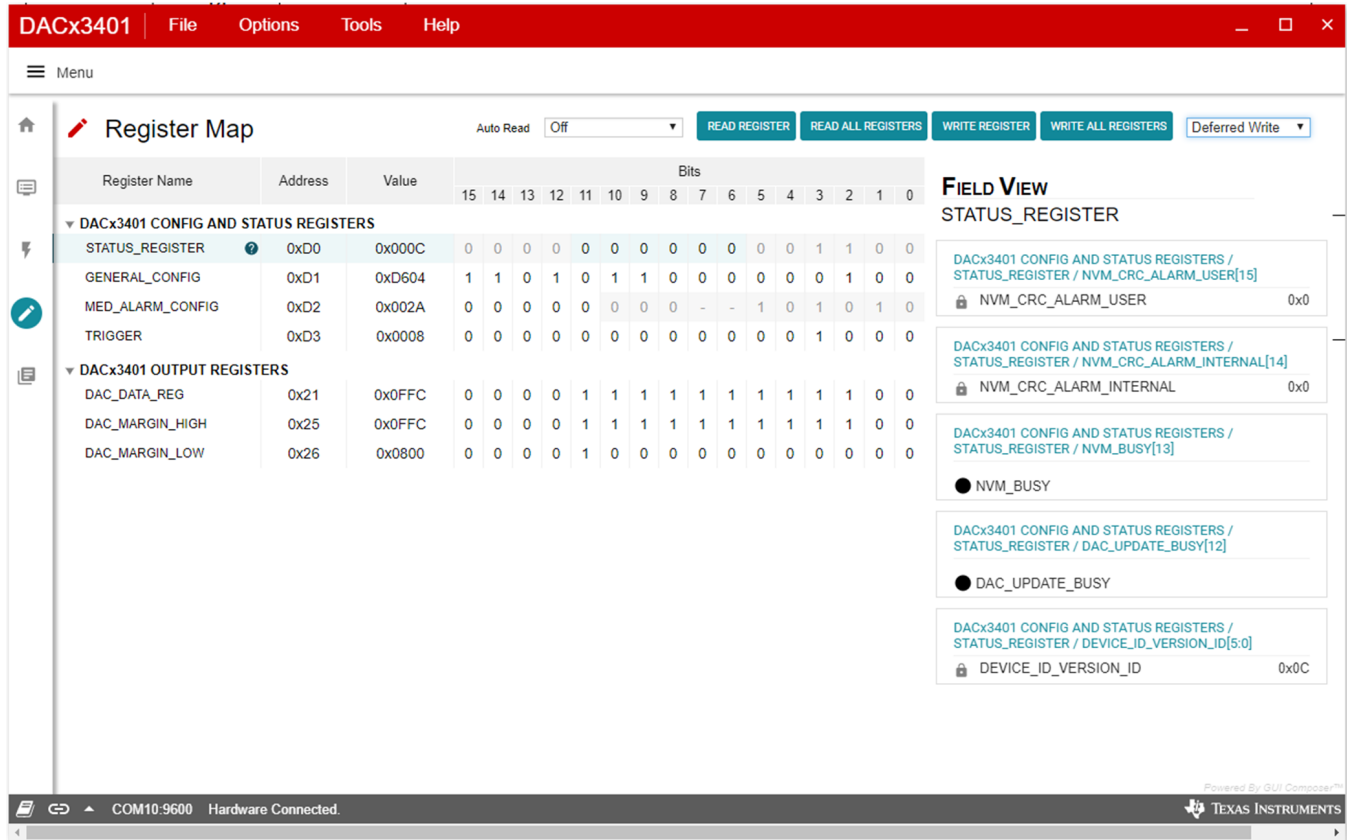

Figure 17. Register Map Page

There are some configuration lists and action buttons provided on the *Register Map* page. The values of the register map can be stored locally by pressing the *Save Registers* button under the *File* menu option. Additionally, the stored configuration files can be recalled and loaded through the *Load Registers* button. Other options selectable by the user are the *Auto Read Interval*, *Read Register*, *Read All Registers*, *Write Register*, *Write All Registers*, and *Update Mode* buttons. All buttons are displayed in Figure 18. The *Write Register* and *Write All Registers* buttons are enabled only with *Deferred* update mode. *Deferred* mode initiates a write operation only when the *Write Register* or the *Write All Registers* button is pressed. By default, the *Immediate* update mode is selected for the *Register Map* page write operations.



Figure 18. Register Page Options



### 3.2.2.5 Collateral Page

This page shown in [Figure 19](#) provides links for all the collateral on the DAC53401 device.

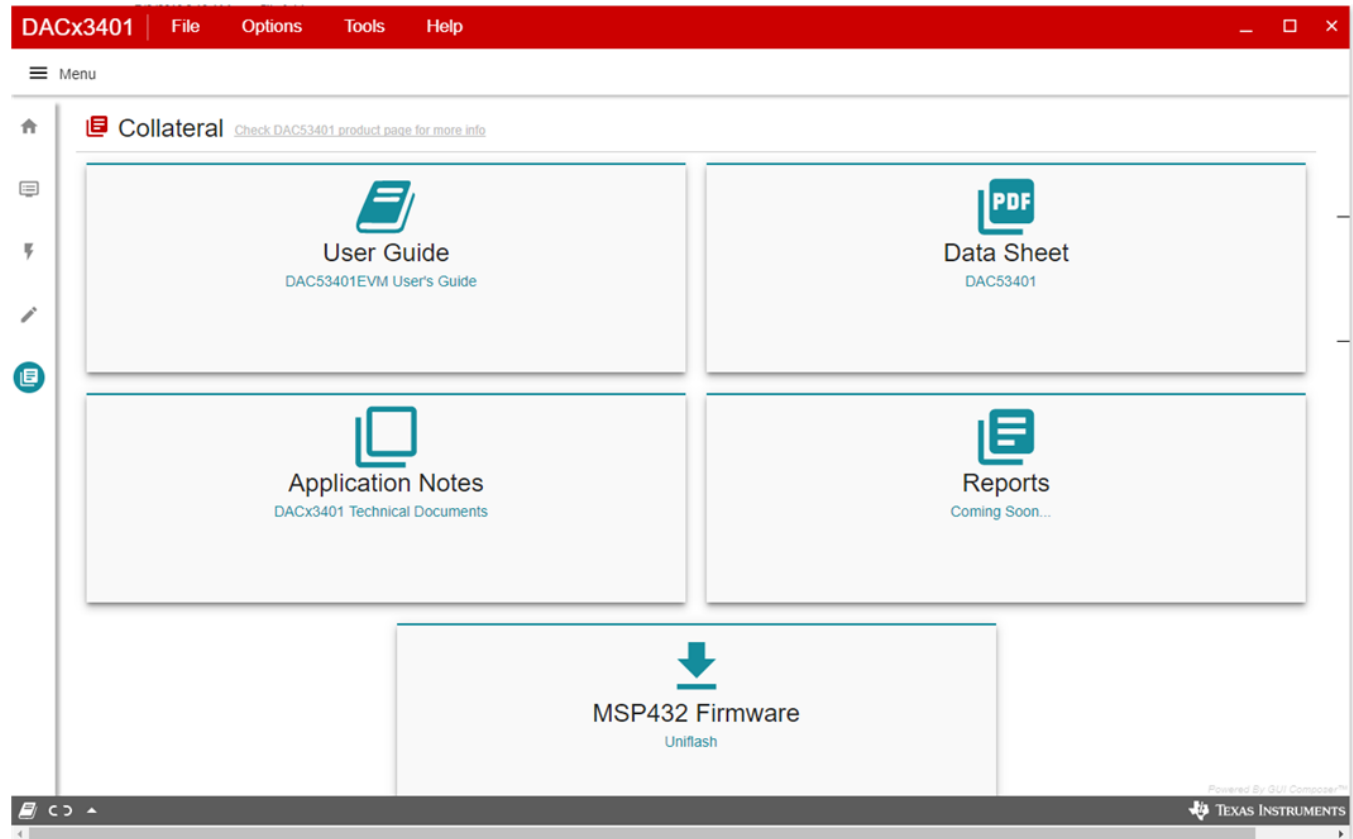
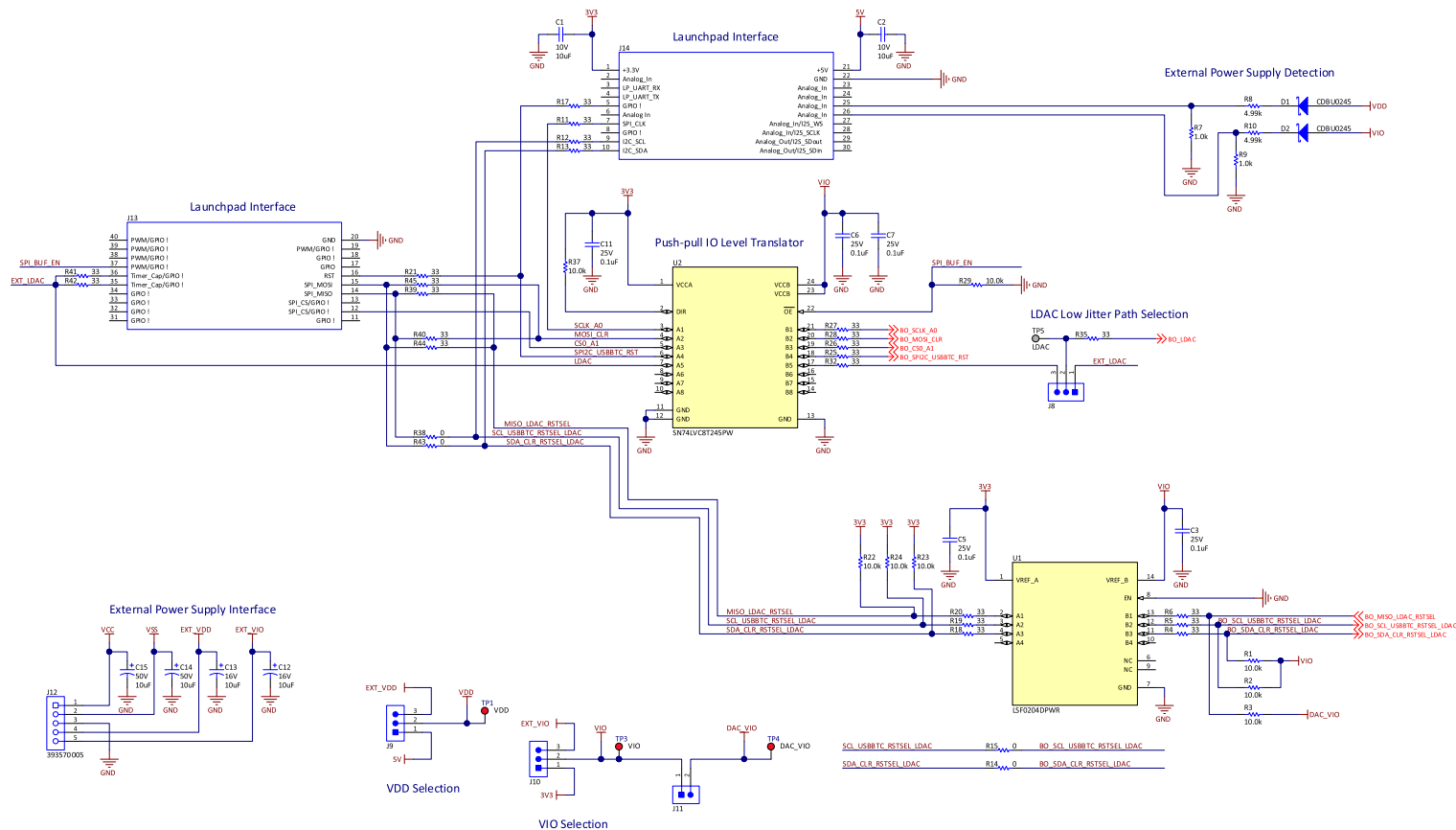

Figure 19. Collateral Page

## 4 Schematic, PCB Layout, and Bill of Materials

This section contains the complete bill of materials and schematic diagram for the BOOSTXL-DAC-PORT and DAC53401EVM.

### 4.1 BOOSTXL-DAC-PORT Schematic



Copyright © 2018, Texas Instruments Incorporated

Figure 20. BOOSTXL-DAC-PORT Schematic Page 1

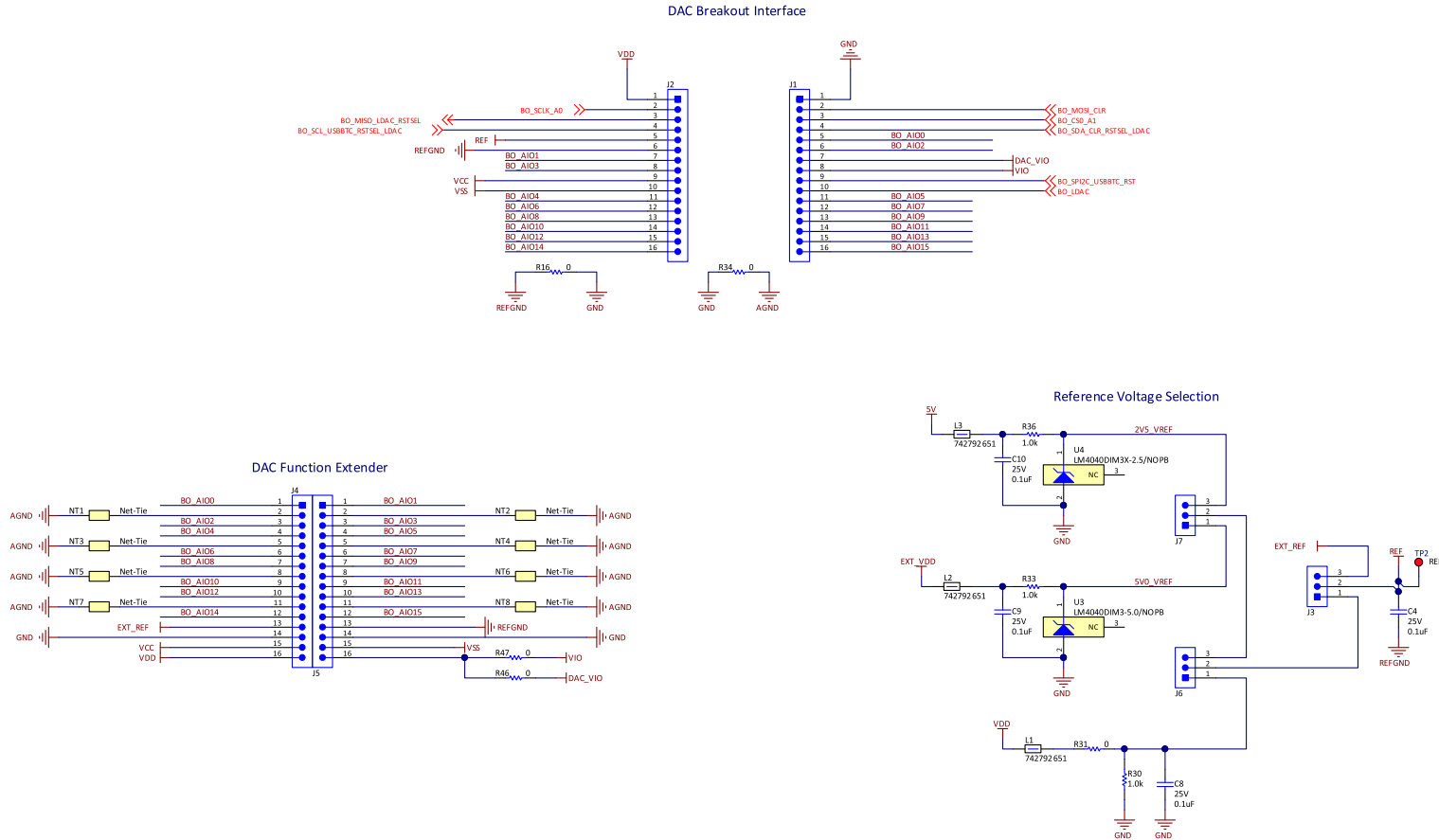

Copyright © 2018, Texas Instruments Incorporated

Figure 21. BOOSTXL-DAC-PORT Schematic Page 2



### 4.3 PCB Components Layout

Figure 23 through Figure 27 show the layout of the components for the DAC53401EVM board.

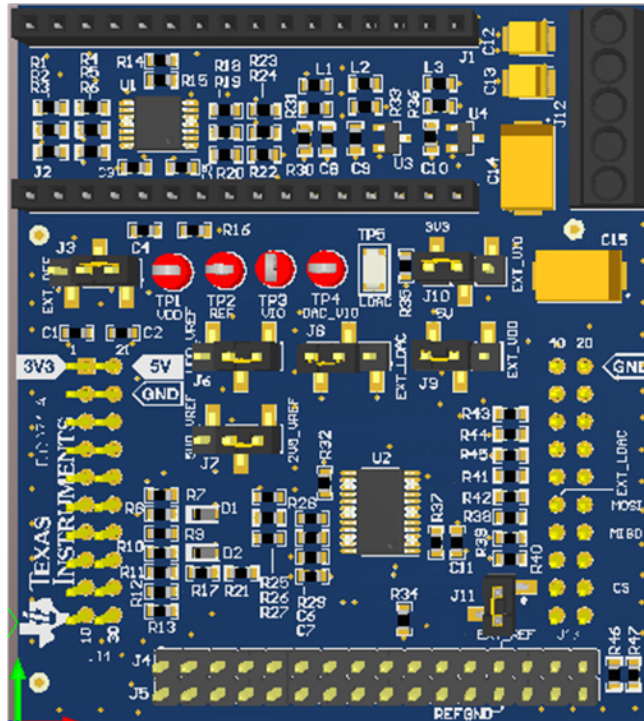

Figure 23. BOOSTXL-DAC-PORT PCB Components Layout

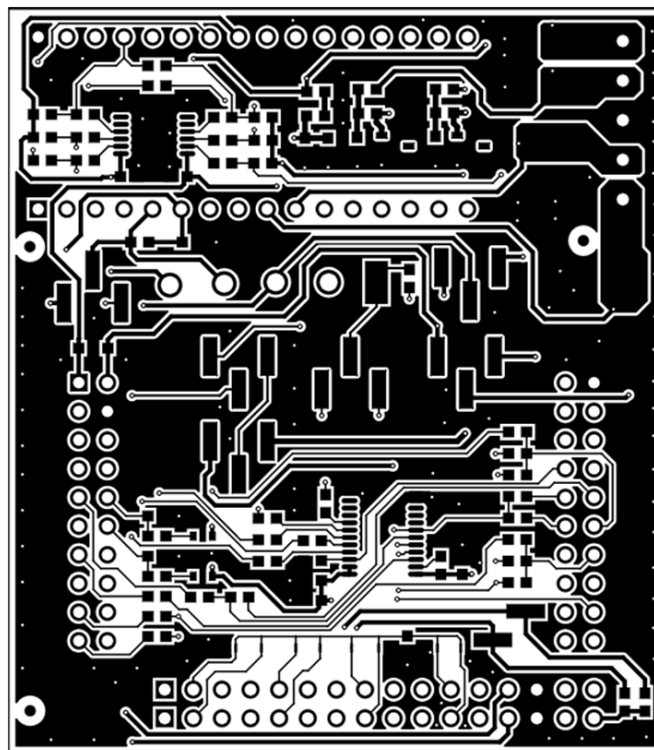

Figure 24. BOOSTXL-DAC-PORT Top Layer

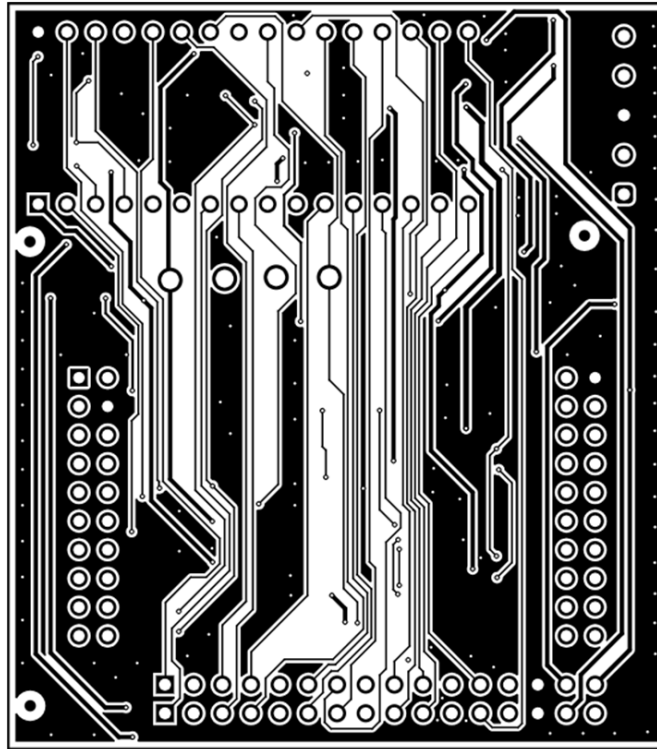

Figure 25. BOOSTXL-DAC-PORT Bottom Layer

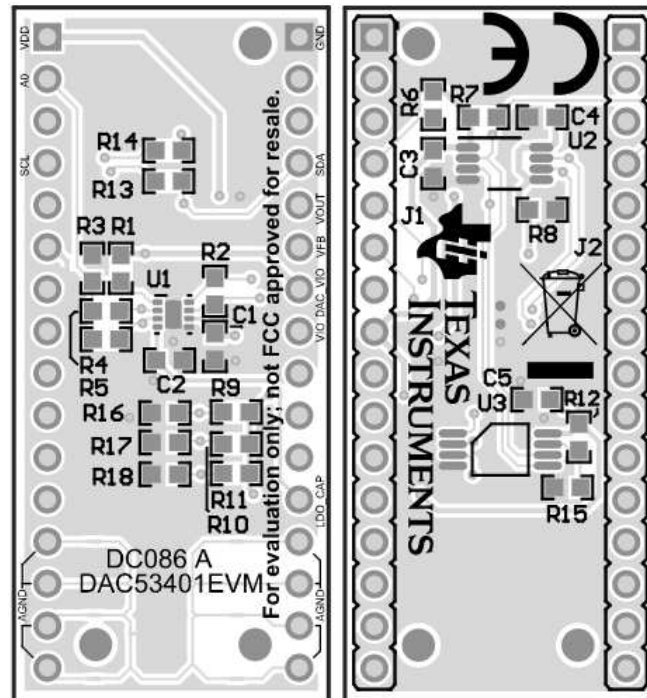

Figure 26. DAC53401EVM PCB Components Layout



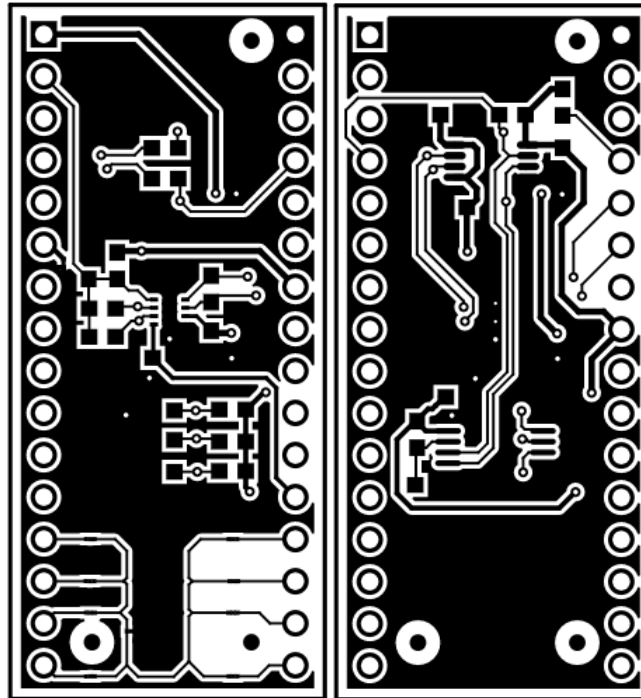

Figure 27. DAC53401EVM Layers

#### 4.4 BOOSTXL-DAC-PORT Bill of Materials

**Table 13. BOOSTXL-DAC-PORT Bill of Materials**

Designator	Quantity	Value	Description	Package Reference	Part Number	Manufacturer
!PCB1	1		Printed Circuit Board		DC071	Any
C1, C2	2	10uF	CAP, CERM, 10 uF, 10 V, +/- 20%, X7R, 0603	0603	GRM188Z71A106MA73D	MuRata
C3, C4, C5, C6, C7, C8, C9, C10, C11	9	0.1uF	CAP, CERM, 0.1 uF, 25 V, +/- 10%, X7R, 0603	0603	C1608X7R1E104K080AA	TDK
C12, C13	2	10uF	CAP, TA, 10 uF, 16 V, +/- 10%, 2 ohm, SMD	3528-21	293D106X9016B2TE3	Vishay-Sprague
C14, C15	2	10uF	CAP, TA, 10 uF, 50 V, +/- 10%, 0.5 ohm, SMD	7343-43	TPSE106K050R0500	AVX
D1, D2	2	50V	Diode, Schottky, 50 V, 0.2 A, SOD-523F	SOD-523F	CDBU0245	Comchip Technology
J1, J2	2		Receptacle, 2.54mm, 16x1, Tin, TH	Receptacle, 2.54mm, 16x1, TH	PPTC161LFBN-RC	Sullins Connector Solutions
J3, J6, J7, J8, J9, J10	6		Header, 2.54mm, 3x1, Gold, SMT	Header, 2.54mm, 3x1, SMT	TSM-103-01-L-SV-P-TR	Samtec
J4, J5	2		Header, 2.54mm, 16x1, TH	Header, 2.54mm, 16x1, TH	22284160	Molex
J11	1		Header, 100mil, 2x1, Gold with Tin Tail, SMT	2x1 Header	TSM-102-01-L-SV	Samtec
J12	1		Terminal Block, 3.5mm, 5x1, Tin, TH	Terminal Block, 3.5mm, 5x1, TH	393570005	Molex
J13, J14	2		Receptacle, 2.54mm, 10x2, Tin, TH	10x2 Receptacle	SSQ-110-03-T-D	Samtec
L1, L2, L3	3	600 ohm	Ferrite Bead, 600 ohm @ 100 MHz, 1 A, 0603	0603	742792651	Würth Elektronik
LBL1	1		Thermal Transfer Printable Labels, 0.650" W x 0.200" H - 10,000 per roll	PCB Label 0.650 x 0.200 inch	THT-14-423-10	Brady
R1, R2, R3, R22, R23, R24, R29, R37	8	10.0k	RES, 10.0 k, 1%, 0.1 W, 0603	0603	RC0603FR-0710KL	Yageo America
R4, R5, R6, R11, R12, R13, R17, R18, R19, R20, R21, R25, R26, R27, R28, R32, R35, R39, R41, R42, R45	21	33	RES, 33, 5%, 0.1 W, AEC-Q200 Grade 0, 0603	0603	CRCW060333R0JNEA	Vishay-Dale
R7, R9, R30, R33, R36	5	1.0k	RES, 1.0 k, 5%, 0.1 W, AEC-Q200 Grade 0, 0603	0603	CRCW06031K00JNEA	Vishay-Dale

**Table 13. BOOSTXL-DAC-PORT Bill of Materials (continued)**

Designator	Quantity	Value	Description	Package Reference	Part Number	Manufacturer
R8, R10	2	4.99k	RES, 4.99 k, 1%, 0.1 W, 0603	0603	CR0603-FX-4991ELF	Bourns
R14, R31, R34, R47	4	0	RES, 0, 5%, 0.1 W, 0603	0603	RC0603JR-070RL	Yageo America
SH-J1, SH-J2, SH-J3, SH-J4, SH-J5, SH-J6, SH-J7	7	1x2	Shunt, 100mil, Gold plated, Black	Shunt	SNT-100-BK-G	Samtec
TP1, TP2, TP3, TP4	4		Test Point, Compact, Red, TH	Red Compact Testpoint	5005	Keystone
TP5	1		Test Point, Miniature, SMT	Test Point, Miniature, SMT	5019	Keystone
U1	1		4-Bit Bidirectional Multi-Voltage Level Translator for Open-Drain & Push-Pull, PW0014A (TSSOP-14)	PW0014A	LSF0204DPWR	Texas Instruments
U2	1		8-Bit Dual-Supply Bus Transceiver with Configurable Voltage-Level Shifting and Three-State Outputs, PW0024A (TSSOP-24)	PW0024A	SN74LVC8T245PW	Texas Instruments
U3	1		Precision Micropower Shunt Voltage Reference, DBZ0003A (SOT-23-3)	DBZ0003A	LM4040DIM3-5.0/NOPB	Texas Instruments
U4	1		Precision Micropower Shunt Voltage Reference, DBZ0003A (SOT-23-3)	DBZ0003A	LM4040DIM3X-2.5/NOPB	Texas Instruments
R15, R16, R38, R43, R46	0	0	RES, 0, 5%, 0.1 W, 0603	0603	RC0603JR-070RL	Yageo America
R40, R44	0	33	RES, 33, 5%, 0.1 W, AEC-Q200 Grade 0, 0603	0603	CRCW060333R0JNEA	Vishay-Dale

#### 4.5 DAC53401EVM Bill of Materials

**Table 14. DAC53401EVM Bill of Materials**

Designator	Quantity	Value	Description	Package Reference	Part Number	Manufacturer
!PCB	1		Printed Circuit Board		DC086	Any
C1, C3, C4, C5	4	0.1uF	CAP, CERM, 0.1 uF, 25 V, +/- 10%, X7R, 0603	0603	C1608X7R1E104K080AA	TDK
J1, J2	2		Header, 2.54mm, 16x1, TH	Header, 2.54mm, 16x1, TH	22284160	Molex
R3, R6, R7, R8, R15, R16, R17, R18	9	10.0k	RES, 10.0 k, 1%, 0.1 W, 0603	0603	RC0603FR-0710KL	Yageo America
U1	1		10-Bit, I2C Interface, Buffered Voltage Output DAC, DSG0008A (WSON-8)	DSG0008A	DAC53401DSGR	Texas Instruments
U2	1		I2C BUS EEPROM (2-Wire), TSSOP-B8	TSSOP-8	BR24G32FVT-3AGE2	Rohm
U3	1		I2C Level-Translation I2C Bus Repeater, DGK0008A (VSSOP-8)	DGK0008A	TCA9800DGKR	Texas Instruments
C2	1	2.2uF	CAP, CERM, 2.2 uF, 10 V, +/- 10%, X7R, 0603	0603	C1608X7R1A225K080A C	TDK
R4, R5, R13, R14	0	0	RES, 0, 5%, 0.1 W, 0603	0603	RC0603JR-070RL	Yageo America
R9, R10, R11, R12	0	10.0k	RES, 10.0 k, 1%, 0.1 W, 0603	0603	RC0603FR-0710KL	Yageo America

## IMPORTANT NOTICE AND DISCLAIMER

TI PROVIDES TECHNICAL AND RELIABILITY DATA (INCLUDING DATA SHEETS), DESIGN RESOURCES (INCLUDING REFERENCE DESIGNS), APPLICATION OR OTHER DESIGN ADVICE, WEB TOOLS, SAFETY INFORMATION, AND OTHER RESOURCES "AS IS" AND WITH ALL FAULTS, AND DISCLAIMS ALL WARRANTIES, EXPRESS AND IMPLIED, INCLUDING WITHOUT LIMITATION ANY IMPLIED WARRANTIES OF MERCHANTABILITY, FITNESS FOR A PARTICULAR PURPOSE OR NON-INFRINGEMENT OF THIRD PARTY INTELLECTUAL PROPERTY RIGHTS.

These resources are intended for skilled developers designing with TI products. You are solely responsible for (1) selecting the appropriate TI products for your application, (2) designing, validating and testing your application, and (3) ensuring your application meets applicable standards, and any other safety, security, regulatory or other requirements.

These resources are subject to change without notice. TI grants you permission to use these resources only for development of an application that uses the TI products described in the resource. Other reproduction and display of these resources is prohibited. No license is granted to any other TI intellectual property right or to any third party intellectual property right. TI disclaims responsibility for, and you will fully indemnify TI and its representatives against, any claims, damages, costs, losses, and liabilities arising out of your use of these resources.

TI's products are provided subject to [TI's Terms of Sale](#) or other applicable terms available either on [ti.com](http://ti.com) or provided in conjunction with such TI products. TI's provision of these resources does not expand or otherwise alter TI's applicable warranties or warranty disclaimers for TI products.

TI objects to and rejects any additional or different terms you may have proposed.

Mailing Address: Texas Instruments, Post Office Box 655303, Dallas, Texas 75265  
Copyright © 2022, Texas Instruments Incorporated