

# Feedforward Capacitor to Improve Stability and Bandwidth With the TPS621-Family and TPS821-Family

Matt Guibord

Battery Power Applications

## ABSTRACT

A common method to improve the stability and bandwidth of a power supply is to use a feedforward capacitor, which is a capacitor placed across the high-side feedback resistor. This capacitor adds a zero and a pole ( $f_z < f_p$ ) to the control loop, which can be strategically placed to improve the phase margin and bandwidth. This improvement can be measured in both the transient response and bode plot of the new circuit. This application report details two design strategies for placing the pole and zero at the optimal frequency to improve transient response and circuit stability for the TPS62130/40/50/60/70 DCS-Control™ devices. Additional information may be found in the TI application report *Optimizing the TPS62130/40/50/60/70 Output Filter*.

## Trademarks

DCS-Control is a trademark of Texas Instruments.  
All other trademarks are the property of their respective owners.

## 1 Adding Extra Capacitance

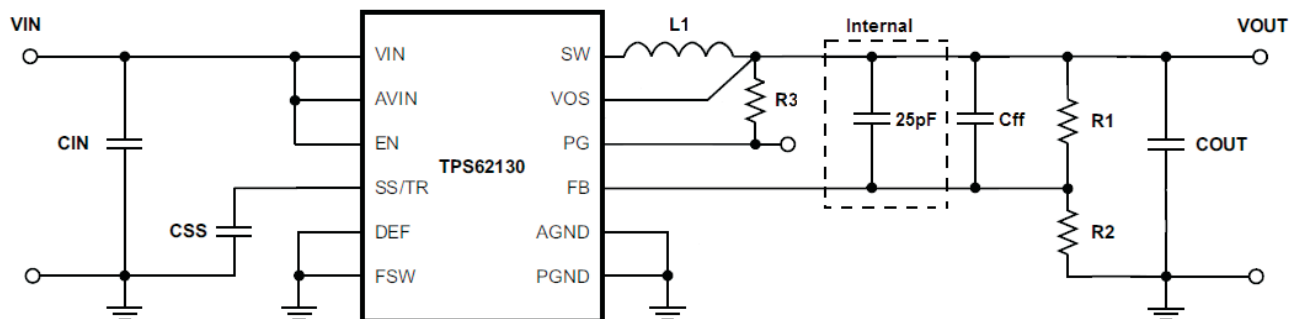

**Figure 1. Simplified Schematic With Internal and External Feedforward Capacitors Shown**

The traditional method of designing with a feedforward capacitor is to add an external capacitor ( $C_{ff}$ ) in parallel with the high-side feedback resistor,  $R_1$  in [Figure 1](#). The capacitor value is chosen based on the values of the feedback resistors to place the geometric mean of the pole and zero at the unity gain crossover frequency. The application report *Optimizing Transient Response of Internally Compensated dc-dc Converters With Feedforward Capacitor* ([SLVA289](#)) presents an equation to calculate the optimal feedforward capacitor. Because the TPS6213x/4x/5x/6x/7x family of integrated circuits has an internal 25-pF feedforward capacitor, the equation must be modified as shown in [Equation 1](#).

$$C_{ff} = \frac{1}{2\pi f_{CO}} \sqrt{\frac{1}{R_1} \left( \frac{1}{R_1} + \frac{1}{R_2} \right)} - 25 \text{ pF} \quad (1)$$

Where  $f_{CO}$  is the unity gain crossover frequency of the control loop without the external feedforward capacitor installed and  $R_1$  and  $R_2$  are the high-side and low-side feedback resistors, respectively. **Figure 1** shows the locations of the feedback resistors and feedforward capacitor. This capacitor value places the geometric mean of the zero and pole at  $f_{CO}$ , which provides the best phase margin boost. The actual frequencies of the zero and pole are calculated using [Equation 2](#) and [Equation 3](#). Note that the pole is always at a higher frequency than the zero because  $R_1$  is always larger than  $R_1//R_2$ .

$$f_Z = \frac{1}{2\pi R_1 C_{ff}} \quad (2)$$

$$f_P = \frac{1}{2\pi (R_1 // R_2) C_{ff}} \quad (3)$$

As an example, take a 12-V<sub>in</sub>, 3.3-V<sub>out</sub> TPS62130 design with a 4.7- $\mu$ H inductor, 200- $\mu$ F output capacitor,  $R_1$  as 10 k $\Omega$ , and  $R_2$  as 3.16 k $\Omega$ . First, the loop gain without the feedforward capacitor needs to be measured to find the unity gain crossover frequency. The application report *How to Measure Control Loop of TPS62130/40/50/60/70 DCS-Control™ Devices (SLVA465)* explains how to take a loop measurement on the DCS-Control™ topology and **Figure 2** shows the results. The crossover frequency is 33.62 kHz, so [Equation 1](#) is used to calculate that 941 pF of extra capacitance is needed. **Figure 3** shows the new loop response with an added 1000-pF  $C_{ff}$  compared with the response without the external  $C_{ff}$ .

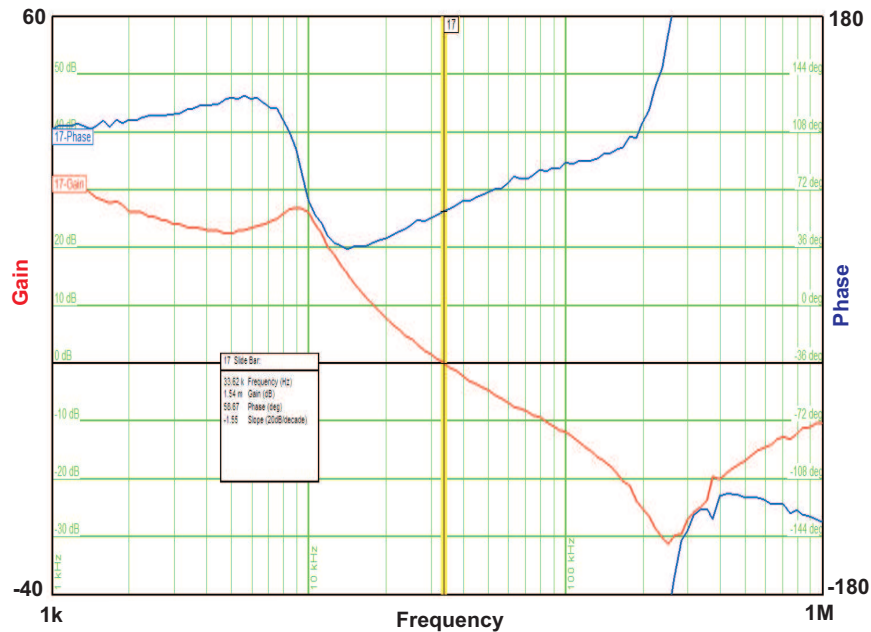

**Figure 2. Measuring the Gain Crossover Frequency Without a Feedforward Capacitor**

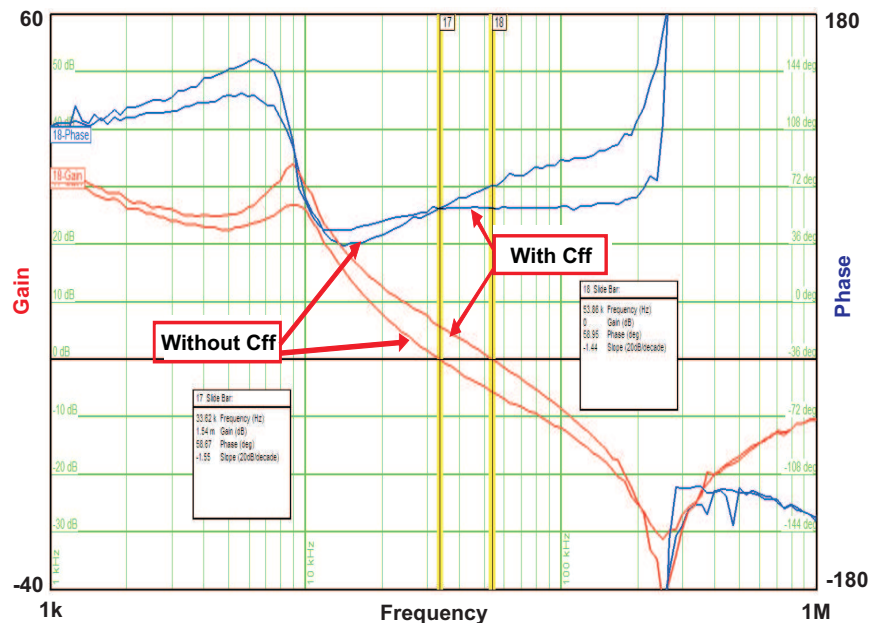

Figure 3. Loop Gain With and Without Feedforward Capacitor

Figure 4 shows the load transient response before and after adding the additional Cff. The increase in loop bandwidth due to the Cff is seen in the bode plot, whereas the transient response shows the tangible benefit of the gain in bandwidth. The transient response is faster and the voltage undershoot is less with the external Cff. In addition, no ringing occurs in the output voltage because the phase is not allowed to dip as low due to the added zero. Note that with the external Cff, the load regulation is reduced somewhat as shown by the different final values of the output voltage in Figure 4. This effect is more pronounced for smaller external Cff values. For this reason, adjusting the resistors and using only the internal 25-pF Cff is the preferred method of loop response optimization as discussed in the next section.

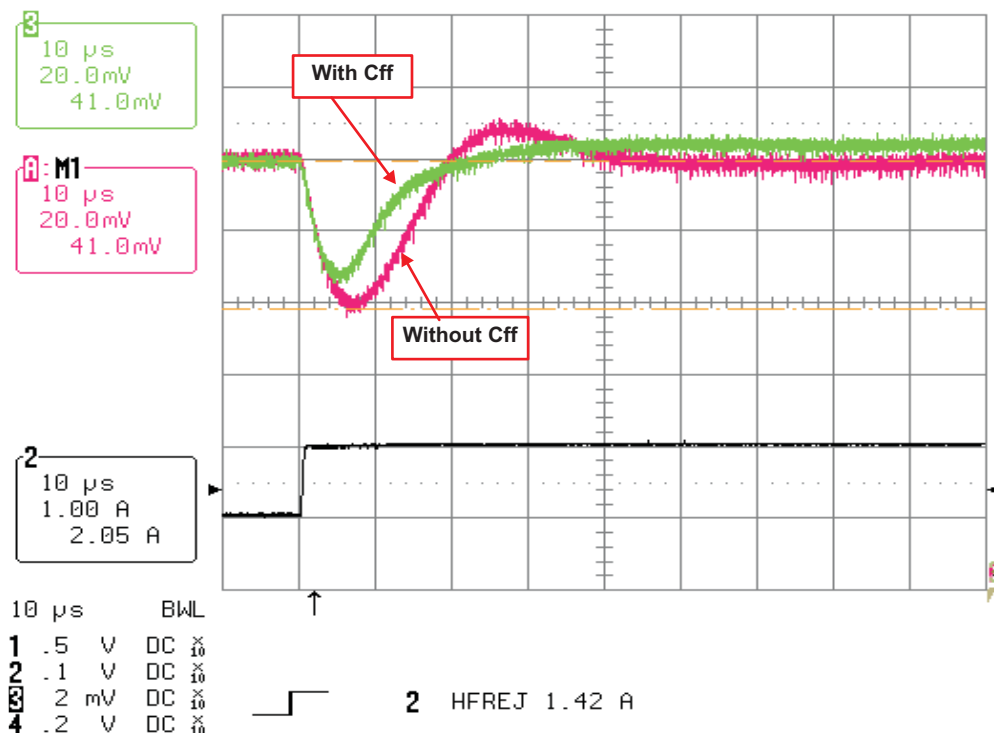

Figure 4. Load Transient Response With and Without Feedforward Capacitor

## 2 Choosing Feedback Resistors Based on Internal Cff

The second and preferred method of designing a TPS62130/40/50/60/70 power supply with a feedforward capacitor is to choose the feedback resistors based on the internal 25-pF feedforward capacitor. This method is unique to this family of devices because of the internal capacitor. The benefit of using this method is the ability to eliminate one component from the circuit to reduce production costs while keeping superior load regulation in practice.

The first step is to measure the control loop with resistors that place the zero due to the internal feedforward capacitor at a frequency higher than the gain crossover point. Because the feedforward capacitor does not have an effect at frequencies higher than 100 kHz (see [Section 3](#)), choose  $R_1$  such that the frequency of the zero is at least greater than 100 kHz. To completely eliminate the effect of the zero's phase response, the zero must be placed one decade above the gain crossover frequency. Therefore, placing the zero at 1 MHz is sufficient for all gain crossover frequencies. Using [Equation 2](#), an appropriate high-side resistor can be calculated as shown by the following equations.

$$R_1 = \frac{1}{2\pi(1 \text{ MHz})(25 \text{ pF})} \approx 6.34 \text{ k}\Omega \quad (4)$$

Therefore, using a 6.34-k $\Omega$  resistor is sufficient for any LC combination.  $R_2$  can be chosen for the desired output voltage using [Equation 5](#).

$$R_2 = \frac{R_1 \times V_{REF}}{V_{OUT} - V_{REF}} \quad (5)$$

For example, for a desired output of 3.3 V,  $R_2$  is calculated as:

$$R_2 = \frac{6.34 \text{ k}\Omega \times 0.8 \text{ V}}{3.3 \text{ V} - 0.8 \text{ V}} \approx 2.05 \text{ k}\Omega \quad (6)$$

From [Equation 2](#) and [Equation 3](#), the zero and pole are placed at 1 MHz and 4.194 MHz, respectively. The control loop gain can then be measured to find the unity gain crossover frequency without any effect from the internal Cff. The following equations then can be used to calculate  $R_1$  and  $R_2$  to reposition the geometric mean of the pole and zero to the crossover point, with Cff equal to 25 pF.

$$R_1 = \frac{1}{2\pi C_{ff} f_{CO}} \sqrt{\frac{V_{OUT}}{V_{REF}}} \quad (7)$$

$$R_2 = \frac{R_1 \times V_{REF}}{V_{OUT} - V_{REF}} \quad (8)$$

Continuing with the previous example, for a 3.3-V output and a crossover frequency of 30.3 kHz,  $R_1$  and  $R_2$  are calculated to be 432 k $\Omega$  and 137 k $\Omega$ , respectively. [Figure 5](#) shows the increased loop bandwidth and phase with the new resistor values. This causes the improved transient response in [Figure 6](#), which also has no ringing and excellent load regulation.

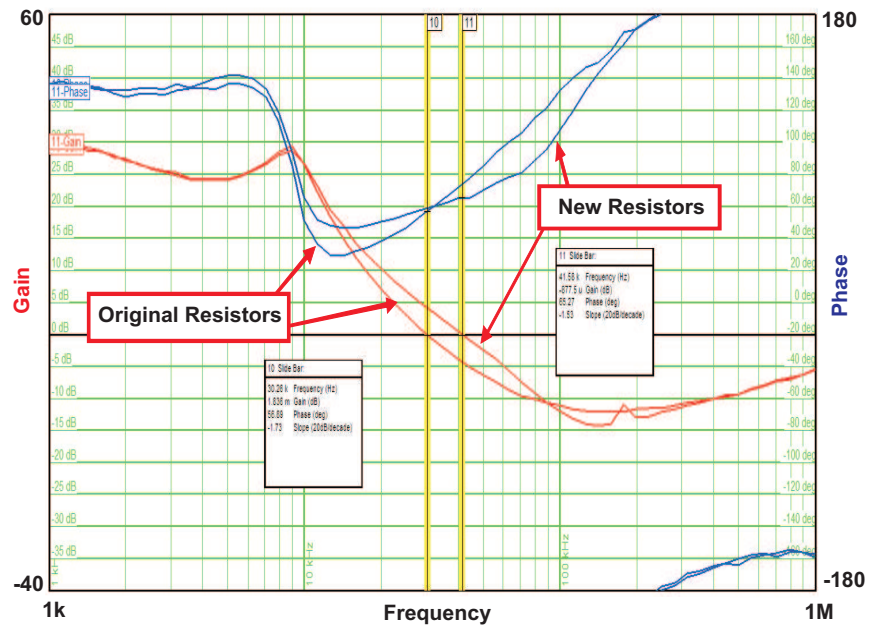

Figure 5. Loop Gain Before and After Optimizing Resistors

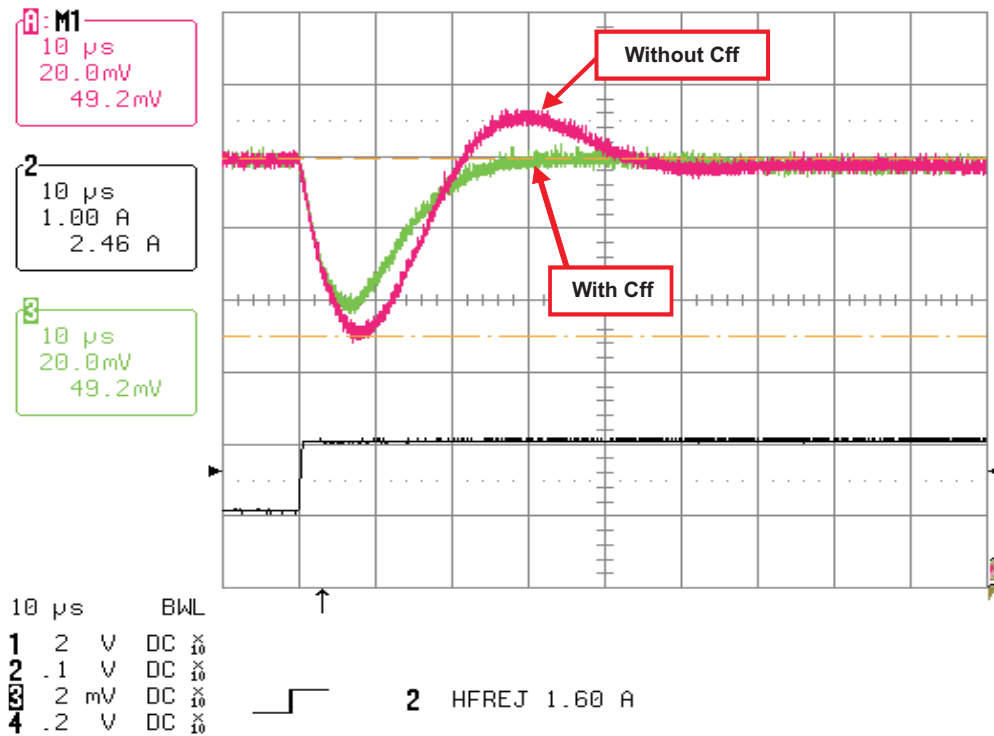

Figure 6. Load Transient Response Before and After Optimizing Resistors

### 3 Feedforward Capacitor for Gain Crossover Frequencies Above 100 kHz

At loop bandwidths above 100 kHz, the feedforward capacitor has limited or no effect on the response. This is a characteristic of the DCS-Control™ topology as implemented on the TPS62130/40/50/60/70. Figure 7 and Figure 8 show the results of optimizing the feedback resistors for the recommended 2.2-μH inductor and 22-μF output capacitor, which has a unity gain crossover frequency of 298.5 kHz. The lack of any significant change in the bode plot and load transient shows that the Cff has no effect.

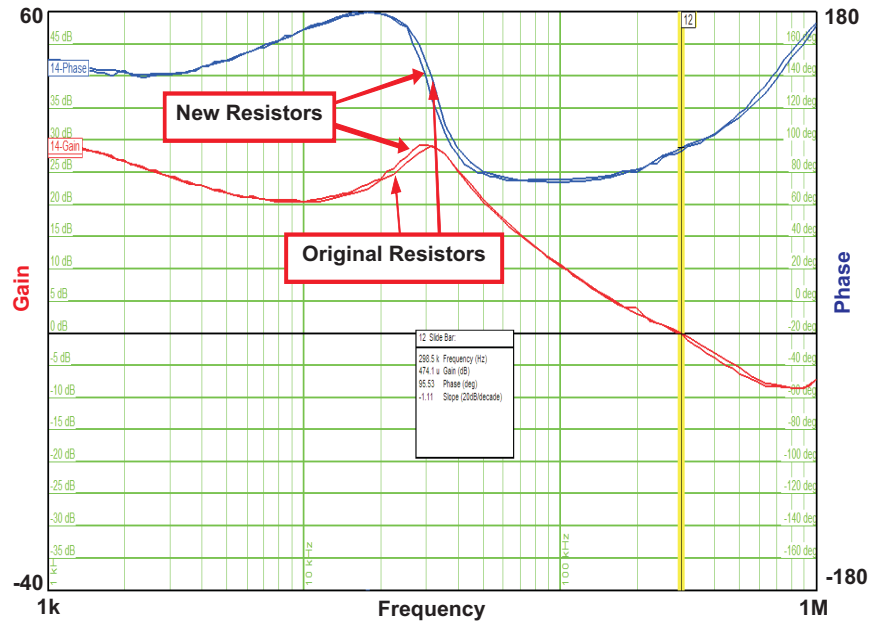

Figure 7. Loop Gain for 2.2-μH Inductor and 22-μF Capacitor

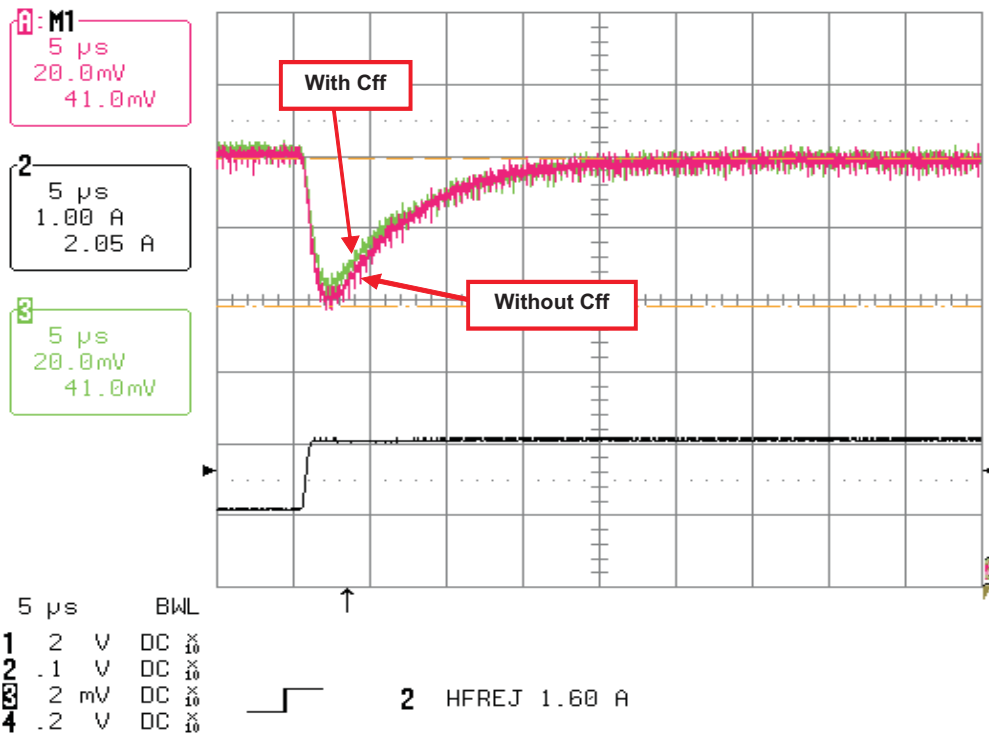

Figure 8. Load Transient Response for 2.2-μH Inductor and 22-μF Capacitor

## 4 Conclusion

This application report presents methods of improving the load transient response of the TPS62130/40/50/60/70 family of devices by using a feedforward capacitor. Either adding an external capacitor or adjusting the feedback resistors are two ways to improve the loop response for loop bandwidths below 100 kHz. For most designs, adjusting the feedback resistors to take advantage of the internal 25-pF C<sub>ff</sub> provides the best response without any extra components or negative performance effects.

## 5 References

1. *Optimizing the TPS62130/40/50/60/70 Output Filter* application report ([SLVA463](#))
2. *How to Measure Control Loop of TPS62130/40/50/60/70 DCS-Control™ Devices* application report ([SLVA465](#))
3. *TPS62130, 3-17V 3A Step-Down Converter in 3x3 QFN Package* data sheet ([SLVSAG7](#))
4. *Optimizing Transient Response of Internally Compensated dc-dc Converters With Feedforward Capacitor* application report ([SLVA289](#))

### Revision History

NOTE: Page numbers for previous revisions may differ from page numbers in the current version.

#### Changes from Original (December 2011) to A Revision

Page

- |                                |   |
|--------------------------------|---|
| • Changed document title. .... | 1 |
|--------------------------------|---|

## IMPORTANT NOTICE FOR TI DESIGN INFORMATION AND RESOURCES

Texas Instruments Incorporated ("TI") technical, application or other design advice, services or information, including, but not limited to, reference designs and materials relating to evaluation modules, (collectively, "TI Resources") are intended to assist designers who are developing applications that incorporate TI products; by downloading, accessing or using any particular TI Resource in any way, you (individually or, if you are acting on behalf of a company, your company) agree to use it solely for this purpose and subject to the terms of this Notice.

TI's provision of TI Resources does not expand or otherwise alter TI's applicable published warranties or warranty disclaimers for TI products, and no additional obligations or liabilities arise from TI providing such TI Resources. TI reserves the right to make corrections, enhancements, improvements and other changes to its TI Resources.

You understand and agree that you remain responsible for using your independent analysis, evaluation and judgment in designing your applications and that you have full and exclusive responsibility to assure the safety of your applications and compliance of your applications (and of all TI products used in or for your applications) with all applicable regulations, laws and other applicable requirements. You represent that, with respect to your applications, you have all the necessary expertise to create and implement safeguards that (1) anticipate dangerous consequences of failures, (2) monitor failures and their consequences, and (3) lessen the likelihood of failures that might cause harm and take appropriate actions. You agree that prior to using or distributing any applications that include TI products, you will thoroughly test such applications and the functionality of such TI products as used in such applications. TI has not conducted any testing other than that specifically described in the published documentation for a particular TI Resource.

You are authorized to use, copy and modify any individual TI Resource only in connection with the development of applications that include the TI product(s) identified in such TI Resource. NO OTHER LICENSE, EXPRESS OR IMPLIED, BY ESTOPPEL OR OTHERWISE TO ANY OTHER TI INTELLECTUAL PROPERTY RIGHT, AND NO LICENSE TO ANY TECHNOLOGY OR INTELLECTUAL PROPERTY RIGHT OF TI OR ANY THIRD PARTY IS GRANTED HEREIN, including but not limited to any patent right, copyright, mask work right, or other intellectual property right relating to any combination, machine, or process in which TI products or services are used. Information regarding or referencing third-party products or services does not constitute a license to use such products or services, or a warranty or endorsement thereof. Use of TI Resources may require a license from a third party under the patents or other intellectual property of the third party, or a license from TI under the patents or other intellectual property of TI.

TI RESOURCES ARE PROVIDED "AS IS" AND WITH ALL FAULTS. TI DISCLAIMS ALL OTHER WARRANTIES OR REPRESENTATIONS, EXPRESS OR IMPLIED, REGARDING TI RESOURCES OR USE THEREOF, INCLUDING BUT NOT LIMITED TO ACCURACY OR COMPLETENESS, TITLE, ANY EPIDEMIC FAILURE WARRANTY AND ANY IMPLIED WARRANTIES OF MERCHANTABILITY, FITNESS FOR A PARTICULAR PURPOSE, AND NON-INFRINGEMENT OF ANY THIRD PARTY INTELLECTUAL PROPERTY RIGHTS.

TI SHALL NOT BE LIABLE FOR AND SHALL NOT DEFEND OR INDEMNIFY YOU AGAINST ANY CLAIM, INCLUDING BUT NOT LIMITED TO ANY INFRINGEMENT CLAIM THAT RELATES TO OR IS BASED ON ANY COMBINATION OF PRODUCTS EVEN IF DESCRIBED IN TI RESOURCES OR OTHERWISE. IN NO EVENT SHALL TI BE LIABLE FOR ANY ACTUAL, DIRECT, SPECIAL, COLLATERAL, INDIRECT, PUNITIVE, INCIDENTAL, CONSEQUENTIAL OR EXEMPLARY DAMAGES IN CONNECTION WITH OR ARISING OUT OF TI RESOURCES OR USE THEREOF, AND REGARDLESS OF WHETHER TI HAS BEEN ADVISED OF THE POSSIBILITY OF SUCH DAMAGES.

You agree to fully indemnify TI and its representatives against any damages, costs, losses, and/or liabilities arising out of your non-compliance with the terms and provisions of this Notice.

This Notice applies to TI Resources. Additional terms apply to the use and purchase of certain types of materials, TI products and services. These include; without limitation, TI's standard terms for semiconductor products (<http://www.ti.com/sc/docs/stdterms.htm>), [evaluation modules](#), and [samples](http://www.ti.com/sc/docs/sampterm.htm) (<http://www.ti.com/sc/docs/sampterm.htm>).

Mailing Address: Texas Instruments, Post Office Box 655303, Dallas, Texas 75265  
Copyright © 2017, Texas Instruments Incorporated