

TPS7H4001EVM-CVAL Evaluation Module (EVM)

The TPS7H4001EVM-CVAL is the evaluation module (EVM) for the TPS7H4001-SP and provides a platform to electrically evaluate its features. This user's guide provides details about the EVM, its configuration, schematics, and BOM.

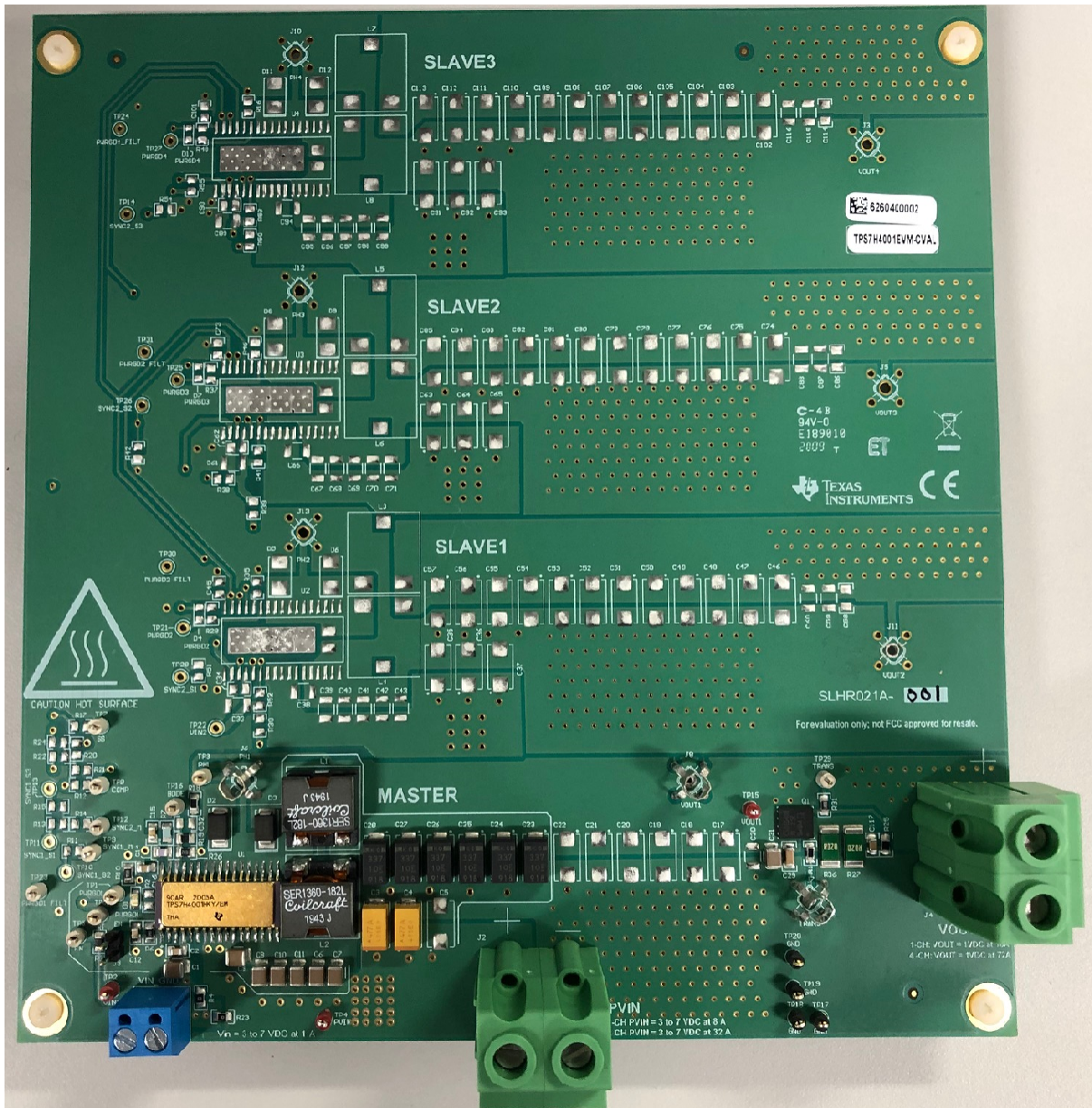

Figure 1. TPS7H4001EVM-CVAL -001 (Single Channel)

Contents

1	TPS7H4001EVM-CVAL Overview	3
2	TPS7H4001EVM-CVAL Default Configuration.....	4
3	TPS7H4001EVM-CVAL Initial Setup	5
4	TPS7H4001EVM-CVAL Testing	7
5	TPS7H4001EVM-CVAL EVM Schematic	17
6	TPS7H4001EVM-CVAL Bill of Materials (BOM)	18
7	Board Layout.....	21

List of Figures

1	TPS7H4001EVM-CVAL -001 (Single Channel).....	1
2	TPS7H4001EVM-CVAL Setup	6
3	Output Voltage Regulation	7
4	Output Voltage Ripple $V_{IN} = 5\text{ V}$, $V_{OUT} = 1\text{ V}$, $I_{OUT} = 18\text{ A}$	8
5	Output Soft Start Voltage, $V_{IN} = 5\text{ V}$, $V_{OUT} = 1\text{ V}$, $I_{OUT} = 18\text{ A}$	9
6	Transient Response to Load Step 9 A to 18 A at 1 A/ μs	10
7	Transient Response to Load Step 18 A to 8 A at 1 A/ μs	11
8	Input Voltage Ripple, $V_{IN} = 5\text{ V}$, $V_{OUT} = 1\text{ V}$, $I_{OUT} = 18\text{ A}$	12
9	EVM Modification to Measure Frequency Response.....	13
10	Frequency Response Test Setup	14
11	Frequency Response	15
12	High Side Current Limiting	16
13	High Side Current Limiting - Zoomed In.....	16
14	TPS7H4001EVM-CVAL EVM Schematic	17
15	Top Overlay	21
16	Top Solder	22
17	Top Layer	23
18	Signal Layer One.....	24
19	Signal Layer Two.....	25
20	Signal Layer Three.....	26
21	Signal Layer Four	27
22	Signal Layer Five.....	28
23	Signal Layer Six	29
24	Bottom Layer.....	30
25	Bottom Solder.....	31
26	Bottom Overlay	32

List of Tables

1	Default EVM Configuration	4
2	Summary of Connections	6
3	TPS7H4001EVM-CVAL BOM	18

Trademarks

All trademarks are the property of their respective owners.

1 TPS7H4001EVM-CVAL Overview

The TPS7H4001-SP is a radiation hardened, 7-V, 18-A synchronous step-down converter with integrated high-side and low-side MOSFETs. High efficiency and efficient usage of space are achieved through low resistance MOSFETs and a current mode control implementation.

The EVM is configured in a default state to accept a 5-V input but can be modified to disable or change the under voltage lock out (UVLO) protection, allowing for any input voltage from 3 V to 7 V. The EVM is also configured for a 1-V output at a maximum peak output current of 18 A. Again, the regulated output voltage can be modified by changing one resistor on the board. The TSP7H4001-SP has a dedicated soft start, enable, and adjustable slope compensation pins providing design flexibility to meet specific application requirements.

Finally, as shown in [Figure 1](#), this EVM is populated and configured to support a single POL channel. However, the EVM provides footprints for up to three slave devices, which could operate in parallel. With four POLs operating in quadrature phases, a 72-A load current could theoretically be provided. Please contact TI support for additional information on evaluating parallel operation of the TPS7H4001-SP.

1.1 Features

- 0.6-V \pm 1.5% voltage reference over temperature, radiation, and line and load regulation
- Adjustable slope compensation
- Adjustable soft start
- Adjustable input enable and undervoltage lockout (UVLO)
- Maximum output current of 18 A

1.2 Applications

- Point of load regulation
- Supports harsh environment applications
- Space satellite point of load supply for FPGAs, microcontrollers, data converters, and ASICs
- Space satellite payloads
- Radiation hardened applications

2 TPS7H4001EVM-CVAL Default Configuration

Table 1 describes the default configuration of the TPS7H4001EVM-CVAL listing the external components that define the converter design.

Table 1. Default EVM Configuration

PARAMETER	SPECIFICATIONS	DESCRIPTION
Input power supply	5 V	Bound by UVLO enable circuit (R5, R6)
Regulated output voltage	1 V	R19 (RTOP) = 10 k Ω , R26 (RBOTTOM) = 15.4 k Ω
L _{OUT}	0.9 μ H	Chosen to meet inductor ripple current of 10% (Kind = 0.1)
C _{OUT}	1980 μ F	Chosen for (1) ESR = 1 m Ω to set output voltage ripple; (2) value used during single event effects testing ensuring regulation maintained with single event upset to switching
Output current	0 to 18 A	By design
Switching frequency	500 kHz	Set by R9 (RT) = 174 k Ω
Soft start time constant	\approx 2 ms	Set by C13 (Css) = 10 nF
UVLO enable rising	\approx 4.432 V	Set by R5 = 10 k Ω and R6 = 3.4 k Ω
UVLO enable falling	\approx 4.284 V	Set by R5 = 10 k Ω and R6 = 3.4 k Ω
Loop bandwidth	\approx 30 kHz	Set by operational transconductance amplifier (OTA) compensation circuit: R7 (RCOMP) = 10 k Ω , C15 (CCOMP) = 10 nF, C14 (CHF) = 150 pF
Loop phase margin	\approx 60 $^\circ$	
Gain margin	\approx -25 dB	

3 TPS7H4001EVM-CVAL Initial Setup

This section provides the test instruments required and the connections to the EVM as shown in [Figure 2](#).

1. Input DC power supply
 - a. Set for 5-V DC, 8-A current limit
 - b. Connect positive output of DC supply to pin 1 of connector J2 (PVIN) and negative terminal of supply to pin 2 of connector J2 for ground using 16 AWG wire or larger. [Note: For more precise measurements, eliminating the IR voltage drop in the input cables is achieved by using a power supply source with sensing ports and connecting between TP4 to PVIN and TP18 to GND.]
2. DC electronic load
 - a. Connect positive DC input of e-load to pin 2 of connector J4 (VOUT) using 16 AWG wire [Note: Wire from pin 2, positive terminal of connector, to the e-load should include at least some part in which the wire gauge can be strapped by the oscilloscope current probe. This will eliminate the need for a setup change to cover all tests].
 - b. Connect negative DC input of e-load to pin 1 of connector J4 (VOUT) using 16 AWG wire.
 - c. Connect voltage monitoring sensing ports of e-load across test points TP15 (VOUT1) and TP20 (GND). A voltage meter can be used to monitor this voltage also.
3. Oscilloscope
 - a. CH1 - Connect voltage scope probe to scope probe test point J6 (PH1) to monitor the phase node. DC coupled, Full BW, 2 V/div, Rising Edge Trigger at 0.5 V.
 - b. CH2 - Connect voltage scope probe to scope probe test point J8 (VOUT1) to monitor the output voltage. AC coupled, BW = 20 MHz, 10 mV/div.
 - c. CH3 - Connect current scope probe to monitor current through wire connecting J4 (VOUT) and e-load. 5 A/div [Note: only required for transient load testing].

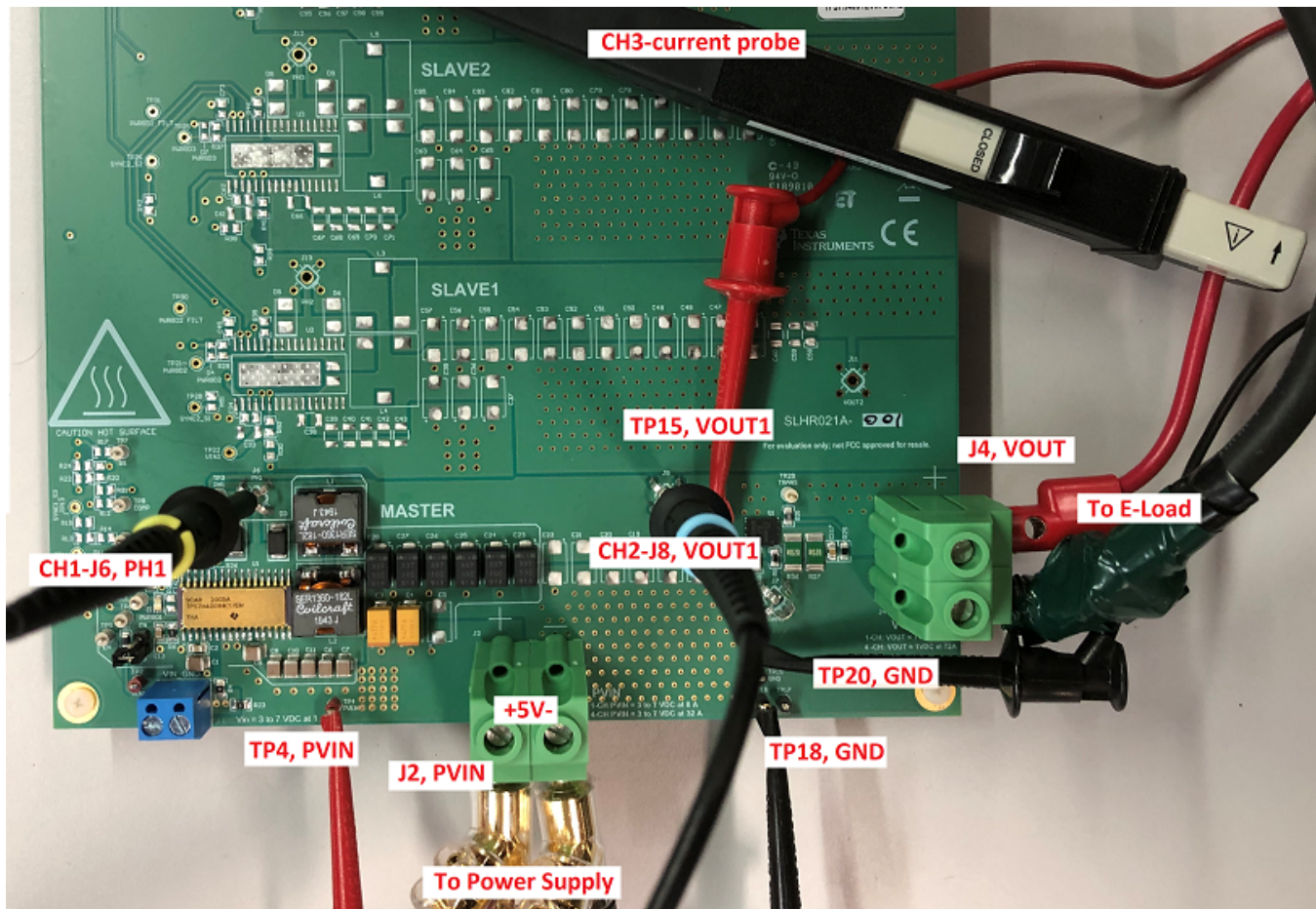

Figure 2. TPS7H4001EVM-CVAL Setup

Table 2. Summary of Connections

REFERENCE DESIGNATOR	SILKSCREEN	FUNCTION
J2	PVIN	Input power: pin 1 = 5 V, pin 2 = GND (Vsupply)
J4	VOUT	Output voltage: pin 1 = GND, pin 2 = Vout ≈1 V (e-load)
J6	PH1	Phase switching node scope probe test point (Scope CH-1)
J8	VOUT1	VOUT1 scope probe test point (Scope CH-2)
TP15	VOUT1	VOUT1 test point (e-load monitor)
TP4	PVIN	PVIN test point (Vsupply_sense)
TP18, TP20	GND	GND test points (Vsupply_sense, e-load monitor)

4 TPS7H4001EVM-CVAL Testing

The following tests will be described in subsequent sections.

1. Output voltage regulation
2. Output voltage ripple
3. Soft startup
4. Transient response to positive/negative load step (9 A to 18 A to 9 A)
5. Input voltage ripple
6. Loop frequency response
7. Current limiting

4.1 Output Voltage Regulation

- Turn-on input DC source (5 V)
- Turn on the e-load and sweep load current from 0 A to 18 A. The monitored output voltage at TP15 (VOUT1) is at or near 1.0 V across the entire current load sweep as shown in [Figure 3](#).

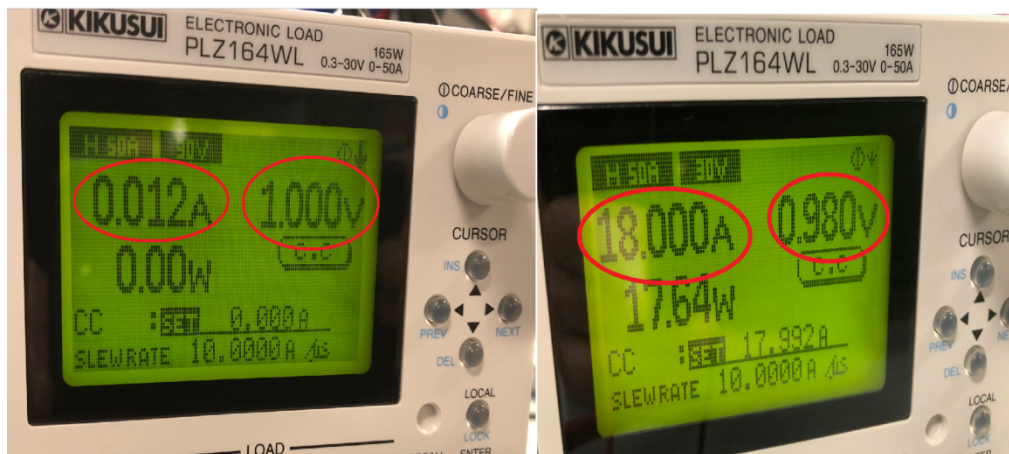

Figure 3. Output Voltage Regulation

4.2 Output Voltage Ripple

Display CH1 (PH1) and CH2 (VOUT1) [AC coupled, BW = 20 MHz] on oscilloscope to monitor the switching phase node and the output voltage ripple as shown in [Figure 4](#).

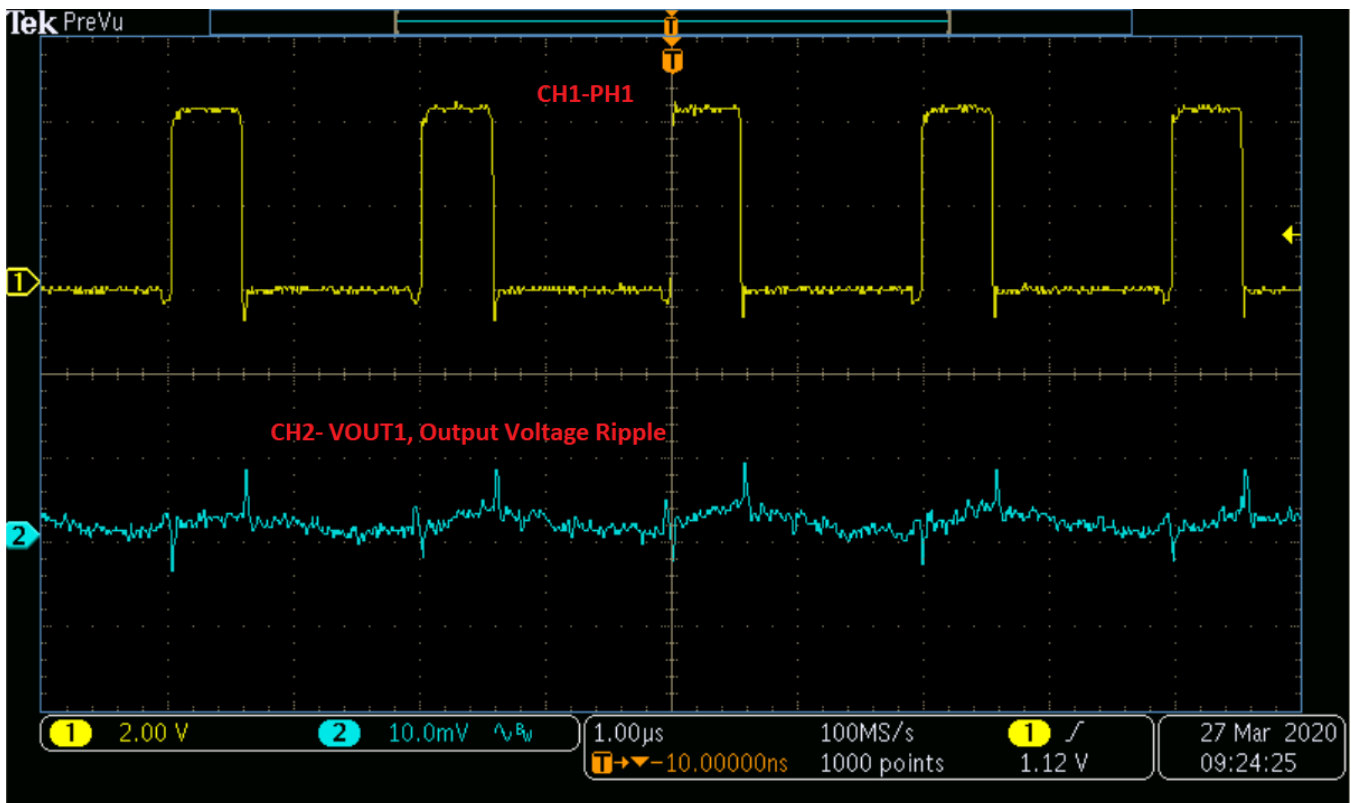

Figure 4. Output Voltage Ripple VIN = 5 V, VOUT = 1 V, IOU = 18 A

4.3 Soft Startup

Display CH1 (PH1) and CH2 (VOUT1) [DC coupled, 500 mV/div] on oscilloscope to monitor the switching phase and the soft start profile of the output voltage as shown in [Figure 5](#).

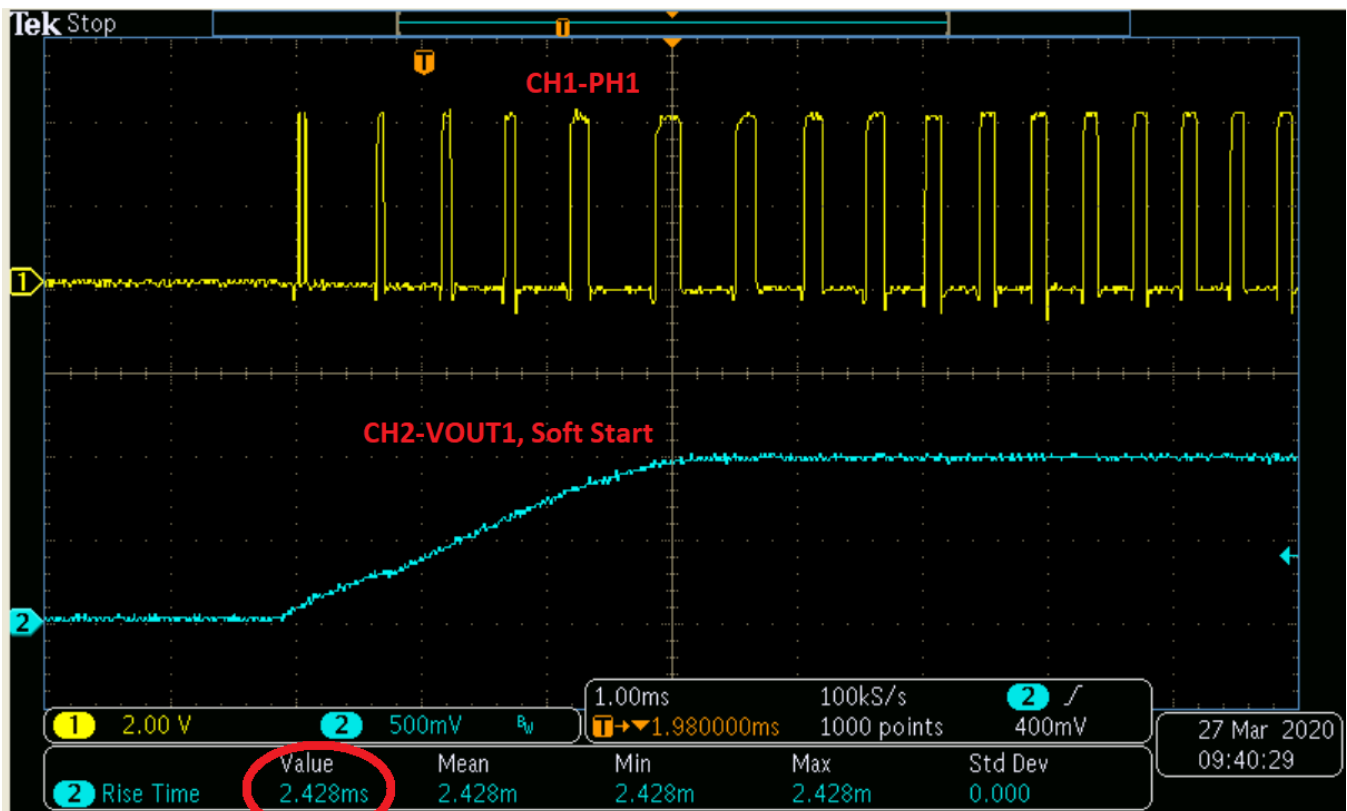

Figure 5. Output Soft Start Voltage, VIN = 5 V, VOUT = 1 V, IOUT = 18 A

4.4 Transient Response to Positive/Negative Load Step (9 A to 18 A to 9 A)

- Configure e-load to switch between 9 A and 18 A at a rate of 1 A/μs.
- On oscilloscope, display CH2 (VOUT1) [AC coupled, 20 mV/div] and CH3 (Output Current Probe) [5 A/div, trigger rising edge ≈12 A] with 40 μs/div.

Figure 6 shows the response to this load step to be less than 25 mV.

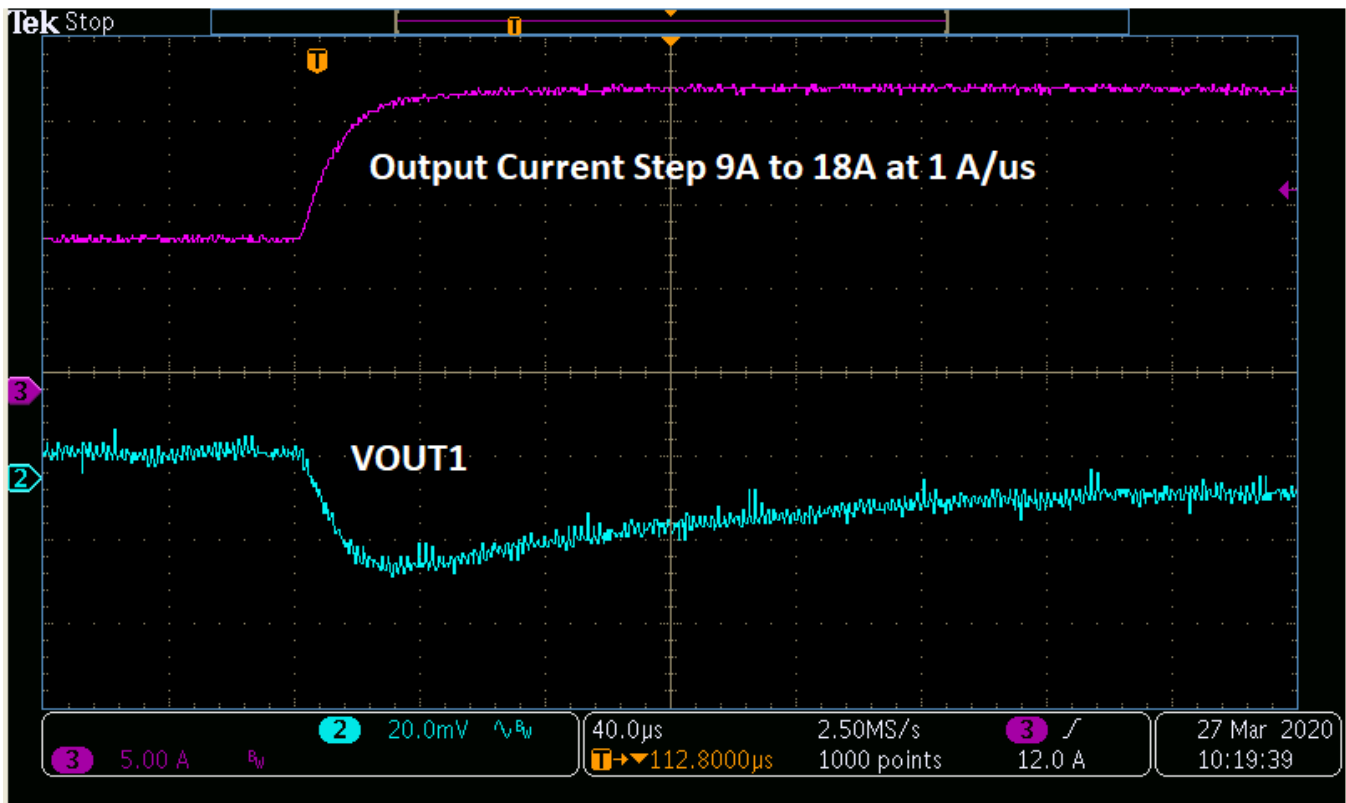

Figure 6. Transient Response to Load Step 9 A to 18 A at 1 A/µs

- Change the trigger on CH3 to falling edge to capture the transient response of VOUT to negative current step from 18 A to 9 A as shown in [Figure 7](#).

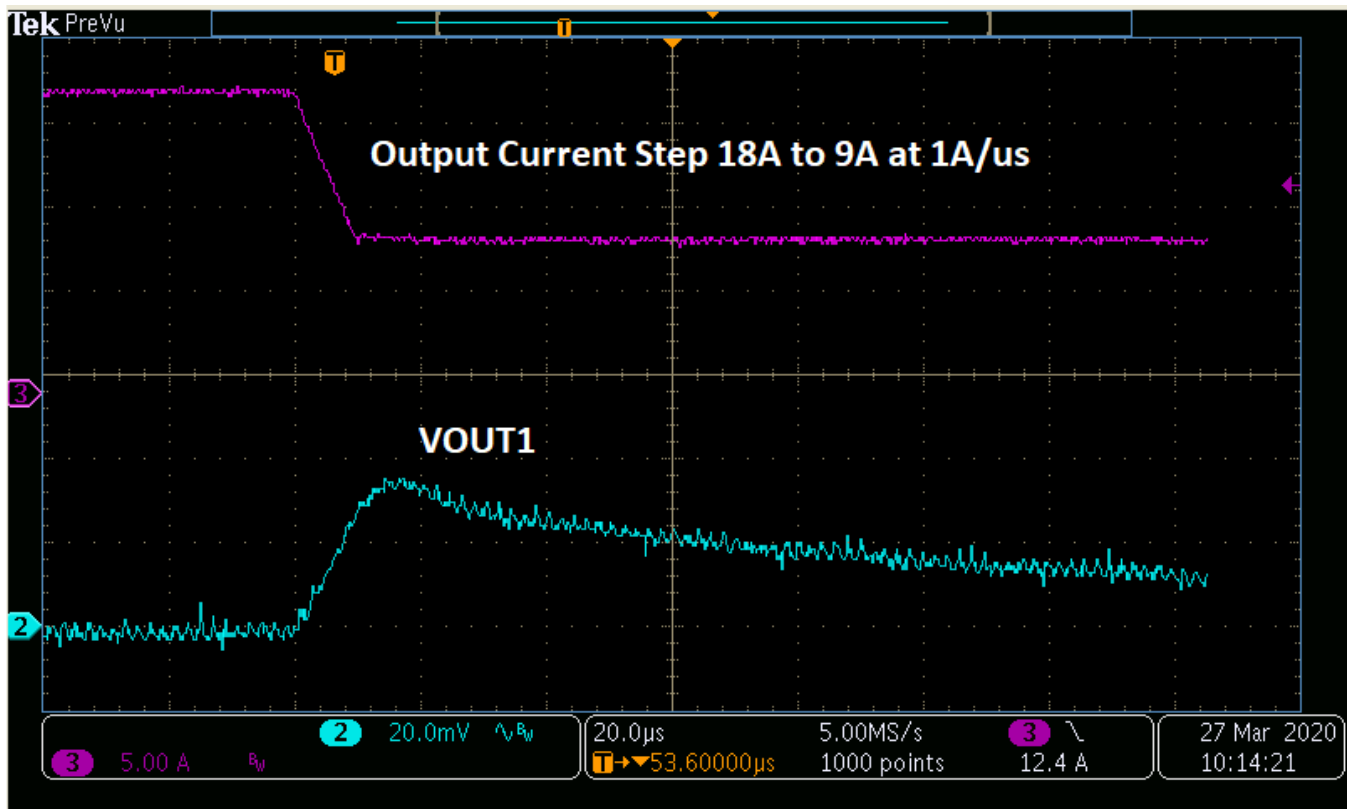

Figure 7. Transient Response to Load Step 18 A to 8 A at 1 A/ μ s

4.5 Input Voltage Ripple

- Trigger CH1 of oscilloscope on Phase Node and put CH2 scope probe between test point TP4 (PVIN) and TP18 (GND).

As shown in [Figure 8](#), the voltage ripple (ignoring the switching coupling to the input) is approximately 76 mV.

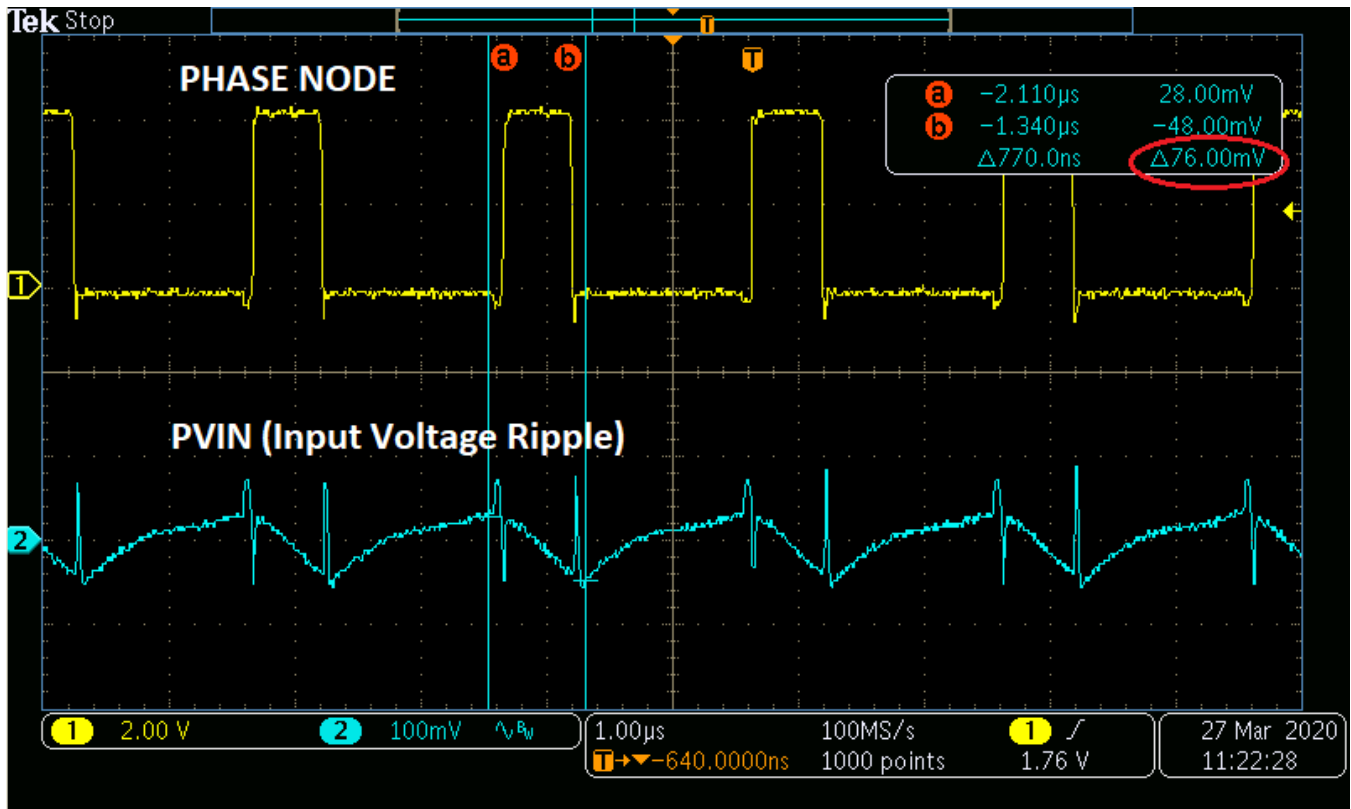

Figure 8. Input Voltage Ripple, VIN = 5 V, VOUT = 1 V, IOUT = 18 A

4.6 Loop Frequency Response

Measuring the frequency response of the feedback loop requires a unique test setup as well as physical changes to the EVM. 0-Ω resistor jumper R18, to right TP16 (BODE) test point and circled in yellow in the graphic below, must be lifted in order to break the loop. Both test points TP16 (BODE) and TP15 (VOUT1) will be used for connections to the Bode100 instruments.

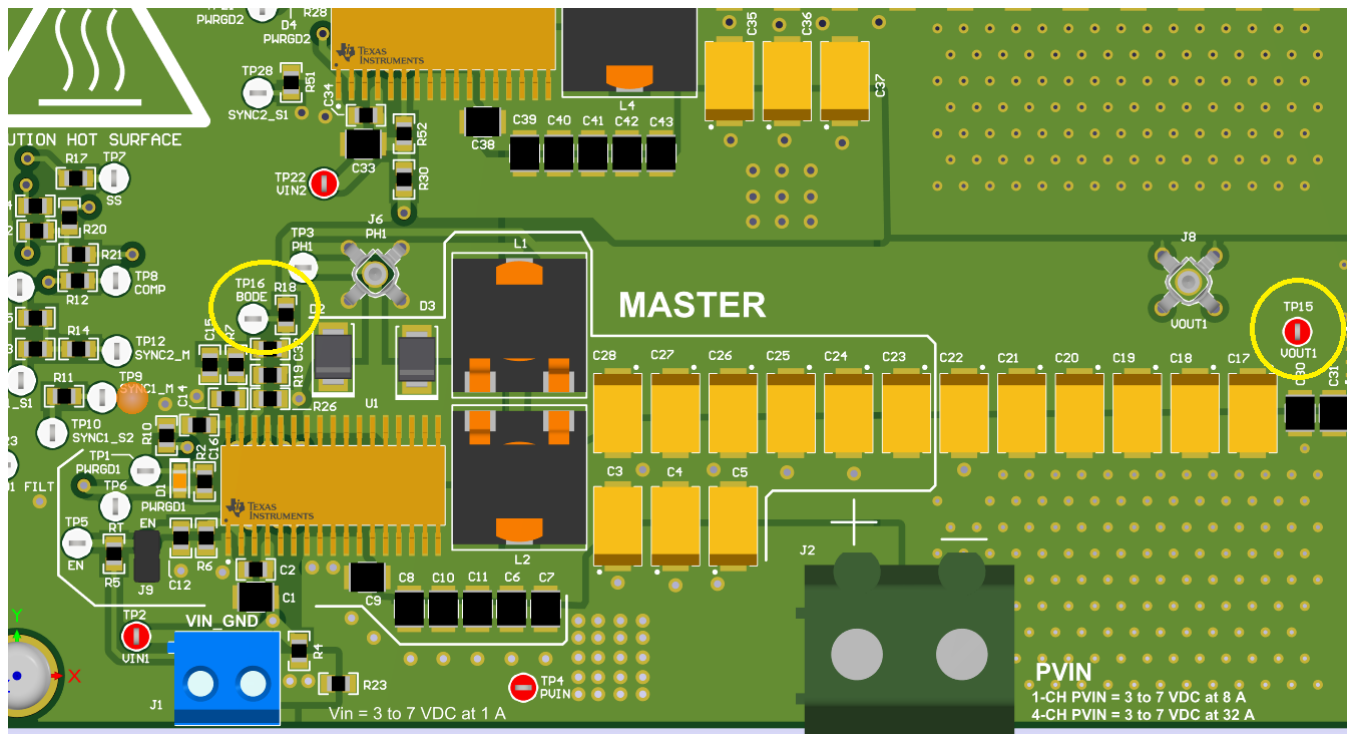

Figure 9. EVM Modification to Measure Frequency Response

The test setup which includes several connections to Picotest Bode100 test instruments is shown in Figure 10 with measurement results shown in Figure 11. The CHF, high frequency pole, component of the compensation circuit is optional. Omitting it will result in slightly increased phase margin. However, the benefit of including it is that the gain curve is set in a downward trajectory as frequency increases, making a monotonic gain curve more likely to be achieved.

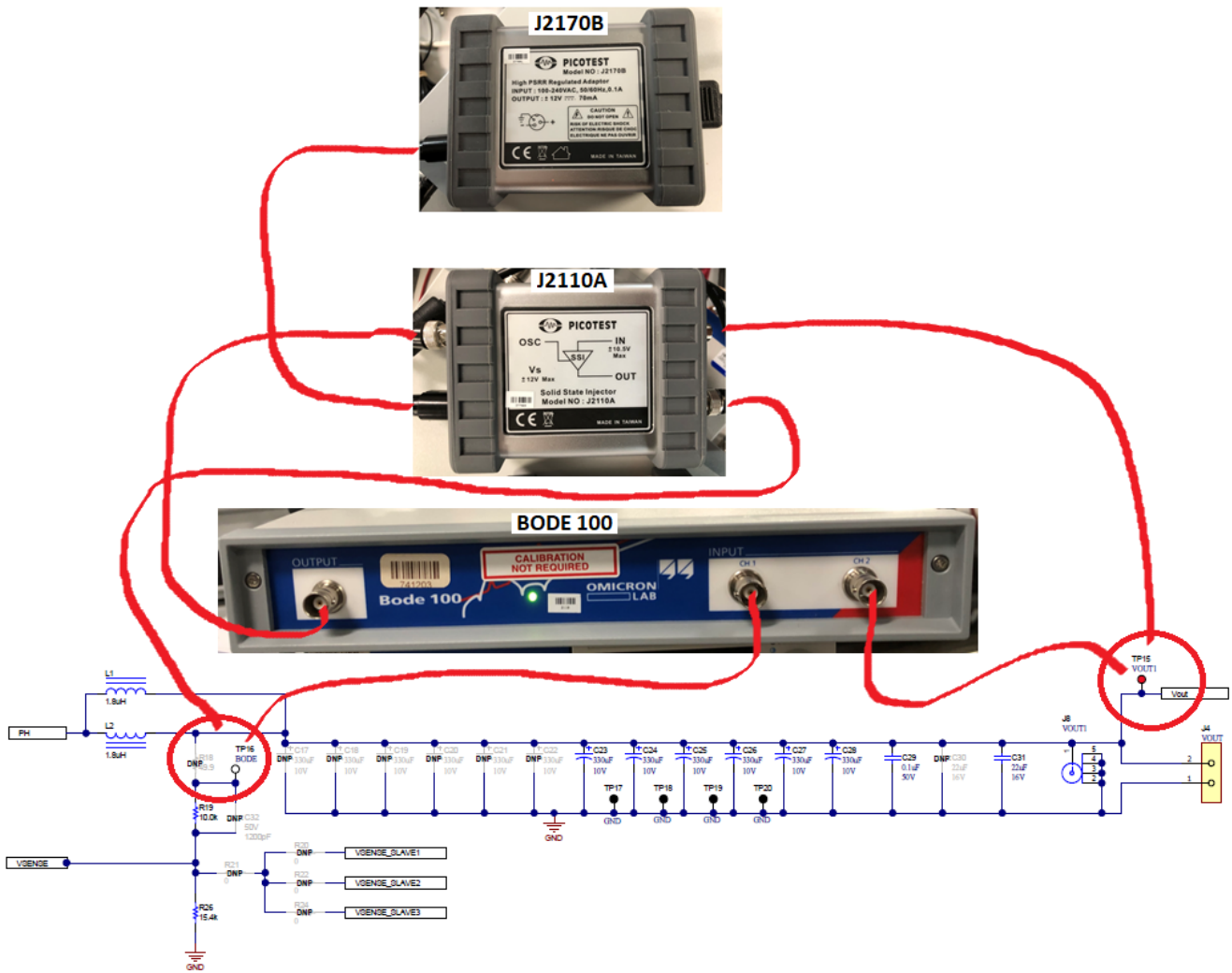

Figure 10. Frequency Response Test Setup

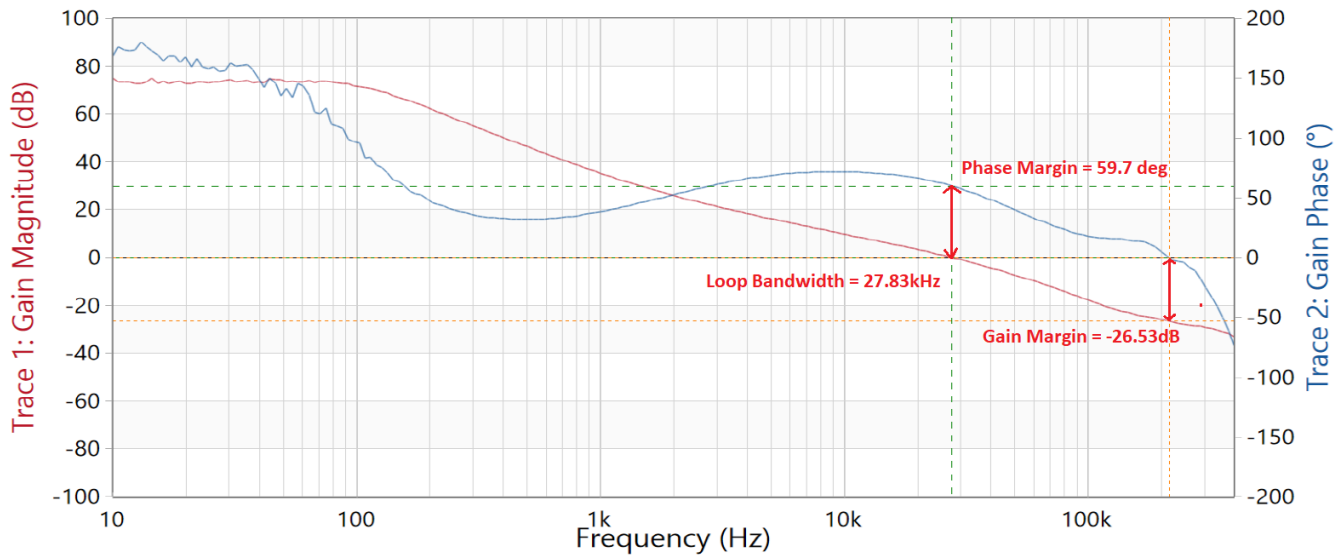

Figure 11. Frequency Response

4.7 Current Limiting

Finally, it is worth mentioning the behavior of the device with regards to current limiting. Although, the recommended operating condition (ROC) of the device is to never exceed 18-A peak current, the design is robust enough to handle output currents up to the limiting mechanism of the device, which is typically 25 A, without damage to the DUT. This does not mean that external components cannot be damaged so it is imperative that the ratings of these components be in line with intended and, potential, unintended operational conditions.

Figure 12 shows what happens when the high side current limit threshold is exceeded. The soft start pin is pulled low which causes the switching phase node to stop switching. This, in turn, causes the output voltage to drop causing VSENSE (not shown) to drop. Only after the soft start pin re-establishes a voltage level equal to the VSENSE pin (VOUT) does the device start switching again as shown in zoomed out version of Figure 13.

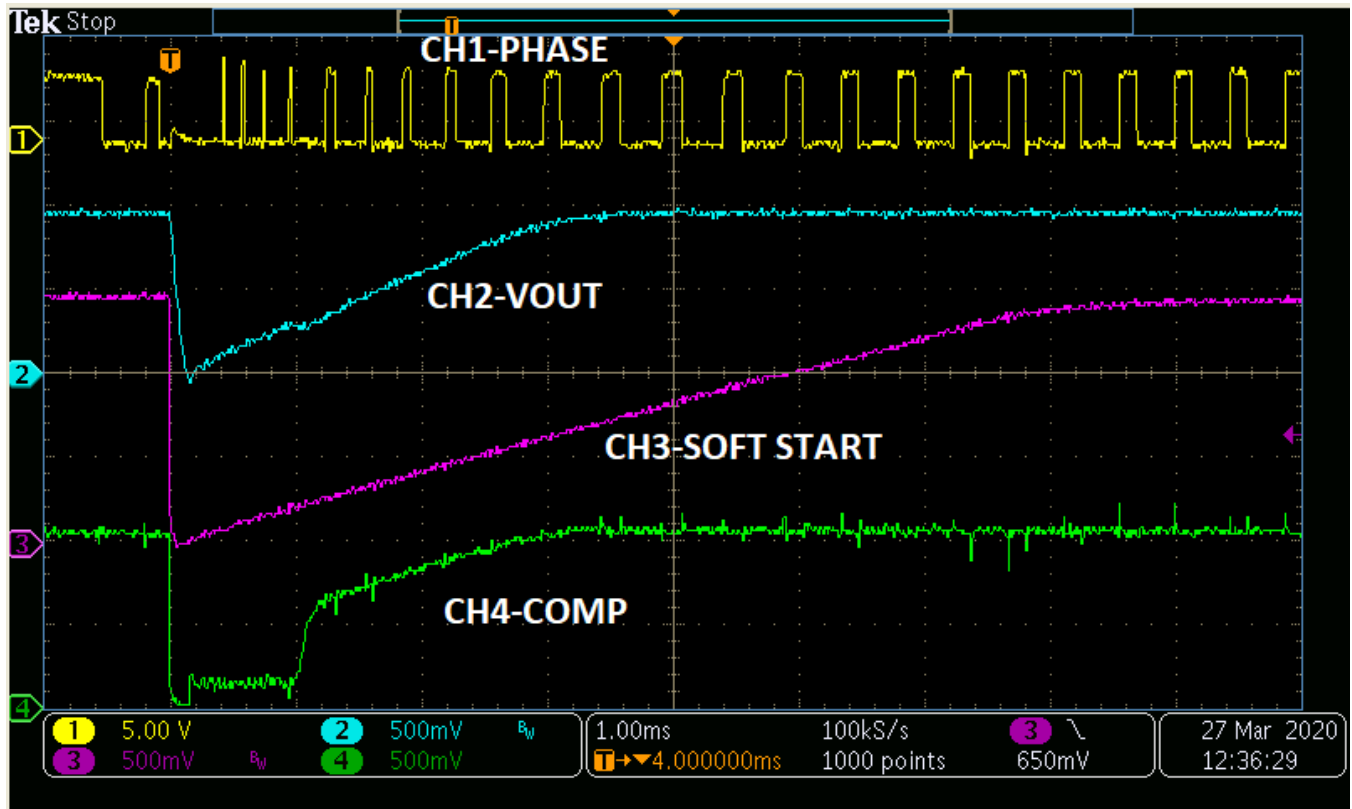

Figure 12. High Side Current Limiting

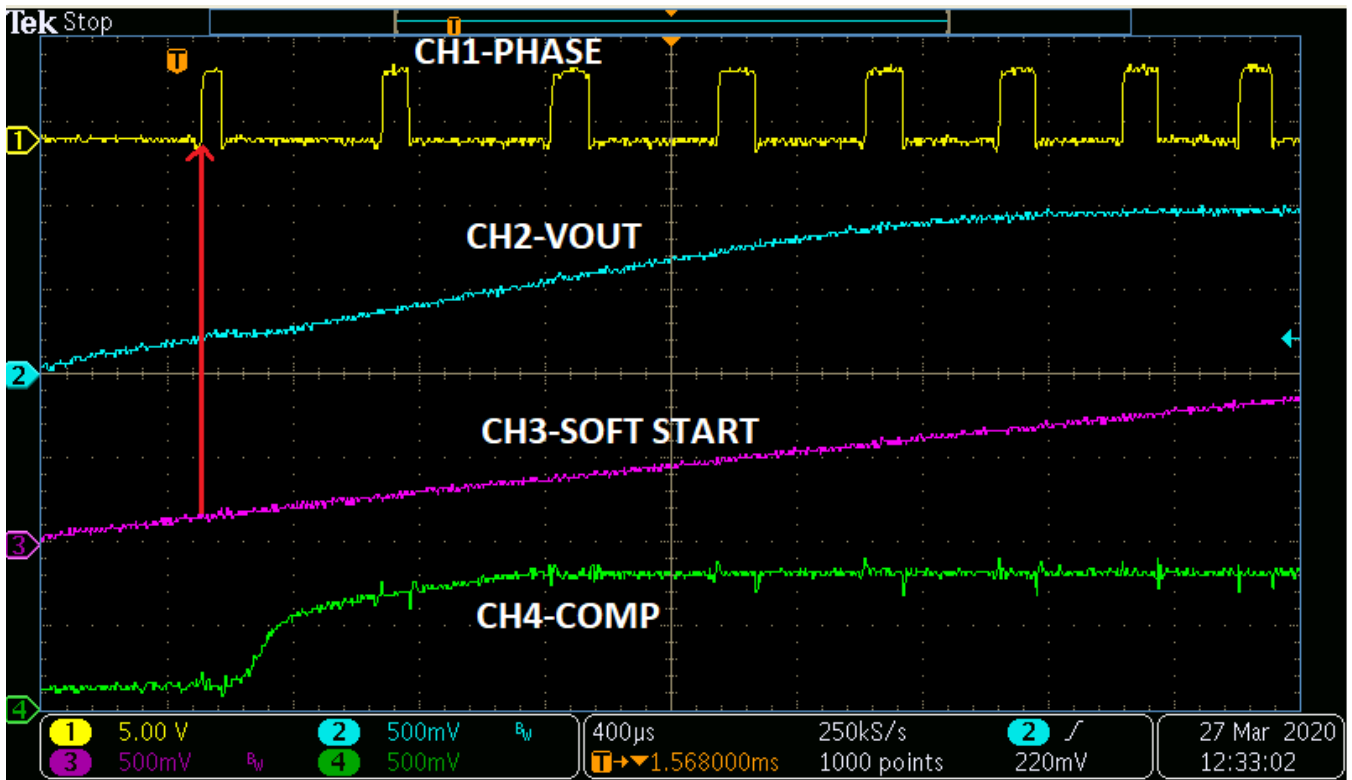

Figure 13. High Side Current Limiting - Zoomed In

5 TPS7H4001EVM-CVAL EVM Schematic

MASTER (POL1) at U1

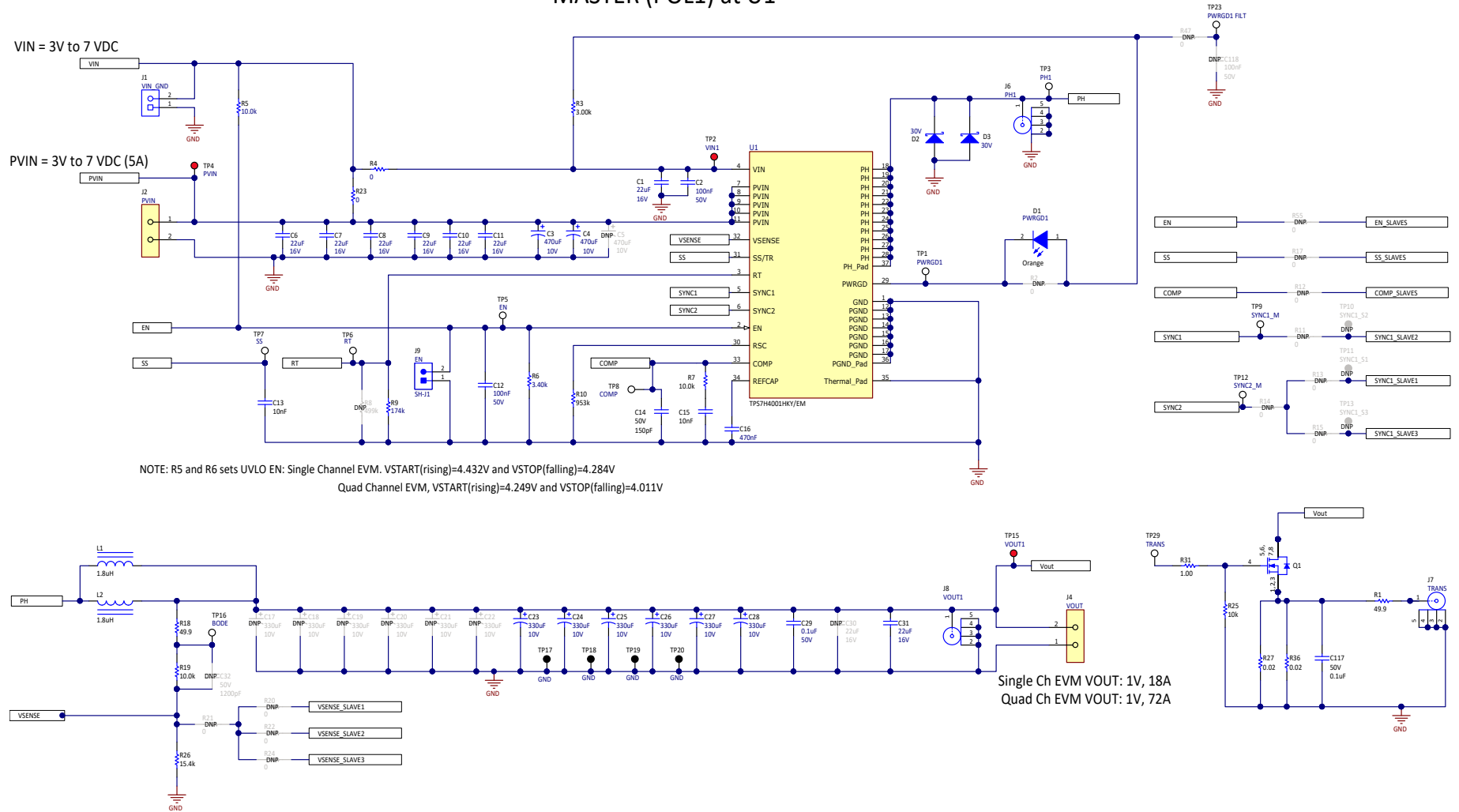

Figure 14. TPS7H4001EVM-CVAL EVM Schematic

6 TPS7H4001EVM-CVAL Bill of Materials (BOM)
Table 3. TPS7H4001EVM-CVAL BOM

Designator	Quantity	Value	Description	Package Reference	Part Number	Manufacturer
IPCB1	1		Printed Circuit Board		SLHR021	Any
C1, C6, C7, C8, C9, C10, C11, C31	8	22uF	CAP, CERM, 22 uF, 16 V, +/- 10%, X7R, 1210	1210	C3225X7R1C226K250AC	TDK
C2, C12	2	0.1uF	CAP, CERM, 0.1 uF, 50 V, +/- 5%, X7R, 0805	0805	08055C104JAT2A	AVX
C3, C4	2	470uF	CAP, TA, 470 uF, 10 V, +/- 10%, 0.023 ohm, SMD	7343-43	TPME477K010R0023	AVX
C13	1	0.01uF	CAP, CERM, 0.01 uF, 50 V, +/- 10%, X7R, 0805	0805	C0805C103K5RACTU	Kemet
C14	1	150pF	CAP, CERM, 150 pF, 50 V, +/- 5%, C0G/NP0, 0805	0805	08055A151JAT2A	AVX
C15	1	0.01uF	CAP, CERM, 0.01 uF, 50 V, +/- 20%, X7R, 0805	0805	C0805C103M5RACTU	Kemet
C16	1	0.47uF	CAP, CERM, 0.47 uF, 50 V, +/- 10%, X7R, 0805	0805	C2012X7R1H474K125AB	TDK
C23, C24, C25, C26, C27, C28	6	330uF	CAP, Tantalum Polymer, 330 uF, 10 V, +/- 20%, 0.006 ohm, 7343-43 SMD	7343-43	T530X337M010ATE006	Kemet
C29	1	0.1uF	CAP, CERM, 0.1 uF, 50 V, +/- 5%, X7R, 1206	1206	C1206C104J5RACTU	Kemet
C117	1	0.1uF	CAP, CERM, 0.1 uF, 50 V, +/- 10%, X7R, 0805	0805	C0805C104K5RACTU	Kemet
D1	1	Orange	LED, Orange, SMD	LED_0805	LTST-C170KFKT	Lite-On
D2, D3	2	30V	Diode, Schottky, 30 V, 2 A, SMB	SMB	B230-13-F	Diodes Inc.
H1, H2, H3, H4	4		Machine Screw, Round, #4-40 x 1/4, Nylon, Philips panhead	Screw	NY PMS 440 0025 PH	B & F Fastener Supply
H5, H6, H7, H8	4		Standoff, Hex, 0.5"L #4-40 Nylon	Standoff	1902C	Keystone
J1	1		Terminal Block, 5.08 mm, 2x1, Brass, TH	2x1 5.08 mm Terminal Block	ED120/2DS	On-Shore Technology
J2, J4	2		Fixed Terminal Blocks MKDSP 10 HV/ 2-10	HDR2	1929517	Phoenix Contact
J6, J7, J8	3		Compact Probe Tip Circuit Board Test Points, TH, 25 per	TH Scope Probe	131-5031-00	Tektronix
J9	1		Header, 2.54 mm, 2x1, Gold, TH	Header, 2.54mm, 2x1, TH	61300211121	Wurth Elektronik
L1, L2	2	1.8uH	Inductor, Shielded E Core, Ferrite, 1.8 uH, 13 A, 0.0026 ohm, AEC-Q200 Grade 3, SMD	SER1360	SER1360-182KLB	Coilcraft
LBL1	1		Thermal Transfer Printable Labels, 0.650" W x 0.200" H - 10,000 per roll	PCB Label 0.650 x 0.200 inch	THT-14-423-10	Brady
Q1	1	25V	MOSFET, N-CH, 25 V, 113 A, DQH0008A (VSON-CLIP-8)	DQH0008A	CSD16408Q5	Texas Instruments
R1, R18	2	49.9	RES, 49.9, 0.1%, 0.125 W, 0805	0805	RT0805BRD0749R9L	Yageo America
R3	1	3.00k	RES, 3.00 k, 1%, 0.125 W, AEC-Q200 Grade 0, 0805	0805	ERJ-6ENF3001V	Panasonic

Table 3. TPS7H4001EVM-CVAL BOM (continued)

Designator	Quantity	Value	Description	Package Reference	Part Number	Manufacturer
R4, R23	2	0	RES, 0, 5%, 0.125 W, AEC-Q200 Grade 0, 0805	0805	CRCW08050000Z0EA	Vishay-Dale
R5, R19	2	10.0k	RES, 10.0 k, 1%, 0.125 W, AEC-Q200 Grade 0, 0805	0805	CRCW080510K0FKEA	Vishay-Dale
R6	1	3.40k	RES, 3.40 k, 1%, 0.125 W, AEC-Q200 Grade 0, 0805	0805	CRCW08053K40FKEA	Vishay-Dale
R7	1	10.0k	RES, 10.0 k, 1%, 0.2 W, 0805	0805	MCU08050C1002FP500	Vishay/Beyschlag
R9	1	174k	RES, 174 k, 1%, 0.125 W, AEC-Q200 Grade 0, 0805	0805	ERJ-6ENF1743V	Panasonic
R10	1	953k	RES, 953 k, 1%, 0.125 W, AEC-Q200 Grade 0, 0805	0805	CRCW0805953KFKEA	Vishay-Dale
R25	1	10k	RES, 10 k, 5%, 0.125 W, AEC-Q200 Grade 0, 0805	0805	CRCW080510K0JNEA	Vishay-Dale
R26	1	15.4k	RES, 15.4 k, 0.1%, 0.125 W, 0805	0805	RG2012P-1542-B-T5	Susumu Co Ltd
R27, R36	2	0.02	RES, 0.02, 1%, 1 W, AEC-Q200 Grade 0, 2512	2512	LRMAM2512-R02FT4	TT Electronics/IRC
R31	1	1.00	RES, 1.00, 1%, 0.125 W, 0805	0805	RC0805FR-071RL	Yageo America
SH-J1	1	1x2	Shunt, 100mil, Flash Gold, Black	Closed Top 100mil Shunt	SPC02SYAN	Sullins Connector Solutions
TP1, TP3, TP5, TP6, TP7, TP8, TP9, TP12, TP16, TP23, TP29	11		Test Point, Miniature, White, TH	White Miniature Testpoint	5002	Keystone
TP2, TP4, TP15	3		Test Point, Miniature, Red, TH	Red Miniature Testpoint	5000	Keystone
TP17, TP18, TP19, TP20	4		Test Point, Miniature, Black, TH	Black Miniature Testpoint	5001	Keystone
U1	1		Radiation Hardened 3-V to 7-V Input, 18-A Synchronous Buck Converter	CDFP34		Texas Instruments
C5, C35, C36, C37, C63, C64, C65, C91, C92, C93	0	470uF	CAP, TA, 470 uF, 10 V, +/- 10%, 0.023 ohm, SMD	7343-43	TPME477K010R0023	AVX
C17, C18, C19, C20, C21, C22, C46, C47, C48, C49, C50, C51, C52, C53, C54, C55, C56, C57, C74, C75, C76, C77, C78, C79, C80, C81, C82, C83, C84, C85, C102, C103, C104, C105, C106, C107, C108, C109, C110, C111, C112, C113	0	330uF	CAP, Tantalum Polymer, 330 uF, 10 V, +/- 20%, 0.006 ohm, 7343-43 SMD	7343-43	T530X337M010ATE006	Kemet
C30, C33, C38, C39, C40, C41, C42, C43, C59, C60, C61, C66, C67, C68, C69, C70, C71, C87, C88, C89, C94, C95, C96, C97, C98, C99, C115, C116	0	22uF	CAP, CERM, 22 uF, 16 V, +/- 10%, X7R, 1210	1210	C3225X7R1C226K250AC	TDK
C32	0	1200pF	CAP, CERM, 1200 pF, 50 V, +/- 10%, X7R, 0805	0805	08055C122KAT2A	AVX
C34, C44, C62, C72, C90, C100, C118	0	0.1uF	CAP, CERM, 0.1 uF, 50 V, +/- 5%, X7R, 0805	0805	08055C104JAT2A	AVX
C45, C73, C101	0	0.47uF	CAP, CERM, 0.47 uF, 50 V, +/- 10%, X7R, 0805	0805	C2012X7R1H474K125AB	TDK
C58, C86, C114	0	0.1uF	CAP, CERM, 0.1 uF, 50 V, +/- 5%, X7R, 1206	1206	C1206C104J5RACTU	Kemet
D4, D7, D10	0	Orange	LED, Orange, SMD	LED_0805	LTST-C170KFKT	Lite-On

Table 3. TPS7H4001EVM-CVAL BOM (continued)

Designator	Quantity	Value	Description	Package Reference	Part Number	Manufacturer
D5, D6, D8, D9, D11, D12	0	30V	Diode, Schottky, 30 V, 2 A, SMB	SMB	B230-13-F	Diodes Inc.
FID1, FID2, FID3, FID4, FID5, FID6	0		Fiducial mark. There is nothing to buy or mount.	N/A	N/A	N/A
J3, J5, J10, J11, J12, J13	0		Compact Probe Tip Circuit Board Test Points, TH, 25 per	TH Scope Probe	131-5031-00	Tektronix
L3, L4, L5, L6, L7, L8	0	1.8uH	Inductor, Shielded E Core, Ferrite, 1.8 μ H, 13 A, 0.0026 ohm, AEC-Q200 Grade 3, SMD	SER1360	SER1360-182KLB	Coilcraft
R2, R11, R12, R13, R14, R15, R17, R20, R21, R22, R24, R28, R30, R32, R37, R39, R40, R41, R42, R43, R47, R48, R50, R51, R52, R53, R54, R55	0	0	RES, 0, 5%, 0.125 W, AEC-Q200 Grade 0, 0805	0805	CRCW08050000Z0EA	Vishay-Dale
R8, R33, R44, R56	0	499k	RES, 499 k, 0.1%, 0.125 W, 0805	0805	RG2012P-4993-B-T5	Susumu Co Ltd
R16, R35, R46	0	953k	RES, 953 k, 1%, 0.125 W, AEC-Q200 Grade 0, 0805	0805	CRCW0805953KFKEA	Vishay-Dale
R29, R38, R49	0	3.00k	RES, 3.00 k, 1%, 0.125 W, AEC-Q200 Grade 0, 0805	0805	ERJ-6ENF3001V	Panasonic
R34, R45, R57	0	174k	RES, 174 k, 1%, 0.125 W, AEC-Q200 Grade 0, 0805	0805	ERJ-6ENF1743V	Panasonic
TP10, TP11, TP13, TP14, TP21, TP24, TP25, TP26, TP27, TP28, TP30, TP31	0		Test Point, Miniature, White, TH	White Miniature Testpoint	5002	Keystone
TP22	0		Test Point, Miniature, Red, TH	Red Miniature Testpoint	5000	Keystone
U2, U3, U4	0		Radiation Hardened 3-V to 7-V Input, 18-A Synchronous Buck Converter	CDFP34		Texas Instruments

7 Board Layout

The following is the layer stack of the TPS7H4001EVM-CVAL board.

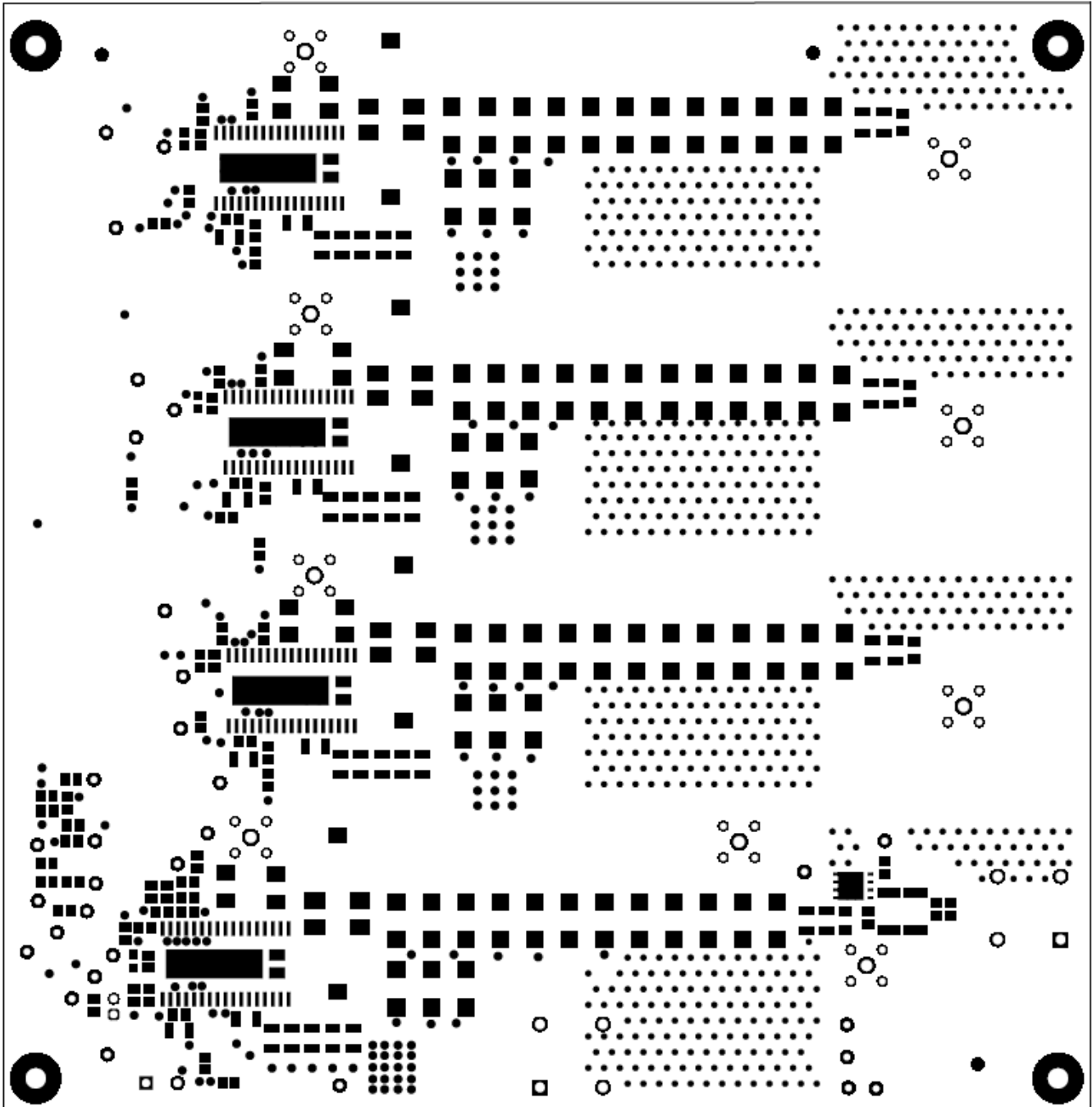

Figure 15. Top Overlay

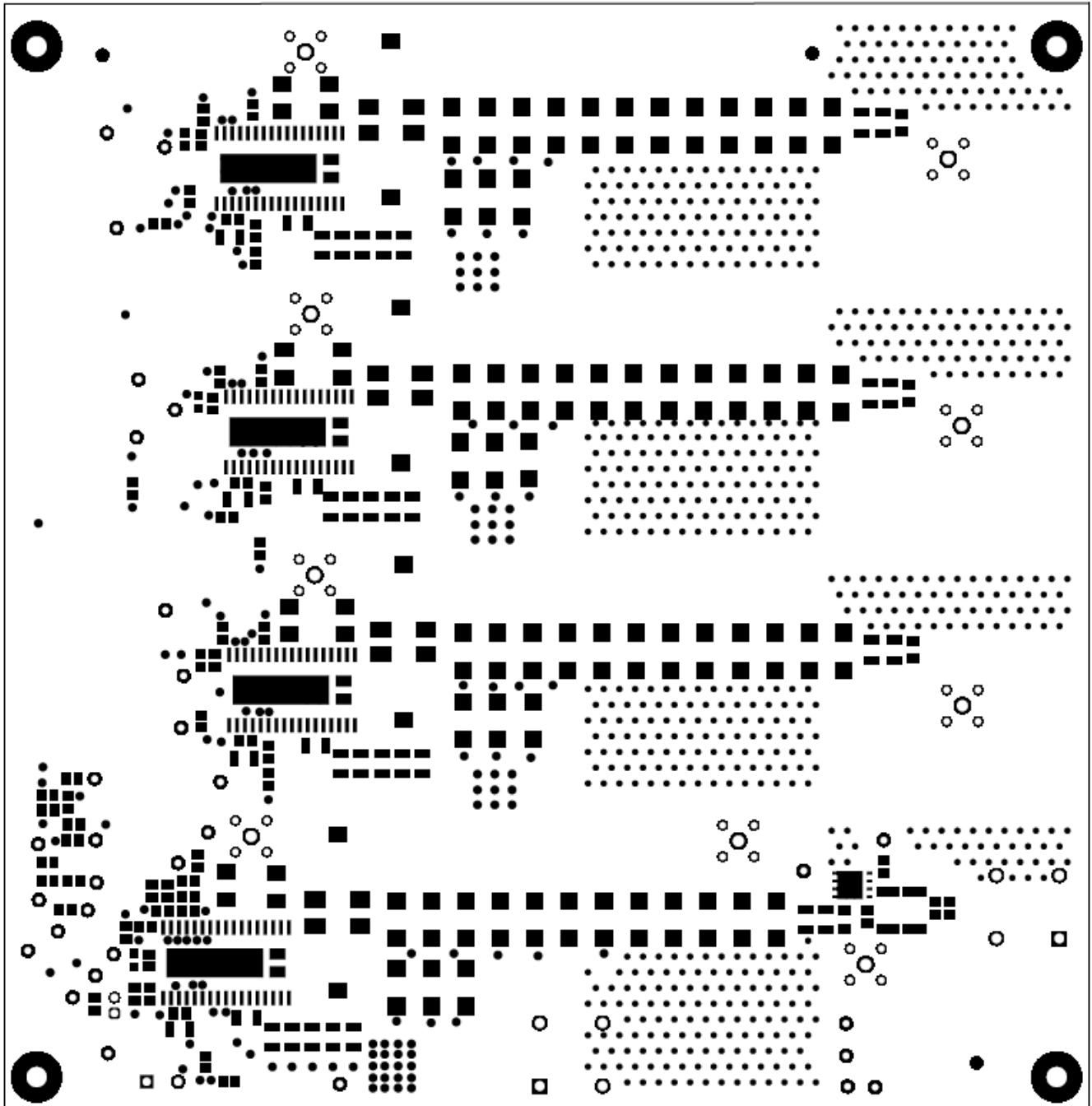

Figure 16. Top Solder

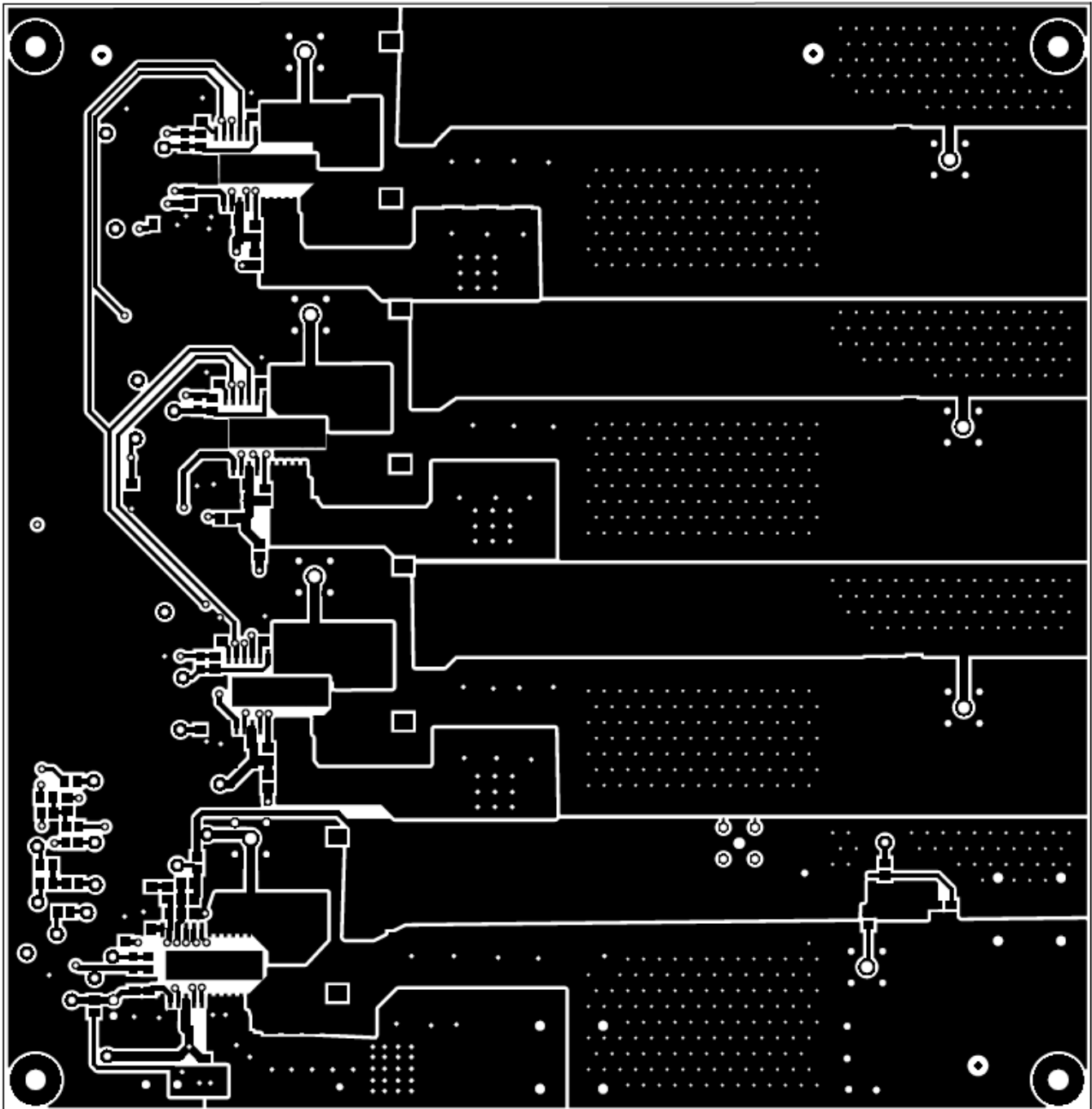

Figure 17. Top Layer

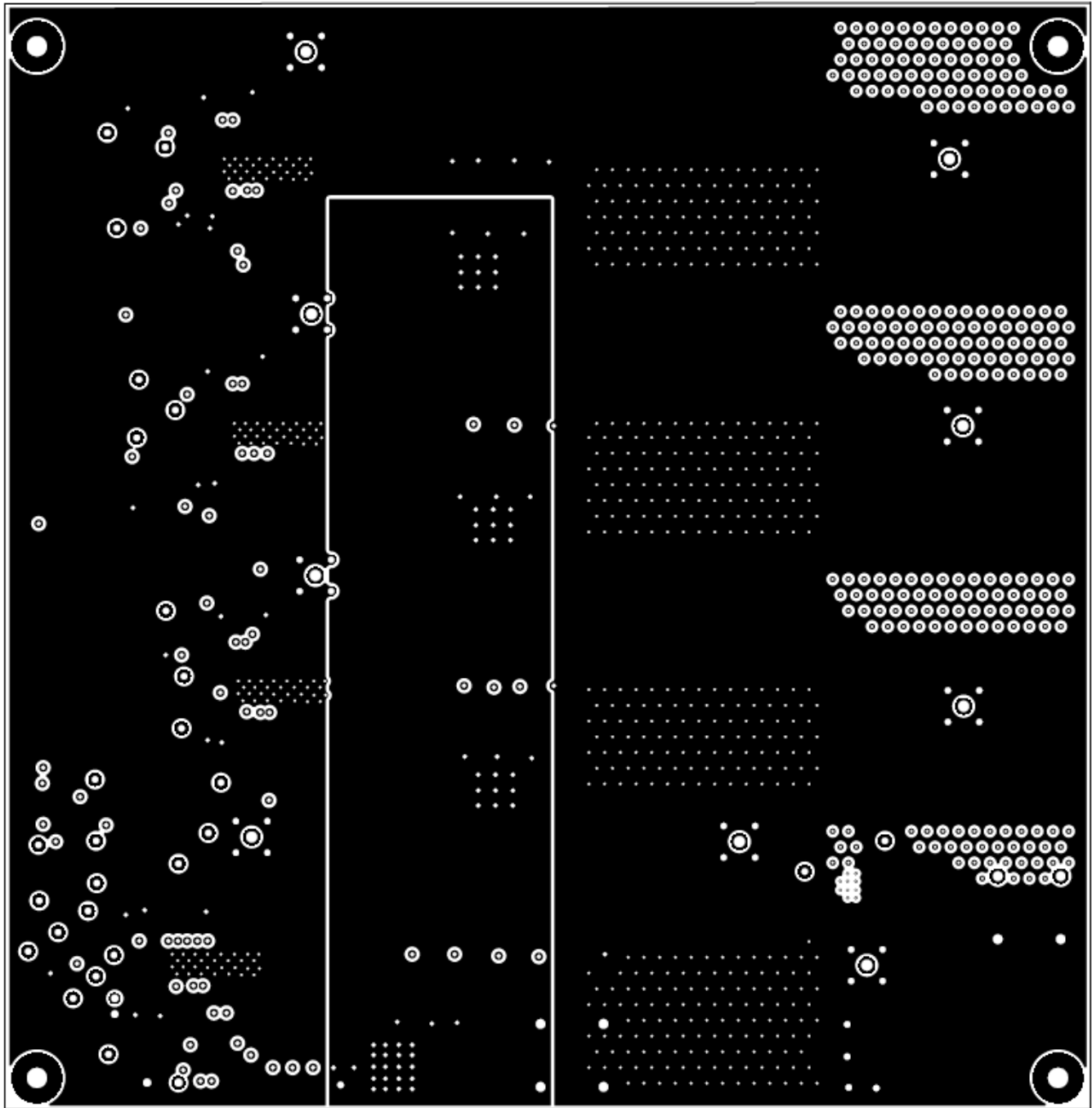

Figure 18. Signal Layer One

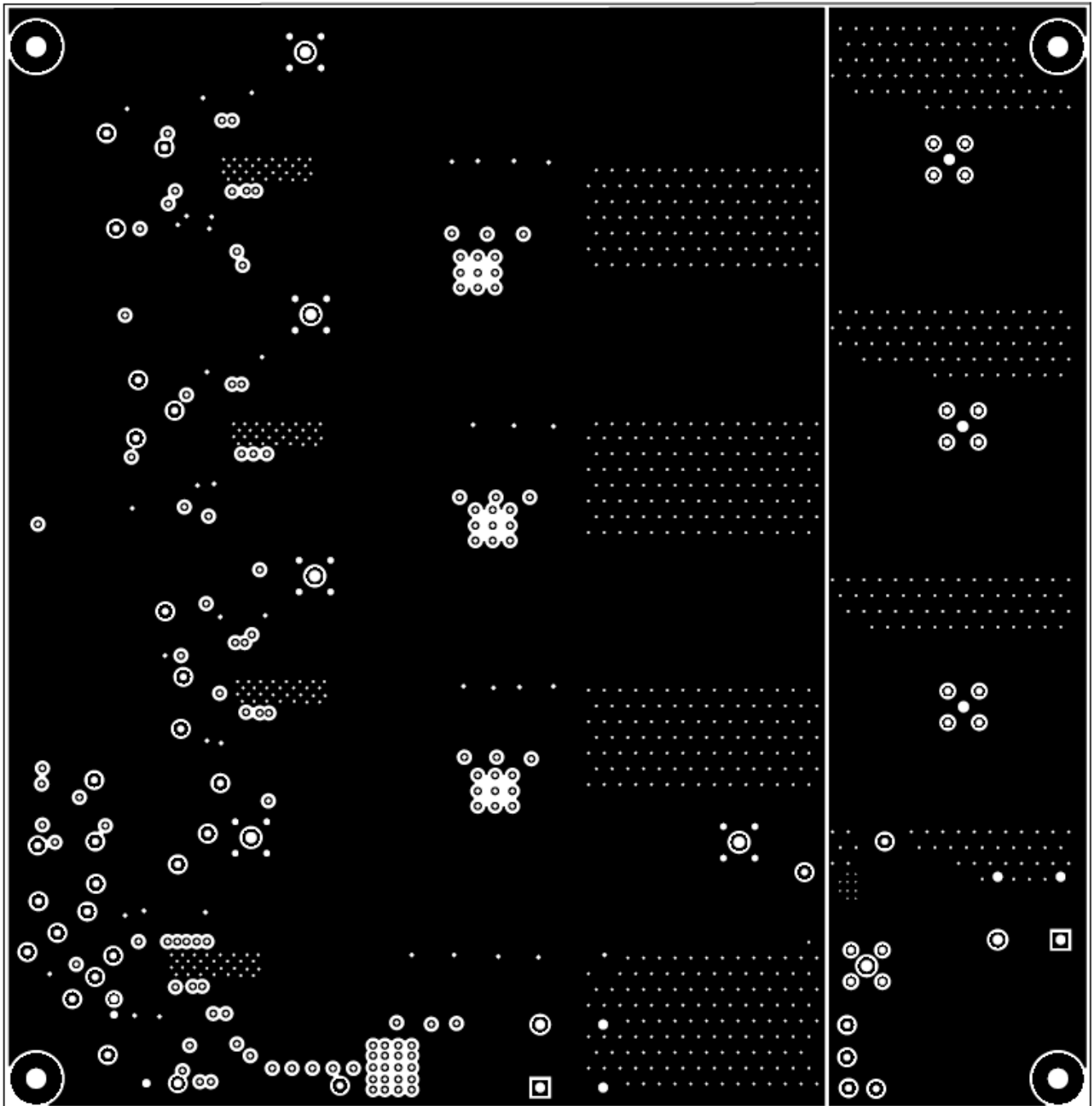

Figure 19. Signal Layer Two

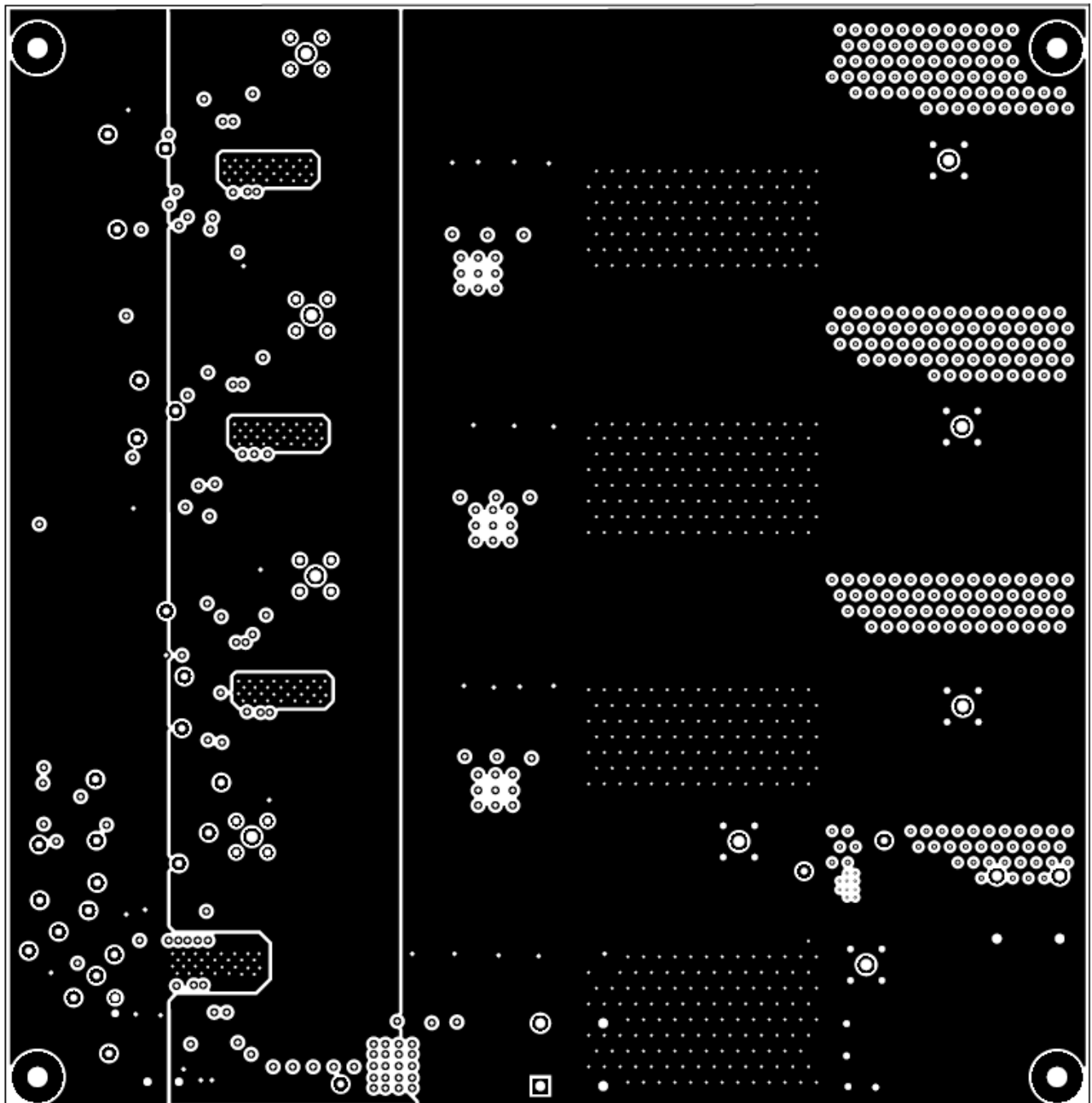

Figure 20. Signal Layer Three

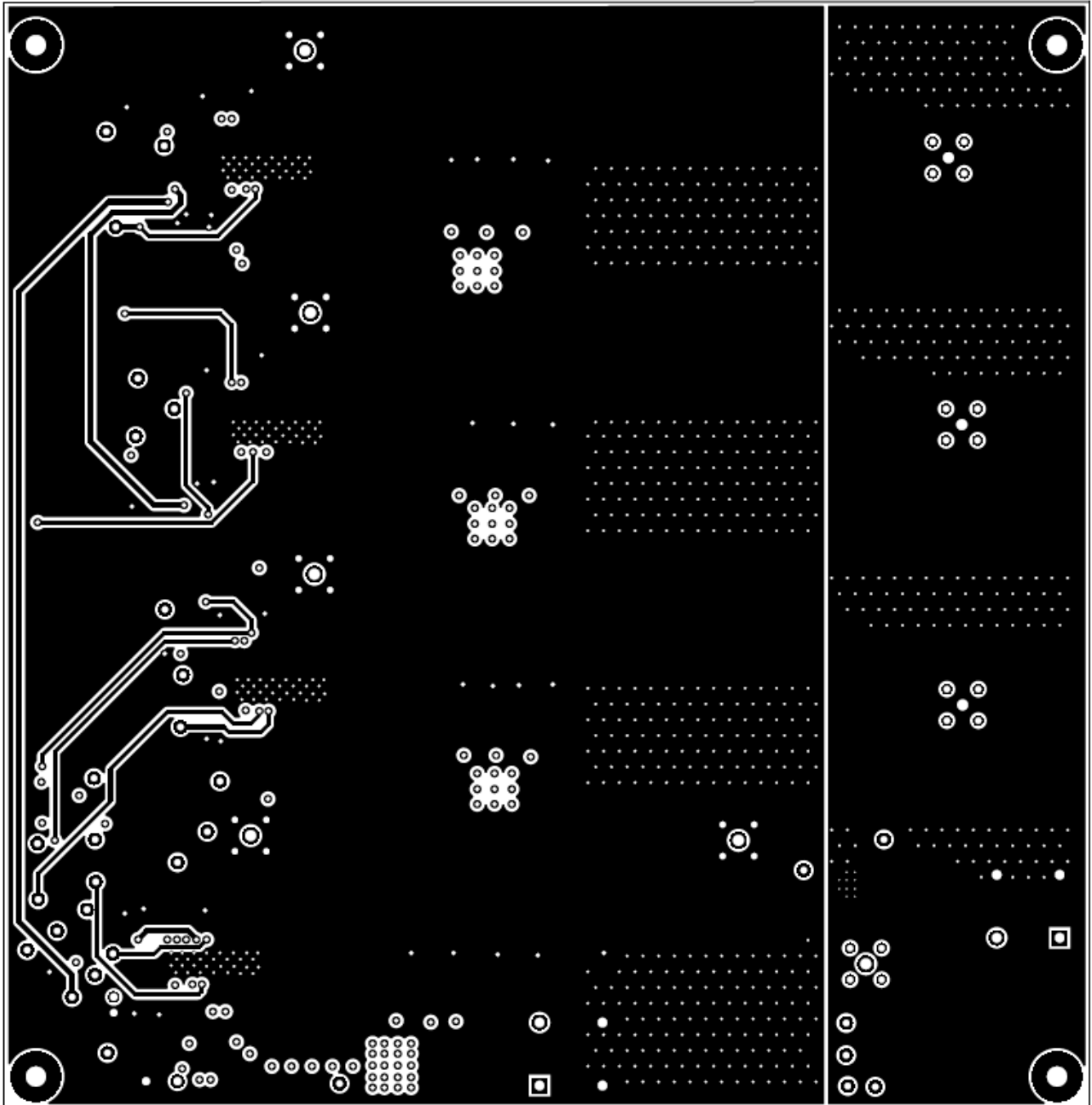

Figure 21. Signal Layer Four

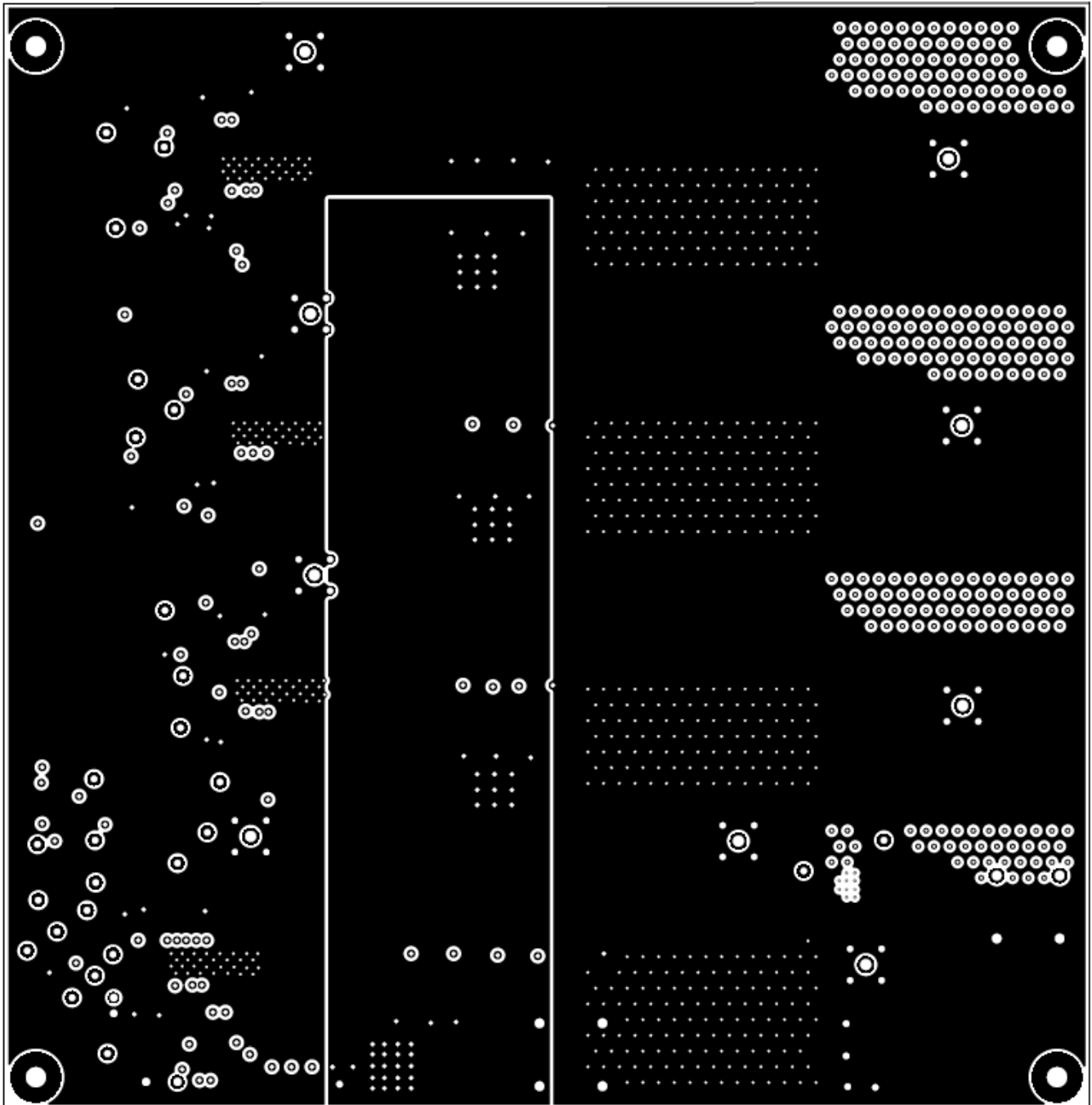

Figure 22. Signal Layer Five

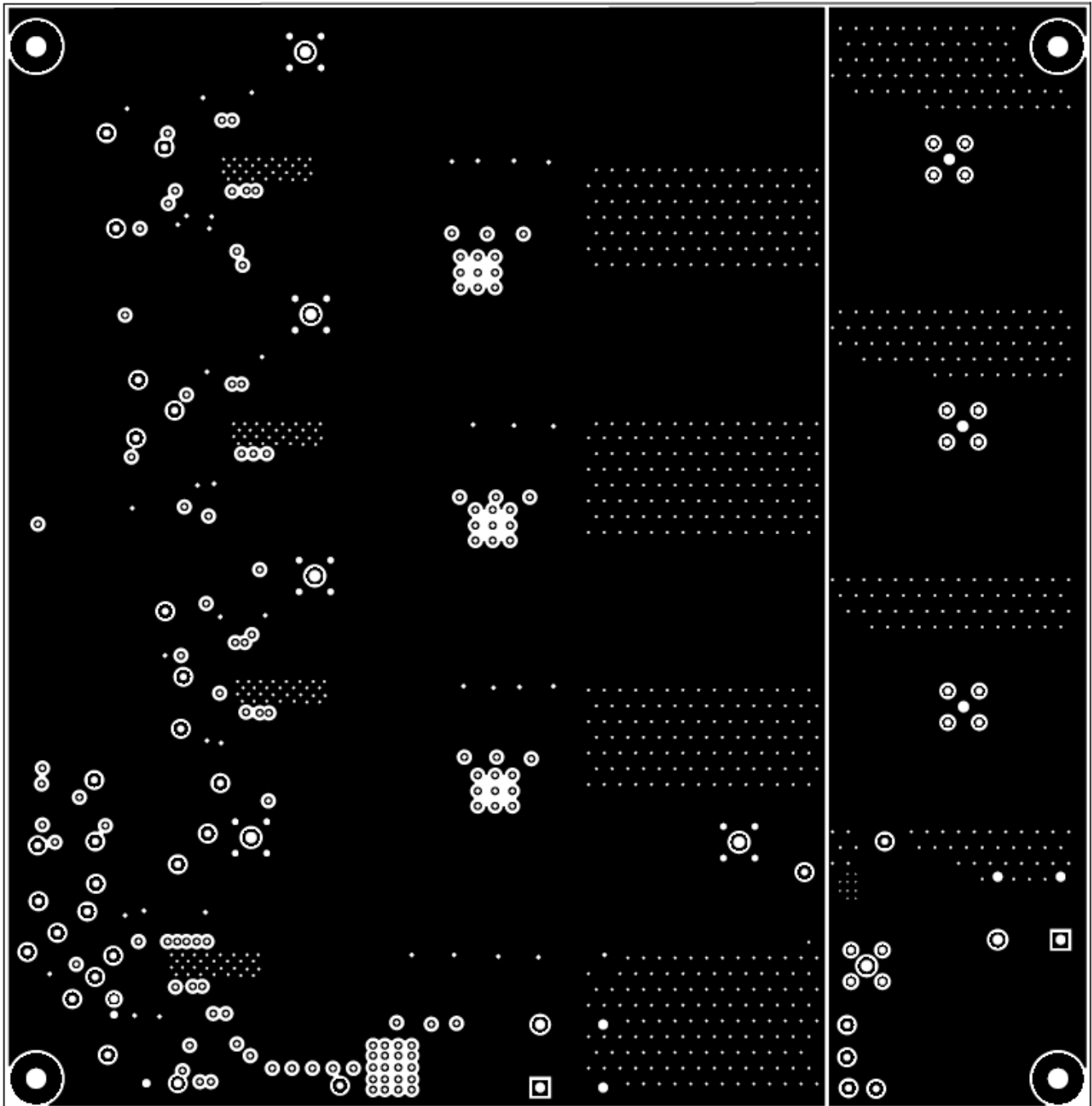

Figure 23. Signal Layer Six

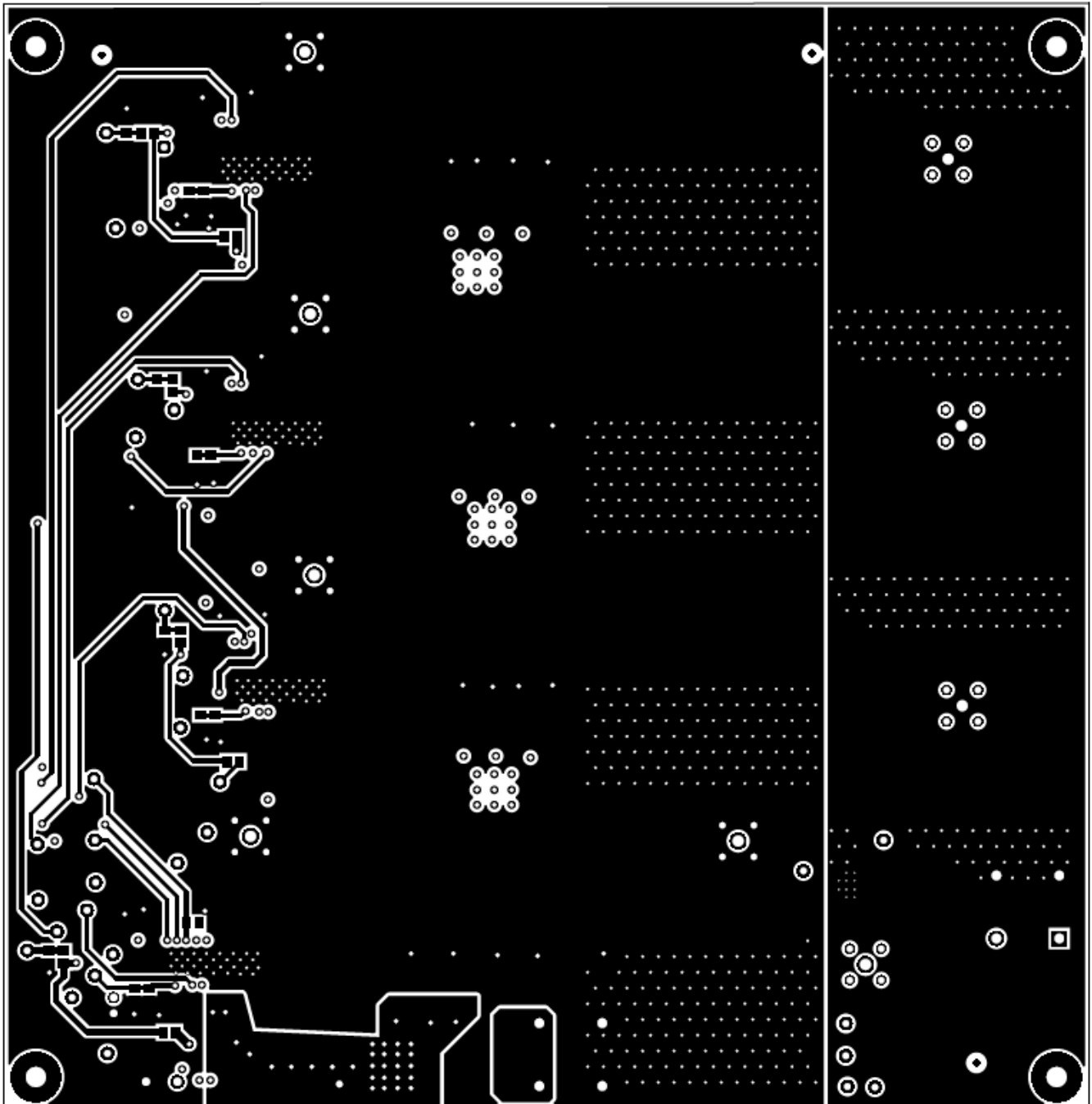

Figure 24. Bottom Layer

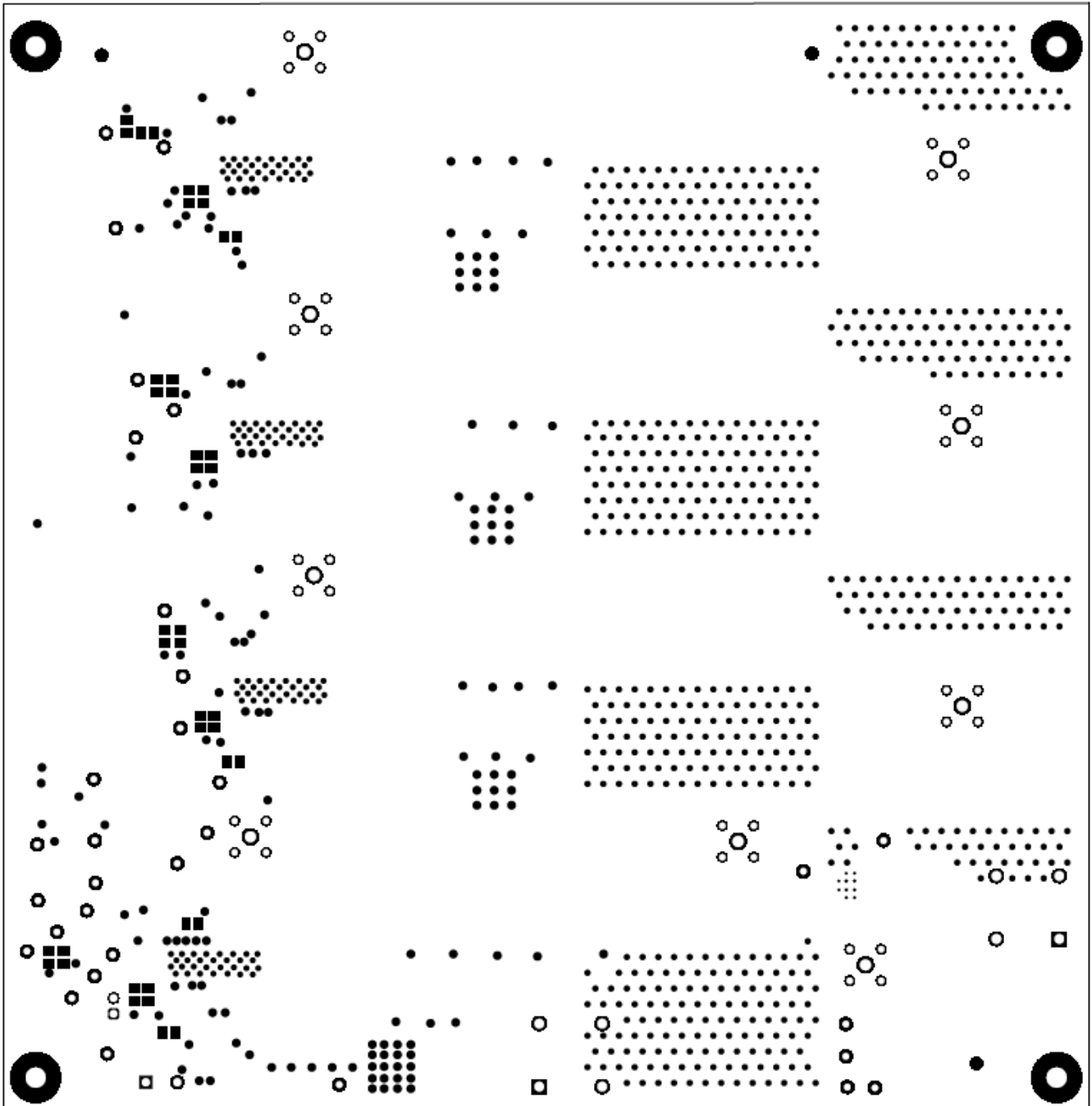

Figure 25. Bottom Solder

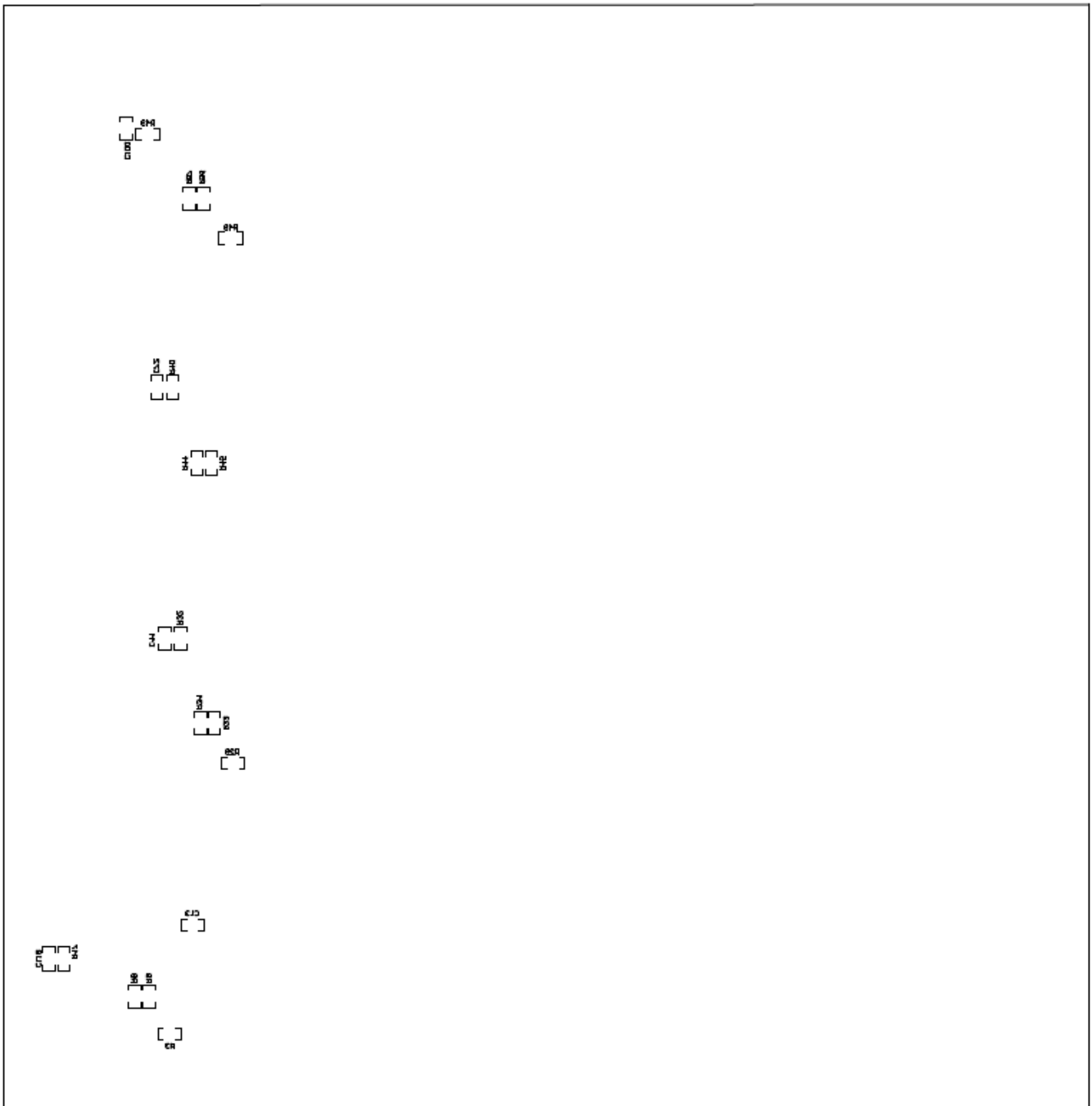

Figure 26. Bottom Overlay

IMPORTANT NOTICE AND DISCLAIMER

TI PROVIDES TECHNICAL AND RELIABILITY DATA (INCLUDING DATA SHEETS), DESIGN RESOURCES (INCLUDING REFERENCE DESIGNS), APPLICATION OR OTHER DESIGN ADVICE, WEB TOOLS, SAFETY INFORMATION, AND OTHER RESOURCES "AS IS" AND WITH ALL FAULTS, AND DISCLAIMS ALL WARRANTIES, EXPRESS AND IMPLIED, INCLUDING WITHOUT LIMITATION ANY IMPLIED WARRANTIES OF MERCHANTABILITY, FITNESS FOR A PARTICULAR PURPOSE OR NON-INFRINGEMENT OF THIRD PARTY INTELLECTUAL PROPERTY RIGHTS.

These resources are intended for skilled developers designing with TI products. You are solely responsible for (1) selecting the appropriate TI products for your application, (2) designing, validating and testing your application, and (3) ensuring your application meets applicable standards, and any other safety, security, regulatory or other requirements.

These resources are subject to change without notice. TI grants you permission to use these resources only for development of an application that uses the TI products described in the resource. Other reproduction and display of these resources is prohibited. No license is granted to any other TI intellectual property right or to any third party intellectual property right. TI disclaims responsibility for, and you will fully indemnify TI and its representatives against, any claims, damages, costs, losses, and liabilities arising out of your use of these resources.

TI's products are provided subject to [TI's Terms of Sale](#) or other applicable terms available either on ti.com or provided in conjunction with such TI products. TI's provision of these resources does not expand or otherwise alter TI's applicable warranties or warranty disclaimers for TI products.

TI objects to and rejects any additional or different terms you may have proposed.

Mailing Address: Texas Instruments, Post Office Box 655303, Dallas, Texas 75265
Copyright © 2022, Texas Instruments Incorporated