

# ***C28x Embedded Application Binary Interface***

*Application Note*

---



Literature Number: SPRAC71B  
FEBRUARY 2019 – REVISED OCTOBER 2023



# Table of Contents



<b>1 Introduction</b>	7
1.1 ABIs for the C28x	8
1.2 Scope	9
1.3 ABI Variants	10
1.4 Toolchains and Interoperability	10
1.5 Libraries	10
1.6 Types of Object Files	11
1.7 Segments	11
1.8 C28x Architecture Overview	11
1.9 C28x Memory Models	11
1.10 Reference Documents	11
1.11 Code Fragment Notation	12
<b>2 Data Representation</b>	13
2.1 Basic Types	14
2.2 Data in Registers	15
2.3 Data in Memory	15
2.4 Pointer Types	15
2.5 Complex Types	16
2.6 Structures and Unions	16
2.7 Arrays	16
2.8 Bit Fields	17
2.8.1 Volatile Bit Fields	18
2.9 Enumeration Types	18
<b>3 Calling Conventions</b>	19
3.1 Call and Return	20
3.1.1 Call Instructions	20
3.1.2 Return Instruction	20
3.1.3 Pipeline Conventions	20
3.1.4 Weak Functions	20
3.2 Register Conventions	20
3.2.1 Argument Registers	22
3.2.2 Callee-Saved Registers	23
3.3 Argument Passing	23
3.3.1 Passing 16-Bit Arguments	23
3.3.2 Passing Longer Arguments	24
3.3.3 C++ Argument Passing	24
3.3.4 Passing Structs and Unions	25
3.3.5 Stack Layout of Arguments Not Passed in Registers	25
3.3.6 Frame Pointer	25
3.4 Return Values	25
3.5 Structures and Unions Passed and Returned by Reference	26
3.6 Conventions for Compiler Helper Functions	26
3.7 Prolog and Epilog Helper Functions	27
3.8 Scratch Registers for Functions Already Seen	27
3.9 Interrupt Functions	27
<b>4 Data Allocation and Addressing</b>	29
4.1 Data Sections and Segments	30
4.2 Data Blocking	31
4.3 Addressing Modes	31

4.4 Allocation and Addressing of Static Data.....	31
4.4.1 Addressing Methods for Static Data.....	32
4.4.2 Placement Conventions for Static Data.....	32
4.4.3 Initialization of Static Data.....	32
4.5 Automatic Variables.....	32
4.6 Frame Layout.....	32
4.6.1 Stack Alignment.....	33
4.6.2 Register Save Order.....	34
4.7 Heap-Allocated Objects.....	34
<b>5 Code Allocation and Addressing.....</b>	<b>35</b>
5.1 Computing the Address of a Code Label.....	36
5.2 Calls.....	36
5.2.1 Direct Call.....	36
5.2.2 Far Call Trampoline.....	36
5.2.3 Indirect Calls.....	36
<b>6 Helper Function API.....</b>	<b>37</b>
6.1 Floating-Point Behavior.....	38
6.2 C Helper Function API.....	38
6.3 Floating-Point Helper Functions for C99.....	40
<b>7 Standard C Library API.....</b>	<b>41</b>
7.1 About Standard C Libraries.....	42
7.2 Reserved Symbols.....	42
7.3 <assert.h> Implementation.....	42
7.4 <complex.h> Implementation.....	42
7.5 <ctype.h> Implementation.....	43
7.6 <errno.h> Implementation.....	43
7.7 <float.h> Implementation.....	43
7.8 <inttypes.h> Implementation.....	43
7.9 <iso646.h> Implementation.....	43
7.10 <limits.h> Implementation.....	44
7.11 <locale.h> Implementation.....	44
7.12 <math.h> Implementation.....	44
7.13 <setjmp.h> Implementation.....	45
7.14 <signal.h> Implementation.....	45
7.15 <stdarg.h> Implementation.....	45
7.16 <stdbool.h> Implementation.....	45
7.17 <stddef.h> Implementation.....	45
7.18 <stdint.h> Implementation.....	46
7.19 <stdio.h> Implementation.....	46
7.20 <stdlib.h> Implementation.....	46
7.21 <string.h> Implementation.....	47
7.22 <tgmath.h> Implementation.....	47
7.23 <time.h> Implementation.....	47
7.24 <wchar.h> Implementation.....	47
7.25 <wctype.h> Implementation.....	47
<b>8 C++ ABI.....</b>	<b>49</b>
8.1 Limits (GC++ABI 1.2).....	50
8.2 Export Template (GC++ABI 1.4.2).....	50
8.3 Data Layout (GC++ABI Chapter 2).....	50
8.4 Initialization Guard Variables (GC++ABI 2.8).....	50
8.5 Constructor Return Value (GC++ABI 3.1.5).....	50
8.6 One-Time Construction API (GC++ABI 3.3.2).....	50
8.7 Controlling Object Construction Order (GC++ ABI 3.3.4).....	50
8.8 Demangler API (GC++ABI 3.4).....	50
8.9 Static Data (GC++ ABI 5.2.2).....	51
8.10 Virtual Tables and the Key function (GC++ABI 5.2.3).....	51
8.11 Unwind Table Location (GC++ABI 5.3).....	51
<b>9 Exception Handling.....</b>	<b>53</b>
9.1 Overview.....	54
9.2 PREL31 Encoding.....	54
9.3 The Exception Index Table (EXIDX).....	55

9.3.1 Pointer to Out-of-Line EXTAB Entry.....	55
9.3.2 EXIDX_CANTUNWIND.....	55
9.3.3 Inlined EXTAB Entry.....	55
9.4 The Exception Handling Instruction Table (EXTAB).....	56
9.4.1 EXTAB Generic Model.....	56
9.4.2 EXTAB Compact Model.....	56
9.4.3 Personality Routines.....	57
9.5 Unwinding Instructions.....	57
9.5.1 Common Sequence.....	57
9.5.2 Byte-Encoded Unwinding Instructions.....	57
9.6 Descriptors.....	60
9.6.1 Encoding of Type Identifiers.....	60
9.6.2 Scope.....	60
9.6.3 Cleanup Descriptor.....	61
9.6.4 Catch Descriptor.....	61
9.6.5 Function Exception Specification (FESPEC) Descriptor.....	62
9.7 Special Sections.....	62
9.8 Interaction With Non-C++ Code.....	62
9.8.1 Automatic EXIDX Entry Generation.....	62
9.8.2 Hand-Coded Assembly Functions.....	62
9.9 Interaction With System Features.....	63
9.9.1 Shared Libraries.....	63
9.9.2 Overlays.....	63
9.9.3 Interrupts.....	63
9.10 Assembly Language Operators in the TI Toolchain.....	63
<b>10 DWARF.....</b>	<b>65</b>
10.1 DWARF Register Names.....	66
10.2 Call Frame Information.....	67
10.3 Vendor Names.....	68
10.4 Vendor Extensions.....	68
<b>11 ELF Object Files (Processor Supplement).....</b>	<b>69</b>
11.1 Registered Vendor Names.....	70
11.2 ELF Header.....	70
11.3 Sections.....	71
11.3.1 Section Indexes.....	71
11.3.2 Section Types.....	71
11.3.3 Extended Section Header Attributes.....	72
11.3.4 Subsections.....	72
11.3.5 Special Sections.....	72
11.3.6 Section Alignment.....	74
11.4 Symbol Table.....	74
11.4.1 Symbol Types.....	75
11.4.2 Common Block Symbols.....	75
11.4.3 Symbol Names.....	75
11.4.4 Reserved Symbol Names.....	75
11.4.5 Mapping Symbols.....	75
11.5 Relocation.....	75
11.5.1 Relocation Types.....	76
11.5.2 Relocation Operations.....	78
11.5.3 Relocation of Unresolved Weak References.....	78
<b>12 ELF Program Loading and Linking (Processor Supplement).....</b>	<b>79</b>
12.1 Program Header.....	80
12.1.1 Base Address.....	80
12.1.2 Segment Contents.....	80
12.1.3 Thread-Local Storage.....	80
12.2 Program Loading.....	81
<b>13 Build Attributes.....</b>	<b>83</b>
13.1 About Build Attributes.....	84
13.2 C28x ABI Build Attribute Subsection.....	84
13.3 Build Attribute Tags.....	85
<b>14 Copy Tables and Variable Initialization.....</b>	<b>87</b>

14.1 About Copy Tables.....	88
14.2 Copy Table Format.....	90
14.3 Compressed Data Formats.....	91
14.3.1 RLE.....	91
14.3.2 LZSS Format.....	91
14.4 Variable Initialization.....	92
<b>15 Revision History.....</b>	<b>95</b>

## List of Figures

Figure 1-1. Parts of the ABI Specification.....	9
Figure 3-1. C28x Registers.....	22
Figure 4-1. Data Sections and Segments (Typical).....	30
Figure 4-2. Local Frame Layout.....	33
Figure 9-1. Short Form Scope.....	60
Figure 9-2. Long Form Scope.....	60
Figure 14-1. Copy Table Overview.....	89
Figure 14-2. Handler Table Format.....	90
Figure 14-3. Compressed Source Data Format.....	91
Figure 14-4. ROM-Based Variable Initialization Via cinit.....	92
Figure 14-5. The .cinit Section.....	93

## List of Tables

Table 2-1. Data Sizes for Standard Types.....	14
Table 2-2. Data Sizes for Pointers.....	15
Table 3-1. TMS320C28x Register Conventions.....	21
Table 4-1. TMS320C28x Addressing Modes.....	31
Table 6-1. TMS320C28x EABI Functions.....	38
Table 6-2. Reserved Floating-Point Classification Helper Functions.....	40
Table 9-1. C28x TDEH Personality Routines.....	57
Table 9-2. Stack Unwinding Instructions.....	58
Table 10-1. DWARF3 Register Numbers for C28x.....	66
Table 10-2. DWARF3 Register Numbers for FPU on C28x.....	67
Table 10-3. TI Vendor-Specific Tags.....	68
Table 10-4. TI Vendor-Specific Attributes.....	68
Table 11-1. Registered Vendors.....	70
Table 11-2. ELF Identification Fields.....	70
Table 11-3. ELF and TI Section Types.....	71
Table 11-4. C28x Special Sections.....	73
Table 11-5. C28x Relocation Types.....	76
Table 11-6. C28x Relocation Operations.....	78
Table 12-1. Steps to Create a Process Image from an ELF Executable.....	81
Table 12-2. Steps to Initialize the Execution Environment.....	81
Table 12-3. Termination Steps.....	81
Table 13-1. C28x ABI Build Attribute Tags.....	86
Table 15-1. Revision History.....	95



This document is a specification for the ELF-based Embedded Application Binary Interface (EABI) for the C28x family of processors from Texas Instruments. The EABI is a broad standard that defines the low-level interface between programs, program components, and the execution environment, including the operating system if one is present. Components of the EABI include calling conventions, data layout and addressing conventions, and object file formats.

This specification aims to enable tool providers, software providers, and users of the C28x to build tools and programs that can interoperate with each other.

<b>1.1 ABIs for the C28x</b> .....	<b>8</b>
<b>1.2 Scope</b> .....	<b>9</b>
<b>1.3 ABI Variants</b> .....	<b>10</b>
<b>1.4 Toolchains and Interoperability</b> .....	<b>10</b>
<b>1.5 Libraries</b> .....	<b>10</b>
<b>1.6 Types of Object Files</b> .....	<b>11</b>
<b>1.7 Segments</b> .....	<b>11</b>
<b>1.8 C28x Architecture Overview</b> .....	<b>11</b>
<b>1.9 C28x Memory Models</b> .....	<b>11</b>
<b>1.10 Reference Documents</b> .....	<b>11</b>
<b>1.11 Code Fragment Notation</b> .....	<b>12</b>

## 1.1 ABIs for the C28x

Prior to release 18.12.0.LTS of TI's C28x Compiler Tools, the one and only ABI for C28x was the original COFF-based ABI. It was strictly a bare-metal ABI; there was no execution-level component.

Release 18.12.0.LTS of the TI Compiler Tools introduced a new ABI called the C28x EABI. It is based on the ELF object file format. It is derived from industry standard models, including the *IA-64 C++ ABI* and the *System V ABI for ELF and Dynamic Linking*. The processor-specific aspects of the ABI, such as data layout and calling conventions, are largely unchanged from the COFF ABI, although there are some differences. Needless to say, the COFF ABI and the EABI are incompatible; that is to say, all of the code in a given system must follow the same ABI. TI's compiler tools support both the new EABI and the older COFF ABI, although we encourage migration to the new ABI as support for the COFF ABI may be discontinued in the future.

A *platform* is the software environment upon which a program runs. The ABI has platform-specific aspects, particularly in the area of conventions related to the execution environment, such as the number and use of program segments, addressing conventions, visibility conventions, pre-emption, program loading, and initialization. Currently bare metal is the only supported platform. The term *bare metal* represents the absence of any specific environment. That is not to say there cannot be an OS; it simply says that there are no OS-specific ABI specifications. In other words, how the program is loaded and run, and how it interacts with other parts of the system, is not covered by the bare-metal ABI.

The bare-metal ABI allows substantial variability in many specific aspects. For example, an implementation may provide position independence (PIC), but if a given system does not require position independence, these conventions do not apply. Because of this variability, programs may still be ABI-conforming but incompatible; for example if one program uses PIC but the other does not, they cannot interoperate. Toolchains should endeavor to enforce such incompatibilities.



## 1.2 Scope

Figure 1-1 shows the components of the ABI and their relationship. We will briefly describe the components, beginning with the lower part of the diagram and moving upward, and provide references to the appropriate chapter of this ABI specification.

The components in the bottom area relate to object-level interoperability.

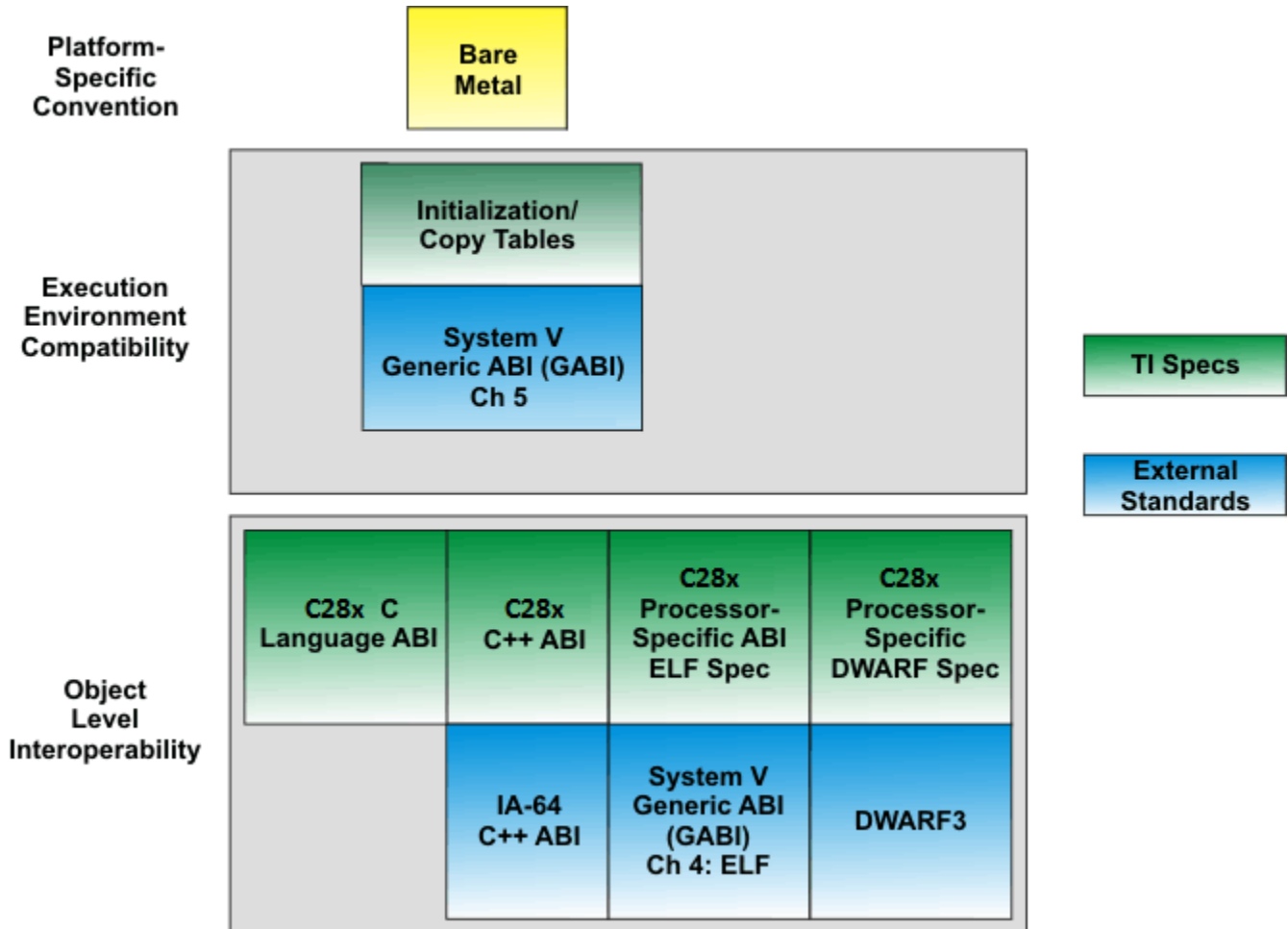

Figure 1-1. Parts of the ABI Specification

The **C Language ABI** (Chapter 2, Chapter 3, Chapter 4, Chapter 5, Chapter 6 and Chapter 7) specifies function calling conventions, data type representations, addressing conventions, and the interface to the C run-time library.

The **C++ ABI** (Chapter 8) specifies how the C++ language is implemented; this includes details about virtual function tables, name mangling, how constructors are called, and the exception handling mechanism (Chapter 9). The C28x C++ ABI is based on the prevalent IA-64 (Itanium) C++ ABI.

The **DWARF** component (Chapter 10) specifies the representation of object-level debug information. The base standard is the DWARF3 standard. This specification details processor-specific extensions.

The **ELF** component (Chapter 11) specifies the representation of object files. This specification extends the System V ABI specification with processor specific information.

**Build Attributes** (Chapter 13) refer to a means of encoding into an object file various parameters that affect inter-object compatibility, such as target device assumptions, memory models, or ABI variants. Toolchains can use build attributes to prevent incompatible object files from being combined or loaded.

The components in the central area of the diagram relate to execution-time interoperability.

The components in the top part of Figure 1-1 augment the ABI with platform-specific conventions that define the requirements for executables to be compatible with an execution environment, such as the number and use of program segments, addressing conventions, visibility conventions, pre-emption, program loading, and initialization. **Bare-Metal** refers to the absence of any specific environment.

Finally, there is a set of specifications that are not formally part of the ABI but are documented here both for reference and so that other toolchains can optionally implement them.

**Initialization** (Chapter 14) refers to the mechanism whereby initialized variables obtain their initial value. Nominally these variables reside in the .data section and they are initialized directly when the .data section is loaded, requiring no additional participation from the tools. However the TI toolchain supports a mechanism whereby the .data section is encoded into the object file in compressed form, and decompressed at startup time. This is a special use of a general mechanism that programmatically copies compressed code or data from offline storage (e.g. ROM) to its execution address. We refer to this facility as *copy tables*. While not part of the ABI, the initialization and copy table mechanism is documented here so that other toolchains can support it if desired.

### 1.3 ABI Variants

As mentioned, the ABI does not define specific behavior in all instances but rather is a canon of principles that allow for platform or system-specific variation. There are model variants within the ABI that may be used or not used. The ABI standardizes the implementation in cases where such variants are used. Some of the variants are incompatible with each other. If any object uses a particular model, all objects must. In such cases, toolchains are expected to use build attributes to prevent incompatible objects from being combined.

- **Bare Metal—Standalone.** This model refers to a single self-contained statically-linked executable. It is the simplest form in terms of interoperability. The relevant parts of the ABI are the object-level components in the lower part of Figure 1-1. Since the executable is statically linked and bound (relocated), there is no need for position-independence.

### 1.4 Toolchains and Interoperability

This ABI is not specific to any particular vendor's toolchain. In fact, its purpose is to enable alternative toolchains to exist and interoperate. The ABI describes how mechanisms are implemented; not how toolchains support them at the user level. Occasionally references are made to the TI tools, these are for illustration only. However, TI's C28x Compiler Tools by nature have unique status since they originate from the silicon vendor and were co-developed with the ABI specification, and in some cases form its basis.

If the behavior of the TI tools conflicts with this ABI, it shall be considered a defect in the tools; if you find such a case, please submit a defect report to support@tools.ti.com. However, in cases where this specification is incomplete or unclear, the behavior of the TI tools shall be considered definitive. A major goal of the ABI standard is interoperability with TI tools; toolchain vendors should strive to meet this goal regardless of omissions or ambiguities in the standard itself. Please notify us in such cases and we will endeavor to clarify the specification.

### 1.5 Libraries

Generally, a toolchain includes a linker as well as standard run-time libraries that implement part of the language support provided by the toolchain.

The library format used by the C28x is the common GNU/SVR4 ar format.

Often the linker and libraries have interdependencies that are outside the realm of the ABI. For example, many linkers use special symbols to control the inclusion or exclusion of various library components; alternatively some libraries refer to special linker-defined symbols. For this reason the linker and library are expected to come

from the same toolchain. Using a linker from one toolchain and a library from a different one is not supported under this ABI. This only applies to the built-in libraries that are part of the toolchain; application libraries built with a different toolchain can be linked.

## 1.6 Types of Object Files

ELF defines the following distinct classes of object files:

- A **relocatable** file holds code and data suitable for static linking with other object files to create an executable file.
- An **executable** file holds a program suitable for execution.

This specification uses the terms *static link unit* and *load module* interchangeably to refer to executables .

## 1.7 Segments

An ELF load module (an executable file ) represents the memory image of the program in the form of *segments*. In this context a segment is a contiguous, indivisible range of memory with common properties. A segment becomes bound when its address is determined, which happens statically at link time.

## 1.8 C28x Architecture Overview

C28x devices have 16-bit and 32-bit CPU registers.

C28x devices have 32-bit address registers, but almost all C28x devices have only a 22-bit address space.

C28x is compiled in little-endian mode only.

C28x is word-addressable, and words are 16 bits.

There are no 8-bit objects on C28x devices. This presents unique challenges for implementing the ELF object file format on C28x devices. See [Chapter 11](#) for more about ELF files.

## 1.9 C28x Memory Models

C28x EABI supports only one memory model: the unified large memory model. In this model, both pointers and the `ptrdiff_t` type are 32 bits.

For information about pointers, see [Section 2.4](#).

## 1.10 Reference Documents

Document Title	Link or URL
TMS320C28x Optimizing C/C++ Compiler User's Guide	<a href="#">SPRU514</a>
TMS320C28x Assembly Language Tools User's Guide	<a href="#">SPRU513</a>
TMS320C28x DSP CPU and Instruction Set Reference Guide	<a href="#">SPRU430</a>
ELF Specification—GABI Chapters 4/5	<a href="http://www.caldera.com/developers/gabi/2003-12-17/contents.html">http://www.caldera.com/developers/gabi/2003-12-17/contents.html</a>
IA64 (Itanium) C++ ABI	<a href="http://refspecs.linux-foundation.org/cxxabi-1.83.html">http://refspecs.linux-foundation.org/cxxabi-1.83.html</a>
IA64 (Itanium) Exception Handling ABI	<a href="http://www.codesourcery.com/public/cxx-abi/abi-eh.html">http://www.codesourcery.com/public/cxx-abi/abi-eh.html</a>
Application Binary Interface for the ARM Architecture	<a href="http://infocenter.arm.com/help/index.jsp?topic=/com.arm.doc.subset.swdev.abi/index.html">http://infocenter.arm.com/help/index.jsp?topic=/com.arm.doc.subset.swdev.abi/index.html</a>
C Library ABI for the ARM Architecture	<a href="http://infocenter.arm.com/help/topic/com.arm.doc.ih0039b/IHI0039B_clibabi.pdf">http://infocenter.arm.com/help/topic/com.arm.doc.ih0039b/IHI0039B_clibabi.pdf</a>
DWARF DEBUGGING Format Version 3	<a href="http://dwarfstd.org/Dwarf3.pdf">http://dwarfstd.org/Dwarf3.pdf</a>
C Language Standard	<a href="http://www.open-std.org/jtc1/sc22/wg14">http://www.open-std.org/jtc1/sc22/wg14</a> , ISO/IEC 9899:1990
C99 Language Standard	<a href="http://www.open-std.org/jtc1/sc22/wg14">http://www.open-std.org/jtc1/sc22/wg14</a> , ISO/IEC 9899
C++ Language Standard	<a href="http://www.open-std.org/jtc1/sc22/wg21">http://www.open-std.org/jtc1/sc22/wg21</a> , ISO/IEC 14882:1998

## 1.11 Code Fragment Notation

Throughout this document we use code fragments to illustrate addressing, calling sequences, and so on. In the fragments, the following notational conventions are often used:

<b>sym</b>	The symbol being referenced
<b>label</b>	A symbol referring to a code address
<b>func</b>	A symbol referring to a function
<b>tmp</b>	A temporary register (also tmp1, tmp2, etc)
<b>reg, reg1, reg2</b>	An arbitrary register
<b>dest</b>	The destination register for a resulting value or address

There are several assembler built-in operators introduced. These serve to generate appropriate relocations for various addressing constructs, and are generally self-evident.



This section describes the representation in memory and registers of the standard C data types. Other languages may be supported; the types used by those languages will define their own mapping to these representations.

In the descriptions and diagrams in this section, bit 0 always refers to the least-significant bit.

<b>2.1 Basic Types</b> .....	<b>14</b>
<b>2.2 Data in Registers</b> .....	<b>15</b>
<b>2.3 Data in Memory</b> .....	<b>15</b>
<b>2.4 Pointer Types</b> .....	<b>15</b>
<b>2.5 Complex Types</b> .....	<b>16</b>
<b>2.6 Structures and Unions</b> .....	<b>16</b>
<b>2.7 Arrays</b> .....	<b>16</b>
<b>2.8 Bit Fields</b> .....	<b>17</b>
<b>2.9 Enumeration Types</b> .....	<b>18</b>

## 2.1 Basic Types

Integral values use twos-complement representation. Floating-point values are represented using IEEE 754.1 representation. Floating-point operations follow IEEE 754.1 to the degree supported by the hardware.

[Table 2-1](#) gives the size and alignment of C data types in bits.

**Table 2-1. Data Sizes for Standard Types**

Type	Generic Name	Size	Alignment
signed char	schar	16	16
unsigned char	uchar	16	16
char	plain char	16	16
bool (C99)	uchar	16	16
_Bool (C99)	uchar	16	16
bool (C++)	uchar	16	16
short, signed short	int16	16	16
unsigned short	uint16	16	16
int, signed int	int16	16	16
unsigned int	uint16	16	16
long , signed long	int32	32	32
unsigned long	uint32	32	32
long long, signed long long	int64	64	32
unsigned long long	uint64	64	32
enum	--	varies (see <a href="#">Section 2.9</a> )	32
float	float32	32	32
double	float64	64	32
long double	float64	64	32
pointer	--	32	16

Generic names in the table are used in this specification to identify types in a language-independent way.

The *char* type is unsigned by default. This is in contrast to the "signed char" and "unsigned char" types, which specify their sign behavior.

The integral types have complementary unsigned variants. The generic names are prefixed with 'u' (e.g. uint32).

The type *bool* uses the value 0 to represent false and 1 to represent true. Other values are undefined.

The additional types from C, C99 and C++ are defined as synonyms for standard types:

```
typedef unsigned long   wchar_t;
typedef unsigned long   wint_t;
typedef char *         va_list;
```

## 2.2 Data in Registers

In general, implementations are free to use registers as they see fit. The standard register representations specified in this section apply only to values passed to or returned from functions.

Some struct objects can reside in registers. See [Section 2.6](#) for more information.

Numeric values in registers are always right justified; that is, bit 0 of the register contains the least significant bit of the value. Signed integral values smaller than 16 bits are sign extended into the upper bits of the register. Unsigned values smaller than 16 bits are zero extended.

C28x has registers of varying sizes. Most commonly-used CPU registers are 16 or 32 bits, and the choice of register depends on the size of the data.

The ACC, P, and XT registers may hold 32-bit data.

- ACC is a register pair of AH:AL. The two 16-bit subregisters can be accessed independently.
- P is a register pair of PH:PL. The two 16-bit subregisters can be accessed independently.
- XT is T:TL. While T can be accessed independently, TL cannot.

The following register pairs may hold 64-bit data or pointers: ACC:P, XAR1:XAR0, XAR3:XAR2, AR5:XAR4, and XAR7:XAR6. In these pairs, the least-significant bits are contained in the second register of the pair.

The XAR0-XAR7 registers may hold 32-bit pointers.

The AH, AL, T, PH, PL, and AR0-AR7 registers may hold 16-bit data.

For devices that support FPU, the R0-R7 registers may hold 32-bit float values.

For more about C28x registers, see the *TMS320C28x DSP CPU and Instruction Set Reference Guide (SPRU430)*.

## 2.3 Data in Memory

The C28x uses little-endian mode only. Endianness refers to the memory layout of multi-byte values. In little endian mode, the least significant byte is stored at the smallest address. Endianness affects only objects' memory representation; scalar values in registers always have the same representation regardless of endianness. Endianness does affect the layout of structures and bit fields, which carries over into their register representation.

Scalar variables are aligned such that they can be loaded and stored using the native instructions appropriate for their type: MOV for words, and MOVL for doublewords. There are no native instructions to load or store 64-bit types. These instructions correctly account for endianness when moving to and from memory.

## 2.4 Pointer Types

Pointers have the following data sizes.

**Table 2-2. Data Sizes for Pointers**

Type	Size	Storage	Alignment
function pointer	32	32	32
data pointer	32	32	32
size_t	32	32	32
ptrdiff_t	32	32	32

Even though pointers are stored as 32 bits, the compiler should assume that the addresses of global variables and functions are within a 22-bit limit.

## 2.5 Complex Types

The `_Complex` types defined in the C99 standard are supported. The internal representation is as follows:

```
struct _Complex
{ float_type real;
  float_type imag; };
```

## 2.6 Structures and Unions

Structure members are assigned offsets starting at 0. Each member is assigned the lowest available offset that satisfies its alignment. Padding may be required between members to satisfy this alignment constraint.

Union members are all assigned an offset of 0.

The underlying representation of a C++ class is a structure. Elsewhere in this document the term *structure* applies to classes as well.

The alignment requirement of a structure or union is equal to the most strict alignment requirement among its members, including bit field containers as described in the next section. The size of a structure or union in memory is rounded up to a multiple of its alignment by inserting padding after the last member. Structures and unions passed by value on the stack have special alignment rules as specified in [Section 3.3](#).

In general, structures having size 32 bits or less may reside in registers or register pairs while being passed to or returned from functions. Such structures are passed by value in the R0H-R3H registers, then by value on the stack. Single field structures are passed and returned by value corresponding to the underlying scalar type. See [Section 3.5](#) for information about larger structures and unions passed and returned by reference.

For devices that support FPU32 or FPU64, homogeneous float structures with a size less than 128 bits are passed by value. In addition, for devices that support FPU64, 64-bit doubles (R0-R3) are passed by value.

In little-endian mode a structure in a register is always right justified; that is, the first byte occupies the LSB of the register (the even register if a pair) and subsequent bytes of the structure are filled into the increasingly significant bytes of the register(s). The C28x uses little-endian mode only.

## 2.7 Arrays

The minimum alignment for an object with the *array* type is that specified by the type of its elements.

C62x, C67x	4 bytes
All others	8 bytes



## 2.8 Bit Fields

The C28x EABI adopts its bit field layout from the IA64 C++ ABI. The following description is consistent with that standard unless explicitly indicated.

The **declared type** of a bit field is the type that appears in the source code. To hold the value of a bit field, the C and C++ standards allow an implementation to allocate any *addressable storage unit* large enough to hold it, which need not be related to the declared type. The addressable storage unit is commonly called the *container type*, and that is how we refer to it in this document. The container type is the major determinant of how bit fields are packed and aligned.

For efficiency, the compiler may access a bit-field with a type that does not match either the declared type or the container type. The declared type and container type are strictly used to determine bit field packing and alignment. The type used to actually load the bit-field is the access type. It can be a narrower type, computed from the size and offset of the bit-field. For instance, in the following example, the container type is 32 bits, but the bit-field will be loaded using a 16-bit access:

```
struct S
{
    long :16;
    long bf:16;
};
```

The C89, C99, and C++ language standards have different requirements for the declared type:

C89	int, unsigned int, signed int
C99	int, unsigned int, signed int, <code>_Bool</code> , or "some other implementation-defined type"
C++	Any integral or enumeration type, including <code>bool</code>

There is no *long long* type in strict C++, but because C99 has it, C++ compilers commonly support it as an extension. The C99 standard does not require an implementation to support long or long long declared types for bit fields, but because C++ allows it, it is not uncommon for C compilers to support them as well.

A bit field's value is fully contained within its container, exclusive of any padding bits. Containers are properly aligned for their type. The alignment of the structure containing the field is affected by that of the container in the same way as a member object of that type. This also applies to unnamed fields, which is a difference from the IA64 C++ ABI. The container may contain other fields or objects, and may overlap with other containers, but the bits reserved for any one field, including padding for oversized fields, never overlap with those of another field.

In the C28x EABI, the container type of a bit field is its declared type, with one exception. C++ allows so-called oversized bit fields, which have a declared size larger than the declared type. In this case the container is the largest integral type not larger than the declared size of the field.

The layout algorithm maintains a *next available bit* that is the starting point for allocating a bit field. The steps in the layout algorithm are:

1. Determine the container type T, as described previously.
2. Let C be the properly-aligned container of type T that contains the next available bit. C may overlap previously allocated containers.
3. If the field can be allocated within C, starting at the next available bit, then do so.
4. If not, allocate a new container at the next properly aligned address and allocate the field into it.
5. Add the size of the bit field (including padding for oversized fields) to determine the next available bit.

In little-endian mode, containers are filled from LSB to MSB. The C28x uses little-endian mode only.

Zero-length bit fields force the alignment of the following member of a structure to the next alignment boundary corresponding to the declared type, and affect structure alignment.

A declared type of plain *int* is treated as a *signed int* by C28x EABI.

### 2.8.1 Volatile Bit Fields

A volatile bit field is one declared with the C *volatile* keyword. When a volatile bit field is read, its container must be read exactly once using the appropriate access for the entire container.

When a volatile bit field with a size less than its container is written, its container must be read exactly once and written exactly once using the appropriate access. The read and the write are not required to be atomic with respect to each other.

The compiler does not use a narrower type for volatile bit-fields; it will instead use exactly the declared type.

When a volatile bit-field with a size exactly equal to the container size is written, it is unspecified whether the read takes place. Because such reads are unspecified, it is not safe to interlink object files compiled with different implementations if they both write to a volatile bit-field with exactly the width of its container. For this reason, using volatile bit-fields in external interfaces should be avoided.

Multiple accesses to the same volatile bit field, or to additional volatile bit fields within the same container may not be merged. For example, an increment of a volatile bit field must always be implemented as two reads and a write. These rules apply even when the width and alignment of the bit field would allow more efficient access using a narrower type. For a write operation the read must occur even if the entire contents of the container will be replaced. If the containers of two volatile bit fields overlap then access to one bit field will cause an access to the other.

An access to 'a' will also cause an access to 'b', but not vice-versa. If the container of a non-volatile bit field overlaps a volatile bit field then it is undefined whether access to the non-volatile field will cause the volatile field to be accessed.

### 2.9 Enumeration Types

Enumeration types (C type *enum*) are represented using an underlying integral type. Normally the underlying type is int or unsigned int, unless neither can represent all the enumerators. In that case, if long or unsigned long can represent all the enumerators, that type is used. Otherwise, the underlying type is long long or unsigned long long. When both the signed and unsigned versions can represent all the values, the ABI leaves the choice among the two alternatives to the implementation. (An application that requires consistency among different toolchains can ensure the choice of the signed alternative by declaring a negative enumerator.)

The C standard requires enumeration constants to fit in type "signed int", so enum types may only be int or unsigned int in strict ANSI mode. Wider enum types are possible in C++. The TI compiler also allows wider enum types in relaxed and GCC modes.

Chapter 3  
**Calling Conventions**

---



This chapter describes conventions for function calls, including the behavior of return values, registers, and argument passing.

<b>3.1 Call and Return</b> .....	<b>20</b>
<b>3.2 Register Conventions</b> .....	<b>20</b>
<b>3.3 Argument Passing</b> .....	<b>23</b>
<b>3.4 Return Values</b> .....	<b>25</b>
<b>3.5 Structures and Unions Passed and Returned by Reference</b> .....	<b>26</b>
<b>3.6 Conventions for Compiler Helper Functions</b> .....	<b>26</b>
<b>3.7 Prolog and Epilog Helper Functions</b> .....	<b>27</b>
<b>3.8 Scratch Registers for Functions Already Seen</b> .....	<b>27</b>
<b>3.9 Interrupt Functions</b> .....	<b>27</b>

## 3.1 Call and Return

A function call is made by calling the dedicated LCR instruction, which pushes the return address to the function call stack and branches to the called function. The called function returns by executing a dedicated LRETR instruction, which pops the return address from the stack and branches to it.

### 3.1.1 Call Instructions

#### 3.1.1.1 Indirect Calls

When the function to be called is not known at compile time, for all architectures, the address of the function will be stored in CPU register XAR7. This instruction reaches the entire address space. For example:

```
LCR *XAR7
```

#### 3.1.1.2 Direct Calls

When the called function is known at compile time, all architectures use a direct call instruction. This instruction may use an immediate, absolute, or symbolic addressing mode. The examples here show only the immediate addressing modes.

The C28x uses the LCR instruction. This addressing mode reaches all valid code memory.

```
LCR #func ; immediate mode, call func
```

### 3.1.2 Return Instruction

A called function returns by executing a dedicated LRET instruction, which pops the return address from the stack and branches to it.

If the function is an interrupt handler function, the IRET instruction is used instead.

### 3.1.3 Pipeline Conventions

The C28x pipeline is protected. Consideration of pipeline latencies or instruction completion is not required (though it may be helpful in improving code performance).

### 3.1.4 Weak Functions

A weak function is a function whose symbol has binding STB\_WEAK. A program can successfully link without a definition of a weak function, leaving references to it unresolved.

The ABI supports calls to imported weak functions; that is, functions potentially defined in a different static link unit. If a reference to a weak function remains unresolved at link time, the linker replaces its address with zeros. The user is responsible for adding a check that the address is not zero or NULL before attempting to call a weak function.

## 3.2 Register Conventions

Implementations must not use the special-purpose registers for any purpose other than the dedicated special purpose. The remaining registers are general-purpose registers.

**SP** is the call stack pointer. The stack pointer must always remain properly aligned, even during hand-coded assembly functions (see [Section 4.6.1](#)). TMS320C28x requires alignment to 16-bit words. Stack management and the local frame structure is presented in [Section 4.6](#).

The ABI designates the following as *callee-saved* registers. That is, a called function is expected to preserve them so they have the same value on return from a function as they had at the point of the call.

- XAR1-XAR3
- R4H-R7H (on FPU32)
- R4L-R7L (on FPU64)

All other registers are *caller-save* registers. That is, they are not preserved across a call, so if their value is needed following the call, the caller is responsible for saving and restoring their contents.

**Table 3-1. TMS320C28x Register Conventions**

Register	Size	Description
ACC	32 bits	Accumulator
AH	16 bits	High half of ACC
AL	16 bits	Low half of ACC
XAR0	16 bits	Auxiliary register 0
XAR1	32 bits	Auxiliary register 1
XAR2	32 bits	Auxiliary register 2
XAR3	32 bits	Auxiliary register 3
XAR4	32 bits	Auxiliary register 4
XAR5	32 bits	Auxiliary register 5
XAR6	32 bits	Auxiliary register 6
XAR7	32 bits	Auxiliary register 7
AR0	16 bits	Low half of XAR0
AR1	16 bits	Low half of XAR1
AR2	16 bits	Low half of XAR2
AR3	16 bits	Low half of XAR3
AR4	16 bits	Low half of XAR4
AR5	16 bits	Low half of XAR5
AR6	16 bits	Low half of XAR6
AR7	16 bits	Low half of XAR7
DP	16 bits	Data-page pointer
IFR	16 bits	Interrupt flag register
IER	16 bits	Interrupt enable register
DBGIER	16 bits	Debug interrupt enable register
P	32 bits	Product register
PH	16 bits	High half of P
PL	16 bits	Low half of P
PC	22 bits	Program counter
RPC	22 bits	Return program counte
SP	16 bits	Stack pointer
ST0	16 bits	Status register 0
ST1	16 bits	Status register 1
XT	32 bits	Multiplicand register
T	16 bits	High half of XT
TL	16 bits	Low half of XT

In addition, some devices have an FPU instruction set, which adds registers R0-R7.

Figure 3-1 shows the C28x registers. See the *TMS320C28x DSP CPU and Instruction Set Reference Guide* (SPRU430) for more information about the registers.

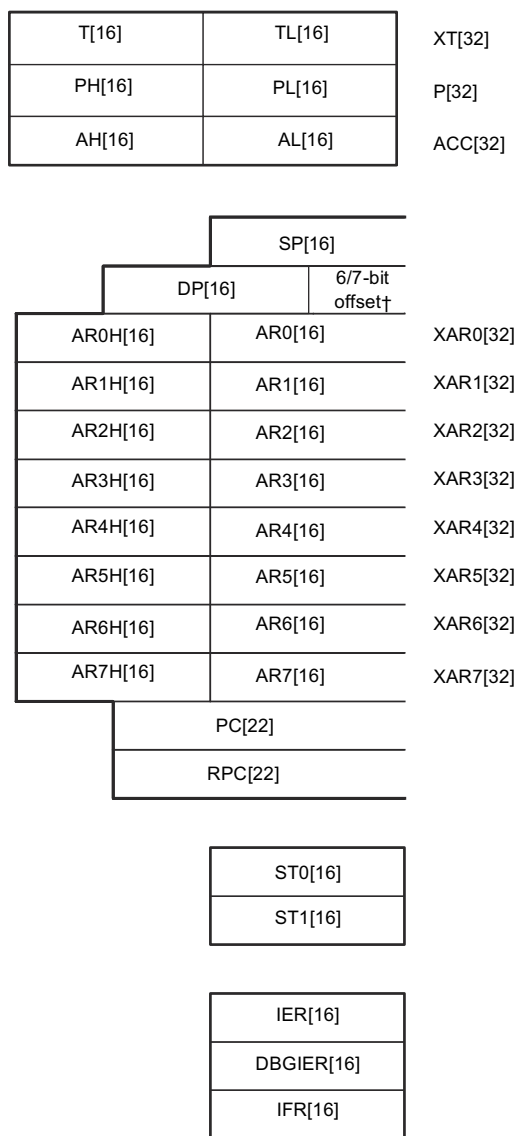

**Figure 3-1. C28x Registers**

### 3.2.1 Argument Registers

The registers that may be used to pass arguments include R0-3 (32-bit float arguments for devices that support FPU), ACC:P (64-bit arguments), ACC (32-bit arguments), XAR4 and XAR5 (pointer arguments), and AL and AH (16-bit arguments). The first argument of each type is placed in the register for that type, and remaining arguments of that type are placed on the stack.

On devices with FPU64 support, double precision floats (64-bit) are passed in registers. On devices without FPU64 support, doubles are passed by reference.

See "How a Function Makes a Call" in the *TMS320C28x Optimizing C/C++ Compiler User's Guide* (SPRU514).

### 3.2.2 Callee-Saved Registers

A called function is required to preserve the callee-saved registers so that they have the same value on return from a function as they had at the point of the call.

Registers XAR1, XAR2, and XAR3 are callee-saved. If the target supports FPU, the R4H, R5H, R6H, and R7H registers are also callee-saved.

All other general-purpose registers are caller-save; that is, they are not preserved across a call, so if their value is needed following the call, the caller is responsible for saving and restoring their contents.

### 3.3 Argument Passing

The number of arguments passed in registers depends on the size and type of each argument. Arguments are assigned, in declared order, to an available register of the appropriate size. Additional arguments are passed on the stack. See "How a Function Makes a Call" in the *TMS320C28x Optimizing C/C++ Compiler User's Guide* ([SPRU514](#)).

#### 3.3.1 Passing 16-Bit Arguments

Arguments with a type that fits in a single CPU register are passed in a single CPU register. That is, types up to 16 bits are passed in a single register. Pointer types are also passed in a single register, regardless of size.

Pointer types are stored as 32-bit values but should be treated as having a 22-bit limit on the address space.

#### Example 1:

*C source code:*

```
void func1(int a0, int a1, int a2, int a3);
int a0, a1, a2, a3;
void func2(void)
{
    func1(a0, a1, a2, a3);
}
```

*Compiled assembly code:*

```
MOVW    DP,#a0
MOV     AL,@a0
MOV     AH,@a1
MOVZ    AR4,@a2
MOVZ    AR5,@a3
; call instruction here
```

**Example 2:**

C source code:

```
void func1(int *a0, int *a1, int *a2, int *a3);
int a0, a1, a2, a3;
void func2(void)
{
    func1(&a0, &a1, &a2, &a3);
}
```

Compiled assembly code:

```
MOVL    XAR4,#a2
MOVL    XAR5,#a1
MOVL    *-SP[2],XAR4
MOVL    XAR4,#a3
MOVL    *-SP[4],XAR4
MOVL    XAR4,#a0
; call instruction here
```

### 3.3.2 Passing Longer Arguments

The 32-bit ACC register (AH:AL) is used to pass long arguments.

**Example:**

C source code:

```
void func1(int a0, long a1, int a2);
int a0, a2;
long a1;
func2(void)
{
    func1(a0, a1, a2);
}
```

Compiled assembly code:

```
MOVW    DP,#a0
MOVZ    AR4,@a0
MOVL    ACC,@a1
MOVZ    AR5,@a2
```

The 64-bit ACC:P register pair is used to pass long long arguments.

**Example:**

C source code:

```
void func1(long long a0);
long long a0;
func2(void)
{
    func1(a0);
}
```

Compiled assembly code:

```
MOVW    DP,#a0
MOVL    P,@a0
MOVL    ACC,@a0+2
```

### 3.3.3 C++ Argument Passing

In C++, the "this" pointer is passed to non-static member functions in XAR4 as an implicit first argument. (If a non-static member function returns a struct by reference, the order is "&struct", "this".)



### 3.3.4 Passing Structs and Unions

Structures and unions 32 bits or smaller are passed by value. Structures and unions larger than 32 bits are generally passed by reference, as described in [Section 3.5](#). However, see [Section 2.6](#) for additional cases where structures and unions are passed by value when using FPU32 or FPU64.

### 3.3.5 Stack Layout of Arguments Not Passed in Registers

Any arguments not passed in registers are placed on the stack in reverse order. Each argument is placed at the next available address correctly aligned for its type, subject to the following additional considerations:

- The stack alignment of a scalar is that of its declared type.
- Regardless of the alignment required by its members, the stack alignment of a structure passed by value is the smallest power of two greater than or equal to its size. (This cannot exceed 2 bytes, which is the largest allowable size for a structure passed by value). This is to allow loading arguments with aligned loads, even if the type is not naturally aligned strictly enough, which might be the case with struct of size 32 containing an array of char.
- Each argument reserves an amount of stack space equal to its size rounded up to the next multiple of its stack alignment.

For a variadic C function (that is, a function declared with an ellipsis indicating that it is called with varying numbers of arguments), the last explicitly declared argument and all remaining arguments are passed on the stack, so that its stack address can act as a reference for accessing the undeclared arguments.

Undeclared scalar arguments to a variadic function that are smaller than int are promoted to and passed as int, in accordance with the C language.

Alignment "holes" can occur between arguments passed on the stack, but "back-fill" does not occur.

### 3.3.6 Frame Pointer

C28x does not use a frame pointer. This effectively limits a single call frame to 0xffff bytes, which is the minimum SP offset supported by any instruction.

## 3.4 Return Values

The function return value is placed in the same register as the usual first argument register, based on its type and size.

- 16-bit results are returned in the AL register.
- 32-bit results are returned in the ACC register.
- 64-bit results are returned in the ACC:P register pair.
- Structs returned by reference are returned in \*XAR6.
- 32-bit float results are returned in R4H for FPU32 and FPU64.
- 64-bit double results are returned in R4 for FPU64. If FPU64 is not supported, double results are returned by reference.

Aggregates larger than 32 bits are returned by reference.

See "How a Called Function Responds" in the *TMS320C28x Optimizing C/C++ Compiler User's Guide* ([SPRU514](#)).

### 3.5 Structures and Unions Passed and Returned by Reference

Structures (including classes) and unions larger than 32 bits are passed and returned by reference. See [Section 2.6](#) for additional cases where structures and unions are passed by value when using FPU32 or FPU64.

To pass a structure or union by reference, the caller places its address in the appropriate location: either in a register or on the stack, according to its position in the argument list. To preserve pass-by-value semantics (required for C and C++), the callee may need to make its own copy of the pointed-to object. In some cases, the callee need not make a copy, such as if the callee is a leaf and it does not modify the pointed-to object.

If the called function returns a structure or union larger than 32 bits, the caller must pass an additional argument containing a destination address for the returned value, or NULL if the returned value is not used.

This additional argument is passed in the first argument register as an implicit first argument. The callee returns the object by copying it to the given address. The caller is responsible for allocating memory if required. Typically this involves reserving space on the stack, but in some cases the address of an already-existing object can be passed and no allocation is required. For example, if `f` returns a structure, the assignment `s = f()` can be compiled by passing `&s` in the first argument register.

#### Examples

*C source code:*

```

struct S { char big[100]; } g;
struct S accepts_and_returns_struct(struct S s)
{
    s.big[0] = 1;
    return s;
}
void caller(void)
{
    struct S w;
    w.big[0] = 0;
    g = accepts_and_returns_struct(w);
}
    
```

*"Lowered" C code:* (higher-level C code converted to lower-level C code)

```

struct S { char big[100]; } g;
void accepts_and_returns_struct(struct S *dst, struct S *sptr)
{
    struct S s;
    s = *sptr;
    s.big[0] = 1;
    if (dst) *dst = s;
}
void caller(void)
{
    struct S w;
    w.big[0] = 0;
    accepts_and_returns_struct(&g, &w);
}
    
```

### 3.6 Conventions for Compiler Helper Functions

The ABI specifies *helper functions* that the compiler uses to implement language features. Generally, these functions adhere to the standard calling conventions. See [Section 6.2](#) for a list of helper functions.

### 3.7 Prolog and Epilog Helper Functions

The following prolog and epilog functions are used as helper functions to reduce code size. Each function performs a typical POP-and-RET function epilog sequence. Code size is reduced by replacing the typical POP-and-RET epilog sequence with a branch to one of these functions. Each function is named after the number of consecutive registers that it restores.

```
_prolog_c28x_1
_prolog_c28x_2
_prolog_c28x_3
_epilog_c28x_1
_epilog_c28x_2
```

The `--opt_for_space` option performs procedural abstraction by replacing common blocks of code, such as prolog and epilog code, with calls to functions that are defined in the run-time library. For this reason, it is necessary to link with the supplied run-time library when using the `--opt_for_space` option. See "Increasing Code-Size Optimizations" in the *TMS320C28x Optimizing C/C++ Compiler User's Guide* ([SPRU514](#)) for more information. Note that this procedural abstraction does not support the FPU registers.

### 3.8 Scratch Registers for Functions Already Seen

When a caller-save register is live across a call, but the callee is known not to modify that register, the compiler may optimize the caller function code by omitting the save and restore around the call. This arises when the definition has been seen.

### 3.9 Interrupt Functions

Interrupt functions (that is, the assembly function that performs the ISR) must save a number of registers. These registers include AR1H, AR0H, XT, and XAR4-XAR7. The following assembly code performs the proper context save and C environment fixing actions for devices *without* FPU32 support:

```
ASP      ; [CPU_]
PUSH     AR1H:AR0H      ; [CPU_]
SPM      0              ; [CPU_]
MOVL     *SP++,XT       ; [CPU_]
MOVL     *SP++,XAR4     ; [CPU_]
MOVL     *SP++,XAR5     ; [CPU_]
MOVL     *SP++,XAR6     ; [CPU_]
MOVL     *SP++,XAR7     ; [CPU_]
CLRC     PAGE0,OVM     ; [CPU_]
CLRC     AMODE          ; [CPU_]
LCR      #||call||     ; [CPU_] |3|
; call occurs [#||call||] ; [] |3|
MOVL     XAR7,*--SP     ; [CPU_]
MOVL     XAR6,*--SP     ; [CPU_]
MOVL     XAR5,*--SP     ; [CPU_]
MOVL     XAR4,*--SP     ; [CPU_]
MOVL     XT,*--SP      ; [CPU_]
POP      AR1H:AR0H     ; [CPU_]
NASP     ; [CPU_]
IRET     ; [CPU_]

```

The following assembly code performs the proper context save and C environment fixing actions for devices that do support FPU32:

```

ASP      ; [CPU_]
PUSH     RB                      ; [CPU_] x
PUSH     AR1H:AR0H              ; [CPU_]
MOVL     *SP++,XT               ; [CPU_]
MOVL     *SP++,XAR4             ; [CPU_]
MOVL     *SP++,XAR5             ; [CPU_]
MOVL     *SP++,XAR6             ; [CPU_]
MOVL     *SP++,XAR7             ; [CPU_]
MOV32    *SP++,STF              ; [CPU_] x
MOV32    *SP++,R0H              ; [CPU_]
MOV32    *SP++,R1H              ; [CPU_]
MOV32    *SP++,R2H              ; [CPU_]
MOV32    *SP++,R3H              ; [CPU_]
SETFLG   RNDF32=1, RNDF64=1    ; [CPU_]
SPM      0                      ; [CPU_]
CLRC     PAGE0,OVM              ; [CPU_]
CLRC     AMODE                  ; [CPU_]
LCR      #||call||             ; [CPU_] |3|
; call occurs [#||call||] ; [] |3|
MOV32    R3H, *--SP             ; [CPU_]
MOV32    R2H, *--SP             ; [CPU_]
MOV32    R1H, *--SP             ; [CPU_]
MOV32    R0H, *--SP             ; [CPU_]
MOV32    STF, *--SP             ; [CPU_]
MOVL     XAR7, *--SP            ; [CPU_]
MOVL     XAR6, *--SP            ; [CPU_]
MOVL     XAR5, *--SP            ; [CPU_]
MOVL     XAR4, *--SP            ; [CPU_]
MOVL     XT, *--SP              ; [CPU_]
POP      AR1H:AR0H              ; [CPU_]
POP      RB                      ; [CPU_]
NASP     ; [CPU_]
IRET     ; [CPU_]

```

Interrupts push the SR and PC registers onto the stack and branch to an interrupt handler. To return from an interrupt function, the function must execute the special instruction IRET, which restores the SR register and branches to the PC where the interrupt occurred.

Chapter 4  
**Data Allocation and Addressing**

---



This chapter describes conventions for storage of data. The data sections defined by the ABI are shown in [Figure 4-1](#).

<b>4.1 Data Sections and Segments</b> .....	<b>30</b>
<b>4.2 Data Blocking</b> .....	<b>31</b>
<b>4.3 Addressing Modes</b> .....	<b>31</b>
<b>4.4 Allocation and Addressing of Static Data</b> .....	<b>31</b>
<b>4.5 Automatic Variables</b> .....	<b>32</b>
<b>4.6 Frame Layout</b> .....	<b>32</b>
<b>4.7 Heap-Allocated Objects</b> .....	<b>34</b>

## 4.1 Data Sections and Segments

In a relocatable object file output by the compiler or assembler, variables are allocated into sections using default rules and compiler directives. A section is an indivisible unit of allocation in a relocatable file. Sections often contain objects with similar properties. Various sections are designated for data, depending on whether the section is initialized, whether it is writable or read-only, how it will be addressed, and what kind of data it contains.

Conventions for placement of static variables into sections and for how they are addressed are covered in [Section 4.4.2](#).

The linker combines sections from object files to form segments in an ELF load module (executable). A segment is a continuous range of memory allocated to a load module, representing part of the execution image of the program.

A load module may contain one or more data segments, into which the linker allocates stack, heap, and static variables. Items may be grouped into a single segment or multiple segments, subject only to these restrictions:

- Within a segment, initialized data must precede uninitialized data. This is a structural constraint of ELF.
- Any additional restrictions imposed by the platform-specific conventions.

The run-time environment can dynamically allocate or resize uninitialized data segments, to allocate space for items such as the stack and heap.

[Figure 4-1](#) shows the data sections defined by the ABI, and an abstract mapping of sections into segments. The mapping is only representative; the specific configuration may vary by platform or system. Initialized sections are shaded blue; uninitialized sections are shaded gray.

Data Sections		
<b>.data</b>	Initialized read-write data	RAM
<b>.bss</b>	Uninitialized read-write data	
<b>.stack</b>	Program stack	
<b>.system</b>	Dynamic data (heap)	
Read-Only Sections		
<b>.const</b>	Far const (read-only) data	ROM or RAM

**Figure 4-1. Data Sections and Segments (Typical)**

The `.const` section contains read-only constants. The `.const` section may be located in read-only memory, and may be addressed using absolute addressing.

The `.data` section contains initialized read-write data.

The `.bss` section contains uninitialized read-write data.

Additional special sections that can be placed by the linker command file are listed in [Section 11.3.5](#).

## 4.2 Data Blocking

Blocking ensures that an object fits entirely within a page or begins on a page boundary. Data blocking allows the compiler to reduce the number of unnecessary DP loads.

For C28x EABI, the default blocking rules are:

- Arrays and their sections are *not* blocked.
- Scalars and their sections are blocked.
- Structs with external linkages (extern in C) are blocked.
- Structs with internal linkages (static in C) are *not* blocked, but their sections are blocked.
- Uninitialized, initialized, and const data are blocked.

However, data page blocking can result in alignment holes in memory due to aligning data to page boundaries. So, there is a tradeoff between your application's need for code size and speed optimization and its need for data size optimization. You can use the **blocked** and **noblocked** data attributes to control blocking on specific variables. See "Data Page (DP) Pointer Load Optimization" and "Variable Attributes" in the *TMS320C28x Optimizing C/C++ Compiler User's Guide* ([SPRU514](#)).

## 4.3 Addressing Modes

C28x devices use a variety of assembly code addressing modes. These modes are briefly listed here and described in detail in the "C28x Addressing Modes" chapter of the *TMS320C28x DSP CPU and Instruction Set Reference Guide* ([SPRU430](#)).

The C28x EABI calling convention requires that the address mode bit (AMODE) of the Status Register (ST1) be set to 0, which is the default. Setting AMODE=0 restricts the set of addressing modes allowed, but allows SP-relative addressing.

Note that assembly code may set AMODE=1, so the linker must be prepared to handle 7-bit direct addressing.

**Table 4-1. TMS320C28x Addressing Modes**

Mode Name	Assembly Example	Relocation Type	Notes
Direct addressing	MOV AL, @var	DP-relative relocation	
Stack addressing	MOV AL, *-SP[4]	no relocation	
Indirect addressing	MOV AL, *XAR3	no relocation	
Register addressing	MOV ACC, @T	no relocation	memory-mapped register move
Data immediate addressing	MOV AL, *(0:var)	absolute relocation	
Program immediate addressing	MAC P, loc16, 0:pma	absolute relocation	loc16 is an entirely distinct memory operand
I/O immediate addressing	OUT *(addr), loc16	absolute relocation	loc16 is an entirely distinct memory operand

## 4.4 Allocation and Addressing of Static Data

All variables that are not auto or dynamic are considered static data; that is, variables with C storage classes *extern* or *static* whose address is established at (static ) link time. These are allocated into various sections according to their properties and then combined into one or more static data segments.

Additional data segments containing static variables are referred to as *absolute data segments*, and are addressed using absolute addressing. There are no restrictions on their number, size, or placement.

#### 4.4.1 Addressing Methods for Static Data

This ABI supports only absolute forms of addressing for static data.

#### 4.4.2 Placement Conventions for Static Data

Interoperability between toolchains requires that addressing generated by one is consistent with placement generated by another, especially with respect to addressing.

This requires the ABI to establish some conventions. Some of these conventions depend on toolchain-specific behavior, such as code generation models supported, or even user behavior, such as command line options selected or language extensions applied. For this reason, the ABI takes a two-pronged approach:

- To achieve consistency, the ABI defines some abstract conventions for placement and addressing, that map to toolchain behavior in some toolchain-specific way. These conventions make it possible to build compatible object files with different toolchains, but cannot precisely specify how to do so.
- To enforce consistency, the ABI requires the linker to either link the program in such a way that the addressing constraints are satisfied, or refuse to link the program.

The toolchain generating the addressing may only have visibility to a variable's declaration and not its definition. Therefore, the conventions must be based only on information available at both points. This excludes, for example, the use of array dimensions.

##### 4.4.2.1 Abstract Conventions for Addressing

All variables are located within reach of absolute addressing (position dependent). Position-independent addressing is not supported.

#### 4.4.3 Initialization of Static Data

A static variable that has an initial non-zero value should be allocated into an initialized data section. The section's contents should be an image of the contents of memory corresponding to the initial values of all variables in the section. The variables thus obtain their initial values directly as the section is loaded into memory. This is the so-called *direct initialization model* used by most ELF-based toolchains.

Variables that are expected to be initialized to zero can be allocated into uninitialized sections. The loader is responsible for zeroing uninitialized space at the end of a data segment.

Although the compiler is required to encode initialized variables directly, the linker is not. The linker may translate the directly encoded initialized sections in the object files into an encoded format for the executable file, and rely on a library function to decode the information and perform the initialization at program startup. (Recall that the linker may assume that the library is from the same toolchain.) Encoding initialization data helps save space in the executable file; it also provides an initialization mechanism for self-booting ROM-based systems that do not rely on a loader. The TI toolchain implements such a mechanism, described in [Chapter 14](#). Other toolchains may adopt a compatible mechanism, a different mechanism, or none at all.

#### 4.5 Automatic Variables

Local variables of a procedure, i.e. variables with C storage class *auto*, are allocated either on the stack or in registers, at the compiler's discretion. Variables on the stack are addressed via the stack pointer (SP).

The stack is allocated from the `.stack` section, and is part of the data segment(s) of the program.

The stack grows from low addresses toward high addresses. The stack pointer must always remain aligned on a 2-word (32-bit) boundary. The SP points at the next unused memory location.

[Section 4.6](#) provides more detail on the stack conventions and local frame structure.

#### 4.6 Frame Layout

There are at least two cases that require a standardized layout for the local frame and ordering of callee-saved registers. They are exception handling and debugging.



This section describes conventions for managing the stack, the general layout of the frame, and the layout of the callee-saved area.

The stack grows from zero toward higher addresses. The SP points to the next unused memory location.

Objects in the frame are accessed using SP-relative addressing with positive offsets.

A compiler is free to allocate one or more "frame pointer" registers to access the frame. The TI compiler does not use a frame pointer, so a single call frame is limited to 0xffff bytes.

Insofar as a frame pointer is not part of the linkage between functions, the choice of whether to use a frame pointer, which register to use, and where it points is up to the discretion of the toolchain. However, the exception handling stack unwinding instructions assume that no frame pointer is available.

The stack frame of a function contains the following areas:

- **Incoming arguments** that are passed on the stack are part of the caller's frame.
- The **callee-saved area** stores registers modified by the function that must be preserved. If exceptions or debugging is enabled, a specific layout must be adhered to. If not, a compiler is free to use alternative schemes for saving registers.
- The **locals and spill temps** area consists of temporary storage used by the function.
- The **outgoing arguments** section is for passing non-register arguments to called functions, as detailed in [Section 3.3](#). The size of the section is the maximum required for any single call.

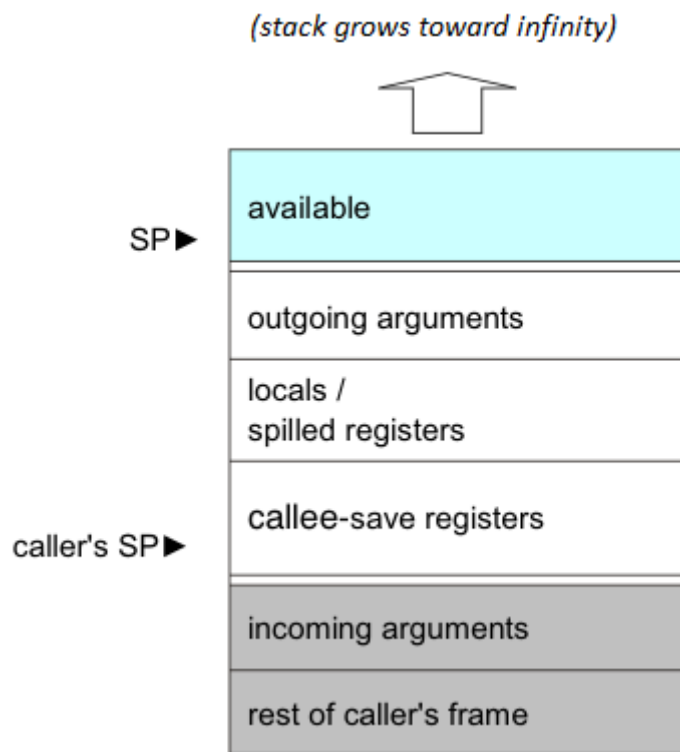

Figure 4-2. Local Frame Layout

Before the frame is allocated, SP points to the return address (SR for interrupt functions).

#### 4.6.1 Stack Alignment

The stack pointer (SP) is 2-word (32-bit) aligned. The stack addresses increase as the stack grows.

The stack must be aligned to 32 bits at all times in C/C++ callable functions that may propagate C++ exceptions. Assembly functions must align the SP (using the ASP instruction) before calling any C-callable function.

### 4.6.2 Register Save Order

As discussed in [Section 3.2](#), functions are responsible for preserving the contents of registers designated as *callee-saved*, normally accomplished by saving modified registers in the local frame upon entry to the function and restoring them before exit. Usually, the order and locations of the callee-saved registers on the stack do not matter, as long as they are restored from the same location as they were saved. In most cases, the compiler saves registers in an arbitrary order. However, there are some features which require a known ordering:

- **Safe Debug Order.** Registers are saved in the following order: XAR1-XAR3. Then, if the target supports FPU, the registers R4L, R4H, .. R7L, R7H are saved.
- **Exception Handling.** The stack unwinding process for exception handling needs to know exactly where each register is so that it can simulate the function epilog. To efficiently encode this information using a bit vector, we defined a fixed order. Exception handling re-uses the *callee-saved register safe debug order* for encoding the bit vectors, so the orderings are the same.

The compiler always saves registers in order, starting at the bottom (highest address) of the frame. If any registers are not saved, the registers will be packed so that there are no holes in the stack, but the relative order will remain the same.

### 4.7 Heap-Allocated Objects

Dynamically allocated objects, such as via C's `malloc()` or C++'s operator "new", are allocated by the runtime library. An execution environment may provide its own implementation of these functions provided they conform to the API specified by the language standard. This ABI does not specify any additional requirements on the dynamic allocation mechanism.

Chapter 5  
**Code Allocation and Addressing**

---



The compiler and assembler generate code into one or more sections. The default code section is called `.text`, but the programmer may direct code into additional named sections. The linker combines code sections into one or more segments. The base ABI imposes no restrictions on the number, size, or placement of code sections, although there may be platform-specific restrictions. Instructions have a variable length from 16 bits to 64 bits, in exact multiples of 16.

<b>5.1 Computing the Address of a Code Label</b> .....	<b>36</b>
<b>5.2 Calls</b> .....	<b>36</b>

## 5.1 Computing the Address of a Code Label

An assembly code section needs to compute a code address to:

- Perform a call or branch
- Create a function pointer
- Fill switch tables

The modes for specifying an address are briefly listed in [Section 4.3](#) and described in detail in the "Addressing Modes" section of the *TMS320C28x DSP CPU and Instruction Set Reference Guide* ([SPRU430](#)).

## 5.2 Calls

A function call is made by calling a dedicated LCR instruction, which pushes the return address to the function call stack and branches to the called function. The called function returns by executing a dedicated LRETR instruction, which pops the return address from the stack and branches to it.

```
LCR    funcname
```

### 5.2.1 Direct Call

If the direct call's target function is placed at a location that is unreachable with the offset in a direct CALL instruction, the static linker rewrites the CALL instruction so that it instead calls a helper stub function called a *trampoline*. The trampoline simply calls the target function. The linker is responsible for placing the trampoline within the reach of the CALL instruction.

### 5.2.2 Far Call Trampoline

The entire address space of the C28x can be reached by direct calls. Therefore, trampolines are not used.

### 5.2.3 Indirect Calls

An indirect call through a function pointer generates a branch with a register operand. For example:

```
LCR    *XAR7                ; indirect call
```



To enable object files built with one toolchain to be linked with a run-time support (RTS) library from another, the API between them must be specified. The interface has two parts. The first specifies functions on which the compiler relies to implement aspects of the language not directly supported by the instruction set. These are called *helper functions*, and are documented in this section. The second involves standardization of compile-time aspects of the source language library standard, such as the C, C99, or C++ Standard Libraries, which are covered in separate sections.

<b>6.1 Floating-Point Behavior</b> .....	<b>38</b>
<b>6.2 C Helper Function API</b> .....	<b>38</b>
<b>6.3 Floating-Point Helper Functions for C99</b> .....	<b>40</b>

## 6.1 Floating-Point Behavior

Floating-point behavior varies by device and by toolchain and is therefore difficult to standardize. The goal of the ABI is to provide a basis for conformance to the C, C99, and C++ standards. Of these C99 is the best-specified with respect to floating-point. Appendix F of the C99 standard defines floating-point behavior of the C language behavior in terms of the IEEE floating-point standard (ISO IEC 60559:1989, previously designated as ANSI/IEEE 754–1985).

The C28x ABI specifies that the helper functions in this section that operate on floating-point values must conform to the behavior specified by Appendix F of the C99 standard.

C99 allows customization of, and access to, the floating-point behavioral environment through the `<fenv.h>` header file. For purposes of standardizing the behavior of the helper functions, the ABI specifies them to operate in accordance with a basic default environment, with the following properties:

- The rounding mode is round to nearest. Dynamic rounding precision modes are not supported.
- No floating-point exceptions are supported.
- Inputs that represent Signaling NaNs behave like Quiet NaNs.
- The helper functions support only the behavior under the `FENV_ACCESS off` state. That is, the program is assumed to execute in non-stop mode and assumed not to access the floating-point environment.

A toolchain is free to implement more complete floating-point support, using its own library. Users who invoke toolchain-specific floating-point support may be required to link using that toolchain's library (in addition to an ABI-conforming helper function library).

## 6.2 C Helper Function API

The compiler generates calls to helper functions to perform operations that need to be supported by the compiler, but are not supported directly by the architecture, such as floating-point operations on devices that lack dedicated hardware. These helper functions must be implemented in the RTS library of any toolchain that conforms to the ABI.

Helper functions are named using the prefix `__C28x_`. Any identifier with this prefix is reserved for the ABI.

The helper functions adhere to the standard calling conventions.

The following tables specify the helper functions using C notation and syntax. The types in the table correspond to the generic data types specified in [Section 2.1](#).

The functions in [Table 6-1](#) perform various mathematical, logical, and comparison operations.

**Table 6-1. TMS320C28x EABI Functions**

Signature	Description
<code>__c28xabi_absll</code>	Return the absolute value of a long long int.
<code>__c28xabi_addd</code>	Add two double-precision floating numbers.
<code>__c28xabi_addf</code>	Add two single-precision floating numbers.
<code>__c28xabi_andll</code>	Bitwise AND for two long long integer values.
<code>__c28xabi_cmpd</code>	Compare two double-precision floating numbers.
<code>__c28xabi_cmpf</code>	Compare two single-precision floating numbers.
<code>__c28xabi_cmpll</code>	Compare two signed long long int values.
<code>__c28xabi_cmpull</code>	Compare two unsigned long long int values.
<code>__c28xabi_divd</code>	Divide two double-precision floating numbers.
<code>__c28xabi_divf</code>	Divide two single-precision floating numbers.
<code>__c28xabi_divi</code>	Divide two signed 16-bit integers.
<code>__c28xabi_divl</code>	Divide two signed 32-bit integers.
<code>__c28xabi_divll</code>	Divide two signed 64-bit long long integers.
<code>__c28xabi_divu</code>	Divide two unsigned 16-bit integers.
<code>__c28xabi_divul</code>	Divide two unsigned 32-bit integers.

**Table 6-1. TMS320C28x EABI Functions (continued)**

Signature	Description
__c28xabi_divull	Divide two unsigned 64-bit long long integers.
__c28xabi_dtof	Convert a double-precision floating number to a single-precision floating number.
__c28xabi_dtoi	Convert a double-precision floating number to a signed 16-bit integer.
__c28xabi_dtol	Convert a double-precision floating number to a signed 32-bit integer.
__c28xabi_dtoll	Convert a double-precision floating number to a signed 64-bit long long integer.
__c28xabi_dtou	Convert a double-precision floating number to an unsigned 16-bit integer.
__c28xabi_dtoul	Convert a double-precision floating number to an unsigned 32-bit integer.
__c28xabi_dtoull	Convert a double-precision floating number to an unsigned 64-bit long long integer.
__c28xabi_ftod	Convert a single-precision floating number to a double-precision floating number.
__c28xabi_ftoi	Convert a single-precision floating number to a signed 16-bit integer.
__c28xabi_ftol	Convert a single-precision floating number to a signed 32-bit integer.
__c28xabi_ftoll	Convert a single-precision floating number to a signed 64-bit long long integer.
__c28xabi_ftou	Convert a single-precision floating number to an unsigned 16-bit integer.
__c28xabi_ftoul	Convert a single-precision floating number to an unsigned 32-bit integer.
__c28xabi_ftoull	Convert a single-precision floating number to an unsigned 64-bit long long integer.
__c28xabi_itod	Convert a signed 16-bit integer to a double-precision floating number.
__c28xabi_itof	Convert a signed 16-bit integer to a single-precision floating number.
__c28xabi_lltod	Convert a signed 64-bit integer to a double-precision floating number.
__c28xabi_lltof	Convert a signed 64-bit integer to a single-precision floating number.
__c28xabi_ltod	Convert a signed 32-bit integer to a double-precision floating number.
__c28xabi_ltof	Convert a signed 32-bit integer to a single-precision floating number.
__c28xabi_modi	Compute the remainder of signed 16-bit division.
__c28xabi_modl	Compute the remainder of signed 32-bit division.
__c28xabi_modll	Compute the remainder of signed 64-bit long long integer division.
__c28xabi_modu	Compute the remainder of unsigned 16-bit division.
__c28xabi_modul	Compute the remainder of unsigned 32-bit division.
__c28xabi_modull	Compute the remainder of unsigned 64-bit long long integer division.
__c28xabi_mpyd	Multiply two double-precision floating numbers.
__c28xabi_mpyf	Multiply two single-precision floating numbers.
__c28xabi_mpyll	Multiply two signed 64-bit long long integer.s
__c28xabi_negd	Negate a double-precision floating number.
__c28xabi_negf	Negate a single-precision floating number.
__c28xabi_orll	Bitwise OR for two long long integer values.
__c28xabi_subd	Subtract one double-precision floating number from another.
__c28xabi_subf	Subtract one single-precision floating number from another.
__c28xabi_ulltod	Convert an unsigned 64-bit long long integer to a double-precision floating number.
__c28xabi_ulltof	Convert an unsigned 64-bit long long integer to a single-precision floating number.
__c28xabi_ultod	Convert an unsigned 32-bit integer to a double-precision floating number.
__c28xabi_ultof	Convert an unsigned 32-bit integer to a single-precision floating number.
__c28xabi_utod	Convert an unsigned 16-bit integer to a double-precision floating number.
__c28xabi_utof	Convert an unsigned 16-bit integer to a single-precision floating number.
__c28xabi_xorll	Bitwise XOR for two long long integer values.

## 6.3 Floating-Point Helper Functions for C99

These functions are unimplemented, but the names are reserved for use by a C99 compiler. The TI library does not currently implement these functions. The API relating to C99 is subject to change.

**Table 6-2. Reserved Floating-Point Classification Helper Functions**

Signature	Description
int32 __C28x_isfinite(float64 x);	True iff x is a representable value
int32 __C28x_isfinitef(float32 x);	True iff x is a representable value
int32 __C28x_isinf(float64 x);	True iff x represents "infinity"
int32 __C28x_isinff(float32 x);	True iff x represents "infinity"
int32 __C28x_isnan(float64 x);	True iff x represents "not a number"
int32 __C28x_isnanf(float32 x);	True iff x represents "not a number"
int32 __C28x_isnormal(float64 x);	True iff x is not denormalized
int32 __C28x_isnormalf(float32 x);	True iff x is not denormalized
int32 __C28x_fpclassify(float64 x);	Classify floating-point value
int32 __C28x_fpclassifyf(float32 x);	Classify floating-point value





The following sections describe any conventions that apply to the C standard header files. These issues cover any requirements that are not specified in the ANSI C standard but which must be followed in order for a toolchain to support the C28x ABI.

7.1 About Standard C Libraries.....	42
7.2 Reserved Symbols.....	42
7.3 <assert.h> Implementation.....	42
7.4 <complex.h> Implementation.....	42
7.5 <ctype.h> Implementation.....	43
7.6 <errno.h> Implementation.....	43
7.7 <float.h> Implementation.....	43
7.8 <inttypes.h> Implementation.....	43
7.9 <iso646.h> Implementation.....	43
7.10 <limits.h> Implementation.....	44
7.11 <locale.h> Implementation.....	44
7.12 <math.h> Implementation.....	44
7.13 <setjmp.h> Implementation.....	45
7.14 <signal.h> Implementation.....	45
7.15 <stdarg.h> Implementation.....	45
7.16 <stdbool.h> Implementation.....	45
7.17 <stddef.h> Implementation.....	45
7.18 <stdint.h> Implementation.....	46
7.19 <stdio.h> Implementation.....	46
7.20 <stdlib.h> Implementation.....	46
7.21 <string.h> Implementation.....	47
7.22 <tgmath.h> Implementation.....	47
7.23 <time.h> Implementation.....	47
7.24 <wchar.h> Implementation.....	47
7.25 <wctype.h> Implementation.....	47

## 7.1 About Standard C Libraries

Toolchains typically include standard libraries for the language they support, such as C, C99, or C++. These libraries have compile-time components (header files) and runtime components (variables and functions). This section discusses header file and library compatibility.

Implementations that adhere to this ABI must conform to the C standard, and must produce object files that are compatible with those produced by another implementation.

During compilation, the compiler and the library header files are required to be from the same implementation. During linking, the linker and library are required to be from the same implementation, which may be different from the implementation of the compiler. The C28x EABI further requires that modules compiled using the header files from one implementation are compatible with the library from another implementation. This is called "header file compatibility." This requirement imposes additional limitations on the library header files beyond what is specified in the C standard.

The C28x is designed based on the ARM EABI. You can read the *C Library ABI for the ARM Architecture* document [on the ARM Infocenter website](#) for background and comments about how the standard C library should be implemented for EABI. The details that apply to ARM do not necessarily apply for C28x. See the chapter on "The C Library Section by Section" in that document.

## 7.2 Reserved Symbols

A number of symbols are reserved for use in the RTS library as described for the ABI. These include the following:

- `_ftable`
- `_ctypes_`

In addition, any symbols listed in [Section 11.4.4](#) or symbols with the prefixes listed in [Section 11.1](#) are reserved.

## 7.3 <assert.h> Implementation

The library must implement `assert` as a macro. If its expression argument is false, it must eventually call a helper function to print the failure message. Whether or not the helper function actually causes something to be printed is implementation-defined. As specified by the C standard, this helper function must terminate by calling `abort`. See [Section 6.2](#).

## 7.4 <complex.h> Implementation

The C99 standard requires that a complex number be represented as a struct containing one array of two elements of the corresponding real type. Element 0 is the real component, and element 1 is the imaginary component. For instance, `_Complex double` is:

```
{ double _val[2]; } /* where 0=real 1=imag */
```

TI's C28x toolset supports the C99 complex numbers and provides this header file.

## 7.5 <ctype.h> Implementation

The ctype.h functions are locale-dependent and therefore may not be inlined. These functions include:

- isalnum
- isalpha
- isblank (a C99 function; this is not yet provided by the TI toolset)
- iscntrl
- isdigit
- isgraph
- islower
- isprint
- ispunct
- isspace
- isupper
- isxdigit
- isascii (obsolete function, not a standard C99 function)
- toupper (currently inlined by the TI compiler, but subject to change)
- tolower (currently inlined by the TI compiler, but subject to change)
- toascii (obsolete function, not a standard C99 function)

## 7.6 <errno.h> Implementation

The following are some of the constants defined for used with errno. See the errno.h file for a complete list.

```
#define EDOM 0x21
#define ERANGE 0x22
#define EILSEQ 0x58
#define ENOENT 0x2
#define EFPOS 0x98
```

## 7.7 <float.h> Implementation

The macros in this file are defined in the natural way. Float is IEEE-32; double and long double are IEEE-64.

## 7.8 <inttypes.h> Implementation

The macros, functions and typedefs in this file are defined in the natural way according to the integer types of the architecture. See [Section 2.1](#).

## 7.9 <iso646.h> Implementation

The macros in this file are fully specified by the C standard and are defined in the natural way.

## 7.10 <limits.h> Implementation

Aside from MB\_LEN\_MAX, the macros in this file are defined in the natural way according to the integer types of the architecture. See [Section 2.1](#).

MB\_LEN\_MAX is defined as follows:

```
#define MB_LEN_MAX 1
```

## 7.11 <locale.h> Implementation

TI's toolset provides only the "C" locale. The LC\_\* macros are defined as follows:

```
#define LC_ALL      0
#define LC_COLLATE 1
#define LC_CTYPE   2
#define LC_MONETARY 3
#define LC_NUMERIC 4
#define LC_TIME     5
```

The order of the fields in the lconv struct is as follows:

(These are the C89 fields. Additional fields added for C99 are not included.)

```
char *decimal_point;
char *grouping;
char *thousands_sep;
char *mon_decimal_point;
char *mon_grouping;
char *mon_thousands_sep;
char *negative_sign;
char *positive_sign;
char *currency_symbol;
char frac_digits;
char n_cs_precedes;
char n_sep_by_space;
char n_sign_posn;
char p_cs_precedes;
char p_sep_by_space;
char p_sign_posn;
char *int_curr_symbol;
char int_frac_digits;
```

## 7.12 <math.h> Implementation

The macros defined by this library must be floating-point constants (not library variables).

- HUGE\_VALF must be float infinity.
- HUGE\_VAL must be double infinity.
- HUGE\_VALL must be long double infinity.
- INFINITY must be float infinity.
- NAN must be quiet NaN.
- MATH\_ERRNO is not currently specified.
- MATH\_ERREXCEPT is not currently specified.

The following FP\_\* macros are defined:

```
#define FP_INFINITE 1
#define FP_NAN      2
#define FP_NORMAL   (-1)
#define FP_SUBNORMAL (-2)
#define FP_ZERO     0
```

The other FP\_\* macros are not currently specified.

### 7.13 <setjmp.h> Implementation

The type and size of jmp\_buf are defined in setjmp.h

For non-FPU targets, jmp\_buf is typically 5 words long and is long-aligned. For FPU targets, jmp\_buf is 9 words long and is long-aligned.

The setjmp and longjmp functions must not be inlined because jmp\_buf is opaque. That is, the fields of the structure are not defined by the standard, so the internals of the structure are not accessible except by setjmp() and longjmp(), which must be out-of-line calls from the same library. These functions cannot be implemented as macros.

### 7.14 <signal.h> Implementation

TI's toolset does not implement the signal library function.

TI's toolset creates the following typedef for "int".

```
typedef int sig_atomic_t;
```

TI's toolset defines the following constants:

```
#define SIG_DFL ((void (*)(int)) 0)
#define SIG_ERR ((void (*)(int)) -1)
#define SIG_IGN ((void (*)(int)) 1)
#define SIGABRT 6
#define SIGFPE 8
#define SIGILL 4
#define SIGINT 2
#define SIGSEGV 11
#define SIGTERM 15
```

### 7.15 <stdarg.h> Implementation

Only the type va\_list shows up in the interface. Macros are used to implement va\_start, va\_arg, and va\_end. See [Chapter 3](#) for the format of the arguments in va\_list.

Upon a call to a variadic C function declared with an ellipsis (...), the last declared argument and any additional arguments are passed on the stack as described in [Section 3.3](#) and accessed using the macros in <stdarg.h>. The macros use a persistent argument pointer initialized via an invocation of va\_start and advanced via invocations of va\_arg. The following conventions apply to implementation of these macros.

- The type of va\_list is char\*.
- Invocation of the macro va\_start(ap, parm) sets ap to point 1 byte past the last (greatest) address allocated to parm.
- Each successive invocation of va\_arg(ap, type) leaves ap pointing 1 byte past the last address reserved for the argument object indicated by type.

### 7.16 <stdbool.h> Implementation

For C++, the type "bool" is a built-in type.

For C99, the type "\_Bool" is a built-in type. For C99, the header file stdbool.h defines a macro "bool" which expands to \_Bool.

Each of these types is represented as an 8-bit unsigned type.

### 7.17 <stddef.h> Implementation

The size and alignment of each type defined instddef.h is defined in [Section 2.4](#).

## 7.18 <stdint.h> Implementation

The macros and typedefs in this header file are defined in the natural way according to the integer types of the architecture. See [Section 2.1](#).

## 7.19 <stdio.h> Implementation

The TI toolset defines the following constants for use with the stdio.h library:

```
#define _IOFBF 1
#define _IOLBF 2
#define _IONBF 4
#define BUFSIZ 256
#define EOF (-1)
#define FOPEN_MAX
#define FILENAME_MAX
#define TMP_MAX
#define L_tmpnam
#define SEEK_SET 0
#define SEEK_CUR 1
#define SEEK_END 2
#define stdin &_ftable[0]
#define stdout &_ftable[1]
#define stderr &_ftable[2]
```

The FOPEN\_MAX, FILENAME\_MAX, TMP\_MAX, and L\_tmpnam values are actually minimum maxima. The library is free to provide support for more/larger values, but must at least provide the specified values.

Because the TI toolset defines stdout and stderr as &\_ftable[1] and &\_ftable[2], the size of FILE must be known to the implementation.

In the TI header files, stdin, stdout, and stderr expand to references into the array \_ftable. To successfully interlink with such files, any other implementations need to implement the FILE array with exactly that name. The C28x EABI does not have a "compatibility mode" (like the mode in the ARM EABI) in which stdin, stdout, and stderr are link-time symbols, not macros. The lack of a compatibility mode means that linkers that need to interlink with a module that refers to stdin directly need to support \_ftable.

If a program does not use the stdin, stdout, or stderr macros (or a function implemented as a macro that refers to one of these macros), there are no issues with the FILE array.

C I/O functions commonly implemented as macros—getc, putc, getchar, putchar—must not be inlined.

The fpos\_t type is defined as a long.

## 7.20 <stdlib.h> Implementation

The TI toolset defines the stdlib.h structures as follows:

```
typedef struct { int quot; int rem; } div_t;
typedef struct { long int quot; long int rem; } ldiv_t;
typedef struct { long long int quot; long long int rem; } lldiv_t;
```

The TI toolset defines constants for use with the stdlib.h library as follows:

```
#define EXIT_SUCCESS 0
#define EXIT_FAILURE 1
#define MB_CUR_MAX 1
```

The results of the rand function are not defined by the ABI specification.

This ABI specification does not require a library to implement either the getenv or system function. The TI toolset does provide a getenv function, which requires debugger support. The TI toolset does not provide a system function.

### 7.21 <string.h> Implementation

The strtok function must not be inlined, because it has a static state. The strcoll and strxfrm functions also must not be inlined, because they depend on the locale.

### 7.22 <tgmath.h> Implementation

The C99 standard completely specifies this header file. The TI toolset does not provide this header file.

### 7.23 <time.h> Implementation

Some typedefs and constants defined for this library are dependent on the execution environment. In order to make code portable, the code must not make assumptions about the type and range of time\_t or clock\_t.

The type for CLOCKS\_PER\_SEC is clock\_t.

### 7.24 <wchar.h> Implementation

The TI toolset defines the following type and constant for use with this library:

```
typedef int wint_t;  
#define WEOF ((wint_t)-1)
```

The type mbstate\_t is the size and alignment of int .

### 7.25 <wctype.h> Implementation

The TI toolset defines the following types for use with this library:

```
typedef void * wctype_t;  
typedef void * wctrans_t;
```

This page intentionally left blank.





The C++ ABI specifies aspects of the implementation of the C++ language that must be standardized in order for code from different toolchains to interoperate. The C28x C++ ABI is based on the Generic C++ ABI originally developed for IA-64 but now widely adopted among C++ toolchains, including GCC. The base standard, referred to as “GC++ABI”, can be found at <http://refspecs.linux-foundation.org/cxxabi-1.83.html>.

This section documents additions to and deviations from that base document.

8.1 Limits (GC++ABI 1.2).....	50
8.2 Export Template (GC++ABI 1.4.2).....	50
8.3 Data Layout (GC++ABI Chapter 2).....	50
8.4 Initialization Guard Variables (GC++ABI 2.8).....	50
8.5 Constructor Return Value (GC++ABI 3.1.5).....	50
8.6 One-Time Construction API (GC++ABI 3.3.2).....	50
8.7 Controlling Object Construction Order (GC++ ABI 3.3.4).....	50
8.8 Demangler API (GC++ABI 3.4).....	50
8.9 Static Data (GC++ ABI 5.2.2).....	51
8.10 Virtual Tables and the Key function (GC++ABI 5.2.3).....	51
8.11 Unwind Table Location (GC++ABI 5.3).....	51

## 8.1 Limits (GC++ABI 1.2)

The GC++ABI constrains the offset of a non-virtual base subobject in the full object containing it to be representable by a 56-bit signed integer, due to the RTTI implementation. For the C28x family, the constraint is reduced to 24 bits. This implies a practical limit of  $2^{23} - 1$  (or 0x7ffff) bytes on the size of a base class.

## 8.2 Export Template (GC++ABI 1.4.2)

Export templates are not currently specified by the ABI.

## 8.3 Data Layout (GC++ABI Chapter 2)

The layout of POD (Plain Old Data), is specified in [Chapter 2](#) of this document. The layout of non-POD data is as specified by the base document. There is a minor exception for bit fields, which are covered in [Section 2.8](#).

## 8.4 Initialization Guard Variables (GC++ABI 2.8)

The guard variable is a one-byte field stored in the first byte of a 16-bit container. A non-zero value of the guard variable indicates that initialization is complete. This follows the IA-64 scheme, except the container is 16 bits instead of 64.

This is a reference implementation of the helper function `__cxa_guard_acquire`, which reads the guard variable and returns 1 if the initialization is not yet complete, 0 otherwise:

```
int __cxa_guard_acquire(unsigned int *guard)
{
    char *first_byte = (char *)guard;
    return (*first_byte == 0) ? 1 : 0;
}
```

This is a reference implementation of the helper function `__cxa_guard_release`, which modifies the guard object to signal that initialization is complete:

```
void __cxa_guard_release(unsigned int *guard)
{
    char *first_byte = (char *)guard;
    *first_byte = 1;
}
```

## 8.5 Constructor Return Value (GC++ABI 3.1.5)

The C28x follows the ARM EABI, under which the C1 and C2 constructors return the *this* pointer. Doing so allows tail-call optimization of calls to these functions.

Similarly, non-virtual calls to D1 and D2 destructors return 'this'. Calls to virtual destructors use thunk functions, which do not return 'this'.

Section 3.3 of the GC++ABI specifies several library helper functions for array new and delete, which take pointers to constructors or destructors as parameters. In the GC++ABI these parameters are declared as pointers to functions returning void, but in the C28x ABI they are declared as pointers to functions that return void \*, corresponding to 'this'.

## 8.6 One-Time Construction API (GC++ABI 3.3.2)

The guard variable is an 8-bit field stored in the first byte of a 16-bit container. See [Section 8.4](#).

## 8.7 Controlling Object Construction Order (GC++ ABI 3.3.4)

The C28x ABI does not specify a mechanism to control object construction.

## 8.8 Demangler API (GC++ABI 3.4)

The C28x ABI suspends the requirement for an implementation to provide the function `__cxa_demangle`, which provides a run-time interface to the demangler.

## 8.9 Static Data (GC++ ABI 5.2.2)

The GC++ ABI requires that a static object referenced by an inline function be defined in a COMDAT group. If such an object has an associated guard variable, then the guard variable must also be defined in a COMDAT group. The GC++ABI permits the static variable and its guard variable to be in different groups, but discourages this practice. The C28x ABI forbids it altogether; the static variable and its guard variable must be defined in a single COMDAT group with the static variable's name as the signature.

## 8.10 Virtual Tables and the Key function (GC++ABI 5.2.3)

The GC++ABI defines a class's key function, whose definition triggers creation of the virtual table for that class, to be the first non-pure virtual function that is not inline *at the point of class definition*. The C28x ABI modifies this to be the first non-pure virtual function that is not inline *at the end of the translation unit*. In other words, an inline member is not a key function if it is first declared inline after the class definition.

## 8.11 Unwind Table Location (GC++ABI 5.3)

Exception handling is covered in [Chapter 9](#) of this document.

This page intentionally left blank.



The C28x EABI employs table-driven exception handling (TDEH). TDEH implements exception handling for languages that support exceptions, such as C++.

TDEH uses tables to encode information needed to handle exceptions. The tables are part of the program's read-only data. When an exception is thrown, the exception handling code in the runtime support library propagates the exception by *unwinding* the stack to the stack frame representing a function with a catch clause that will catch the exception. As the stack is unwound, locally-defined objects must be destroyed (by calling the destructor) along the way. The tables encode information about how to unwind the stack, which objects to destroy when, and where to transfer control when the exception is finally caught.

TDEH tables are generated into executable files by the linker, using information generated into relocatable files by the compiler. This section specifies the format and encoding of the tables, and how the information is used to propagate exceptions. An ABI-conforming toolchain must generate tables in the format specified here.

<b>9.1 Overview</b> .....	<b>54</b>
<b>9.2 PREL31 Encoding</b> .....	<b>54</b>
<b>9.3 The Exception Index Table (EXIDX)</b> .....	<b>55</b>
<b>9.4 The Exception Handling Instruction Table (EXTAB)</b> .....	<b>56</b>
<b>9.5 Unwinding Instructions</b> .....	<b>57</b>
<b>9.6 Descriptors</b> .....	<b>60</b>
<b>9.7 Special Sections</b> .....	<b>62</b>
<b>9.8 Interaction With Non-C++ Code</b> .....	<b>62</b>
<b>9.9 Interaction With System Features</b> .....	<b>63</b>
<b>9.10 Assembly Language Operators in the TI Toolchain</b> .....	<b>63</b>

## 9.1 Overview

The C28x's exception handling table format and mechanism is based on that of the ARM processor family, which itself is based on the IA-64 Exception Handling ABI (<http://www.codesourcery.com/public/cxx-abi/abi-eh.html>). This section focuses on the C28x-specific portions.

TDEH data consists of three main components: the EXIDX, the EXTAB, and catch and cleanup blocks.

The Exception Index Table (EXIDX) maps program addresses to entries in the Exception Action Table (EXTAB). All addresses in the program are covered by the EXIDX.

The EXTAB encodes instructions which describe how to unwind a stack frame (by restoring registers and adjusting the stack pointer) and which catch and cleanup blocks to invoke when an exception is propagated.

Catch and cleanup blocks (collectively known as *landing pads*) are code fragments that perform exception handling tasks. Cleanup blocks contain calls to destructor functions. Catch blocks implement catch clauses in the user's code. These blocks are only executed when an exception actually gets thrown. These blocks are generated for a function when the rest of the function is generated, and execute in the same stack frame as the function, but may be placed in a different section.

## 9.2 PREL31 Encoding

Some fields of the EXIDX and EXTAB tables need to record program memory addresses or pointers to other locations in the tables, both of which are typically in code or read-only segments. To facilitate position independence, this is done using a special-purpose PC-relative relocation called R\_C28x\_PREL31, abbreviated here as PREL31. A PREL31 field is encoded as a scaled, signed 31-bit offset which occupies the least significant 31 bits of a 32-bit word. The remaining (most significant) bit is used for different purposes in different contexts. The relocated address to which the field refers is found by left-shifting the encoded offset by 1 bit and adding it to the address of the field.

### 9.3 The Exception Index Table (EXIDX)

When a throw statement is seen in the source code, the compiler generates a call to a runtime support library function named `__cxa_throw`. When the throw is executed, the return address for the `__cxa_throw` call site is used to identify which function is throwing the exception. The library searches for the return address in the EXIDX table.

Each entry in the table represents the exception handling behavior of a range of program addresses, which may be one or several functions that share exactly the same exception handling behavior. Each entry encodes the start of a program address range, and is considered to cover all program addresses until the address encoded in the next entry. The linker may combine adjacent functions with identical behavior into one entry.

Each entry consists of two 32-bit words. The first word of each entry is a PREL31 field representing the starting program address of the function or functions. Bit 31 of the first word shall be 0. The second word has one of three formats, depending on bit 31 of the second word. If bit 31 is 0, the second word is either a PREL31 pointer to an EXTAB entry somewhere else in memory or the special value `EXIDX_CANTUNWIND`. If bit 31 is 1, the second word is an inlined EXTAB entry. These three formats are detailed in the subsections that follow.

#### 9.3.1 Pointer to Out-of-Line EXTAB Entry

In this format, the second word of the EXIDX table entry contains 0 in the top bit and the PREL-31-encoded address of the EXTAB entry for this address range in the other bits.

31	30-0
0	PREL31 Representation of function address
0	PREL31 Representation of EXTAB entry

#### 9.3.2 EXIDX\_CANTUNWIND

As a special case, if the second word of the EXIDX has the value `0x1`, the EXIDX represents `EXIDX_CANTUNWIND`, indicating that the function cannot be unwound at all. If an exception tries to propagate through such a function, the unwinder calls `abort` or `std::terminate`, depending on the language.

31	30-0
0	PREL31 Representation of function address
<b>0x00000001 (EXIDX_CANTUNWIND)</b>	

#### 9.3.3 Inlined EXTAB Entry

If the entire EXTAB entry for this function is small enough, it is placed in the second EXIDX word and the upper bit is set to one. The second word uses the same encoding as the EXTAB compact model described in [Section 9.4](#), but with no descriptors and no terminating NULL. This saves 4 bytes that would have been a pointer to an out-of-line EXTAB entry plus 4 bytes for the terminating NULL.

31	30-28	27-24	23-0
0	PREL31 Representation of function address		
1	000	PR Index	Data for personality routine specified by 'index'

## 9.4 The Exception Handling Instruction Table (EXTAB)

Each EXTAB entry is one or more 32-bit words that encode frame unwinding instructions and descriptors to handle catch and cleanup. The first word describes that entry's *personality*, which is the format and interpretation of the entry.

When an exception is thrown, EXTAB entries are decoded by “personality routines” provided in the runtime support library. Personality routines specified by the ABI are listed in [Table 9-1](#).

### 9.4.1 EXTAB Generic Model

A generic EXTAB entry is indicated by setting bit 31 of the first word to 0. The first word has a PREL31 entry representing the address of the personality routine. The rest of the words in the EXTAB entry are data that are passed to the personality routine.

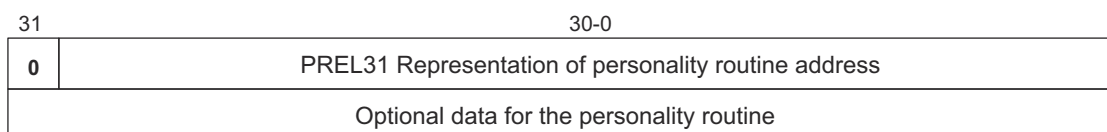

The format of the optional data is up to the discretion of the personality routine, but the length must be an integer multiple of whole 32-bit words. The unwinder calls the personality routine, passing it a pointer to the first word of optional data.

### 9.4.2 EXTAB Compact Model

A compact EXTAB entry is indicated by a 1 in bit 31 of the first word. (When an EXTAB entry is encoded into the second word of an EXIDX entry, the compact form is always used.) In the compact form, the personality routine is encoded by a 4-bit PR index in the first byte of the entry. The remaining 3 bytes contain unwinding instructions as specified by the personality routine. In a non-inlined EXTAB entry, additional data is provided in additional successive 32-bit words: any additional unwinding instructions, followed optionally by action descriptors, terminated with a NULL word.

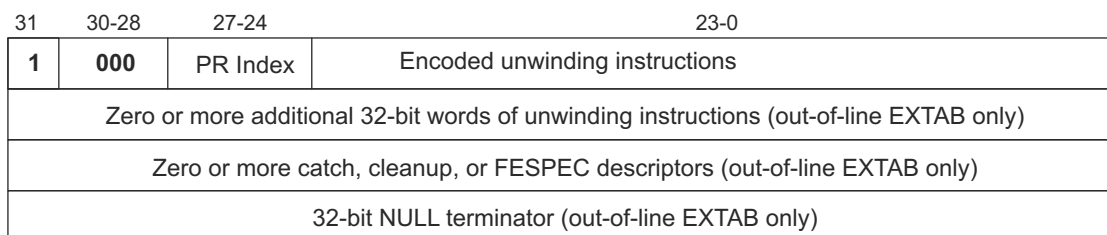



### 9.4.3 Personality Routines

The C28x has the following ABI-specified personality routines. They have the same format as the ARM EABI. The following table specifies the personality routines and their PR indexes.

**Table 9-1. C28x TDEH Personality Routines**

PR Index (bits 27-24)	Personality	Routine Name	Unwind Instructions	Width of Scope Fields	Notes
0000	PR0 (Su16)	__C28x_unwind_cpp_pr0	Up to 3 one-byte instructions	16	
0001	PR1 (Lu16)	__C28x_unwind_cpp_pr1	Unlimited onebyte instructions	16	
0010	PR2 (Lu32)	__C28x_unwind_cpp_pr2	Unlimited onebyte instructions	32	Must be used if 16-bit scope fields will not reach

When using compact model EXTAB entries, a relocatable file must explicitly indicate which routines it depends on by including a reference from the EXTAB's section to the corresponding personality routine symbol, in the form of a R\_C28x\_NONE relocation.

## 9.5 Unwinding Instructions

Unwinding a frame is performed by simulating the function's epilog. Any operation that may be performed in a function's epilog needs to be encoded in the EXTAB entry so that the stack unwinder can decode the information and simulate the epilog.

The unwinding instructions make assumptions about the stack layout; in particular, *callee-saved register safe debug order* is always assumed.

### 9.5.1 Common Sequence

Abstractly, all unwinding sequences take the following form:

1. Restore SP (SP += constant)
2. (Optional) Restore callee-saved registers (reg1 := SP[0]; reg2 := SP[-1]; and so on)
3. Return

#### Step 1: Restore SP

An actual epilog does not restore SP until after the callee-saved registers are restored, but because stack unwinding is a virtual operation, the simulated unwinding of TDEH may perform the SP restore first. This simplifies the restoration of the other callee-saved registers.

SP will be restored by incrementing by a constant. In addition to the explicit increment, the SP is implicitly incremented to account for the size of the callee-saved area.

#### Step 2: Restore Registers

Abstractly, the callee-saved registers are restored in *register safe debug order* ([Section 4.6.2](#)) starting with the location pointed to by (the old) SP and moving to lower addresses.

#### Step 3: Return

Every unwinding sequence ends with an implicit or explicit "RET ", which indicates that unwinding is complete for the current frame.

### 9.5.2 Byte-Encoded Unwinding Instructions

Personality routines PR0, PR1, and PR2 use a byte-encoded sequence of instructions to describe how to unwind the frame. The first few instructions are packed into the three remaining bytes of the first word of the EXTAB; additional instructions are packed into subsequent words. Unused bytes in the last word are filled with "RET " instructions.

Although the instructions are byte-encoded, they are always packed into 32-bit words starting at the MSB. As a consequence, the first unwinding instruction will not be at the lowest-addressed byte in little-endian mode.

Personality routine PR0 allows at most three unwinding instructions, all of which are stored in the first EXTAB word. If there are more than three unwinding instructions, one of the other personality routines must be used.

31	30-28	27-24	23-16	15-8	7-0
1	000	0000 (PR0)	First unwind instruction	Second unwind instruction	Third unwind instruction
Optional descriptors					
NULL					

For PR1 and PR2, bits 23-16 encode the number of extra 32-bit words of unwinding instructions, which can be 0.

31	30-28	27-24	23-16	15-8	7-0
1	000	PR Index	Number of additional unwinding words	First unwind instruction	Second unwind instruction
Third unwind instruction		Fourth unwind instruction		...	...
Optional descriptors					
NULL					

[Table 9-2](#) summarizes the unwinding instruction set. Each instruction is described in more detail after the table.

**Table 9-2. Stack Unwinding Instructions**

Encoding	Instruction	Description
0000 0xxx	POP (XAR1-XAR3) + RET	(or just RET if x=0)
0000 1000 0xxx xxxx	POP (XAR1-XAR3, R4-R7) + RET	(or just RET if x=0)
0000 1yyy yxxx xxxx		reserved (where yyyy not 0)
0001 0000		cannot unwind (function may catch but not propagate)
0001 0001 xxxx xxxx	SP -= (ULEB128 << 1) + 512;	range is [514, max]
0001 001x		reserved
0001 01xx		reserved
0001 1xxx		reserved
001x xxxx		reserved
01xx xxxx		reserved
1xxx xxxx	SP -= (xxxxxxx << 1) + 2;	range is [2, 256]

The following restrictions apply:

- The stack must be aligned to 32 bits at all times in C/C++ callable functions that may propagate C++ exceptions.
- The program may not place code or data above 0x80000000. Doing so will give a relocation error.

All other bit patterns are reserved.

The following paragraphs detail the interpretation of the unwinding instructions.

### POP + RET

The POP+RET instruction specifies a bitmask representing registers saved by this function's prolog. These registers must be popped in order, starting with XAR1 through XAR3. If FPU is enabled, R4 through R7 are

then popped in order. When that is complete, there are no more unwinding instructions. If none of the bits in the bitmask are set, this is simply a RET instruction.

### Small Increment

7	6	5	4	3	2	1	0
1	1	k	k	k	k	k	k

The value of k is extracted from the lower 6 bits of the encoding. This instruction can increment the SP by a value in the range 0x8 to 0x200, inclusive. Increments in the range 0x208 to 0x400 should be done with two of these instructions.

### Large Increment

7	6	5	4	3	2	1	0
1	0	0	0	0	0	0	1
k	k	k	k	k	k	k	k
...							

The value ULEB128 is ULEB128-encoded in the bytes following the 8-bit opcode. This instruction can increment the SP by a value of 0x408 or greater. Increments less than 0x408 should be done with one or two Small Increment instructions.

### CANTUNWIND

7	6	5	4	3	2	1	0
1	0	0	0	0	0	0	0
0	0	0	0	0	0	0	0

This instruction indicates that the function cannot be unwound, usually because it is an interrupt function. However, an interrupt function can still have try/catch code, so EXIDX\_CANTUNWIND is not appropriate.

## 9.6 Descriptors

If any local objects need to be destroyed, or if the exception is caught by this function, the EXTAB contains *descriptors* describing what to do and for which exception types.

If present, the descriptors follow the unwinding instructions. The format of the descriptors is a sequence of descriptor entries followed by a 32-bit zero (NULL) word. Each descriptor starts with a *scope*, which identifies what kind of descriptor it is and specifies a program address range within which the descriptor applies. Additional descriptor-specific words follow the scope.

Descriptors shall be listed in depth-first order so that all of the applicable descriptors can be handled in one pass.

The general form for an EXTAB entry with descriptors is:

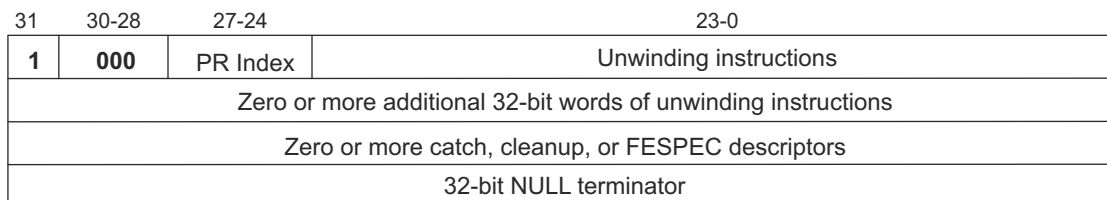

### 9.6.1 Encoding of Type Identifiers

Catch descriptors and FESPEC descriptors ([Section 9.6.5](#)) encode type identifiers to be used in matching the type of thrown objects against catch clauses and exception specifications. These fields are encoded to reference the `type_info` object corresponding to the specified type.

### 9.6.2 Scope

The scope identifies the descriptor type and specifies a program address range in which an action should take place. The range corresponds to a potentially-throwing call site. The unwinder looks through the descriptor list for descriptors containing a scope containing the call site; once a match is found, the descriptor is activated.

The scope encodes a program address range by specifying an offset from the starting address of the function and a length, both in bytes. If the length and offset each fit in a 15-bit unsigned field, the scope uses the short form encoding and the rest of the EXTAB entry can be encoded for PR0 or PR1. If either the length or offset exceed 15-bits, the scope uses the long form encoding and PR2 must be used.

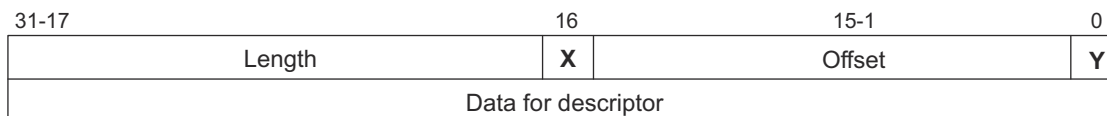

**Figure 9-1. Short Form Scope**

The short form scope may not be used with PR2 (Lu32).

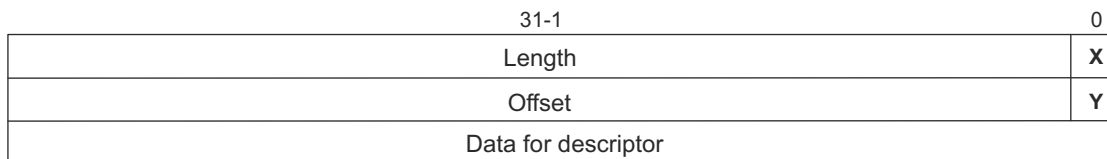

**Figure 9-2. Long Form Scope**

If the length or offset require the long form scope, personality routine PR2 (Lu32) must be used.

Bits X and Y in the scope encodings indicate the kind of descriptor that follows the scope:

X	Y	Descriptor
0	0	Cleanup descriptor
1	0	Catch descriptor
0	1	Function exception specification (FESPEC) descriptor

### 9.6.3 Cleanup Descriptor

Cleanup descriptors control destruction of local objects which are fully constructed and are about to go out of scope, and thus must be destructed.

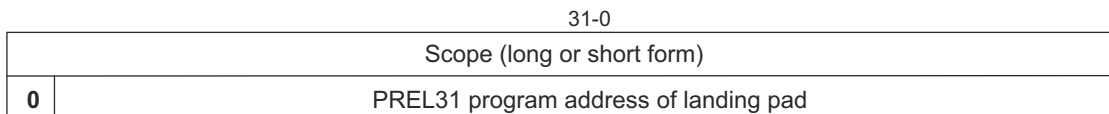

The cleanup descriptor simply contains a single pointer to a cleanup code block containing one or more calls to destructor functions.

### 9.6.4 Catch Descriptor

Catch descriptors control which exceptions are caught, and when. A function may have several catch clauses which each apply to a different subset of potentially-throwing function calls. One call site can have multiple catch descriptors, each with a different type.

If the type in the catch descriptor matches the thrown type, control is transferred to the *landing pad*, which is just a code fragment representing a catch block. Catch blocks implement *catch* clauses in the user's code. These blocks are only executed when an exception actually gets thrown. These blocks are generated for a function when the rest of the function is generated, and execute in the same stack frame as the function, but may be placed in a different section.

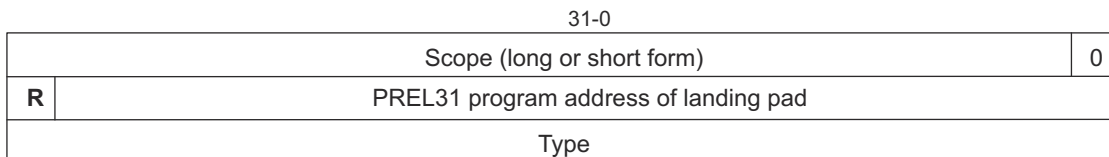

If bit R is 1, the type of the catch clause is a reference type represented by TYPE. If bit R is 0, the type is not a reference type.

The type field is either a reference to a `type_info` object or one of two special values:

- The special value `0xFFFFFFFF` (-1) means the *any* type ["catch(...)"].
- The special value `0xFFFFFFFFE` (-2) means the *any* type ["catch(...)"], and also indicates that the personality routine should immediately return `_URC_FAILURE`. In this case, the landing pad address should be set to 0. This idiom may be used to prevent exception propagation out of the code covered by that scope.

### 9.6.5 Function Exception Specification (FESPEC) Descriptor

FESPEC descriptors enforce `throw()` declarations in the user's code. If a `throw` declaration is used, a FESPEC descriptor will be created for this function to ensure that only those types listed are thrown. If a type not listed is thrown, the unwinder will typically call `std::unexpected` (but there are exceptions).

31-0	
Scope (long or short form)	
D	Number of type info pointers
Reference to type_info object	
Reference to type_info object	
...	
0	(if D == 1) PREL31 program address of landing pad

The first word of the descriptor consists of a 31-bit unsigned integer, which specifies the number of `type_info` fields that follow.

If bit D is 1, the `type_info` list is followed by a 32-bit word containing a PREL31 program address of a code fragment which is called if no type in the list matches the thrown type. Bit 31 of this word is set to 0.

If bit D is 0, and no type in the list matches the thrown type, the unwinding code should call `__cxa_call_unexpected`. If any descriptors match this form, the EXTAB section must contain a `R_C28x_NONE` relocation to `__cxa_call_unexpected`.

## 9.7 Special Sections

All of the exception handling tables are stored in two sections. The EXIDX table is stored in a section called `.C28x.exidx` with type `SHT_C28x_UNWIND`. The linker must combine all the input `.C28x.exidx` sections into one contiguous `.C28x.exidx` output section, maintaining the same relative order as the code sections they refer to. In other words, the entries in the EXIDX table are sorted by address. Each EXIDX section in a relocatable file must have the `SHF_LINK_ORDER` flag set to indicate this requirement.

The EXTAB is stored in a section called `.C28x.extab`, with type `SHT_PROGBITS`. The EXTAB is not required to be contiguous and there is no ordering requirement.

Exception tables can be linked anywhere in memory.

## 9.8 Interaction With Non-C++ Code

### 9.8.1 Automatic EXIDX Entry Generation

Functions which do not have an EXIDX entry will have one created for them automatically by the linker, so functions from a library compiled without exception-handling enabled (such as a C-only library) can be used in an application which uses TDEH. Automatically-generated entries will be `EXIDX_CANTUNWIND`, so if a function compiled without exception-handling support enabled calls a function which does propagate an exception, `std::terminate` will be called and the application will halt.

### 9.8.2 Hand-Coded Assembly Functions

Hand-coded assembly functions can be instrumented to handle or propagate exceptions. This is only necessary if the function calls a function which might propagate an exception, and this exception must be propagated out of the assembly function. The user must create an appropriate EXIDX entry and an EXTAB containing at least the unwinding instructions.

## 9.9 Interaction With System Features

### 9.9.1 Shared Libraries

The exception-handling tables can propagate exceptions within an executable. Propagating an exception across calls between different load modules requires help from the OS.

### 9.9.2 Overlays

C++ functions which may propagate exceptions must not be part of an overlay. The EXIDX lookup table does not handle overlay functions, and it could not distinguish between the different possible functions at a particular location.

### 9.9.3 Interrupts

Interrupts, hardware exceptions, and OS signals cannot be handled directly by exceptions.

Because interrupt functions could happen anywhere, we cannot support propagating exceptions from interrupt functions. All interrupt functions will be EXIDX\_CANTUNWIND. However, interrupt functions can call functions which might themselves throw exceptions, and thus interrupt functions must be in the EXIDX table and may have descriptors, but will never have unwinding instructions.

Applications which wish to use an exception to represent interrupts must arrange for the interrupt to be caught with an interrupt function, which must set a global volatile object to indicate that the interrupt has occurred, and then use the value of that variable to throw an exception after the interrupt function has returned.

If an OS provides signal, exceptions representing signals must be handled similarly.

## 9.10 Assembly Language Operators in the TI Toolchain

These implementation details pertain to the TI toolchain and are not part of the ABI.

The TI compiler uses special built-in assembler functions to indicate to the assembler that certain expressions in the exception-handling tables should get special processing.

### **\$EXIDX\_FUNC**

The argument is a function address to be encoded using the PREL31 representation.

### **\$EXIDX\_EXTAB**

The argument is an EXTAB label to be encoded using the PREL31 representation.

### **\$EXTAB\_LP**

The argument is a landing pad label to be encoded using the PREL31 representation.

### **\$EXTAB\_RTTI**

The argument is the label for the unique type\_info object representing a type. (These objects are generated for run-time type identification.)

### **\$EXTAB\_SCOPE**

The argument is an offset into a function. This expression will be used in a scope descriptor to indicate during which portions of the functions it should be applied.

This page intentionally left blank.





The C28x uses the DWARF Debugging Information Format Version 3, also known as DWARF3, to represent information for a symbolic debugger in object files. DWARF3 is documented in <http://www.dwarfstd.org/doc/Dwarf3.pdf>. This section augments that standard by specifying parts of the representation that are specific to the C28x.

<b>10.1 DWARF Register Names</b> .....	<b>66</b>
<b>10.2 Call Frame Information</b> .....	<b>67</b>
<b>10.3 Vendor Names</b> .....	<b>68</b>
<b>10.4 Vendor Extensions</b> .....	<b>68</b>

## 10.1 DWARF Register Names

DWARF3 registers use register name operators (see Section 2.6.1 of the DWARF3 standard). The operand of a register name operator is a register number representing an architecture register. [Table 3-1](#) lists C28x registers. [Table 10-1](#) defines mappings from DWARF3 register numbers/names to C28x registers.

**Table 10-1. DWARF3 Register Numbers for C28x**

DWARF Register #	C28x ISA Register	Size	Description
0	AL	16 bits	ACC accumulator low half
1	AH	16 bits	ACC accumulator high half
2	PL	16 bits	Low half of P
3	PH	16 bits	High half of P
4	AR0	16 bits	Low half of XAR0
5	XAR0	32 bits	Auxiliary register 0
6	AR1	16 bits	Low half of XAR1
7	XAR1	32 bits	Auxiliary register 1
8	AR2	16 bits	Low half of XAR2
9	XAR2	32 bits	Auxiliary register 2
10	AR3	16 bits	Low half of XAR3
11	XAR3	32 bits	Auxiliary register 3
12	AR4	16 bits	Low half of XAR4
13	XAR4	32 bits	Auxiliary register 4
14	AR5	16 bits	Low half of XAR5
15	XAR5	32 bits	Auxiliary register 5
16	AR6	16 bits	Low half of XAR6
17	XAR6	32 bits	Auxiliary register 6
18	AR7	16 bits	Low half of XAR7
19	XAR7	32 bits	Auxiliary register 7
20	SP	16 bits	Stack pointer
21	TL	16 bits	Low half of XT
22	T	16 bits	High half of XT
23	ST0	16 bits	Status register 0
24	ST1	16 bits	Status register 1
25	PC	22 bits	Program counter 0x3F FFC0
26	RPC	22 bits	Return program counter
27	--		Reserved for internal use
28	FP		XAR2 frame pointer
29	DP	16 bits	Data-page pointer
30	SXM		status register bits
31	PM		status register bits
32	OVM		status register bits
33-35, 38			Reserved for internal use
36	IFR	16 bits	Interrupt flag register
37	IER	16 bits	Interrupt enable register
38	EALLOW		Reserved for internal use

The FPU32 registers are a subset of the FPU64 registers. For example on FPU32, register 41 represents the 32-bit register R0; on FPU64, it is the lower 32 bits of the R0 64-bit register. Likewise, on FPU32, register 43 represents the 32-bit register R0H; on FPU64, it is the upper 32 bits of the R0 64-bit register.

**Table 10-2. DWARF3 Register Numbers for FPU on C28x**

DWARF Register #	FPU32 Register (all 32 bits)	FPU64 Register (64 bits unless otherwise noted)	Description
39-40	STF	STF (32 bits)	Floating pointer status register
41	R0	R0H:R0L	
43	R0H		
45	R1	R1H:R1L	
47	R1H		
49	R2	R2H:R2L	
51	R2H		
53	R3	R3H:R3L	
55	R3H		
57	R4	R4H:R4L	
59	R4H		
61	R5	R5H:R5L	
63	R5H		
65	R6	R6H:R6L	
67	R6H		
69	R7	R7H:R7L	
71	R7H		
73-74	RB	RB (32 bits)	Repeat block register
75-76	PSEUDO	PSEUDO (32 bits)	Reserved for internal use
all others			Reserved for internal use

## 10.2 Call Frame Information

Debuggers need to be able to view and modify the local variables of any function as its execution progresses.

DWARF3 does this by having the compiler keep track of where (in registers or on the stack) a function stores its data. The compiler encodes this information in a byte-coded language specified in Section 6.4 of the DWARF3 standard. This allows the debugger to progressively recreate a previous state by interpreting the byte-coded language. Each function activation is represented by a base address, called the Canonical Frame address (CFA), and a set of values corresponding to the contents of the machine's registers during that activation. Given the point to which the activation's execution has progressed, the debugger can figure out where all of the function's data is, and can unwind the stack to a previous state, including a previous function activation.

The DWARF3 standard suggests a very large unwinding table, with one row for each code address and one column for each register, virtual or not, including the CFA. Each cell contains unwinding instructions for that register at that point in time (code address).

Both the definition of the CFA and the set of registers comprising the state are architecture-specific.

The set of registers includes all the registers listed in [Table 10-1](#), indexed by their DWARF register numbers from the first column.

For the CFA, the C28x ABI follows the convention suggested in the DWARF3 standard, defining it as the value of SP (R1) at the call site in the previous frame (that of the calling procedure).

The unwinding table may include registers that are not present on all C28x ISAs. Therefore a situation may arise in which the ISA executing the program has registers that are not mentioned in the call frame information. In this situation, the interpreter should behave as follows:

- Callee-saved registers should be initialized to the same-value rule.
- All other registers should be initialized to the undefined rule.

### 10.3 Vendor Names

The DW\_AT\_producer attribute is used to identify the toolchain that produced an object file. The operand is a string that begins with a vendor prefix. The following prefixes are reserved for specific vendors:

<b>TI</b>	C28x Code Generation Tools from Texas Instruments
<b>GNU</b>	The GNU Compiler Collection (GCC)

### 10.4 Vendor Extensions

The DWARF standard allows toolchain vendors to define additional tags and attributes for representing information that is specific to an architecture or toolchain. TI has defined some of each. This section serves to document the ones that apply generally to the C28x architecture.

Unfortunately, the set of allowable values is shared among all vendors, so the ABI cannot mandate standard values to be used across vendors. The best we can do is ask producers to define their own vendor-specific tags and attributes with the same semantics (using the same values if possible), and ask consumers to use the DW\_AT\_producer attribute in order to interpret vendor-specific values that differ from toolchain to toolchain.

[Table 10-3](#) defines TI vendor-specific DIE tags for the C28x. [Table 10-3](#) defines TI vendor-specific attributes.

**Table 10-3. TI Vendor-Specific Tags**

Name	Value	Description
DW_TAG_TI_branch	0x4088	Identifies calls and returns

#### DW\_TAG\_TI\_branch

This tag identifies branches that are used as calls and returns. It is generated as a child of a DW\_TAG\_subprogram DIE. It has a DW\_AT\_lowpc attribute corresponding to the location of the branch instruction.

If the branch is a function call, it has a DW\_AT\_TI\_call attribute with non-zero value. It may also have a DW\_AT\_name attribute that indicates the name of the called function, or a DW\_AT\_TI\_indirect attribute if the callee is not known (as with a call through a pointer).

If the branch is a return, it has a DW\_AT\_TI\_return attribute with non-zero value.

**Table 10-4. TI Vendor-Specific Attributes**

Name	Value	Class	Description
DW_AT_TI_symbol_name	0x2001	string	Object file name (mangled)
DW_AT_TI_return	0x2009	flag	Branch is a return
DW_AT_TI_call	0x200A	flag	Branch is a call
DW_AT_TI_asm	0x200C	flag	Function is assembly language
DW_AT_TI_indirect	0x200D	flag	Branch is an indirect call
DW_AT_TI_max_frame_size	0x2014	constant	Activation record size

**DW\_AT\_TI\_call, DW\_AT\_TI\_return, DW\_AT\_TI\_indirect:** These attributes apply to DW\_TAG\_TI\_branch DIEs, as described previously.

**DW\_AT\_TI\_symbol\_name:** This attribute can appear in any DIE that has a DW\_symbol\_name. It provides the object-file-level name associated with the variable or function; that is, with any mangling or other alteration applied by the toolchain to the source-level name.

**DW\_AT\_TI\_max\_frame\_size:** This attribute may appear in a DW\_TAG\_subprogram DIE. It indicates the amount of stack space required for an activation of the function, in bytes. Its intended use is for downstream tools that perform static stack depth analysis.

# Chapter 11

## **ELF Object Files (Processor Supplement)**

---



The C28x ABI is based on the ELF object file format. The base specification for ELF is comprised of Chapters 4 and 5 of the larger System V ABI specification (<http://www.sco.com/developers/gabi/2003-12-17/contents.html>).

The subsections that follow contain C28x processor-specific supplements for Chapter 4 (Object Files) of the specification. [Chapter 12](#) of this document contains processor-specific supplements for Chapter 5 (Program Loading and Dynamic Linking) of the specification.

However, for the C28x ELF format, fields that represent target addresses are native (word-oriented), but fields that represent target sizes are expressed in bytes.

<b>11.1 Registered Vendor Names</b> .....	<b>70</b>
<b>11.2 ELF Header</b> .....	<b>70</b>
<b>11.3 Sections</b> .....	<b>71</b>
<b>11.4 Symbol Table</b> .....	<b>74</b>
<b>11.5 Relocation</b> .....	<b>75</b>

## 11.1 Registered Vendor Names

The compiler toolsets create and use vendor-specific symbols. To avoid potential conflicts TI encourages vendors to define and use vendor-specific namespaces. The list of currently registered vendors and their preferred shorthand name is given in [Table 11-1](#).

**Table 11-1. Registered Vendors**

Name	Vendor
cx, __cxa	C++ ABI namespace. Applies to all symbols specified by the C++ ABI.
c28xabi, __c28xabi	Common namespace for symbols specified by the C28x EABI.
C28X	Common namespace for symbols specified by the C28x.
TI, __TI	Reserved for symbols specific to the TI toolchain. This also represents a composite namespace for all TI processor ABIs.
gnu, __gnu	Reserved for symbols specific to the GCC toolchain.

### Note

The TI or \_\_TI specification defines names for processor-specific section types, special sections, and so on. Where there is commonality among different TI processors, such entities are named using TI rather than defining distinct names for each processor. For example, the Exception Table Index Table section type is SHT\_TI\_EXIDX for all TI processors, rather than SHT\_C28x\_EXIDX for C28x, SHT\_C2000\_EXIDX for C2000, and so on.

## 11.2 ELF Header

The ELF header provides a number of fields that guide interpretation of the file. Most of these are specified in the System V ELF specification. This section augments the base standard with specific details for the C28x.

### e\_ident

The 16-byte ELF identification field identifies the file as an object file and provides machine-independent data with which to decode and interpret the file's contents. [Table 11-2](#) specifies the values to be used for C28x object files.

**Table 11-2. ELF Identification Fields**

Index	Symbolic Value	Numeric Value	Comments
EI_MAG0		0x7f	Per System V ABI
EI_MAG1		E	Per System V ABI
EI_MAG2		L	Per System V ABI
EI_MAG3		F	Per System V ABI
EI_CLASS	ELFCLASS32	1	32-bit ELF
EI_DATA	ELFDATA2LSB	1	Little-endian
EI_VERSION	EV_CURRENT	1	
EI_ABIVERSION		0	

The EI\_OSABI field shall be ELFOSABI\_NONE unless overridden by the conventions of a specific platform. No platforms for the C28x family override the default setting of the EI\_OSABI field; its value is always ELFOSABI\_NONE.

### e\_type

There are currently no C28x-specific object file types. All values between ET\_LOPROC and ET\_HIPROC are reserved to future revisions of this specification.

## e\_machine

An object file conforming to this specification must have the value EM\_TI\_C2000 (141, 0x8D).

## e\_entry

The base ELF specification requires this field to be zero if an application does not have an entry point. Nonetheless, some applications may require an entry point of zero (for example, via the reset vector).

A platform standard may specify that an executable file always has an entry point, in which case e\_entry specifies that entry point, even if zero.

## e\_flags

This member holds processor-specific flags associated with the file. There are no C28x-specific flags for e\_flags field.

## 11.3 Sections

There are no processor-specific special section indexes defined. All processor-specific values are reserved to future revisions of this specification.

The program may not place code or data above 0x80000000. Doing so will give a relocation error.

### 11.3.1 Section Indexes

The C28x ABI does not define any special section indexes.

### 11.3.2 Section Types

The ELF specification reserves section types 0x70000000 and higher for processor-specific values. TI has split this space into two parts: values from 0x70000000 through 0x7EFFFFFF are processor-specific, and values from 0x7F000000 through 0xFFFFFFFF are for TI-specific sections common to multiple TI architectures. The combined set is listed in [Table 11-3](#).

Not all these section types are used in the C28x ABI. Some are specific to the TI toolchain but outside the ABI, and some are used by TI toolchains for architectures other than C28x. They are documented here for completeness, and to reserve the tag values.

**Table 11-3. ELF and TI Section Types**

Name	Value	Comment
SHT_C28x_UNWIND	0x70000001	Unwind function table for stack unwinding
SHT_C28x_PREEMPTMAP	0x70000002	DLL dynamic linking pre-emption map (not supported by C28x)
SHT_C28x_ATTRIBUTES	0x70000003	Object file compatibility attributes
SHT_TI_ICODE	0x7F000000	Intermediate code for link-time optimization
SHT_TI_XREF	0x7F000001	Symbolic cross reference information
SHT_TI_HANDLER	0x7F000002	Reserved
SHT_TI_INITINFO	0x7F000003	Compressed data for initializing C variables
SHT_TI_SH_FLAGS	0x7F000005	Extended section header attributes
SHT_TI_SYMALIAS	0x7F000006	Symbol alias table
SHT_TI_SH_PAGE	0x7F000007	Per-section memory space table

SHT\_C28x\_UNWIND identifies a section containing unwind function table for stack unwinding. See [Chapter 9](#) for details.

SHT\_C28x\_ATTRIBUTES identifies a section containing object compatibility attributes. See [Chapter 13](#).

SHT\_TI\_ICODE identifies a section containing a TI-specific intermediate representation of the source code, used for link-time recompilation and optimization.

SHT\_TI\_XREF identifies a section containing symbolic cross-reference information.

SHT\_TI\_HANDLER is not currently used.

SHT\_TI\_INITINFO identifies a section containing compressed data for initializing C variables. This section contains a table of records indicating source and destination addresses, and the data itself, usually in the compressed form. See [Chapter 14](#).

SHT\_TI\_SH\_FLAGS identifies a section containing a table of TI-specific section header flags.

SHT\_TI\_SYMALIAS identifies a section containing a table that defines symbols as being equivalent to other, possibly externally defined, symbols. The TI linker uses the table to eliminate trivial functions that simply forward to other functions.

SHT\_TI\_SH\_PAGE is used only on targets that have distinct, possibly overlapping, address spaces (pages). The section contains a table that associates other sections with page numbers. This section type is not used on C28x.

### 11.3.3 Extended Section Header Attributes

For the C28x, the following processor-specific attribute flag may be used in the TI toolchain:

TI\_SHF\_NOINIT identifies a section that contains variables that are not initialized. The NOINIT attribute can apply only to the `.TI.noinit` and `.TI.persistent` sections. For example:

<code>".TI.noinit"</code>	<code>SHT_NOBITS</code>	<code>TI_SHF_NOINIT</code>
<code>".TI.persistent"</code>	<code>SHT_PROGBITS</code>	<code>TI_SHF_NOINIT</code>

Linkers should not create `.cinit` records for these sections.

### 11.3.4 Subsections

C28x object files use a section naming convention that provides improved granularity while retaining the convenience of default rules for combining sections at link time. A section whose name contains a colon is called a *subsection*. Subsections behave as normal sections in all respects, but their name guides the linker when combining sections into output files. The root name of a subsection is the name up to, but not including, the colon. The suffix includes all characters following the colon. By default, the linker combines all sections with matching roots into a single section with that name. For example, `.text`, `text:func1`, and `.text:func2` are combined into a single section called `.text`. The user may be able to override this default behavior in toolchain-specific ways.

If there are multiple colons, section combination proceeds recursively from the right-most colon. For example, unless the user specifies otherwise, the default rules combine `.bss:func1:var1` and `.bss:func1:var2`, which then combine into `.bss`.

Subsections whose root names match special sections have the same ABI-defined properties as the section they match, as defined in [Section 11.3.5](#). For example `.text:func1` is an instance of a `.text` section.

### 11.3.5 Special Sections

The System V ABI, along with other base documents and other sections of this ABI, defines several sections with dedicated purposes. [Table 11-4](#) consolidates dedicated sections used by the C28x and groups them by functionality.

Section names are not mandated by the ABI. Special sections should be identified by type, not by name. However, interoperability among toolchains can be improved by following these conventions. For example, using these names may decrease the likelihood of having to write custom linker commands to link relocatable files built by different compilers.

The ABI does mandate that a section whose name does match an entry in the table must be used for the specified purpose. For example, the compiler is not required to generate code into a section called `.text`, but it is not allowed to generate a section called `.text` containing anything other than code.



All of the section names listed in the table that follows are prefixes. The type and attributes apply to all sections with names that begin with these strings.

**Table 11-4. C28x Special Sections**

Prefix	Type	Attributes
<b>Code Sections</b>		
.text	SHT_PROGBITS	SHF_ALLOC + SHF_EXECINSTR
<b>Data Sections</b>		
.data	SHT_PROGBITS	SHF_ALLOC + SHF_WRITE
.bss	SHT_NOBITS	SHF_ALLOC + SHF_WRITE
.TI.noinit	SHT_NOBITS	TI_SHF_NOINIT
.TI.persistent	SHT_PROGBITS	TI_SHF_NOINIT
.const	SHT_PROGBITS	SHF_ALLOC
<b>Exception Handling Data Sections</b>		
.C28x.exidx	SHT_C28x_UNWIND	SHF_ALLOC + SHF_LINK_ORDER
.C28x.extab	SHT_PROGBITS	SHF_ALLOC
<b>Initialization and Termination Sections</b>		
.init_array	SHT_INIT_ARRAY	SHF_ALLOC + SHF_WRITE
<b>ELF Structures</b>		
.rel	SHT_REL	None
.rela	SHT_RELA	None
.symtab	SHT_SYMTAB	None
.symtab_shndx	SHT_SYMTAB_SHNDX	None
.strtab	SHT_STRTAB	SHF_STRINGS
.shstrtab	SHT_STRTAB	SHF_STRINGS
.note	SHT_NOTE	None
<b>Build Attributes</b>		
.C28x.attributes	SHT_C28x_ATTRIBUTES	None
<b>Symbolic Debug Sections</b>		
.debug <sup>(1)</sup>	SHT_PROGBITS	None
<b>TI Toolchain-Specific Sections</b>		
.stack	SHT_NOBITS	SHF_ALLOC + SHF_WRITE
.systemem	SHT_NOBITS	SHF_ALLOC + SHF_WRITE
.switch	SHT_PROGBITS	SHF_ALLOC
.binit	SHT_PROGBITS	SHF_ALLOC
.cinit	SHT_TI_INITINFO	SHF_ALLOC
.const.handler_table	SHT_PROGBITS	SHF_ALLOC
.ovly	SHT_PROGBITS	SHF_ALLOC
.ppdata	SHT_NOBITS	SHF_ALLOC + SHF_WRITE
.ppinfo	SHT_NOBITS	SHF_ALLOC + SHF_WRITE
.TI.crctab	SHT_PROGBITS	SHF_ALLOC
.TI.icode	SHT_TI_ICODE	None
.TI.xref	SHT_TI_XREF	None
.TI.section.flags	SHT_TI_SH_FLAGS	None
.TI.symbol.alias	SHT_TI_SYMALIAS	None
.TI.section.page	SHT_TI_SH_PAGE	None
<b>Sections in the System V ABI but Unused by the C28x EABI</b>		
.comment		

**Table 11-4. C28x Special Sections (continued)**

Prefix	Type	Attributes
.data1		
.dsbt		
.dynamic		
.dynstr		
.dynsym		
.far		
.fardata		
.fardata:const		
.fini		
.fini_array		
.gnu.version		
.gnu.version_d		
.gnu.version_r		
.got		
.hash		
.init		
.interp		
.line		
.neardata		
.plt		
.preinit_array		
.rodata		
.rodata1		
.tbss		
.tdata		
.tdata1		
.TI.tls_init		

- (1) Additional sections with names like `.debug_info` and `.debug_line` are also used. The `.debug` section name is a prefix, as are other section names. The type and attributes apply to all sections with names that begin with `.debug`.

The "**TI Toolchain-Specific Sections**" sections in the previous table are used by the TI toolchain in various toolchain-specific ways. The ABI does not mandate the use of these sections (although interoperability encourages their use), but it does reserve these names.

The "**Sections in the System V ABI but Unused by the C28x EABI**" sections in the previous table are specified by the System V ABI, but are not used or defined under the C28x ABI. Other sections are used by TI for other devices; these names are reserved.

### 11.3.6 Section Alignment

Sections containing C28x code must be 16-bit (word) aligned and padded to a 16-bit (word) boundary.

Platform standards may set a limit on the maximum alignment that they can guarantee (normally the virtual memory page size).

## 11.4 Symbol Table

There are no processor-specific symbol types or symbol bindings. All processor-specific values are reserved to future revisions of this specification.

The C28x ABI follows the ELF specification with respect to global and weak symbol definitions, and the meaning of symbol values.

### 11.4.1 Symbol Types

This specification adheres to the ARM ELF specification with respect to Symbol Types, namely:

- All code symbols exported from an object file (symbols with binding STB\_GLOBAL) shall have type STT\_FUNC.
- All extern data objects shall have type STT\_OBJECT. No STB\_GLOBAL data symbol shall have type STT\_FUNC.
- The type of an undefined symbol shall be STT\_NOTYPE or the type of its expected definition.
- The type of any other symbol defined in an executable section can be STT\_NOTYPE.

### 11.4.2 Common Block Symbols

As described in the ELF specification, symbols with type STT\_COMMON are allocated by the linker.

Common block symbols addressed with other addressing forms should have section index SHN\_COMMON, as described in the base ELF specification.

### 11.4.3 Symbol Names

A symbol that names a C or assembly language entity should have the name of that entity. For example, a C function called *func* generates a symbol called *func*. (There is no leading underscore as was the case in the former COFF ABI). Symbol names are case sensitive and are matched exactly by linkers.

The C28x compiler follows the following naming convention for temporary symbols:

- Parser generated symbols are prefixed with \$P\$
- Optimizer generated symbols are prefixed with \$O\$
- Codegen generated symbols are prefixed with \$C\$

### 11.4.4 Reserved Symbol Names

The following symbols are reserved to this and future revisions of this specification:

- Local symbols (STB\_LOCAL) beginning with \$
- Global symbols (STB\_GLOBAL, STB\_WEAK) beginning with any of the vendor names listed in [Table 11-1](#).
- Global symbols (STB\_GLOBAL, STB\_WEAK) ending with any of \$\$Base or \$\$Limit
- Symbols matching the pattern \${Tramp}\${|L|S}\${PI}\$symbol
- Compiler generated temporary symbols beginning with \$P\$, \$O\$, \$C\$ (as described in [Section 4.7](#))

### 11.4.5 Mapping Symbols

Mapping symbols are local symbols that serve to classify program data. Currently the ABI does not specify any behavior that uses mapping symbols. Nevertheless, the following two names are reserved for future use: \$code, and \$data.

## 11.5 Relocation

The ELF relocations for C28x are defined such that the all information needed to perform the relocation is contained in the relocation entry, the object field, and the associated symbol. The linker does not need to decode instructions, beyond unpacking the object field, to perform the relocation. This results in slightly more relocation types than the older C28x COFF ABI. Relocation types are not compatible between COFF and ELF.

Relocations are specified as operating on a relocatable field. Roughly speaking, the relocatable field is the bits of the program image that are affected by the relocation. The field is defined in terms of an addressable container whose address is given by the *r\_offset* field of the relocation entry. The field's size and position within to the container, as well as the computation of the relocated value, are specified by the relocation type. The relocation operation consists of extracting the relocatable field, performing the operation, and re-inserting the resultant value back into the field.

ELF relocations can be of type Elf32\_Rela or Elf32\_Rel. The Rela entries contain an explicit addend which is used in the relocation calculation. Entries of type Rel use the relocatable field itself as the addend. Certain relocations are identified as Rela only. For the most part these correspond to the upper 16 bits of a 32-bit

address, where the resultant value depends on carry propagation from lower bits that are not available in the field. Where *Rela* is specified, an implementation must honor this requirement. An implementation may choose to use *Rel* or *Rela* type relocations for other relocations.

The effects of addressing modes on relocations is briefly described in [Section 4.3](#).

### 11.5.1 Relocation Types

Relocation types are described in two tables. [Table 11-5](#) gives numeric values for the relocation types and summarizes the computation of the relocated value. Following that table is a description of the relocation types and examples of their use. [Table 11-6](#) describes, for each type, the exact computation, including extraction and insertion of the relocation field, overflow checking, and any scaling or other adjustments.

The following notations are used in [Table 11-5](#).

<b>S</b>	The value of the symbol associated with the relocation, specified by the symbol table index contained in the <i>r_info</i> field in the relocation entry.
<b>A</b>	The addend used to compute the value of the relocatable field. For <i>Elf32_rel</i> relocations, <i>A</i> is encoded into the relocatable field according to <a href="#">Table 11-6</a> . For <i>Elf32_Rela</i> relocations, <i>A</i> is given by the <i>r_addend</i> field of the relocation entry.
<b>PC</b>	The address of the container containing the field. This may not be the same as the address of the instruction containing the relocation.

**Table 11-5. C28x Relocation Types**

Name	Value	Operation	Constraints
R_C28X_NONE	0		
R_C28X_ABS8	1	S + A	
R_C28X_ABS16	2	S + A	
R_C28X_ABS32	3	S + A	
R_C28X_ABSLO6	4	S+A	
R_C28X_ABSLO6_BLKD	4	S+A	Duplicate, but indicates blocked access
R_C28X_ABS22	5	S+A	
R_C28X_ABS22_BR	5	S+A	Duplicate, but used in function calls only
R_C28X_HI6	6	S+A	Rela only
R_C28X_DP_HI10	7	S+A-PC	Rela only
R_C28X_DP_HI16	8	S+A	
R_C28X_PCREL16	9	S+A-PC	
R_C28X_PCREL8	10	S+A-PC	
R_C28X_HI16	11	S+A	Rela only
R_C28X_NEGWORD	12	special	
R_C28X_NEGBYTE	13	special	
R_C28X_ABS8_HI	14		
R_C28X_ABS13_SE16	15	special	
R_CLA_ABS16	16	S+A	
R_C28X_ABSLO7	17	S+A	
R_C28X_PREL31	18	S+A-PC	

#### 11.5.1.1 Absolute Relocations

Absolute relocations directly encode the relocated address of a symbol. C28x "Direct," "Data immediate," "Program immediate," and "I/O immediate" addressing modes all require absolute relocations. The relocation types with names containing "ABS" are all absolute relocation types.

### 11.5.1.2 PC-Relative Relocations

PC-relative relocations encode addresses as signed PC-relative offsets. The relocation types with names containing "PCR" are PC-relative relocation types.

In the assembler and linker, displacements are computed relative to the address of the container of the relocation as defined in [Table 11-6](#), not the starting address of the instruction. Because the PC advances while reading the individual words of the instruction, the effective PC value that will be used by the hardware when performing the addressing mode may differ from the address of the relocation container. To compensate for this, the assembler must adjust the relocation addend by the difference.

### 11.5.1.3 Relocations in Data Sections

The R\_C28X\_ABS16/32 relocation types directly encode the relocated address of a symbol into 16-, or 32-bit fields. These relocations are used to relocate addresses in initialized data sections. The signedness of the field is unspecified for R\_C28X\_ABS16/32; that is, these relocation types are used for both signed and unsigned values. They are also used for some instruction relocations, as shown here:

```
.field x,32      ; R_C28X_ABS32
.field x,16      ; R_C28X_ABS16
```

### 11.5.1.4 Relocations for C28x Instructions

The following statements perform various types of relocations. The relocation type for each statement is shown in the comments.

These statements perform direct addressing relocations.

```
MOV DP, #var ; R_C28X_DP_HI10
MOV AL, @var ; R_C28X_ABSLO6
MOV AL, @@var ; R_C28X_ABSLO7
MOVW DP, #var ; R_C28X_DP_HI16
```

These statements perform relocations for branches:

```
LCR function ; R_C28X_ABS22
SB label ; R_C28X_PCREL8
B label ; R_C28X_PCREL16
```

These statements perform special relocations:

```
MOV AH, #HI(var) ; R_C28X_HI6
SUB loc16, #lab ; R_C28X_NEGWORD (on lab)
SUBB AH, #lab ; R_C28X_NEGBYTE
MOVW loc16, #lab, EQ ; R_C28X_ABS_HI (on lab)
```

This statement performs a special relocation using C2xLP compatibility addressing:

```
MPY #lab ; R_C28X_ABS13_SE16 ; sign extend 13->16 bits
```

This statement performs a special relocation using CLA relocation:

```
MI16TOF32 MR0, @lab ; R_CLA_ABS16
```

### 11.5.1.5 Other Relocation Types

The R\_C28X\_NONE relocation type performs no operation. It is used to create a reference from one section to another, to ensure that if the referring section is linked in, so is the referent section.

R\_C28X\_PREL31 is used to encode code addresses in exception handling tables. See [Section 9.2](#).

## 11.5.2 Relocation Operations

Table 11-6 provides detailed information on how each relocation is encoded and performed. The table uses the following notations:

<b>F</b>	The relocatable field. The field is specified using the tuple <b>[CS, O, FS]</b> , where CS is the container size, O is the starting offset from the LSB of the container to the LSB of the field, and FS is the size of the field. All values are in bits. The notation <b>[x,y]+[z,w]</b> indicates that relocation occupies discontinuous bit ranges, which should be concatenated to form the field. When "F" is used in the addend column, it indicates that the field is already of the exact size of the address space.
<b>R</b>	The arithmetic result of the relocation operation
<b>EV</b>	The encoded value to be stored back into the relocation field
<b>SE(x)</b>	Sign-extended value of x. Sign-extension is conceptually performed to the width of the address space.
<b>ZE(x)</b>	Zero-extended value of x. Zero-extension is conceptually performed to the width of the address space.
<b>r_addend</b>	The addend must be stored in a RELA field, and may not be stored in the relocation container.

For relocation types for which overflow checking is enabled, an overflow occurs if the encoded value (including its sign, if any) cannot be encoded into the relocatable field. That is:

- A signed relocation overflows if the encoded value falls outside the half-open interval  $[-2^{FS-1} \dots 2^{FS-1})$ .
- An unsigned relocation overflows if the encoded value falls outside the half-open interval  $[0 \dots 2^{FS})$ .
- A relocation whose signedness is indicated as *either* overflows if the encoded value falls outside the half-open interval  $[-2^{FS-1} \dots 2^{FS})$ .

**Table 11-6. C28x Relocation Operations**

Relocation Name	Signedness	Container Size (CS)	Field [O, FS] (F)	Addend (A)	Result (R)	Overflow Check	Encoded Value (EV)
R_C28X_NONE	None	32	[0,32]	None	None	No	None
R_C28X_ABS32	Either	32	[0,32]	F	S + A	No	R
R_C28X_ABS16	Either	16	[0,16]	SE(F)	S + A	No	R
R_C28X_ABS8	Either	8	[0,8]	SE(F)	S + A	Yes	R
R_C28X_PCR16	Signed	16	[0,16]	SE(F)	S + A - P	No	R
R_C28X_ABS_HI16	None	16	[0,16]	r_addend	S + A	No	R >> 16
R_C28X_PREL31	Signed	32	[0,31]	SE(F)	S + A - P	No	R >> 1

## 11.5.3 Relocation of Unresolved Weak References

A relocation that refers to an undefined weak symbol is satisfied as follows:

- References to weak functions shall be implemented using Immediate addressing mode.
- When used in an absolute relocation type (R\_C28x\_ABS\*) the reference resolves to zero.

All other cases are non-conformant with the ABI.

**ELF Program Loading and Linking (Processor Supplement)**

In general, *program loading* describes the steps involved in taking a program represented as an ELF file and beginning its execution. By its nature, this process is platform and system specific.

A system may use a subset of the mechanisms depending on its specific requirements.

This part of the ABI is based on Chapter 5 of the System V ABI standard (<http://www.sco.com/developers/gabi/2003-12-17/contents.html>), which describes object file information and system actions that create running programs. This section contains a processor-specific supplement to that standard for those elements that are common to most C28x-based systems.

<b>12.1 Program Header</b> .....	<b>80</b>
<b>12.2 Program Loading</b> .....	<b>81</b>

## 12.1 Program Header

The program header contains the following fields.

### **p\_type**

The C28x defines no processor-specific segment types for the p\_type field in the program header.

### **p\_vaddr, p\_paddr**

The C28x does not currently have virtual addressing. Both the p\_vaddr and p\_paddr fields indicate the execution address of the segment. Segments that are loaded at one address and copied to another to execute are represented in the object file by two distinct segments: a load-image segment containing the segment's code or data whose address fields refer to the load address; and an uninitialized run-image segment whose address fields refer to the run address. The application is responsible for copying the contents of the load image to the run address at the appropriate time.

### **p\_flags**

There are no processor-specific segment flags defined for C28x.

### **p\_align**

As described in the System V ABI, loadable segments are aligned in the file such that their p\_vaddr (address in memory) and p\_offset (offset in the file) are congruent, modulo p\_align. In systems with virtual memory, p\_align generally specifies the page size. Unless specified for a specific platform, for the C28x the meaning and setting of p\_align is unspecified.

#### **12.1.1 Base Address**

C28x does not support position-independent code as described in the "Base Address" section of Chapter 5 of the System V ABI standard.

Segments that are not position independent must either be loaded at their specified address or relocated at load time.

#### **12.1.2 Segment Contents**

The base ABI (this section) does not define any requirements for what segments must be present or what their contents are. For example, a C28x program may contain any number of code and data segments, including multiple code segments and multiple absolute data segments, as described in [Chapter 4](#) and [Chapter 5](#). Specific platforms may have their own requirements: for example some high-level operating systems may constrain programs to have only one code and one data segment, or perhaps just one segment for both.

#### **12.1.3 Thread-Local Storage**

The ABI does not currently specify a standard mechanism for thread-local storage.



## 12.2 Program Loading

There are many system-specific aspects of loading a program and starting its execution. This section describes in general terms aspects of the process that are common to most systems, with an emphasis on items that are specific to C28x.

These steps may be performed by a combination of an offline agent such as a host-based loader, run-time components of the target system such an operating system, or library components that are linked into the program itself such as self-boot code.

In general, loading a program consists of four series of actions: creating the process image, initializing the execution environment, executing the program, and performing termination actions.

Creating the process image involves copying the program and its subcomponents into memory and performing relocation if needed. These steps must necessarily be performed by some external agent such as a host-based loader or operating system.

Initializing the execution environment involves steps that must occur before the program starts running (i.e. before main is called). These steps can be performed either by an external agent or by the program itself. Likewise, termination actions occur when main returns (or calls exit), and can be performed either externally or by the program.

[Table 12-1](#), [Table 12-2](#) and [Table 12-3](#) list the steps to create, initialize, and terminate a program. While the order of the steps is not absolute, there are dependencies that must be honored.

**Table 12-1. Steps to Create a Process Image from an ELF Executable**

Step	
1.	Determine the address for each loadable segment. In bare-metal or non-dynamic systems, this is usually the address in the <code>p_vaddr</code> field of the segment's program header. Other considerations are discussed in <a href="#">Section 12.1</a> .
2.	Initialize the memory system and allocate memory.
3.	Copy the contents of each segment into memory. If a segment has unfilled space (that is, its file size is less than its memory size), initialize the unfilled space to 0.
.	Marshall command line arguments and environment variables. This step is platform specific.

**Table 12-2. Steps to Initialize the Execution Environment**

Step	
.	Set SP. SP (R1) should be set to the value of the symbol <code>__TI_STACK_END</code> , properly aligned on an 8-byte boundary.
.	Initialize variables. For self-booting ROM-based systems, some mechanism is required to initialize RAM-based (read-write) variables with their initial values. The mechanism is toolchain and platform specific. One such mechanism, implemented in the TI tools, is described in <a href="#">Chapter 14</a> .
.	Perform initialization calls. Generally these are calls to constructors for global objects defined in the module. Pointers to initialization functions are stored in a table. The table is delimited by a pair of global symbols: <code>__TI_INITARRAY_Base</code> and <code>__TI_INITARRAY_Limit</code> .
.	Branch to the entry point. The entry point is specified in the <code>e_entry</code> field of the ELF header. On systems with some underlying software fabric such as an OS, the entry point is typically the main function. On bare-metal systems, most of the initialization steps listed in this table may be performed by the program itself, via library code that executes before main. In that case the ELF entry point is the address of that code. For example the TI tools provide an entry routine called <code>_c_int00</code> that begins the sequence in Step 10 (set SP) once the process image is created.

**Table 12-3. Termination Steps**

Step	
.	Perform <code>atexit</code> calls. Functions registered by <code>atexit</code> are called, in reverse order of registration.

This page intentionally left blank.



The ABI specification for the ARM ABIv2 specification defines the build attributes mechanism to capture the build time options so that a linker can enforce compatibility of relocatable files. The ELF specification uses the same structure to encode the build attributes as documented in the ARM ABIv2 build attributes specifications in "ARM Addenda" to, and "Errata" in, the *ABI for the ARM Architecture*, document number ARM IHI0045A released on 13th November 2007.

<b>13.1 About Build Attributes</b> .....	<b>84</b>
<b>13.2 C28x ABI Build Attribute Subsection</b> .....	<b>84</b>
<b>13.3 Build Attribute Tags</b> .....	<b>85</b>

### 13.1 About Build Attributes

Build attributes are classified as vendor-specific or ABI-specific. The section documents build attributes that are ABI-specific. Vendors are free to implement additional toolchain-specific attributes.

Every ABI conforming relocatable file must contain the build attributes section of type SHT\_C28x\_ATTRIBUTES (0x70000003), conventionally named C28x.attributes. An executable file can optionally contain the build attributes section. A conforming tool should only use the section type to recognize the build attribute section.

The build attributes section consists of a one-byte version specifier with the value 'A' (0x41), followed by a sequence of vendor subsections.

'A'	vendor subsection	vendor subsection	...
-----	----------------------	----------------------	-----

Each subsection has the following format:

length	vendor name	0	vendor data
uint32	char[ ]	uint8	

The length field specifies the length in bytes of the entire subsection. The vendor name "C28x" is reserved for ABI-specified attributes. The format and interpretation of vendor data in other subsections is vendor-specific.

### 13.2 C28x ABI Build Attribute Subsection

Attributes that are specified by this ABI are recorded in the subsection with the vendor string C28x. Toolchains should determine compatibility between relocatable files using solely these attributes; vendor-specific information should not be used other than as permitted by the Tag\_Compatibility attribute which is provided for this purpose.

The vendor data in the C28x subsection contains any number of attribute vectors. Attribute vectors begin with a scope tag that specifies whether they apply to the entire file or only to listed sections or symbols. An attribute vector has one of the following three formats:

1	length	(omitted)		attributes	Apply to file
2	length	section numbers	0	attributes	Apply to specified sections
3	length	section numbers	0	attributes	Apply to specified sections
ULEB128	uint32	ULEB128[ ]	ULEB128[ ]	See below	

The length field specifies the length in bytes of the entire attribute vector, including the other fields. The symbol and section number fields are sequences of section or symbol indexes, terminated with 0.

Attributes in an attribute vector are represented as a sequence of tag-value pairs. Tags are represented as ULEB128 constants. Values are either ULEB128 constants or NULL-terminated strings.

The effect of omitting a tag in the file scope is identical to including it with a value of 0 or "", depending on the parameter type.

To allow a consumer to skip unrecognized tags, the parameter type is standardized as ULEB128 for even-numbered tags and a NULL-terminated string for odd-numbered tags. Tags 1, 2, 3 (the scope tags) and 32 (Tag\_ABI\_Compatibility) are exceptions to this convention.

As the ABI evolves, new attributes may be added. To enable older toolchains to robustly process files that may contain attributes they do not comprehend, the ABI adopts the following conventions:

- Tags 0-63 must be comprehended by a consuming tool. A consuming tool may choose to generate an error if an unknown tag in this range is encountered.
- Tags 64-127 convey information a consumer can ignore safely.
- For N >= 128, tag N has the same property as tag N modulo 128.

### 13.3 Build Attribute Tags

#### **OFBA\_C28XABI\_Tag\_C28x (=4), ULEB128**

This tag specifies the C28x ISA(s) that can execute the instructions encoded in the file. The following values are defined:

0	C28x code not present
1	C28x code present

In order to link, all the object files in a build must have the same ISA tag.

#### **OFBA\_C28XABI\_Tag\_Code\_FPU, (=6), ULEB128**

0	FPU code not present
1	FPU32 code present
2	FPU64 code present

This tag specifies which version of the FPU is supported, if any.

In order to link, all the object files in a build must be compiled with the same FPU support.

#### **OFBA\_C28XABI\_Tag\_CLA, (=8), ULEB128**

0	No CLA.
1	CLA 0 supported
2	CLA 1 supported
3	CLA 2 supported

This tag specifies the CLA version supported, if any.

In order to link, all the object files in a build must be compiled with the same CLA support.

#### **OFBA\_C28XABI\_Tag\_TMU, (=10), ULEB128**

0	No TMU
1	TMU 0 supported

This tag specifies the TMU version supported, if any.

In order to link, all the object files in a build must be compiled with the same TMU support.

#### **OFBA\_C28XABI\_Tag\_VCU, (=12), ULEB128**

0	No VCU.
1	VCU 0 supported
2	VCU 2 supported
3	VCU 2.1 supported

This tag specifies the VCU version supported, if any.

In order to link, all the object files in a build must be compiled with the same VCU support.

**OFBA\_C28XABI\_Tag\_float\_args, (=14), ULEB128**

0	No float args
1	Float args present

This tag specifies whether any single-precision float arguments are used.

**OFBA\_C28XABI\_Tag\_double\_args, (=16), ULEB128**

0	No double args
1	Double args present

This tag specifies whether any double-precision float arguments are used.

[Table 13-1](#) summarizes the build attribute tags defined by the ABI.

**Table 13-1. C28x ABI Build Attribute Tags**

Tag	Tag Value	Parameter Type	Compatibility Rules
Tag_File	1	uint32	
Tag_Section	2	uint32	
Tag_Symbol	3	uint32	
OFBA_C28XABI_Tag_C28x	4	ULEB128	Cannot be mixed across object files.
OFBA_C28XABI_Tag_FPU	6	ULEB128	Cannot be mixed across object files.
OFBA_C28XABI_Tag_CLA	8	ULEB128	Cannot be mixed across object files.
OFBA_C28XABI_Tag_TMU	10	ULEB128	Cannot be mixed across object files.
OFBA_C28XABI_Tag_VCU	12	ULEB128	Cannot be mixed across object files.
OFBA_C28XABI_Tag_float_args	14	ULEB128	none (Can be mixed across object files.)
OFBA_C28XABI_Tag_double_args	16	ULEB128	none (Can be mixed across object files.)

Chapter 14

## **Copy Tables and Variable Initialization**

---



This section provides a general description of the copy table mechanism, followed by a specification of the data structures involved. Finally, there is a description of how the implementation of variable initialization in the TI toolchain builds upon the basic copy table functionality.

<b>14.1 About Copy Tables</b> .....	<b>88</b>
<b>14.2 Copy Table Format</b> .....	<b>90</b>
<b>14.3 Compressed Data Formats</b> .....	<b>91</b>
<b>14.4 Variable Initialization</b> .....	<b>92</b>

## 14.1 About Copy Tables

Copy tables is the term for a general capability in the TI Toolchain to facilitate moving data from offline storage to online storage. Offline storage generally refers to where the program is loaded; it could be ROM, slower memory, and so on. Online storage generally refers to where the data resides when the program runs. The data being copied can be either code or variables. The term *copy table* refers to a table of source and destination addresses in which objects to be copied are registered. There is also a runtime component in the form of library functions that read the table and perform the copying in response to calls in the program.

There are numerous applications for copy tables, but the two most common are:

- **Initialization**—In a ROM-based bare-metal system, initialized read-write variables must be copied from ROM to RAM at program startup time.
- **Overlays**—As the program runs, different code and data components are swapped in and out of a region of memory.

The copy table mechanism is not part of the ABI. The means by which initialized variables get their initial values is by contract between the linker and the run-time library, which are required to be from the same toolchain. However, there may be advantages for other toolchains to follow the TI mechanism, or there may be a need for downstream tools to recognize the format, so we document it here.

The following figure illustrates the general mechanism. An object file contains an initialized section, `.mydata` in the example. At link time, the user specifies that `.mydata` is to have separate load and run addresses, and specifies that a copy table entry be created for it. The linker *removes* the data from `.mysect`, making it an uninitialized section, and assigns its address as its run location. It creates a new initialized section called `.mydata.load1` which contains `.mydata`'s data in encoded form, and places it at the load location. It links in a function called `copy_in` from the run-time library to decode and copy the data at run time, as well as additional format-specific helper functions. Finally, it creates a section (`.ovly1` in the example) that contains a copy table, which is a sequence of copy records that point to the source data and the destination address, and a handler table (not shown) that the copy function uses to choose the right decode helper function.

At run time, the application invokes `copy_in` to decompress and copy the data. The argument to `copy_in` is the address of the copy table associated with the section. The function parses the table and executes the specified copy operations.

Multiple objects can be encoded and registered for copy-in. Each generates its own copy table in the `.ovly1` section.

<sup>1</sup> Section names for copy table sections and compressed source data are arbitrarily chosen by the linker.



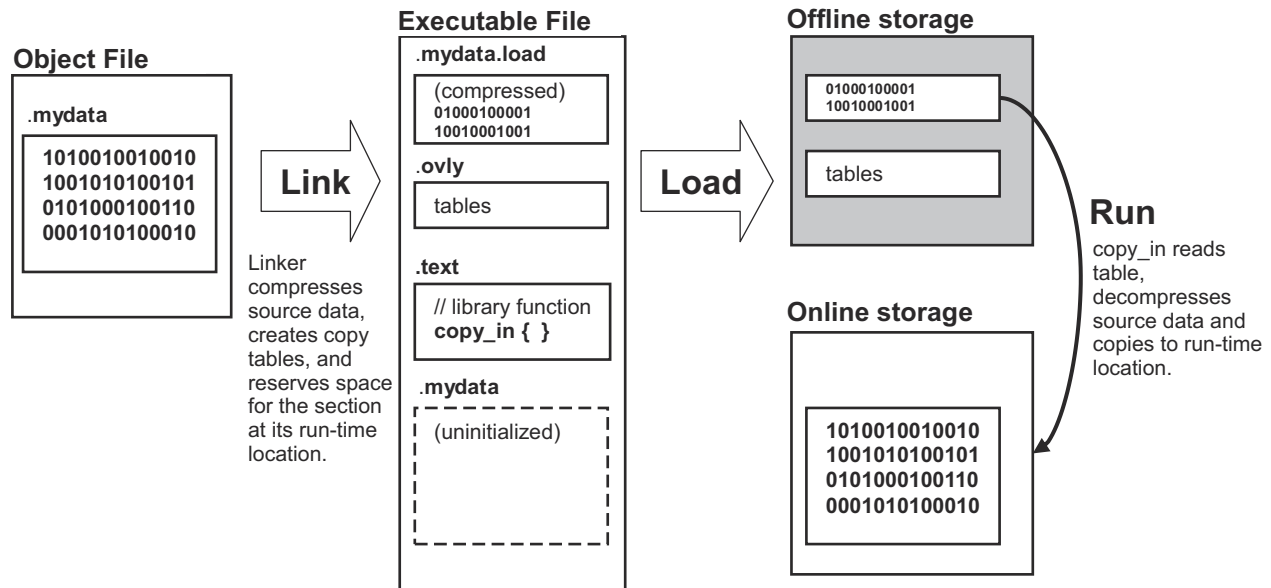

Figure 14-1. Copy Table Overview

A few variations are possible:

- **Multiple objects.** Multiple sections can be registered into a single copy table. This is so that all the code and data associated with an overlay can be copied in with a single invocation, without the application having to be aware of the number of separate components that comprise the overlay. A copy table can contain multiple copy records. Each copy record controls the copy-in of a contiguous chunk of code or data.
- **No compression.** The compression is optional. If compression is not enabled, there is no need for a separate load version of the section. The linker simply assigns separate load and run addresses to the initialized section.
- **Initialization.** Initialization of variables is a special case of the general mechanism. Copy records for initialization have a slightly different format, are stored in a different section called `.cinit`, and support zero-initialization as well as copy-in. These details are covered in [Section 14.4](#).
- **Boot-Time Copy-In.** A special section called `.binit` contains copy tables that are automatically invoked at application startup time. This is similar to the initialization case, but whereas initialization is part of the language implementation and is therefore built-in to the toolchain, boot-time copy-in is strictly an application level operation.

## 14.2 Copy Table Format

A copy table has the following format:

```
typedef struct
{
    uint16    rec_size;
    uint16    num_recs;
    COPY_RECORD recs[num_recs];
} COPY_TABLE;
```

**rec\_size** is a 16-bit unsigned integer that specifies the size in 16-bit units of each copy record in the table.

**num\_recs** is a 16-bit unsigned integer that specifies the number of copy records in the table.

The remainder of the table consists of a vector of copy records, each of which has the following format:

```
typedef struct
{
    uint32    load_addr; /* 32-bit storage for data or code pointer */
    uint32    run_addr; /* 32-bit storage for data or code pointer */
    uint32    size;
} COPY_RECORD;
```

The **load\_addr** field is the address of the source data in offline storage.

The **run\_addr** field is the destination address to which the data will be copied.

The **size** field is overloaded:

- If the size is zero, the load data is compressed. The source data has a format-specific encoding that implies its size. In this case, the first 16 bits of the source data encodes the compression format. The format is encoded as an index into the *handler table*, which is a table of pointers to handler routines for each format in use.
- If the size is non-zero, the source data is the exact image of the data to copy; in other words, it is not compressed. The copy-in operation is to simply copy *size* 16 bit units of data from the load address to the run address.

The rest of the source data is format-specific. The copy-in routine reads the first 16 bits of the source data to determine its format/index, uses that value to index into the handler table, and invokes the handler to finish decompressing and copying the data.

The handler table has the following format:

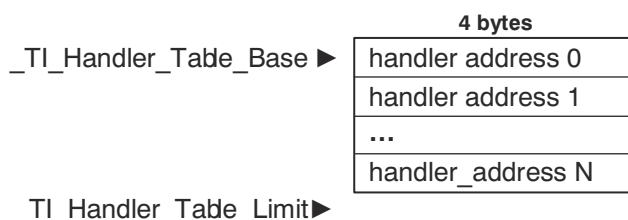

**Figure 14-2. Handler Table Format**

The copy-in routine references the table via special linker-defined symbols as shown. The assignment of handler indexes is not fixed; the linker reassigns indices for each application depending on what decompression routines are needed for that application. The handler table is generated into the .cinit section of the executable file.

The run-time support library in the TI toolchain contains handler functions for all the supported compression formats. The first argument to the handler function is the address pointing to the 16 bits after the 16-bit index. The second argument is the destination address.

[Reference Implementation of Copy-In Function](#) provides a reference implementation of the copy\_in function:

## Reference Implementation of Copy-In Function

```

typedef void (*handler_fptr)(const unsigned char *src, unsigned char *dst);
extern int __TI_Handler_Table_Base;
void copy_in(COPY_TABLE *tp)
{
    unsigned short i;
    for (i = 0; i < tp->num_recs; i++)
    {
        COPY_RECORD crp = tp->recs[i];
        const unsigned char *ld_addr = (const unsigned char *)crp.load_addr;
        unsigned char *rn_addr = (unsigned char *)crp.run_addr;
        if (crp.size) // not compressed, just copy the data.
            memcpy(rn_addr, ld_addr, crp.size);
        else // invoke decompression routine
        {
            unsigned char index = *ld_addr++;
            handler_fptr hndl = ((handler_fptr *)__TI_Handler_Table_Base)[index];
            (*hndl)(ld_addr, rn_addr);
        }
    }
}

```

### 14.3 Compressed Data Formats

Abstractly, compressed source data has the following format:

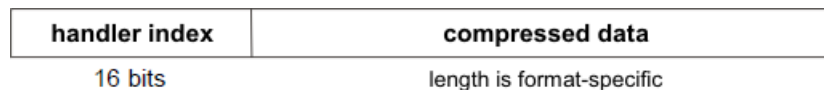

**Figure 14-3. Compressed Source Data Format**

The handler index specifies the decode function, which interprets the rest of the data. There are currently two supported compression formats for copy tables: Run-length encoding (RLE) and Lempel-Ziv Storer and Szymanski compression (LZSS).

#### 14.3.1 RLE

The data following the 16-bit index is compressed using run length encoded (RLE) format. The C28x uses a simple run length encoding that can be decompressed using the following algorithm:

1. Read the first 16 bits and assign it as the delimiter (D).
2. Read the next 16 bits (B).
3. If B != D, copy B to the output buffer and go to step 2.
4. Read the next 16 bits (L).
5. If L > 0 and L < 4 copy D to the output buffer L times. Go to step 2.
6. If L = 4 read the next 16 bits (B'). Copy B' to the output buffer L times. Go to step 2.
7. If L == 0, then read the next 16 bits (L):
  - If L == 0, then we've reached the end of the data, so go to step 10.
  - If L is the most significant 16 bits of the 32-bit run length, save it as L.hi and read the next 16 bits, which are the least significant 16 bits of the 32-bit run length, L.lo. Concatenate L.hi with L.lo to form the 32-bit run length L.
8. Read the next 16-bits, the repeat character (C).
9. Copy C to the output buffer L times. Go to step 2.
10. End of processing.

The RLE handler function in the TI toolchain is called `__TI_decompress_rle`.

#### 14.3.2 LZSS Format

The data following the 16-bit index is compressed using LZSS compression. The LZSS handler function in the TI toolchain is called `__TI_decompress_lzss`. Refer to the implementation of this function in the RTS source code for details on the format.

The decompression algorithm for LZSS is as follows:

1. Read 16 bits, which are the encoding flags (F) marking the start of the next LZSS encoded packet.
2. For each bit (B) in F, starting from the least significant to the most significant bit, do the following:
  - a. If (B & 0x1), read the next 16 bits and write it to the output buffer. Then advance to the next bit (B) in F and repeat this step.
  - b. Else read the next 16-bits into temp (T), length (L) = (T & 0xf) + 2, and offset (O) = (T >> 4).
    - i. If L == 17, read the next 16-bits (L'); then L += L'.
    - ii. If O == LZSS end of data (LZSS\_EOD), we've reached the end of the data, and the algorithm is finished.
    - iii. At position (P) = output buffer - Offset (O) - 1, read L bytes from position P and write them to the output buffer.
    - iv. Go to step 2a.

## 14.4 Variable Initialization

As described in [Section 4.1](#), initialized read-write variables are collected into dedicated section(s) of the object file, for example `.data`. The section contains an image of its initial state upon program startup.

The TI toolchain supports two models for loading such sections. In the so-called *RAM model*, some unspecified external agent such as a loader is responsible for getting the data from the executable file to its location in read-write memory. This is the typical direct-initialization model used in OS-based systems or, in some instances, boot-loaded systems.

The other model, called the *ROM model*, is intended for bare-metal embedded systems that must be capable of cold starts without support of an OS or other loader. Any data needed to initialize the program must reside in persistent offline storage (ROM), and get copied into its RAM location upon startup. The TI toolchain implements this by leveraging the copy table capability described in [Chapter 14](#). The initialization mechanism is conceptually similar to copy tables, but differs slightly in the details.

[Figure 14-4](#) depicts the conceptual operation of variable initialization under the ROM model. In this model, the linker *removes* the data from sections that contain initialized variables. The sections become uninitialized sections, allocated into RAM at their run-time address (much like, say, `.bss`). The linker encodes the initialization data into a special section called `.cinit` (for C Initialization), where the startup code from the run-time library decodes and copies it to its run address.

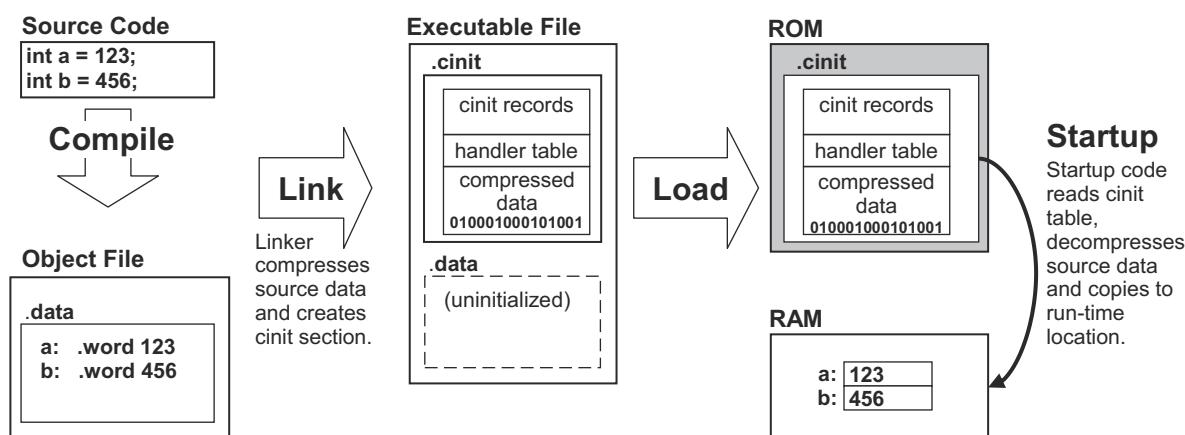

**Figure 14-4. ROM-Based Variable Initialization Via cinit**

Like copy tables, the source data in the `.cinit` tables may or may not be compressed. If it is compressed, the encoding and decoding scheme is identical to that of copy tables so that the handler tables and decompression handlers can be shared.

The `.cinit` section contains some or all of the following items:

- The **cinit table**, consisting of cinit records, which are similar to copy records.
- The **handler table**, consisting of pointers to decompression routines, as described in [Section 14.2](#). The handler table and handlers are shared by initialization and copy tables.
- The **source data**, consisting of compressed or uncompressed data used to initialize variables.

These items may be in any order.

Figure 14-5 is a schematic depiction of the .cinit section.

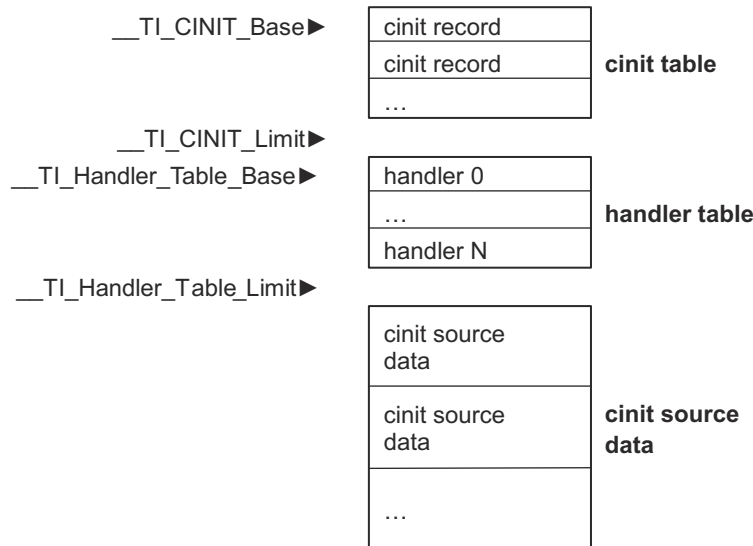

Figure 14-5. The .cinit Section

The .cinit section has the section type `SHT_TI_INITINFO` which identifies it as being in this format. Tools should rely on the section type and not on the name .cinit.

Two special symbols are defined to delimit the cinit table: `__TI_CINIT_Base` points to the cinit table, and `__TI_CINIT_Limit` points 16 bits past the end of the table. The startup code references the table using these symbols.

Records in the cinit table have the following format:

```
typedef struct
{
    uint32 source_data;
    uint32 dest;
} CINIT_RECORD;
```

- The **source\_data** field points to the source data in the cinit section.
- The **dest** field points to the destination address. Unlike copy table records, cinit records do not contain a size field; the size is always encoded in the source data.

The source data has the same format as compressed copy table source data (see [Section 14.2](#)), and the handlers have the same interface. In addition to the RLE and LZSS formats, there are two additional formats defined for cinit records: uncompressed, and zero-initialized.

- The explicit **uncompressed** format is required because unlike a copy table record, there is no overloaded size field in a cinit record. The size field is always encoded into the source data, even when no compression is used. The encoding is as follows:

handler index	padding	size	data
16 bits	16 bits	32 bits	size number of 16-bit data chunks

The encoded data includes a size field, which is aligned on the next 32-bit boundary following the handler index. The size field specifies how many 16-bit units of data are in the data payload, which begins immediately following the size field. The initialization operation copies *size* 16-bit units of data from the data field to the destination address. The TI run-time library contains a handler called `__TI_decompress_none` for the uncompressed format.

- The **zero-initialization** format is a compact format used for the common case of variables whose initial value is zero. The encoding is as follows:

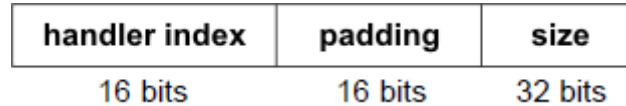

The size field is aligned on the next 32-bit boundary following the handler index. The initialization operation fills *size* consecutive 16-bit units of data at the destination address with zero. The TI run-time library contains a handler called `__TI_zero_init` for this format.

As an optimization, the linker is free to coalesce initializations of adjacent objects into single cinit records if they can be profitably encoded using the same format. This is typically significant for zero-initialized objects.



Changes from June 3, 2022 to October 31, 2023 (from Revision Y (June 2022) to Revision Z (October 2023))	Page
• Corrected information about e_machine field in ELF header.....	70

---

[Table 15-1](#) lists changes made since earlier versions of this document were published.

**Table 15-1. Revision History**

	Location	Additions / Modifications / Deletions
SPRAC71A	<a href="#">Section 11.5.1</a>	Added R_C28X_ABS22_BR and R_C28X_ABSLO6_BLKD relocation types.

## IMPORTANT NOTICE AND DISCLAIMER

TI PROVIDES TECHNICAL AND RELIABILITY DATA (INCLUDING DATA SHEETS), DESIGN RESOURCES (INCLUDING REFERENCE DESIGNS), APPLICATION OR OTHER DESIGN ADVICE, WEB TOOLS, SAFETY INFORMATION, AND OTHER RESOURCES "AS IS" AND WITH ALL FAULTS, AND DISCLAIMS ALL WARRANTIES, EXPRESS AND IMPLIED, INCLUDING WITHOUT LIMITATION ANY IMPLIED WARRANTIES OF MERCHANTABILITY, FITNESS FOR A PARTICULAR PURPOSE OR NON-INFRINGEMENT OF THIRD PARTY INTELLECTUAL PROPERTY RIGHTS.

These resources are intended for skilled developers designing with TI products. You are solely responsible for (1) selecting the appropriate TI products for your application, (2) designing, validating and testing your application, and (3) ensuring your application meets applicable standards, and any other safety, security, regulatory or other requirements.

These resources are subject to change without notice. TI grants you permission to use these resources only for development of an application that uses the TI products described in the resource. Other reproduction and display of these resources is prohibited. No license is granted to any other TI intellectual property right or to any third party intellectual property right. TI disclaims responsibility for, and you will fully indemnify TI and its representatives against, any claims, damages, costs, losses, and liabilities arising out of your use of these resources.

TI's products are provided subject to [TI's Terms of Sale](#) or other applicable terms available either on [ti.com](https://www.ti.com) or provided in conjunction with such TI products. TI's provision of these resources does not expand or otherwise alter TI's applicable warranties or warranty disclaimers for TI products.

TI objects to and rejects any additional or different terms you may have proposed.

Mailing Address: Texas Instruments, Post Office Box 655303, Dallas, Texas 75265  
Copyright © 2023, Texas Instruments Incorporated