

# ***Code Composer Studio Development Tools v3.3***

## ***Getting Started Guide***

Literature Number: SPRU509H  
October 2006





<b>Preface</b> .....	<b>9</b>
<b>1 Introduction</b> .....	<b>11</b>
1.1 Welcome to the World of eXpressDSP™ .....	12
1.2 Development Flow .....	13
<b>2 Getting Started Quickly</b> .....	<b>15</b>
2.1 Launching the Code Composer Studio Development Tools.....	16
2.1.1 Important Icons Used in Code Composer Studio .....	16
2.2 Creating a New Project.....	16
2.3 Building Your Program.....	17
2.4 Loading Your Program.....	17
2.5 Basic Debugging .....	17
2.5.1 Go to Main .....	17
2.5.2 Using Breakpoints.....	17
2.5.3 Source Stepping.....	18
2.5.4 Viewing Variables .....	18
2.5.5 Output Window .....	18
2.5.6 Symbol Browser .....	18
2.6 Introduction to Help .....	18
<b>3 Target and Host Setup</b> .....	<b>19</b>
3.1 Setting Up the Target .....	20
3.1.1 Code Composer Studio Setup Utility .....	20
3.1.2 Parallel Debug Manager.....	23
3.1.3 Connect/Disconnect.....	23
3.1.4 Status Bar .....	24
3.2 Host IDE Customization .....	24
3.2.1 Default Colors and Faults .....	24
3.2.2 Default Keyboard Shortcuts.....	25
3.2.3 Other IDE Customizations .....	25
<b>4 Code Creation</b> .....	<b>27</b>
4.1 Configuring Projects .....	28
4.1.1 Creating a Project .....	28
4.1.2 Project Configurations .....	30
4.1.3 Project Dependencies .....	31
4.1.4 Makefiles .....	32
4.1.5 Source Control Integration .....	33
4.2 Text Editor.....	34
4.2.1 Viewing and Editing Code.....	34
4.2.2 Customizing the Code Window.....	34
4.2.3 Using the Editor's Text Processing Functionality .....	35
4.2.4 Setting Auto-Save Defaults .....	36
4.2.5 Autocompletion, Tooltips and Variable Watching (CodeSense) .....	36
4.2.6 Using an External Editor.....	37
4.3 Code Generation Tools.....	38

4.3.1	Code Development Flow .....	38
4.3.2	Project Build Options .....	38
4.3.3	Compiler Overview .....	40
4.3.4	Assembly Language Development Tools .....	40
4.3.5	Assembler Overview .....	40
4.3.6	Linker Overview .....	41
4.3.7	C/C++ Development Tools .....	41
4.4	Building Your Code Composer Studio Project .....	42
4.4.1	From Code Composer Studio.....	42
4.4.2	External Make .....	42
4.4.3	Command Line .....	43
4.5	Available Foundation Software .....	43
4.5.1	DSP/BIOS .....	43
4.5.2	Chip Support Library (CSL) .....	44
4.5.3	Board Support Library (BSL).....	44
4.5.4	DSP Library (DSPLIB) .....	44
4.5.5	Image/Video Processing Library (IMGLIB).....	45
4.5.6	TMS320 DSP Algorithm Standard Components .....	46
4.5.7	Reference Frameworks.....	47
4.6	Automation (for Project Management).....	49
4.6.1	Using General Extension Language (GEL) .....	49
4.6.2	Scripting Utility .....	49
<b>5</b>	<b>Debug .....</b>	<b>51</b>
5.1	Setting Up Your Environment for Debug .....	52
5.1.1	Setting Custom Debug Options .....	52
5.1.2	Simulation .....	55
5.1.3	Memory Mapping .....	55
5.1.4	Pin Connect .....	57
5.1.5	Port Connect .....	57
5.1.6	Program Load.....	58
5.2	Basic Debugging .....	59
5.2.1	Running/Stepping .....	59
5.2.2	Breakpoints.....	60
5.2.3	Connecting Breakpoints to Files.....	63
5.2.4	Watch Window.....	65
5.2.5	Property Page Manager Window.....	67
5.2.6	Memory Window.....	68
5.2.7	Register Window .....	70
5.2.8	Disassembly/Mixed Mode .....	72
5.2.9	Call Stack.....	72
5.2.10	Symbol Browser .....	73
5.2.11	Command Window .....	73
5.2.12	Memory Save/Load Utility .....	74
5.2.13	C6000 Functional Simulators Interrupt Latency Detection Feature.....	74
5.2.14	Cache Coherence .....	74
5.2.15	Cache Tag RAM Viewer.....	75
5.2.16	Exception Reporting .....	77
5.2.17	Software Pipelined Loop (SPLOOP) Buffer.....	78

---

5.2.18	MMU Page Table Viewer.....	78
5.3	Advanced Debugging Features .....	79
5.3.1	Advanced Event Triggering (AET) .....	79
5.4	Real-Time Debugging .....	81
5.4.1	Real-Time Mode .....	81
5.4.2	Rude Real-Time Mode.....	82
5.4.3	Real-Time Data Exchange (RTDX) .....	83
5.5	Automation (for Debug).....	86
5.5.1	Using the General Extension Language (GEL) .....	86
5.5.2	Scripting Utility for Debug .....	86
5.6	Reset Options.....	86
5.6.1	Target Reset .....	86
5.6.2	Emulator Reset .....	87
5.6.3	Advanced Resets.....	87
5.6.4	Halt on Reset .....	87
<b>6</b>	<b>Analyze/Tune .....</b>	<b>89</b>
6.1	Application Code Analysis .....	90
6.1.1	Data Visualization .....	90
6.1.2	Simulator Analysis.....	91
6.1.3	Emulator Analysis .....	91
6.1.4	DSP/BIOS Real-Time Analysis (RTA) Tools.....	91
6.1.5	Code Coverage and Multi-Event Profiler Tool .....	94
6.2	Application Code Tuning (ACT) .....	94
6.2.1	Tuning Dashboard.....	94
6.2.2	Compiler Consultant .....	96
6.2.3	Cache Tune .....	96
<b>7</b>	<b>Additional Tools, Help, and Tips .....</b>	<b>99</b>
7.1	Component Manager .....	100
7.1.1	Opening Component Manager .....	101
7.1.2	Multiple Versions of Code Composer Studio.....	101
7.2	Update Advisor.....	101
7.2.1	Registering Update Advisor .....	101
7.2.2	Checking for Tool Updates .....	101
7.2.3	Automatically Checking for Tool Updates .....	102
7.2.4	Uninstalling the Updates .....	102
7.3	Additional Help .....	102
7.3.1	Online Help .....	102
7.3.2	Online Tutorial.....	102

---

## List of Figures

1-1	eXpress DSP™ Software and Development Tools .....	12
1-2	Simplified Code Composer Studio Development Flow .....	13
2-1	Icons on the Code Composer Studio Toolbar .....	16
3-1	Standard Setup Configurations .....	20
3-2	GEL File Configuration .....	22
3-3	Parallel Debug Manager .....	23
3-4	Modifying Keyboard Shortcuts .....	25
4-1	Project Creation Wizard .....	28
4-2	Code Composer Studio Control Window .....	29
4-3	Add Files to Project .....	29
4-4	Configuration Toolbar .....	30
4-5	Add Project Configurations .....	31
4-6	Project Configuration Dependencies .....	32
4-7	Source Control Integration .....	33
4-8	Elements in the Source Code Window .....	34
4-9	Using Regular Expressions with the Text Editor .....	35
4-10	Selective Display .....	36
4-11	Code Sense .....	37
4-12	Code Development Flow .....	38
4-13	Build Options Dialog Box .....	39
4-14	TMS320 DSP Algorithm Standard Elements .....	46
4-15	Reference Framework Elements .....	48
5-1	Disassembly Style .....	54
5-2	Memory Map .....	55
5-3	Data Offset .....	58
5-4	Toolbar Icons for Running and Debugging .....	59
5-5	Breakpoint Manager .....	61
5-6	Sample Parameter Dialog .....	64
5-7	Data File Control .....	64
5-8	Watch Locals Tab .....	65
5-9	Specifying a Variable to Watch .....	66
5-10	Watch Element Values .....	66
5-11	Property Window .....	67
5-12	Memory Window .....	68
5-13	Memory Window Options .....	68
5-14	Register Window .....	70
5-15	Editing a Registry Value .....	71
5-16	Customize Register Groups .....	71
5-17	Register Window with Customized Register Group .....	71
5-18	Disassembly Window .....	72
5-19	Call Stack Window .....	72
5-20	Symbol Browser Window .....	73
5-21	Command Window .....	73
5-22	Cache Tag RAM Viewer .....	75
5-23	Cache Tag RAM Viewer Property Page .....	76
5-24	Exceptions Window .....	77
5-25	Event Analysis Window .....	80
5-26	Event Sequencer .....	81
5-27	RTDX Data Flow .....	83
5-28	RTDX Diagnostics Window .....	84
5-29	RTDX Configuration Window .....	84
5-30	RTDX Channel Viewer Window .....	85

---

6-1	Sample Graph Properties Dialog .....	90
6-2	Example Graph .....	90
6-3	Real-Time Capture and Analysis .....	92
6-4	DSP/BIOS RTA Toolbar .....	92
6-5	Goals Window .....	95
6-6	Cache Tune Tool .....	97
7-1	Component Manager .....	100
7-2	Update Advisor Web Settings .....	102

---

## List of Tables

4-1	CodeWright Text Editor: A Quick Reference .....	35
5-1	GEL Functions for Memory Maps .....	56



## ***Read This First***

---

---

---

### **About This Manual**

To get started with Code Composer Studio™ (CCStudio) Development Tools, review the first two sections of this book. The remaining sections contain more detailed information on specific processes and tools. To determine whether you can utilize these features, see the online help provided with the Code Composer Studio installation.

### **Trademarks**

Code Composer Studio, CCStudio, DSP/BIOS, RTDX, TMS320C2000, TMS320C6000, C6000, TMS320C62x, TMS320C64x, TMS320C67x, C62x, C64x, C67x, TMS320C5000, TMS320C55x, C55x, and C54x are trademarks of Texas Instruments Incorporated. The Texas Instruments logo and Texas Instruments are registered trademarks of Texas Instruments Incorporated.

Intel, Pentium are trademarks of Intel Corporation or its subsidiaries in the United States and other countries.

Windows and Windows NT are registered trademarks of Microsoft Corporation.

All trademarks are the property of their respective owners.



## ***Introduction***

---

---

---

This section introduces TI's eXpressDSP technology initiative. It also includes a simplified development flow for Code Composer Studio development tools.

<b>Topic</b>	<b>Page</b>
<b>1.1 Welcome to the World of eXpressDSP™ .....</b>	<b>12</b>
<b>1.2 Development Flow.....</b>	<b>13</b>

## 1.1 Welcome to the World of eXpressDSP™

TI has a variety of development tools available that enable quick movement through the digital signal processor (DSP) based application design process from concept, to code/ build, through debug analysis, tuning, and on to testing. Many of the tools are part of TI's real-time eXpressDSP™ software and development tool strategy, which is very helpful in quickly getting started as well as saving valuable time in the design process. TI's real-time eXpressDSP Software and Development Tool strategy includes three components that allow developers to use the full potential of TMS320™ DSPs:

- Powerful DSP-integrated development tools in Code Composer Studio
- eXpressDSP Software, including:
  - Scalable, real-time software foundation: DSP/BIOS™ kernel
  - Standards for application interoperability and reuse: TMS320 DSP Algorithm Standard
  - Design-ready code that is common to many applications to get you started quickly on DSP design: eXpressDSP Reference Frameworks
- A growing base of TI DSP-based products from TI's DSP Third Party Network, including eXpressDSP-compliant products that can be easily integrated into systems

**Figure 1-1. eXpress DSP™ Software and Development Tools**

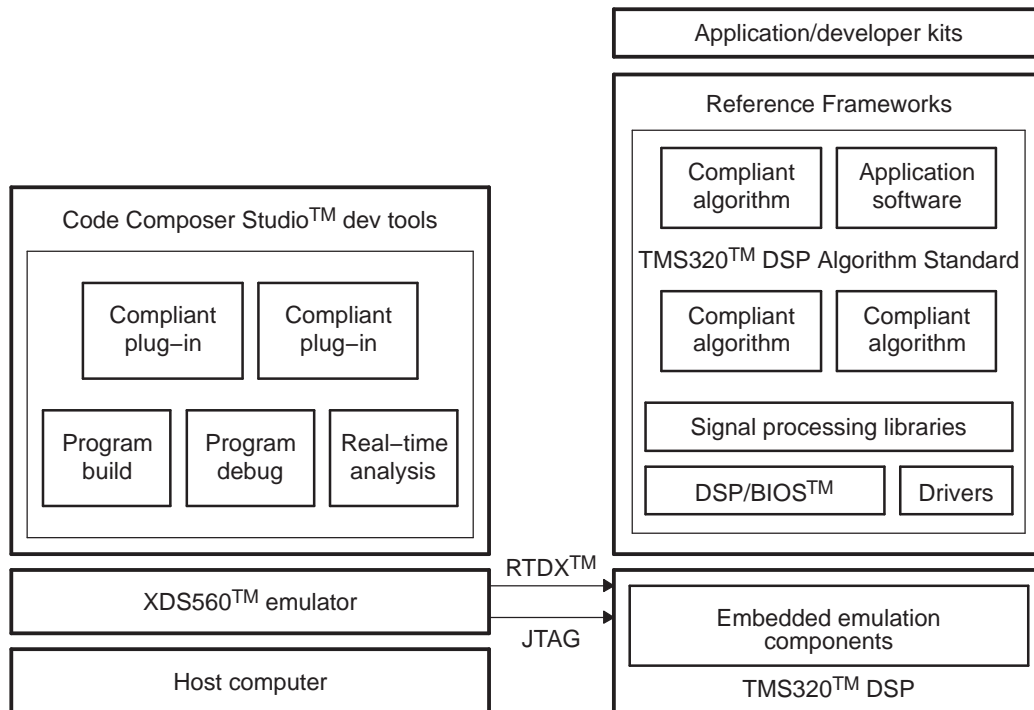

## 1.2 Development Flow

The development flow of most DSP-based applications consists of four basic phases: application design, code creation, debug, and analysis/tuning. This user's guide will provide basic procedures and techniques in program development flow using Code Composer Studio.

**Figure 1-2. Simplified Code Composer Studio Development Flow**

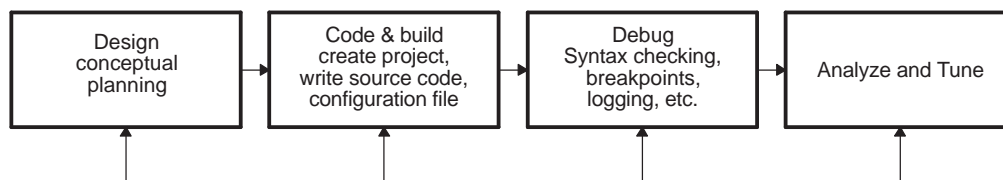



## Getting Started Quickly

---

---

---

This section introduces some of the basic features and functions in Code Composer Studio so you can create and build simple projects. Experienced users can proceed to the following sections for more in-depth explanations of Code Composer Studio's various features.

Topic	Page
2.1 Launching the Code Composer Studio Development Tools.....	16
2.2 Creating a New Project .....	16
2.3 Building Your Program .....	17
2.4 Loading Your Program .....	17
2.5 Basic Debugging.....	17
2.6 Introduction to Help .....	18

## 2.1 Launching the Code Composer Studio Development Tools

To launch Code Composer Studio IDE for the first time, click the icon (shown below) on your desktop. A simulator is automatically configured by default. To configure Code Composer Studio for a specific target, see [Chapter 3](#) for more information.

### 2.1.1 Important Icons Used in Code Composer Studio

These icons will be referred to throughout this manual.

**Figure 2-1. Icons on the Code Composer Studio Toolbar**

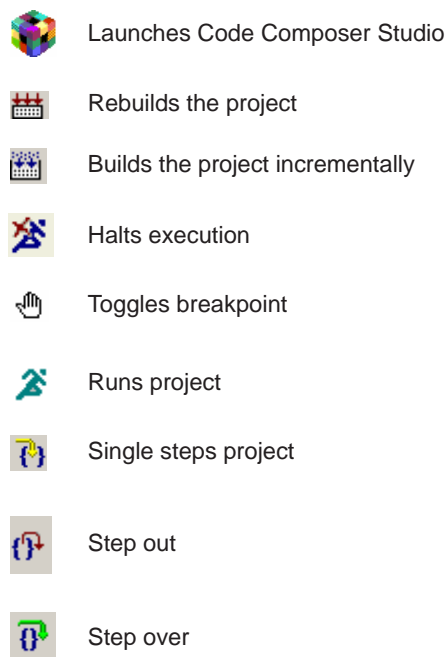

## 2.2 Creating a New Project

To create a working project, follow these steps:

1. If you installed Code Composer Studio in C:\CCStudio\_v3.3, create a folder called practice in the C:\CCStudio\_v3.3\myprojects folder.
2. Copy the contents of C:\CCStudio\_v3.3\tutorial\target\consultant folder to this new folder. Target refers to the current configuration of Code Composer Studio. There is no default configuration, you must set a configuration before starting Code Composer Studio. See [Chapter 3](#) for more about Code Composer Studio configurations.
3. Launch Code Composer Studio.
4. From the CCStudio Project menu, choose New.
5. In the Project Name field, type the project name (practice).
6. In the Location field, type or browse to the folder you created in step 1.
7. By default, Project Type is set as Executable (.out) and Target is set as the current configuration of Code Composer Studio.
8. Click Finish. Code Composer Studio creates a project file called practice.pjt. This file stores your project settings and references the various files used by your project.
9. Add files to the project by choosing Add Files to Project from the Project menu. You can also right-click the project in the Project View window on the left and then select Add Files to Project.



10. Add main.c, DoLoop.c, and Ink.cmd (this is a linker command file that maps sections to memory) from the folder you created. You may need to choose All Files from the Files of type dropdown box to view all the types of files.
11. Next, choose Add Files to Project again and browse to the C:\CCStudio\_v3.3\target\cgtools\lib\ directory and add the rts.lib file for your configured target.
12. You do not need to manually add any include files to your project, because the program finds them automatically when it scans for dependencies as part of the build process. After you build your project, the include files appear in the Project View.

## 2.3 Building Your Program

Now that you have created a functional program, you can build it. Use the Project→Rebuild All function the first time you build the project. An output window will show the build process and status. When the build is finished, the output window will display *Build complete 0 errors, 0 warnings*.

The Rebuild All command is mainly used to rebuild the project when the project options or any files in the project have changed. For further information, see [Section 2.3](#).

## 2.4 Loading Your Program

After the program has been built successfully, load the program by going to File→Load Program. By default, Code Composer Studio IDE will create a subdirectory called Debug within your project directory and store the .out file in it. Select practice.out and click Open to load the program.

---

**Note:** Remember to reload the program by choosing File→Reload Program if you rebuild the project after making changes.

---

## 2.5 Basic Debugging

To see Code Composer Studio's versatile debugger in action, complete the following exercises. For more in-depth information, see [Chapter 5](#).

### 2.5.1 Go to Main

To begin execution of the Main function, select Debug→Go Main. The execution halts at the Main function and you will notice the program counter (yellow arrow) in the left margin beside the function. This is called the selection margin.

### 2.5.2 Using Breakpoints

To set a breakpoint, place the cursor on the desired line and press F9. In addition, you can set the breakpoint by selecting the Toggle Breakpoint toolbar button. When a breakpoint has been set, a red icon will appear in the selection margin. To remove the breakpoint, simply press F9 or the Toggle Breakpoint toolbar button again. You can also open the Breakpoints Manager (Debug→Breakpoints) to view all the breakpoints, set new ones, or change the breakpoint action.

In main.c, set a breakpoint at the line: DoLoop(Input1, Input2, Weights, Output, LOOPCOUNT);As execution was halted at the main function, you can press F5, select Debug→Run, or select the Run toolbar button to run the program. Once execution reaches the breakpoint, it halts, as displayed in the status bar at the bottom of the CCStudio window.

### 2.5.3 Source Stepping

Source stepping is only possible when program execution has been halted. Since you halted at the breakpoint, you can now execute the program line by line using source stepping. Step into the DoLoop function by selecting the Source-Single Step button on the side toolbar. Step through a few times to observe the executions. The Step Over and Step Out functions are also available below the Single Step button. Assembly stepping is also available. Whereas source stepping steps through the lines of code, assembly stepping steps through the assembly instructions. For more information on assembly stepping, see [Section 5.2.1](#).

### 2.5.4 Viewing Variables

In the debugging process, you should view the value of the variables to ensure that the function executes properly. Variables can be viewed in the watch window when the CPU has been halted. The watch window can be opened by selecting View→Watch Window. The Watch Locals tab shows all the relevant variables in the current execution.

As you continue to Step Into the while loop, the values of the variables change through each execution. In addition, you can view the values of specific variables by hovering the mouse pointer over the variable or by placing the variables in the Watch1 tab. For more information on variables and watch windows, see [Section 5.2.4](#).

### 2.5.5 Output Window

The Output window is located at the bottom of the screen by default. It can also be accessed by View→Output Window. By default, the printf function displays the same Output window, showing information such as the contents of Stdout and the build log.

### 2.5.6 Symbol Browser

The symbol browser allows you to access all the components in your project with a single click. Select View→Symbol Browser to open the window. The symbol browser has multiple tabs, including tabs for Files, Functions, and Globals.

Expanding the tree in the Files tab shows the source files in your project. Double-clicking on files in the Files or Functions tabs automatically accesses the file. The Globals tab allows you to access the global symbols in your project.

For more information on the Symbol browser, see [Section 5.2.10](#).

You should now have successfully created, built, loaded, and debugged your first Code Composer Studio program.

## 2.6 Introduction to Help

Code Composer Studio provides many help tools through the Help menu. Select Help→Contents to search by contents. Select Help→Tutorial to access tutorials to guide you through the Code Composer Studio development process.

Select Help→Web Resources to obtain the most current help topics and other guidance. User manuals are PDF files that provide information on specific features or processes.

You can access updates and a number of optional plug-ins through Help→Update Advisor.

## Target and Host Setup

---

---

---

This section provides information on how to define and set up your target configuration for both single processor and multiprocessor configurations, and how to customize several general IDE options.

Topic	Page
3.1 Setting Up the Target.....	20
3.2 Host IDE Customization .....	24

## 3.1 Setting Up the Target

### 3.1.1 Code Composer Studio Setup Utility

This section provides information on how to define and set up your target configuration for both single processor and multiprocessor configurations, and how to customize several general IDE options.

#### 3.1.1.1 Adding an Existing Configuration

The Setup utility allows you to configure the software to work with different hardware or simulator targets. You must select a configuration in Setup before starting the Code Composer Studio IDE.

You can create a configuration using the provided standard configuration files, or create a customized configuration using your own configuration files (see the online help and/or the tutorial). This example uses the standard configuration files.

To create a system configuration using a standard configuration file:

1. Double-click on the Setup CCStudio desktop icon. The System Configuration dialog box appears.
2. From the list of Available Factory Boards, select the standard configuration that matches your system. Your list of available boards will differ depending on your installation. Determine if one of the available configurations matches your system. If none are adequate, you can create a customized configuration (see the online help and/or the tutorial).

Figure 3-1. Standard Setup Configurations

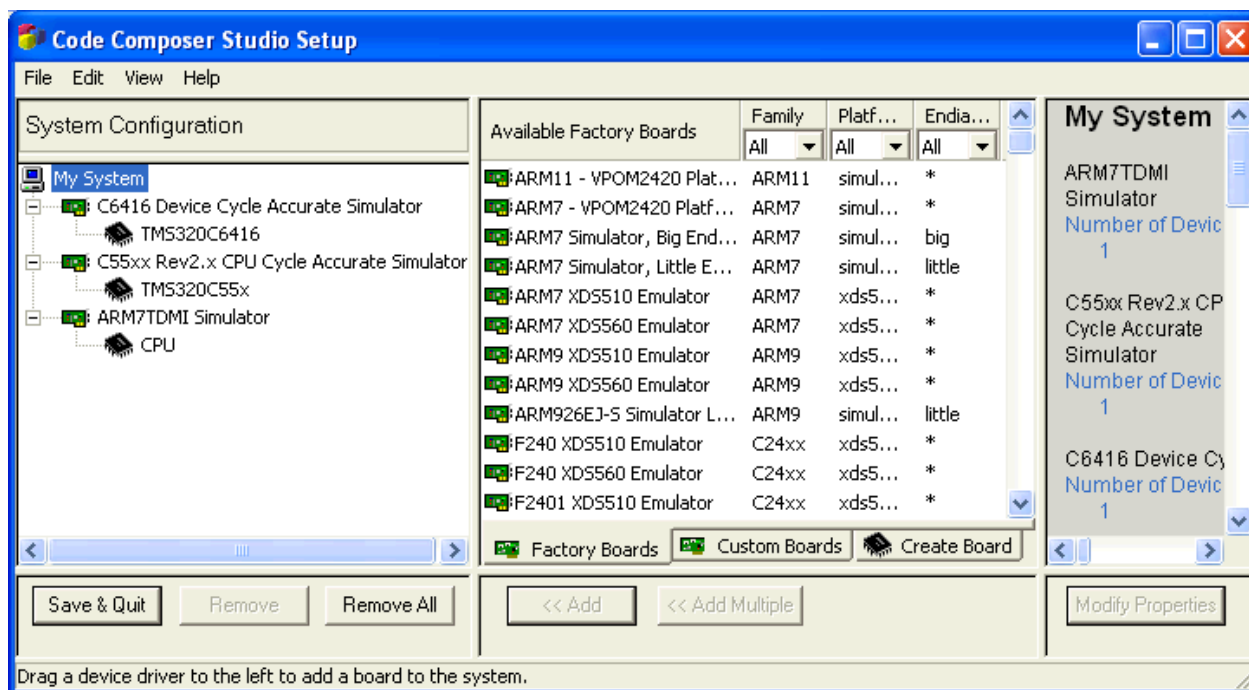

3. Click the Add button to import your selection to the system configuration currently being created. The configuration you selected now displays under the My System icon in the System Configuration pane of the Setup window. If your configuration has more than one target, repeat these steps until you have selected a configuration for each board.
4. Click the Save & Quit button to save the configuration.
5. Click the Yes button to start the Code Composer Studio IDE with your configuration. You can now start a project. See [Chapter 4](#) of this book, or the online help and tutorial for more information.

### 3.1.1.2 Creating a New System Configuration

To set up a new system configuration, start with the Code Composer Studio Setup dialog box.

Start with a blank working configuration by selecting Remove All from the File menu. (You may also start with a standard or imported configuration that is close to your desired system. In that case, begin at step three below after loading the starting configuration).

1. Select the My System icon in the System Configuration pane.
2. In the Available Factory Boards pane, select a target board or simulator that represents your system. With your mouse drag the board that you want to the left screen under My System, or click on the Add button. To find the correct board, you can filter the list of boards by family, platform and endianness. If you wish, you can drag more than one board to the left panel under My System.
3. If you want to use a target board or simulator that is not listed in the Available Factory Boards pane, you must install a suitable device driver now. (For example, you may have received a device driver from a third-party vendor or you may want to use a driver from a previous version of Code Composer Studio.) Proceed to the Installing/Uninstalling Device Drivers help topic (from the main CCStudio program, select Help→Contents→Code Composer Studio Setup→How To Start→Installing/Uninstalling Device Drivers) and then continue with this section to complete your system configuration.
4. Click on the processor type you have just added, and open the Connection Properties dialog box using one of the following procedures:
  - Right-click on the processor type in the System Configuration pane and select Properties from the context menu. If you have selected the current processor, selecting Properties will display the Processor Properties dialog.
  - Select the processor type in the System Configuration pane and then select the Modify Properties button in the right-hand pane.
5. Edit the information in the Connection Properties dialog.
6. The starting GEL file, the Master/Slave value, the Startup mode, and the BYPASS name and bit numbers are included in the Processor Properties dialog. To access the Processor Properties dialog, right-click on the desired processor and choose Properties from the context menu. Other properties may be available, depending on your processor. When configuring simulators, multiple properties may appear with default values based on the processor.  
The Connection Properties and Processor Properties dialogs may have tabs with different fields. The tabs that appear and the fields that can be edited will differ depending on the board or processor that you have selected. After filling in the information in each tab, you can click the Next button to go to the next tab, or simply click on the next tab itself. When you are done, click the Finish button.

For more information on configuring the Connection or Processor Properties dialogs, see the online help (Help→Contents→Code Composer Studio Setup→Custom Setup).

### 3.1.1.3 Creating Multiprocessor Configurations

The most common configurations include a single simulator or a single target board with a single CPU. However, you can create more complicated configurations in the following ways:

- Connect multiple emulators to your computer, each with its own target board.
- Connect more than one target board to a single emulator, using special hardware to link the scan paths on the boards.
- Create multiple CPUs on a single board, and the CPUs can be all of the same kind or they can be of different types (e.g., DSPs and microcontrollers).

Although a Code Composer Studio configuration is represented as a series of boards, in fact, each board is either a single CPU simulator or a single emulator scan chain that can be attached to one or more boards with multiple processors. The device driver associated with the board must be able to comprehend all the CPUs on the scan chain. More information may be found in the online help (Help→Contents→Code Composer Studio Setup→How To Start→Configuring CCStudio for Heterogeneous Debugging).

### 3.1.1.4 Startup GEL Files

The general extension language (GEL) is an interpretive language, similar to C. GEL functions can be used to configure the Code Composer Studio development environment. They can also be used to initialize the target CPU. A rich set of built-in GEL functions is available, or you can create your own user-defined GEL functions.

The GEL file field under the Processor Properties dialog allows you to associate a GEL file (.gel) with each processor in your system configuration. Access the Processor Properties dialog by selecting the current processor and choosing Properties from the context menu.

**Figure 3-2. GEL File Configuration**

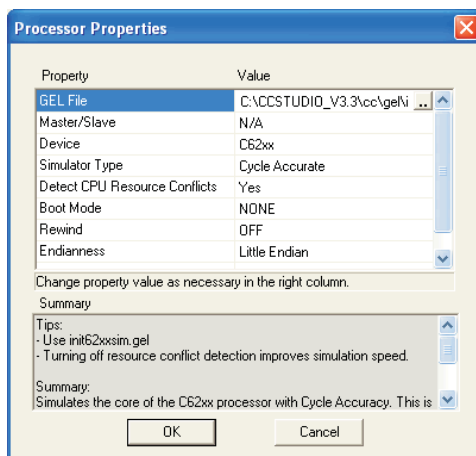

When Code Composer Studio is started, each startup GEL file is scanned and all GEL functions contained in the file are loaded. If the GEL file contains a StartUp() function, the code within that function is also executed. For example, the GEL mapping functions can be used to create a memory map that describes the processor's memory to the debugger.

```
StartUp(){ /*Everything in this function will be executed
on startup*/ GEL_MapOn(); GEL_MapAdd(0, 0, 0xF000, 1,
1); GEL_MapAdd(0, 1, 0xF000, 1, 1);}
```

GEL files are asynchronous and not synchronous; in other words, the next command in the GEL file will execute before the previous one completes. For more information, see the Code Composer Studio online help. Select Help→Contents→Making a Code Composer Project→Building & Running Your Project→Automating Tasks with General Extension Language (GEL).

### 3.1.1.5 Device Drivers

Special software modules called device drivers, are used to communicate with the target. Each driver file defines a specific target configuration: a target board and emulator, or simulator. Device drivers may either be supplied by Texas Instruments or by third-party vendors.

Each target board or simulator type listed in the Available Factory Boards pane is physically represented by a device driver file. Code Composer Studio IDE does not support creating device drivers, but TI or third parties may ship device drivers separately from those which are pre-installed.

### 3.1.2 Parallel Debug Manager

In multiprocessor configurations, invoking Code Composer Studio starts a special control known as the Parallel Debug Manager Plus (PDM+).

Figure 3-3. Parallel Debug Manager

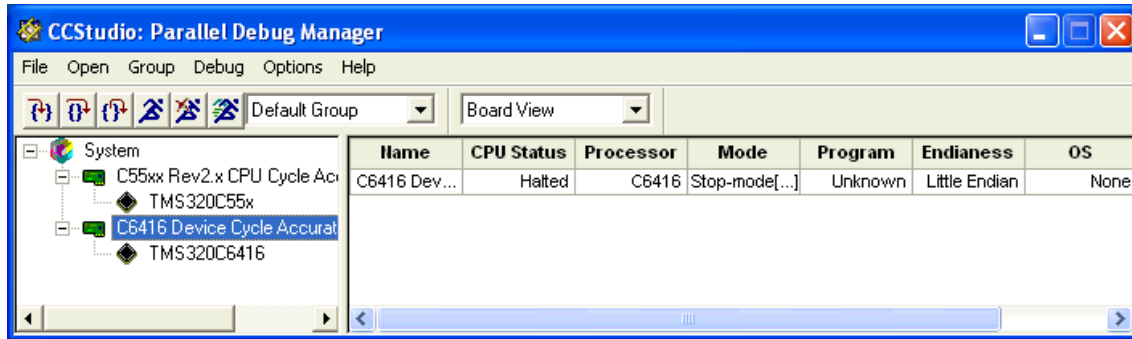

The Parallel Debug Manager allows you to open a separate Code Composer Studio IDE session for each target device. Activity on the specified devices can be controlled in parallel using the PDM control.

This version of Parallel Debug Manager (PDM+) includes the following features:

- You can connect or disconnect from targets on-the-fly by right-clicking the processor on the right panel.
- The interface allows an expanded view of processors, with several dropdown filters to reveal a list by group, by CPU or by board.
- Red highlighting on the processor icon (on the left pane) indicates that the processor is not connected to the system or that it has updated status information.
- You can put processors into loosely-coupled groups, (i.e., where the processors are not all on the same physical scan chain). Choosing Group View from the second dropdown menu on the toolbar and System on PDM's left pane shows which groups are synchronous.

Global breakpoints work only when processors in a group belong to the same physical scan chain. For further details on the Parallel Debug Manager, see the online help under Help→Contents→Debugging Windows and Analysis Tools→Parallel Debug Manager.

### 3.1.3 Connect/Disconnect

Code Composer Studio IDE makes it easy to dynamically connect and disconnect with the target by using the Connect/Disconnect functionality. Connect/Disconnect allows you to disconnect from your hardware target and even to restore the previous debug state when reconnecting.

By default, Code Composer Studio IDE will not attempt to connect to the target when the control window is opened. Connection to the target can be established by going to Debug→Connect. The default behavior can be changed in the Debug Properties tab under Option→Customize. The status bar will briefly flash a help icon to indicate changes in the target's status. When the target is disconnected, the status bar will indicate this fact, as well as the last known execution state of the target (i.e., halted, running, free running or error condition). When connected, the status bar will also indicate if the target is stepping (into, over, or out), and the type of breakpoint that caused the halt (software or hardware). See [Section 3.1.4](#) for more information on the status bar.

After a connection to the target (except for the first connection), a menu option entitled Restore Debug State will be available under the Debug Menu. Selecting this option will enable every breakpoint that was disabled at disconnect. You can also reset them by pressing F9 or by selecting Toggle Breakpoints from the right-click menu. Breakpoints from Advanced Event Triggering jobs and emulator analysis will not be enabled.

If the Parallel Debug Manager is open, you can connect to a target by right-clicking on the cell corresponding to the target device underneath the column marked Name. For further details on Connect/Disconnect, see the Code Composer Studio online help under Debugging Windows and Analysis Tools→The Debugging Process→Connect/Disconnect.



### 3.1.4 Status Bar

The status bar is displayed at the bottom of the Code Composer Studio application window. The status bar displays messages relating to the target's connect status along with a basic status indicator. The left side of the status indicator shows if the target is running or not. The right side of the status indicator turns yellow to indicate that the target was recently halted. This occurs when you manually halt the process, or when Code Composer Studio temporarily halts the target to carry out another internal process. The indicator will turn grey after a few seconds.

The status bar also shows messages about the current options used by CCStudio:

- **Process Mode (ARM processors only).** The status bar displays the name of the current mode used by the executed process. The options are:
  - ARM: Indicates that the process is in the ARM mode.
  - THUMB: Indicates that the process is in the Thumb mode.
- **Endianness.** The status bar denotes the Endianness sequencing method being used, with either LE (Little Endian) or BE (Big Endian).
- **Jazelle Indicator.** The word JAVA is displayed in the status bar when Jazelle is enabled.
- **MMU Indicator (ARM processors only).** The status bar displays either MMU Off or MMU On to indicate the status of the Memory Management Unit (MMU) mode. Note: This feature is only available for ARM 9 and ARM 11 targets.
- **Privileges (ARM processors only).** The status bar indicates the privilege mode for the application by displaying either USER mode or SUPERVISOR mode.
- **Task Level Debugging Indicator.** The status bar indicates the status of Task Level Debugging (TLD) by displaying TLD when TLD has been enabled on the device. Note: TLD support is not available for all operating systems.
- **Descriptions.** The center of the status bar displays text which describes the actions of individual menu commands and toolbar items as you hold the mouse cursor over them, and the path of the active source file window. The right area of the status bar shows the line and column position of the cursor when viewing a source file.
- **Profile Clock.** The Profile Clock is displayed on the right side of the status bar, if it has been enabled. See the Application Code Tuning Online Help for more information.

## 3.2 Host IDE Customization

Once Code Composer Studio is launched, you can customize several general IDE options.

### 3.2.1 Default Colors and Faults

Selecting the menu options Option→Font→Editor Font and Option→Color→Editor Color allows you to modify the default appearance (or View Setup) in the CodeWright text editor ([Section 4.2.2](#)). Selecting the menu options Option→Font→Tools Font or Tools Color allows you to modify the default appearance for various IDE tool windows.



### 3.2.2 Default Keyboard Shortcuts

The default IDE has more than 80 predefined keyboard shortcuts that can be modified. New keyboard shortcuts can be created for any editing or debugging commands that can be invoked from a document window. To assign keyboard shortcuts:

1. Select Option→Customize.
2. In the Customize dialog box, select the Keyboard tab to view the following options:
  - **Filename.** The standard keyboard shortcuts file is displayed by default. To load a previous keyboard configuration file (\*.key), enter the path and filename, or navigate to the file.
  - **Commands.** Select the command you want to assign to a keyboard shortcut.
  - **Assigned Keys.** Displays the keyboard shortcuts that are assigned to the selected command.
  - **Add.** Click the Add button to assign a new key sequence for invoking the selected command. In the Assign Shortcut dialog box, enter the new key sequence, and then click OK.
  - **Remove.** To remove a particular key sequence for a command, select the key sequence in the Assigned Keys list and click the Remove button.
  - **Default Keys.** Immediately reverts to the default keyboard shortcuts.
  - **Save As.** Click the Save As button to save your custom keyboard configuration in a file. In the Save As dialog box, navigate to the location where you want to save your configuration, name the keyword configuration file, and click Save.

**Figure 3-4. Modifying Keyboard Shortcuts**

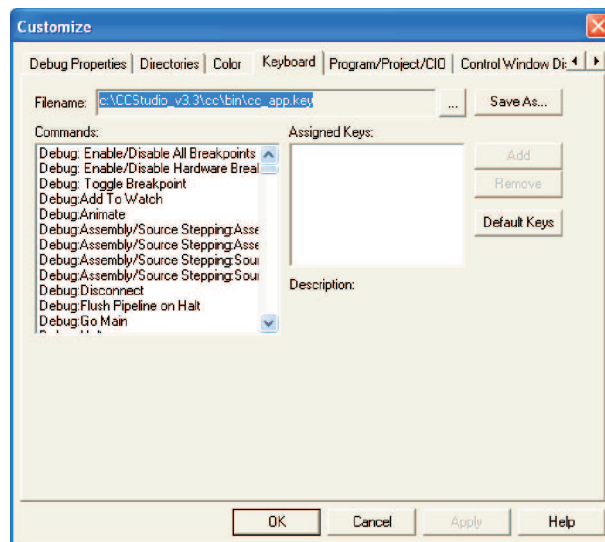

3. Click OK to exit the dialog box.

### 3.2.3 Other IDE Customizations

- Specify the number of recent files on the File menu by selecting Option→Customize→File Access.
- Remember a project's active directory by selecting Option→Customize→File Access. When you switch projects, you can specify whether the IDE will start you inside the directory of your active project or inside the last directory you used.
- Set what kind of information (processor type, project name, path, etc.) appears in the title bar by selecting Option→Customize→Control Window Display.
- Set default closing options by selecting Option→Customize→Control Window Display. You can specify that the IDE should automatically close all windows when you close a project. Or you can choose to close all projects whenever you close a control window.
- Customize the code window using CodeWright (see [Section 4.2.2](#)).



## Code Creation

---

---

---

This describes the options available to create code and build a basic Code Composer Studio IDE project.

Topic	Page
4.1 Configuring Projects .....	28
4.2 Text Editor .....	34
4.3 Code Generation Tools .....	38
4.4 Building Your Code Composer Studio Project .....	42
4.5 Available Foundation Software .....	43
4.6 Automation (for Project Management) .....	49

## 4.1 Configuring Projects

A project stores all the information needed to build an individual program or library, including:

- Filenames of source code and object libraries
- Code generation tool options
- Include file dependencies

### 4.1.1 Creating a Project

The following procedure allows you to create single or multiple new projects (multiple projects can be open simultaneously). Each project's filename must be unique.

The information for a project is stored in a single project file (\*.pjt).

1. From the Project menu, choose New. The Project Creation wizard window displays.

**Figure 4-1. Project Creation Wizard**

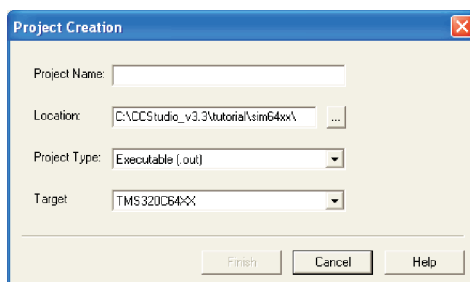

2. In the Project Name field, type the project name.
3. In the Location field, specify the directory where you want to store the project file. Object files generated by the compiler and assembler are also stored here. You can type the full path in the Location field or click the Browse button and use the Choose Directory dialog box. It is a good idea to use a different directory for each new project.
4. In the Project Type field, select a Project Type from the dropdown list. Choose either Executable (.out) or Library (lib). Executable indicates that the project generates an executable file. Library indicates that you are building an object library.
5. In the Target field, select the target family for your CPU. This information is necessary when tools are installed for multiple targets.
6. Click Finish. A project file called yourprojectname.pjt is created. This file stores all files and project settings used by your project.

The new project and first project configuration (in alphabetical order) become the active project, and inherit the TI-supplied default compiler and linker options for debug and release configurations.

**Figure 4-2. Code Composer Studio Control Window**

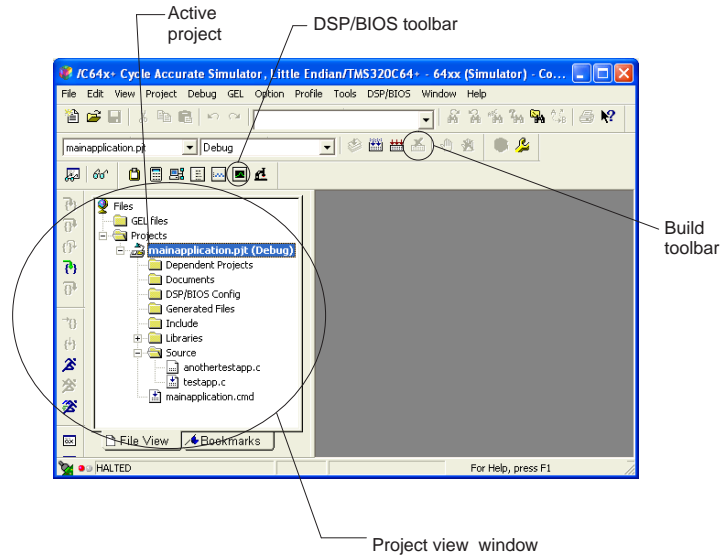

After creating a new project file, add the files for your source code, object libraries, and linker command file to the project list.

#### 4.1.1.1 Adding Files to a Project

You can add several different files or file types to your project. The types are shown in the graphic below. To add files to your project:

1. Select Project→Add Files to Project, or right-click on the project's filename in the Project View window and select Add Files to Project from the context menu. The Add Files to Project dialog box displays.

**Figure 4-3. Add Files to Project**

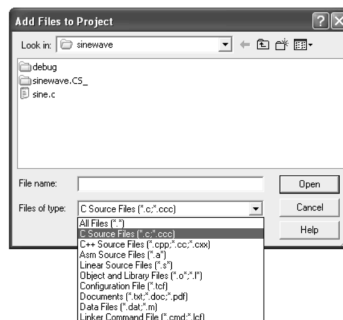

2. In the Add Files to Project dialog box, specify a file to add. If the file does not exist in the current directory, browse to the correct location. Use the Files of Type dropdown list to set the type of files that appear in the File name field.

**Note:** Do not try to manually add header/include files (\*.h) to the project. These files are automatically added when the source files are scanned for dependencies as part of the build process.

3. Click Open to add the specified file to your project.

The Project View (see [Figure 4-2](#)) is automatically updated when a file is added to the current project.

The project manager organizes files into folders for source files, include files, libraries, and DSP/BIOS configuration files. Source files that are generated by DSP/BIOS are placed in the Generated Files folder. Code Composer Studio IDE searches for project files in the following path order when building the program:

- The folder that contains the source file
- The folders listed in the Include search path for the compiler or assembler options (from left to right)
- The folders listed in the definitions of the optional DSP\_C\_DIR (compiler) and DSP\_A\_DIR (assembler) environment variables (from left to right)

#### 4.1.1.2 Removing a File

If you need to remove a file from the project, right-click on the file in the Project View and choose Remove from Project from the context menu.

### 4.1.2 Project Configurations

A project configuration defines a set of project level build options. Options specified at this level apply to every file in the project.

Project configurations enable you to define build options for the different phases of program development. For example, you can define a Debug configuration to use while debugging your program and a Release configuration for building the finished product.

Each project is created with two default configurations: Debug and Release. Additional configurations can be defined. Whenever a project is created or an existing project is initially opened, the first configuration (in alphabetical order) is set to active in the workspace.

When you build your program, the output files generated by the software tools are placed in a configuration-specific subdirectory. For example, if you have created a project in the directory MyProjects, the output files for the Debug configuration are placed in MyProjects\Debug. Similarly, the output files for the Release configuration are placed in MyProjects\Release.

#### 4.1.2.1 Changing the Active Project Configuration

Click on the Select Active Configuration field in the Project toolbar and select a configuration from the dropdown list.

**Figure 4-4. Configuration Toolbar**

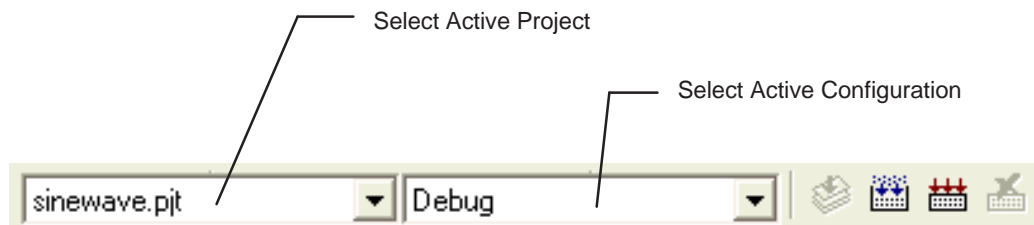

#### 4.1.2.2 Adding a New Project Configuration

1. Select Project→Configurations, or right-click on the project's filename in the Project View window and select Configurations.
2. In the Project Configurations dialog box, click Add. The Add Project Configuration window displays.

**Figure 4-5. Add Project Configurations**

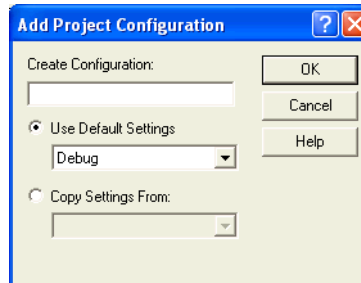

3. In the Add Project Configuration dialog box, specify the name of the new configuration in the Create Configuration field, and choose to Use Default Settings (build options) or Copy Settings from an existing configuration to populate your new configuration.
4. Click OK to accept your selections and exit the Add Project Configuration dialog.
5. Click Done to exit the Project Configurations dialog.
6. Modify your new configuration using the Build Options dialog found in the Project menu.

#### 4.1.3 Project Dependencies

The project dependencies tool allows you to manage and build more complex projects. Project dependencies allow you to break a large project into multiple smaller projects and then create the final project using those dependencies. Subprojects are always built first, because the main project depends on them.

##### 4.1.3.1 Creating Project Dependencies (Subprojects)

There are three ways to create a project dependency relationship or subproject.

- **Drag-and-drop from the project view windows.** Drop the sub-project to the target project icon or to the Dependent Projects icon under the target project. You can drag-and-drop from within the same project view window, or you can drag-and-drop between the project view windows of two Code Composer Studios running simultaneously.
- **Drag-and-drop from Windows File Explorer.**
  1. Open the main project in Code Composer Studio.
  2. Launch Windows Explorer. Both Explorer and Code Composer Studio should be open.
  3. In Windows Explorer, select the .pj1 file of the project you want to be a subproject.
  4. Drag this .pj1 file to the Project Window of Code Composer Studio. A plus sign should appear on the .pj1 file you are moving.
  5. Drop it into the Dependent Projects folder of the main project.
- **Use the context menu.** In the project view, right-click on the Dependent Projects icon under a loaded project, select Add Dependent Projects from the context menu. In the dialog, browse and select another project .pj1 file. The selected .pj1 file will be a sub-project of the loaded project. If the selected .pj1 file is not yet loaded, it will be automatically loaded.

### 4.1.3.2 Project Dependencies Settings

Sub-projects each have their own configuration settings. In addition, the main project has configuration settings for each sub-project. All of these settings can be accessed from the Project Dependencies dialog. To open the dialog, select Project Dependencies from the Project menu or from the context menu of the project.

### 4.1.3.3 Modifying Project Configurations

In the Project Dependencies dialog, it is possible to modify the subproject settings. As mentioned previously, the dialog can be accessed by Project→Project Dependencies.

As shown by [Figure 4-6](#), you can choose to exclude certain subprojects from your configuration. In the example shown, the MyConfig configuration for modem.pjt excludes zlib.pjt from the build. In addition, you can also select a particular subproject configuration for this configuration. In MyConfig, sinewave.pjt is built using the Debug configuration rather than the default MyConfig subproject configuration.

**Figure 4-6. Project Configuration Dependencies**

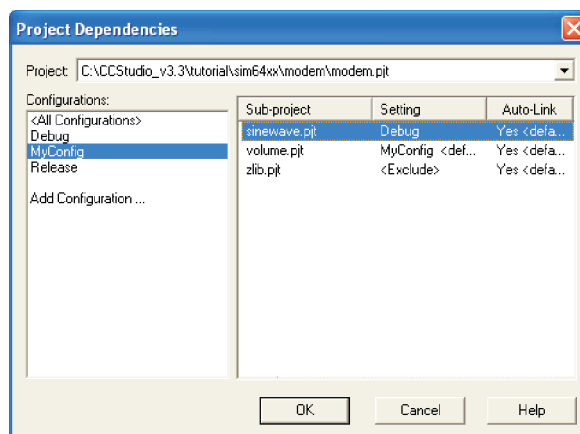

### 4.1.3.4 Sub-project configurations

Each sub-project has its own set of build configurations. For each main project configuration, you can choose to build each sub-project using a particular configuration. To modify the sub-project setting, use the dropdown box beside the project (under the Setting column).

## 4.1.4 Makefiles

The Code Composer Studio IDE supports the use of external makefiles (\*.mak) and an associated external make utility for project management and build process customization.

To enable the Code Composer Studio IDE to build a program using a makefile, a Code Composer Studio project must be created that contains the makefile. After a Code Composer Studio project is associated with the makefile, the project and its contents can be displayed in the Project View window and the Project→Build and Project→Rebuild All commands can be used to build the program.

1. Double-click on the name of the makefile in the Project View window to open the file for editing.
2. Modify your makefile build commands and options.

Special dialogs enable you to modify the makefile build commands and makefile options. The normal Code Composer Studio Build Options dialogs are not available when working with makefiles.

Multiple configurations can be created, each with its own build commands and options.



---

**Note: Limitations and Restrictions:** Source files can be added to or removed from the project in the Project View. However, changes made in the Project View do not change the contents of the makefile. These source files do not affect the build process nor are they reflected in the contents of the makefile. Similarly, editing the makefile does not change the contents in the Project View. File-specific options for source files that are added in the Project View are disabled. The Project→Compile File command is also disabled. However, when the project is saved, the current state of the Project View is preserved.

---

**Note:** Before using Code Composer Studio IDE commands to build your program using a makefile, it is necessary to set the required environment variables. To set environment variables, run the batch file DosRun.bat. The batch file is located in the directory C:\CCStudio\_v3.3. If you installed Code Composer Studio IDE in a directory other than C:\CCStudio\_v3.3, the batch file will be located in the specified directory.

---

### 4.1.5 Source Control Integration

The project manager can connect your projects to a variety of source control providers. The Code Composer Studio IDE automatically detects any installed providers that are compatible.

1. From the Project menu, choose Source Control→Select Provider.
2. Select the Source Control Provider that you want to use and press OK.  
If no source control providers are listed, ensure that you have correctly installed the client software for the provider on your machine.
3. Open one of your projects and select Add to Source Control from Project→Source Control.
4. Add your source files to Source Control.
5. You can check files in and out of source control by selecting a file in the Project View window and right clicking on the file. Icons will identify source files that are connected to a source control.

**Figure 4-7. Source Control Integration**

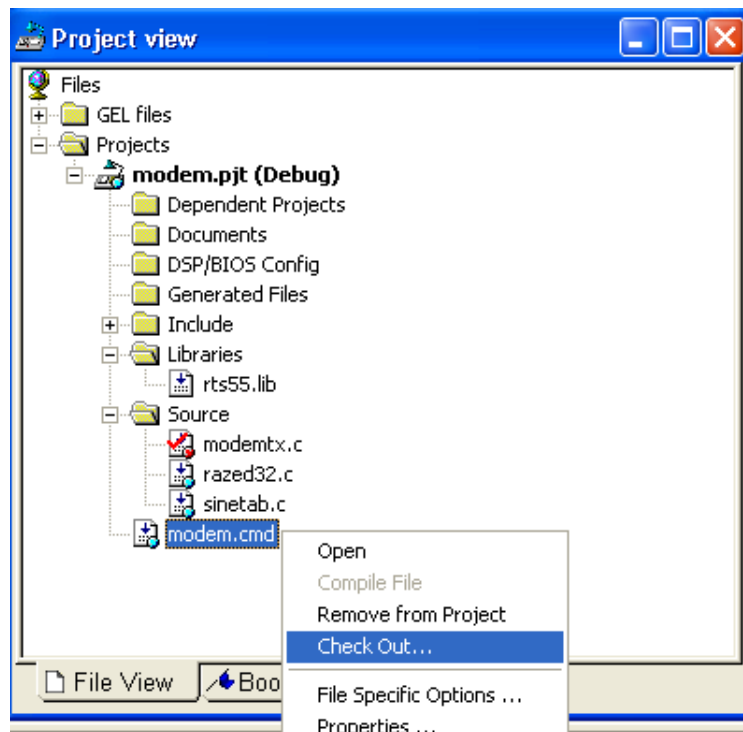

## 4.2 Text Editor

### 4.2.1 Viewing and Editing Code

Double-click on the filename in the Project View to display the source code in the IDE window.

- **Selection margin.** By default, a selection margin is displayed on the left-hand side of integrated editor and disassembly windows. Colored icons in the selection margin indicate various options, as described in the online help. A yellow arrow identifies the location of the Program Counter (PC).
- **Keywords.** The integrated editor features keyword highlighting. Keywords, comments, strings, assembler directives, and GEL commands are highlighted in different colors. In addition, you can create or customize new sets of keywords and save them in keyword files (\*.kwd).
- **Keyboard shortcuts.** Default keyboard shortcuts can be changed or created for any editing or debugging commands in a document window. Select Option→Customize to modify keyboard shortcuts.
- **Bookmarks.** Set bookmarks on any line in any source file to find and maintain key locations.

**Figure 4-8. Elements in the Source Code Window**

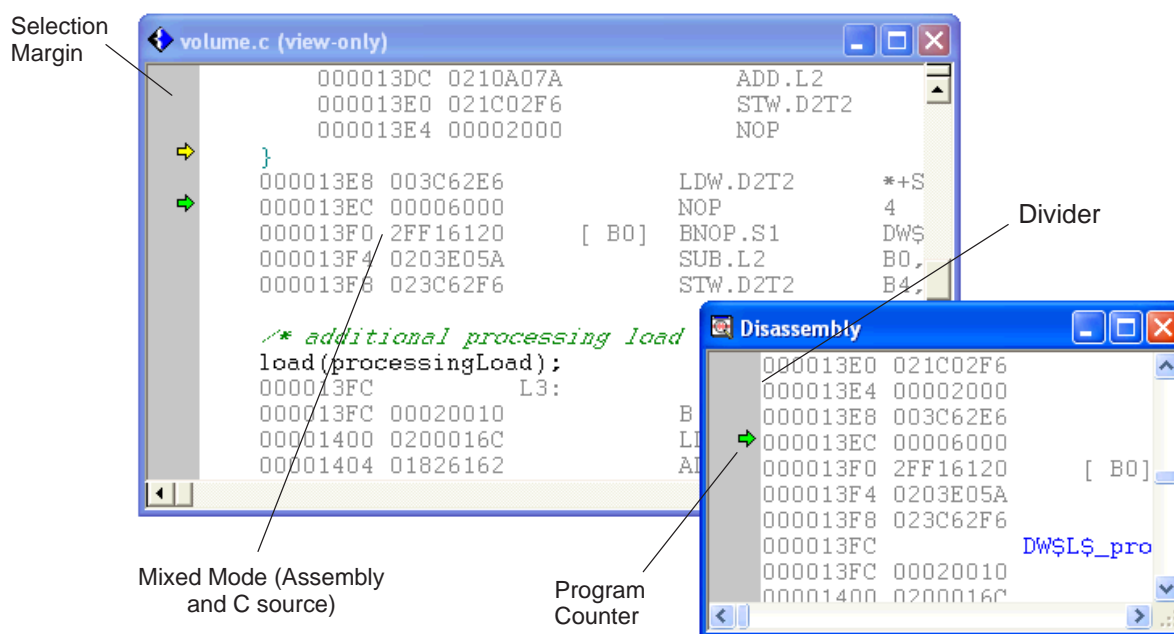

### 4.2.2 Customizing the Code Window

The IDE's text editor (called CodeWright) lets you customize code formatting and behavior. The Option→Editor menu has additional options for Language, ChromaCoding Lexers, and View Setups.

- **Language.** You can associate a file type (i.e., .cpp, .awk, etc.) with a set of behaviors. Note that the list of file types under Option→Editor→Language is different from the list of ChromaCoding lexers. By default, many of the file types are associated with the relevant lexer (i.e., the .h file type is associated with the C lexer). Some file types are not mapped to lexers at all.
- **ChromaCoding Lexers.** A lexer stores a collection of settings to color various elements of the programming language vocabulary. This vocabulary includes identifiers, braces, preprocessors, keywords, operators, strings, and comments. The CodeWright text editor comes with about 20 language-specific lexers already configured for use, including several specific lexers for the Code Composer Studio IDE, such as GEL, CCS, C, and DSP/BIOS. You can also create new lexers by clicking the New or Save as button on the right side of any ChromaCoding Lexer dialog box.
- **View Setups.** This defines generic features that are not specific to a single programming language, such as coloring all comments in all languages blue. However, a lexer defines what comment delimiters to use before and after a comment for the text editor.

**Table 4-1. CodeWright Text Editor: A Quick Reference**

CodeWright Menu Location	Configurable Settings and Options
Editor Properties (global settings): Option→Editor→Properties	Options for the editor, file loading, debug, selection margin resizing, tool tips, external editors, and backup (auto-save)
Settings for File Types (language properties): Option→Editor→Language	Language options and mapping, tabs and indenting, templates, coloring for code text, CodeSense, formatting for different file types, and comments
Lexer Settings (settings for language-specific lexers): Option→Editor→ChromaCoding Lexers	Identifiers, brace characters, excluding coloring text with regex, adding new words (keywords, preprocessors, operators) and keyword defaults, language-specific comments, defaults for strings, number elements
View Setups (additional global settings): Option→Editor→View Setups	Showing line numbers and rulers, line highlighting, scrolling, line number widths, showing visibles (EOL, tabs, spaces, etc.), general color defaults, general font defaults
Advanced Text Processing Edit→Advanced, or right-click within text window and select Advanced	Caps to lower (and vice versa), inserting comments and functions, tabs to spaces (and vice versa), and other advanced editing options

### 4.2.3 Using the Editor's Text Processing Functionality

The text editor includes several additional functions for processing text.

- **Differencing and merging.** You can use the diffing function (File→Difference between files) to compare two similar files. Merging (File→Merge Files) allows you to merge multiple files.
- **Support for regular expressions.** Select Edit→Find in Files or Edit→Replace in Files. In addition to the usual find or replace functionality, the text editor lets you use regular expressions for more complex text processing. For example, you can do a global replace for all the files in a certain directory. You can also use saved searches and use the helper dropdown window (see [Figure 4-9](#)) to construct regular expressions.

**Figure 4-9. Using Regular Expressions with the Text Editor**

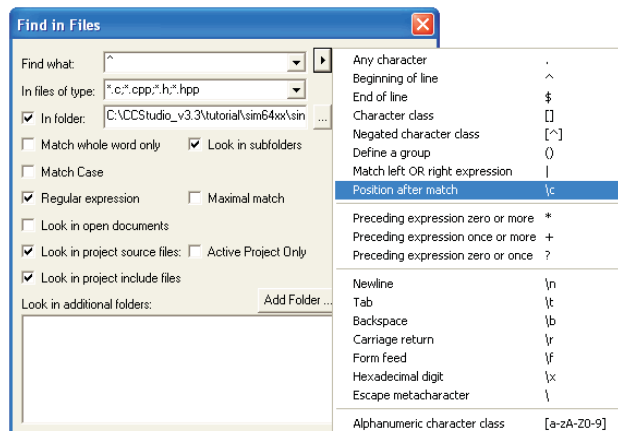

- **Selectively hiding and displaying code.** Selective display (Edit→Advanced→Selective Display) allows you to reveal or hide certain kinds of code according to the chosen parameters. For example, you can specify that the editor use the selective display function to expand and collapse certain kinds of code. Or you can choose to hide all function definitions or preprocessor directives by choosing the appropriate option. A small icon will appear on the margin to indicate that code has been hidden (see [Figure 4-10](#)). Clicking on the icon toggles the visibility of that particular block of code.

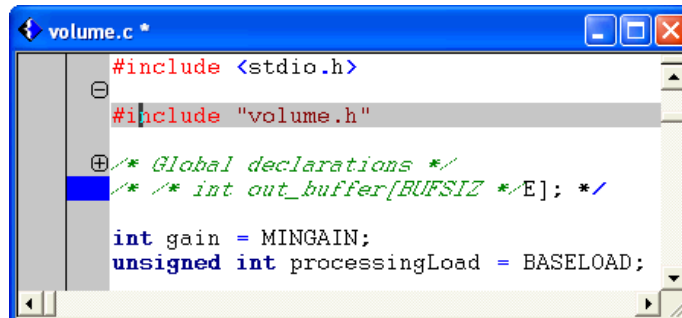
**Figure 4-10. Selective Display**

#### 4.2.4 Setting Auto-Save Defaults

The text editor can periodically save your working files to prevent loss of work in the event of a system crash. To use this function, select Option→Editor→Properties→Backup tab and check the box to enable auto-save. You can also select the time interval between saves or specify the name and location of the backup file. CCStudio will prompt you before overwriting an old backup file unless you specify otherwise.

#### 4.2.5 Autocompletion, Tooltips and Variable Watching (CodeSense)

The CodeWright text editor uses an autocompletion engine called CodeSense. When the tooltip or autocompletion activates, an icon will appear underneath the current line of your code. It shows symbols, function parameters and tooltips for C, C++, and Java code. Tooltips can also be used for variable watching.

CodeSense only works with certain file types and the CodeSense DLL must be enabled.

To enable CodeSense:

1. Choose Option→Editor→Language→CodeSense tab.
2. In the left box, highlight the file type you are working with.
3. To the right of the File Type box, make sure that CodeSense DLL is enabled. (If CodeSense is not supported for that particular file type, the option will be disabled.)

After the CodeSense DLL is enabled, CodeSense can be used to:

- List symbols (functions, structs, macros, members, etc.) that are associated with the symbol being typed.
- Insert symbols from the context list into the current document, completing the symbol being typed.
- Access a symbol's definition using a selected symbol's Goto button in the list. (Ctrl-G is the corresponding keyboard shortcut for the Goto functionality).
- Obtain a tooltip listing necessary parameters for a function as it is being typed.
- See a symbol's definition in a hover tooltip that can appear automatically, or when either Ctrl or Shift is pressed (depending on the CodeSense settings).

CodeSense word completion helps you finish typing symbols. Once you have entered a few characters, complete the following steps to use this feature:

1. Press Ctrl and Space together to bring up a list box of context-sensitive symbols to choose from. The symbols begin with whatever you have typed so far; the right-hand column provides the definition of each symbol.

**Figure 4-11. Code Sense**

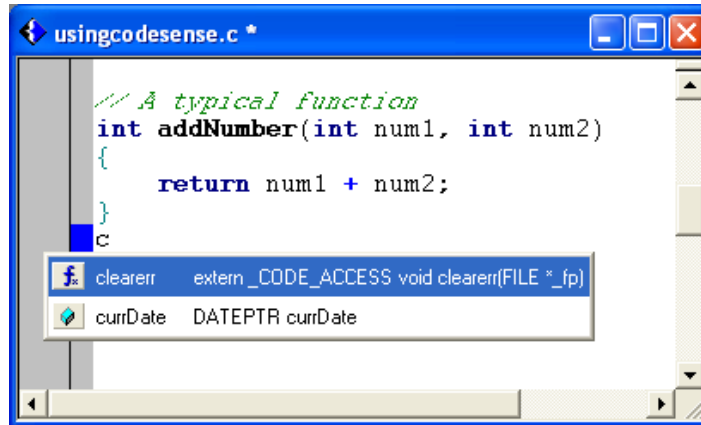

2. Highlight the appropriate symbol from the list. Press the selected symbol's corresponding image (the Goto button) to display the definition of the symbol within the library's source code. The key sequence Ctrl-G will also access a selected symbol's definition.
3. While the dropdown list is still displayed, press Enter. The highlighted symbol is entered into your document automatically, completing the word you began.

#### 4.2.6 Using an External Editor

The Code Composer Studio IDE supports the use of an external (third-party) text editor in place of the default integrated editor. After an external editor is configured and enabled, it is launched whenever a new blank document is created or an existing file is opened. An external editor can only be used to edit files. The integrated editor is used to debug your program. You can configure an external editor by selecting the External Editor tab from the Option→Editor→Properties dialog.

## 4.3 Code Generation Tools

### 4.3.1 Code Development Flow

Code generation tools include an optimizing C/C++ compiler, an assembler, a linker, and assorted utilities, see [Figure 4-12](#).

**Figure 4-12. Code Development Flow**

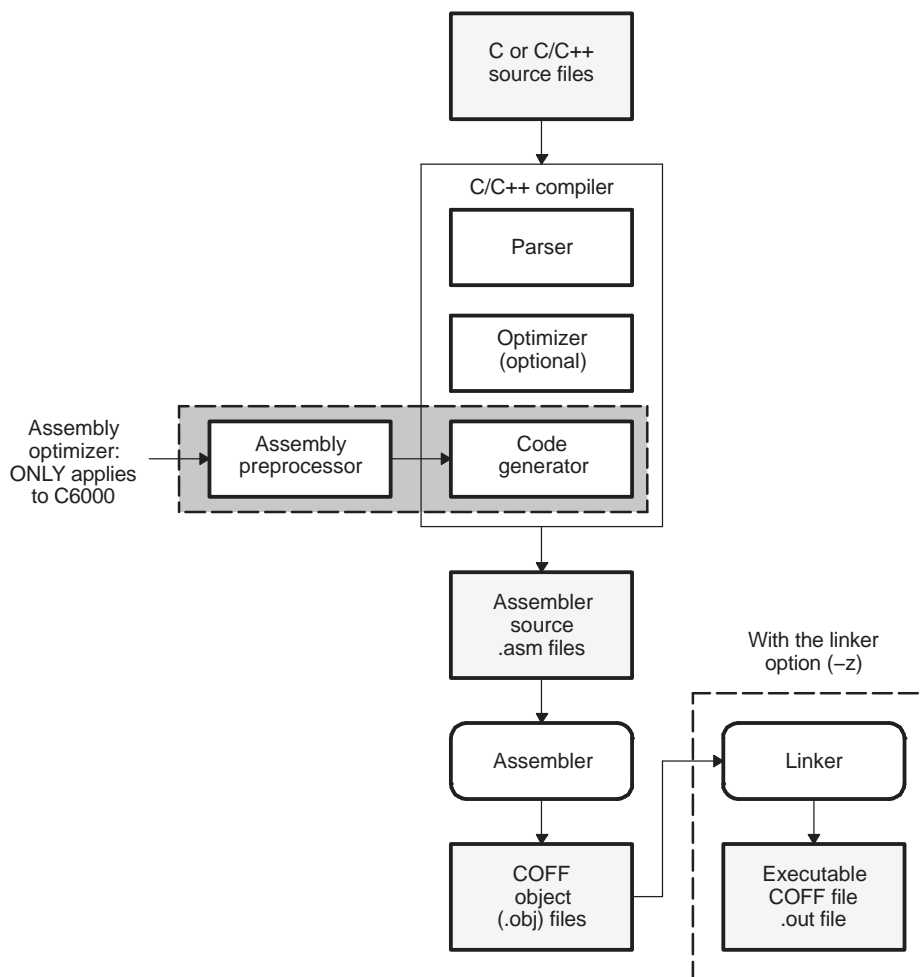

### 4.3.2 Project Build Options

A graphical interface is provided for using the code generation tools. A Code Composer Studio project keeps track of all information needed to build a target program or library. A project records:

- Filenames of source code and object libraries
- Compiler, assembler, and linker options
- Include file dependencies

When you build a project, CCStudio invokes the appropriate code generation tools to compile, assemble, and/or link the program. The Build Options dialog box specifies the compiler, assembler, and linker options (see [Figure 4-13](#)). Choose Build Options from the Project menu to access this dialog. This dialog box lists nearly all the command line options. Any options that are not represented can be typed directly into the editable text box at the top of the dialog. Each target configuration has a device-specific set of options. See the compiler or assembly guide for your target for more information.

**Figure 4-13. Build Options Dialog Box**

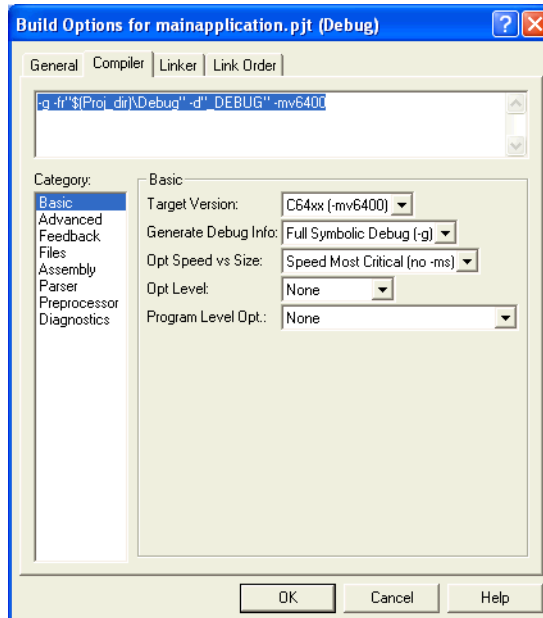

You can set the compiler and linker options that are used during the build process.

Your build options can be set at two different levels, depending on how frequently or in what configuration they are needed. First, you can define a set of project-level options that apply to all files in your project. Then, you can optimize your program by defining file-specific options for individual source code files.

---

**Note:** For options that are commonly used together, you can set project-level configurations, rather than setting the same individual options repeatedly. You can also look for this information in the online help and tutorial.

---

#### 4.3.2.1 Setting Project-Level Build Options

1. Select Project→Build Options.
2. In the Build Options Dialog Box, select the appropriate tab.
3. Select the options to be used when building your program.
4. Click OK to accept your selections.

#### 4.3.2.2 Setting File-Specific Options

1. Right-click on the name of the source file in the Project View window and select File Specific Options from the context menu.
2. Select the options to be used when compiling this file. These will differ from the project-level build options.
3. Click OK to accept your selections.
4. Any changes will only be applied to the selected file.

### 4.3.3 Compiler Overview

The C and C++ compilers (for C5000™ and C6000™) are full-featured optimizing compilers that translate standard ANSI C programs into assembly language source. The following subsection describes the key features of the compilers.

#### 4.3.3.1 Interfacing with the Code Composer Studio IDE

The following features allow you to interface with the compiler:

- **Compiler shell program.** The compiler tools include a shell program that you use to compile, assembly optimize, assemble, and link programs in a single step. For more information, see the About the Shell Program section in the Optimizing Compiler User's Guide appropriate for your device.
- **Flexible assembly language interface.** The compiler has straightforward calling conventions, so you can write assembly and C functions that call each other. For more information, see the section on Run-Time Environment in the Optimizing Compiler User's Guide appropriate for your device.

### 4.3.4 Assembly Language Development Tools

The following is a list of the assembly language development tools:

- **Assembler.** The assembler translates assembly language source files into machine language object files. The machine language is based on common object file format (COFF).
- **Archiver.** The archiver allows you to collect a group of files into a single archive file called a library. Additionally, the archiver allows you to modify a library by deleting, replacing, extracting, or adding members. One of the most useful applications of the archiver is building a library of object modules.
- **Linker.** The linker combines object files into a single executable object module. As it creates the executable module, it performs relocation and resolves external references. The linker accepts relocatable COFF object files and object libraries as input.
- **Absolute lister.** The absolute lister accepts linked object files as input and creates .abs files as output. You can assemble these .abs files to produce a listing that contains absolute, rather than relative, addresses. Without the absolute lister, producing such a listing requires many manual operations.
- **Cross-reference lister.** The cross-reference lister uses object files to produce a cross-reference listing showing symbols, their definitions, and their references in the linked source files.
- **Hex-conversion utility.** The hex-conversion utility converts a COFF object file into TI-Tagged, ASCII-hex, Intel, Motorola-S, or Tektronix object format. You can download the converted file to an EPROM programmer.
- **Mnemonic-to-algebraic translator utility.** For the TMS320C54x device only, this tool converts assembly language source files. The utility accepts an assembly language source file containing mnemonic instructions. It converts the mnemonic instructions to algebraic instructions, producing an assembly language source file containing algebraic instructions.

### 4.3.5 Assembler Overview

The assembler translates assembly language source files into machine language object files. These files are in common object file format (COFF).

The two-pass assembler does the following:

- Processes the source statements in a text file to produce a relocatable object file
- Produces a source listing (if requested) and provides you with control over this listing
- Allows you to segment your code into sections and maintains a section program counter (SPC) for each section of object code
- Defines and references global symbols and appends a cross-reference listing to the source listing (if requested)
- Assembles conditional blocks
- Supports macros, allowing you to define macros inline or in a library



### 4.3.6 Linker Overview

The linker allows you to configure system memory by allocating output sections efficiently into the memory map. As the linker combines object files, it performs the following tasks:

- Allocates sections into the target system's configured memory
- Relocates symbols and sections to assign them to final addresses
- Resolves undefined external references between input files

The linker command language controls memory configuration, output section definition, and address binding. The language supports expression assignment and evaluation. You configure system memory by defining and creating a memory module. The directives MEMORY and SECTIONS allow you to:

- Allocate sections into specific areas of memory
- Combine object file sections
- Define or redefine global symbols at link time

#### 4.3.6.1 Text-Based Linker

The text linker combines object files into a single executable COFF object module. Linker directives in a linker command file allow you to combine object file sections, bind sections or symbols to addresses or within memory ranges, and define or redefine global symbols. For more information, see the Code Generation Tools online help.

### 4.3.7 C/C++ Development Tools

The following is a list of the C/C++ development tools:

- **C/C++ compiler.** The C/C++ compiler accepts C/C++ source code and produces assembly language source code. A shell program, an optimizer, and an interlist utility are parts of the compiler.
  - The shell program enables you to compile, assemble, and link source modules in one step. If any input file has a .sa extension, the shell program invokes the assembly optimizer.
  - The optimizer modifies code to improve the efficiency of C programs.
  - The interlist utility interweaves C/C++ source statements with assembly language output.
- **Assembly optimizer (C6000 only).** The assembly optimizer allows you to write linear assembly code without being concerned with the pipeline structure or with assigning registers. It accepts assembly code that has not been register-allocated and is unscheduled. The assembly optimizer assigns registers and uses loop optimization to turn linear assembly into highly parallel assembly that takes advantage of software pipelining.
- **Library-build utility.** You can use the library-build utility to build your own customized run-time-support library. Standard run-time-support library functions are provided as source code in rts.src and rstcpp.src. The object code for the run-time-support functions is compiled for little-endian mode versus big-endian mode and C code versus C++ code into standard libraries. The run-time-support libraries contain the ANSI standard run-time-support functions, compiler-utility functions, floating-point arithmetic functions, and C I/O functions that are supported by the compiler.
- **C++ name demangling utility.** The C++ compiler implements function overloading, operator overloading, and type-safe linking by encoding a function's signature in its link-level name. The process of encoding the signature into the link name is often referred to as name mangling. When you inspect mangled names, such as in assembly files or linker output, it can be difficult to associate a mangled name with its corresponding name in the C++ source code. The C++ name demangler is a debugging aid that translates each mangled name it detects to its original name found in the C++ source code.

## 4.4 Building Your Code Composer Studio Project

### 4.4.1 From Code Composer Studio

To build and run a program, follow these steps:

1. Choose Project→Rebuild All or click the Rebuild All toolbar button. All the files in your project are recompiled, reassembled, and relinked. Messages about this process are shown in the status bar at the bottom of the window.
2. By default, the .out file is built into a debug directory located under your current project folder. To change this location, select a different one from the Select Configuration toolbar.
3. Choose File→Load Program. Select the program you just rebuilt, and click Open. The program is loaded onto the target DSP and opens a disassembly window that shows the disassembled instructions that make up the program.
4. Choose View→Mixed Source/ASM. This allows you to simultaneously view your c source and the resulting assembly code.
5. Click on an assembly instruction in the mixed-mode window. (Click on the actual instruction, not the address of the instruction or the fields passed to the instruction.)
6. Press the F1 key. The Code Composer Studio IDE searches for help on that instruction.
7. Choose Debug→Go Main to begin execution from the main function. The execution halts at Main.
8. Choose Debug→Run to run the program.
9. Choose Debug→Halt to quit running the program.

---

**Note:** You can use the supplied timake.exe utility located in the CCStudio\_v3.3\cc\bin directory to build a project from the DOS shell.

---

### 4.4.2 External Make

Code Composer Studio supports the use of external makefiles (\*.mak) and an associated external make utility for project management and build process customization.

To enable the Code Composer Studio IDE to build a program using a makefile, a Code Composer Studio project must be created that contains the makefile. After a Code Composer Studio project is associated with the makefile, the project and its contents can be displayed in the Project View window and the Project→Build and Project→Rebuild All commands can be used to build the program.

Double-click on the name of the makefile in the Project View window to open the file for editing. You can also modify your makefile build commands and options through special dialogs. The normal Build Options dialogs are not available when working with makefiles. Multiple configurations can be created, each with its own build commands and options.

---

**Note: Limitations and Restrictions:** Source files can be added to or removed from the project in the Project View. However, changes made in the Project View do not change the contents of the makefile. These source files do not affect the build process nor are they reflected in the contents of the makefile. Similarly, editing the makefile does not change the contents in the Project View. File-specific options for source files that are added in the Project View are disabled. The Project→Compile File command is also disabled. However, when the project is saved, the current state of the Project View is preserved.

---

---

### 4.4.3 Command Line

#### 4.4.3.1 Using the Timake Utility From the Command Line

The timake.exe utility located in the CCStudio\_v3.3\cc\bin directory provides a way to build projects (\*.pjt) outside of the Code Composer Studio environment from a command prompt. This utility can be used to accomplish batch builds.

To invoke the timake utility:

1. Open a DOS Command prompt.
2. Set up the necessary environment variables by running the batch file DosRun.bat. This batch file must be run before using timake. If you installed the Code Composer Studio product in C:\CCStudio\_v3.3, the batch file is located at: C:\CCStudio\_v3.3\DosRun.bat.
3. Run the timake.exe utility in the CCStudio\_v3.3\cc\bin directory.

See the online help topic on the timake utility for more information.

#### 4.4.3.2 Makefiles

In addition to the option of using external makefiles within the Code Composer Studio IDE, you can also export a standard Code Composer Studio project file (\*.pjt) to a standard makefile that can be built from the command line using any standard make utility. Code Composer Studio comes with a standard make utility (gmake) that can be run after running the DosRun.bat file.

To export a Code Composer Studio Project to a standard makefile:

1. Make the desired project active by selecting the project name from the Select Active Project dropdown list on the Project toolbar.
2. Select Project→Export to Makefile.
3. In the Exporting <filename>.pjt dialog box, specify the configurations to export, the default configuration, the host operating system for your make utility, and the file name for the standard makefile.
4. Click OK to accept your selections and generate a standard makefile.

See the online help topic, *Exporting a Project to a Makefile* for more information.

## 4.5 Available Foundation Software

### 4.5.1 DSP/BIOS

DSP/BIOS™ is a scalable real-time kernel, designed specifically for the TMS320C5000™, TMS320C2000™, and TMS320C6000™ DSP platforms. DSP/BIOS enables you to develop and deploy sophisticated applications more quickly than with traditional DSP software methodologies and eliminates the need to develop and maintain custom operating systems or control loops. Because multithreading enables real-time applications to be cleanly partitioned, an application using DSP/BIOS is easier to maintain and new functions can be added without disrupting real-time response. DSP/BIOS provides standardized APIs across C2000, C5000, and C6000 DSP platforms to support rapid application migration.

DSP/BIOS is released separately from the main CCS releases, so updated versions of the DSP/BIOS API and configuration tools are available through the Update Advisor. After installing an updated version of DSP/BIOS, you can specify which DSP/BIOS version to be used by CCStudio with the Component Manager.

## 4.5.2 Chip Support Library (CSL)

The Chip Support Library (CSL) provides C-program functions to configure and control on-chip peripherals. It is intended to simplify the process of running algorithms in a real system. The goal is peripheral ease of use, shortened development time, portability, hardware abstraction, and a small level of standardization and compatibility among devices.

---

**Note:** Support for the CSL graphic user interface has been removed in CCStudio v3.3. For more information about CSL or to find out if CSL is supported by your device, check your device product folder on [www.ti.com](http://www.ti.com), or contact the Product Information Center (<http://www-k.ext.ti.com/sc/technical-support/product-information-centers.htm>).

---

### 4.5.2.1 Benefits of CSL

CSL has the following benefits:

- **Standard protocol to program peripherals.** CSL provides a higher-level programming interface for each on-chip peripheral. This includes data types and macros to define peripheral register configuration, and functions to implement the various operations of each peripheral.
- **Basic resource management.** Basic resource management is provided through the use of open and close functions for many of the peripherals. This is especially helpful for peripherals that support multiple channels.
- **Symbol peripheral descriptions.** As a side benefit to the creation of CSL, a complete symbolic description of all peripheral registers and register fields has been created. It is suggested that you use the higher-level protocols described in the first two bullets, as these are less device-specific, making it easier to migrate your code to newer versions of DSPs.

## 4.5.3 Board Support Library (BSL)

The TMS320C6000 DSK Board Support Library (BSL) is a set of C-language application programming interfaces (APIs) used to configure and control all on-board devices, allowing developers to get algorithms functioning in a real system. The BSL consists of discrete modules that are built and archived into a library file. Each module represents an individual API and is referred to as an API module. The module granularity is constructed such that each device is covered by a single API module except the I/O Port module, which is divided into two API modules: LED and DIP.

### 4.5.3.1 Benefits of BSL

Some of the advantages offered by the BSL include: device ease of use, a level of compatibility between devices, shortened development time, portability, some standardization, and hardware abstraction.

## 4.5.4 DSP Library (DSPLIB)

The DSP Library (DSPLIB) includes many C-callable, assembly-optimized, general-purpose signal-processing, and image/video processing routines. These routines are typically used in computationally intensive real-time applications where optimal execution speed is critical. By using these routines, you can achieve execution speeds considerably faster than equivalent code written in standard ANSI C language. In addition, by providing ready-to-use DSP and image/video processing functions, DSPLIB and IMGLIB can significantly shorten your application development time.

For more information on DSPLIB, see the appropriate reference guide for your device:

- *TMS320C54x DSP Library Programmer's Reference* ([SPRU518](#))
- *TMS320C55x DSP Library Programmer's Reference* ([SPRU422](#))
- *TMS320C62x DSP Library Programmer's Reference* ([SPRU402](#))
- *TMS320C64x DSP Library Programmer's Reference* ([SPRU565](#))
- *TMS320C64x+ DSP Big-Endian Library Programmer's Reference* ([SPRUEC5](#))
- *TMS320C64x+ DSP Little-Endian Library Programmer's Reference* ([SPRUEB8](#))

#### 4.5.4.1 Benefits of DSPLIB

DSPLIB includes commonly-used routines. Use the provided source code to modify functions.

Features include:

- Optimized assembly code routines
- C and linear assembly source code
- C-callable routines fully compatible with the TI Optimizing C compiler
- Benchmarks (cycles and code size)
- Tested against reference C model

#### 4.5.4.2 DSPLIB Functions Overview

DSPLIB provides a collection of C-callable high performance routines that serve as key enablers for a wide range of signal and image/video processing applications.

The routines contained in the DSPLIB are organized into the following functional categories:

- Adaptive filtering
- Correlation
- FFT
- Filtering and convolution
- Math
- Matrix functions
- Miscellaneous

#### 4.5.5 Image/Video Processing Library (IMGLIB)

The Image/Video Processing Library (IMGLIB) includes many C-callable, assembly-optimized, general-purpose signal-processing, and image/video processing routines. The IMGLIB is only available for C5500/C6000 platform devices. These routines are typically used in computationally intensive real-time applications where optimal execution speed is critical. By using these routines, you can achieve execution speeds faster than equivalent code written in standard ANSI C language. In addition, DSPLIB and IMGLIB can significantly shorten application development time by providing ready-to-use DSP and image/video processing functions.

For more information on IMGLIB, see the appropriate reference guide for your device:

- *TMS32C55x Imaging/Video Processing Library Programmer's Reference* ([SPRU037](#))
- *TMS320C62x Image/Video Processing Library Programmer's Reference* ([SPRU400](#))
- *TMS320C64x Image/Video Processing Library Programmer's Reference* ([SPRU023](#))
- *TMS320C64x+ Image/Video Processing Library Programmer's Reference* ([SPRU023](#))

#### 4.5.5.1 Benefits of IMGLIB

IMGLIB includes commonly used routines. Source code is provided that allows you to modify functions to match your specific needs.

Features include:

- Optimized assembly code routines
- C and linear assembly source code
- C-callable routines fully compatible with the TI Optimizing C compiler
- Benchmarks (cycles and code size)
- Tested against reference C model

### 4.5.5.2 IMGLIB Functions Overview

IMGLIB provides a collection of C-callable high performance routines that can serve as key enablers for a wide range of signal and image/video processing applications.

The set of software routines included in the IMGLIB are organized into three different functional categories as follows:

- Image/video compression and decompression
- Image analysis
- Picture filtering/format conversions

### 4.5.6 TMS320 DSP Algorithm Standard Components

DSPs are programmed in a mix of C and assembly language, and directly access hardware peripherals. For performance reasons, DSPs have little or no standard operating system support. Unlike general-purpose embedded microprocessors, DSPs are designed to run sophisticated signal processing algorithms and heuristics. However, because of the lack of consistent standards, it is not possible to use an algorithm in more than one system without significant reengineering. Reusing DSP algorithms is labor intensive, so the time-to-market for a new DSP-based product is lengthy.

The TMS320 DSP Algorithm Standard (known as XDAIS) defines a set of requirements for DSP algorithms that allow system integrators to quickly assemble systems from using one or more such algorithms.

#### 4.5.6.1 Scope of XDAIS

**Figure 4-14. TMS320 DSP Algorithm Standard Elements**

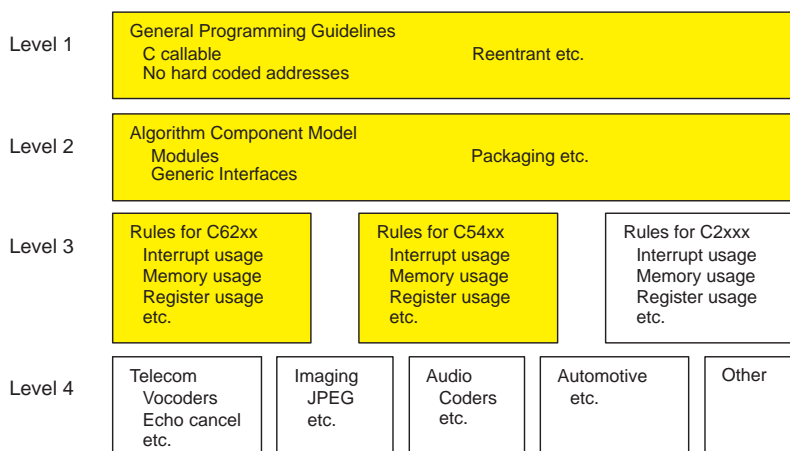

Level 1 contains programming guidelines that apply to all algorithms on all DSP architectures, regardless of application area. Almost all recently developed software modules already follow these guidelines, so this level formalizes them.

Level 2 contains rules and guidelines that enable all algorithms to operate within a single system. Conventions are established for an algorithm’s use of data memory and names for external identifiers, as well as rules for algorithm packaging.

Level 3 contains the guidelines for specific DSP families. There are no current agreed-upon guidelines for algorithms for use of processor resources. These guidelines outline the uses of the various architectures. Deviations from these guidelines may occur, but the algorithm vendor can outline the deviation in the relevant documentation or module headers.

The shaded boxes in [Figure 4-14](#) represent the areas that are covered in this version of the specification.

Level 4 contains the various vertical markets. Due to the inherently different nature of each of these businesses, it seems appropriate for the market leaders to define the interfaces for groups of algorithms based on the vertical market. If each unique algorithm has an interface, the standard will not stay current. At this level, any algorithm that conforms to the rules defined in the top three levels is considered eXpressDSP-compliant.

#### 4.5.6.2 Rules and Guidelines

The TMS320 DSP Algorithm Standard specifies both rules and guidelines. Rules must be followed for software to be eXpressDSP-compliant. On the other hand, guidelines are strongly suggested recommendations that are not required for software to be eXpressDSP-compliant.

#### 4.5.6.3 Requirements of the Standard

The required elements of XDAIS are as follows:

- Algorithms from multiple vendors can be integrated into a single system.
- Algorithms are framework-agnostic. That is, the same algorithm can be efficiently used in virtually any application or framework.
- Algorithms can be deployed in purely static as well as dynamic run-time environments.
- Algorithms can be distributed in binary form.
- Integration of algorithms does not require recompilation of the client application; however, reconfiguration and relinking may be required.

#### 4.5.6.4 Goals of the Standard

The XDAIS must meet the following goals:

- Enable developers to easily conform to the standard
- Enable developers to verify conformance to the standard
- Enable system integrators to easily migrate between TI DSPs
- Enable host tools to simplify a system integrator's tasks; including configuration, performance modeling, standard conformance, and debugging
- Incur little or no overhead for static systems

#### 4.5.7 Reference Frameworks

Reference frameworks for eXpressDSP software are provided for applications that use DSP/BIOS and the TMS320 DSP Algorithm Standard. You first select the reference framework that best approximates your system and its future needs, and then adapt the framework and populate it with eXpressDSP-compliant algorithms. Common elements such as device drivers, memory management, and channel encapsulation are already pre-configured in the frameworks, therefore you can focus on your system. Reference frameworks contain design-ready, reusable, C-language source code for TMS320C5000 and TMS320C6000 DSPs.

Reference frameworks software and documentation are available for download from the TI website. They are not included in the Code Composer Studio installation.

Figure 4-15 shows the elements that make up a reference framework on the target DSP.

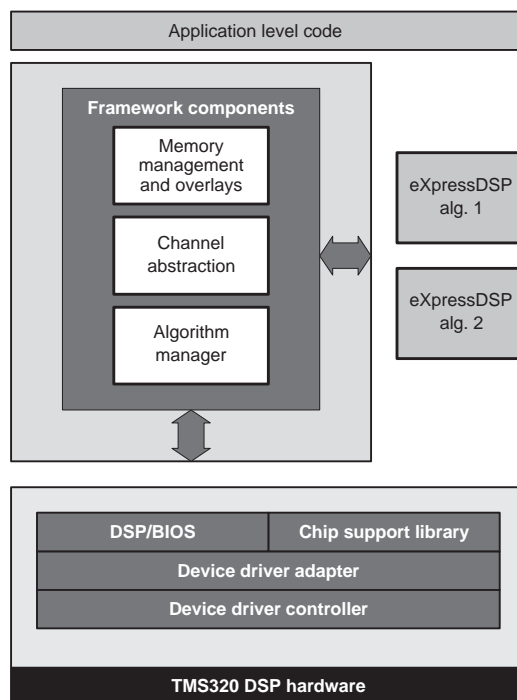

**Figure 4-15. Reference Framework Elements**

See the following list for element descriptions:

- **Device controller and device adapter.** The device drivers used in reference frameworks are based on a standard driver model, which provides device adapters and specifies a standard device controller interface. If you have unique external hardware, the device controller might require modification, but the device adapter probably needs little or no modification.
- **Chip Support Library (CSL).** The controller uses CSL modules to support peripheral hardware.
- **DSP/BIOS.** This extensible software kernel is a good example of how each reference framework leverages different amounts of the eXpressDSP infrastructure, depending on its needs. The low-end RF1 framework uses relatively few DSP/BIOS modules. In addition to providing an obvious footprint savings, reducing the number of modules helps clarify design choices for a designer who may not fully appreciate the ramifications of module selections.
- **Framework components.** These elements are crafted to provide overall system resource management. One example of this is channel abstraction. Every reference framework needs some kind of channel management. However, design optimizations can be made based on the number of channels likely to be in use. For simple systems with 1 to 3 channels, channel scheduling is handled with the low-overhead DSP/BIOS HWI and IDL modules. For larger numbers of channels, it is wiser to use the SWI module, although it comes with some extra footprint. For large systems with channels that change dynamically, the TSK module is most appropriate. The algorithm managers manage some eXpressDSP-compliant algorithms, similar to channel managers. Other framework components are modules that handle memory overlay schemes, which is a critical technique in most memory constrained systems. Starting with the appropriate framework simplifies many development choices.
- **eXpressDSP-compliant algorithms.** Each algorithm follows the rules and guidelines detailed in the *TMS320 DSP Algorithm Standard Rules and Guidelines* ([SPRU352](#)). To be standard-compliant, algorithms must not directly access any hardware peripherals and must implement standard resource management interfaces known as IALG (for memory management) and optionally, IDMA (for DMA resource management). In the examples that TI provides, the algorithms are simple, including finite impulse response (FIR) filters and volume controllers. You can substitute more significant eXpressDSP-compliant algorithms for the TI-provided ones, making a generic reference framework more application-specific.



- **Application-level code.** The last step is to modify the application-level code. This code applies unique and value-added application-specific knowledge, allowing for real product differentiation. For instance, the application code required for a single-channel MP3 player is different than that required for a digital hearing aid.

## 4.6 Automation (for Project Management)

### 4.6.1 Using General Extension Language (GEL)

The General Extension Language (GEL) is an interpretive language, similar to C, that lets you create functions for Code Composer Studio. You create your GEL functions by using the GEL grammar, and then load them into the Code Composer Studio IDE. A subset of GEL functions may be used to automate project build options, or custom GEL menus may be created to automatically open and build a project.

Here's a sample GEL Script to open the volume project:

```
/*
 * Copyright 1998 by Texas Instruments Incorporated.
 * All rights reserved. Property of Texas Instruments
 * Incorporated.
 * Restricted rights to use, duplicate or disclose this
 * code are
 * granted through contract.
 */
/*
 * ===== PrjOpen.gel =====
 * Simple gel file to demonstrate project management
 * capabilities of GEL
 */
menuitem "MyProjects"
hotmenu OpenVolume()
{
 // Open Volume tutorial example
GEL_ProjectLoad("C:\\CCStudio_v3.3\\tutorial\\sim55xx\\volume1\\volume.pjt");
 // Set currently active configuration to debug
GEL_ProjectSetActiveConfig("C:\\CCStudio_v3.3\\tutorial\\sim55xx\\volume1\\volume.pjt",
 "Debug");
 // Build the project.
GEL_ProjectBuild();
}
```

### 4.6.2 Scripting Utility

The scripting utility is a set of IDE commands that are integrated into a VB or perl scripting language. You may utilize the full capabilities of a scripting language, such as perl or VB, and combine it with automation tasks in Code Composer Studio. The scripting utility can configure a test scenario, open and build a corresponding project, and load it for execution. There are a number of scripting commands that may be used to build and manage projects. Scripting is synchronous.

The scripting utility is an add-on capability available through Update Advisor (see [Section 7.2](#)).



## Debug

---

---

---

This section applies to all platforms using Code Composer Studio IDE. However, not all devices have access to all of the tools discussed in this section. For a complete listing of the tools available to you, see the online help and online documentation provided with the Code Composer Studio IDE.

This section discusses the various debug tools included with Code Composer Studio.

Topic	Page
<b>5.1 Setting Up Your Environment for Debug</b> .....	<b>52</b>
<b>5.2 Basic Debugging</b> .....	<b>59</b>
<b>5.3 Advanced Debugging Features</b> .....	<b>79</b>
<b>5.4 Real-Time Debugging</b> .....	<b>81</b>
<b>5.5 Automation (for Debug)</b> .....	<b>86</b>
<b>5.6 Reset Options</b> .....	<b>86</b>

## 5.1 Setting Up Your Environment for Debug

Before you can successfully debug an application, the environment must be configured as shown in the following sections.

### 5.1.1 Setting Custom Debug Options

Several debugging options are customizable within Code Composer Studio IDE. You can configure these options to help with the debug process or to suit your desired preferences.

#### 5.1.1.1 Debug Properties Tab

This debug properties dialog is available from the Customize dialog under Option→Customize→Debug Properties. It allows you to disable certain default behaviors when debugging, other options are described in the online help. The behaviors available from the debug properties tab are as follows, your list may have additional items depending on your installation:

- **Open the Disassembly Window automatically.** Disabling this option prevents the disassembly Window from appearing after a program is loaded. This option is enabled by default.
- **Perform Go Main automatically.** Enabling this option instructs the debugger to automatically run to the symbol *main* for the application loaded. This option is disabled by default.
- **Connect to the target when a control window is opened.** You can disable this option when you are experiencing target connection problems or don't need the actual target to be connected (i.e., when writing source code, etc.). This option is disabled by default.
- **Remove remaining debug state at connect.** When the Code Composer Studio IDE disconnects from the target, it typically tries to remove breakpoints by default. If there are errors in this process, Code Composer Studio will try again to remove breakpoints when reconnecting to the target. However, this second attempt to remove breakpoints may put some targets into a bad state. Thus, TI recommends disabling this option to prevent a second attempt to remove breakpoints when reconnecting.
- **Step over functions without debug information when source stepping.** This option allows you to step over functions that do not have debug information when you are source stepping.
- **Enable cache highlighting for disassembly and mixed mode.** You can disable this feature to improve performance while debugging. This is only relevant for devices that support cache visibility, which is currently limited to C64x+ devices. If this option is enabled, then addresses that have been read from the target device's cache are displayed with a background color indicating from which level of cache the address has been read (if any). The same cache highlighting colors will be used in the memory window, disassembly window, and mixed mode window. The cache highlighting colors can be configured via the memory window properties (select View→Memory, then right click on the Memory Window and select Properties from the context menu). Disabling both the cache highlighting and protected memory options will significantly improve the speed at which a program can be single-stepped.
- **Enable highlighting of protected memory for disassembly and mixed mode.** You can disable this feature to improve performance while debugging. This is only relevant for devices that support memory protection visibility, which is currently limited to C64x+ devices. To use this option, your program must have a range of addresses configured as a protected memory region. If this option is enabled, then the disassembly window and mixed mode windows will display "\*\*\*\*\*" for addresses in the protected memory regions. If the option is not enabled, then the data read from addresses in protected memory regions for C64x+ devices will be indeterminate and garbage opcodes will be displayed. If you are debugging programs on C64x+ devices that use the memory protection features of these devices, it is recommended that this option be enabled. Disabling both the cache highlighting and protected memory options will significantly improve the speed at which a program can be single-stepped.
- **Animation speed.** Animation speed is the minimum time (in seconds) between breakpoints. Program execution does not resume until the minimum time has expired since the previous breakpoint. See [Section 5.2.1.1](#) for more details.

### 5.1.1.2 Directories

To open the source file, the debugger needs the location of the source file where the application is halted. The debugger includes source path information for all the files in an open project, files in the current directory, and specified paths to Code Composer Studio IDE.

The paths you specify to Code Composer Studio IDE are empty by default. Thus, if the application being debugged uses source files that are not in an open project or current directory, then you must specify the path to these files. If not, the debugger will not be able to automatically open the file when execution halts at a location that references that source file. It will then prompt you to manually find the file. For instance, including libraries in a build is a common example of using source files that are not in the open project.

The Directories dialog box enables you to specify additional search paths that the debugger uses to find the included source files.

To specify a search path directory, select the Directories tab in the Option→Customize menu dialog. The options include:

- **Directories.** The Directories list displays the defined search path. The debugger searches the listed directories in order from top to bottom. If two files have the same name and are located in different directories, the file located in the directory that appears highest in the Directories list takes precedence.
- **New.** To add a new directory to the Directories list, click the New icon button. Enter the full path or browse to the appropriate directory. By default, the new directory is added to the bottom of the list.
- **Delete.** Select a directory in the Directories list, then click the Delete icon button to remove it.
- **Move Up/Move Down.** Select a directory in the Directories list, then click the Move Up icon button to move that directory higher in the list, or Move Down to move that directory lower in the list.
- **Look in subfolders.** You can enable the debugger to search in the subfolders of the listed paths.
- **Default File I/O Directory.** In addition to setting source file directories, you can now set a default directory for File I/O files by enabling the Default File I/O directory option. Use the browse button to find the path you wish to select as the default directory.

### 5.1.1.3 Program/Project/CIO Load Options

You can set defaults for loading a program by selecting the Program/Project/CIO tab from the Option→Customize menu dialog, including the following default behaviors in the Program section:

- **Perform verification during Program Load.** This checkbox is enabled by default, so Code Composer Studio reads back selected memory to verify that the program loaded correctly.
- **Load Program After Build.** When this option is selected, the executable is loaded immediately upon building the project, thus the target contains the current symbolic information generated after a build.
- **Do Not Set CIO Breakpoint At Load.** By default, if your program has been linked using a TI library (rts\*.lib), a C I/O breakpoint (C\$\$IO\$\$) is set when the program is loaded. This option enables you to choose not to set the C I/O breakpoint. The C I/O breakpoint is necessary for the normal operation of C I/O library functions such as printf and scanf. The C I/O breakpoint is not needed if your program does not execute CIO functions. When C I/O code is loaded in RAM, Code Composer Studio sets a software breakpoint. However, when C I/O code is loaded in ROM, Code Composer Studio uses a hardware breakpoint. Since most processors support only a small number of hardware breakpoints, using even one can significantly impact debugging. You can also avoid using the hardware breakpoint when C I/O code is loaded in ROM by embedding a breakpoint in your code and renaming the label C\$\$IO\$\$ to C\$\$IOE\$\$.
- **Do Not Set End of Program Breakpoint At Load.** By default, if your program has been linked using a TI library (rts\*.lib), an End of Program breakpoint (C\$\$EXIT) is set when the program is loaded. This option allows you to choose not to set the End of Program breakpoint. The End of Program breakpoint halts the processor when your program exits following completion. The End of Program breakpoint is not needed if your program executes an infinite loop. When End of Program code is loaded in RAM, Code Composer Studio sets a software breakpoint. However, when End of Program code is loaded in ROM, Code Composer Studio uses a hardware breakpoint. Since most processors support only a small number of hardware breakpoints, using even one can have a significant impact when debugging. You can also avoid using the hardware breakpoint when End of Program code is loaded in ROM by embedding a breakpoint in your code and renaming the label C\$\$EXIT to C\$\$EXITE\$\$ to indicate that this is an embedded breakpoint.

- **Disable All Breakpoints When Loading New Programs.** Enabling this option will remove all existing breakpoints before loading a new program.

The Project Options section offers the following options:

- **Open Dependent Projects When Loading Projects.** By default, if your program has subprojects upon which a main project is dependent, all the subprojects are opened along with the main project. If this option is disabled, then the subprojects will not be opened.
- **Do Not Scan Dependencies When Loading Projects.** To determine which files must be compiled during an incremental build, the project must maintain a list of include file dependencies for each source file. A dependency tree is created whenever you build a project. To create the dependency tree, all the source files in the project list are recursively scanned for #include, .include, and .copy directives, and each included file name is added to the project list. By default, when a project is opened, all files in the project are scanned for dependencies. If this option is disabled, it will not automatically scan for dependencies upon opening a project, and the project may open more quickly.
- **Auto-save Projects Before Build.** Enabling this option will save your project automatically before beginning a build.
- **Open Project Window On Startup.** Enabling this feature will open the active project window when CCStudio is started.

The CIO Options section offers the following option.

- **Maximum # of lines.** This option allows you to set the maximum number of lines shown in the Output window's *Stdout* tab. The default maximum is 256 lines, but you can set it as high as 32768. Changing this option may require restarting the program. Once a running application has output more lines than supported, the oldest output lines will be removed from the window so that the number of displayed lines does not exceed the maximum.

#### 5.1.1.4 Disassembly Style

Several options are available for changing the information view in the disassembly window. The Disassembly Style Options dialog box allows you to input specific viewing options for your debugging session.

To set disassembly style options:

1. Select Option→Disassembly Style, or right-click in the disassembly window and select Properties→Disassembly Options.
2. Enter your choices in the Disassembly Style Options dialog box.

Figure 5-1. Disassembly Style

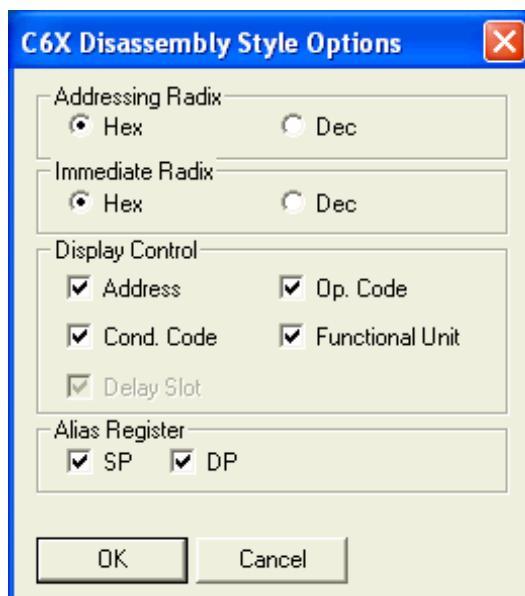

3. Click OK. The contents of the disassembly window are immediately updated with the new style.

## 5.1.2 Simulation

To configure the simulator to behave closer to the actual hardware target, you can set options for memory mapping (Section 5.1.3), pin connect (Section 5.1.4), or port connect (Section 5.1.5).

## 5.1.3 Memory Mapping

The memory map tells the debugger which areas of memory it can access. Memory maps vary depending on the application.

When a memory map is defined and memory mapping is enabled, the debugger checks every memory access against the memory map. The debugger will not attempt to access an area of memory that is protected by the memory map.

The debugger compares memory accesses against the memory map in software, not hardware. The debugger cannot prevent your program from attempting to access nonexistent memory.

### 5.1.3.1 Memory Mapping with Simulation

The simulator utilizes pre-defined memory map ranges to allow the most generic representation of valid memory settings for simulated DSP targets. The memory map settings can be altered to some degree; however, this is not recommended, as simulator performance may be affected by extensive changes to valid memory ranges.

### 5.1.3.2 Memory Mapping Using the Debugger

Although the memory map can be defined interactively while using the debugger, this can be inconvenient because you normally set up one memory map before debugging, and then use this memory map for all other debugging sessions.

To add a new memory map range:

1. Select Option→Memory Map.

Figure 5-2. Memory Map

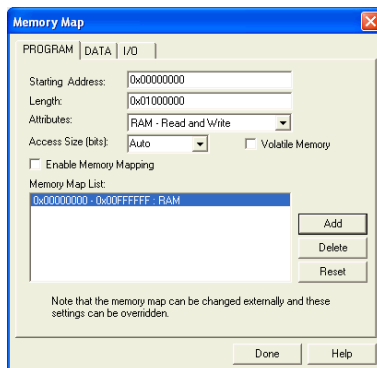

2. If your actual or simulated target memory configuration supports multiple pages, the Memory Map dialog box contains a separate tab for each type of memory page (e.g., Program, Data, and I/O). Select the appropriate tab for the type of memory that you want to modify. Tabs do not appear for processors that have only one memory page.
3. Click Done to accept your selections.

The Memory Map dialog offers the following options:

- **Enable Memory Mapping.** Ensure that the Enable Memory Mapping checkbox is checked. Otherwise, the debugger assumes all addressable memory (RAM) on your target is valid.
- **Starting Address.** Enter the start address of the new memory range in the Starting Address input field.
- **Length.** Enter the length of the new memory range in the Length input field.
- **Attributes.** Select the read/write characteristics of the new memory range in the Attributes field.
- **Access Size (bits).** Specify the access size for your target processor. You can select an access size from the dropdown list, or you can type a value in the Access Size field. It is not necessary to specify a size for processors that support only one access size.
- **Volatile Memory.** Normally, a write access consists of Read, Modify, and Write operations. When the Volatile Memory option is set on a segment of memory, any write access to that memory is completed by using only a Write operation.
- **Memory Map List.** Displays the list of memory-mapped ranges.
- **Add.** Adds a new memory range to the Memory Map list.
- **Delete.** In the Memory Map List, select the desired memory map range and click the Delete button. You can also delete an existing memory map range by changing the Attributes field to *None - No Memory/Protected*. This means you can neither read nor write to this memory location.
- **Reset.** Resets the default values in the Memory Map List.

The debugger allows you to enter a new memory range that overlaps existing ones. The new range is assumed to be valid, and the overlapped range's attributes are changed accordingly.

After you have defined a memory map, you may wish to modify its read/write attributes. You can do this by defining a new memory map (with the same Starting Address and Length) and clicking the Add button. The debugger overwrites the existing attributes with the new ones.

### 5.1.3.3 Defining Memory Map with GEL

The memory map can also be defined using the general extension language (GEL) built-in functions. GEL provides a complete set of memory-mapping functions. You can easily implement a memory map by putting the memory-mapping functions in a GEL text file and executing the GEL file at start up. (See [Section 5.5.1](#) for an introduction to GEL.)

When you first invoke the Code Composer Studio IDE, the memory map is turned off. You can access any memory location without interference from the memory map. If you invoke Code Composer Studio with an optional GEL filename specified as a parameter, the GEL file is automatically loaded. If the file contains the GEL function `Startup()`, the GEL functions in the file are executed. You can specify GEL mapping functions in this file to automatically define the memory mapping requirements for your environment.

Use the following GEL functions to define your memory map:

**Table 5-1. GEL Functions for Memory Maps**

Function	Description
GEL_MapAdd()	Memory map add
GEL_MapDelete()	Memory map delete
GEL_MapOn()	Enable memory map
GEL_MapOff()	Disable memory map
GEL_MapReset()	Reset memory map
GEL_MapAddStr()	Adds to the memory map



The GEL\_MapAdd() function defines a valid memory range and identifies the read/write characteristics of the memory range. The following is a sample of a GEL file that can be used to define two blocks of length 0xF000 that are both readable and writeable:

```
StartUp()  
{  
  GEL_MapOn();  
  GEL_MapReset();  
  GEL_MapAdd(0, 0, 0xF000, 1, 1);  
  GEL_MapAdd(0, 1, 0xF000, 1, 1);  
}
```

When you have set up your memory map, choose Option→Memory Map to view the memory map.

#### 5.1.4 Pin Connect

The Pin Connect tool enables you to specify the interval at which selected external interrupts occur.

To simulate external interrupts:

1. Create a data file that specifies interrupt intervals.
2. Start the Pin Connect tool by choosing Pin Connect from the Tools menu.
3. Select the pin name and click Connect.
4. Load your program.
5. Run your program.

For detailed information on the Pin Connect tool, see the Pin Connect topics provided in the online help: Help→Contents→Debugging Windows and Analysis Tools→Analysis Tools (Generic)→Pin Connect.

#### 5.1.5 Port Connect

You can use the Port Connect tool to access a file through a memory address. Then, by connecting to the memory (port) address, you can read data in from a file, and/or write data out to a file.

To connect a memory (port) address to a data file, follow these steps:

1. From the Tools menu, select Port Connect to display the Port Connect window and start the Port Connect tool.
2. Click the Connect button to open the Connect dialog box.
3. In the Port Address field, enter the memory address. This parameter can be an absolute address, any C expression, the name of a C function, or an assembly language label. If you want to specify a hex address, be sure to prefix the address number with 0x. Otherwise, it is treated as a decimal address.
4. In the Length field, enter the length of the memory range. The length can be any C expression.
5. In the Page field (C5000 only), choose type of memory (program or I/O) that the address occupies. For program memory, choose Prog. For I/O space, choose I/O.
6. In the Type field, select the Write or Read radio button, depending on whether you want to read data from a file or write data to a file.
7. Click OK to display the Open Port File window.
8. Select the data file to which you want to connect and click Open.
9. Select the No Rewind feature to prohibit the file from being rewound when the end-of-file (EOF) is reached. For read accesses made after EOF, the value 0xFFFFFFFF is read and the file pointer is kept unchanged.

The file is accessed during an assembly language read or write of the associated memory address. Any memory address can be connected to a file. A maximum of one input and one output file can be connected to a single memory address. Multiple addresses can be connected to a single file.

For detailed information on the Port Connect tool, see the Port Connect topics provided in the online help: Help→Contents→Debugging Windows and Analysis Tools→Analysis Tools (Generic)→Port Connect.

### 5.1.6 Program Load

The COFF file (\*.out) produced by building your program must be loaded onto the actual or simulated target board prior to execution.

Program code and data are downloaded onto the target at the addresses specified in the COFF file. Symbols are loaded into a symbol table maintained by the debugger on the host. The symbols are loaded at the code and data addresses specified in the COFF file.

A COFF file can be loaded by selecting File→Load Program and then using the Load Program dialog box to select the desired COFF file.

#### 5.1.6.1 Loading Symbols Only

It is useful to load only symbol information when working in a debugging environment where the debugger cannot or need not load the object code, such as when the code is in ROM.

Symbols can be loaded by selecting File→Load Symbols→Load Symbols Only from the main menu and then using the Load Symbols dialog box to select the desired COFF file.

The debugger deletes any previously loaded symbols from the symbol table maintained on the host. The symbols in the symbol file are then loaded into the symbol table. Symbols are loaded at the code and data addresses specified in the symbol file. This command does not modify memory or set the program entry point.

You can also specify a code offset and a data offset that the debugger will apply to every symbol in the specified symbol file. For example, if you have a symbol file for an executable that contains code addresses starting at 0x100 and data addresses starting at 0x1000. However, in the program loaded on the target, the corresponding code starts at 0x500100 and the data is located at 0x501000.

To specify the code and data offset, select File→Load Symbols→Load Symbols with Offsets from the main menu and then use the Load Symbols dialog box to select the desired COFF file. Once a COFF file is selected, an additional Load Symbols with Offsets dialog box will appear for you to enter the actual starting addresses for code and data.

**Figure 5-3. Data Offset**

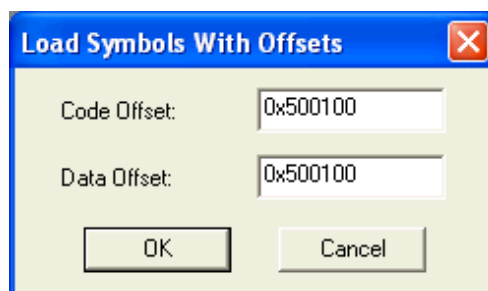

The debugger automatically offsets every symbol in that symbol file by the given value.

#### 5.1.6.2 Adding Symbols Only













Symbol information can also be appended to the existing symbol table. This command differs from the Load Symbol command in that it does not clear the existing symbol table before loading the new symbols, but just appends the new symbols to the existing symbol table.

The steps for adding symbol information, with File→Load Symbols→Add Symbols with Offsets, or without offsets File→Load Symbols→Add Symbols Only, is similar to the steps outlined above for loading symbols.

## 5.2 Basic Debugging

Several components are often necessary for basic debugging in the Code Composer Studio IDE. The chart below provides a list of the icons used for debugging in CCStudio. If these icons are not visible in the toolbar, select View→Debug Toolbars→ASM/Source Stepping. From the Debug Toolbars options list, you will see a list of various debug toolbars which can be made visible. A visible toolbar has a checkmark next to the name in the menu.

**Figure 5-4. Toolbar Icons for Running and Debugging**

	Step into (source mode)
	Step over (source mode)
	Step out (source and assembly mode)
	Single step (assembly mode)
	Step over (assembly mode)
	Run
	Halt
	Animate
	Toggle breakpoint
	Expression
	Run to Cursor
	Set PC to Cursor

### 5.2.1 Running/Stepping

#### 5.2.1.1 Running

To run a program, select the appropriate command under the Debug item on the IDE's menu. If the Target Control toolbar is also visible, run icons will be visible on a vertical toolbar on the left side. If these icons are not already visible, select View→Debug Toolbars→Target Control.

These commands allow you to run the program:

- **Main.** Take your execution to your main function by selecting Debug→Go Main.
- **Run.** After execution has been halted, you can continue to run by pressing the Run button.
- **Run to Cursor.** If you want the program to run to a specific location, you can place the cursor at that location and press this button.
- **Set PC to Cursor.** You can also set the program counter to a certain location by placing the cursor at the location and then pressing this button.
- **Low Power Run.** Choose Debug→Low Power Run. This is the same as a normal run, except that the target is not prevented from going into low power mode (sleep mode). If power is lost, the lower left corner of the CCStudio window will display a message. Losing power may cause breakpoints to be lost. After a halt, all breakpoints will be verified, and disabled if they are no longer present.
- **Animate.** This action runs the program until a breakpoint is encountered. Breakpoints stop the execution of the program. While the program is stopped, you can examine the state of the program, examine or modify variables, examine the call stack, etc. If you associate a file with the breakpoint action Read Data from File or Write Data to File, you can stop the program execution and then resume. Modify the animate speed by selecting Customize from the Option menu.
- **Halt.** Lastly, you can halt execution at any time by pressing the halt button.

### 5.2.1.2 Stepping

Both source and assembly stepping are available only when the execution has been halted. Source stepping steps through lines of code displayed in your source editor; Assembly stepping steps through lines of instructions that display in your disassembly window. By accessing the mixed Source/ASM mode through View→Mixed Source/ASM, you can view both source and assembly code simultaneously.

To perform a stepping command, choose the appropriate stepping icon on the toolbar, or select Debug→Assembly/Source Stepping and then the appropriate command.

There are three types of stepping:

- Single Step or Step Into executes one single statement and halts execution.
- Step Over executes the function and halts after the function returns.
- Step Out executes the current subroutine and returns to the calling function. Execution is then halted after returning to the calling function.

### 5.2.1.3 Multiprocessor Broadcast Commands Using PDM

When using the Parallel Debug Manager (PDM), all run/step commands are broadcast to all target processors in the current group. If the device driver supports synchronous operation, each of the following commands is synchronized to start at the same time on each processor.

- Use Locked Step (Step Into) to single step all processors that are not already running.
- Use Step Over to execute a step over on all processors that are not already running.
- If all the processors are inside a subroutine, you can use Step Out to execute the step-out command on all the processors that are not already running.
- Run sends a global run command to all processors that are not already running.
- Halt stops all processors simultaneously.
- Animate starts animating all the processors that are not already running.
- Run Free disables all breakpoints before executing the loaded program starting from the current PC location.

## 5.2.2 Breakpoints

Breakpoints are essential components of any debugging session. They stop the execution of the program. While the program is stopped, you can examine the state of the program, examine or modify variables, examine the call stack, etc. Breakpoints can be set on a line of source code in an editor window or on a disassembled instruction in the disassembly window. After a breakpoint is set, it can be enabled or disabled. You can also associate actions or conditions with it.

If a breakpoint is set on a source line, there must be an associated line of disassembly code. When compiler optimization is turned on, many source lines do not allow the setting of breakpoints. To see allowable lines, use mixed mode in the editor window.

---

**Note:** Code Composer Studio tries to relocate a breakpoint to a valid line in your source window and places a breakpoint icon in the selection margin beside the line on which it locates the breakpoint. If an allowable line cannot be determined, it reports an error in the message window.

---

---

**Note:** Code Composer Studio briefly halts the target whenever it reaches a breakpoint that is connected to a file. Any windows or displays connected to that breakpoint are updated when execution stops. Therefore, the target application may not meet real-time deadlines if you are using certain actions with breakpoints. At this stage of development, you are testing the algorithm. Later, you can analyze real-time behavior using RTDX and DSP/BIOS.

---

### 5.2.2.1 Breakpoint Manager

The Breakpoint Manager allows you to configure individual breakpoints, and allows you to choose various actions or properties to associate with the breakpoints. To open the Breakpoint Manager, select Breakpoints from the Debug menu. On C55x emulators, you also have options to set hardware breakpoints, watchpoints, or counters. See the *C55x Emulation Breakpoint Options* main online help topic for more information on these options.

**Figure 5-5. Breakpoint Manager**

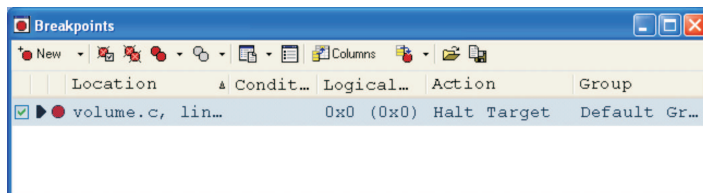

The Breakpoint Manager includes the following functions on the toolbar:

- New Item.** When you click this, it will prompt you to enter an address that will be the location for the breakpoint. That address corresponds to the location within the Assembly window. It can also correspond to a symbol in your code. If you type in a location that the breakpoint manager does not recognize, you will receive an error message that the breakpoint's location does not resolve to an address. To correct this, verify that the location is valid and that it is spelled correctly. You can still create/enable a breakpoint by double-clicking in the Selection Margin. By default, all newly created breakpoints are enabled. However, you can disable an individual breakpoint by unchecking the first checkbox for the breakpoint in the Breakpoint Manager. On C55x emulators, this menu also has options to create hardware breakpoints, watchpoints, and counters. On the C64xx CPU Cycle Accurate Simulator and C6416 Device Functional Simulator, there is also an option to make a Watchpoint. See [Section 5.2.2.4](#) for more information.
- Remove Selected Items.** Clicking this icon allows you to remove several breakpoints at the same time. However, it only removes the selected breakpoints. To remove more than one breakpoint, you need to select several breakpoints.
- Remove All.** Clicking this icon removes all breakpoints. A different icon performs the same action in the project toolbar.
- Enable All.** This icon has two separate actions it can execute. If you click on the icon, it will automatically enable all breakpoints. There is also a dropdown menu next to the icon that has a list of breakpoint groups you have configured. Choosing a group from the list will enable only those breakpoints in the group you have chosen. Enabled breakpoints have a checkmark next to them in the manager window.
- Disable All.** If you click on the icon, it will automatically disable all breakpoints. There is also a dropdown menu next to the icon that has a list of breakpoint groups you have configured. Choosing a group from the list will disable only those breakpoints in the group you have chosen. Disabled breakpoints do not have a checkmark next to them in the manager window.
- Goto Location.** This opens the location of any of your breakpoints in the Breakpoint Manager. Highlight the breakpoint in the Breakpoint Manager and click on the main icon to view the location of the breakpoint in the source editor. You can also view the same memory address in different windows (Source Editor, Disassembly Window, Memory Window) by choosing a window from the dropdown menu next to the icon.

- **Open Property Window.** This button launches the property window for the selected breakpoint. You can also open the Property Window by right-clicking within the Breakpoint Manager window and selecting Properties from the context menu. Properties that cannot be edited will appear grayed-out in the Property Window.
- **Hide/Show Columns.** This option allows you to choose which columns to display inside the Breakpoint Manager.
- **Create/Filter Groups.** If you have created a group of breakpoints, clicking this button will display a list of the groups you have created. This dialog allows you to create, remove, or rename breakpoint groups. There is also a dropdown menu that lists all breakpoint group, including the default group (grayed out). A checkmark beside the menu item indicates the breakpoint that belongs to this group is visible in the list view; otherwise, it is hidden. The menu item Show System Breakpoints enables system breakpoint visibility, although system breakpoints are read only.
- **Load Configuration.** This button allows you to load a set of breakpoints that you have previously saved (see Save Breakpoint Configuration).
- **Save Configuration.** After closing the IDE, all your breakpoints will be lost. However, you can save them to a configuration with this button, which creates an XML file inside your project, making it possible to restore them later.

Once a breakpoint has been created, the Breakpoint Manager allows you to associate an action with that breakpoint. See the online help for more information on the Breakpoint Manager, including a guide to the different breakpoint icons.

### 5.2.2.2 Software Breakpoints

Breakpoints can be set in any disassembly window or document window containing C/C++ source code. There is no limit to the number of software breakpoints that can be set, provided they are set at writable memory locations (RAM). Software breakpoints operate by modifying the target program to add a breakpoint instruction at the desired location.

To set a software breakpoint:

1. In a document window or disassembly window, move the cursor over the line where you want to place a breakpoint.
2. Double-click in the selection margin immediately preceding the line when you are in a document window. In a disassembly window, double-click on the desired line.

A breakpoint icon (solid red dot) in the selection margin indicates that a breakpoint has been set at the desired location.

The Toggle Breakpoint context menu option or Toggle Breakpoint button also enable you to quickly set and clear breakpoints.

1. In a document window or disassembly window, put the cursor in the line where you want to set the breakpoint.
2. Right-click and select Toggle Breakpoint from the context menu, or click on the Toggle Breakpoint icon button on the Project toolbar.

Finally, you can also create a software breakpoint using the Breakpoint Manager.

1. From the Debug menu, select Breakpoints.
2. In the Breakpoint Manager, select the New Item icon in the toolbar, select New Software Breakpoint from the dropdown menu and type in a location for the breakpoint.
3. The new breakpoint will appear in the Breakpoint Manager list.



### 5.2.2.3 Hardware Breakpoints

Hardware breakpoints differ from software breakpoints in that they do not modify the target program; they use hardware resources available on the chip. Hardware breakpoints are useful for setting breakpoints in ROM memory or breaking on memory accesses instead of instruction acquisitions. A breakpoint can be set for a particular memory read, memory write, or memory read or write. Memory access breakpoints are not shown in the source or memory windows. The number of hardware breakpoints you can use depends on your DSP target. Hardware breakpoints can also have a count, which determines the number of times a location is encountered before a breakpoint is generated. If the count is 1, a breakpoint is generated every time. Hardware breakpoints cannot be implemented on a simulated target. On C55x emulators, you also have options to set hardware breakpoints, watchpoints, or counters. See the *C55x Emulation Breakpoint Options* main help topic for more information on these options.

To set a hardware breakpoint:

1. Select Debug→Breakpoints. The Breakpoint Manager appears.
2. From the New Item button dropdown menu, select Hardware Breakpoint.
3. Enter the program or memory location where you want to set the breakpoint. Use one of the following methods:
  - For an absolute address, you can enter any valid C expression, the name of a C function, or a symbol name.
  - Enter a breakpoint location based on your C source file. This is convenient when you do not know where the C instruction is located in the executable. The format for entering in a location based on the C source file is: *fileName, lineNumber*.

### 5.2.2.4 C64x Simulator Watchpoints

Watchpoints halt simulation when an access is made to a targeted memory location. The access could be from the CPU or from the DMA (if supported by the particular device configuration). Debug reads and writes to memory locations do not cause watchpoints to trigger. Watchpoints are supported by the following configurations:

- C64xx CPU Cycle Accurate Simulator
- C6416 Device Functional Simulator

To use this option, you must load a project and open the Breakpoint Manager by selecting Debug → Breakpoints. In the Breakpoint Manager, select New Watchpoint from the dropdown menu next to the New Item icon in the toolbar. The New Watchpoint dialog will open. Enter a location for the watchpoint and an event to break on. Location can be specified either as an absolute memory address, or a symbol name. For example, to create a watchpoint on a global variable defined in a .c file as:  
int IntegerA;

You would specify the watchpoint location as:

&IntegerA

You can choose from the following events:

- Memory Read
- Memory Write
- All Access Types

Choose an event and click OK. The Breakpoint Manager will show your new watchpoint. See the online help for *Watchpoints* for more information on modifying existing watchpoint properties or halting the target on these breakpoints.

## 5.2.3 Connecting Breakpoints to Files

### 5.2.3.1 Functions

You can set an action for a breakpoint that will allow you to:

- Transfer input data from a file on the host PC to a buffer on the target for use by the algorithm
- Transfer output data from a buffer on the target to a file on the host PC for analysis
- Update a window, such as a graph, with data

### 5.2.3.2 Using Breakpoints to Transfer Data from a PC File to a Target

You can use a breakpoint to transfer the contents of a PC file to the target for use as test data and update the data windows.

1. Choose File→Load Program. Select filename.out, and click Open.
2. Double-click on the filename.c file in the Project View.
3. Choose Breakpoints from the Debug menu to open the Breakpoint Manager.
4. Put your cursor in a line of the main function to which you want to add a breakpoint. Identify the name of the function (dataIO, for instance).
5. Click the Toggle Breakpoint toolbar button or press F9. This will set a software breakpoint. The selection margin indicates that a breakpoint has been set (red icon). You can also set a breakpoint using the Breakpoint Manager or using the Property Window for the Breakpoint Manager.
6. The breakpoint should appear in the Breakpoint Manager. In the Breakpoint Manager window, find the Action column, and click on the dropdown box in the row for the breakpoint you just made. Select Read Data from File as the action. A Parameter dialog box appears.
7. Click on the space next to File in the Parameter dialog box, browse to your project folder, select filename.dat, and click Open. Then change the Start Address and the Length values as desired. Also, you can put a check mark in the Wrap Around box if required. The Start Address field specifies where the data from the file is to be placed. The Length field specifies how many samples from the data file are read each time the breakpoint is reached. The Wrap Around option causes the IDE to start reading from the beginning of the file when it reaches the end of the file. This allows the data file to be treated as a continuous stream of data.

**Figure 5-6. Sample Parameter Dialog**

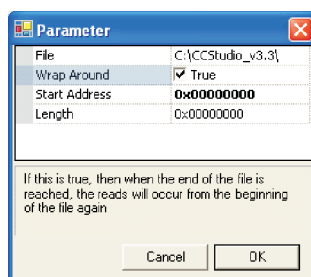

8. Click OK. A control window for the filename.dat file appears that allows you to start, stop, rewind, or fast forward within the data file.

**Figure 5-7. Data File Control**



9. The breakpoint should appear as connected in the Breakpoint Manager.

To connect to a file output, choose the action Write Data to File in the Breakpoint Manager. You will need to input information on the File, Format, Starting Address, and Length, as well as Page type for certain devices.



## 5.2.4 Watch Window

### 5.2.4.1 Using Watch Window to Track a Variable's Value

When debugging a program, it is useful to see how the value of a variable changes during program execution. The watch window allows you to monitor the values of local and global variables and C/C++ expressions. You can also add a global or file static variable from a list as a watched expression. For detailed information on the watch window, see the Watch Window topics provided in the online help: Help→Contents→Debugging Windows and Analysis Tools→Debugging Windows→Watch Window. To open the watch window:

1. Select View→Watch Window, or click the Watch Window icon button on the Watch toolbar. The watch window contains two tabs: Watch Locals and Watch 1.
  - In the Watch Locals tab, the debugger automatically displays the Name, Value, Type, and Radix option of the variables that are local to the currently executing function.
  - In the Watch 1 tab, the debugger displays the Name, Value, Type, and Radix option of the local and global variables and expressions that you specify.
2. Choose File→Load Program. Load your .out file for this project.
3. Double-click on the filename.c file in the Project View.
4. Put your cursor in a line that allows breakpoints.
5. Click the Toggle Breakpoint toolbar button or press F9. The selection margin indicates that a breakpoint has been set (red icon).
6. Choose View→Watch Window. A separate area in the lower-right corner of the window appears. At run time, this area shows the values of watched variables. By default, the Watch Locals tab is selected and displays variables that are local to the executed function.
7. If not at main, choose Debug→Go Main.
8. Choose Debug→Run, or press F5 or the Run icon. The watch window will update the local values.

**Figure 5-8. Watch Locals Tab**



9. Select the Watch 1 tab.
10. Click on the Expression icon in the Name column and type the name of the variable to watch.
11. Click on the white space in the watch window to save the change. The value should immediately appear, similar to this example.

**Figure 5-9. Specifying a Variable to Watch**

12. Click the Step Over toolbar button or press F10 to step over the call to your watched variable.

In addition to watching the value of a simple variable, you can watch the values of the elements of a structure.

#### 5.2.4.2 Using Watch Window to Watch Values of a Structure's Elements

To watch the values of the elements of a structure:

1. Select the Watch 1 tab.
2. Click on the Expression icon in the Name column and type the name of the expression to watch.
3. Click on the white space in the watch window to save the change.
4. Click once on the + sign. The line expands to list all the elements of the structure and their values. (The address shown for Link may vary.)

**Figure 5-10. Watch Element Values**



5. Double-click on the value of any element in the structure to edit that value.
6. Change the value of a variable.

Notice that the value changes in the watch window. The value also changes color to red, indicating that you have changed it manually.

## 5.2.5 Property Page Manager Window

CCStudio has added property windows for options relating to the following debug windows: the Breakpoint Manager (Section 5.2.2), the Memory window (Section 5.2.6), and the Cache Tag RAM Viewer (Section 5.2.15). Other debug windows still use separate dialog boxes for property configuration. Each debug window has a different set of options and the list may change depending on what is selected inside the debug window. For instance, the property values may change for different breakpoints in the Breakpoint Manager, or for different memory addresses in the Memory window. When the Breakpoint Manager, Memory Window, or Cache Tag RAM Viewer are open, right-click anywhere in that window and select Properties from the context menu, or select View→Property Window.

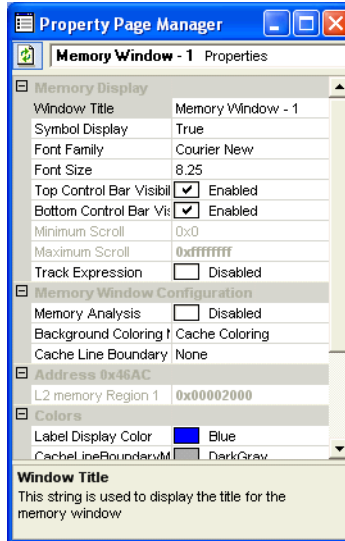
**Figure 5-11. Property Window**



To collapse a set of properties, choose the minus sign next to the set. To expand a set of properties, choose the plus sign next to the collapsed set. If you click on a single property, the description of that property will appear in the bottom of the window. Clicking on a property value and hovering over it with the mouse will display a short tool tip description of that property value.

If the descriptions of a property are long, you may not be able to read the entire description of that property. To show the rest of the description, grab the border cursor (i.e., the two parallel lines) and move it upward to expand the available space for description.

To enable or disable the value of a property, click on the value twice to confirm the change. Otherwise, choose the desired value from the dropdown menu or type in the box.

For the Breakpoint Manager Property Window, once you have changed a property, the title of the Property Window will show in italics with a star (\*) next to it. Click on the Submit Changes icon in the toolbar to apply the changes to the property window. The Refresh icon will also apply the changes. Once you have applied the changes, the title of the window will be in normal text again. The Add icon will add a new breakpoint (or other item) with the same properties.

The Property Window for C55x emulator breakpoints also has advanced options available for each item selected. If you click on one of the advanced properties, a description of the property will appear in the description box below.

## 5.2.6 Memory Window

The memory window allows you to view the contents of memory starting at a specified address. Select View→Memory to display the memory window. You can enter a starting address in the text box at the top left of the window, or select a target from the right dropdown menu. You can also edit the contents of a selected memory location by double-clicking on the value. For devices that support cache management, the memory window also has color backgrounds and highlighting to display various kinds of cache and cache tag information. You can open multiple instances of the memory window. Any property changes made within an open memory window apply only to that memory window, except for the Memory Analysis property, which applies to all memory windows.

Figure 5-12. Memory Window

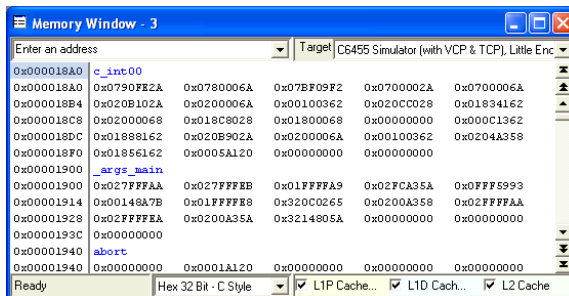

The L1P Cache/L1D Cache/L2 Cache checkboxes on the bottom let you highlight memory values coming from cache instead of addressable memory for certain devices. See the online help sections on the memory window for more detailed information on using the memory window for cache coherency.

Double-clicking on a memory value will allow you to directly edit the value. Values that have been edited will appear in red. For more information on the memory window and its options, see the online help. To refresh the active memory window, right-click within the memory window and choose Refresh.

The Memory Window Properties window allows you to specify various characteristics of the memory window. To view the properties of the memory window, right-click in the Memory Window and choose Properties from the context menu. Some properties will appear only if you enable other properties. The list below contains a comprehensive list of properties. However, that does not mean all are available for your target or applicable to your configuration.

Figure 5-13. Memory Window Options

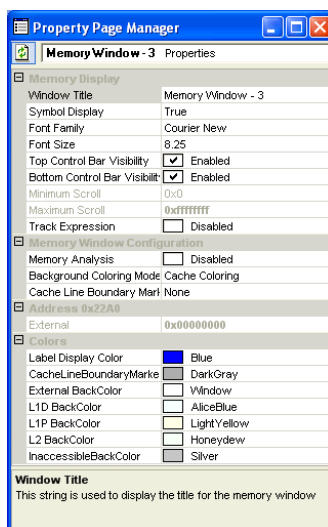

The Properties page offers these memory window options:

- Memory Display:
  - Window Title: This string is used to display the title for the memory window.
  - Symbol Display: This Boolean property indicates whether the memory window should display symbols.
  - Font Family: This specifies which font family to use when displaying data in the memory window.
  - Font Size: This specifies which font size to use when displaying data in the memory window.
  - Top Control Bar Visibility: Use this to show and hide the top control bar on the memory window.
  - Bottom Control Bar Visibility: Use this to show and hide the bottom bar on the memory window.
  - Minimum Scroll: Use this to set the minimum possible value the memory window can be scrolled to.
  - Maximum Scroll: Use this to set the minimum possible value the memory window can be scrolled to.
  - Track Expression: If enabled, the memory window will refresh the expression currently in the address combo box each time the target halts.
- Memory Window Configuration:
  - Background Coloring Mode:
    - None: Turns off background coloring.
    - Cache Coloring: Background color reflects which level of cache the memory was read from.
    - Memory Level Coloring: Background color reflects which level of cache or mapped memory the memory was read from.
  - Cache Line Boundary Markers: Configures the memory window to draw a thin line around the left and top edges of the data at the start of a cache line.
  - Memory Analysis: Note: Auto-disabled when in polite real-time mode or continuous refresh. When enabled, Cache Tag RAM Details will be displayed as properties of the selected address item in the property editor and memory analyzer options will become visible in the Bold property category. This property is shared by all views of this memory space. Disable to reduce the time it takes to update the display.
- Address (specific address of cursor): The properties under this category vary depending on the memory/cache type currently selected by the cursor. Depending on cache levels you are using at that memory address, you may see one line or multiple lines containing values. The data can reveal the cause of visibility or data corruption problems by indicating whether a line is dirty in any cache.
  - L1D Cache/L1P Cache/L2 Cache/External: The values listed here display discrepancy/coherency problems. It also displays which levels of the memory hierarchy this data is cached in.
  - L1D Cache LRU/L2 Cache LRU: LRU (least recently used) is true if this cache line is the next to be evicted from cache. L1P does not have LRUs.
  - L1D Cache Dirty Bit/L2 Cache Dirty Bit: Dirty bit is true if this cache line has been modified by the CPU. L1P does not have dirty bits, and emulation writes will not set the dirty bit.
  - Dirty Cache Lines Analysis: This value will indicate any cache marked as dirty at this memory address.
- Bold Values (Memory Analyzers): Only visible when Memory Analysis has been enabled.
  - Data Memory Differences: Compares the contents of cached data memory with the contents of the mapped data memory it is associated with and highlights addresses where the two are different.
  - LRU Cache Lines: Highlights cached memory addresses that have been marked as Least Recently Used.
  - Dirty Cache Lines: Highlights cached memory addresses that have been marked as dirty.
  - Program Memory Differences: Compares the contents of cached program memory with the contents of the mapped program memory it is associated with and highlights addresses where the two are different.

- Colors:
  - Label Display Color: The color to be used when displaying labels in the memory window.
  - CacheLineBoundaryMarkerColor: If one of the Cache Line Border Marks is enabled, the start of each cache line in the target device's memory is identified by drawing a line to the left and above the first memory item in the cache line.
  - L1D BackColor: Each level in the target device's memory hierarchy can be displayed with a unique background color to provide a visual indication in the memory window of where in the memory hierarchy a memory item is being read from.
  - External BackColor: Each level in the target devices' memory hierarchy can be displayed with a unique background color to provide a visual indication in the memory window of where in the memory hierarchy
  - L1P Back Color: Each level in the target device's memory hierarchy can be displayed with a unique background color to provide a visual indication in the memory window of where in the memory hierarchy a memory item is being read from.
  - L2 Back Color: Each level in the target device's memory hierarchy can be displayed with a unique background color to provide a visual indication in the memory window of where in the memory hierarchy a memory item is being read from.
  - InaccessibleBackColor : Each level in the target device's memory hierarchy can be displayed with a unique background color to provide a visual indication in the memory window of where in the memory hierarchy a memory item is being read from.

### 5.2.7 Register Window

The register window enables you to view and edit the contents of various registers on the target.

**Figure 5-14. Register Window**

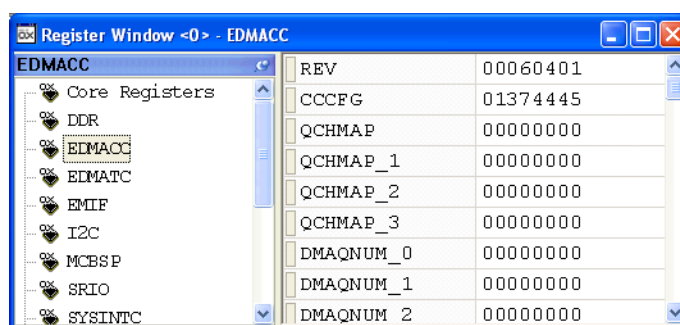

To access the register window, select View→Registers and select the register set that you would like to view or edit. Double-clicking on the value of a register will allow you to directly edit the value. Values that have been edited will appear in red.

You can view the registers in grid view (default) or in tree view. Right-click on the Register window and select Grid view or Tree view from the context menu. Tree view allows you to expand some registers to show the individual bits for that register. Any registers that support a bitfield will have a small + sign next to them. These can be expanded to view the bitfield. The value for each bit can be edited by double-clicking on the value. Any edited values will appear in red.

To access the contents of a register without opening the Registers window, select Edit→Register. Choose the register from the dropdown list and edit the value as desired.

**Figure 5-15. Editing a Registry Value**

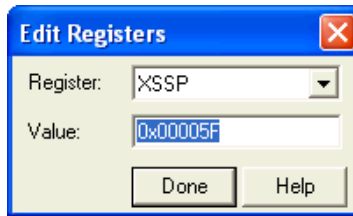

### 5.2.7.1 Customizing Register Groups

The register now has a additional feature that allows you to organize registers into customized groups. With the register window open, right-click and choose Customize Register Group from the context menu. Create a new group with the New Group button, and then use the arrow buttons in the dialog to move individual registers into the register group.

**Figure 5-16. Customize Register Groups**

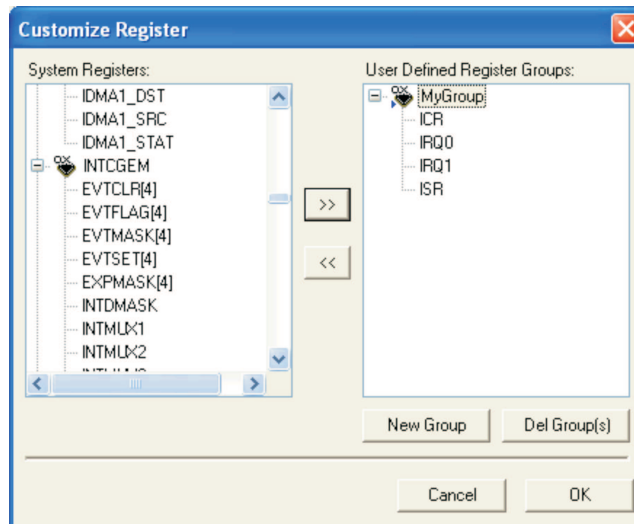

Choose OK to return to your normal register window, which will now show your custom group. If you click on it, your chosen registers now appear on the right panel.

**Figure 5-17. Register Window with Customized Register Group**

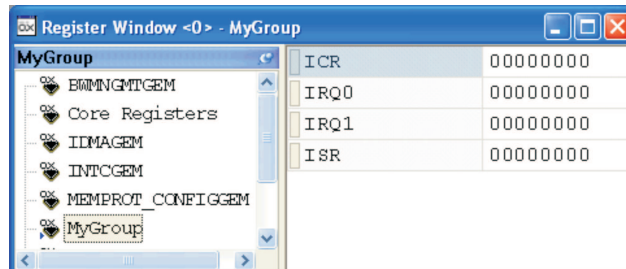

To delete the custom group you have created, either right-click inside the Register Window and choose Remove User Defined Group or open the Customize Register dialog and choose the Del Group(s) button.



## 5.2.8 Disassembly/Mixed Mode

### 5.2.8.1 Disassembly Mode

When you load a program onto your actual or simulated target, the debugger automatically opens a disassembly window.

**Figure 5-18. Disassembly Window**

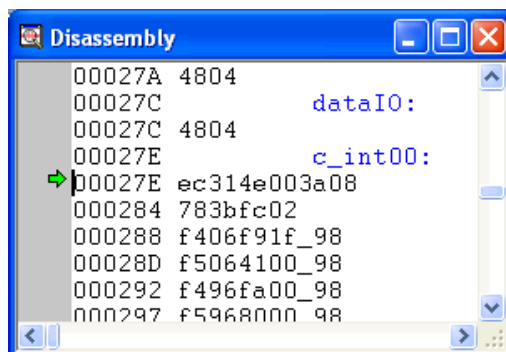

The disassembly window displays the disassembled instructions and symbolic information needed for debugging. Disassembly reverses the assembly process and allows the contents of memory to be displayed as assembly language code. Symbolic information consists of symbols and strings of alphanumeric characters that represent addresses or values on the target.

As you step through your program using the stepping commands, the PC advances to the instruction.

### 5.2.8.2 Mixed Mode

In addition to viewing disassembled instructions in the disassembly window, the debugger enables you to view your C source code interleaved with disassembled code, allowing you to toggle between source mode and mixed mode. To change your selection, toggle View→Mixed Source/ASM, or right-click in the source file window and select Mixed Mode or Source Mode, depending on your current selection.

## 5.2.9 Call Stack

Use the Call Stack window to examine the function calls that led to the current location in the program. To display the Call Stack:

1. Select View→Call Stack, or click the View Stack button on the Debug toolbar.

**Figure 5-19. Call Stack Window**

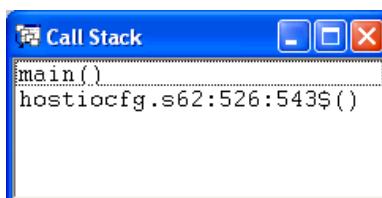

2. Double-click on a function listed in the Call Stack window. The source code containing that function is displayed in a document window. The cursor is set to the current line within the desired function. Once you select a function in the Call Stack window, you can observe local variables that are within the scope of that function.

The call stack only works with C programs. Calling functions are determined by walking through the linked list of frame pointers on the runtime stack. Your program must have a stack section and a main function; otherwise, the call stack displays the message *C source is not available*. Also note that the Call Stack window displays only the first 100 lines of output, it omits any lines over 100.



### 5.2.10 Symbol Browser

The Symbol Browser window (Figure 5-20) displays five tabbed windows for a loaded COFF output file (\*.out):

- All associated files
- Functions
- Global variables
- Types
- Labels

Each tabbed window contains nodes representing various symbols. A plus sign (+) preceding a node indicates that the node can be further expanded. To expand the node, simply click the + sign. A minus sign (-) precedes an expanded node. Click the - sign to hide the contents of that node.

To open the Symbol Browser window, select View→Symbol Browser.

**Figure 5-20. Symbol Browser Window**

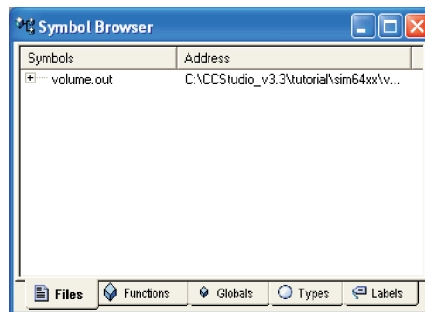

For detailed information on the Symbol Browser tool, see the Symbol Browser topics provided in the online help.

### 5.2.11 Command Window

The Command Window enables you to specify commands to the debugger using the TI Debugger command syntax.

Many of the commands accept C expressions as parameters. This allows the instruction set to be relatively small, yet powerful. Because evaluating some types of C expressions can affect existing values, you can use the same command to display or change a value.

To open the Command Window, select Tools→Command Window.

**Figure 5-21. Command Window**

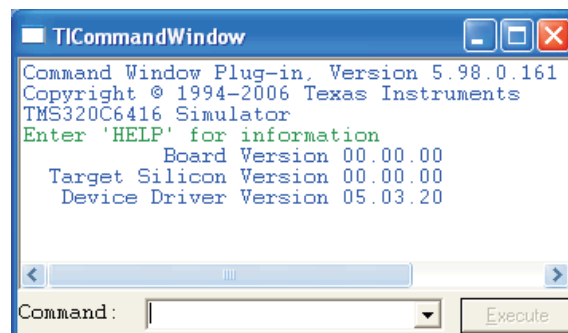

For detailed information on the Command Window, see the Command Window topics provided in the online help.

### 5.2.12 Memory Save/Load Utility

Previous versions of CCStudio supported data file formats in either a COFF output file (.out) or a CCStudio data file (.dat). This tool allows you to support raw binary data transfers, and also allows for faster download speeds. This new option is available for ARM and C5000 targets. It has been optimized to take advantage of the newer emulation capabilities of the XDS560 to allow improvements of data download speeds (host to target), as well as additional improvements in speed regardless of emulator. There is also an option to perform byte swapping for every 16-bit word during the data transfer. You can use the Write file to memory tab to load a file, and the Save memory to file tab to save a file.

### 5.2.13 C6000 Functional Simulators Interrupt Latency Detection Feature

This tool allows you to measure the worst-case interrupt latency of the code, including programming interrupt constraints such as disabling GIE /NMIE, and architectural behavior such as non-serviceability of interrupts in branch delay slots. Note: This feature is only available on the C6000 functional simulators.

While programming, you may find that the algorithm has a larger interrupt latency than quoted. If so, you may not discover it until late in the development lifecycle, and it may require a delay to correct. Characterization of the interrupt latency of the code is needed so that you can determine the real time latencies in the application. The application consists of multiple components that cannot be individually designed. The Interrupt Latency Detection (ILD) feature on the C6000 simulator provides you with a deterministic measure of the worst-case interrupt latency of the code. As a result, you can quote the interrupt latency of the code for a given set of test vectors. See the online help topics for the *Interrupt Latency Detection Feature* for more information on how to use this option.

### 5.2.14 Cache Coherence

If multiple devices, such as the CPU or peripherals, share the same cacheable memory region, cache and memory can become incoherent. Suppose the CPU accesses a memory location that is subsequently allocated in cache. Later, a peripheral writes data to this same location that is meant to be read and processed by the CPU. However, since this memory location is kept in cache, the memory access hits in cache and the CPU reads the old data instead of the new data. A similar problem occurs if the CPU writes to a memory location that is cached, and the data is to be read by a peripheral. The data only is updated in cache but not in memory from where the peripheral reads the data. The cache and the memory are said to be incoherent. Coherence needs to be addressed if the following events are true:

- Multiple requestors (CPU data path, CPU fetch path, peripherals, DMA controllers, other external entities) share a region of memory for the purpose of data exchange.
- This memory region is cacheable by at least one device.
- A memory location in this region has been cached.
- This memory location has been modified (by any device).

Consequently, if a memory location is shared, cached, and has been modified, there is a cache coherence problem.

C64x+ DSPs automatically maintain cache coherence for DMA (includes EDMA and IDMA) data accesses to L2 SRAM through a hardware cache coherence protocol based on snoop commands. The coherence mechanism is activated on a DMA read and write access. When a DMA read of a cached L2 SRAM location occurs, the data is directly forwarded from L1D cache to the DMA without being updated in L2 SRAM. On a DMA write, the data is forwarded to L1D cache and is updated in L2 SRAM.

For other scenarios, it is your responsibility to maintain cache coherency, see the online help for more information.

### 5.2.15 Cache Tag RAM Viewer

The Cache Tag RAM viewer displays the contents of a tag RAM in tabular form. The cache tag RAM stores cache states including tag address, valid, dirty, and LRU. The Cache Tag RAM viewer provides a static view into cache that lets you verify your optimization methods. You can check whether what is expected to be in cache is currently in cache. You can also fine-tune memory layouts and access patterns. For instance, the LRU status can be actively managed to retain certain data structures in cache.

**Note:** The Cache Tag RAM Viewer is only supported on C64x+ based devices.

Although this same information displays in the memory window, the memory map representation offers limited capability to view cache capacity and assess cache conflicts. For these tasks, the information is better represented in a cache "map" that shows cache lines and their associated status bits.

To launch the viewer, choose Tools→CacheTagRAMViewer Control→Cache Tag RAM Viewer.

**Figure 5-22. Cache Tag RAM Viewer**

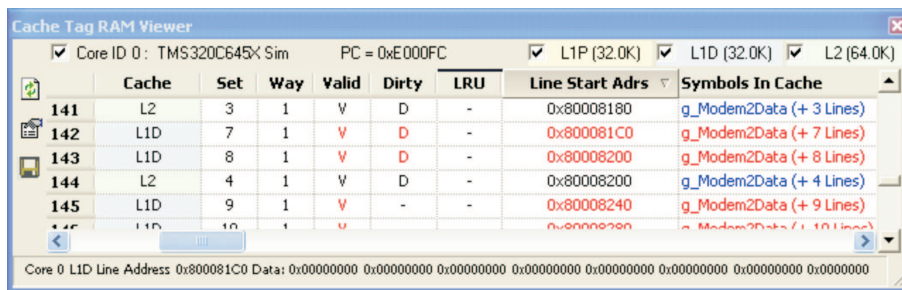

- Core ID: Core ID identifies the CPU core on the device to which each core device belongs
- Cache: Cache identifies the cache level and type to which each cache line belongs.
- Set: Set identifies the set of cache lines to which each cache lines belongs
- Way: For N-way set associative caches, Way identifies the way each cache line occupies. Blank for direct-mapped caches.
- Valid: V if the cache line is valid, hyphen (-) if line is marked invalid
- Dirty: D if the cache line is dirty, hyphen (-) if not dirty, blank if not implemented by the cache
- LRU Least Recently Used Way: L for the least-recently used way in the set, hyphen (-) if not least recently used, blank if not implemented by the cache
- Line Start Adrs: The first address in the line of memory that has been cached
- Symbols in Cache: This shows the symbolic names defined for any of the addresses in the cached line of memory. See online help for more detail.
- Headers: Uncheck to remove all of this core's caches from the cache tag RAM view

### 5.2.15.1 Cache Tag RAM Viewer Properties

To view the properties for the Cache Tag RAM, right-click on the Cache Tag RAM viewer and choose Properties from the context menu. Using the Property Window, you can show only dirty or invalid cache lines or limit your view only to changed cache lines. You can also make the display show a row for each cache line, or a row for each symbol.

Figure 5-23. Cache Tag RAM Viewer Property Page

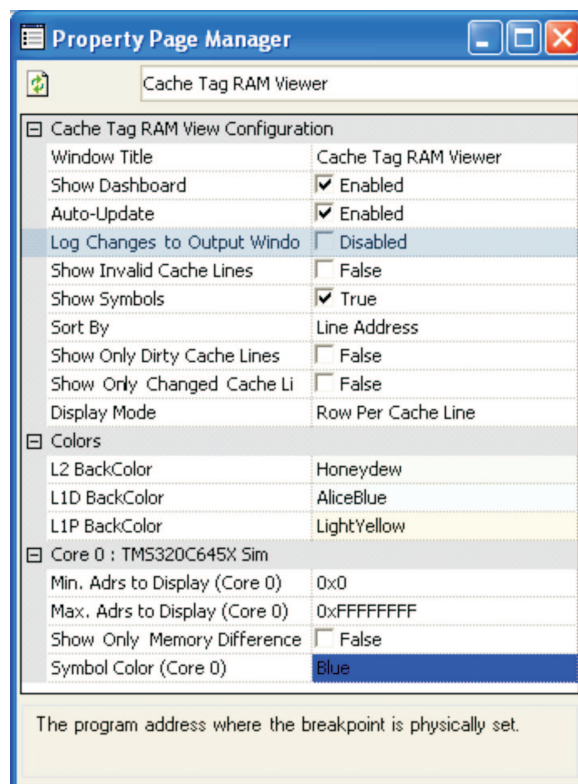

- Cache Tag RAM View Configuration
  - Window Title: Title of window.
  - Show Dashboard: Controls whether the target status and cache controls at the top of the Cache Tag RAM Viewer display are shown or not
  - Auto-Update: Controls whether the display is automatically updated when a target device halts, or requires a manual refresh
  - Log Changes to Output Window: When true, logs cache lines that have changed since the previous refresh to the IDE's output window
  - Show Invalid Cache Lines: When enabled, both valid and invalid cache lines in the selected caches are displayed.
  - Show Symbols: When true, all of the symbols for each device are read out and displayed against the cache lines in which they reside. (Tip: Turn off to improve single step execution speed.)
  - Sort By: Data in the Cache Tag RAM Viewer can be sorted by any of the columns.
  - Show Only Dirty Cache Lines: When true, only lines that are dirty are displayed
  - Show Only Changed Cache Lines.
  - Display Mode: In Symbol Per Row display mode, only cache lines that contain addresses with symbols defined are displayed with each symbol on a separate row. In Cache Lines per Row display mode, each cache line is shown on a unique row with all of its symbols shown in a string separated by commas.

- Colors
  - L2 BackColor: Each level in the target device's memory hierarchy can be displayed with a unique background to provide a visual indication in the memory window of where a memory item is being read from in the memory hierarchy.
  - L1D BackColor: Each level in the target device's memory hierarchy can be displayed with a unique background to provide a visual indication in the memory window of where a memory item is being read from in the memory hierarchy.
  - L1P BackColor: Each level in the target device's memory hierarchy can be displayed with a unique background to provide a visual indication in the memory window of where a memory item is being read from in the memory hierarchy.
- Core 0: (device name)
- Minimum Address to Display: Only cache lines that include an address greater than or equal to this address are displayed. Hit the Escape key to revert to the default value.
- Maximum Address to Display: Only cache lines that include an address less than or equal to this address are displayed. Hit the Escape key to revert to the default value.
- Show Only Memory Differences: When true, only cache lines with contents that differ from the associated mapped memory are displayed
- Symbol Color: Determines the displayed foreground color of symbols such as labels

### 5.2.16 Exception Reporting

Exceptions are high priority interrupts that can cause the CPU to branch to an exception handler. The exception handler then attempts to recover from the fault and resume normal execution, thereby avoiding a full reset or power cycle of the system. Exceptions can signal many kinds of problems, and provide information about CPU fault conditions. Exceptions resulting from memory protection or security violations might indicate problems with memory maps or bad pointers (CPU or DMA).

If the exception reporting tool reports an exception, the CPU will halt and display a message in the output window. At that point, you can view the information and decide whether to terminate the application (and reset the CPU), resume the application, or let an exception handler proceed to run.

If your device supports exceptions, you can configure exception reporting by selecting Debug→Exceptions. An option dialog will open, check the feature marked Enable Exception Handling on the bottom left to view and choose exception types.

Figure 5-24. Exceptions Window

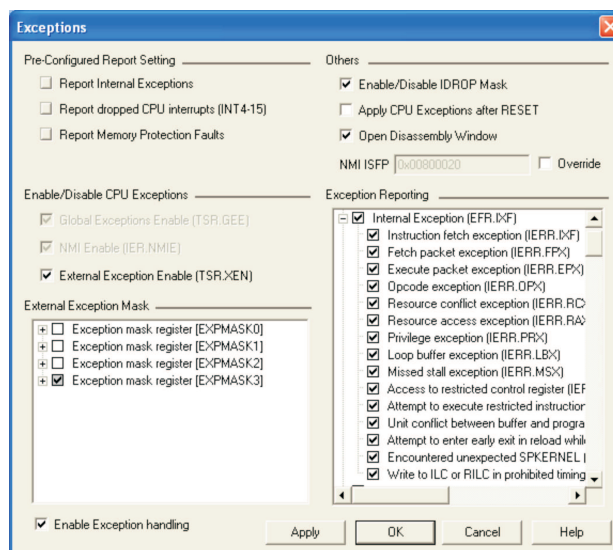

**Note:** Even if you check Enable Exception Handling, no exceptions will be enabled until you first check which types of exceptions you wish to report. The types include the following basic exceptions, see the main help topic on Configuring Exception Reporting for more information.

- A software exception is caused by the instruction SWE (or SWENR). It can be used to call into the operating system functions which require the CPU to be in secure supervisor mode.
  - An internal exception is caused by illegal conditions within the CPU core (e.g., an illegal opcode was encountered).
  - The NMI exception is an external exception that is non-maskable. It can be used to notify the application about a serious problem outside the CPU.
  - An external exception is maskable and can be used to alert the application about an error outside the CPU (e.g., memory protection faults, peripheral errors, etc).
- 

Changes to the exception configuration will remain even if a project is closed, but check the Apply CPU Exceptions After Reset option to keep the configuration between CCStudio uses. See the online help topics on Exception Reporting for more information.

---

**Note:** Exception reporting is only supported on C64x+ based devices.

---

### 5.2.17 *Software Pipelined Loop (SPLOOP) Buffer*

More recent targets like C64x+ support Software Pipelined Loop (SPLOOP), an algorithm for processing software loops in a more efficient manner. For detailed information about SPLOOPS and their characteristics, see the *TMS320C64x/C64x+ DSP CPU and Instruction Set Reference Guide* ([SPRU732](#)). The SPLOOP facility on the C64x+ DSP stores a single iteration of the loop in a specialized buffer and contains hardware that will selectively overlay copies of the single iteration in a software pipeline manner to construct an optimized execution of the loop. To view the SPLOOPS on an appropriate target, choose Project → Build Options, and then select the following build options: Opt Level: (-2 or higher) and Target Version: mv64+. If you step through a disassembly code that uses SPLOOPS, you may notice that more than one cursor arrow appears in the selection margin of the disassembly code. These multiple cursor arrows are a virtual representation of the loops executing in parallel. SPLOOP-supported targets will organize execution packets within these loops to optimize power use, efficiency and speed.

---

**Note:** SPLOOP is only supported on C64x+ based devices.

---

### 5.2.18 *MMU Page Table Viewer*

The MMU Page Table Viewer tool is a new option for CCStudio on the ARM 9 and ARM 11 devices that allows you to visualize how the Memory Management Unit (MMU) translates virtual memory to physical memory. Physical memory refers to the memory devices that are attached to the CPU. Virtual memory is generated by the program. Virtual addresses are translated and mapped by hardware on the CPU into the physical addresses required to access the memory devices. This translation allows multiple tasks to simultaneously run the same program without linking the program against the physical memory address range associated with each task. The translation process also controls which memory regions are accessible, protects regions of memory from inadvertent or malicious access by a program, and manages memory resources. The mapping and translation are performed by the Memory Management Unit (MMU), which uses a virtual address to look up the corresponding physical address region and its configuration information.



The MMU Page Table Viewer allows you to accurately visualize the address translation tables and configuration of the MMU. It decodes the two level page table hierarchy of the MMU, displaying the logical to physical memory mapping and the page frame attributes. The Page Table Viewer has a flexible XML driven display, which supports ARM 9 and ARM 11 MMU page tables. The Viewer display can be set to either automatically or manually update, and when sorted by logical address, only the visible page table entries are read from the target. However, the Viewer is currently only supported for emulation, and there is no visualization of cached Translation Lookaside Buffer (TLB) page table entries. Note: The MMU Page Table Viewer currently only provides visibility into the ARM v5 MMU. It does not support the ARM v6 MMU.

To launch the MMU Page Table Viewer, choose MMU Page Table Viewer from the Tools menu. This opens a new window at the bottom of CCStudio. Scroll over each column to display the associated tooltip which provides an explanation of the options available, as well as tips for usage. Both levels of the page hierarchy are merged into one view in the Viewer. The master page table (Level 1) is indexed, and the second level index (Level 2) is shown for each entry. The column on the far left of the window displays the page levels: the first number is the L1 table index, and the second number is the L2 table index for each entry. To choose a logical address for viewing, select the desired address from the dropdown box in the upper left corner of the Viewer window. You can also choose to enable the MMU, system mode, or ROM mode. Choosing any of these options will reload the Viewer. Double-clicking on an entry in the Viewer will open that page table entry in the memory window for editing. You can also edit the entry by in the Property Manager Window for that row.

## 5.3 Advanced Debugging Features

### 5.3.1 Advanced Event Triggering (AET)

Advanced Event Triggering uses Event Analysis and Event Sequencer tools to simplify hardware analysis.

Event Analysis uses an interface to configure common hardware debug tasks called jobs. You can easily set breakpoints, action points, and counters by using a context menu and performing a drag-and-drop action. You can access Event Analysis from the Tools menu, or by right-clicking in a source file.

Event Sequencer looks for conditions in your target program and initiates specific actions when it detects these conditions. While the CPU is halted, you define the conditions and actions, then run your target program. The sequence program looks for the specified condition and performs the requested action.

#### 5.3.1.1 Event Analysis

The following jobs can be performed using Event Analysis:

- Setting breakpoints
  - Hardware breakpoints
  - Hardware breakpoints with count
  - Chained breakpoint
- Setting action/watch points
  - Data actionpoint
  - Program actionpoint
  - Watchpoint
  - Watchpoint with data
- Setting counters
  - Data access counter
  - Watchdog timer
  - Counter (from current location)
  - Count in Range
- Other
  - Benchmark to here
  - Emulation pin configuration

For detailed information on the Event Analysis tool, see the online help.

To configure a job using the Event Analysis Tool, Code Composer Studio IDE must be configured for a target processor that contains on-chip analysis features. You can use Event Analysis by selecting it from the Tools menu or by right-clicking in a source file. Once you configure a job, it is enabled and will perform analysis when you run code on your target. For information about how to enable or disable a job that is already configured, see the Advanced Event Triggering online help.

1. Select Tools→Advanced Event Triggering→Event Analysis to view the Event Analysis window.

**Figure 5-25. Event Analysis Window**

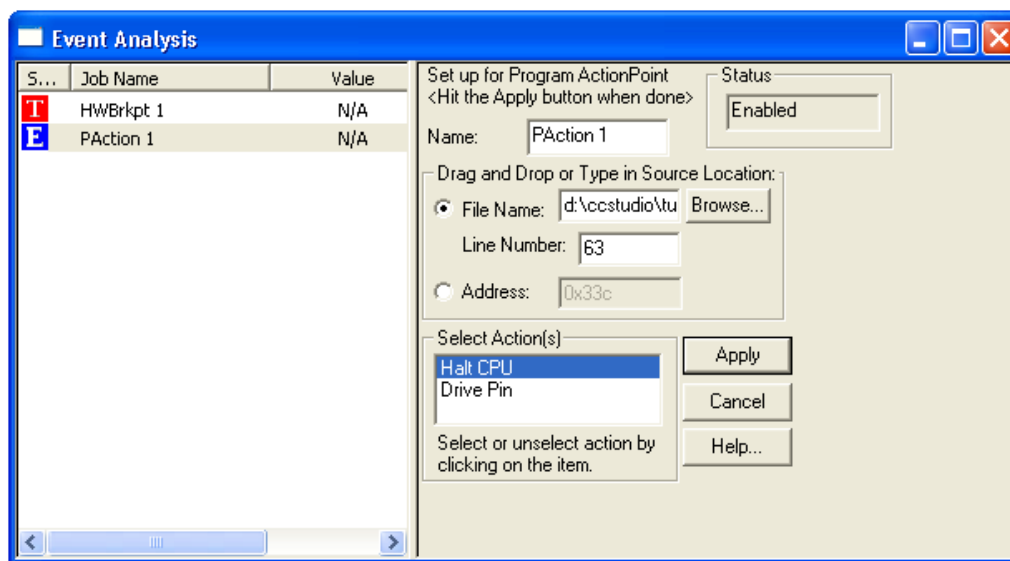

2. Right-click in the Event Analysis Window and choose Event Triggering→Job Type→Job. The job menu is dynamically built and dependent on the target configuration. Unsupported jobs are grayed out.
3. Type your information in the Job dialog box.
4. Click Apply to program the job and save your changes.

### 5.3.1.2 Event Sequencer

Event Sequencer looks for conditions in your target program and initiates specific actions when it detects these conditions. While the CPU is halted, you define the conditions and actions, then run your target program. The sequence program looks for the specified condition and performs the requested action.

To use the Event Sequencer, Code Composer Studio IDE must be configured for a target processor that contains on-chip analysis features. You can use the Event Sequencer by selecting it from the Tools menu. Once you create an Event Sequencer program, it is enabled and performs analysis when you run code on your target. For information on creating an Event Sequencer program, see the Advanced Event Triggering online help.



To enable the Event Sequencer:

1. Select Tools→Advanced Event Triggering→Event Sequencer. The Event Sequencer displays.

**Figure 5-26. Event Sequencer**

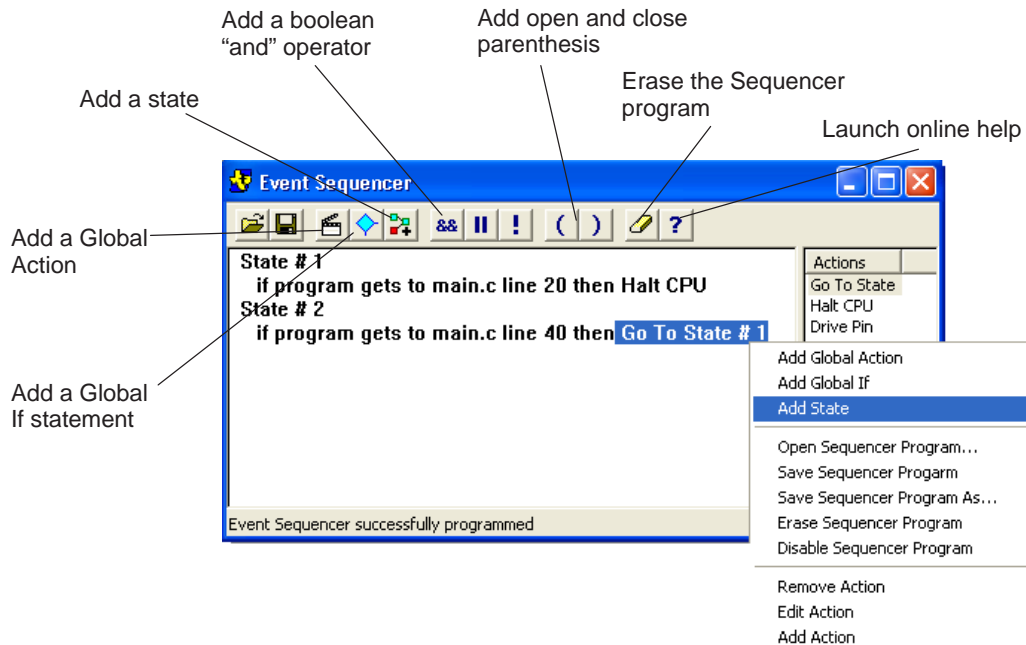

2. Right-click in the Event Sequencer window or use the Event Sequencer toolbar buttons to create a sequencer program.

## 5.4 Real-Time Debugging

Traditional debugging approaches (stop mode) require that programmers completely halt their system, which stops all threads and prevents interrupts from being handled. Stop mode can be exclusively used for debug as long as the system/application does not have any real-time constraints. However, for a better gauge of your application's real-world system behavior, Code Composer Studio IDE offers several options, including Real-Time Mode ([Section 5.4.1](#)), Rude Real-Time Mode ([Section 5.4.2](#)), and Real-Time Data Exchange ([Section 5.4.3](#)).

### 5.4.1 Real-Time Mode

Real-time mode allows time-critical interrupts in the foreground code to be taken while the target is halted in background code. A time-critical interrupt is an interrupt that must be serviced even when background code is halted. For example, a time-critical interrupt might service a motor controller or a high-speed timer. You can suspend program execution in multiple locations, which allows you to break within one time-critical interrupt while still servicing others.

To enable real-time mode debug:

1. You may need to configure interrupts and set breakpoints to get ready for real-time mode, see the online tutorial on Real-Time Emulation for more information. Select Debug→Real-time Mode. The status bar at the bottom of the control window now indicates POLITE REALTIME.
2. Configure the real-time refresh options by selecting View→Real-Time Refresh Options. The first option will specify how often the Watch Window is updated. Checking the Global Continuous Refresh checkbox will continuously refresh all windows that display target data, including memory, graph, and watch windows. To continuously update only a certain window, uncheck this box and select Continuous Refresh from the window's context menu.
3. Click OK to close the dialog box.
4. Select View→Registers→Core Registers to open the Core Register window. The debug interrupt enable register (DIER) should be visible in the list. DIER designates a single interrupt, a specific subset of interrupts, or all interrupts that you selected via the interrupt enable registers (IER) as real-time (time-critical) interrupts. DIER mirrors the architecturally specified IER.
5. Double-click on a register value and enter the new register value to specify which interrupts to designate as real-time interrupts.
6. Click somewhere in the white space to view the change. Values that have been edited will appear in red.
7. Code Composer Studio IDE has been configured for Real-Time Mode debug.

### **5.4.2 Rude Real-Time Mode**

High priority interrupts, or other sections of code can be extremely time-critical, and the number of cycles taken to execute them must be kept at a minimum or to an exact number. This means debug actions (both execution control and register/memory accesses) may need to be prohibited in some code areas or targeted at a specific machine state. In default real-time mode, the processor runs in polite mode by absence of privileges, i.e., debug actions will respect the appropriate action delaying and not intrude in the debug sensitive windows.

However, debug commands (both execution control and register/memory access) can fail if they are not able to find a window that is not marked debug action-sensitive. In order to have the debugger gain control, you must change real-time debug from polite to rude mode. In rude real-time mode, the possession of privileges allows a debug action to override any protection that may prevent debug access and be executed successfully without delay. Also, you can not debug critical code regions until they are switched into rude real-time mode.

To enable rude real-time mode, perform one of the following:

- Select Perform a Rude Retry from the display window when a debug command fails.
- Select Enable Rude Real-time Mode from Debug menu when Real-Time is enabled.

When rude real-time is enabled, the status bar at the bottom of the main program window displays RUDE REALTIME. To disable rude real-time, deselect the Enable Rude Real-time Mode item in the Debug menu. The status bar now reads POLITE REALTIME.

If rude real-time is enabled and you halt the CPU, there is a good chance that the CPU will halt even when debug accesses are blocked, which might be within a time-critical ISR. This prevents the CPU from completing that ISR in the appropriate amount of time, as the CPU cannot proceed until you respond to the breakpoint. To prevent this problem, you must switch back to polite real-time mode by deselecting Enable Rude Real-time Mode.

See the online help section Debugging Windows and Analysis Tools→Analysis Tools (Generic)→Real Time Debugging for more detailed information on real-time mode.

### 5.4.3 Real-Time Data Exchange (RTDX)

The DSP/BIOS Real-Time Analysis (RTA) facilities utilize the Real-Time Data Exchange (RTDX) link to obtain and monitor target data in real-time. You can utilize the RTDX link to create your own customized interfaces to the DSP target by using the RTDX API Library. See the online help or tutorial for more details.

Real-time data exchange (RTDX) transfers data between a host computer and target devices without interfering with the target application. This bi-directional communication path provides for data collection by the host as well as host interaction with the running target application. The data collected from the target may be analyzed and visualized on the host. Application parameters may be adjusted using host tools, without stopping the application. RTDX also enables host systems to provide data stimulation to the target application and algorithms.

RTDX consists of both target and host components. A small RTDX software library runs on the target application. The target application makes function calls to this library's API in order to pass data to or from it. This library uses a scan-based emulator to move data to or from the host platform via a JTAG interface. Data transfer to the host occurs in real-time while the target application is running.

On the host platform, an RTDX host library operates in conjunction with Code Composer Studio IDE. Data visualization and analysis tools communicate with RTDX through COM APIs to obtain the target data and/or to send data to the DSP application.

The host library supports two modes of receiving data from a target application: continuous and non-continuous. In continuous mode, the data is simply buffered by the RTDX Host Library and is not written to a log file. Continuous mode should be used when the developer wants to continuously obtain and display the data from a target application, and does not need to store the data in a log file. In non-continuous mode, data is written to a log file on the host. This mode should be used when developers want to capture a finite amount of data and record it in a log file.

#### 5.4.3.1 RTDX Data Flow

RTDX forms a two-way data pipe between a target application and a host client. This data pipe consists of a combination of hardware and software components as shown below.

**Figure 5-27. RTDX Data Flow**

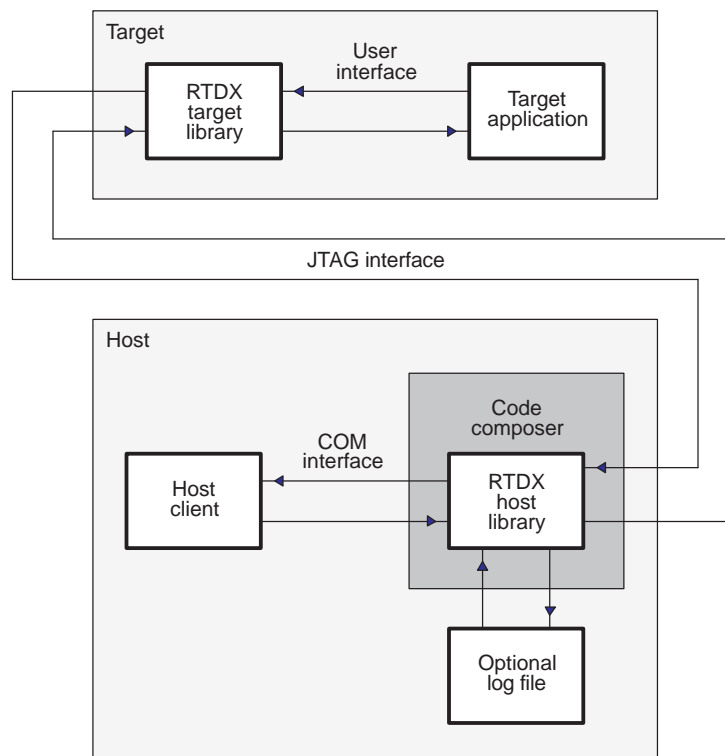

### 5.4.3.2 Configuring RTDX Graphically

The RTDX tools allow you to configure RTDX graphically, set up RTDX channels, and run diagnostics on RTDX. These tools allow you to enhance RTDX functionality when transmitting data.

RTDX has three menu options: Diagnostics Control, Configuration Control, and Channel Viewer Control.

**Diagnostics Control.** RTDX provides the RTDX Diagnostics Control to verify that RTDX is working correctly on your system. The diagnostics test the basic functionality of target-to-host transmission and host-to-target transmission. To open the RTDX Diagnostics Control, select Tools→RTDX→Diagnostics Control. These tests are only available if RTDX is enabled.

**Figure 5-28. RTDX Diagnostics Window**

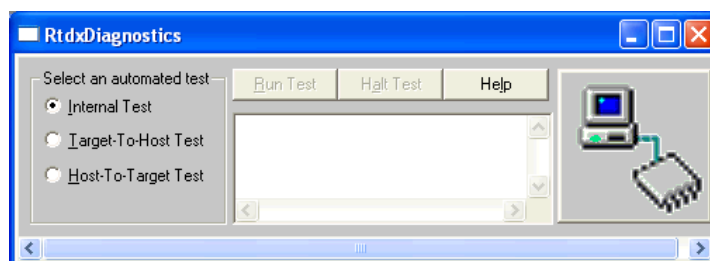

**Configuration Control.** This is the main RTDX window. It allows you to:

- View the current RTDX configuration settings
- Enable or disable RTDX
- Access the RTDX Configuration Control Properties page to reconfigure RTDX and select port configuration settings

To open the RTDX Configuration Control, select Tools→RTDX→Configuration Control.

**Figure 5-29. RTDX Configuration Window**

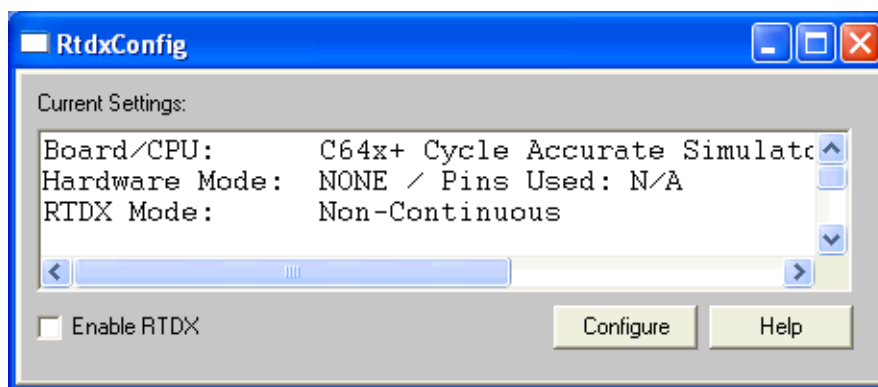

**Channel View Control.** The RTDX Channel Viewer Control is an Active X control that automatically detects target-declared channels and adds them to the viewable list. The RTDX Channel Viewer Control also allows you to:

- Remove or add a target-declared channel from the viewable list
- Enable or disable a channel that is on the list

To open the RTDX Channel Viewer Control in Code Composer Studio IDE, select Tools→RTDX→Channel Viewer Control. The Channel Viewer Control window displays.

**Figure 5-30. RTDX Channel Viewer Window**

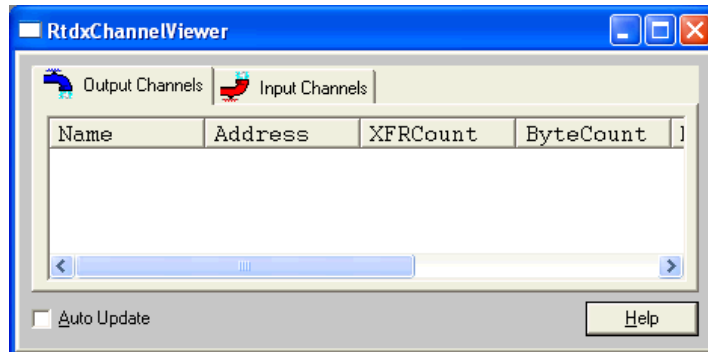

Click on the Input and Output Channels tabs to display a list of those channels. Both the Output and Input Channels windows allow you to view, delete, and re-add channels.

Checking the Auto-Update feature enables you to automatically update information for all channels without refreshing the display. If you are not using the Auto-Update feature, right-click on a tab and select Refresh from the context menu to update information for all channels.

---

**Note:** For the RTDX Channel View Control to receive extended channel information for a specific channel, an RTDX client must have that channel open.

---

### 5.4.3.3 Sending a Single Integer to the Host

The basic function of RTDX is to send a single integer to the host. The following steps provide an overview of the process of sending data from the target to the host and from the host to the target. For specific commands and details on transmitting different types of data, see the online RTDX help or tutorial.

To send data from your target application to the host:

1. Prepare your target application to capture real-time data by inserting specific RTDX syntax into your application code to allow real-time data transfer from the target to the host. Although the process for preparing a target application is the same for all data types, different data types require different function calls for data transfer. Therefore, sending an integer to the host requires you to add a function call that is specific to only transmitting a single integer, instead of sending an array of integers to the host.
2. Prepare your host client to process the data by instantiating one RTDX object for each desired channel, opening a channel for the objects specified, and calling any other desired functions.
3. Start Code Composer Studio IDE.
4. Load your target application onto the TI processor.
5. Check the Enable RTDX box under Tools→RTDX→Configuration Control.
6. Run your target application to capture real-time data and send it to the RTDX Host Library.
7. Run your host client to process the data.

For details on using RTDX, see the online RTDX help or tutorial.

#### 5.4.3.4 Receiving Data from the Host

A client application can send data to the target application by writing data to the target. Data sent from the client application to the target is first buffered in the RTDX Host Library. The data remains in the RTDX Host Library until a request for data arrives from the target. Once the RTDX Host Library has enough data to satisfy the request, it writes the data to the target without interfering with the target application.

The state of the buffer is returned into the variable `buffer state`. A positive value indicates the number of bytes the RTDX Host Library has buffered which the target has not yet requested. A negative value indicates the number of bytes that the target has requested which the RTDX Host Library has not yet satisfied.

To send data from a host client to your target application:

1. Prepare your target application to receive data by writing a simple RTDX target application that reads data from the host client.
2. Prepare your host client to send data by instantiating one RTDX object for each desired channel, opening a channel for the objects specified, and calling any other desired functions.
3. Start Code Composer Studio IDE.
4. Load your target application onto the TI processor.
5. Check the Enable RTDX box under Tools→RTDX→Configuration Control.
6. Run your target application.
7. Run your host client.

For details on using RTDX, see the online RTDX help or tutorial.

## 5.5 Automation (for Debug)

### 5.5.1 Using the General Extension Language (GEL)

As mentioned earlier, GEL scripts can be used to create custom GEL menus and automate steps in Code Composer Studio. [Section 4.6.1](#) described how to use built-in GEL functions to automate various project management steps. There are also many built-in GEL functions that can be used to automate debug steps, such as setting breakpoints, adding variables to the Watch Window, beginning execution, halting execution, and setting up File I/O.

### 5.5.2 Scripting Utility for Debug

The scripting utility ([Section 4.6.2](#)) also has commands that can automate many debug steps. See the online help that comes with the scripting utility for more information.

## 5.6 Reset Options

It may be necessary to perform a reset of the target or the emulator using commands integrated in the Code Composer Studio IDE. The availability of these reset commands depends on the IDE connection to the target. See [Section 3.1.3](#) for more information on connecting or disconnecting the target.

### 5.6.1 Target Reset

Target reset initializes the contents of all registers to their power-up state, and halts execution of the program. If the target board does not respond to this command and you are using a kernel-based device driver, the CPU kernel may be corrupt. In this case, you must reload the kernel. The simulator initializes the contents of all registers to their power-up state, according to target simulation specifications. To reset the target processor, select Debug→Reset CPU.

---

**Note:** Connection must be established with the target for the Debug→Reset CPU option to be available.

---

### 5.6.2 Emulator Reset

Some processors require putting the processor into its functional run state before a hard reset will work. In this case, the only way to force the processor back into this functional run state is to reset the emulator. An emulator reset will pull the TRST pin active, forcing the device to the functional run mode.

The Reset Emulator option becomes available whenever Code Composer Studio is disconnected from the target. To reset the emulator, choose Debug→Reset Emulator. Upon running Reset Emulator, the hardware is left in a free running state and you can now manually reset the target hardware by pressing the reset button or by selecting Debug→Reset CPU. Note that this does not apply to ARM devices.

### 5.6.3 Advanced Resets

In addition to the default reset option (Reset CPU), you may have a choice of alternate resets depending on your target. Click on Debug→Advanced Resets to see a list of alternate resets. These are defined differently on each target; your target documentation will describe any new resets that are available through this menu item.

### 5.6.4 Halt on Reset

When Halt on Reset is selected from the Debug menu, the target will halt after a reset (inside the reset vector). Otherwise, the target will run. Some user-initiated resets will not necessarily run the target immediately, this is more for an external reset or when running and executing a reset. This value is undetermined until the target is connected. If you have hardwired this state in the hardware after a power up, the value will not be correct until it is connected. You can force a change on the target even when it is not connected.





## Analyze/Tune

---

---

---

To create an efficient application, you may need to focus on performance, power, code size, or cost, depending on your goals.

Application Code Analysis is the process of gathering and interpreting data about the factors that influence an application's efficiency. Application Code Tuning is the modification of code to improve its efficiency. DSP developers can analyze and tune their application as often as necessary to meet the efficiency goals defined by their customers, application, and hardware.

Code Composer Studio IDE provides various tools to help developers analyze and tune their applications.

Topic	Page
<b>6.1 Application Code Analysis .....</b>	<b>90</b>
<b>6.2 Application Code Tuning (ACT) .....</b>	<b>94</b>

## 6.1 Application Code Analysis

The analysis tools offered by Code Composer Studio IDE have been designed to gather and present important data.

### 6.1.1 Data Visualization

Code Composer Studio IDE can graph data processed by your program in a variety of ways, including time/frequency, constellation diagram, eye diagram, and image. Access these graphs by choosing View→Graph and selecting the desired graph type. Then you can specify the graph properties in the graph property dialog. The example below shows a Single Time (Time/Frequency) graph property dialog. See the online help for more detailed information.

**Figure 6-1. Sample Graph Properties Dialog**

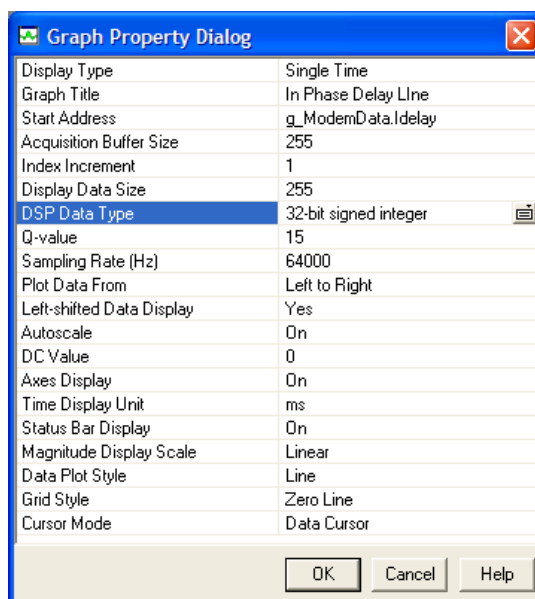

Once the properties are configured, click the OK button to open a graph window that plots the specified data points. If the graph is animated, it will update on every halt if there are no breakpoints connected to the graph. However, if there is a connected breakpoint, it will only update on that breakpoint.

**Figure 6-2. Example Graph**

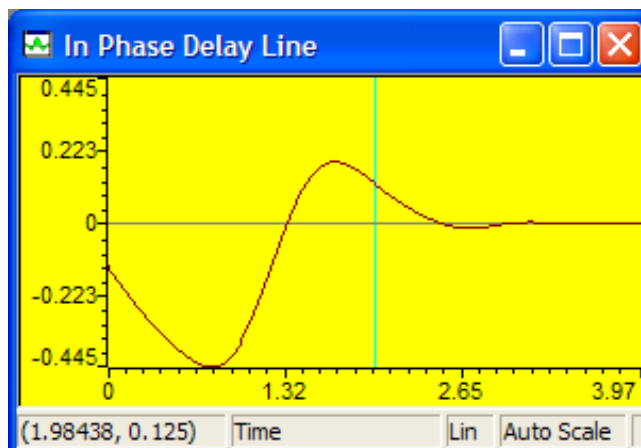

### 6.1.2 Simulator Analysis

The Simulator Analysis tool reports on particular system events so you can accurately monitor and measure your program performance. For detailed information, see the Simulator Analysis topics provided in the online help.

User options for simulator analysis include:

- Enable/disable analysis
- Count the occurrence of selected events
- Halt execution whenever a selected event occurs
- Delete count or break events
- Create a log file
- Reset event counter

To use the Simulator Analysis tool:

1. Load your program.
2. Start the analysis tool. Select Tools→Simulator Analysis for your device.
3. Right-click in the Simulator Analysis window and select Enable Analysis from the context menu, if it is not already enabled.
4. Run or step through your program.
5. Analyze the output of the analysis tool.

### 6.1.3 Emulator Analysis

The C6000 Emulator Analysis tool allows you to set up, monitor, and count events and hardware breakpoints. For detailed information, see the Emulator Analysis topics provided in the online help.

To start the Emulator Analysis tool, load your program, and select Tools→Emulator Analysis for your device from the menu bar. This option is only available when emulators are in use.

The Emulator Analysis window contains the following information in columns:

- **Event.** The event name.
- **Type.** Whether the event is a break or count event.
- **Count.** The number of times the event occurred before the program halted.
- **Break Address.** The address at which the break event occurred.
- **Routine.** The routine in which the break event occurred.

---

**Note:** You cannot use the analysis feature while you are using the profiling clock.

---

### 6.1.4 DSP/BIOS Real-Time Analysis (RTA) Tools

The DSP/BIOS Real-Time Analysis (RTA) features, shown in [Figure 6-3](#), provide you with unique visibility into your application by allowing you to probe, trace, and monitor a DSP application during execution. These utilities piggyback upon the same physical JTAG connection already employed by the debugger, and use this connection as a low-speed (albeit real-time) communication link between the target and host.

**Figure 6-3. Real-Time Capture and Analysis**

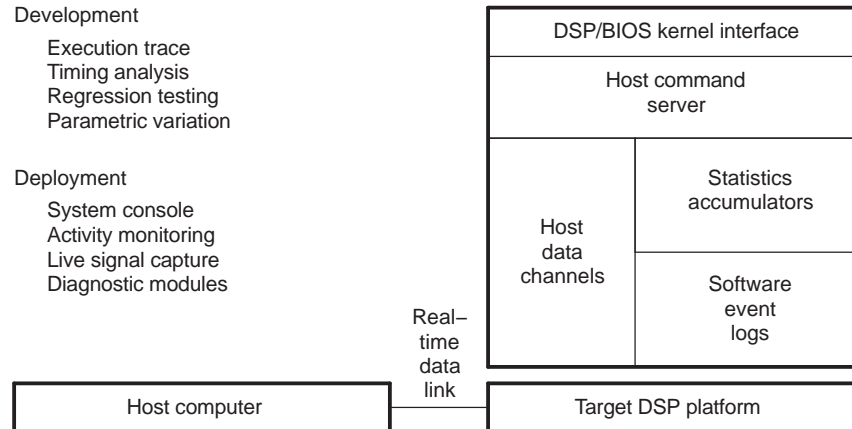

DSP/BIOS RTA requires the presence of the DSP/BIOS kernel within the target system. In addition to providing run-time services to the application, the DSP/BIOS kernel provides support for real-time communication with the host through the physical link. By structuring an application around the DSP/BIOS APIs and statically created objects, you can automatically instrument the target for capturing and uploading the real-time information that drives the CCStudio visual analysis tools. Supplementary APIs and objects allow explicit information capture under target program control as well. From the perspective of its hosted utilities, DSP/BIOS affords several broad capabilities for real-time program analysis.

The DSP/BIOS Real-Time Analysis tools can be accessed through the DSP/BIOS toolbar (Figure 6-4).

**Figure 6-4. DSP/BIOS RTA Toolbar**

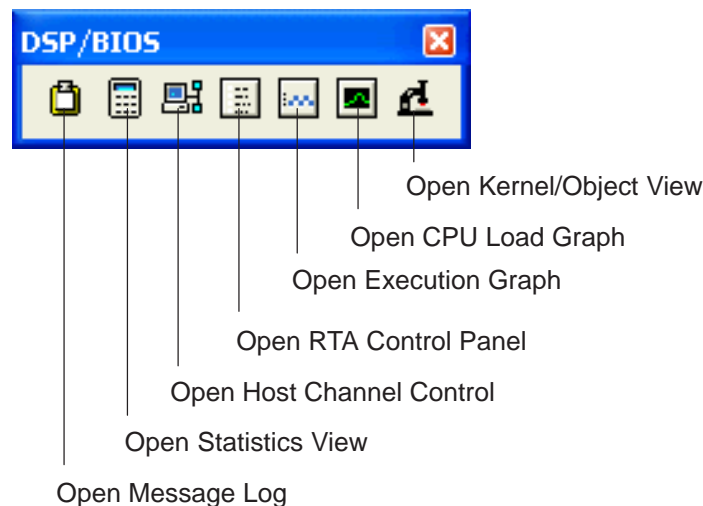

Here is a description of each element on the toolbar:

- **Message Log.** Displays time-ordered sequences of events written to kernel log objects by independent real-time threads. This is useful for tracing the overall flow of control in the program. There are two ways in which the target program logs events:
  - Explicitly, through DSP/BIOS API calls. For example, this can be done through `LOG_printf(&trace, "hello world!");`, where `trace` is the name of the log object.
  - Implicitly, by the underlying kernel when threads become ready, dispatched, and terminated. An example of this would be log events in the Execution Graph Details.  
 You can output the log to a file by right-clicking in the Message Log window and selecting Property Page.
- **Statistics View.** Displays summary statistics amassed in kernel accumulator objects, reflecting dynamic program elements ranging from simple counters and time-varying data values, to elapsed processing intervals of independent threads. The target program accumulates statistics explicitly through DSP/BIOS API calls or implicitly by the kernel when scheduling threads for execution or performing I/O operations. You can change various settings by right-clicking in the Statistics View window and selecting Property Page.
- **Host Channel Control.** Displays host channels defined by your program. You can use this window to bind files to these channels, start the data transfer over a channel, and monitor the amount of data transferred. Binding kernel I/O objects to host files provides the target program with standard data streams for deterministic testing of algorithms. Other real-time target data streams managed with kernel I/O objects can be tapped and captured to host files on-the-fly for subsequent analysis.
- **RTA Control Panel.** Controls the real-time trace and statistics accumulation in target programs. In effect, this allows developers to control the degree of visibility into the real-time program execution. By default, all types of tracing are enabled. You must check the *Global host enable* option to enable the tracing types. Your program can also change the settings in this window. The RTA Control Panel checks for any programmatic changes at the rate set for the RTA Control Panel in the Property Page. In the Property Page, you can also change refresh rates for any RTA tool, such as the Execution Graph.
- **Execution Graph.** Displays the execution of threads in real-time. Through the execution graph you can see the timing and the order in which threads are executed. Thick blue lines indicate the thread that is currently running, that is, the thread using the CPU. More information about different lines in the graph can be accessed by right-clicking in the Execution Graph window and selecting Legend. If you display the Execution Graph Details in a Message Log window, you can double-click on a box (a segment of a line) in the Execution Graph to see details about that event in text form. You can also hide threads in the graph by right-clicking in the Execution Graph window and selecting Property Page.
- **CPU Load Graph.** Displays a graph of the target CPU processing load. The most recent CPU load is shown in the lower-left corner and the highest CPU load reached so far is shown in the lower-right corner. The CPU load is defined as the amount of time not spent performing the low-priority task that runs when no other thread needs to run. Thus, the CPU load includes any time required to transfer data from the target to the host and to perform additional background tasks. The CPU load is averaged over the polling rate period. The longer the polling period, the more likely it is that short spikes in the CPU load are not shown in the graph. To set the polling rate, open the RTA Control Panel window and right-click in the window. Select Property Page, and in the Host Refresh Rates tab, set the polling rate with the Statistics View / CPU Load Graph slider and click OK.
- **Kernel/Object View.** Displays the configuration, state, and status of the DSP/BIOS objects currently running on the target. This tool shows both the dynamic and statically configured objects that exist on the target. You can right-click in the window and select Save Server Data to save the current data.

---

**Note:** When used in tandem with the Code Composer Studio IDE standard debugger during software development, the DSP/BIOS real-time analysis tools provide critical visibility into target program behavior during program execution when the debugger can offer little insight. Even after the debugger halts the program and assumes control of the target, information already captured through DSP/BIOS can provide invaluable insights into the sequence of events that led up to the current point of execution.

---

The DSP/BIOS real-time analysis tools also can act as the software counterpart of the hardware logic analyzer. The embedded DSP/BIOS kernel and host analysis tools combine to form a new set of manufacturing test and field diagnostic tools. These tools are capable of interacting with application programs in operative production systems through the existing JTAG infrastructure.

The overhead cost of using DSP/BIOS is minimal, therefore instrumentation can be left in to enable field diagnostics, so that developers can capture and analyze the actual data that causes failures.

### **6.1.5 Code Coverage and Multi-Event Profiler Tool**

The Code Coverage and Multi-event Profiler tool provides two distinct capabilities:

- Code coverage provides visualization of source line coverage to help developers to construct tests to ensure adequate code coverage.
- Multi-event profiling provides function profile data collected over multiple events of interest – all in a single simulation run of the application. Events include CPU cycles, instructions executed, pipeline stalls, cache hits, misses and so on. This tool helps identify possible factors affecting performance.

See the *Code Coverage and Multi-event Profiler User's Guide* ([SPRU624](#)) for further details.

## **6.2 Application Code Tuning (ACT)**

The tuning process begins where the analysis stage ends. When application code analysis is complete, the DSP developer should have identified inefficient code. The tuning process consists of determining whether inefficient code can be improved, setting efficiency objectives, and attempting to meet those goals by modifying code. Code Composer Studio links several tools together into an organized method of tuning, as well as providing a single point for analyzing tuning progress.

### **6.2.1 Tuning Dashboard**

The Dashboard is a central focal point for the tuning process. It displays build- and run-time profile data suggestions for which tuning tool to use, and it can launch each of the tools. The Dashboard is the main interface during the tuning phase of the development cycle.

#### **6.2.1.1 Advice Window**

The Advice window is a component of the Dashboard that displays tuning information. It guides you through the tuning process, explaining and detailing the appropriate steps, and displaying helpful information, links to other tools and documentation, and important messages. The Advice window should be consulted when first using a tool, or to determine the appropriate action to take at any point in the tuning procedure.

Code Composer Studio IDE initially starts in the Debug layout. To open the Advice window, switch to the Tuning layout by clicking the tuning fork icon on the toolbar. Alternatively, you can choose Advice from the Profile→Tuning menu item. The Advice window will open at the left of the Code Composer Studio IDE screen and display the Welcome information.

At the top of the Advice Window there is a toolbar with buttons for Internet-style navigation of advice pages as well as buttons for opening the main advice pages. Click on the arrows in the toolbar to navigate back and forth through the history of advice pages for that tab. There are one or more tabs below the center pane. These tabs display different advice pages, allowing you to carry out more than one task at once. Click on the tabs at the bottom of the Advice Window to switch between open pages. To close the active tab, right-click on the Advice Window and choose Close Active Tab from the context menu.

The Welcome advice page contains links to descriptions of each of the major tuning tools. At the bottom of the Welcome advice page, there is a blue box containing suggestions for the next step in the tuning process. These blue Action boxes are found throughout the Advice Window pages. When navigating through the Advice Window pages, red warning messages may appear. These messages serve as helpful reminders and contain valuable solutions for various problems.

When you have launched a tool, such as CacheTune, an advice tab for that tool appears at the bottom of the Advice window. The page contains information about the tool, including its function, use, and how to apply the tool for optimum tuning efficiency.

### 6.2.1.2 Profile Setup

As the Advice Window indicates, Code Composer Studio IDE must identify the desired code elements for tuning before beginning the process. This can be accomplished using Profile Setup. The Profile Setup window should be used at the beginning of the tuning process to specify the data to be collected and the requisite sections of code.

The Profile Setup window can be opened using the Advice Window. In the blue Action box at the bottom of the Welcome page, click the link to open the Setup Advice page. The first Action box will contain a link to open the Profile Setup window. Profile Setup can also be launched from the main menu topic Profile→Setup.

The Activities tab displays the activity for which the profiling session will collect data for your application. The Ranges tab specifies the program ranges for which data is collected. Functions, loops, and arbitrary segments of code can be added to the Ranges tab for collection of tuning information. Use the exit points in the Control tab to notify Code Composer Studio when to stop data collection. You can also use the Control tab to isolate different sections of code by adding Halt or Resume Collection points. The Custom tab collects custom data, such as cache hits or CPU idle cycles.

### 6.2.1.3 Goals Window

Tuning an application requires setting and reaching efficiency goals, so Code Composer Studio provides a method of recording numerical goals and tracking your progress.

The Goals Window displays a summary of application data, including values for the size of the code and number of cycles, that can be updated each time the code is run. It also compares the current data against both the last run's data and the defined goals.

To open the Goals Window, select Goals from the Profile→Tuning menu.

Figure 6-5. Goals Window



	Goal	Current	Previous	Delta
Code Size	3260	3296	3360	-64
Cycle Total	17365	(14920)	17465	-2545

If an application has been loaded and profiling has been set up, the Goals Window can be populated with data simply by running the application. To record objectives for tuning, click in the Goals column, type in the goal and press Enter. If a goal has been reached, the data will be displayed in green and in parentheses. Otherwise, the data will appear in red. When the application is restarted and run, the Current values in the Goals Window will move to the Previous column and the difference will be displayed in the Delta column. The Goals Window also allows you to save or view the contents in a log at any time, by using the logging icons at the left side of the window.

### 6.2.1.4 Profile Viewer

The Profile Viewer displays collected data during the tuning process. It consists of an information grid. Each row corresponds to the elements of code selected in the Ranges tab of the Profile Setup window. The columns store the collected data for each profiled section of code, as selected in the Activities and Custom tabs of the Profile Setup window.

The Profile Viewer provides a single location for the display of all collected information during the tuning process. Ranges can be sorted by different data values. Data sets displayed in the Profile Viewer can be saved, restored, and compared with other data sets.

The Profile Viewer pinpoints the most inefficient sections of code. For instance, to determine which function results in the most cache stalls, the cache stall data in the Profile Viewer can be sorted from largest to smallest. Sections of the function can then be profiled to determine exactly what code is generating cache stalls.



To open the Profile Viewer, select Profile→Viewer from the main menu. Alternatively, navigate to the Setup tab in the Advice Window. At the bottom of the Setup Advice page, click on the Profile Data Viewer link to display the Profile Viewer in the lower portion of the screen. If tuning has been set up using the Profile Setup window, running the application will display data in the Profile Viewer. The view can be customized by dragging and dropping rows and columns. The data can be saved and restored using the Profile Viewer buttons, and it can be sorted by double-clicking on the title of a column. In addition, several Profile Viewers can be opened simultaneously.

### 6.2.2 **Compiler Consultant**

The Compiler Consultant tool analyzes your C/C++ source code and provides you with specific advice on changes that will improve performance. The tool displays two types of information: Compile Time Loop Information and Run Time Loop Information. Compile Time Loop Information is created by the compiler. Run Time Loop Information is data gathered by profiling your application. Each time you compile or build your code, Consultant will analyze the code and create suggestions for different optimization techniques to improve code efficiency. You then have the option of implementing the advice and building the project again. You can then use the Profile Viewer window to view the results of the optimization. The project must be built with the - -consultant option enabled in the Build options. For more information, see Compiler Consultant in the online help under Application Code Tuning.

When you analyze Compiler Consultant information, sort information in the Profile Viewer by the different columns, as follows:

- If you didn't profile, sort on Estimated Cycles Per Iteration to see which loops take the most estimated cycles in a single iteration (Compile Time Loop Information).
- If you profiled with the activity Collect Run Time Loop Information, sort on cycle.CPU: Excl. Total to see which loops execute the most cycles, ignoring system effects.
- If you profiled with the activity Profile all Functions and Loops for Total Cycles, sort on cycle.Total: Excl. Total to see which loops execute the most cycles, including system effects.
- Sort on Advice Count to see which loops have the most advice.

This sorting will bring the rows to the top of the Profile Viewer that consume the most CPU cycles and which should gain the most performance benefit by tuning. You can then work on tuning one loop at a time. Double-clicking on the Advice Types entry for any loop row will bring up the full advice for that loop in the Consultant tab of the Advice window.

After you have applied the advice to fix individual loops, it is useful to hide that row in the Profile Viewer window. Hiding rows reduces the amount of information present in the Profile Viewer window. Rows can always be unhidden.

### 6.2.3 **Cache Tune**

The CacheTune tool provides a graphical visualization of cache accesses over time. This tool is highly effective at highlighting non-optimal cache usage (due to conflicting code placement, inefficient data access patterns, etc.). Using this tool, you can significantly optimize cache efficiency, thereby reducing the cycles consumed in the memory subsystem and improving the cache efficiency of the overall application.

All the memory accesses are color-coded by type. Various filters, panning, and zoom features facilitate quick drill-down to view specific areas. This visual/temporal view of cache accesses enables quick identification of problem areas, such as conflict, capacity, or compulsory misses.



The Tuning→CacheTune menu item launches the Cache Tune tool showing the latest cache traces. Various options must be chosen in the Profile Setup to view the cache traces, see the online help for more information. There are three kinds of cache trace files:

- Program Cache trace
- Data Cache trace
- Cross Cache trace

The data cache trace tab is displayed by default. If no cache traces have been collected, then the graph is empty.

Once the tool is launched, you can view other cache data files by opening a saved dataset.

Datasets can be opened by clicking the Open dataset button, pressing its hotkey, or clicking the Load dataset item in the context menu.

For more information, see Compiler Consultant in the online help under Application Code Tuning, or see the *Cache Analysis User's Guide* ([SPRU575](#)) on the TI website for further information on the Cache Analysis tool.

**Figure 6-6. Cache Tune Tool**

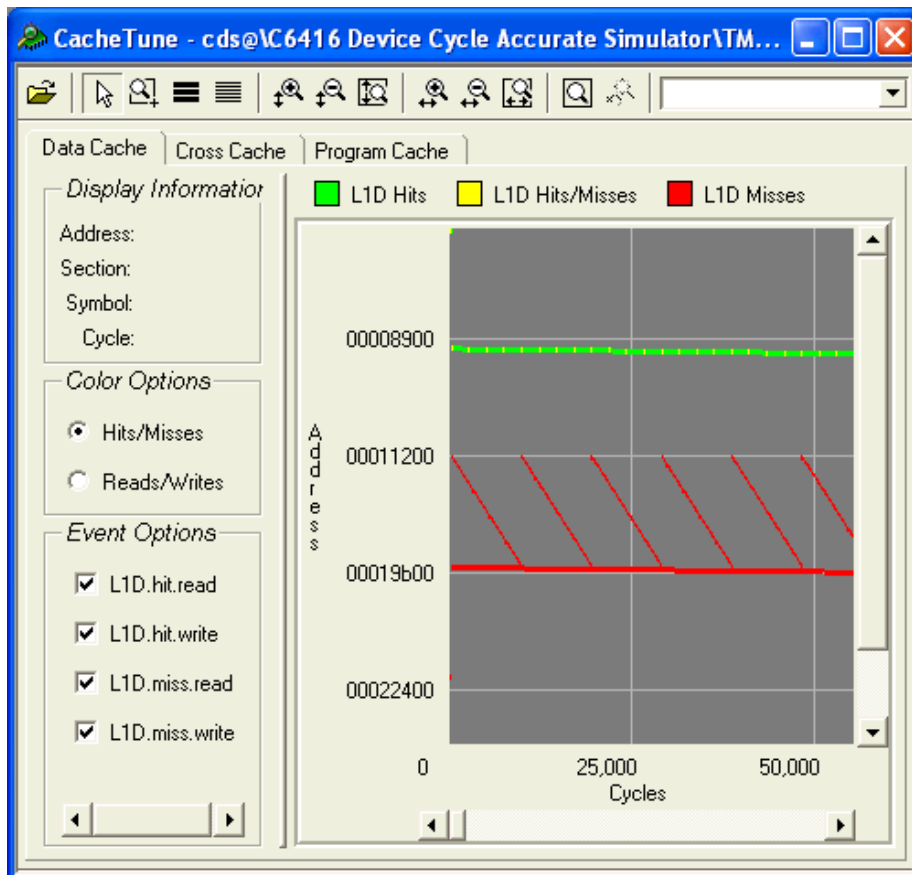



## ***Additional Tools, Help, and Tips***

---

---

---

This section identifies how to customize your IDE installation, how to update the installation, and how to find additional help and documentation.

<b>Topic</b>	<b>Page</b>
<b>7.1 Component Manager.....</b>	<b>100</b>
<b>7.2 Update Advisor .....</b>	<b>101</b>
<b>7.3 Additional Help .....</b>	<b>102</b>

## 7.1 Component Manager

**Note:** The Component Manager is an advanced tool used primarily to customize or modify your installation. Use this tool only to resolve component interaction in a custom or multiple installation environment.

Multiple installations of the Code Composer Studio IDE can share installed tools. The Component Manager provides an interface for handling multiple versions of tools with these multiple installations.

The Component Manager window displays a listing of all installations, build tools, Texas Instruments plug-in tools, and third-party plug-in tools. When a node is selected in the tree (the left pane of the Component Manager), its properties are displayed in the Properties pane to the right (see [Figure 7-1](#)).

With the Component Manager, you can enable or disable tools for a particular Code Composer Studio installation. This functionality allows you to create a custom combination of tools contained within the IDE. The Component Manager also allows you to access the Update Advisor to download the most recent version of the tools from the web.

**Figure 7-1. Component Manager**

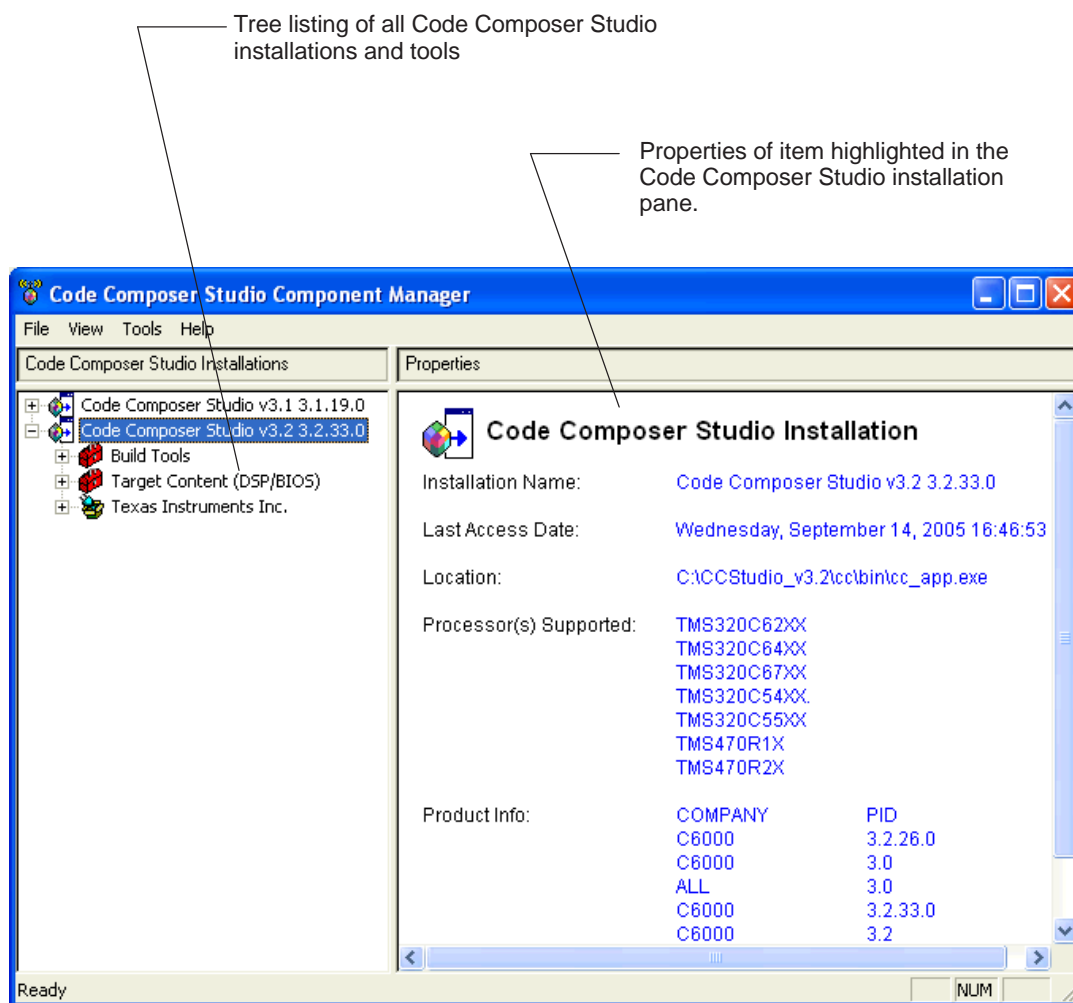

### 7.1.1 Opening Component Manager

To open the Component Manager:

1. From the Help menu in the Code Composer Studio IDE, select About. The About Code Composer Studio dialog box appears.
2. In the About dialog box, click the Component Manager button to display the window.

### 7.1.2 Multiple Versions of Code Composer Studio

The following is a list of requirements for maintaining multiple versions of the Code Composer Studio IDE and related tools:

- To keep more than one version of the Code Composer Studio IDE or a related tool, you must install each version in a different directory.
- If you install an additional version of the Code Composer Studio IDE, or an additional version of a tool in the same directory as its previous installation, the original installation will be overwritten.
- You cannot enable multiple versions of the same tool within one installation.

## 7.2 Update Advisor

The Update Advisor allows you to download updated versions of the Code Composer Studio IDE and related tools. The Update Advisor accesses the Available Updates web site. This site displays a list of patches, drivers, and tools available for downloading.

To use the Update Advisor, you must have Internet access and a browser installed on your machine. See Update Advisor under the online help for complete system requirements.

---

**Note:** You must be registered with my.TI before you can access the Available Updates web site.

---

### 7.2.1 Registering Update Advisor

If you did not register your product during installation, you can access the online registration form from the Code Composer Studio help menu: Help→Register.

---

**Note:** The first time you use Update Advisor, your browser may display the my.TI web page. To register, follow the directions displayed on the page.

---

You must register online and have a valid subscription plan to receive downloads through Update Advisor. You receive a 90 day free subscription service with the Code Composer Studio product. At the end of this period, you must purchase an annual subscription service. Annual subscriptions are only available for the full product.

### 7.2.2 Checking for Tool Updates

In the Code Composer Studio IDE, select Help→Update Advisor→Check for Updates. If you are already registered with my.TI and have accepted the cookie necessary for automatic log-in, your browser will go directly to the Available Updates web site. To query the Available Updates web site, the Update Advisor passes certain information from your machine:

- Code Composer Studio IDE product registration number
- Code Composer Studio IDE installation version
- Text description of the installed product
- List of installed plugins

The Available Updates web site will then list any updates appropriate for your installation. You have the opportunity to just download the updates, or to download and install them immediately.

You can also configure the Update Advisor to automatically check for updates.

### 7.2.3 Automatically Checking for Tool Updates

You may check for tool updates at any time, or you can configure the Update Advisor to automatically check for updates.

1. Select Help→Update Advisor→Settings. The Web Setting dialog box appears:

**Figure 7-2. Update Advisor Web Settings**

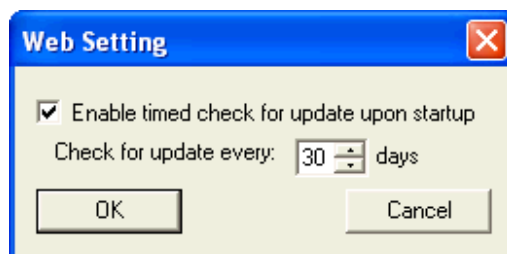

2. To enable the automatic update feature, click the checkbox to the left of the *Enable timed check for update upon startup* field. When this field is enabled, the Update Advisor automatically checks for web updates according to the specified schedule.
3. In the Check for Update field, specify how often the Update Advisor should check the Available Updates web site.
4. Click OK to save your changes and close the dialog box.

### 7.2.4 Uninstalling the Updates

Any installed update can be uninstalled to restore the previous version of the Code Composer Studio IDE.

Note that only the previous version of a tool can be restored. If you install one update for a tool, and then install a second update for the same tool, the first update can be restored. The original version of the tool cannot be restored, even if you uninstall both the second update and the first update.

## 7.3 Additional Help

You can access Help→Contents to guide you through certain topics step by step, perform the online tutorials, view online help sites that provide the most current help topics, or view user manuals in PDF format that provide information on specific features or processes. Additionally, you can access the Update Advisor to get the newest features through Help→Update Advisor.

### 7.3.1 Online Help

The online help provides links to the tutorials, multimedia demos, user manuals, application reports, and a website ([www.dspvillage.com](http://www.dspvillage.com)) where you can obtain information regarding the software. Simply click on Help and follow the links provided. For context-sensitive help, choose a relevant part of the IDE and click F1.

### 7.3.2 Online Tutorial

The Code Composer Studio IDE Tutorial contains lessons that help you get started quickly with the Code Composer Studio IDE. To start the Code Composer Studio IDE Tutorial, select Help→Tutorial.

## IMPORTANT NOTICE

Texas Instruments Incorporated and its subsidiaries (TI) reserve the right to make corrections, modifications, enhancements, improvements, and other changes to its products and services at any time and to discontinue any product or service without notice. Customers should obtain the latest relevant information before placing orders and should verify that such information is current and complete. All products are sold subject to TI's terms and conditions of sale supplied at the time of order acknowledgment.

TI warrants performance of its hardware products to the specifications applicable at the time of sale in accordance with TI's standard warranty. Testing and other quality control techniques are used to the extent TI deems necessary to support this warranty. Except where mandated by government requirements, testing of all parameters of each product is not necessarily performed.

TI assumes no liability for applications assistance or customer product design. Customers are responsible for their products and applications using TI components. To minimize the risks associated with customer products and applications, customers should provide adequate design and operating safeguards.

TI does not warrant or represent that any license, either express or implied, is granted under any TI patent right, copyright, mask work right, or other TI intellectual property right relating to any combination, machine, or process in which TI products or services are used. Information published by TI regarding third-party products or services does not constitute a license from TI to use such products or services or a warranty or endorsement thereof. Use of such information may require a license from a third party under the patents or other intellectual property of the third party, or a license from TI under the patents or other intellectual property of TI.

Reproduction of information in TI data books or data sheets is permissible only if reproduction is without alteration and is accompanied by all associated warranties, conditions, limitations, and notices. Reproduction of this information with alteration is an unfair and deceptive business practice. TI is not responsible or liable for such altered documentation.

Resale of TI products or services with statements different from or beyond the parameters stated by TI for that product or service voids all express and any implied warranties for the associated TI product or service and is an unfair and deceptive business practice. TI is not responsible or liable for any such statements.

Following are URLs where you can obtain information on other Texas Instruments products and application solutions:

<b>Products</b>		<b>Applications</b>	
Amplifiers	<a href="http://amplifier.ti.com">amplifier.ti.com</a>	Audio	<a href="http://www.ti.com/audio">www.ti.com/audio</a>
Data Converters	<a href="http://dataconverter.ti.com">dataconverter.ti.com</a>	Automotive	<a href="http://www.ti.com/automotive">www.ti.com/automotive</a>
DSP	<a href="http://dsp.ti.com">dsp.ti.com</a>	Broadband	<a href="http://www.ti.com/broadband">www.ti.com/broadband</a>
Interface	<a href="http://interface.ti.com">interface.ti.com</a>	Digital Control	<a href="http://www.ti.com/digitalcontrol">www.ti.com/digitalcontrol</a>
Logic	<a href="http://logic.ti.com">logic.ti.com</a>	Military	<a href="http://www.ti.com/military">www.ti.com/military</a>
Power Mgmt	<a href="http://power.ti.com">power.ti.com</a>	Optical Networking	<a href="http://www.ti.com/opticalnetwork">www.ti.com/opticalnetwork</a>
Microcontrollers	<a href="http://microcontroller.ti.com">microcontroller.ti.com</a>	Security	<a href="http://www.ti.com/security">www.ti.com/security</a>
Low Power Wireless	<a href="http://www.ti.com/lpw">www.ti.com/lpw</a>	Telephony	<a href="http://www.ti.com/telephony">www.ti.com/telephony</a>
		Video & Imaging	<a href="http://www.ti.com/video">www.ti.com/video</a>
		Wireless	<a href="http://www.ti.com/wireless">www.ti.com/wireless</a>

Mailing Address: Texas Instruments  
Post Office Box 655303 Dallas, Texas 75265