

DLP® Technology for Mobile Smart TV

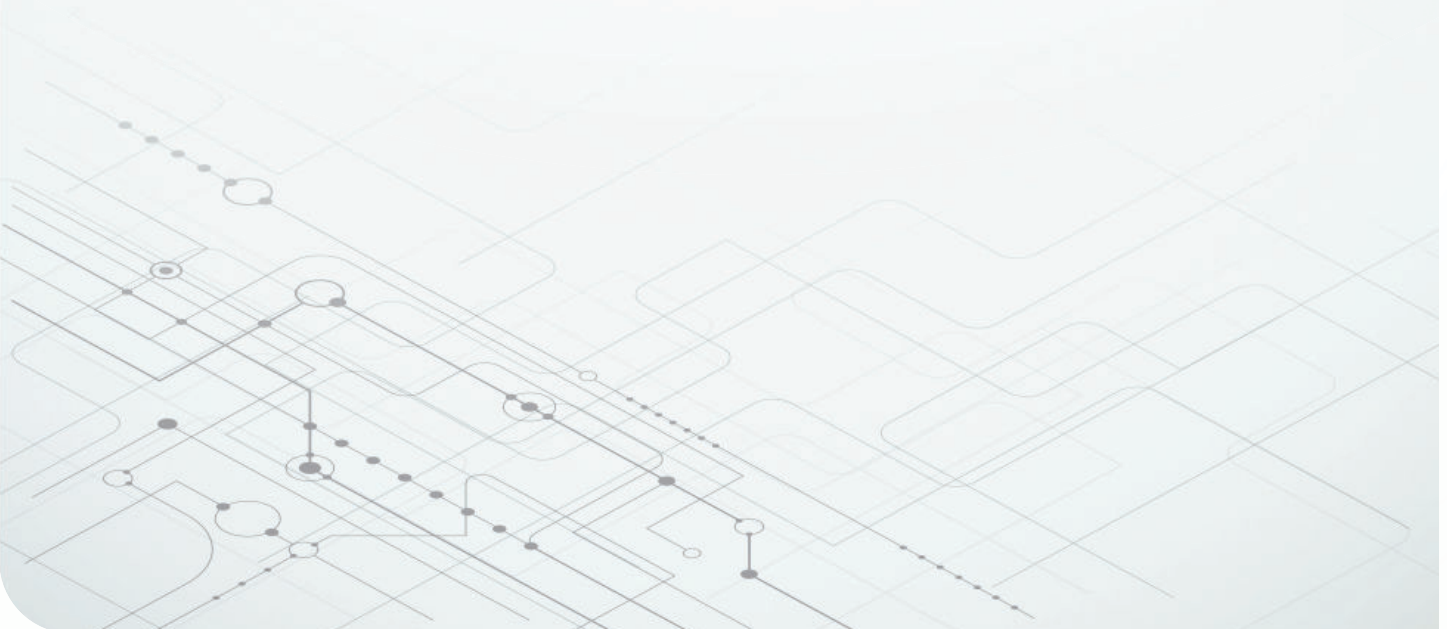

Bill Bommersbach
DLP® Products
Product Marketing Manager



Texas Instruments DLP Pico technology is a micro-electro-mechanical systems (MEMS) technology that modulates light using a digital micromirror device (DMD). A DMD consists of hundreds of thousands of highly reflective, digitally switchable, micrometer-sized mirrors (micromirrors) organized in a two-dimensional array.

At a glance

1 What is Mobile Smart TV?
Mobile smart TVs are projection-based display devices that can display on virtually any surface. This technology is enabled by the combination of 3 technologies: wireless connectivity, a mobile operating platform, and DLP technology.

2 Mobile Smart TV Advantages Over Traditional Displays
Unlike traditional displays, mobile smart TVs have substantial advantages including a screenless application, portability, scalability, quick set up, improved aesthetic, small size, and smart capability.

3 Why Choose DLP Technology for Mobile Smart TV?
Choosing DLP technology for mobile smart TV enables high optical efficiency, a wide choice of display resolution chipsets, high contrast, high speed, and advanced image processing algorithms.

Each micromirror on a DMD represents a pixel on the screen (see [Figure 1](#)) and is independently modulated, in sync with color sequential illumination, to create stunning displays. DLP Pico technology powers the displays of

products worldwide, from media projectors to projectors inside of tablets and smartphones.

TI's DLP Pico chipsets are a great fit for any display system that requires high resolution and high brightness at low power in a compact size.

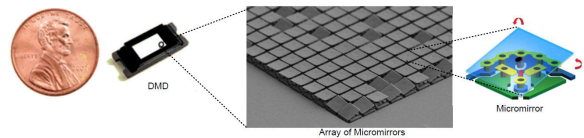

Figure 1. Digital micromirror device (DMD).

What is Mobile Smart TV?

Mobile Smart TV is a projection-based display device that allows users to display any content on virtually any surface from a small, portable product. For example, the display surface can be a wall or table in an office or a home, a countertop in a kitchen, the ceiling in a bedroom, the side of a camping tent, or even a garage door.

Mobile Smart TV is enabled by innovations across three technology areas: wireless connectivity, the Android platform or any mobile operating system, and DLP technology. By combining these three technologies, Mobile Smart TV can provide an HD video experience with any content, anywhere from a compact, wireless device.

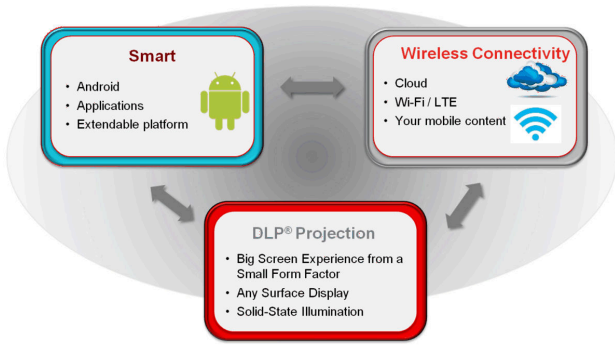

Figure 2. Mobile Smart TV as Combination of Three Technologies

Mobile Smart TV can be used in a wide variety of ways. Some possible use cases are:

- **On the go display:** For consumers who travel frequently or live in small homes, Mobile Smart TV with embedded wireless and video streaming applications can create a large display when needed yet also remain extremely portable.

- **Anywhere display:** For consumers who would rather not have a TV mounted on a bedroom wall, a Mobile Smart TV can be an inconspicuous wireless device that blends in to the décor while creating a large, HD display on a wall or a ceiling as required.
- **Laser TV:** For consumers who want a big screen TV experience in their own home, Laser TVs based on DLP technology can provide a compact and portable solution. Through a simple installation process, Laser TV's can be placed approximately 2ft away from a screen or wall and display a stunning 100+ inch image. Laser TV's can be optionally paired with an ambient light rejection screen to produce an even more cinematic experience.



Figure 3. Mobile Smart TV examples.

Mobile Smart TV Advantages Over Traditional Displays

Mobile Smart TV has several key advantages over traditional displays:

- **Screenless** – No fixed screen or display panel required, allowing content to be displayed on virtually any surface.
- **Portable** – No fixed installation required, enabling Mobile Smart TV product to be easily moved or taken on the go. In contrast, traditional big screen televisions are large and not easily moved or transported.
- **Scalable** – The display image size scales with distance from the display surface, enabling images ranging from as small as few inches in diagonal to as large as 100 inches or more in diagonal from the same portable device.
- **Quick Set Up** – No fixed installation or mounting on the wall or placement on a pedestal required – allowing Mobile Smart TV product to just power on and create stunning display.
- **Improved Aesthetics** – No fixed screen required, allowing display to be only visible when required and invisible when turned off. Once the display is off, the room aesthetics are kept in its natural state – without compromise – so there is no display panel to view “all of the time”.
- **Small Size** – No large display panel required, allowing Mobile Smart TV product to be small size – can be designed to fit in your pocket or carry in your hand.
- **Smart** – Built-in video streaming applications and Wi-Fi®, enabling Mobile Smart TV product to provide all functionalities of a smart display.

Why Choose DLP Technology for Mobile Smart TV?

DLP technology offers several key advantages that make it a great fit for Mobile Smart TV:

- **High optical efficiency:** DLP technology can work with any light source including LEDs, lasers, laser-phosphor or lamp and offers very high optical efficiency. The result is a high brightness display with low power consumption, which is a particularly good fit for high brightness display applications such as Mobile Smart TV. Low power consumption also enables battery operation for a cable-less experience.
- **Wide choice of display resolution chipsets:** DLP technology offers a wide range of display chipsets ranging from small resolution – nHD (640 × 360), WVGA (854 × 480) to HD resolution – WXGA (1280 × 800), HD (1280 × 720) and Full HD (1920 × 1080) to 4K-resolutions. This provides the system designer with flexibility in designing and differentiating products across brightness, size, resolution, battery requirements and cost levels.
- **High contrast:** Depending on the optical design, DLP technology can enable a high contrast ratio, which creates deep blacks and improves perceived brightness and image quality.
- **High speed:** Each DMD micromirror can flip thousands of times per second, enabling fast color refresh rates and high frame rates (120 Hz or higher in select cases). In addition, low display latency makes DLP technology a great fit for gaming.
- **Advanced image processing algorithms:** DLP® IntelliBright™ suite of algorithms perform two key functions:
 - Content Adaptive Illumination Control: The ability to dynamically adjust each RGB LED to optimize power based on frame by frame content.
 - Local Area Brightness Boost: The ability to intelligently boost darker regions of images depending on ambient lighting conditions. For more information on these algorithms, see the [TI DLP IntelliBright](#) application note.

DLP Brilliant Color™ software can improve the following two areas:

- Color Gamut: Maximizes the displayed color gamut through clever use of multi-primary color wheels, or the spokes in a RGB color wheel.
- Illumination Efficiency: Wisely makes use of additional color filters to improve Introducing BrilliantColor™ technology.

DLP technology is a proven display technology. Tens of millions of DLP chips have been sold and DLP Cinema® is the technology of choice for more than nine of ten digital cinema screens worldwide. DLP chipsets for Mobile Smart TV take the same core technology and transform it into a tiny chip that creates stunning displays from compact, portable devices.

System and Electronics Considerations for Mobile Smart TV Using DLP Technology

A typical Mobile Smart TV system is comprised of two subsystems (see Figure 4):

- Front end subsystem
- DLP projection subsystem

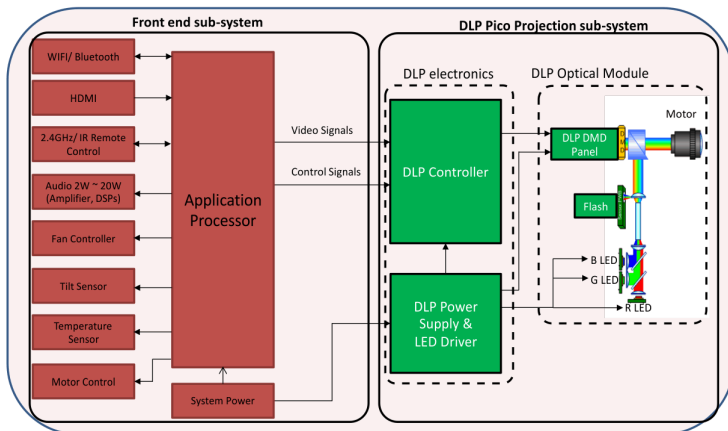

Figure 4. Mobile Smart TV system diagram.

Front end subsystem – Consists of an application processor that provides functionality such as:

- Wi-Fi® and Bluetooth®
- HDMI
- IR remote control

- Audio control
- Fan control
- Tilt sensor for automatic keystone correction
- Motor control for autofocus

DLP Projection subsystem: The DLP Projection subsystem consists of two additional subsystems: the DLP optical module and DLP electronics.

- **DLP Optical Module:** The DLP DMD, along with its associated illumination sources, optical elements, and necessary mechanical components are combined into a compact and rugged assembly known as an optical module or light engine (see Figure 5).

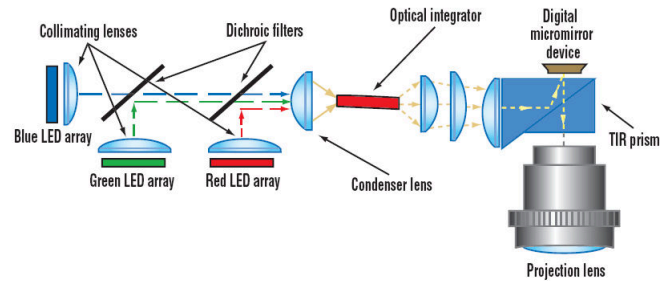

Figure 5. Simplified optical module diagram.

The optical module is the core display component of the system. Optical modules can be of various sizes depending on the application and requirements. In general, the higher the brightness, the larger the size of the optical module due to larger LEDs, optics, DMD and thermal management in the form of heat sinks and fans.

To enable faster time to market many DLP optical modules of various designs, sizes, capabilities, and performance are readily available from a number of Original Design Manufacturers (ODMs) who are part of the DLP eco-system. For more information on the ecosystem and ODM contacts, please visit the [DLP Solutions and Services](#) page.

If none of the readily available optical modules fit the requirements, there are several DLP [design houses](#) that have the expertise to support custom optical designs.

DLP Electronics

- A typical DLP electronics system block diagram for a Mobile Smart TV application is shown in **Figure 6**. The key components are the DLP controller, DLP chipset power management IC, and the LED drive circuit.
 - The DLP controller communicates with a front end processor via I²C and receives 24-bit RGB video data via parallel interface.
 - Power up/power down of the DLP system is controlled by the front end processor using the PROJ_ON signal.
 - The Power Management IC (PMIC)/LED driver provides all the necessary power supplies for the DLP controller and the DMD while the LED driver controls the RGB LED current.

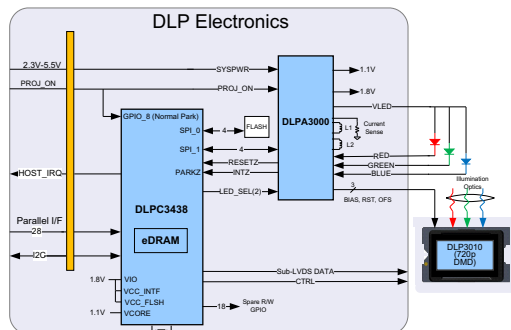

Figure 6. DLP electronics system block diagram using DLP3010, DLPC3438, and DLPA3000.

DLP Chipset Portfolio for Mobile Smart TV

The following DLP chipsets are well suited for Mobile Smart TV applications.





Smallest, Lowest Power to Compact, High Brightness					
DMD part number	DLP230xx 	DLP3010 	DLP3310 	DLP47xx 	DLP650xx 
DMD Specifications					
Micromirror array diagonal size	0.23"	0.30"	0.33"	0.47"	0.65"
Display resolution	qHD (GP) 720p (KP) 1080p (NP) 1080p (NPSE)	720p	1080p	1080p (10) 1080p (2NE) 4K UHD (2TP) 4K UHD (2TE)	WXGA (LE) 1080p (NE) 4K (TE)
XPR FPGA required	Yes except GP	No	Yes	No	No
Typical Optical Module Specifications (from third-party optical module manufacturers)					
Typical brightness (lm)	Up to 600	Up to 300	Up to 1000	Up to 2000	Up to 8000
Typical image diagonal size	Up to 80"	Up to 60"	Up to 100"	Up to 120"	Up to 180"
Display Controller and PMIC Specifications					
Frame refresh rate	Up to 120Hz	Up to 120Hz	Up to 60Hz	Up to 60 Hz	Up to 120 Hz
DLP Algorithms	IntelliBright™	IntelliBright™	IntelliBright™	IntelliBright™	BrightColor™

Table 1. DLP chipset portfolio for Mobile Smart TV.

Brightness is an important consideration when selecting a DLP chipset. **Figure 7** can help determine the required brightness and matching chipsets based on screen size and ambient light conditions.

Image Diagonal	Suggested Brightness of Display (in lumens)			
	Dark (50 nits*)	Dim (100 nits)	Lit Room (200 nits)	Bright Room (350 nits)
100-120"	450-650	900-1300	1750-2500	3000-4500
80-100"	300-450	550-900	1100-1750	1950-3000
60-80"	150-300	350-550	650-1100	1100-1950
50-60"	110-150	250-350	450-650	800-1100
40-50"	80-120	150-250	300-500	500-800
30-40"	40-80	80-150	150-300	300-500
20-30"	20-40	40-80	80-150	130-300
10-20"	5-20	10-40	20-80	30-130
5-10"	<10	<10	<20	<30

Lighting Environment	
Lighting Environment	Brightness of Display
Dark (50 nits*)	
Dim (100 nits)	
Lit Room (200 nits)	
Bright Room (350 nits)	

DLP Chip Size Required	
>0.5" Class (DLP ECD TV Solution)	
0.45" Class DLP4710	
0.3" Class DLP3010	
0.2" Class DLP2010	

*1 nit = 1 cd/m²

Figure 7. Brightness table.

Note

DLP Enterprise chipsets are available for > 0.5 inch diagonal. Contact TI for more details.

Get Started with Mobile Smart TV Product Development

- Learn more about DLP Picotechnology:
 - Read the *Getting Started with DLP Technology* white paper, [DLPA059](#)
 - Browse [products and data sheets](#)
- Evaluate DLP technology with an easy to use evaluation module (EVM):
 - [DLP2010 EVM](#)
 - [DLP3010 EVM](#)
 - [DLP4500 EVM](#)
 - [DLP4710 EVM](#)
 - [DLP230NP EVM](#)

- Download a TI Design reference design to speed product development, including a schematic, layout files, BOM and test report.
 - [DLP2010](#): Ultra Mobile, Ultra Low Power Display Reference Design using DLP Technology
 - [DLP3010](#): Portable, Low Power HD Projection Display using DLP Technology
 - [DLP4710](#): Portable, Low Power Full HD Projection Display using DLP Technology
 - [DLP230NP](#): Portable, Smallest 1080p Projection Display using DLP Technology

- Find optical modules and design support:
 - Contact ODMs for production-ready optical modules www.ti.com/lsds/ti/dlp/video-and-data-display/solutions-services.page
 - Contact Design Houses for custom solutions www.ti.com/lsds/ti/dlp/video-and-data-display/solutions-services.page
- Contact your local TI salesperson or TI distributor representative: www.ti.com/general/docs/contact.tsp
- Check out TI's E2E community to search for solutions, get help, share knowledge and solve problems with fellow engineers and TI experts: e2e.ti.com/support/dlp_micro-electro-mechanical_systems/default.aspx
- For information about chipsets which incorporate DMD's larger than 0.5", contact the following ODMs:
 - **Coretronic Corporation**
Coretronic successfully provides all of the key factors ranging from technology solutions to turn-key solutions.
No. 2, Ke Bei 5th Rd., Science Park,
Chu-Nan 35053, Miao-Li County, Taiwan, R.O.C
Contact: House Chen -
house.chen@coretronic.com
 - **Ricoh Company, Ltd.**
Ricoh can provide complete projection light engine modules, including the optical light engine plus advanced electronic block.
3-2-3, Shin-Yokohama, Kohoku-ku Yokohama-shi,
Kanagawa, 222-8530, Japan
Contact: Takafumi Sakamoto -
takafumi.sakamoto@nts.ricoh.co.jp
Contact: Kikuzo Koitabashi -
kikuzoh.koitabashi@nts.ricoh.co.jp
- **Qisda**
Qisda can provide engine modules or entire projection systems.
157 Shan-ying Road,
Gueishan Taoyuan 333, Taiwan, R.O.C.
03-3598800 #2538
Contact: Jim Wang Jim.Wang@qisda.com
- **Delta**
Delta can provide part-of or the entire projection system.
186 Ruey Kuang Road,
Neihu , Taipei, Taiwan
Contact: Josephine Lee
Josephine.lee@delta.com.tw

Important Notice: The products and services of Texas Instruments Incorporated and its subsidiaries described herein are sold subject to TI's standard terms and conditions of sale. Customers are advised to obtain the most current and complete information about TI products and services before placing orders. TI assumes no liability for applications assistance, customer's applications or product designs, software performance, or infringement of patents. The publication of information regarding any other company's products or services does not constitute TI's approval, warranty or endorsement thereof.

IntelliBright™ is a trademark of Texas Instruments.
 Wi-Fi® is a registered trademark of Wi-Fi Alliance.
 DLP® and DLP Cinema® are registered trademarks of Texas Instruments.
 Bluetooth® is a registered trademark of Bluetooth SIG, Inc.
 All trademarks are the property of their respective owners.

IMPORTANT NOTICE AND DISCLAIMER

TI PROVIDES TECHNICAL AND RELIABILITY DATA (INCLUDING DATA SHEETS), DESIGN RESOURCES (INCLUDING REFERENCE DESIGNS), APPLICATION OR OTHER DESIGN ADVICE, WEB TOOLS, SAFETY INFORMATION, AND OTHER RESOURCES "AS IS" AND WITH ALL FAULTS, AND DISCLAIMS ALL WARRANTIES, EXPRESS AND IMPLIED, INCLUDING WITHOUT LIMITATION ANY IMPLIED WARRANTIES OF MERCHANTABILITY, FITNESS FOR A PARTICULAR PURPOSE OR NON-INFRINGEMENT OF THIRD PARTY INTELLECTUAL PROPERTY RIGHTS.

These resources are intended for skilled developers designing with TI products. You are solely responsible for (1) selecting the appropriate TI products for your application, (2) designing, validating and testing your application, and (3) ensuring your application meets applicable standards, and any other safety, security, regulatory or other requirements.

These resources are subject to change without notice. TI grants you permission to use these resources only for development of an application that uses the TI products described in the resource. Other reproduction and display of these resources is prohibited. No license is granted to any other TI intellectual property right or to any third party intellectual property right. TI disclaims responsibility for, and you will fully indemnify TI and its representatives against, any claims, damages, costs, losses, and liabilities arising out of your use of these resources.

TI's products are provided subject to [TI's Terms of Sale](#) or other applicable terms available either on [ti.com](https://www.ti.com) or provided in conjunction with such TI products. TI's provision of these resources does not expand or otherwise alter TI's applicable warranties or warranty disclaimers for TI products.

TI objects to and rejects any additional or different terms you may have proposed.

Mailing Address: Texas Instruments, Post Office Box 655303, Dallas, Texas 75265
Copyright © 2024, Texas Instruments Incorporated