

TPA2026D2EVM

Contents

1	Introduction	1
2	Operation	2
3	TPA2026D2EVM Schematic	6
4	TPA2026D2EVM PCB Layers	7
5	TPA2026D2EVM Parts List	9

List of Figures

1	Place Shunts Horizontally Across SCL and SDA.....	2
2	Found New Hardware Wizard Advisory Screen.....	3
3	Starting the Software	4
4	Software Interface.....	5
5	Connect I ² C Controls to JP3.....	6
6	TPA2026D2EVM Schematic.....	6
7	TPA2026D2EVM – Top Layer.....	7
8	TPA2026D2EVM – Layer 2	7
9	TPA2026D2EVM – Layer 3.....	8
10	TPA2026D2EVM – Bottom Layer.....	8

List of Tables

1	TPA2026D2EVM Parts List.....	9
---	------------------------------	---

1 Introduction

1.1 Description

The TPA2026D2 is a stereo, filter-free Class-D audio power amplifier with automatic gain control (AGC), dynamic range compression (DRC) and I²C™ digital volume control. The AGC and DRC functions enhance the perceived audio loudness, and at the same time prevent speaker damage from overdrive. The TPA2026D2 has independent software shutdown control for each channel and a 30-step volume control. Availability in the WCSP package makes TPA2026D2 an ideal choice for both cellular handsets and PDAs.

The TPA2026D2 evaluation module (EVM) is a complete, stand-alone audio board. It contains the TPA2026D2 WCSP (YZH) Class-D audio power amplifier.

All components and the EVM are Pb free.

1.2 TPA2026D2EVM Specifications

V_{DD}	Supply voltage range	-0.3 V to 6 V
I_{DD}	Supply current	2 A Maximum
P_o	Continuous output power per channel, 8 Ω , $V_{DD} = 5$ V, THD + N = 10%	1.7 W
V_i	Audio Input Voltage	0.5 V to $V_{DD} - 0.5$ V
R_L	Minimum load impedance	8 Ω

2 Operation

The TPA2026D2EVM can be evaluated in a stand-alone mode or when connected to existing circuits with I²C controls.

2.1 Quick Start List for Stand-Alone Operation

A desktop or laptop computer with Windows™ XP installed is required in the stand-alone operation. Install the software before connecting the EVM to a computer with a USB cable. The inputs accept standard RCA plugs and the outputs accept banana connectors.

2.1.1 Software Installation Sequence

1. Insert the CD provided.
2. Unzip the files to a temporary folder.
3. Install TPA2026D2 software by executing setup.exe located in *TPA2026D2 Interface\Volume*.

Accept license agreement and defaults, and complete the installation. Note: you can uninstall later with Add/Remove Programs.

NOTE: It is unnecessary to repeat the steps in [Section 2.1.1](#), once the software is installed.

2.1.2 Evaluation Module Preparations

1. Ensure that all external power sources are set to OFF.
2. Install shunt in jumper JP4;
3. Install shunts in jumpers JP5 and JP6 when single-ended audio inputs are used; this ties INL– and INR– to ground.
4. Install shunts in JP2 and JP3 as shown in [Figure 1](#). This sets the TPA2026D2 to accept I²C inputs from the EVM itself.

Figure 1. Place Shunts Horizontally Across SCL and SDA

5. Powering the EVM:
 - The EVM can be powered via USB connection or by external power supply:
 - (a) Via USB power: Install shunt for JP1 if USB power is used.
 - (b) External power supply: connect an external regulated power supply adjusted for 2.5 V–5.5 V to the module VDD (**J8**) and GND (**J7**) banana jacks, taking care to observe marked polarity. Make sure JP1 is removed in this case.
 Note:
 - (i) USB interface may not be able to provide enough current. For best audio performance, use external power supply.
 - (ii) Make sure only one power source is used. Connecting two power sources will cause damage to the device and the supply.
6. Connect audio source to RCA jacks J4 and J3.
7. Connect speakers (8 Ω to 32 Ω) to the output banana jacks ROUT and LOU (J6, J9, J10 and J11).
8. Plug in USB.

9. Turn on the power supply.
10. If this is the first time a TPA2026D2EVM is plugged in after installing the software, follow the Windows dialog (Figure 2), questions, and selections:
 - (a) Select "Install from a list or specific location (Advanced)", then click next.
 - (b) Browse to the folder where the TPA2026D2 interface is installed then click ok.
 - (c) Windows will automatically install the driver.

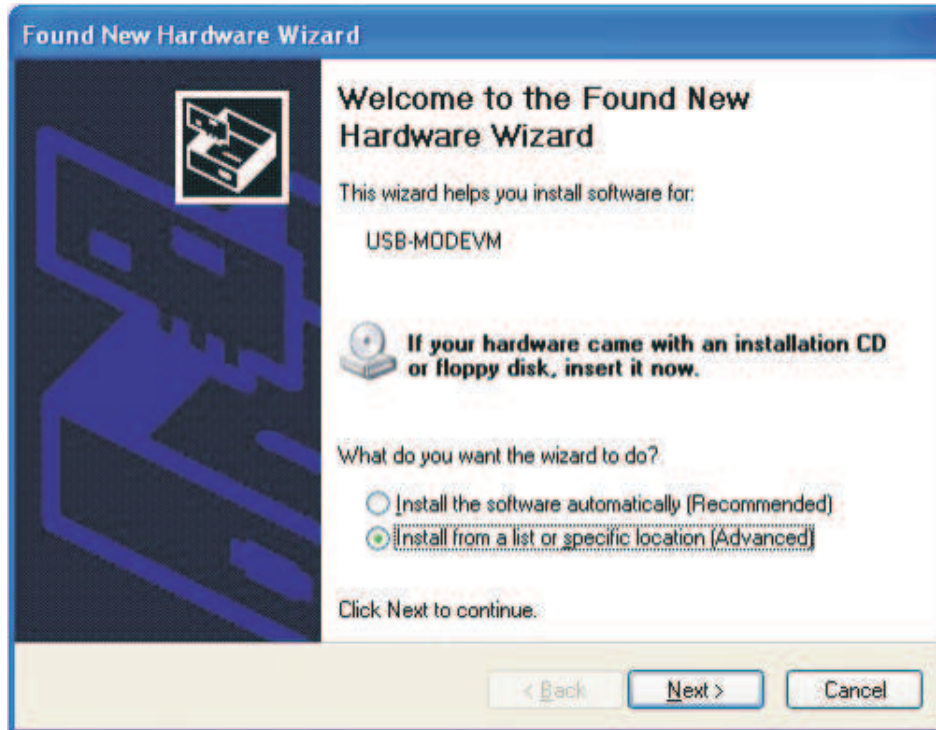

Figure 2. Found New Hardware Wizard Advisory Screen

NOTE: It is not necessary to repeat steps 10. a. to c., once the driver is installed.

2.1.3 Using the Software

1. Start the TPA2026D2 Interface by clicking the *Start* menu and clicking on the *TPA2026D2 Interface* icon. ⁽¹⁾

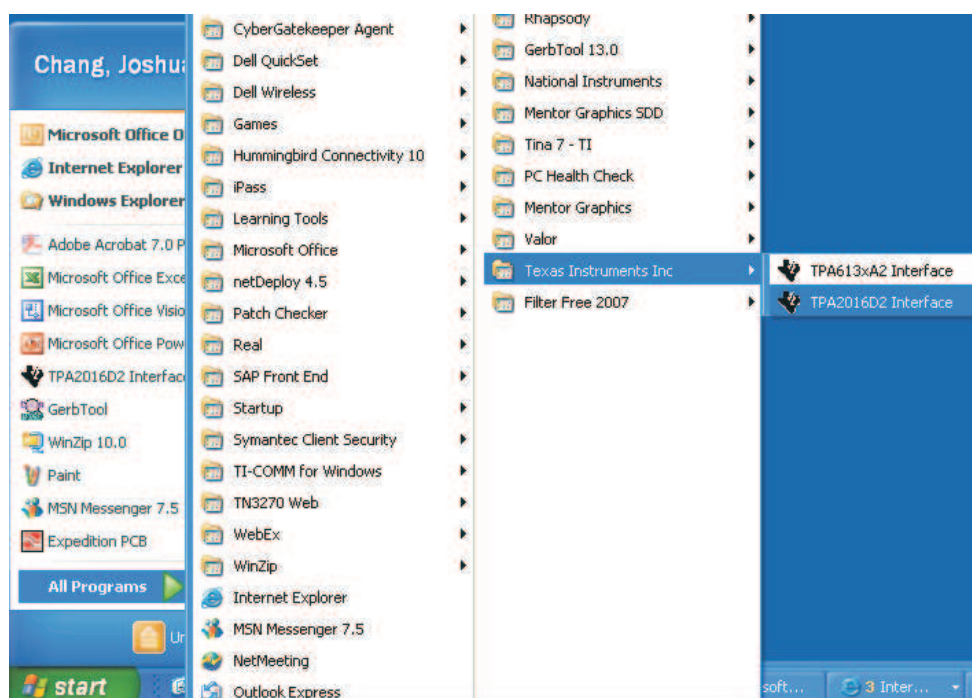

Figure 3. Starting the Software

⁽¹⁾ Computer screen images showing Windows XP interface are courtesy of Microsoft Corporation

- The TPA2026D2 software interface is as shown in [Figure 4](#).

Figure 4. Software Interface

NOTE: The TPA2026D2 powers up with the amplifier in software shutdown. To hear an output, uncheck shutdown.

- Uncheck and check *Left Enable* or *Right Enable* to place the corresponding channels in and out of SHUTDOWN.
- Click *Shutdown* to place the TPA2026D2 in and out of SOFTWARE SHUTDOWN.
- Adjust the *Attack Time*, *Release Time* and *Hold Time* by sliding the bar or clicking the tap in the GUI. You can also type a value in the box; in that case, the value will be rounded to the closest available setting.
- Adjust the *Fixed Gain*, *Minimum Gain* and *Limiter Level* by dragging the bar or clicking the tap in the GUI. You can also type a value in the box; in that case, the value will be rounded to the closest available setting.
- Adjust *Compression Ratio* and *Noise Gate Threshold* by clicking the value.
- The Limiter Power Level can be calculated by selecting the Load Resistance.
- I2C Status* box reports the status of I²C communications. An error or failure has occurred if it shows *I2C failure*.
- To read the I²C status, click Refresh.
- Thermal* box reports the status of thermal failure. A thermal fault has occurred if it turns red.
- The GUI has a built-in I²C programming interface. Follow the steps below to use the I²C programming function.
 - At the top left corner of the GUI, click *File* to access the I²C programming interface.
 - Save Script* can record the current register values. Select *Save Script* >> Click the folder icon to browse to the place where you want to save the script >> name the file in text format, then select OK to save.
 - Load Script* can load the previously saved script to program the entire register file. Select *Load Script* >> Click the folder icon to browse to the place where the script is located >> Select the file then click OK >> Click Load.
 - I2C interface* can program individual register value of TPA2026D2. Select I²C Interface >> I²C address is xB0, which is the address of TPA2026D2. Device address is from 1 to 7, which is the register address of TPA2026D2.

2.1.4 Shutdown Control

The TPA2026D2 EVM provides independent hardware shutdown controls for the Class-D power amplifier and the USB controller.

- Press and hold push button $\overline{\text{SDN}}$ to shutdown TPA2026D2. Release $\overline{\text{SDN}}$ to activate TPA2026D2.
- Press and hold push button $\overline{\text{RST}}$ to shutdown the USB controller. Release $\overline{\text{RST}}$ to activate the USB controller.

2.2 Quick Start List When Connected to Existing Circuits With I²C Controls

The TPA2026D2EVM can be easily connected to existing circuits with I²C controls. Connections to the EVM module can be made using banana plugs for the power supply. The inputs accept standard RCA plugs and the outputs accept banana connectors.

2.2.1 Evaluation Module Preparations

- Ensure that all external power sources are set to OFF.
- Install shunts in jumpers JP4.
- Remove shunts between JP2 and JP3 and connect I²C controls to JP3 as shown in [Figure 5](#).

Figure 5. Connect I²C Controls to JP3

4. Install shunts in jumpers JP5 and JP6 when single-ended audio inputs are used; this ties INL– and INR– to ground.
5. Remove JP1.
6. Connect an external regulated power supply adjusted for 2.5 V–5.5 V to the module VDD (J8) and GND (J7) banana jacks, taking care to observe marked polarity.
7. Connect audio source to J4 and J3.
8. Connect speakers (8 Ω to 32 Ω) to the output RCA jacks ROUT and LOUT (J5 and J2, respectively).
9. Turn on power supply.

3 TPA2026D2EVM Schematic

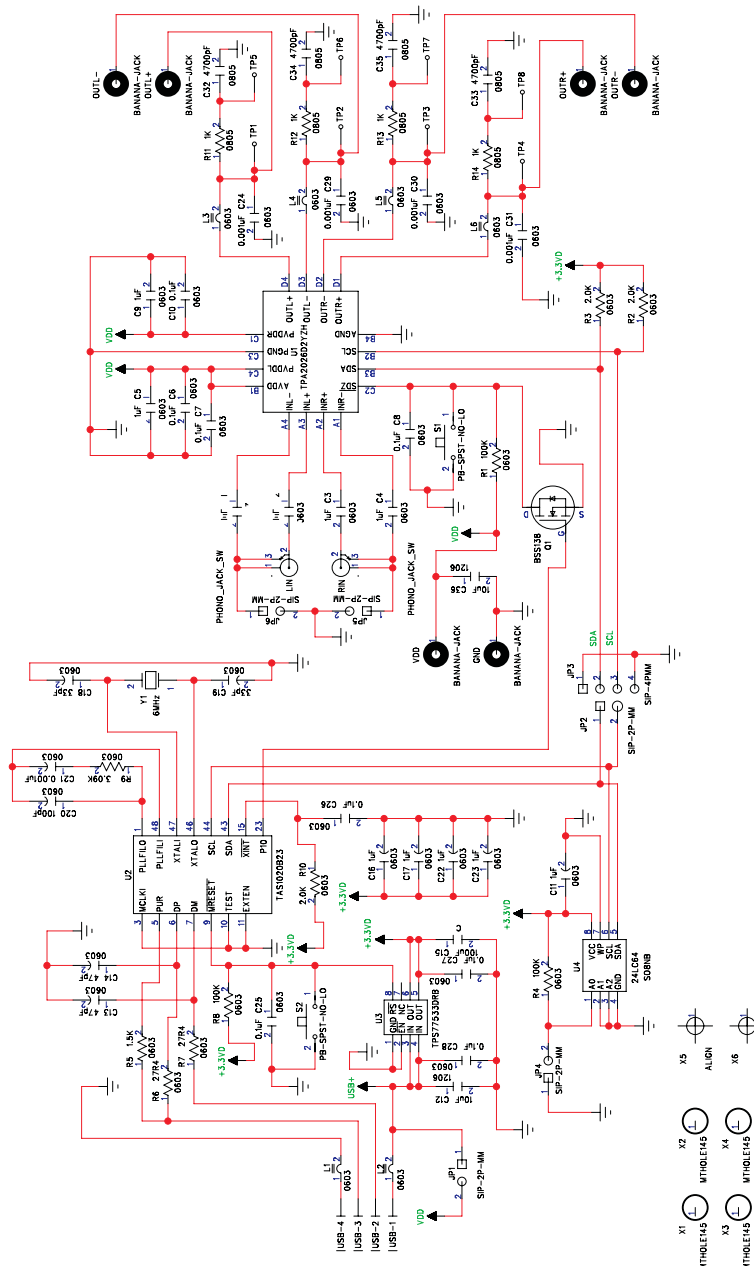

Figure 6. TPA2026D2EVM Schematic

4 TPA2026D2EVM PCB Layers

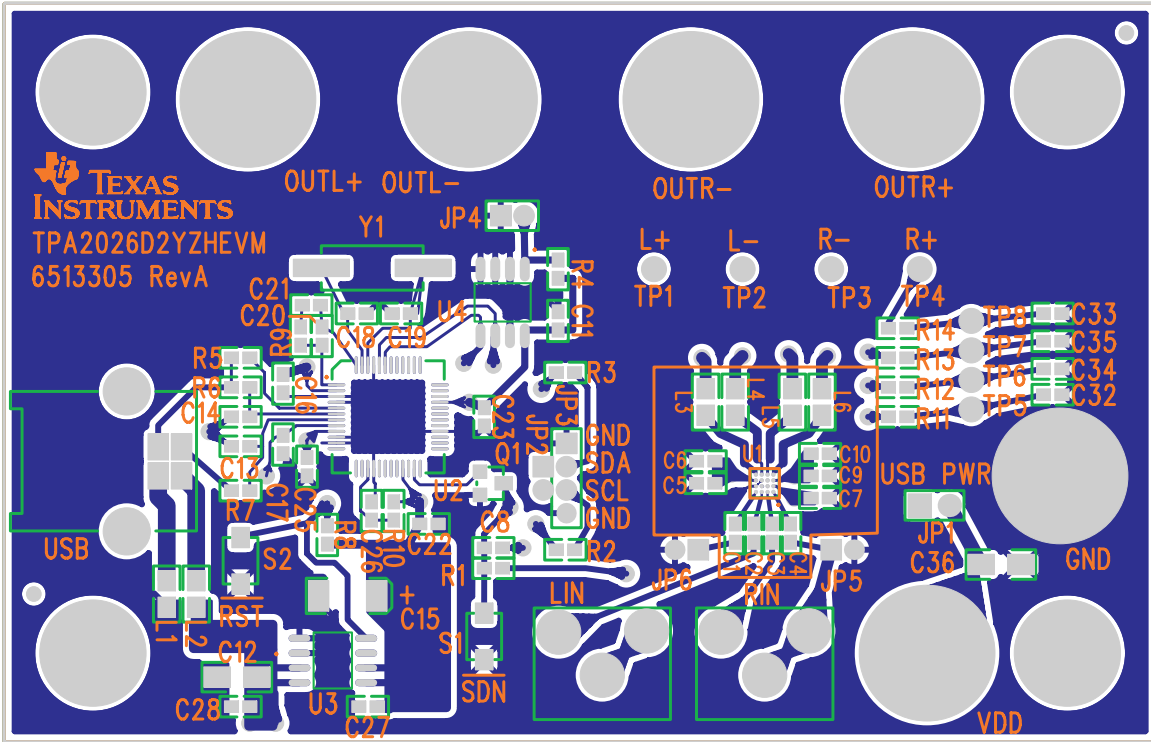

Figure 7. TPA2026D2EVM – Top Layer

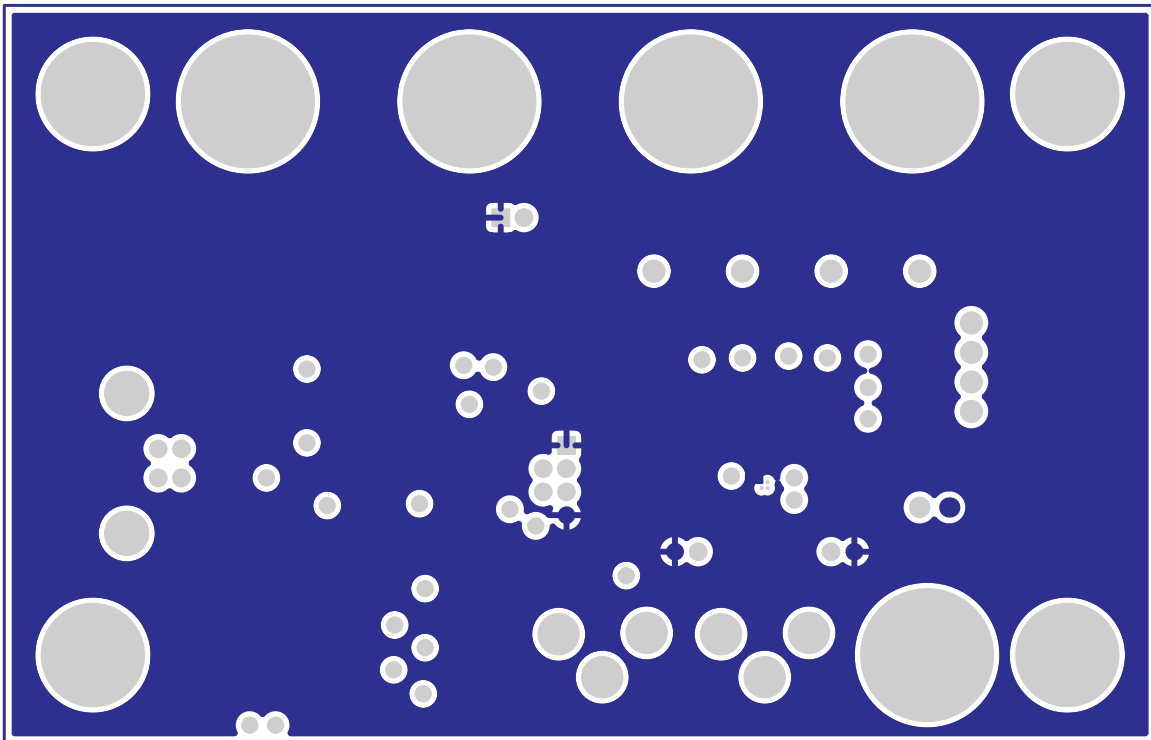

Figure 8. TPA2026D2EVM – Layer 2

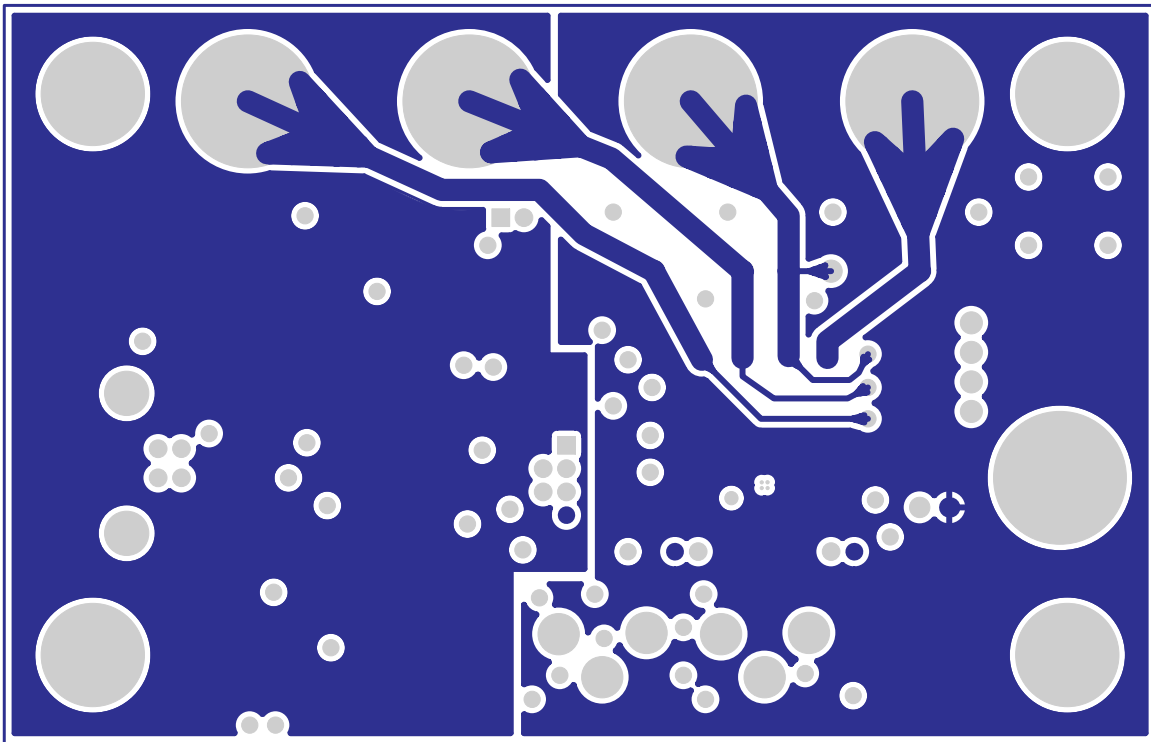

Figure 9. TPA2026D2EVM – Layer 3

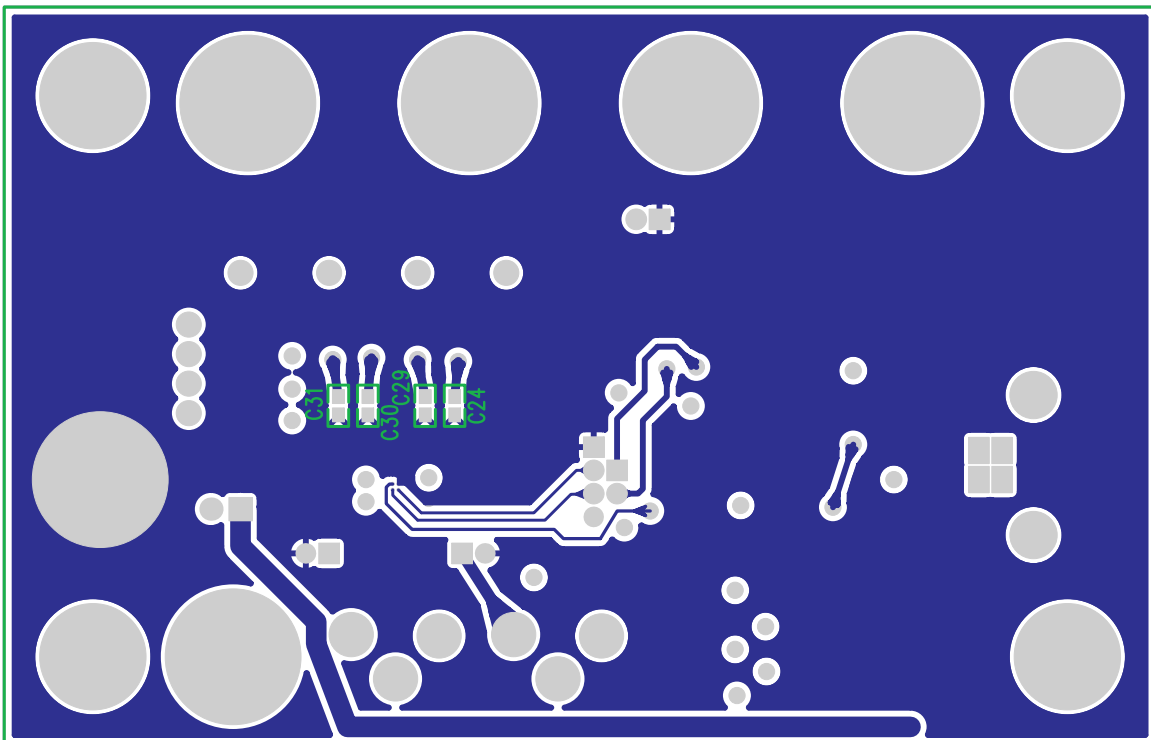

Figure 10. TPA2026D2EVM – Bottom Layer

5 TPA2026D2EVM Parts List

Table 1. TPA2026D2EVM Parts List

Reference	Description	Qty	MFR/ Part Number	Vendor Name / Number
C18, C19	CAP CERM SMD0603 33PFD 50V 5% COG ROHS	2	TDK C1608C0G1H330J	DIGI-KEY/445-1275-1
C13, C14	CAP CERM SMD0603 47PFD 50V 5% COG ROHS	2	TDK C1608C0G1H470J	DIGI-KEY/445-1277-1
C20	CAP CERM SMD0603 100PFD 50V 5% COG ROHS	1	TDK C1608C0G1H101J	DIGI-KEY/445-1281-1
C21	CAP CERM SMD0603 1000PFD 50V 5% COG ROHS	1	TDK C1608C0G1H102J	DIGI-KEY/445-1293-1
C32, C33, C34, C35	CAP CERM SMD0805 4700PFD 50V 5% COG ROHS	4	PANASONIC ECJ-2VB1H472K	DIGI-KEY/PCC472BNCT
C6, C7, C8, C10	CAP CERM SMD0603 0.1UFD 25V 10% X7R ROHS	4	AVX 06033D104KAT2A	DIGI-KEY/478-1244-1
C25, C26, C27, C28	CAP CERM SMD0603 0.1UFD 50V 10% X7R ROHS	4	TDK C1608X7R1H104K	DIGI-KEY/445-1314-1
C1, C2, C3, C4, C5, C9, C11, C16, C17, C22, C23	CAP CERM SMD0603 1.0UFD 10V 10% X5R ROHS	11	TDK C1608X5R1A105K	DIGI-KEY/445-1321-1
C12	CAP CERM SMD1206 10UFD 6.3V 10% X5R ROHS	1	TDK C3216X5R0J106K	DIGI-KEY/445-1388-1
C36	CAP CERM SMD1206 10UFD 16V 10% X5R ROHS	1	KEMET C1206C106K4PACTU	DIGI-KEY/399-5091-1
C15	CAP TANT SMD 100UFD 10V 10% B45197A ROHS	1	KEMET B45197A2107K309	DIGI-KEY/495-1528-1
R6, R7	RESISTOR SMD0603 27.4 OHMS 1/10W 1% ROHS	2	Panasonic ERJ-3EKF27R4V	DIGI-KEY/P27.4HCT
R11, R12, R13, R14	RESISTOR SMD0805 1.0K OHMS 1/8W 1% ROHS	4	Panasonic ERJ-3EKF1001V	DIGI-KEY/P1.00KHCT
R5	RESISTOR SMD0603 1.5K OHMS 1/10W 5% ROHS	1	Panasonic ERJ-3GEYJ1R5V	DIGI-KEY/P1.5GCT
R2, R3, R10	RESISTOR SMD0603 2K OHMS 1/10W 5% ROHS	3	Panasonic ERJ-3GEYJ202V	DIGI-KEY/P2.0KGCT
R9	RESISTOR SMD0603 3.09K OHMS 1/10W 1% ROHS	1	Panasonic ERJ-3EKF3091V	DIGI-KEY/P3.09KHCT
R1, R4, R8	RESISTOR SMD0603 100K OHMS 1/10W 5% ROHS	3	Panasonic ERJ-3GEYJ104V	DIGI-KEY/P100KGCT
U4	EEPROM W/I2C 64K 2.5V SOIC ROHS	1	MICROCHIP TECHNOLOGY 24LC64-E/SN	DIGI-KEY/24LC64-E/SN
Y1	CRYSTAL 6.00MHz 30PPM SMD CSM-7X	1	ECS INC. ECS-60-32-5PXDNDN-TR	DIGI-KEY/XC1295CT
Q1	ROHS NFET 50V 200mA SOT-23 ROHS	1	ON SEMI BSS138LT1G	DIGI-KEY/BSS138LT1GOSCT
L1, L2	FERRITE BEAD SMD0805 600 OHM 2A MPZ ROHS	2	TDK MPZ2012S601A	DIGI-KEY/445-2206-1
L3, L4, L5, L6	FERRITE BEAD SMD0805 100 OHM 4A MPZ ROHS	4	TDK MPZ2012S101A	DIGI-KEY/ 445-1567-1
JP1, JP2, JP4, JP5, JP6	HEADER THRU MALE 2 PIN 2MM GOLD ROHS	5	NORCOMP 26630201RP2	DIGI-KEY/2663S-02
JP3	HEADER THRU MALE 4 PIN 2MM GOLD ROHS	1	NORCOMP 26630401RP2	DIGI-KEY/2663S-04
RIN	JACK, RCA 3-PIN PCB-RA RED ROHS	1	SWITCHCRAFT PJRAN1X1U03X	NEWARK/ 89K7617
LIN	JACK, RCA 3-PIN PCB-RA BLACK ROHS	1	SWITCHCRAFT PJRAN1X1U01X	NEWARK/65K7770
USB	JACK USB TYPE B PCB-RA ROHS	1	MILL-MAX 897-43-004-90-000000	DIGI-KEY/ED90064
GND, OUTL+, OUTL-, OUTR+, OUTR-, VDD	BINDING POST NON-INSULATED 15A ROHS	6	EMERSON 111-2223-001	DIGI-KEY/J587
N/A	4-40 SCREW, STEEL 0.250 IN	4	BUILDING FASTENERS PMS 440 0025	DIGI-KEY/H342

Table 1. TPA2026D2EVM Parts List (continued)

Reference	Description	Qty	MFR/ Part Number	Vendor Name / Number
N/A	STANDOFF,4-40,0.5INx3/16IN,ALUM RND F-F	4	KEYSTONE ELECTRONICS PH 2027	DIGI-KEY/2027K
U1	2.8W/CH STEREO CLASS-D AUDIO AMP WCSP16-YZH, ROHS	1	TI TPA2026D2YZH	TI/TPA2026D2YZH
U2	USB STREAMING CONTROLLER TQFP48-PFB ROHS	1	TI 296-13041-5	DIGI-KEY/296-13041-5
U3	VOLT REG LDO 3.3V 500mA SOIC8-D ROHS	1	TI 296-2776-5	DIGI-KEY/296-2776-5

Evaluation Board/Kit Important Notice

Texas Instruments (TI) provides the enclosed product(s) under the following conditions:

This evaluation board/kit is intended for use for **ENGINEERING DEVELOPMENT, DEMONSTRATION, OR EVALUATION PURPOSES ONLY** and is not considered by TI to be a finished end-product fit for general consumer use. Persons handling the product(s) must have electronics training and observe good engineering practice standards. As such, the goods being provided are not intended to be complete in terms of required design-, marketing-, and/or manufacturing-related protective considerations, including product safety and environmental measures typically found in end products that incorporate such semiconductor components or circuit boards. This evaluation board/kit does not fall within the scope of the European Union directives regarding electromagnetic compatibility, restricted substances (RoHS), recycling (WEEE), FCC, CE or UL, and therefore may not meet the technical requirements of these directives or other related directives.

Should this evaluation board/kit not meet the specifications indicated in the User's Guide, the board/kit may be returned within 30 days from the date of delivery for a full refund. **THE FOREGOING WARRANTY IS THE EXCLUSIVE WARRANTY MADE BY SELLER TO BUYER AND IS IN LIEU OF ALL OTHER WARRANTIES, EXPRESSED, IMPLIED, OR STATUTORY, INCLUDING ANY WARRANTY OF MERCHANTABILITY OR FITNESS FOR ANY PARTICULAR PURPOSE.**

The user assumes all responsibility and liability for proper and safe handling of the goods. Further, the user indemnifies TI from all claims arising from the handling or use of the goods. Due to the open construction of the product, it is the user's responsibility to take any and all appropriate precautions with regard to electrostatic discharge.

EXCEPT TO THE EXTENT OF THE INDEMNITY SET FORTH ABOVE, NEITHER PARTY SHALL BE LIABLE TO THE OTHER FOR ANY INDIRECT, SPECIAL, INCIDENTAL, OR CONSEQUENTIAL DAMAGES.

TI currently deals with a variety of customers for products, and therefore our arrangement with the user **is not exclusive.**

TI assumes **no liability for applications assistance, customer product design, software performance, or infringement of patents or services described herein.**

Please read the User's Guide and, specifically, the Warnings and Restrictions notice in the User's Guide prior to handling the product. This notice contains important safety information about temperatures and voltages. For additional information on TI's environmental and/or safety programs, please contact the TI application engineer or visit www.ti.com/esh.

No license is granted under any patent right or other intellectual property right of TI covering or relating to any machine, process, or combination in which such TI products or services might be or are used.

FCC Warning

This evaluation board/kit is intended for use for **ENGINEERING DEVELOPMENT, DEMONSTRATION, OR EVALUATION PURPOSES ONLY** and is not considered by TI to be a finished end-product fit for general consumer use. It generates, uses, and can radiate radio frequency energy and has not been tested for compliance with the limits of computing devices pursuant to part 15 of FCC rules, which are designed to provide reasonable protection against radio frequency interference. Operation of this equipment in other environments may cause interference with radio communications, in which case the user at his own expense will be required to take whatever measures may be required to correct this interference.

EVM Warnings and Restrictions

It is important to operate this EVM within the input voltage range of -0.3 V to 6 V and the output voltage range of -0.3 V to 0.3 V .

Exceeding the specified input range may cause unexpected operation and/or irreversible damage to the EVM. If there are questions concerning the input range, please contact a TI field representative prior to connecting the input power.

Applying loads outside of the specified output range may result in unintended operation and/or possible permanent damage to the EVM. Please consult the EVM User's Guide prior to connecting any load to the EVM output. If there is uncertainty as to the load specification, please contact a TI field representative.

During normal operation, some circuit components may have case temperatures greater than 85°C. The EVM is designed to operate properly with certain components above 85°C as long as the input and output ranges are maintained. These components include but are not limited to linear regulators, switching transistors, pass transistors, and current sense resistors. These types of devices can be identified using the EVM schematic located in the EVM User's Guide. When placing measurement probes near these devices during operation, please be aware that these devices may be very warm to the touch.

Mailing Address: Texas Instruments, Post Office Box 655303, Dallas, Texas 75265
Copyright © 2010, Texas Instruments Incorporated

IMPORTANT NOTICE

Texas Instruments Incorporated and its subsidiaries (TI) reserve the right to make corrections, modifications, enhancements, improvements, and other changes to its products and services at any time and to discontinue any product or service without notice. Customers should obtain the latest relevant information before placing orders and should verify that such information is current and complete. All products are sold subject to TI's terms and conditions of sale supplied at the time of order acknowledgment.

TI warrants performance of its hardware products to the specifications applicable at the time of sale in accordance with TI's standard warranty. Testing and other quality control techniques are used to the extent TI deems necessary to support this warranty. Except where mandated by government requirements, testing of all parameters of each product is not necessarily performed.

TI assumes no liability for applications assistance or customer product design. Customers are responsible for their products and applications using TI components. To minimize the risks associated with customer products and applications, customers should provide adequate design and operating safeguards.

TI does not warrant or represent that any license, either express or implied, is granted under any TI patent right, copyright, mask work right, or other TI intellectual property right relating to any combination, machine, or process in which TI products or services are used. Information published by TI regarding third-party products or services does not constitute a license from TI to use such products or services or a warranty or endorsement thereof. Use of such information may require a license from a third party under the patents or other intellectual property of the third party, or a license from TI under the patents or other intellectual property of TI.

Reproduction of TI information in TI data books or data sheets is permissible only if reproduction is without alteration and is accompanied by all associated warranties, conditions, limitations, and notices. Reproduction of this information with alteration is an unfair and deceptive business practice. TI is not responsible or liable for such altered documentation. Information of third parties may be subject to additional restrictions.

Resale of TI products or services with statements different from or beyond the parameters stated by TI for that product or service voids all express and any implied warranties for the associated TI product or service and is an unfair and deceptive business practice. TI is not responsible or liable for any such statements.

TI products are not authorized for use in safety-critical applications (such as life support) where a failure of the TI product would reasonably be expected to cause severe personal injury or death, unless officers of the parties have executed an agreement specifically governing such use. Buyers represent that they have all necessary expertise in the safety and regulatory ramifications of their applications, and acknowledge and agree that they are solely responsible for all legal, regulatory and safety-related requirements concerning their products and any use of TI products in such safety-critical applications, notwithstanding any applications-related information or support that may be provided by TI. Further, Buyers must fully indemnify TI and its representatives against any damages arising out of the use of TI products in such safety-critical applications.

TI products are neither designed nor intended for use in military/aerospace applications or environments unless the TI products are specifically designated by TI as military-grade or "enhanced plastic." Only products designated by TI as military-grade meet military specifications. Buyers acknowledge and agree that any such use of TI products which TI has not designated as military-grade is solely at the Buyer's risk, and that they are solely responsible for compliance with all legal and regulatory requirements in connection with such use.

TI products are neither designed nor intended for use in automotive applications or environments unless the specific TI products are designated by TI as compliant with ISO/TS 16949 requirements. Buyers acknowledge and agree that, if they use any non-designated products in automotive applications, TI will not be responsible for any failure to meet such requirements.

Following are URLs where you can obtain information on other Texas Instruments products and application solutions:

Products		Applications	
Amplifiers	amplifier.ti.com	Audio	www.ti.com/audio
Data Converters	dataconverter.ti.com	Automotive	www.ti.com/automotive
DLP® Products	www.dlp.com	Communications and Telecom	www.ti.com/communications
DSP	dsp.ti.com	Computers and Peripherals	www.ti.com/computers
Clocks and Timers	www.ti.com/clocks	Consumer Electronics	www.ti.com/consumer-apps
Interface	interface.ti.com	Energy	www.ti.com/energy
Logic	logic.ti.com	Industrial	www.ti.com/industrial
Power Mgmt	power.ti.com	Medical	www.ti.com/medical
Microcontrollers	microcontroller.ti.com	Security	www.ti.com/security
RFID	www.ti-rfid.com	Space, Avionics & Defense	www.ti.com/space-avionics-defense
RF/IF and ZigBee® Solutions	www.ti.com/lprf	Video and Imaging	www.ti.com/video
		Wireless	www.ti.com/wireless-apps

Mailing Address: Texas Instruments, Post Office Box 655303, Dallas, Texas 75265
Copyright © 2010, Texas Instruments Incorporated