

Using the TPS92070EVM-648 Integrated Dimming LED Lighting Driver Converter for 230 VAC Input

The TPS92070EVM-648 evaluation module (EVM) is a low power isolated flyback converter that provides 5 on-board LEDs with 370 mA of drive current from a nominal 230 VAC input. This EVM is designed to demonstrate the TPS92070 in a typical application where LEDs can be used for general illumination applications that require dimming.

Contents

| | | |
|---|--|----|
| 1 | Description | 2 |
| | 1.1 Typical Applications | 2 |
| | 1.2 Features | 3 |
| 2 | Electrical Performance Specifications | 3 |
| 3 | Schematic | 4 |
| 4 | Test Setup | 5 |
| | 4.1 Test Equipment | 5 |
| | 4.2 Recommended Test Setup | 6 |
| | 4.3 List of Test Points | 6 |
| 5 | Test Procedure | 7 |
| | 5.1 Line Regulation and Efficiency Measurement Procedure | 7 |
| | 5.2 Dimming | 7 |
| | 5.3 Equipment Shutdown | 7 |
| 6 | Performance Data and Typical Characteristic Curves | 7 |
| | 6.1 Efficiency | 7 |
| | 6.2 LED Current Regulation | 8 |
| | 6.3 Power Factor | 8 |
| | 6.4 Average Conduction | 9 |
| | 6.5 Turn On | 9 |
| | 6.6 Output Voltage Ripple | 10 |
| | 6.7 Output Current Ripple | 11 |
| | 6.8 AC Input | 11 |
| | 6.9 Switching Waveform | 12 |
| | 6.10 TDD, No Dimmer | 12 |
| | 6.11 TDD, With Dimmer | 13 |
| | 6.12 Valley Detect | 13 |
| | 6.13 Turn Off | 14 |
| | 6.14 Dimmer Detection | 14 |
| 7 | EVM Assembly Drawing and PCB layout | 15 |
| 8 | Bill of Materials | 18 |

List of Figures

| | | |
|---|--|---|
| 1 | TPS92070EVM-648 Schematic | 4 |
| 2 | TPS92070EVM-648 Recommended Test Set Up | 6 |
| 3 | TPS92070EVM-648 Efficiency with Respect to Line Voltage, no Dimmer | 7 |
| 4 | TPS92070EVM-648 LED Current Regulation with Respect to Line Voltage, no Dimmer | 8 |
| 5 | TPS92070EVM-648 Power Factor with Respect to Line Voltage, no Dimmer..... | 8 |
| 6 | LED Current with Respect to Average Dimmer Conduction | 9 |

| | | |
|----|--|----|
| 7 | Turn on, Full Load, no Dimmer, VIN = 230 VAC, CH1 = SEN, CH2 = VDD, CH3 = BP, CH4 = LINE | 9 |
| 8 | LED Turn on, Full Load, no Dimmer, VIN = 230 VAC | 10 |
| 9 | LED Output Voltage Ripple, Full Load, no Dimmer, VIN = 230 VAC | 10 |
| 10 | LED Output Current Ripple, Full Load, no Dimmer, VIN = 230 VAC, scale = 1 Amp per volt | 11 |
| 11 | Input AC Voltage and Current, Full Load, no Dimmer, CH1 = I _{IN} , CH3 = V _{IN} , scale = 1 Amp/V | 11 |
| 12 | Switching Waveforms, Full Load, no Dimmer, VIN = 230 VAC, CH1 = Q3 drain, CH2 = GATE, CH3 = PCS, 328 mV | 12 |
| 13 | TDD Signal Low When There is no Dimmer Detected on the Input, Valley Fill PFC is Enabled, Full Load, VIN = 230 VAC, CH1 = TDD, CH2 = SEN, CH3 = VIN | 12 |
| 14 | TDD Signal High When There is a Dimmer Detected on the Input, Valley Fill PFC is Disabled, Full Load, VIN = 230 VAC, CH1 = TDD, CH2 = SEN, CH3 = VIN | 13 |
| 15 | Valley Detect, Full Load, no Dimmer, VIN = 230 VAC, CH1 = VD, CH2 = GATE, CH3 = PCS | 13 |
| 16 | Turn off, Full Load, no Dimmer, VIN = 230 VAC, CH1 = SEN, CH2 = VDD, CH3 = BP, CH4 = LINE | 14 |
| 17 | Dimmer Detection, DTC Sinks Current During AC Zero Crossing to Keep TRIAC Triggered. CH1 = VIN, CH2 = DTC, CH3 = SEN | 14 |
| 18 | TPS92070EVM-648 Top View | 15 |
| 19 | TPS92070EVM-648 Top Layer Assembly Drawing (Top View) | 15 |
| 20 | TPS92070EVM-648 Bottom View | 16 |
| 21 | TPS92070EVM-648 Bottom Assembly Drawing (Bottom view) | 16 |
| 22 | TPS92070EVM-648 Top Copper (Top View) | 17 |
| 23 | TPS92070EVM-648 Internal Layer 1 (Top View) | 17 |
| 24 | TPS92070EVM-648 Internal Layer 2 (Top View) | 17 |
| 25 | TPS92070EVM-648 Bottom Copper (Bottom View) | 18 |

List of Tables

| | | |
|---|---|----|
| 1 | TPS92070EVM-648 Electrical Performance Specifications | 3 |
| 2 | The Function of Each Test Point | 6 |
| 3 | Bill of Materials | 18 |

1 Description

This evaluation module uses the TPS92070 High Efficiency Integrated Dimming LED Lighting Driver Controller (TI Literature Number [SLUSAN1](#)) in a low power offline flyback converter to provide 370 mA to the on-board LED load. The input accepts a nominal 50 Hz, 230 VAC input voltage. The TPS92070EVM-648 is designed to be used with a leading edge triac dimmer switch in series with the input voltage to control the lumen output of the LEDs. The integrated dimming interface circuit on the TPS92070 provides exponentially controlled light output based on the external dimmer position.

This user's guide provides the schematic, component list, assembly drawing, and test set up necessary to evaluate the TPS92070 in an AC input LED lighting application. To use an input voltage greater than 240 VAC, it is recommended the user change the fuse to one rated for at least 300 V at 1 A.

1.1 Typical Applications

The TPS92070 is suited for use in low power lighting applications such as:

- LED light bulb replacement
- LED luminaires
- LED down-lights
- LED wall washers

1.2 Features

The TPS92070EVM-648 features include:

- 180 VAC to 240 VAC input range
- LED current regulation of 370 mA, nominal
- 6 W output at 16.5 V
- Advanced integrated dimming interface
- Exponential dimming profile
- Programmable minimum LED Current
- Valley switching and DCM operation
- Leading edge dimmer detection
- Valley fill power factor correction
- Cycle by cycle current limit protection

2 Electrical Performance Specifications

Table 1. TPS92070EVM-648 Electrical Performance Specifications

| SYMBOL | PARAMETER | TEST CONDITIONS | MIN | TYP | MAX | UNITS |
|--------------------------------|-------------------------------|--|-----|------|-----|----------|
| INPUT CHARACTERISTICS | | | | | | |
| V_{IN} | Voltage range | | 180 | 230 | 265 | VAC |
| f_{LINE} | Input frequency | | | 50 | | Hz |
| $I_{IN(MAX)}$ | Input current | $V_{IN(TYP)}$, $I_{LED} = \text{full load}^{(1)}$ | | 50 | | mA |
| PF | Input power factor | $V_{IN(MAX)}$, $I_{LED} = \text{full load}^{(1)}$ | | 0.80 | | |
| OUTPUT CHARACTERISTICS | | | | | | |
| V_{OUT} | Output voltage | $V_{IN(MIN)} \leq V_{IN} \leq V_{IN(MAX)}$, $I_{LED} = \text{full load}^{(1)}$ | | 16 | | V |
| I_{LED} | Output load current set point | $V_{IN(MIN)} \leq V_{IN} \leq V_{IN(MAX)}$, $I_{LED} = \text{full load}^{(1)}$ | 352 | 370 | 388 | mA |
| | Output current regulation | $V_{IN(MIN)} \leq V_{IN} \leq V_{IN(MAX)}$, $I_{LED} = \text{full load}^{(1)}$ | | 5% | | |
| $I_{LED(min)}$ | Minimum LED current | $V_{IN(MIN)} \leq V_{IN} \leq V_{IN(MAX)}$, $I_{LED} = \text{full load}^{(1)}$ With dimmer capable of 10% conduction angle | | 13 | | mA |
| | Output voltage ripple | $V_{IN(TYP)}$, $I_{LED} = \text{full load}^{(1)}$ | | 5 | | V_{PP} |
| SYSTEMS CHARACTERISTICS | | | | | | |
| f_{SW} | Switching frequency | | 30 | | 146 | kHz |
| η | Full load efficiency | $V_{IN(TYP)}$, $I_{LED} = \text{full load}^{(1)}$ | | 83% | | |
| T_A | Operating temperature | | | 25 | | °C |

⁽¹⁾ Full load is 5 on-board LEDs in series.

CAUTION

High voltage levels are present on the evaluation module whenever it is energized. Proper precautions must be taken when working with the EVM. Serious injury can occur if proper safety precautions are not followed.

3 Schematic

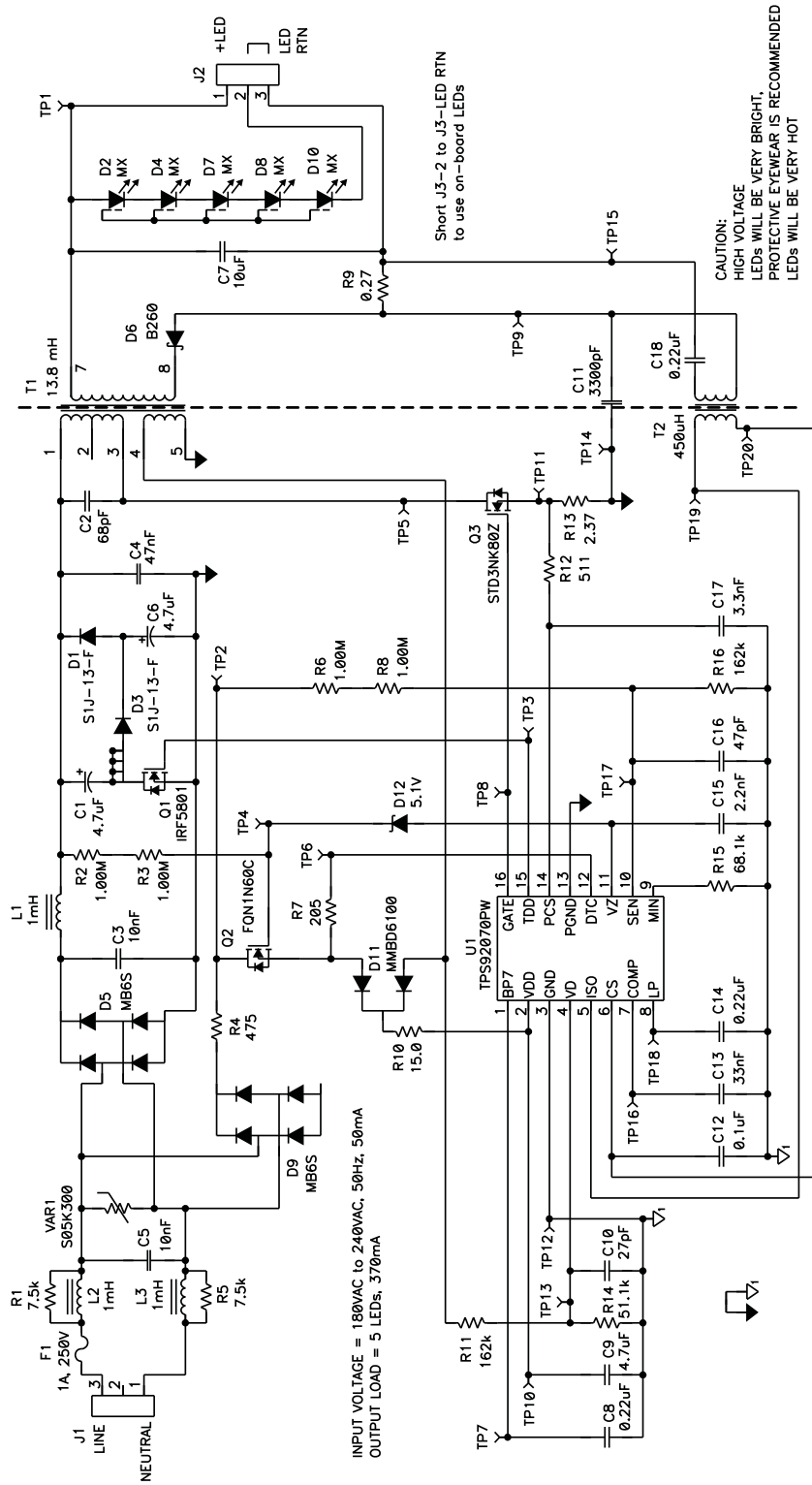

Figure 1. TPS92070EVM-648 Schematic

WARNING

High voltages that may cause injury exist on this evaluation module (EVM). Please ensure all safety procedures are followed when working on this EVM. Never leave a powered EVM unattended.

LEDs will be very bright! Shaded protective eyewear is recommended.

4 Test Setup

4.1 Test Equipment

Voltage Source: The input voltage source shall be an isolated variable AC source capable of supplying between 180 VAC and 265 VAC at no less than 10W and connected as shown in [Figure 2](#). (example: Hewlett Packard 6813B AC Power Source)

Power meter: For accurate efficiency calculations, a power meter should be inserted between the AC source and the EVM. For highest accuracy, connect the voltage terminals of the power meter directly across the Line and Neutral terminals of the EVM. (example: Voltech PM100 Single Phase Power Analyzer)

Multimeters: Two digital multimeters are used to measure the LED voltage (DMM V_{LED}) and load current (DMM A_{LED}). (example: Fluke 45 Digital Multimeter)

Output Load: By connecting a jumper wire from J2 pin 2 to J2 pin 3 (LED RTN) the 5 Cree™ MX series white LEDs that are on the EVM may be used as the load. The EVM can also be used to drive the user's external LED load by connecting the jumper wire from J2 pin 1 (+LED) to the external 370mA, 3.2 V LEDs and return them to J2 pin 3 (LED RTN).

Oscilloscope: A 200 MHz digital oscilloscope with 4 isolated channels for differential mode measurements is recommended. Non-isolated probes may result in flickering. A high voltage probe and a current probe are also recommended. (examples: Tektronix TPS2024B Four Channel Digital Storage Oscilloscope, Tektronix P5205A High Voltage Differential Probe, Tektronix TCPA300 Amplifier AC/DC Current Probe)

Dimmer: A leading edge dimmer, rated for 230 VAC can be used for controlling to LED light output. (example: Busch 2250U)

Fan: Forced air cooling is not required.

Recommended Wire Gauge: A minimum of AWG 22 wire is recommended to connect the AC voltage source to the EVM at less than 3 feet long.

4.2 Recommended Test Setup

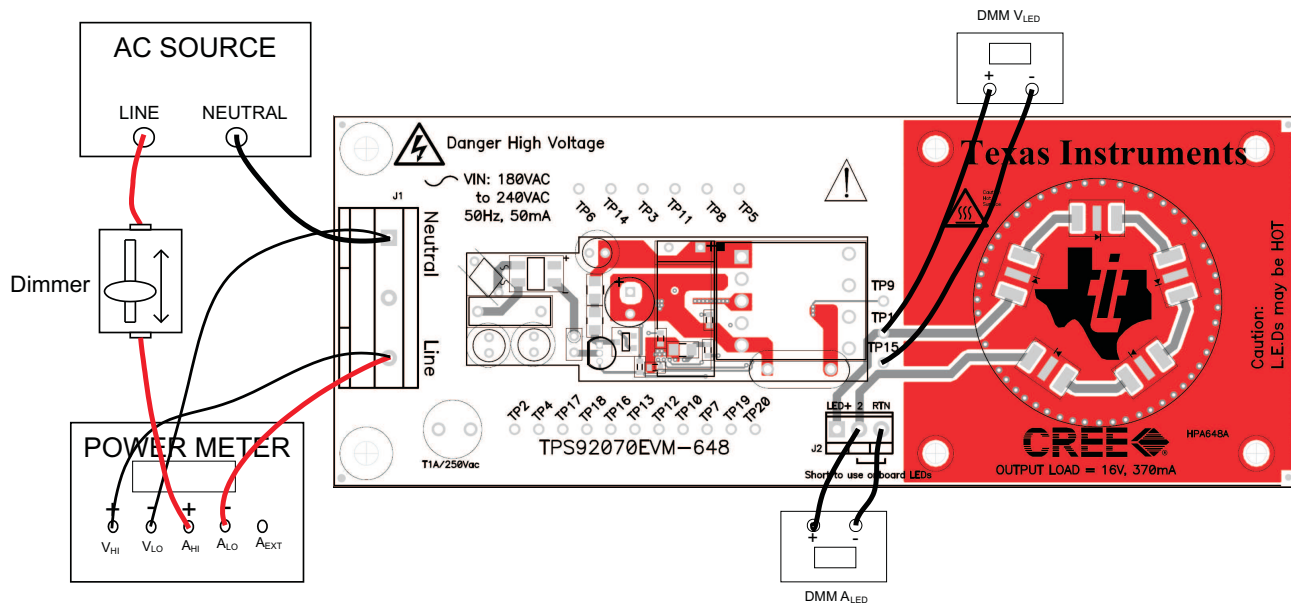

Figure 2. TPS92070EVM-648 Recommended Test Set Up

4.3 List of Test Points

Table 2. The Function of Each Test Point

| Test Point | Name | Description |
|------------|-----------|---|
| TP1 | +LED | LED output voltage, reference to TP15 |
| TP2 | Q2 drain | Phase detection circuit, reference to TP12 |
| TP3 | TDD | TRIAC dimmer detect, reference to TP14 |
| TP4 | Q2 gate | Phase detection circuit, reference to TP12 |
| TP5 | Q3 drain | High voltage switch drain, reference to TP14 |
| TP6 | DTS | Dimmer trigger control input, reference to TP14 |
| TP7 | BP | Bypass for internal 7 V regulator, reference to TP12 |
| TP8 | GATE | Q3 gate drive, reference to TP14 |
| TP9 | SRTN | Secondary side return |
| TP10 | VDD | Bias pin, reference to TP12 |
| TP11 | Q3 source | Primary current sense access, reference to TP14 |
| TP12 | GND | Ground, reference for TP2, TP4, TP7, TP10, TP13, TP16, TP17, TP18, TP19, TP20 |
| TP13 | VD | Valley detect, reference to TP12 |
| TP14 | PGND | Power ground, reference for TP3, TP5, TP6, TP8, TP11 |
| TP15 | LED RTN | Return for LED load, reference for TP1 |
| TP16 | COMP | Loop compensation, reference to TP12 |
| TP17 | SEN | Dimmer sense input, reference to TP12 |
| TP18 | LP | Pole for DTC low pass filter, reference to TP12 |
| TP19 | ISO | Inverting input to LED current sense comparator, reference to TP12 |
| TP20 | CS | Non-inverting input to LED current sense comparator, reference to TP12 |

5 Test Procedure

5.1 Line Regulation and Efficiency Measurement Procedure

1. With the dimmer removed from the test set up, set the AC voltage source to 180 VAC, 50 Hz.
2. The LEDs should be lit and the LED current should be within regulation per [Table 1](#).
3. Adjust AC voltage up to 265 VAC.
4. LEDs should be lit and the current should remain within regulation per [Table 1](#) with no flicker.
5. Efficiency data should be taken without the dimmer in circuit and input measurements taken from the power meter.
6. Turn off AC power. LEDs should turn off with no flashing or flicker.

5.2 Dimming

1. With dimmer in circuit, set the AC voltage source between 180 VAC and 265 VAC, 50 Hz.
2. Adjust the dimmer to control light output.

5.3 Equipment Shutdown

1. Turn off AC voltage source.

6 Performance Data and Typical Characteristic Curves

[Figure 3](#) through [Figure 17](#) present typical performance curves for the TPS92070EVM-648. Since actual performance data can be affected by measurement techniques and environmental variables, these curves are presented for reference and may differ from actual field measurements.

6.1 Efficiency

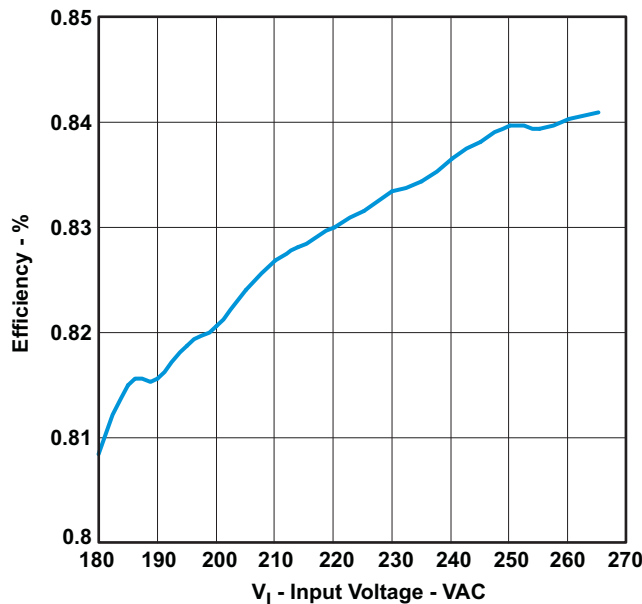

Figure 3. TPS92070EVM-648 Efficiency with Respect to Line Voltage, no Dimmer

6.2 LED Current Regulation

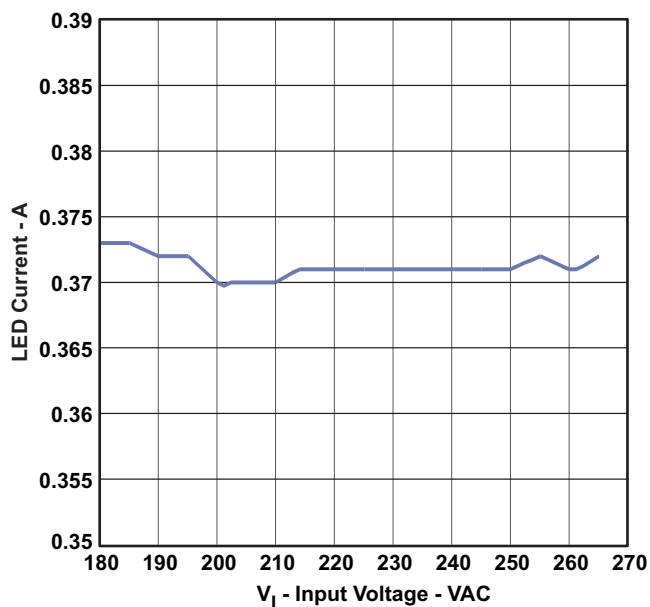

Figure 4. TPS92070EVM-648 LED Current Regulation with Respect to Line Voltage, no Dimmer

6.3 Power Factor

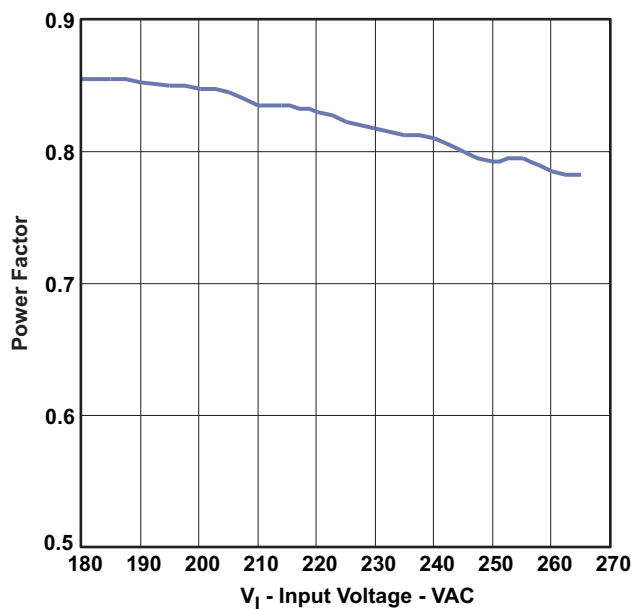

Figure 5. TPS92070EVM-648 Power Factor with Respect to Line Voltage, no Dimmer

6.4 Average Conduction

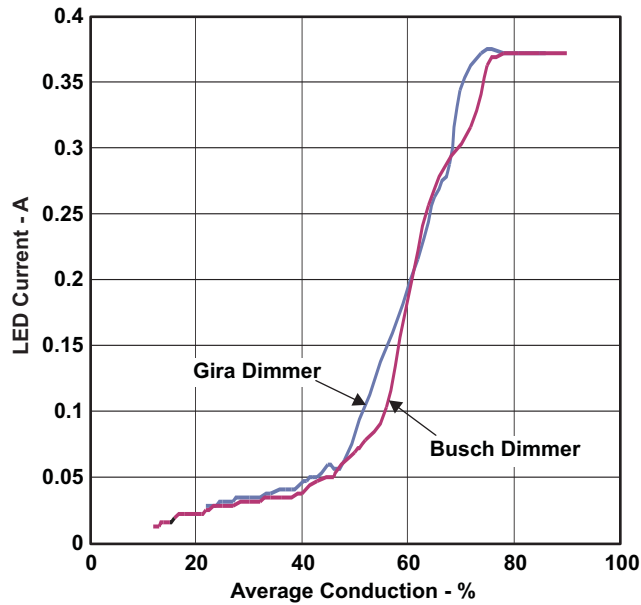

Figure 6. LED Current with Respect to Average Dimmer Conduction

6.5 Turn On

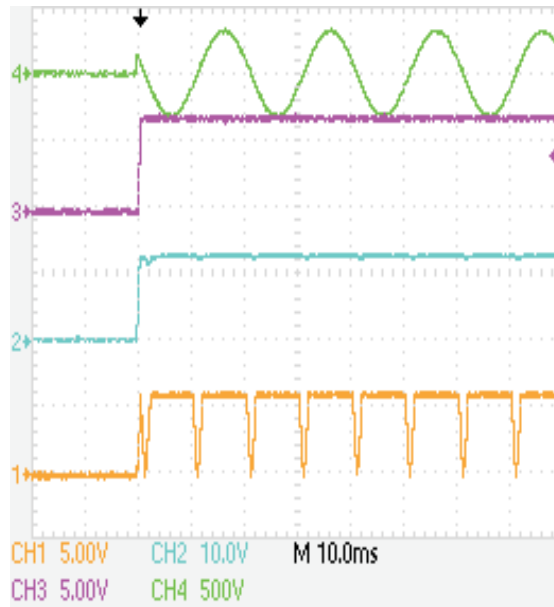

Figure 7. Turn on, Full Load, no Dimmer, VIN = 230 VAC, CH1 = SEN, CH2 = VDD, CH3 = BP, CH4 = LINE

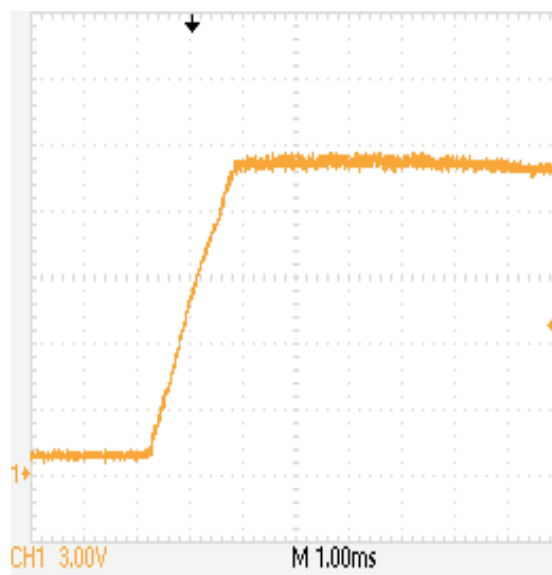

Figure 8. LED Turn on, Full Load, no Dimmer, VIN = 230 VAC

6.6 Output Voltage Ripple

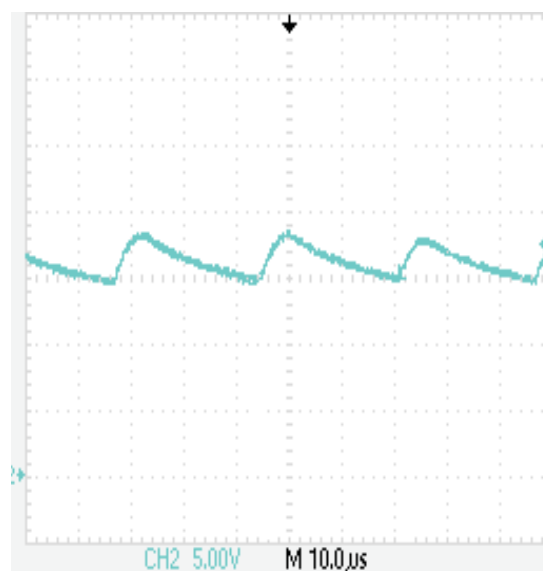

Figure 9. LED Output Voltage Ripple, Full Load, no Dimmer, VIN = 230 VAC

6.7 Output Current Ripple

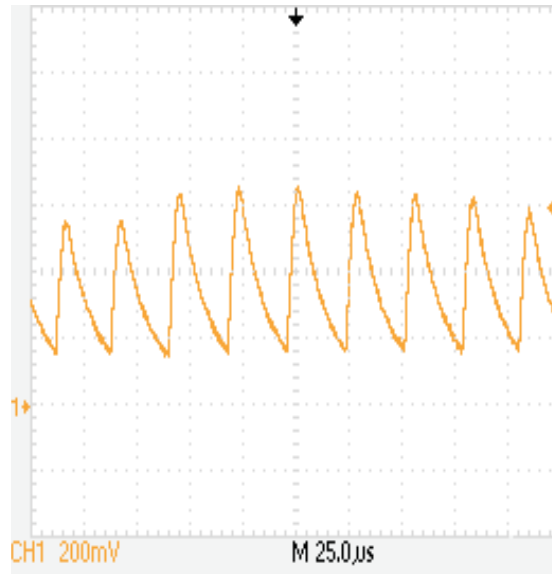
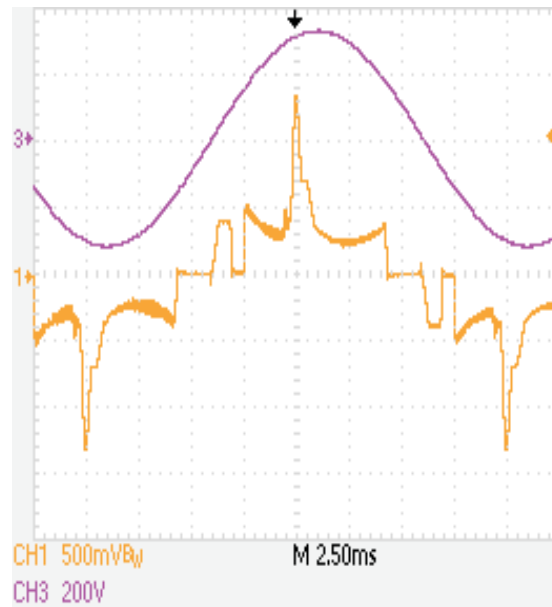

Figure 10. LED Output Current Ripple, Full Load, no Dimmer, $V_{IN} = 230$ VAC, scale = 1 Amp per volt

6.8 AC Input



Notice the influence of the DTC circuit at the zero voltage crossings

Figure 11. Input AC Voltage and Current, Full Load, no Dimmer, $CH1 = I_{IN}$, $CH3 = V_{IN}$, scale = 1 Amp/V

6.9 Switching Waveform

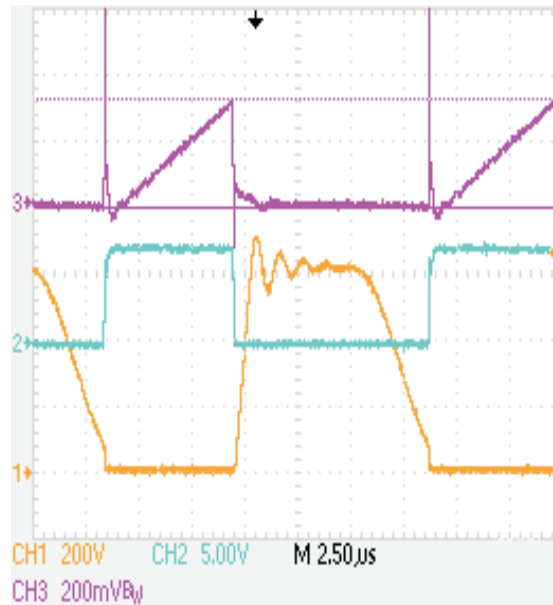

Figure 12. Switching Waveforms, Full Load, no Dimmer, VIN = 230 VAC, CH1 = Q3 drain, CH2 = GATE, CH3 = PCS, 328 mV

6.10 TDD, No Dimmer

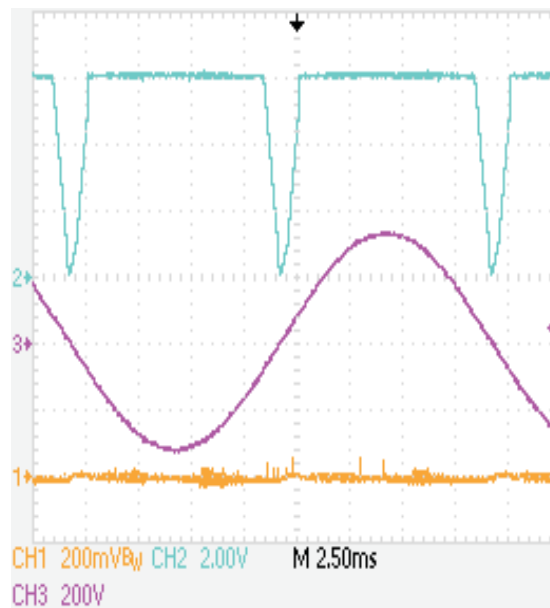

Figure 13. TDD Signal Low When There is no Dimmer Detected on the Input, Valley Fill PFC is Enabled, Full Load, VIN = 230 VAC, CH1 = TDD, CH2 = SEN, CH3 = VIN

6.11 TDD, With Dimmer

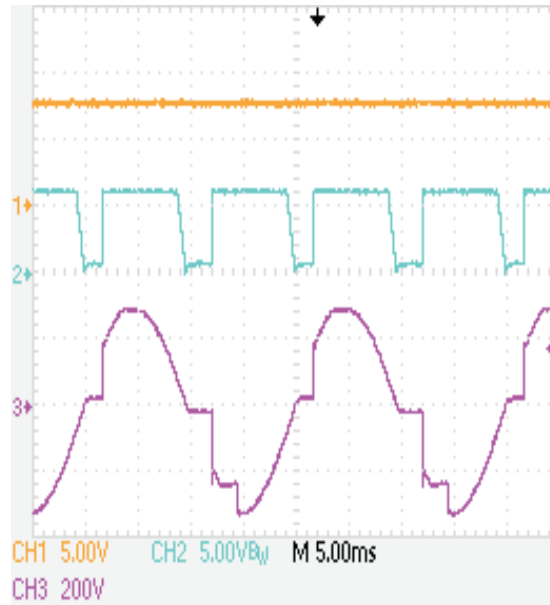

Figure 14. TDD Signal High When There is a Dimmer Detected on the Input, Valley Fill PFC is Disabled, Full Load, VIN = 230 VAC, CH1 = TDD, CH2 = SEN, CH3 = VIN

6.12 Valley Detect

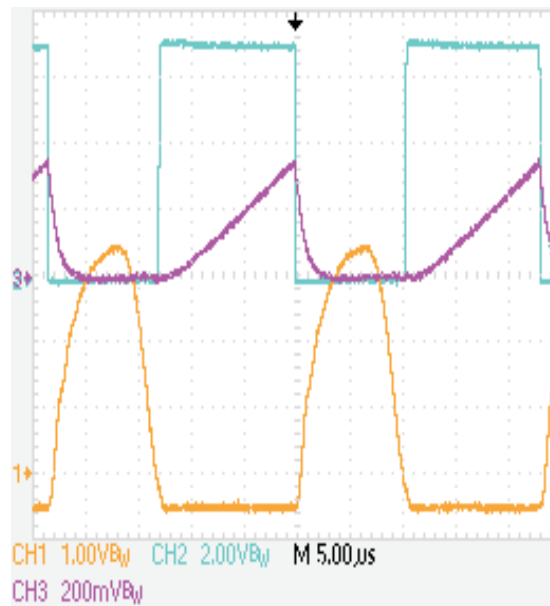

Figure 15. Valley Detect, Full Load, no Dimmer, VIN = 230 VAC, CH1 = VD, CH2 = GATE, CH3 = PCS

6.13 Turn Off

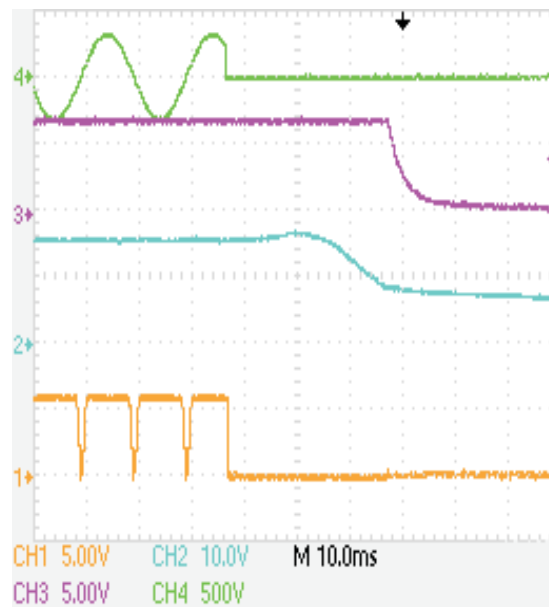

Figure 16. Turn off, Full Load, no Dimmer, VIN = 230 VAC, CH1 = SEN, CH2 = VDD, CH3 = BP, CH4 = LINE

6.14 Dimmer Detection

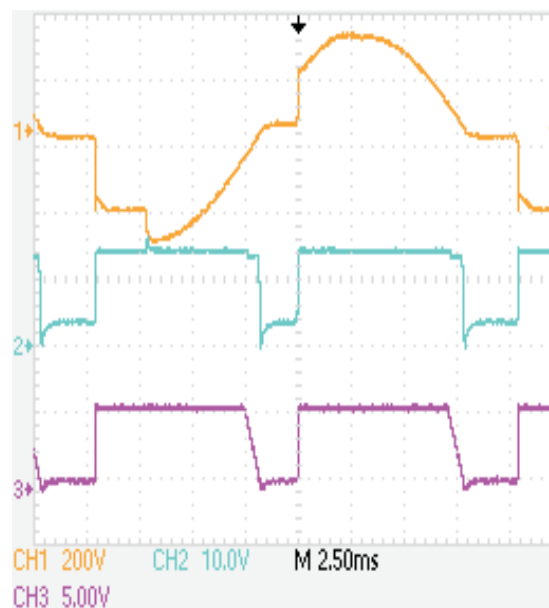

Figure 17. Dimmer Detection, DTC Sinks Current During AC Zero Crossing to Keep TRIAC Triggered. CH1 = VIN, CH2 = DTC, CH3 = SEN

7 EVM Assembly Drawing and PCB layout

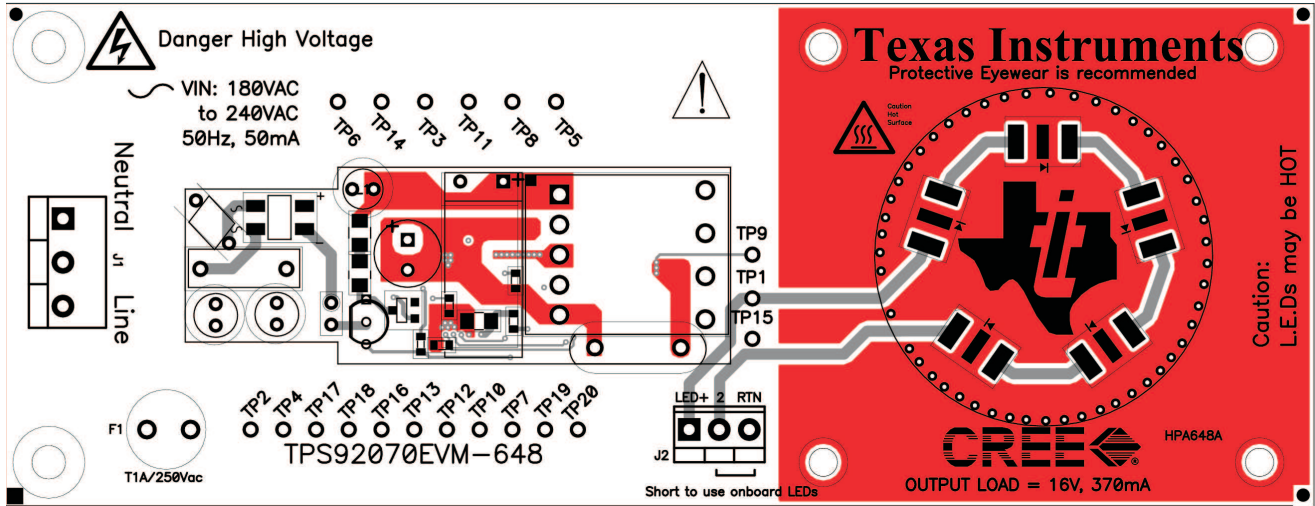

Figure 18. TPS92070EVM-648 Top View

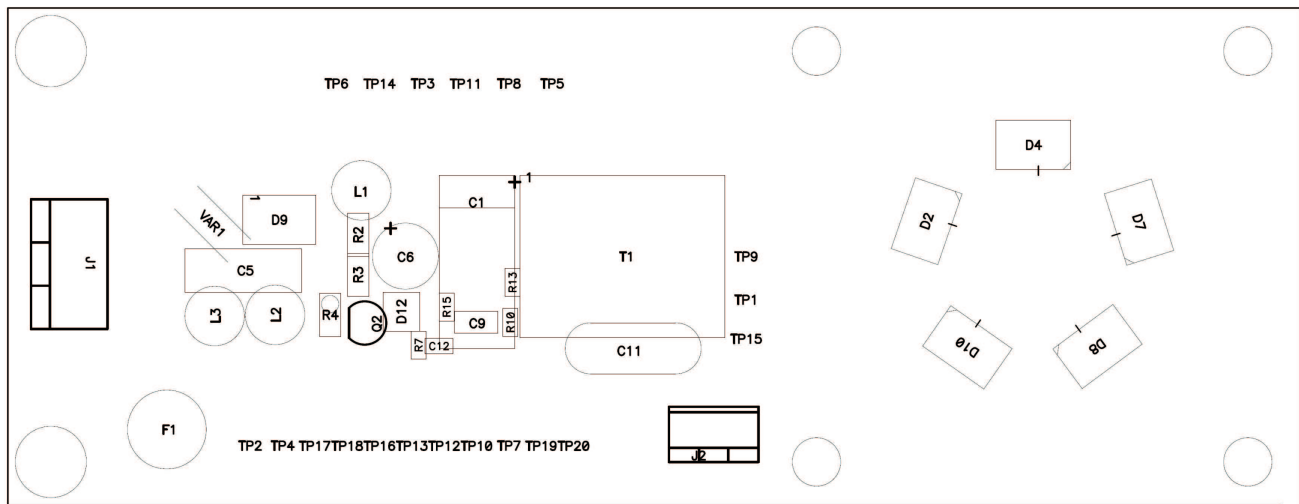

Figure 19. TPS92070EVM-648 Top Layer Assembly Drawing (Top View)

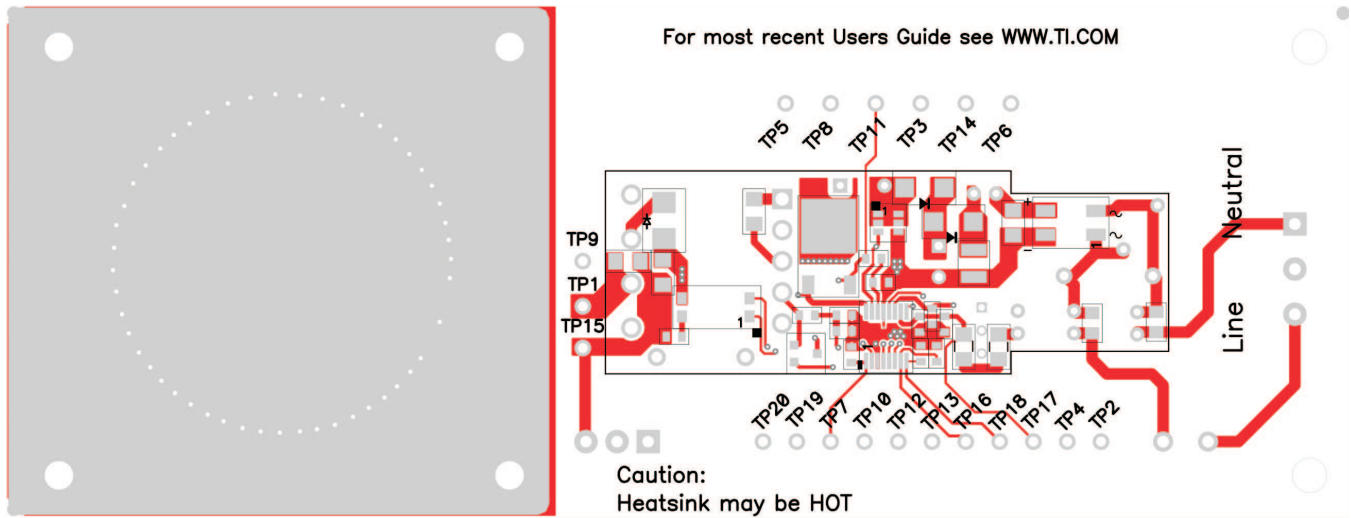

Figure 20. TPS92070EVM-648 Bottom View

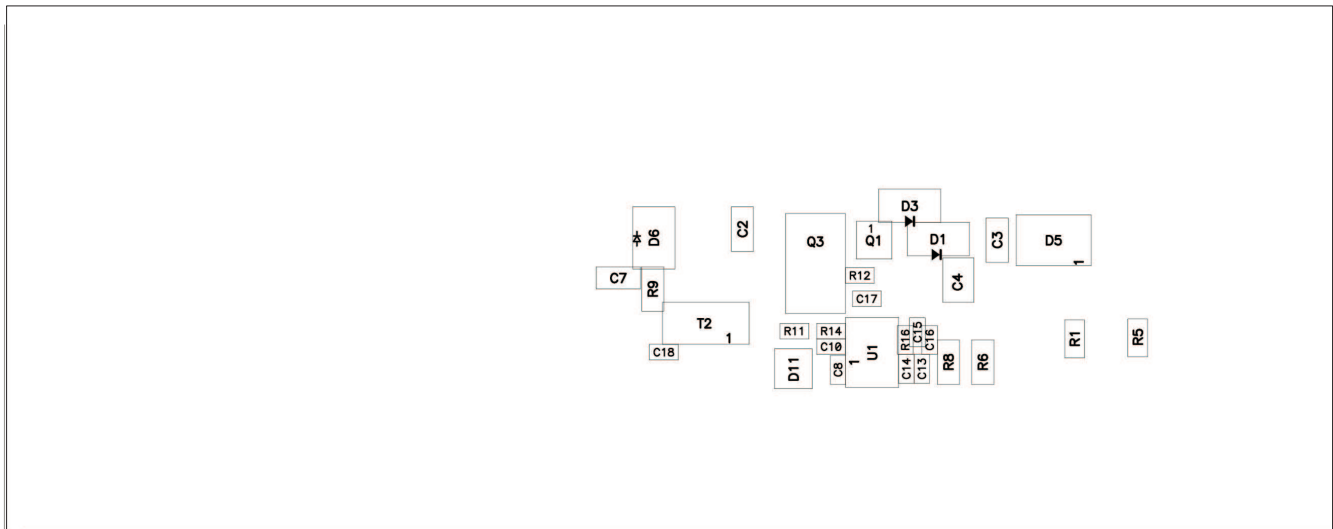

Figure 21. TPS92070EVM-648 Bottom Assembly Drawing (Bottom view)

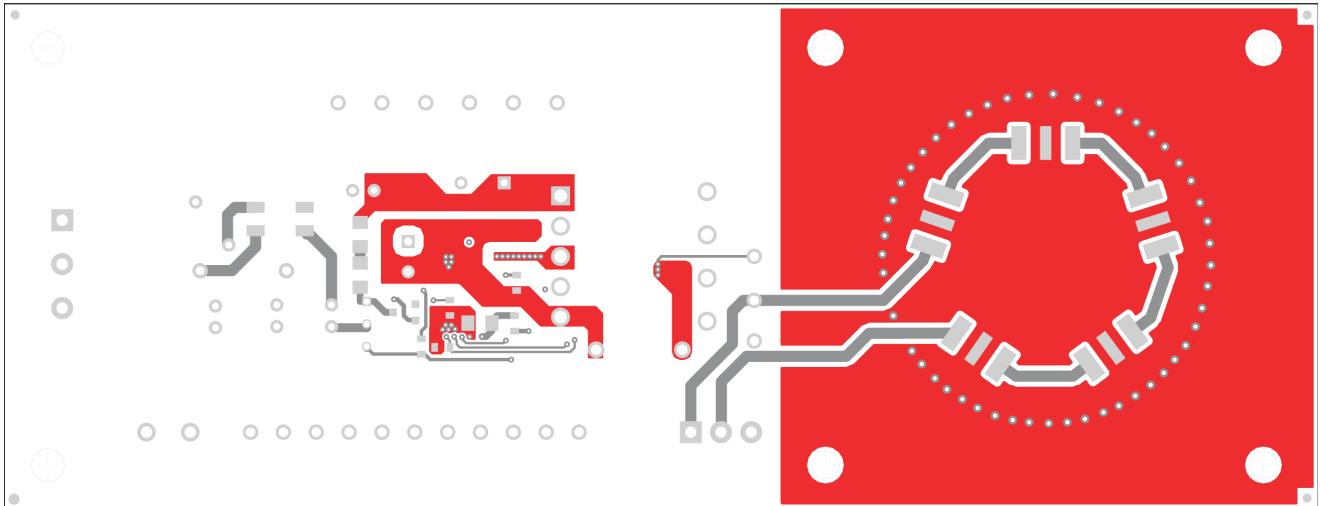

Figure 22. TPS92070EVM-648 Top Copper (Top View)

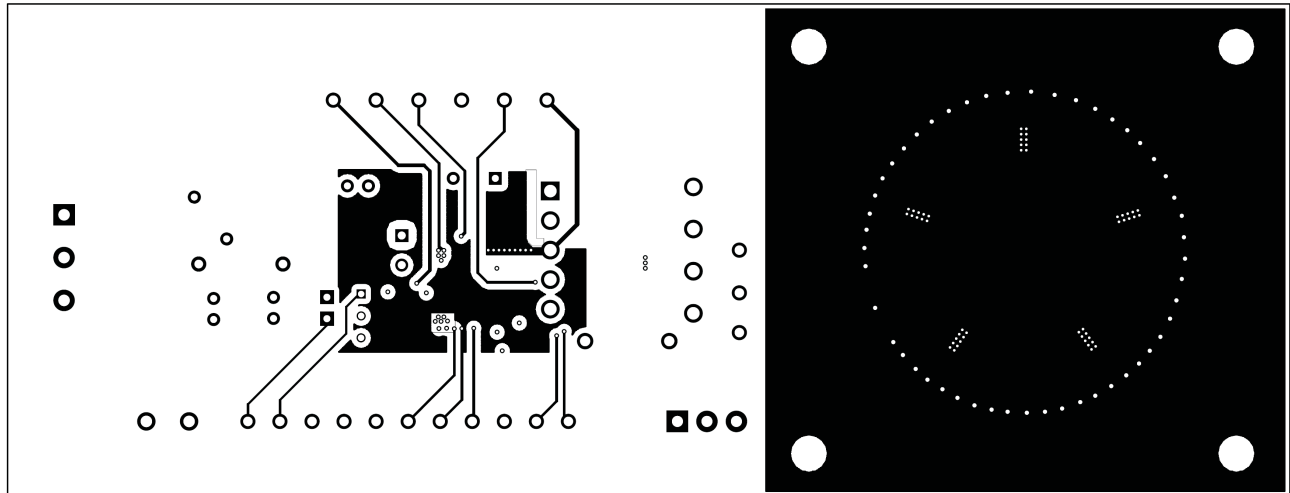

Figure 23. TPS92070EVM-648 Internal Layer 1 (Top View)

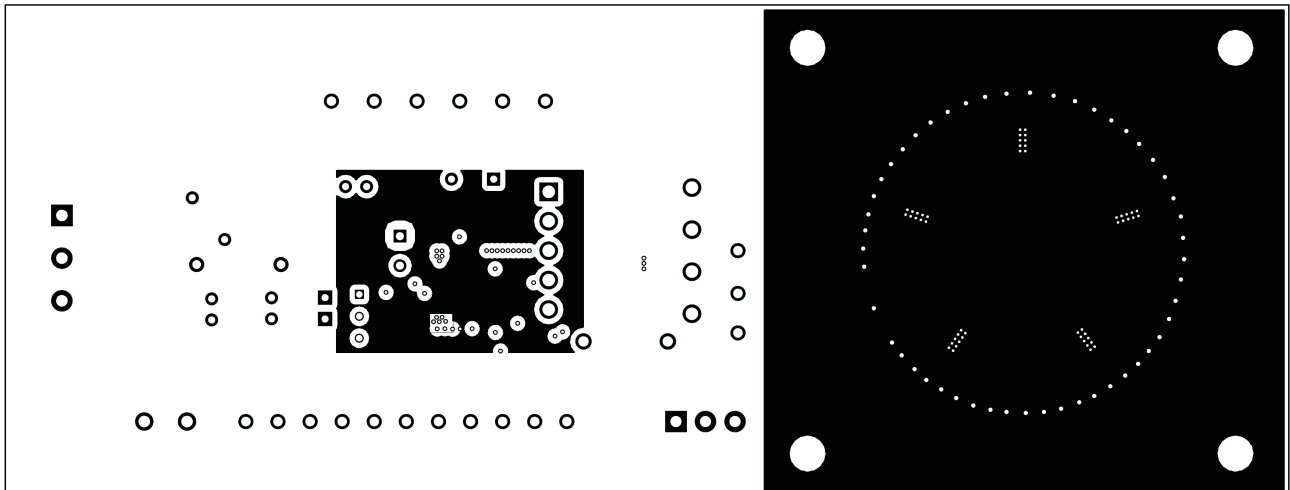

Figure 24. TPS92070EVM-648 Internal Layer 2 (Top View)

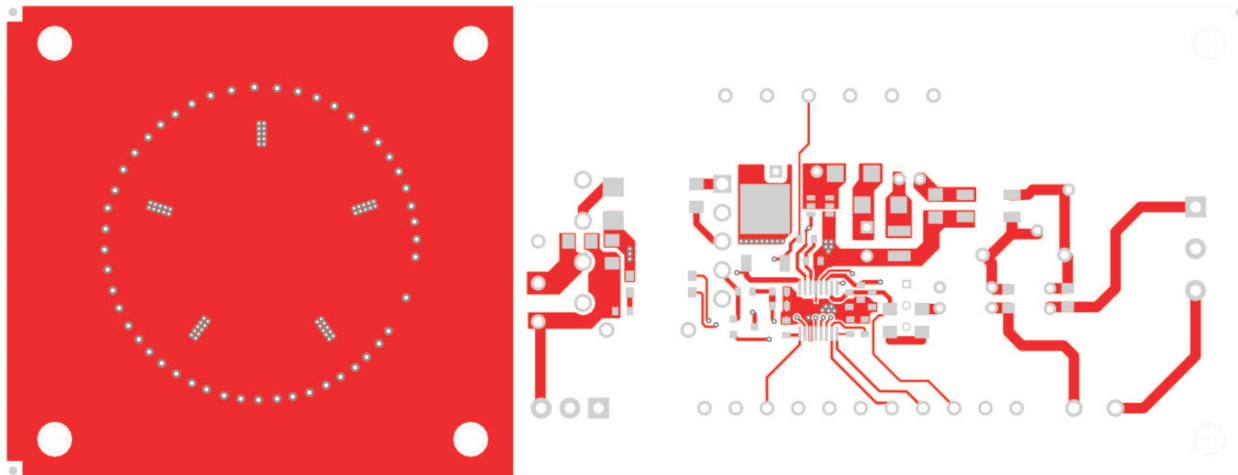

Figure 25. TPS92070EVM-648 Bottom Copper (Bottom View)

8 Bill of Materials

The bill of materials table list the components according to the schematic shown in Figure 1.

Table 3. Bill of Materials

| Count | RefDes | Description | Part Number | Mfr |
|-------|---------------------|--|--|-------------------------|
| 1 | C1 | Capacitor, Aluminum Electrolytic, 4.7 μ F, 400V, -40 to 105°C, \pm 20%, 10.00 mm Dia | EKMG401ELL4R7MJ16S | United Chemi-Con |
| 1 | C2 | Capacitor, Ceramic, 68 pF, 1000V, U2J, \pm 5%, 1206 | GRM31A7U3A680JW31D | Murata Electronics |
| 1 | C3 | Capacitor, Ceramic, 10 nF, 630V, X7R, \pm 10%, 1206 | GRM31BR72J103KW01L | Murata Electronics |
| 1 | C4 | Capacitor, Ceramic, 47 nF, 630V, X7R, \pm 10%, 1210 | C3225X7R2J473K | TDK Corporation |
| 1 | C5 | Capacitor, Metallized Polypropylene Film, 10 nF, 305VAC, X2, \pm 20%, 0.157 x 0.512 inch | B32921C3103M | Epcos Inc. |
| 1 | C6 | Capacitor, Aluminum Electrolytic, 4.7 μ F, 200V, -40 to +105°C, \pm 20%, 8.00 mm Dia | EKMG201ELL4R7MHB5D | United Chemi-Con |
| 1 | C7 | Capacitor, Ceramic, 10 μ F, 25V, X7R, \pm 10%, 1206 | TMK316B7106KL-TD | Taiyo Yuden |
| 3 | C8, C14, C18 | Capacitor, Ceramic, 0.22 μ F, 16V, X7R, \pm 10%, 0603 | Std | Std |
| 1 | C9 | Capacitor, Ceramic, 4.7 μ F, 25V, X7R, \pm 10%, 1206 | GRM31CR71E475KA88L | Murata Electronics |
| 1 | C10 | Capacitor, Ceramic, 27 pF, 50V, COG, NP0, \pm 5%, 0603 | Std | Std |
| 1 | C11 | Capacitor, Ceramic Disc, 330 μ pF, 500VAC, X1Y1, \pm 20%, 15 mm Dia | VY1332M59Y5UQ63V0 | Vishay/BC Components |
| 1 | C12 | Capacitor, Ceramic, 0.1 μ F, 25 V, X7R, \pm 10%, 0603 | Std | Std |
| 1 | C13 | Capacitor, Ceramic, 33 nF, 25 V, X7R, \pm 10%, 0603 | Std | Std |
| 1 | C15 | Capacitor, Ceramic, 2.2 nF, 50 V, X7R, \pm 10%, 0603 | Std | Std |
| 1 | C16 | Capacitor, Ceramic, 47 pF, 50V, COG, NP0, \pm 10%, 0603 | Std | Std |
| 1 | C17 | Capacitor, Ceramic, 3.3 nF, 50 V, X7R, \pm 10%, 0603 | Std | Std |
| 2 | D1, D3 | Diode, Rectifier, 1A, 60 0V, SMA | S1J-13-F | Diodes, Inc. |
| 5 | D2, D4, D7, D8, D10 | LED, Xlamp, 1A Max, White, 5.0 x 6.0 mm | MX6AWT-A1-0000-000AE7 or MX3AWT-A1-0000-000BE7 | Cree |
| 2 | D5, D9 | Diode, Bridge Rectifier, 0.5A, 600V, SO-4 | MB6S | Fairchild Semiconductor |
| 1 | D6 | Diode, Schottky, 2A, 60V, SMB | B260-13-F | Diodes, Inc. |
| 1 | D11 | Diode, Switching, Dual, 200mA, 70V, SOT-23 | MMBD6100LT1G | On Semiconductor |
| 1 | D12 | Diode, Zener, 5.1V, 250 mW, SOT-23 | BZX84-C5V1,215 | NXP Semiconductors |
| 1 | F1 | Fuse, Slow Blow, 1A, 250V, 0.335 inch | 38211000410 | Littelfuse / Wickmann |
| 3 | L1, L2, L3 | Inductor, Filter Choke, 1mH, \pm 10%, 6 mm Dia | 7447462102V | Würth Midcom |
| 1 | Q1 | MOSFET, N-ch, 200V, 600mA, 2.2 Ohms, TSOP-6 | IRF5801TRPBF | International Rectifier |
| 1 | Q2 | MOSFET, N-ch, 600V, 0.3A, 11.5 Ohms, TO-92 | FQN1N60CTA | Fairchild Semiconductor |
| 1 | Q3 | MOSFET, N-ch, 800V, 2.5A, 4.5 Ohms, DPAK | STD3NK80ZT4 | STMicroelectronics |
| 2 | R1, R5 | Resistor, Chip, 7.5k, 1/10W, \pm 1%, 0805 | Std | Std |
| 4 | R2, R3, R6, R8 | Resistor, Thick Film, 1.00M, 1/4W, \pm 1%, 1206 | Std | Std |

Table 3. Bill of Materials (continued)

| Count | RefDes | Description | Part Number | Mfr |
|-------|----------|---|------------------|----------------------------|
| 1 | R4 | Resistor, Metal Film, 475, 1/4 W, $\pm 1\%$, 0.250 inch x 0.093 inch Dia | RNF14FTD475R | Stackpole Electronics Inc. |
| 1 | R7 | Resistor, Chip, 205, 1/10W, $\pm 1\%$, 0603 | Std | Std |
| 1 | R9 | Resistor, Thick Film, 0.27, 1/2 Watt, $\pm 1\%$, 1206 | RCWE1206R270FKEA | Vishay/Dale |
| 1 | R10 | Resistor, Chip, 15.0, 1/10W, $\pm 1\%$, 0603 | Std | Std |
| 2 | R11, R16 | Resistor, Chip, 162k, 1/10W, $\pm 1\%$, 0603 | Std | Std |
| 1 | R12 | Resistor, Chip, 511, 1/10W, $\pm 1\%$, 0603 | Std | Std |
| 1 | R13 | Resistor, Chip, 2.37, 1/10W, $\pm 1\%$, 0603 | Std | Std |
| 1 | R14 | Resistor, Chip, 51.1k, 1/10W, $\pm 1\%$, 0603 | Std | Std |
| 1 | R15 | Resistor, Chip, 68.1k, 1/10W, $\pm 1\%$, 0603 | Std | Std |
| 1 | T1 | Transformer, 13.8 mH, $\pm 10\%$, 20.3 x 24.38 mm | 7508110410 | Würth Midcom |
| 1 | T2 | Transformer, 450 μ H, 1:1, 0.173 x 0.360 inch | 750082157 | Würth Midcom |
| 1 | U1 | IC, Dimmable Quasi-Resonant LED Lighting Controller, TSSOP | TPS92070PW | Texas Instruments |
| 1 | VAR1 | Varistor, Disk, 300VAC, 5mm Radial, D Size | S05K300 | Epcos Inc. |
| 1 | | Jumper Wire, U-Shape, 0.200 inch x 22 AWG | 923345-02-C | 3M |

Evaluation Board/Kit Important Notice

Texas Instruments (TI) provides the enclosed product(s) under the following conditions:

This evaluation board/kit is intended for use for **ENGINEERING DEVELOPMENT, DEMONSTRATION, OR EVALUATION PURPOSES ONLY** and is not considered by TI to be a finished end-product fit for general consumer use. Persons handling the product(s) must have electronics training and observe good engineering practice standards. As such, the goods being provided are not intended to be complete in terms of required design-, marketing-, and/or manufacturing-related protective considerations, including product safety and environmental measures typically found in end products that incorporate such semiconductor components or circuit boards. This evaluation board/kit does not fall within the scope of the European Union directives regarding electromagnetic compatibility, restricted substances (RoHS), recycling (WEEE), FCC, CE or UL, and therefore may not meet the technical requirements of these directives or other related directives.

Should this evaluation board/kit not meet the specifications indicated in the User's Guide, the board/kit may be returned within 30 days from the date of delivery for a full refund. **THE FOREGOING WARRANTY IS THE EXCLUSIVE WARRANTY MADE BY SELLER TO BUYER AND IS IN LIEU OF ALL OTHER WARRANTIES, EXPRESSED, IMPLIED, OR STATUTORY, INCLUDING ANY WARRANTY OF MERCHANTABILITY OR FITNESS FOR ANY PARTICULAR PURPOSE.**

The user assumes all responsibility and liability for proper and safe handling of the goods. Further, the user indemnifies TI from all claims arising from the handling or use of the goods. Due to the open construction of the product, it is the user's responsibility to take any and all appropriate precautions with regard to electrostatic discharge.

EXCEPT TO THE EXTENT OF THE INDEMNITY SET FORTH ABOVE, NEITHER PARTY SHALL BE LIABLE TO THE OTHER FOR ANY INDIRECT, SPECIAL, INCIDENTAL, OR CONSEQUENTIAL DAMAGES.

TI currently deals with a variety of customers for products, and therefore our arrangement with the user **is not exclusive.**

TI assumes **no liability for applications assistance, customer product design, software performance, or infringement of patents or services described herein.**

Please read the User's Guide and, specifically, the Warnings and Restrictions notice in the User's Guide prior to handling the product. This notice contains important safety information about temperatures and voltages. For additional information on TI's environmental and/or safety programs, please contact the TI application engineer or visit www.ti.com/esh.

No license is granted under any patent right or other intellectual property right of TI covering or relating to any machine, process, or combination in which such TI products or services might be or are used.

FCC Warning

This evaluation board/kit is intended for use for **ENGINEERING DEVELOPMENT, DEMONSTRATION, OR EVALUATION PURPOSES ONLY** and is not considered by TI to be a finished end-product fit for general consumer use. It generates, uses, and can radiate radio frequency energy and has not been tested for compliance with the limits of computing devices pursuant to part 15 of FCC rules, which are designed to provide reasonable protection against radio frequency interference. Operation of this equipment in other environments may cause interference with radio communications, in which case the user at his own expense will be required to take whatever measures may be required to correct this interference.

EVM Warnings and Restrictions

It is important to operate this EVM within the input voltage range of 180 VAC to 240 VAC and the output voltage range of 15 V to 19 V .

Exceeding the specified input range may cause unexpected operation and/or irreversible damage to the EVM. If there are questions concerning the input range, please contact a TI field representative prior to connecting the input power.

Applying loads outside of the specified output range may result in unintended operation and/or possible permanent damage to the EVM. Please consult the EVM User's Guide prior to connecting any load to the EVM output. If there is uncertainty as to the load specification, please contact a TI field representative.

During normal operation, some circuit components may have case temperatures greater than 40°C. The EVM is designed to operate properly with certain components above 40°C as long as the input and output ranges are maintained. These components include but are not limited to linear regulators, switching transistors, pass transistors, and current sense resistors. These types of devices can be identified using the EVM schematic located in the EVM User's Guide. When placing measurement probes near these devices during operation, please be aware that these devices may be very warm to the touch.

IMPORTANT NOTICE

Texas Instruments Incorporated and its subsidiaries (TI) reserve the right to make corrections, modifications, enhancements, improvements, and other changes to its products and services at any time and to discontinue any product or service without notice. Customers should obtain the latest relevant information before placing orders and should verify that such information is current and complete. All products are sold subject to TI's terms and conditions of sale supplied at the time of order acknowledgment.

TI warrants performance of its hardware products to the specifications applicable at the time of sale in accordance with TI's standard warranty. Testing and other quality control techniques are used to the extent TI deems necessary to support this warranty. Except where mandated by government requirements, testing of all parameters of each product is not necessarily performed.

TI assumes no liability for applications assistance or customer product design. Customers are responsible for their products and applications using TI components. To minimize the risks associated with customer products and applications, customers should provide adequate design and operating safeguards.

TI does not warrant or represent that any license, either express or implied, is granted under any TI patent right, copyright, mask work right, or other TI intellectual property right relating to any combination, machine, or process in which TI products or services are used. Information published by TI regarding third-party products or services does not constitute a license from TI to use such products or services or a warranty or endorsement thereof. Use of such information may require a license from a third party under the patents or other intellectual property of the third party, or a license from TI under the patents or other intellectual property of TI.

Reproduction of TI information in TI data books or data sheets is permissible only if reproduction is without alteration and is accompanied by all associated warranties, conditions, limitations, and notices. Reproduction of this information with alteration is an unfair and deceptive business practice. TI is not responsible or liable for such altered documentation. Information of third parties may be subject to additional restrictions.

Resale of TI products or services with statements different from or beyond the parameters stated by TI for that product or service voids all express and any implied warranties for the associated TI product or service and is an unfair and deceptive business practice. TI is not responsible or liable for any such statements.

TI products are not authorized for use in safety-critical applications (such as life support) where a failure of the TI product would reasonably be expected to cause severe personal injury or death, unless officers of the parties have executed an agreement specifically governing such use. Buyers represent that they have all necessary expertise in the safety and regulatory ramifications of their applications, and acknowledge and agree that they are solely responsible for all legal, regulatory and safety-related requirements concerning their products and any use of TI products in such safety-critical applications, notwithstanding any applications-related information or support that may be provided by TI. Further, Buyers must fully indemnify TI and its representatives against any damages arising out of the use of TI products in such safety-critical applications.

TI products are neither designed nor intended for use in military/aerospace applications or environments unless the TI products are specifically designated by TI as military-grade or "enhanced plastic." Only products designated by TI as military-grade meet military specifications. Buyers acknowledge and agree that any such use of TI products which TI has not designated as military-grade is solely at the Buyer's risk, and that they are solely responsible for compliance with all legal and regulatory requirements in connection with such use.

TI products are neither designed nor intended for use in automotive applications or environments unless the specific TI products are designated by TI as compliant with ISO/TS 16949 requirements. Buyers acknowledge and agree that, if they use any non-designated products in automotive applications, TI will not be responsible for any failure to meet such requirements.

Following are URLs where you can obtain information on other Texas Instruments products and application solutions:

Products

| | |
|-----------------------------|--|
| Audio | www.ti.com/audio |
| Amplifiers | amplifier.ti.com |
| Data Converters | dataconverter.ti.com |
| DLP® Products | www.dlp.com |
| DSP | dsp.ti.com |
| Clocks and Timers | www.ti.com/clocks |
| Interface | interface.ti.com |
| Logic | logic.ti.com |
| Power Mgmt | power.ti.com |
| Microcontrollers | microcontroller.ti.com |
| RFID | www.ti-rfid.com |
| RF/IF and ZigBee® Solutions | www.ti.com/lprf |

Applications

| | |
|-------------------------------|--|
| Communications and Telecom | www.ti.com/communications |
| Computers and Peripherals | www.ti.com/computers |
| Consumer Electronics | www.ti.com/consumer-apps |
| Energy and Lighting | www.ti.com/energy |
| Industrial | www.ti.com/industrial |
| Medical | www.ti.com/medical |
| Security | www.ti.com/security |
| Space, Avionics and Defense | www.ti.com/space-avionics-defense |
| Transportation and Automotive | www.ti.com/automotive |
| Video and Imaging | www.ti.com/video |
| Wireless | www.ti.com/wireless-apps |

TI E2E Community Home Page

e2e.ti.com

Mailing Address: Texas Instruments, Post Office Box 655303, Dallas, Texas 75265
Copyright © 2011, Texas Instruments Incorporated