

Using the UCD3138LLCEVM-028

User's Guide



Literature Number: SLUU979A
August 2012–Revised July 2013



WARNING

Always follow TI's set-up and application instructions, including use of all interface components within their recommended electrical rated voltage and power limits. Always use electrical safety precautions to help ensure your personal safety and the safety of those working around you. Contact TI's Product Information Center <http://support/ti.com> for further information.

Save all warnings and instructions for future reference.

Failure to follow warnings and instructions may result in personal injury, property damage, or death due to electrical shock and/or burn hazards.

The term TI HV EVM refers to an electronic device typically provided as an open framed, unenclosed printed circuit board assembly. It is intended strictly for use in development laboratory environments, solely for qualified professional users having training, expertise, and knowledge of electrical safety risks in development and application of high-voltage electrical circuits. Any other use and/or application are strictly prohibited by Texas Instruments. If you are not suitably qualified, you should immediately stop from further use of the HV EVM.

1. Work Area Safety:

- (a) Keep work area clean and orderly.
- (b) Qualified observer(s) must be present anytime circuits are energized.
- (c) Effective barriers and signage must be present in the area where the TI HV EVM and its interface electronics are energized, indicating operation of accessible high voltages may be present, for the purpose of protecting inadvertent access.
- (d) All interface circuits, power supplies, evaluation modules, instruments, meters, scopes and other related apparatus used in a development environment exceeding 50 V_{RMS}/75 VDC must be electrically located within a protected Emergency Power Off (EPO) protected power strip.
- (e) Use a stable and non-conductive work surface.
- (f) Use adequately insulated clamps and wires to attach measurement probes and instruments. No freehand testing whenever possible.

2. Electrical Safety:

- (a) De-energize the TI HV EVM and all its inputs, outputs, and electrical loads before performing any electrical or other diagnostic measurements. Revalidate that TI HV EVM power has been safely de-energized.
- (b) With the EVM confirmed de-energized, proceed with required electrical circuit configurations, wiring, measurement equipment hook-ups and other application needs, while still assuming the EVM circuit and measuring instruments are electrically live.
- (c) Once EVM readiness is complete, energize the EVM as intended.

WARNING: while the EVM is energized, never touch the EVM or its electrical circuits as they could be at high voltages capable of causing electrical shock hazard.

3. Personal Safety:

- (a) Wear personal protective equipment e.g. latex gloves and/or safety glasses with side shields or protect EVM in an adequate lucent plastic box with interlocks from accidental touch.

4. Limitation for Safe Use:

- (a) EVMs are not to be used as all or part of a production unit.

Digitally Controlled LLC Resonant Half-Bridge DC-DC Converter

1 Introduction

This EVM, UCD3138LLCEVM-028 is to help evaluate the UCD3138 64-pin digital control device in an off-line power converter application and then to aid in its design. The EVM is a standalone LLC resonant half-bridge DC-to-DC power converter. The EVM is used together with its control card, UCD3138CC64EVM-030, also an EVM on which is placed UCD3138RGC.

The UCD3138LLCEVM-028 together with UCD3138CC64EVM-030 can be used as they are delivered without additional work, from either hardware or firmware, to evaluate an LLC resonant half-bridge DC-to-DC converter. This EVM combination allows for some of its design parameters to be retuned using a GUI based tool, called Texas Instruments Fusion Digital Power Designer. It is also possible to load custom firmware with user's own definition and development.

Three EVMs are included UCD3138LLCEVM-028, UCD3138CC64EVM-030, and USB-TO-GPIO.

This user's guide provides basic evaluation instruction from a viewpoint of system operation in a standalone LLC resonant half-bridge DC-to-DC power converter.

WARNING

- High voltages are present on this evaluation module during operation and for a while even after power off. This module should only be tested by skilled personnel in a controlled laboratory environment.
- An isolated DC voltage source meeting IEC61010 reinforced insulation standards is recommended for evaluating this EVM.
- High temperature exceeding 60°C may be found during EVM operation and for a while even after power off.
- This EVM's purpose is to facilitate the evaluation of digital control in an LLC using the UCD3138, and cannot be tested and treated as a final product.
- Extreme caution should be taken to eliminate the possibility of electric shock and heat burn.
- Read and understand this user's guide thoroughly before starting any physical evaluation.

2 Description

The UCD3138LLCEVM-028 along with the UCD3138CC64EVM-030 demonstrates an LLC resonant half-bridge DC-DC power converter with digital control using the UCD3138 device. The UCD3138 device is located on the UCD3138CC64EVM-030 board. The UCD3138CC64EVM-030 is a daughter card with preloaded firmware that provides the required control functions for an LLC converter. For details of the firmware please contact TI. UCD3138LLCEVM-028 accepts a DC input from 350 V_{DC} to 400 V_{DC}, and outputs a nominal 12 V_{DC} with full load output power of 340 W, or full output current of 29 A.

NOTE: This EVM does not have an input fuse and relies on the input current limit from the input voltage source used.

2.1 Typical Applications

- Offline DC-to-DC Power Conversion
- Servers
- Telecommunication Systems

2.2 Features

- Digitally Controlled LLC Resonant Half-Bridge DC-to-DC Power Conversion
- DC Input from 350 V_{DC} to 400 V_{DC}
- 12 V_{DC} Regulated Output from No Load to Full Load
- Full-Load Power 340 W, or Full-Load Current 29 A
- High Efficiency
- Constant Soft-Start Time
- Protection: Over Voltage, Over Current, Brownout and Output Short-Circuit Protection
- Test Points to Facilitate Device and Topology Evaluation
- Synchronous Rectification
- Automatic Mode Switching between LLC Mode and PWM Mode
- Cycle-by-Cycle Current Limiting with Duty Cycle Matching
- Constant Current and Constant Power Control Mode
- PMBUS Communication
- Current Sharing Capability (GUI Enable), Across Paralleled Units

3 Performance Specifications

Table 1. UCD3138LLCEVM-028 Performance Specifications

PARAMETER	TEST CONDITIONS	MIN	TYP	MAX	UNITS
Input Characteristics					
Voltage operation range		350		400	V _{DC}
Input UVLO On			325		
Input UVLO Off			310		
Input current	Input = 350 V _{DC} , full load = 29 A			1.2	A
Input current	Input = 380 V _{DC} , full load = 29 A			1.1	
Input current	Input = 400 V _{DC} , full load = 29 A			1.0	
Output Characteristics					
Output voltage, V _{OUT}	No load to full load		12		VDC
Output load current, I _{OUT}	350 V _{DC} to 400 V _{DC}			29	A
Output voltage ripple	380 V _{DC} and full load = 29 A		200		mVpp
Output over current	Operation 10s then latch-off shutdown	30			A
Systems Characteristics					
Switching frequency	Resonant mode	35		150	kHz
	PWM Mode		150		
Peak efficiency	380 V _{DC} , full load = 29 A		93.5%		
Full-load efficiency	380 V _{DC} , load = 20 A		94.0%		
Operating temperature	Natural convection		25		°C
Firmware					
Device ID (version)	UCD3100ISO1 0.0.44.0000 120517				
Filename	UCD3138LLCEVM_028_0_0_44_120517.x0				

4 Schematics

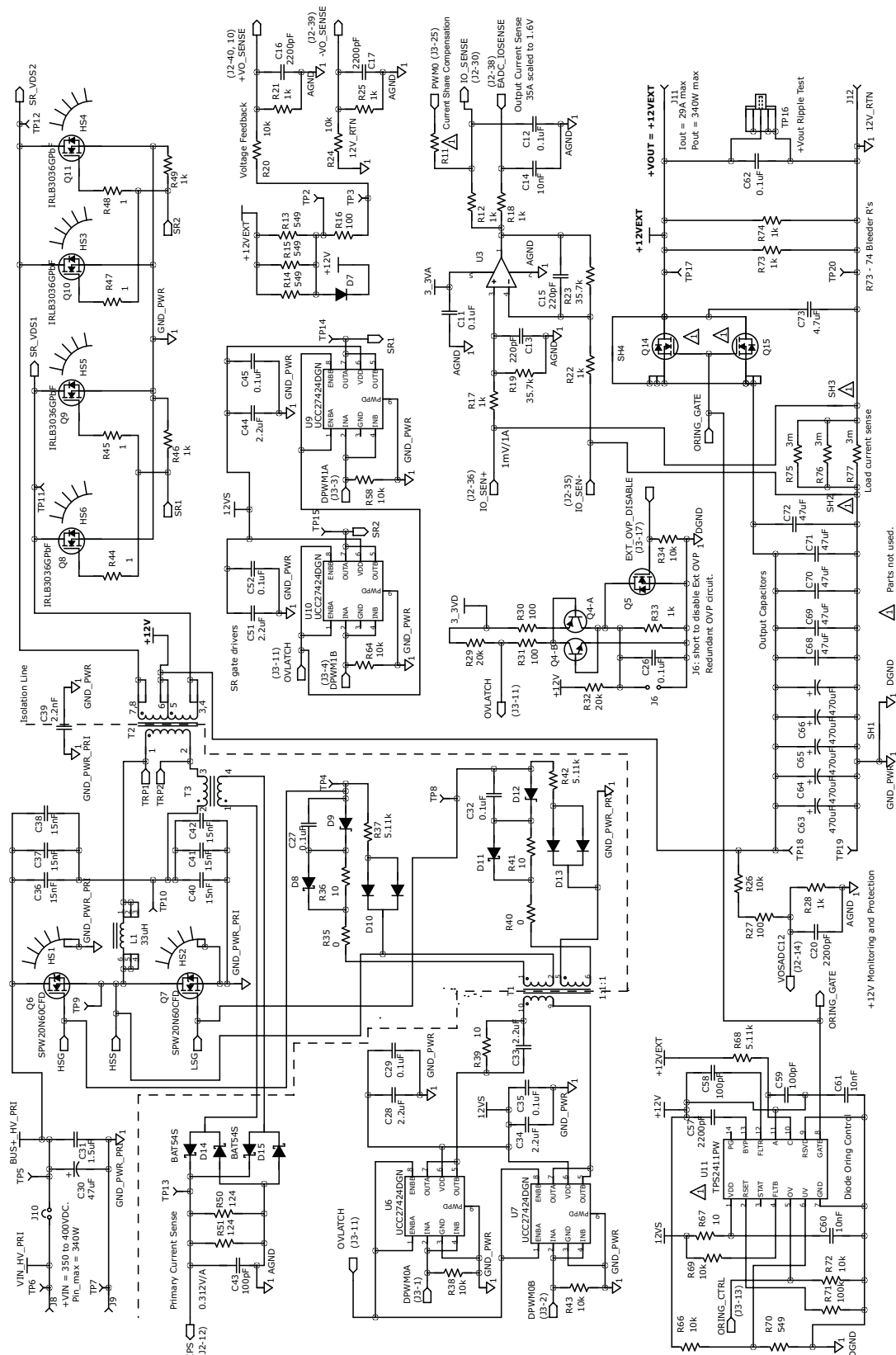

Figure 1. UCD3138LLCEVM-028 Schematic (image 1 of 2)

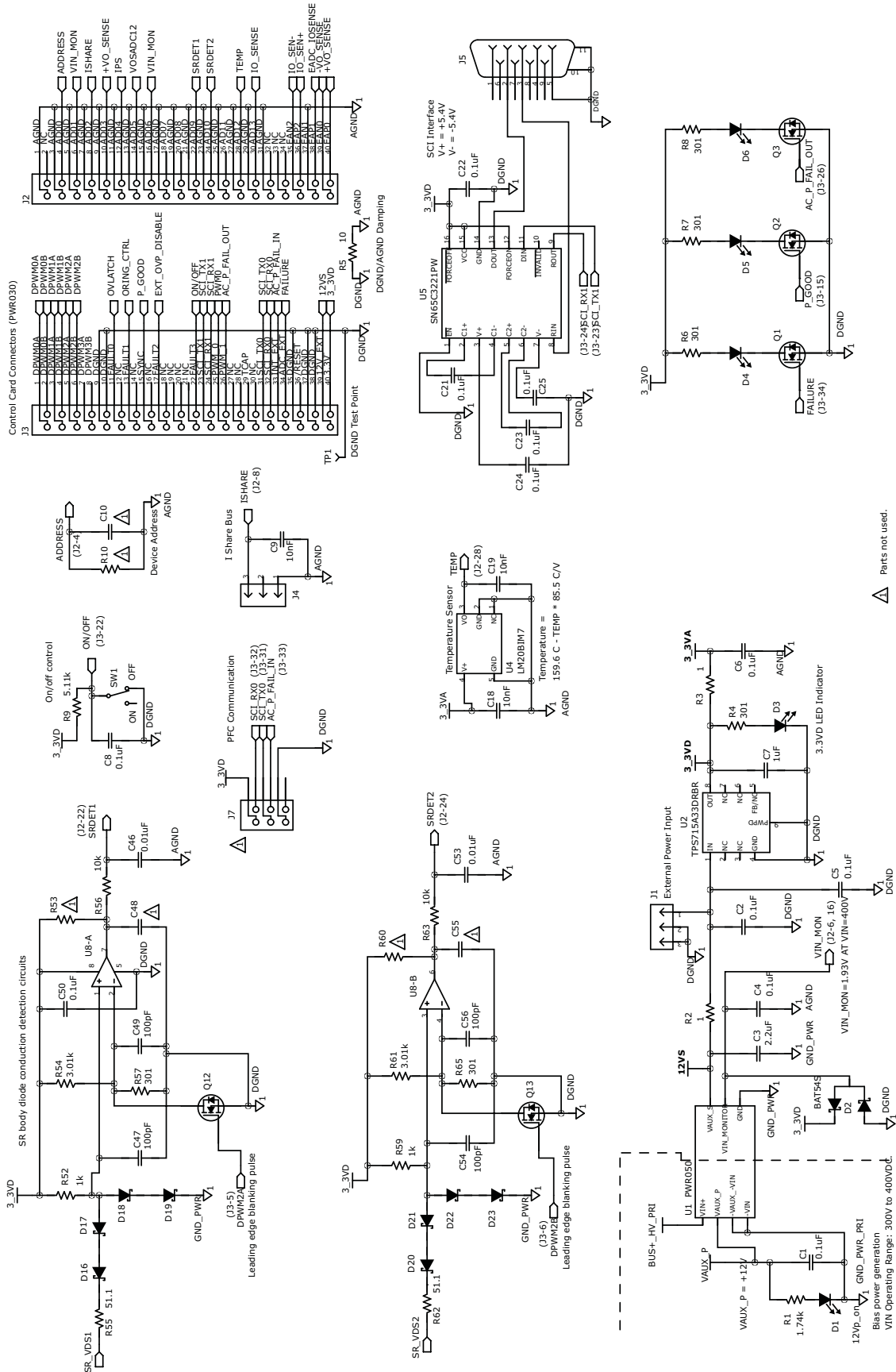

Figure 2. UCD3138PFCEVM-026 Schematic (image 2 of 2)

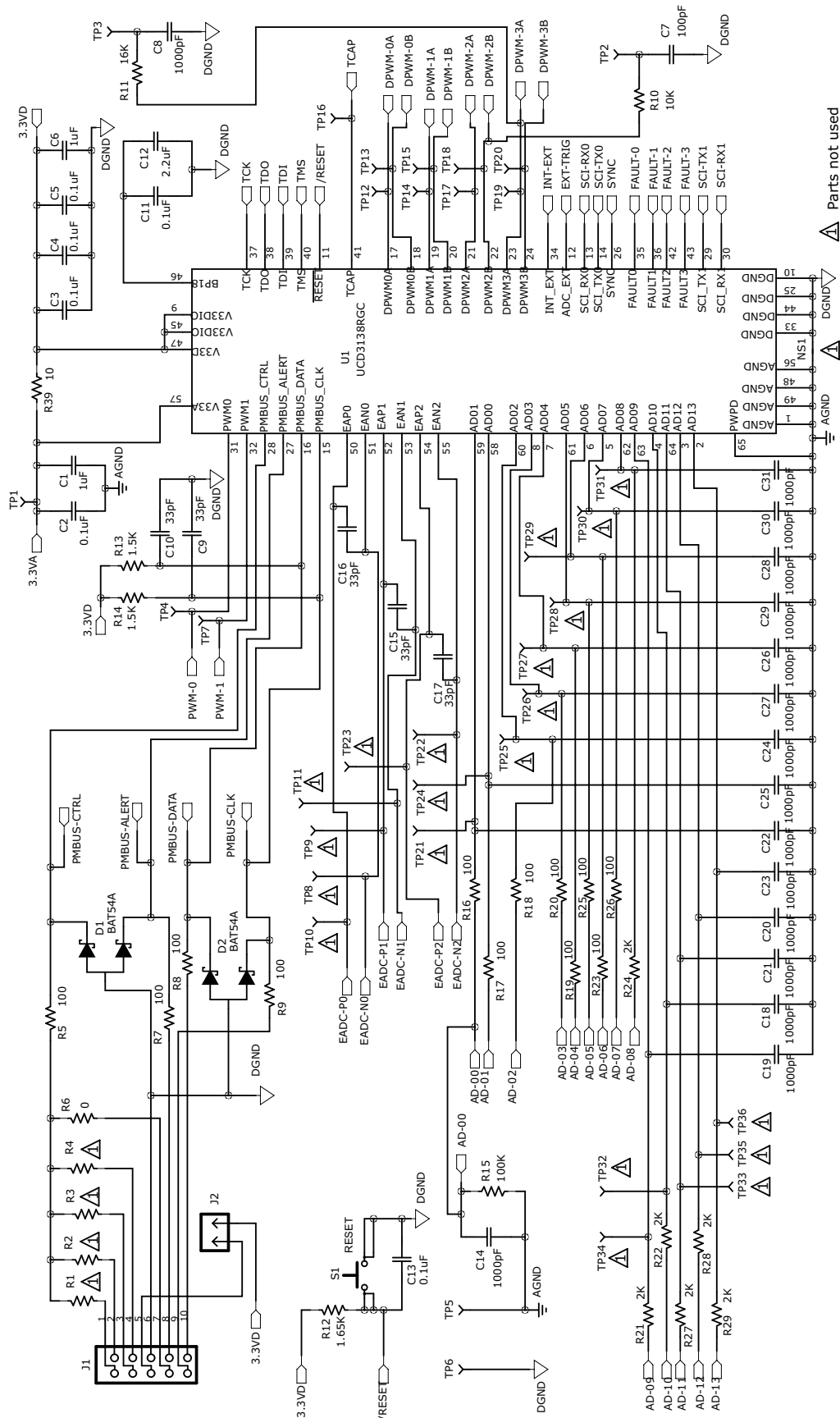

Figure 3. UCD3138CC64EVM-030 Schematic (image 1 of 2)

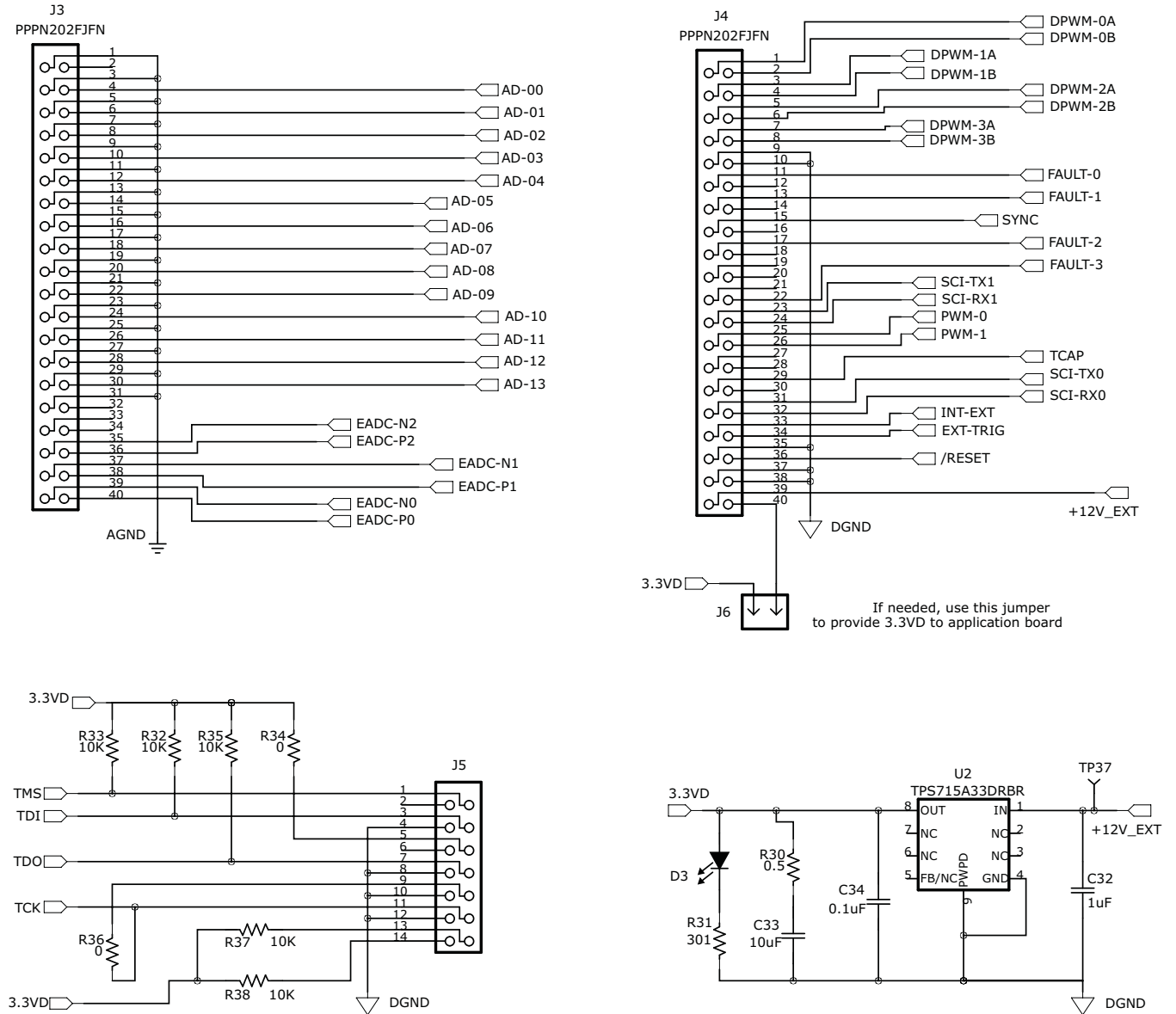

Figure 4. UCD3138CC64EVM-030 Schematic (image 2 of 2)

5 Test Setup

5.1 Test Equipment

DC Voltage Source: capable of 350 V_{DC} to 400 V_{DC}, adjustable, with minimum power rating of 400 W, or current rating not less than 1.5 A, with current limit function. The DC voltage source to be used should meet IEC61010 safety requirements.

DC Multimeter: One unit capable of 0-V_{DC} to 400-V_{DC} input range, four digits display preferred; and one unit capable of 0-V_{DC} to 15-V_{DC} input range, four digits display preferred.

Output Load: DC load capable of receiving 0 V_{DC} to 15 V_{DC}, 0 A to 30 A, and 0 W to 360 W or greater, with display such as load current and load power.

Current-meter, DC, optional in case the load has no display, one unit, capable of 0 A to 30 A. A low ohmic shunt and DMM are recommended.

Oscilloscope: capable of 500-MHz full bandwidth, digital or analog, if digital 5 Gs/s or better.

Fan: 200 LFM to 400 LFM forced air cooling is recommended, but not a must.

Recommended Wire Gauge: capable of 30 A, or better than number 14 AWG, with the total length of wire less than 8 feet (a four foot input and a four foot return).

5.2 Recommended Test Setup

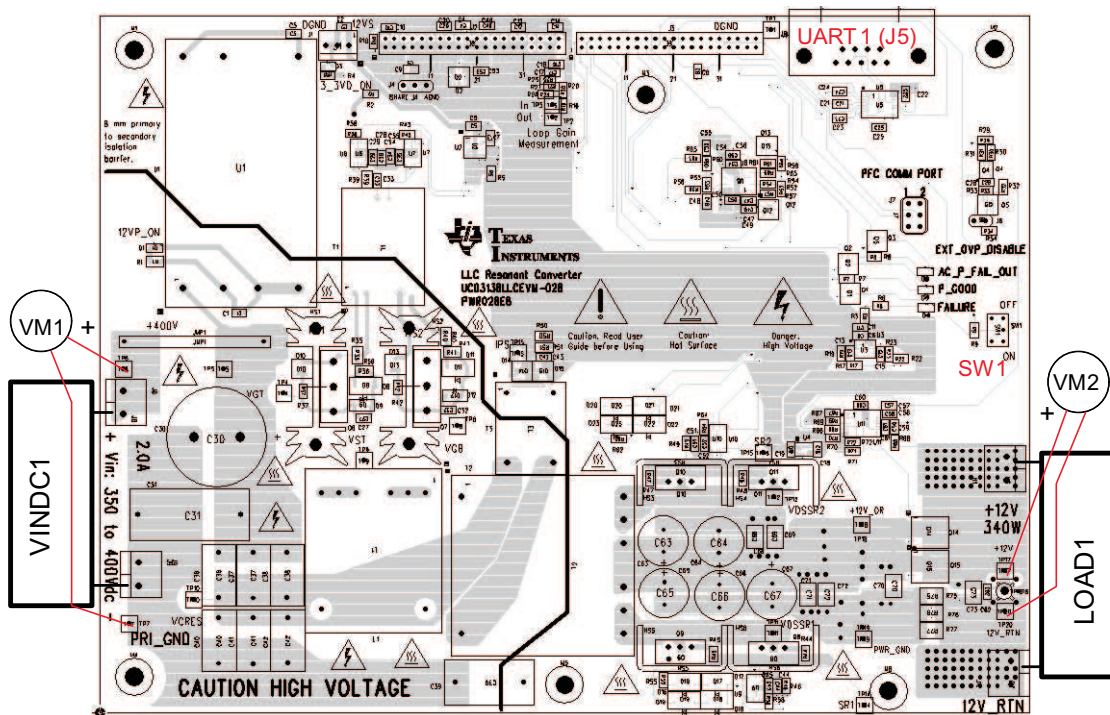

Figure 5. UCD3138LLCEVM-028 Recommended Test Set Up

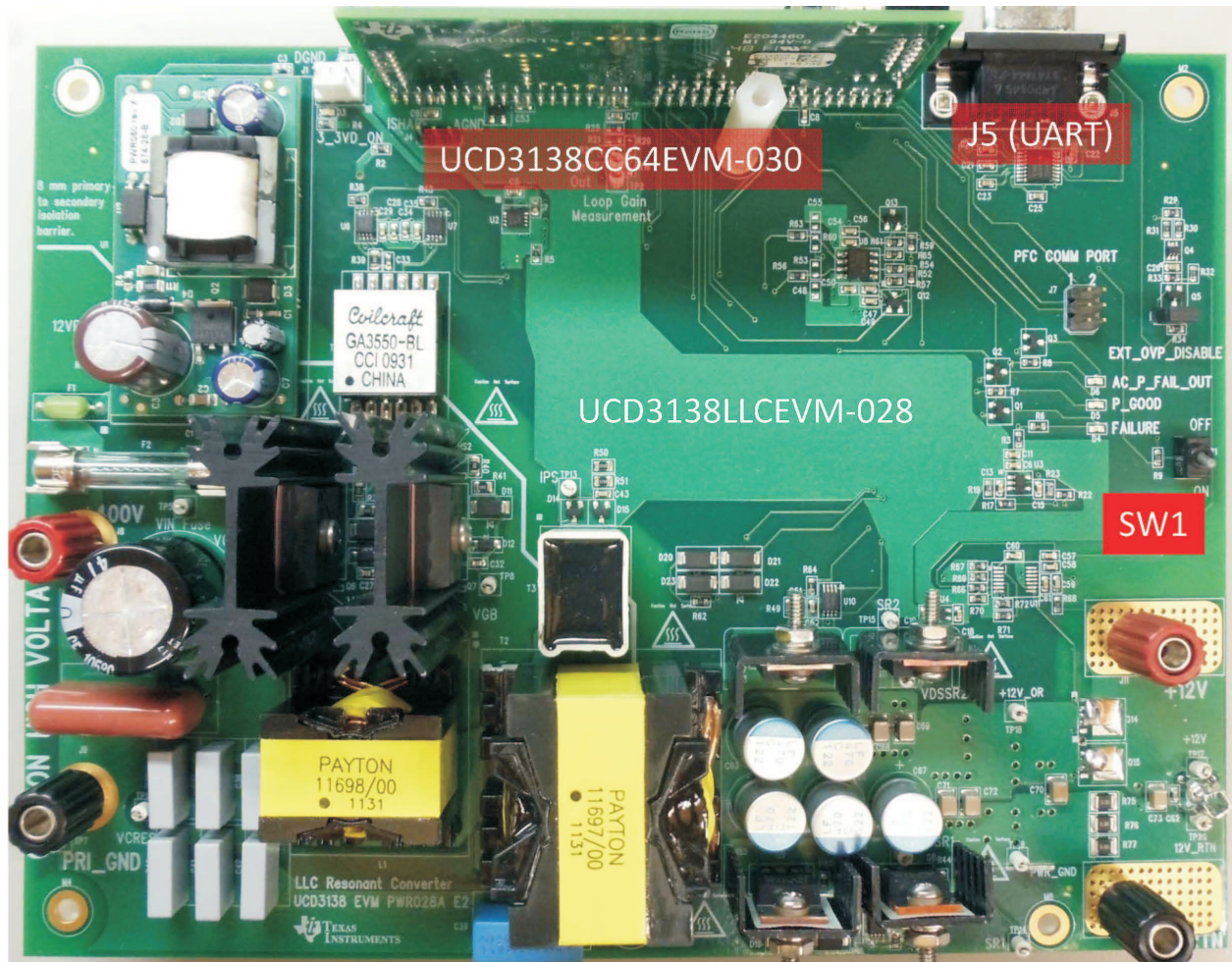

Figure 6. Orientation of Board UCD3138CC64EVM-030 on Board UCD3138LLCEVM-028

6 List of Test Points

Table 2. UCD3138CC64EVM-030 Test Points

TEST POINTS	NAME	DESCRIPTION
TP1	DGND	Digital GND
TP2	Not Used	
TP3	Not Used	
TP4	HSG	Primary high-side MOSFET gate, Q6
TP5	Input +	Input + after jumper J10
TP6	Input_P	Input voltage positive terminal
TP7	Input_N	Input voltage return terminal
TP8	LSG	Primary low-side MOSFET gate, Q7
TP9	HSS	Primary-side switch node, or the intersection of Q6 and Q7
TP10	SWC	Primary side, the intersection of bridge capacitors
TP11	SR_VDS1	Drain of secondary side sync FET Q8 and Q9
TP12	SR_VDS2	Drain of secondary side sync FET Q10 and Q11
TP13	IPS	Primary current sense
TP14	SR1	SR gate drive to Q8 and Q9
TP15	SR2	SR gate drive to Q10 and Q11
TP16	Vo_Ripple	Output voltage ripple
TP17	Vo_P	Output voltage positive terminal
TP18	Xmer_C	Power transformer center point of the secondary side windings.
TP19	GND_PWR	Power GND
TP20	Vo_N	Output voltage return

7 List of Terminals

Table 3. List of Terminals

TERMINAL	NAME	DESCRIPTION
J1	Bias Input	3 pin, external power input, 12 V
J2	Analog Signal	40-pin header, analog signal to control card (UCD3138CC64EVM-030)
J3	Digital Signal	40-pin header, digital signal to control card
J4	AJ	Analog signal connection, 40 pins
J5	UART1	Standard UART connection, RS232, 9 pin
J6	OVP-1	2-pin header, jump across to disable external OVP
J7	Not Used	
J8	Input_P	Input voltage positive terminal
J9	Input_N	Input voltage return terminal
J10	Jumper	Reserved to an input fuse substitution
J11	Output_P	Output voltage positive terminal
J12	Output_N	Output voltage return terminal

8 Test Procedure

8.1 Efficiency Measurement Procedure

WARNING

- Danger of electrical shock! High voltage present during the measurement.
- Do not leave EVM powered when unattended.
- Danger of heat burn from high temperature.

1. Refer to [Figure 5](#) for basic set up to measure power conversion efficiency. The required equipment for this measurement is listed in [Section 5.1](#).
2. Before making electrical connections, visually check the boards to make sure no shipping damage occurred.
3. In this EVM package, three EVMs are included, UCD3138LLCEVM-028, UCD3138CC64EVM-030, and USB-TO-GPIO. For this measurement, the UCD3138LLCEVM-028 and UCD3138CC64EVM-030 boards are needed.
4. First install the UCD3138CC64EVM-030 board onto the UCD3138LLCEVM-028. Care must be taken with the alignment and orientation of the two boards, or damage may occur. Refer to [Figure 6](#) for UCD3138PFCEVM-030 board orientation.
5. Connect the DC voltage source to J8 (+) and J9 (-). The DC voltage source should be isolated and meet IEC61010 requirements. Set up the DC output voltage in the range specified in [Table 1](#), between 350 V_{DC} and 400 V_{DC}; set up the DC source current limit 1.2 A.

NOTE: The board has no fuse installed and relies on the external voltage source current limit for circuit protection.

6. Connect an electronic load with either constant-current mode or constant-resistance mode. The load range is from zero to 29 A.
7. Check and make sure a jumper is installed on J6.
8. It is recommended to use the switch SW1 to turn on the board output after the input voltage is applied to the board. Before applying input voltage, make sure the switch, SW1, is in the *OFF* position.
9. If the load does not have a current or a power display, a current meter or low ohmic shunt and DMM is needed between the load and the board for current measurements.
10. Connect a volt-meter across the output connector and set the volt-meter scale 0 V to 15 V on its voltage, DC.
11. Turn on the DC voltage source output, flip SW1 to *ON* and vary the load. Record output voltage and current measurements.

8.2 Equipment Shutdown

1. Shut down the DC voltage source.
2. Shut down the electronic load.

9 Performance Data and Typical Characteristic Curves

Figure 7 through Figure 20 present typical performance curves for UCD3138LLCEVM-028.

9.1 Efficiency

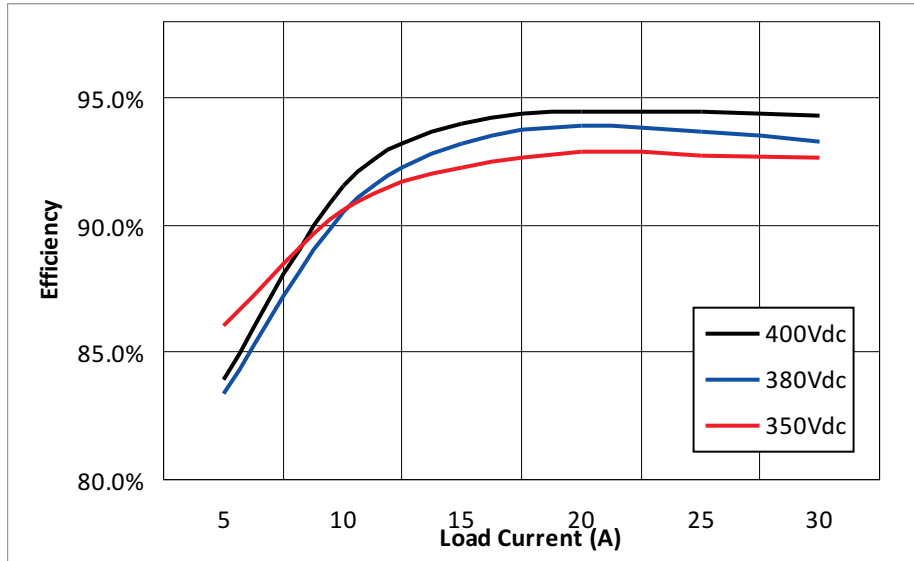

Figure 7. UCD3138LLCEVM-028 Efficiency

9.2 Load Regulation

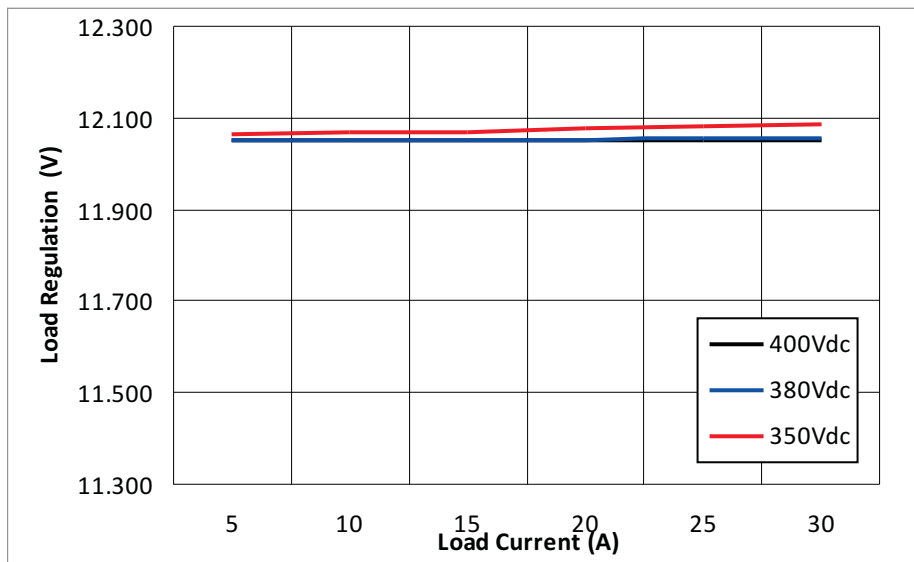

Figure 8. UCD3138LLCEVM-028 Load Regulation

9.3 Switching Frequency Control

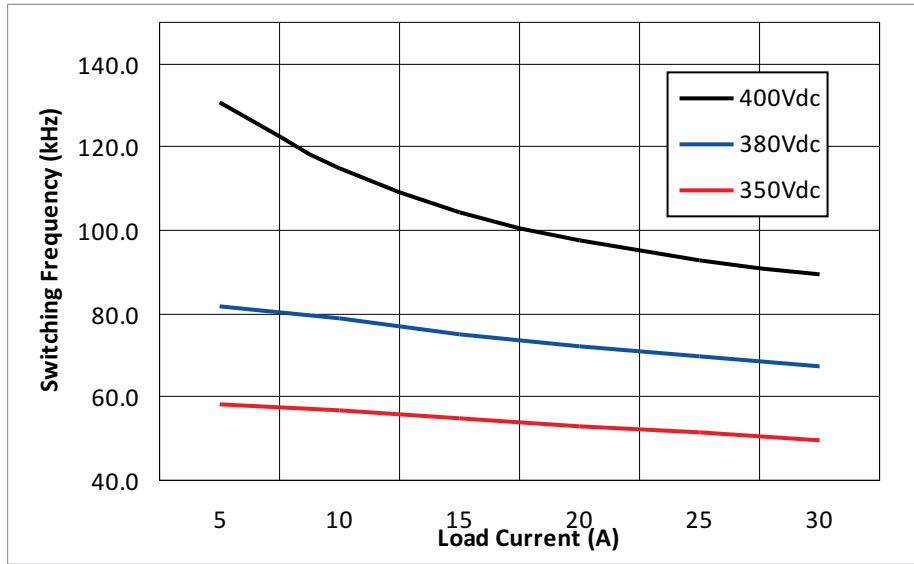

Figure 9. Switching Frequency Control in LLC Mode

9.4 Load Operation with LLC and PWM

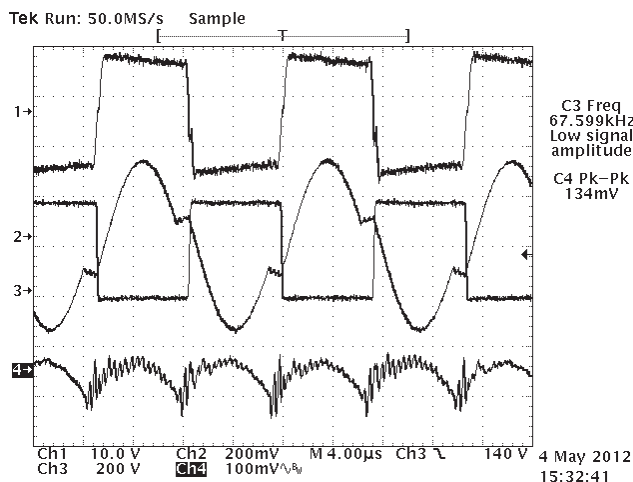

Figure 10. LLC Resonant Mode Operation at Full Load (Ch1 = V_{GS} of Q7, Ch2 = current in resonant network, 2 A/div, Ch3 = V_{DS} of Q7, Ch4 = V_o ripple)

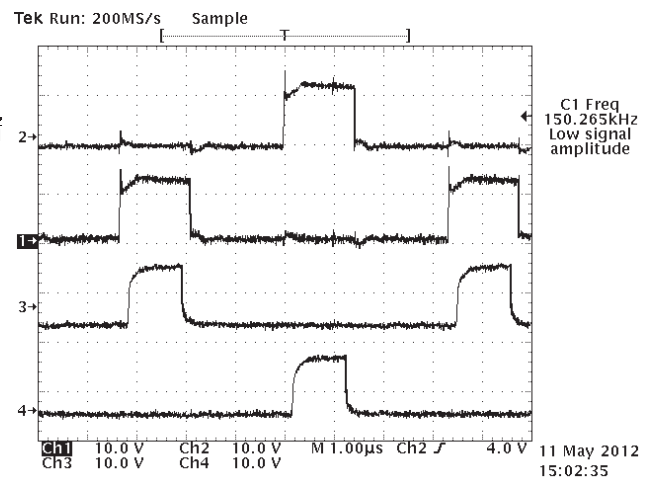

Figure 11. PWM Mode Operation after $F_{sw} = 150$ kHz (Ch1 = V_{GS} of Q7, Ch2 = V_{GS} of Q6, Ch3 = V_{GS} of SR2, Ch4 = V_{GS} of SR3)

9.5 Very Light-Load Operation at High Line of Input

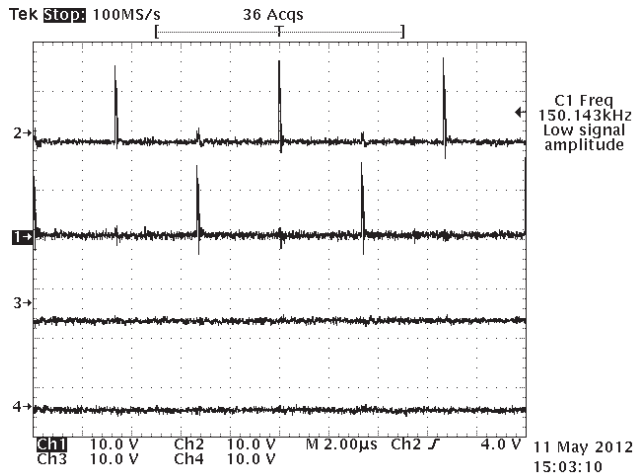

Figure 12. PWM Control at 400VDC Input and Light Load (SR off)
(Ch1 = V_{GS} , Q7, Ch2 = V_{GS} , Q6, Ch3 = V_{GS} , SR1, Ch4 = V_{GS} , SR2)

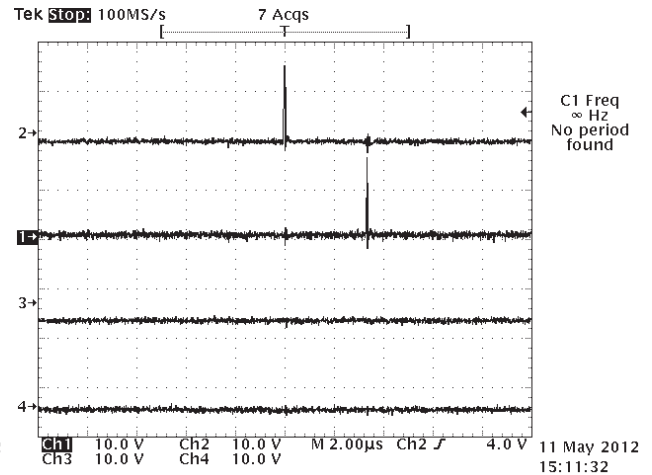

Figure 13. PWM Control with SR Off and Pulse Skipping
(Ch1 = V_{GS} , Q7, Ch2 = V_{GS} , Q6, Ch3 = V_{GS} , SR1, Ch4 = V_{GS} , SR2)

9.6 Output Voltage Ripple

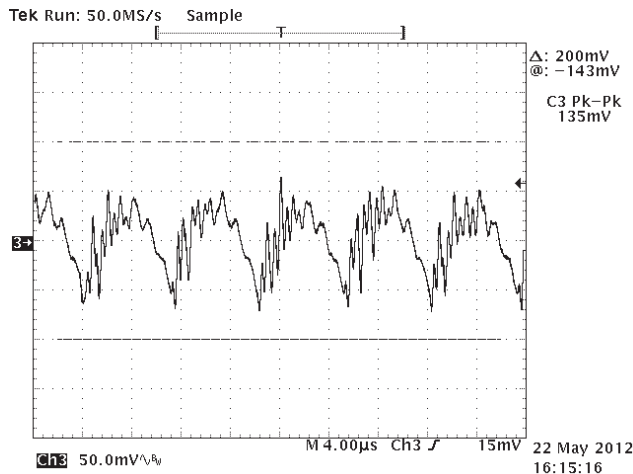

Figure 14. Output Voltage Ripple 380 V_{DC} and Full Load

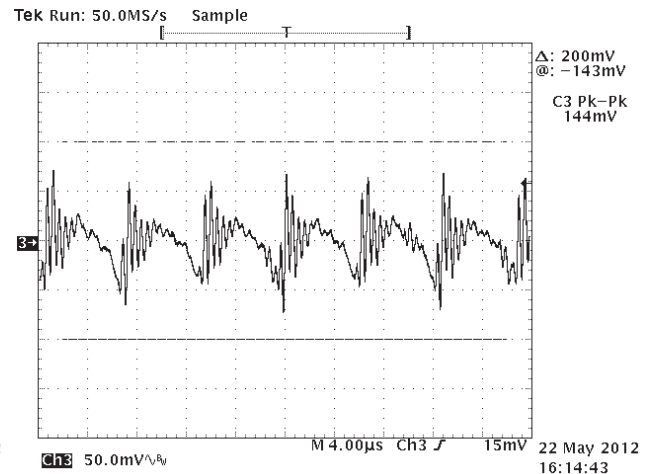

Figure 15. Output Voltage Ripple 380 V_{DC} and Half Load

9.7 Output Turn On

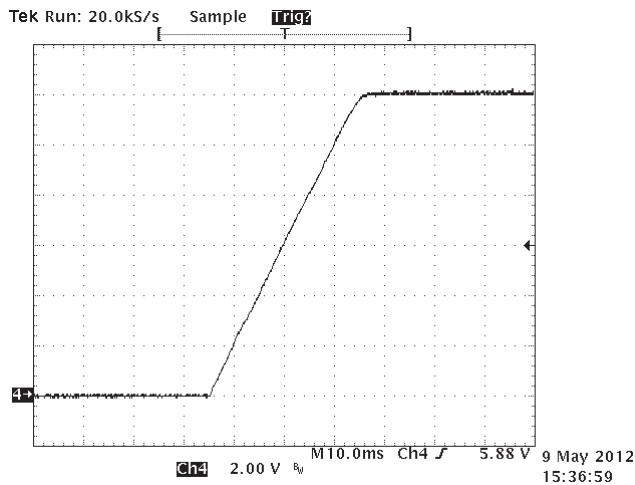

Figure 16. Output Turn On 380 V_{DC} with Load Range

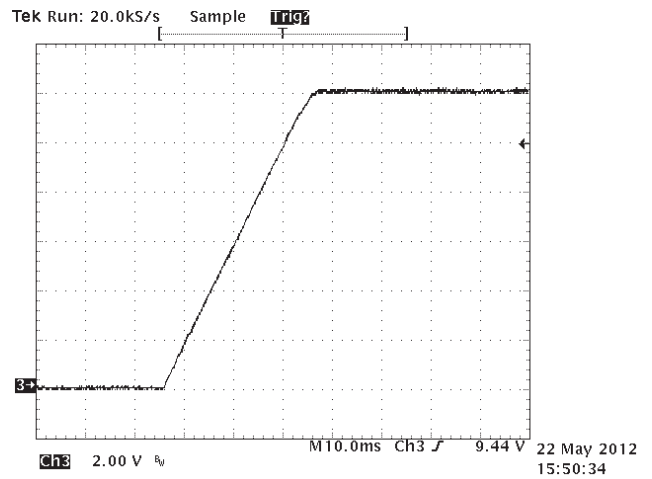

Figure 17. Output Turn On 350 V_{DC} with Load Range

9.8 Other Waveforms

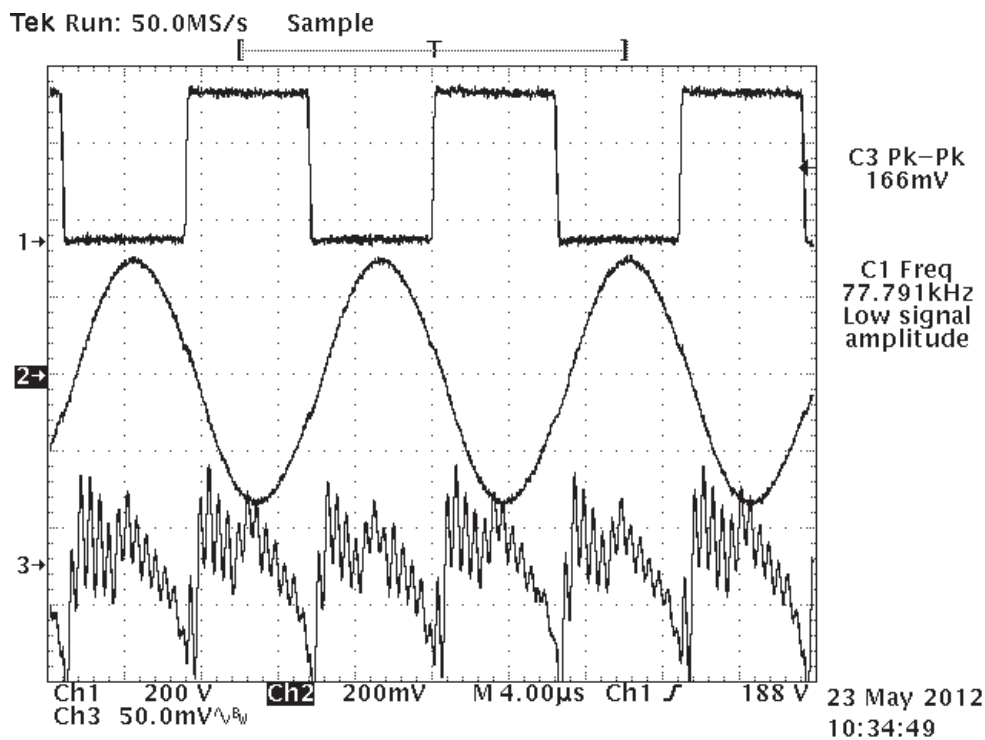

Figure 18. 380 V_{DC} and 30 A Before OCP Latch-Off Shutdown
(Ch1 = V_{DS} of Q7, Ch2 = current of resonant network, Ch3 = V_o ripple)

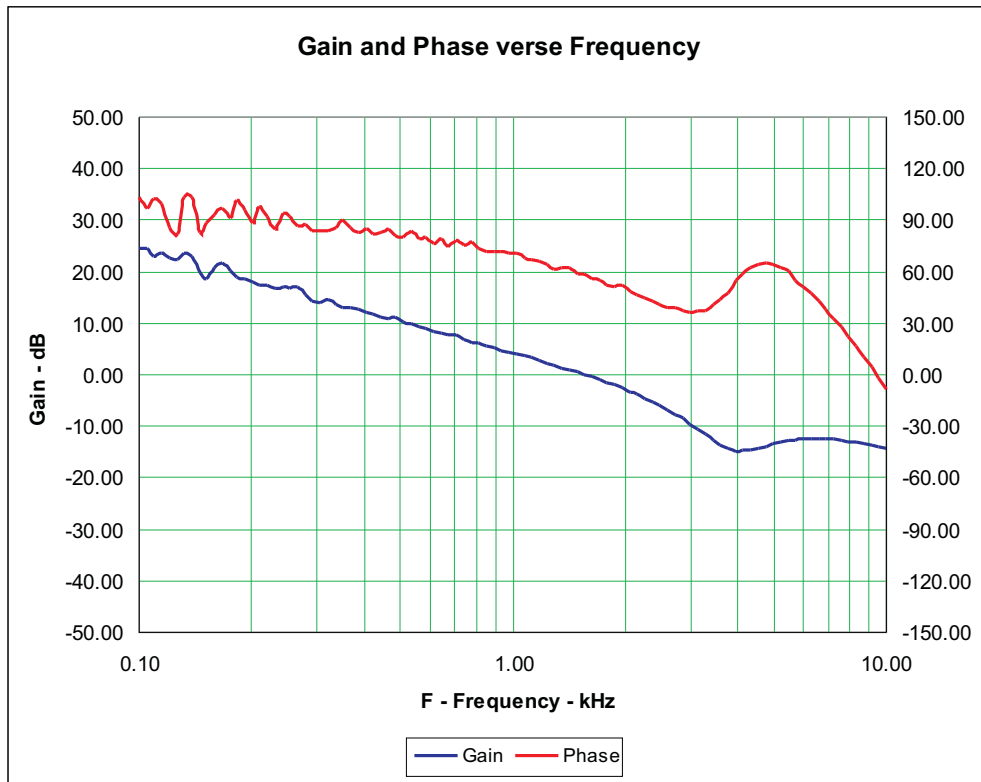

Figure 19. Control Loop Bode Plots at 380 V_{DC} and Full Load

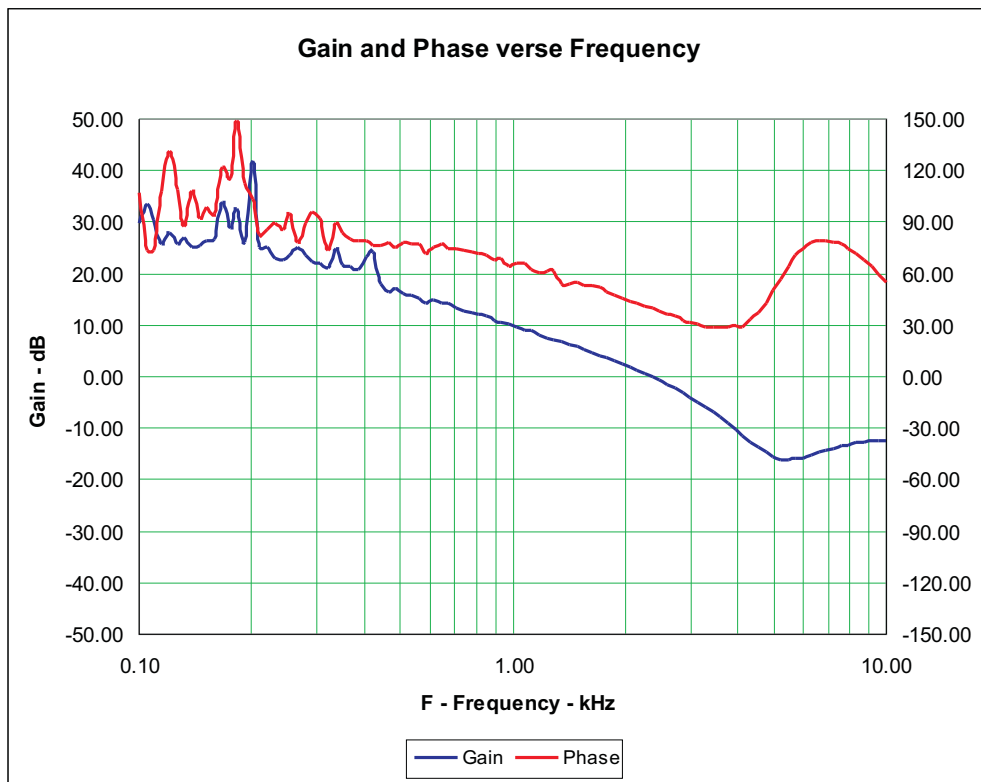

Figure 20. Control Loop Bode Plots at 400 V_{DC} and Full Load

10 EVM Assembly Drawing and PCB layout

The following figures (Figure 21 through Figure 26) show the design of the UCD3138LLCEVM-028 printed circuit board. PCB dimensions: L x W = 8.0 inch x 6.0 inch, PCB material: FR4 or compatible, four layers and 2-ounce copper on each layer

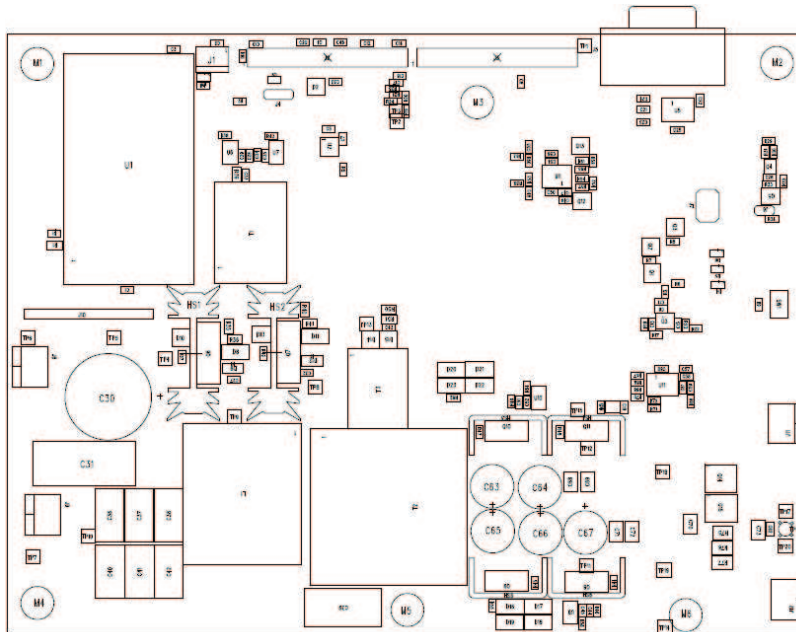

Figure 21. UCD3138LLCEVM-028 Top Layer Assembly Drawing (top view)

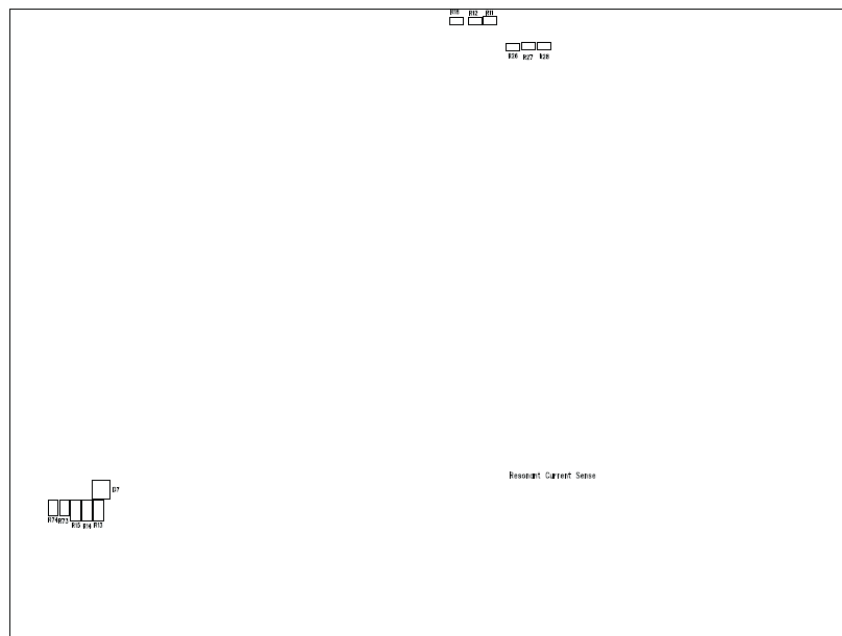

Figure 22. UCD3138LLCEVM-028 Bottom Assembly Drawing (bottom view)

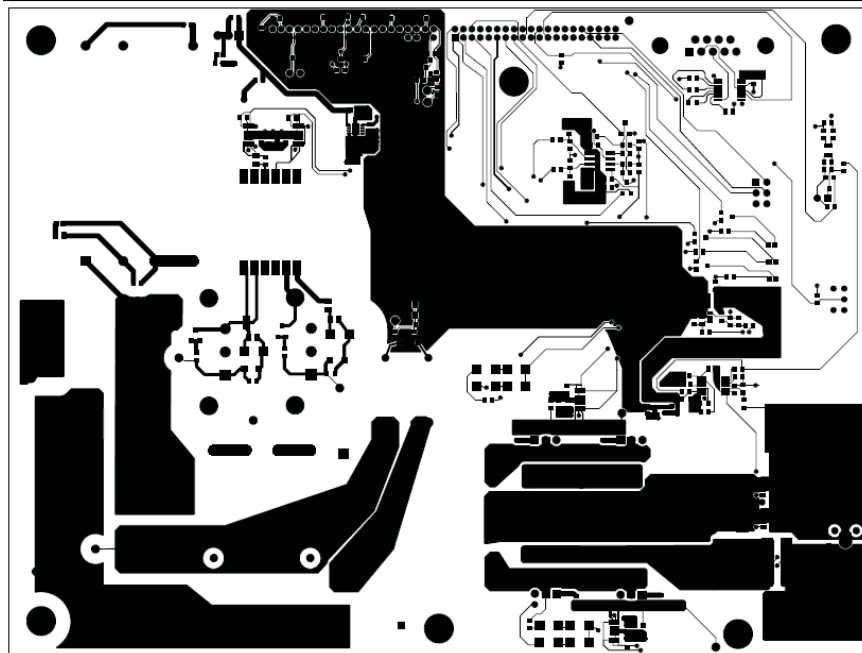

Figure 23. UCD3138LLCEVM-028 Top Copper (top view)

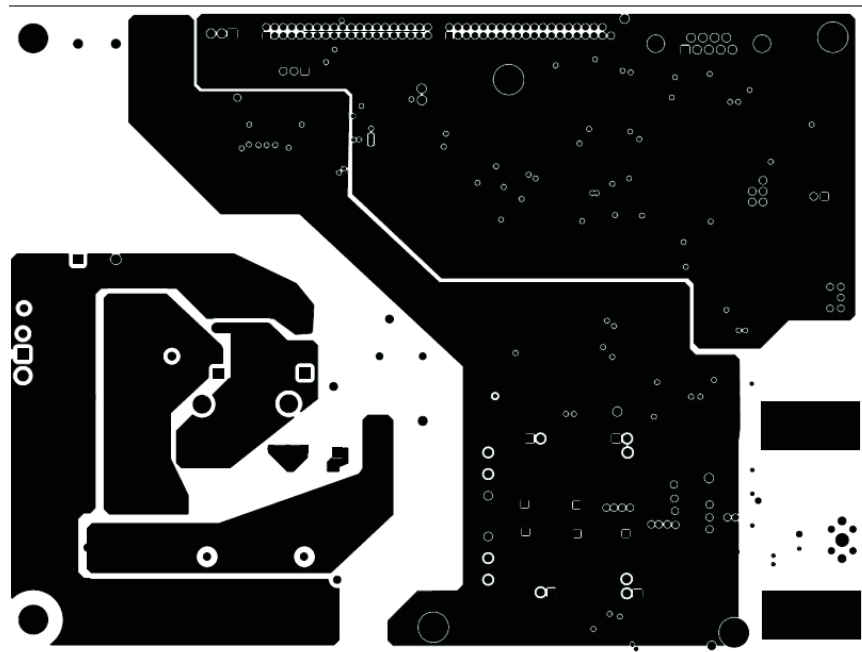

Figure 24. UCD3138LLCEVM-028 Internal Layer 1 (top view)

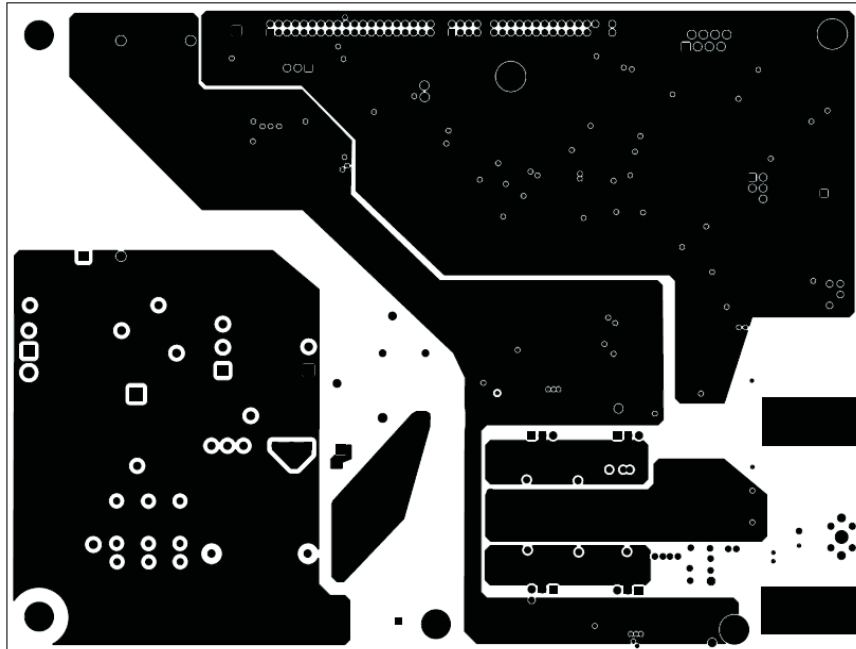

Figure 25. UCD3138LLCEVM-028 Internal Layer 2 (top view)

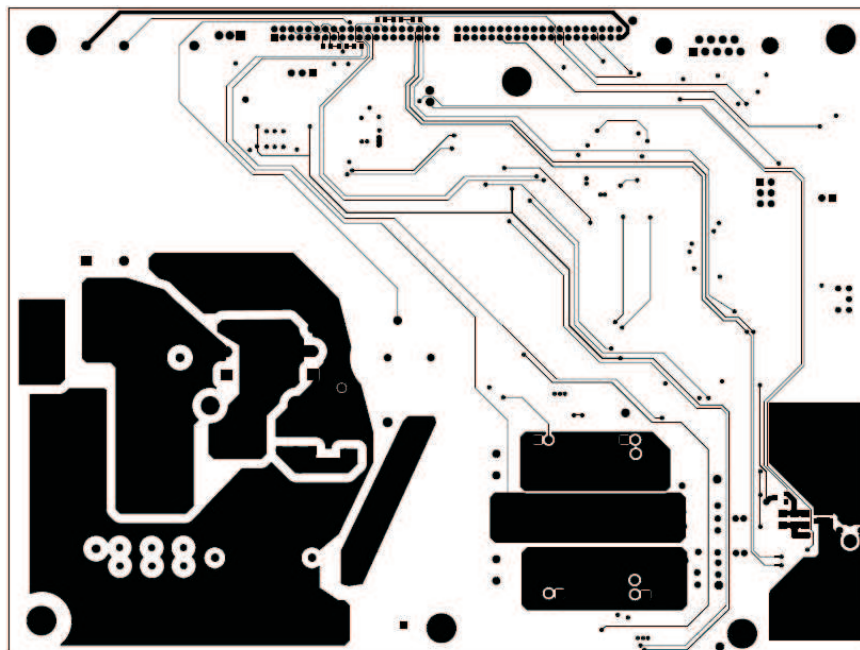

Figure 26. UCD3138LLCEVM-028 Bottom Copper (top view)

11 List of Materials

Component list based on [Figure 1](#) and [Figure 2](#)

Table 4. UCD3138LLCEVM-028 List of Materials

QTY	REF DES	DESCRIPTION	PART NUMBER	MFR
22	C1, C2, C4, C5, C6, C8, C11, C12, C21, C22, C23, C24, C25, C26, C27, C29, C32, C35, C45, C50, C52, C62	Capacitor, ceramic, 16 V, X7R, 10%, 0.1 μ F, 0603	STD	STD
0	C10, C48, C55	Capacitor, ceramic, 6.3 V, X7R, 10%, open, 0603	STD	STD
2	C13, C15	Capacitor, ceramic, 50 V, X7R, 10%, 220 pF, 0603	STD	STD
4	C16, C17, C20, C57	Capacitor, ceramic, 50 V, X7R, 10%, 2200 pF, 0603	STD	STD
6	C3, C28, C33, C34, C44, C51	Capacitor, ceramic, 16 V, X5R, 10%, 2.2 μ F, 0603	STD	STD
1	C30	Capacitor, aluminum electrolytic, 450 V, \pm 20%, 47 μ F, 10 mm x 20 mm	LGU2W470MELY	NichiCon
1	C31	Capacitor, polyester, 450 V, \pm 10%, 1.5 μ F, 1.012 inch x 0.322 inch	ECQ-E2W155KH	Panasonic
6	C36, C37, C38, C40, C41, C42	Capacitor, film, TH, \pm 5%, 630 V, 0.015 μ F, 5.9 mm x 12.5 mm	ECWF6153JL	Panasonic
1	C39	Capacitor, film 250 V _{AC} , \pm 20%, 0.0022 μ F, 7 mm x 18 mm	B81123C1222M	Epcos
7	C43, C47, C49, C54, C56, C58, C59	Capacitor, ceramic, 16 V, X7R, 10%, 100 pF, 0603	STD	STD
2	C46, C53	Capacitor, ceramic, 16 V, X7R, 10%, 0.01 μ F, 0603	STD	STD
5	C63, C64, C65, C66, C67	Capacitor, electrolytic, 16 V _{DC} , \pm 20%, 470 μ F, 10 mm x 13 mm	PLF1C471MDO1	Nichicon
5	C68, C69, C70, C71, C72	Capacitor, ceramic, 16 V, X5R, \pm 20%, 47 μ F, 1210	STD	STD
1	C7	Capacitor, ceramic, 16 V, X7R, 10%, 1 μ F, 0603	STD	STD
1	C73	Capacitor, ceramic, 16 V, X5R, 10%, 4.7 μ F, 1210	STD	STD
6	C9, C14, C18, C19, C60, C61	Capacitor, ceramic, 16 V, X7R, 10%, 10 nF, 0603	STD	STD
3	D1, D3, D5	Diode, LED, green, 2.1 V, 20 mA, 6 mcd, 0603	LTST-C190GKT	Lite On
2	D10, D13	Diode, switching, dual, 70 V, 250 mA, SOT23	BAV70-V	Zetex
3	D2, D14, D15	Diode, dual Schottky, 200 mA, 30 V, SOT23	BAT54S	Zetex
2	D4, D6	Diode, LED, red, 2.1 V, 20 mA, 6 mcd, 0603	LTST-C190CKT	Lite On
1	D7	Diode, switching, 100 V, 200 mA, SOT23	MMBD914	Fairchild
10	D8, D11, D16, D17, D18, D19, D20, D21, D22, D23	Diode, power Schottky, 1 A, 30 V, SMA	STPS130A	ST
2	D9, D12	Diode, Zener, 20 mA, 2.5 V, SOD123	MMSZ5222BT1G	On Semi
2	HS1, HS2	Heatsink, TO-218, TO-247, vertical mount, 5°C/W, 0.5 inch x 1.38 inch	513201B02500	Aavid
4	HS3, HS4, HS5, HS6	Heatsink, TO-220, vertical mount, 0.5 inch x 0.750 inch	507302B00000	Aavid
1	J1	Connector, friction lock 100-millimeter pitch, 0.230 inch x 0.300 inch	22-27-2031	Molex
1	J10	Jumper, 1.200-inch length, solid tinned copper, AWG 22, noninsulated, AWG 22	8021 000100	Belden
2	J2, J3	Header, 40 pin, 2 mm Pitch, 4.00 mm x 40.00 mm	87758-4016	Molex
1	J4	Header, male 3 pin, 100-millimeter spacing, 0.100 inch x 3 inch	PEC03SAAN	Sullins
1	J5	Connector, 9 pin D, right angle, female, 1.213 mm x 0.510 mm	182-009-213R171	Norcomp

Table 4. UCD3138LLCEVM-028 List of Materials (continued)

QTY	REF DES	DESCRIPTION	PART NUMBER	MFR
1	J6	Header, male 2 pin, 100-millimeter spacing, 0.100 inch x 2 inch	PEC02SAAN	Sullins
0	J7	Header, male 2 x 3 pin, 100-millimeter spacing, open, 0.20 inch x 0.30 inch	PEC03DAAN	Sullins
4	J8, J9, J11, J12	Terminal block, 2 pin, 15 A, 5.1 mm, 0.40 inch x 0.35 inch	ED120/2DS	OST
1	L1	Inductor, resonant, 33 μ H, 20%, 26.6 mm x 34.55 mm	11698	Payton Planar Transformers
6	Q1, Q2, Q3, Q5, Q12, Q13	MOSFET, N-channel, 60 V, 115 mA, 1.2 Ω , SOT23	2N7002	Diodes
0	Q14, Q15	MOSFET, N-channel, 25 V, 33 A, 1.7 m Ω , open, QFN-8 power	CSD16325Q5	TI
1	Q4	Transistor, complementary, NPN/PNP 60 V and 40 V, 600 mA, SOT-363	MMDT4413	Diodes
2	Q6, Q7	MOSFET, N-channel, 650 V, 20.7 A, 0.22 Ω , TO-247	SPW20N60CFD	Infineon
4	Q8, Q9, Q10, Q11	MOSFET, N-channel, 60 V, 195A, 2.4 m Ω , TO-220	IRLB3036GPbF	IR
1	R1	Resistor, chip, 1/10 W, 1%, 1.74 k Ω , 0805	STD	STD
0	R10, R11, R53, R60	Resistor, chip, 1/16 W, 1%, open, 0603	STD	STD
12	R12, R17, R18, R21, R22, R25, R28, R33, R46, R49, R52, R59	Resistor, chip, 1/16 W, 1%, 1 k Ω , 0603	STD	STD
3	R13, R14, R15	Resistor, chip, 1/4 W, 1%, 549 Ω , 1206	STD	STD
4	R16, R27, R30, R31	Resistor, chip, 1/16 W, 1%, 100 Ω , 0603	STD	STD
2	R19, R23	Resistor, chip, 1/16 W, 1%, 35.7 k Ω , 0603	STD	STD
6	R2, R3, R44, R45, R47, R48	Resistor, chip, 1/16 W, 1%, 1 Ω , 0603	STD	STD
13	R20, R24, R26, R34, R38, R43, R56, R58, R63, R64, R66, R69, R72	Resistor, chip, 1/16 W, 1%, 10 k Ω , 0603	STD	STD
2	R29, R32	Resistor, chip, 1/16 W, 1%, 20 k Ω , 0603	STD	STD
2	R35, R40	Resistor, chip, 1/10 W, 1%, 0 Ω , 0805	STD	STD
3	R36, R39, R41	Resistor, chip, 1/10 W, 1%, 10 Ω , 0805	STD	STD
6	R4, R6, R7, R8, R57, R65	Resistor, chip, 1/16 W, 1%, 301 Ω , 0603	STD	STD
2	R5, R67	Resistor, chip, 1/16 W, 1%, 10 Ω , 0603	STD	STD
2	R50, R51	Resistor, chip, 1/10 W, 1%, 124 Ω , 0805	STD	STD
2	R54, R61	Resistor, chip, 1/16 W, 1%, 3.01 k Ω , 0603	STD	STD
2	R55, R62	Resistor, chip, 1/16 W, 1%, 51.1 Ω , 0603	STD	STD
1	R70	Resistor, chip, 1/16 W, 1%, 549 Ω , 0603	STD	STD
1	R71	Resistor, chip, 1/16 W, 1%, 100 k Ω , 0603	STD	STD
2	R73, R74	Resistor, chip, 1/10 W, 1%, 1 k Ω , 0805	STD	STD
3	R75, R76, R77	Resistor, chip, 1/2 W, 1%, 3 m Ω , 1210	STD	STD
4	R9, R37, R42, R68	Resistor, chip, 1/16 W, 1%, 5.11 k Ω , 0603	STD	STD
1	SW1	Switch, on-none-on, 0.28 inch x 0.18 inch	G12AP-RO	NKK
1	T1	Transformer, gate drive, \pm 25%, 460 μ H, 0.685 inch x 0.950 inch	GA3550-BL	Coilcraft
1	T2	Transformer, half-bridge, turns-ratio = 16:1:1, 520 μ H, 35.5 mm x 39.1 mm	11697	Payton Planar Transformers
1	T3	Transformer, current sense, 5mA - 35A, 1:200, 0.570 inch x 0.770 inch	CS4200V-01L	Coilcraft

Table 4. UCD3138LLCEVM-028 List of Materials (continued)

QTY	REF DES	DESCRIPTION	PART NUMBER	MFR
1	U1	Module, 5W, auxiliary bias PS, PCB assembly, 1.200 inch x 2.200 inch	PWR050	TI
0	U11	N+1 and Oring Power Rail Controller, open, TSSOP-14	TPS2411PW	TI
1	U2	High Input Voltage, Micropower, 3.2 μ A at 80 mA LDO, 3.3 V, QFN-8	TPS715A33DRBR	TI
1	U3	Presicion, Low Noise, Low Quiescent Current Op-Amp, SOT23-5	OPA376AIDBVR	TI
1	U4	Micro SMD Temperature Sensor, 2.4 V, 10 μ A, SC70-5	LM20BIM7/NOPB	TI
1	U5	3-V to 5.5V- Single Channel RS-232 Compatible Line Drive/Receiver, TSSOP-16	SN65C3221PW	TI
4	U6, U7, U9, U10	Dual Non-Inverting, 5-A High-Speed, Low-Side MOSFET Driver with Enable, HTSSOP	UCC27524DGN	TI
1	U8	4.5 ns R-R, High-Speed Comparator, SO-8	TLV3502AID	TI
1	U12	Control card, UCD3138 control card, PCB assembly, 3.400x1.800 inch	UCD3138CC64EVM-030	TI

NOTE: PWR050 is a bias board and its design documents can be found from www.ti.com in the UCD3138PFCEVM026 Technical Documents.

12 References

1. UCD3138 Datasheet, [Highly Integrated Digital Controller for Isolated Power](#), (Texas Instruments Literature Number SLUSAP2), 2012
2. UCD3138CC64EVM-030 Evaluation Module and User's Guide, [Programmable Digital Power Controller Control Card Evaluation Module](#), (Texas Instruments Literature Number SLUU886), 2012
3. SEM1900, 2010, [Designing an LLC Resonant Half-Bridge Power Converter](#)
4. TI Application Note, [Feedback Loop Design of an LLC Resonant Power Converter](#), (Texas Instruments Literature Number SLUA582A), November 2010.
5. APEC 2006, *Optimal design methodology for LLC resonant converter*, Bing Lu; Wenduo Liu; Yan Liang; Lee, F.C.; van Wyk, J.D. pages 19-23
6. TI Application Manual, [UCD3138 Digital Power Peripherals Programmer's Manual](#), (Texas Instruments Literature Number SLUU995)
7. TI Application Manual, [UCD3138 Monitoring and Communications Programmer's Manual](#), (Texas Instruments Literature Number SLUU996)
8. TI Application Manual, [UCD3138 ARM and Digital System Programmer's Manual](#), (Texas Instruments Literature Number SLUU994)
9. User Guide, *UCD3138 Isolated Power Fusion GUI*, (please contact TI)

EVALUATION BOARD/KIT/MODULE (EVM) ADDITIONAL TERMS

Texas Instruments (TI) provides the enclosed Evaluation Board/Kit/Module (EVM) under the following conditions:

The user assumes all responsibility and liability for proper and safe handling of the goods. Further, the user indemnifies TI from all claims arising from the handling or use of the goods.

Should this evaluation board/kit not meet the specifications indicated in the User's Guide, the board/kit may be returned within 30 days from the date of delivery for a full refund. THE FOREGOING LIMITED WARRANTY IS THE EXCLUSIVE WARRANTY MADE BY SELLER TO BUYER AND IS IN LIEU OF ALL OTHER WARRANTIES, EXPRESSED, IMPLIED, OR STATUTORY, INCLUDING ANY WARRANTY OF MERCHANTABILITY OR FITNESS FOR ANY PARTICULAR PURPOSE. EXCEPT TO THE EXTENT OF THE INDEMNITY SET FORTH ABOVE, NEITHER PARTY SHALL BE LIABLE TO THE OTHER FOR ANY INDIRECT, SPECIAL, INCIDENTAL, OR CONSEQUENTIAL DAMAGES.

Please read the User's Guide and, specifically, the Warnings and Restrictions notice in the User's Guide prior to handling the product. This notice contains important safety information about temperatures and voltages. For additional information on TI's environmental and/or safety programs, please visit www.ti.com/esh or contact TI.

No license is granted under any patent right or other intellectual property right of TI covering or relating to any machine, process, or combination in which such TI products or services might be or are used. TI currently deals with a variety of customers for products, and therefore our arrangement with the user is not exclusive. TI assumes no liability for applications assistance, customer product design, software performance, or infringement of patents or services described herein.

REGULATORY COMPLIANCE INFORMATION

As noted in the EVM User's Guide and/or EVM itself, this EVM and/or accompanying hardware may or may not be subject to the Federal Communications Commission (FCC) and Industry Canada (IC) rules.

For EVMs **not** subject to the above rules, this evaluation board/kit/module is intended for use for ENGINEERING DEVELOPMENT, DEMONSTRATION OR EVALUATION PURPOSES ONLY and is not considered by TI to be a finished end product fit for general consumer use. It generates, uses, and can radiate radio frequency energy and has not been tested for compliance with the limits of computing devices pursuant to part 15 of FCC or ICES-003 rules, which are designed to provide reasonable protection against radio frequency interference. Operation of the equipment may cause interference with radio communications, in which case the user at his own expense will be required to take whatever measures may be required to correct this interference.

General Statement for EVMs including a radio

User Power/Frequency Use Obligations: This radio is intended for development/professional use only in legally allocated frequency and power limits. Any use of radio frequencies and/or power availability of this EVM and its development application(s) must comply with local laws governing radio spectrum allocation and power limits for this evaluation module. It is the user's sole responsibility to only operate this radio in legally acceptable frequency space and within legally mandated power limitations. Any exceptions to this are strictly prohibited and unauthorized by Texas Instruments unless user has obtained appropriate experimental/development licenses from local regulatory authorities, which is responsibility of user including its acceptable authorization.

For EVMs annotated as FCC – FEDERAL COMMUNICATIONS COMMISSION Part 15 Compliant

Caution

This device complies with part 15 of the FCC Rules. Operation is subject to the following two conditions: (1) This device may not cause harmful interference, and (2) this device must accept any interference received, including interference that may cause undesired operation.

Changes or modifications not expressly approved by the party responsible for compliance could void the user's authority to operate the equipment.

FCC Interference Statement for Class A EVM devices

This equipment has been tested and found to comply with the limits for a Class A digital device, pursuant to part 15 of the FCC Rules. These limits are designed to provide reasonable protection against harmful interference when the equipment is operated in a commercial environment. This equipment generates, uses, and can radiate radio frequency energy and, if not installed and used in accordance with the instruction manual, may cause harmful interference to radio communications. Operation of this equipment in a residential area is likely to cause harmful interference in which case the user will be required to correct the interference at his own expense.

FCC Interference Statement for Class B EVM devices

This equipment has been tested and found to comply with the limits for a Class B digital device, pursuant to part 15 of the FCC Rules. These limits are designed to provide reasonable protection against harmful interference in a residential installation. This equipment generates, uses and can radiate radio frequency energy and, if not installed and used in accordance with the instructions, may cause harmful interference to radio communications. However, there is no guarantee that interference will not occur in a particular installation. If this equipment does cause harmful interference to radio or television reception, which can be determined by turning the equipment off and on, the user is encouraged to try to correct the interference by one or more of the following measures:

- Reorient or relocate the receiving antenna.
- Increase the separation between the equipment and receiver.
- Connect the equipment into an outlet on a circuit different from that to which the receiver is connected.
- Consult the dealer or an experienced radio/TV technician for help.

For EVMs annotated as IC – INDUSTRY CANADA Compliant

This Class A or B digital apparatus complies with Canadian ICES-003.

Changes or modifications not expressly approved by the party responsible for compliance could void the user's authority to operate the equipment.

Concerning EVMs including radio transmitters

This device complies with Industry Canada licence-exempt RSS standard(s). Operation is subject to the following two conditions: (1) this device may not cause interference, and (2) this device must accept any interference, including interference that may cause undesired operation of the device.

Concerning EVMs including detachable antennas

Under Industry Canada regulations, this radio transmitter may only operate using an antenna of a type and maximum (or lesser) gain approved for the transmitter by Industry Canada. To reduce potential radio interference to other users, the antenna type and its gain should be so chosen that the equivalent isotropically radiated power (e.i.r.p.) is not more than that necessary for successful communication.

This radio transmitter has been approved by Industry Canada to operate with the antenna types listed in the user guide with the maximum permissible gain and required antenna impedance for each antenna type indicated. Antenna types not included in this list, having a gain greater than the maximum gain indicated for that type, are strictly prohibited for use with this device.

Cet appareil numérique de la classe A ou B est conforme à la norme NMB-003 du Canada.

Les changements ou les modifications pas expressément approuvés par la partie responsable de la conformité ont pu vider l'autorité de l'utilisateur pour actionner l'équipement.

Concernant les EVMs avec appareils radio

Le présent appareil est conforme aux CNR d'Industrie Canada applicables aux appareils radio exempts de licence. L'exploitation est autorisée aux deux conditions suivantes : (1) l'appareil ne doit pas produire de brouillage, et (2) l'utilisateur de l'appareil doit accepter tout brouillage radioélectrique subi, même si le brouillage est susceptible d'en compromettre le fonctionnement.

Concernant les EVMs avec antennes détachables

Conformément à la réglementation d'Industrie Canada, le présent émetteur radio peut fonctionner avec une antenne d'un type et d'un gain maximal (ou inférieur) approuvé pour l'émetteur par Industrie Canada. Dans le but de réduire les risques de brouillage radioélectrique à l'intention des autres utilisateurs, il faut choisir le type d'antenne et son gain de sorte que la puissance isotrope rayonnée équivalente (p.i.r.e.) ne dépasse pas l'intensité nécessaire à l'établissement d'une communication satisfaisante.

Le présent émetteur radio a été approuvé par Industrie Canada pour fonctionner avec les types d'antenne énumérés dans le manuel d'usage et ayant un gain admissible maximal et l'impédance requise pour chaque type d'antenne. Les types d'antenne non inclus dans cette liste, ou dont le gain est supérieur au gain maximal indiqué, sont strictement interdits pour l'exploitation de l'émetteur.

【Important Notice for Users of EVMs for RF Products in Japan】

This development kit is NOT certified as Confirming to Technical Regulations of Radio Law of Japan

If you use this product in Japan, you are required by Radio Law of Japan to follow the instructions below with respect to this product:

1. Use this product in a shielded room or any other test facility as defined in the notification #173 issued by Ministry of Internal Affairs and Communications on March 28, 2006, based on Sub-section 1.1 of Article 6 of the Ministry's Rule for Enforcement of Radio Law of Japan,
2. Use this product only after you obtained the license of Test Radio Station as provided in Radio Law of Japan with respect to this product, or
3. Use of this product only after you obtained the Technical Regulations Conformity Certification as provided in Radio Law of Japan with respect to this product. Also, please do not transfer this product, unless you give the same notice above to the transferee. Please note that if you could not follow the instructions above, you will be subject to penalties of Radio Law of Japan.

Texas Instruments Japan Limited
(address) 24-1, Nishi-Shinjuku 6 chome, Shinjuku-ku, Tokyo, Japan

<http://www.tij.co.jp>

【無線電波を送信する製品の開発キットをお使いになる際の注意事項】

本開発キットは技術基準適合証明を受けておりません。

本製品のご使用に際しては、電波法遵守のため、以下のいずれかの措置を取っていただく必要がありますのでご注意ください。

1. 電波法施行規則第6条第1項第1号に基づく平成18年3月28日総務省告示第173号で定められた電波暗室等の試験設備でご使用いただく。
2. 実験局の免許を取得後ご使用いただく。
3. 技術基準適合証明を取得後ご使用いただく。

なお、本製品は、上記の「ご使用にあたっての注意」を譲渡先、移転先に通知しない限り、譲渡、移転できないものとします。

上記を遵守頂けない場合は、電波法の罰則が適用される可能性があることをご留意ください。

日本テキサス・インスツルメンツ株式会社
東京都新宿区西新宿 6 丁目 2 4 番 1 号
西新宿三井ビル

<http://www.tij.co.jp>

EVALUATION BOARD/KIT/MODULE (EVM) WARNINGS, RESTRICTIONS AND DISCLAIMERS

For Feasibility Evaluation Only, in Laboratory/Development Environments. Unless otherwise indicated, this EVM is not a finished electrical equipment and not intended for consumer use. It is intended solely for use for preliminary feasibility evaluation in laboratory/development environments by technically qualified electronics experts who are familiar with the dangers and application risks associated with handling electrical mechanical components, systems and subsystems. It should not be used as all or part of a finished end product.

Your Sole Responsibility and Risk. You acknowledge, represent and agree that:

1. You have unique knowledge concerning Federal, State and local regulatory requirements (including but not limited to Food and Drug Administration regulations, if applicable) which relate to your products and which relate to your use (and/or that of your employees, affiliates, contractors or designees) of the EVM for evaluation, testing and other purposes.
2. You have full and exclusive responsibility to assure the safety and compliance of your products with all such laws and other applicable regulatory requirements, and also to assure the safety of any activities to be conducted by you and/or your employees, affiliates, contractors or designees, using the EVM. Further, you are responsible to assure that any interfaces (electronic and/or mechanical) between the EVM and any human body are designed with suitable isolation and means to safely limit accessible leakage currents to minimize the risk of electrical shock hazard.
3. Since the EVM is not a completed product, it may not meet all applicable regulatory and safety compliance standards (such as UL, CSA, VDE, CE, RoHS and WEEE) which may normally be associated with similar items. You assume full responsibility to determine and/or assure compliance with any such standards and related certifications as may be applicable. You will employ reasonable safeguards to ensure that your use of the EVM will not result in any property damage, injury or death, even if the EVM should fail to perform as described or expected.
4. You will take care of proper disposal and recycling of the EVM's electronic components and packing materials.

Certain Instructions. It is important to operate this EVM within TI's recommended specifications and environmental considerations per the user guidelines. Exceeding the specified EVM ratings (including but not limited to input and output voltage, current, power, and environmental ranges) may cause property damage, personal injury or death. If there are questions concerning these ratings please contact a TI field representative prior to connecting interface electronics including input power and intended loads. Any loads applied outside of the specified output range may result in unintended and/or inaccurate operation and/or possible permanent damage to the EVM and/or interface electronics. Please consult the EVM User's Guide prior to connecting any load to the EVM output. If there is uncertainty as to the load specification, please contact a TI field representative. During normal operation, some circuit components may have case temperatures greater than 60°C as long as the input and output are maintained at a normal ambient operating temperature. These components include but are not limited to linear regulators, switching transistors, pass transistors, and current sense resistors which can be identified using the EVM schematic located in the EVM User's Guide. When placing measurement probes near these devices during normal operation, please be aware that these devices may be very warm to the touch. As with all electronic evaluation tools, only qualified personnel knowledgeable in electronic measurement and diagnostics normally found in development environments should use these EVMs.

Agreement to Defend, Indemnify and Hold Harmless. You agree to defend, indemnify and hold TI, its licensors and their representatives harmless from and against any and all claims, damages, losses, expenses, costs and liabilities (collectively, "Claims") arising out of or in connection with any use of the EVM that is not in accordance with the terms of the agreement. This obligation shall apply whether Claims arise under law of tort or contract or any other legal theory, and even if the EVM fails to perform as described or expected.

Safety-Critical or Life-Critical Applications. If you intend to evaluate the components for possible use in safety critical applications (such as life support) where a failure of the TI product would reasonably be expected to cause severe personal injury or death, such as devices which are classified as FDA Class III or similar classification, then you must specifically notify TI of such intent and enter into a separate Assurance and Indemnity Agreement.

Mailing Address: Texas Instruments, Post Office Box 655303, Dallas, Texas 75265
Copyright © 2013, Texas Instruments Incorporated

IMPORTANT NOTICE

Texas Instruments Incorporated and its subsidiaries (TI) reserve the right to make corrections, enhancements, improvements and other changes to its semiconductor products and services per JESD46, latest issue, and to discontinue any product or service per JESD48, latest issue. Buyers should obtain the latest relevant information before placing orders and should verify that such information is current and complete. All semiconductor products (also referred to herein as "components") are sold subject to TI's terms and conditions of sale supplied at the time of order acknowledgment.

TI warrants performance of its components to the specifications applicable at the time of sale, in accordance with the warranty in TI's terms and conditions of sale of semiconductor products. Testing and other quality control techniques are used to the extent TI deems necessary to support this warranty. Except where mandated by applicable law, testing of all parameters of each component is not necessarily performed.

TI assumes no liability for applications assistance or the design of Buyers' products. Buyers are responsible for their products and applications using TI components. To minimize the risks associated with Buyers' products and applications, Buyers should provide adequate design and operating safeguards.

TI does not warrant or represent that any license, either express or implied, is granted under any patent right, copyright, mask work right, or other intellectual property right relating to any combination, machine, or process in which TI components or services are used. Information published by TI regarding third-party products or services does not constitute a license to use such products or services or a warranty or endorsement thereof. Use of such information may require a license from a third party under the patents or other intellectual property of the third party, or a license from TI under the patents or other intellectual property of TI.

Reproduction of significant portions of TI information in TI data books or data sheets is permissible only if reproduction is without alteration and is accompanied by all associated warranties, conditions, limitations, and notices. TI is not responsible or liable for such altered documentation. Information of third parties may be subject to additional restrictions.

Resale of TI components or services with statements different from or beyond the parameters stated by TI for that component or service voids all express and any implied warranties for the associated TI component or service and is an unfair and deceptive business practice. TI is not responsible or liable for any such statements.

Buyer acknowledges and agrees that it is solely responsible for compliance with all legal, regulatory and safety-related requirements concerning its products, and any use of TI components in its applications, notwithstanding any applications-related information or support that may be provided by TI. Buyer represents and agrees that it has all the necessary expertise to create and implement safeguards which anticipate dangerous consequences of failures, monitor failures and their consequences, lessen the likelihood of failures that might cause harm and take appropriate remedial actions. Buyer will fully indemnify TI and its representatives against any damages arising out of the use of any TI components in safety-critical applications.

In some cases, TI components may be promoted specifically to facilitate safety-related applications. With such components, TI's goal is to help enable customers to design and create their own end-product solutions that meet applicable functional safety standards and requirements. Nonetheless, such components are subject to these terms.

No TI components are authorized for use in FDA Class III (or similar life-critical medical equipment) unless authorized officers of the parties have executed a special agreement specifically governing such use.

Only those TI components which TI has specifically designated as military grade or "enhanced plastic" are designed and intended for use in military/aerospace applications or environments. Buyer acknowledges and agrees that any military or aerospace use of TI components which have **not** been so designated is solely at the Buyer's risk, and that Buyer is solely responsible for compliance with all legal and regulatory requirements in connection with such use.

TI has specifically designated certain components as meeting ISO/TS16949 requirements, mainly for automotive use. In any case of use of non-designated products, TI will not be responsible for any failure to meet ISO/TS16949.

Products

Audio	www.ti.com/audio
Amplifiers	amplifier.ti.com
Data Converters	dataconverter.ti.com
DLP® Products	www.dlp.com
DSP	dsp.ti.com
Clocks and Timers	www.ti.com/clocks
Interface	interface.ti.com
Logic	logic.ti.com
Power Mgmt	power.ti.com
Microcontrollers	microcontroller.ti.com
RFID	www.ti-rfid.com
OMAP Applications Processors	www.ti.com/omap
Wireless Connectivity	www.ti.com/wirelessconnectivity

Applications

Automotive and Transportation	www.ti.com/automotive
Communications and Telecom	www.ti.com/communications
Computers and Peripherals	www.ti.com/computers
Consumer Electronics	www.ti.com/consumer-apps
Energy and Lighting	www.ti.com/energy
Industrial	www.ti.com/industrial
Medical	www.ti.com/medical
Security	www.ti.com/security
Space, Avionics and Defense	www.ti.com/space-avionics-defense
Video and Imaging	www.ti.com/video

TI E2E Community

e2e.ti.com