

***TPS54373EVM-237 3-Amp
SWIFT™ Regulator With
Disabled Sink During Start-Up
Evaluation Module***

User's Guide

IMPORTANT NOTICE

Texas Instruments Incorporated and its subsidiaries (TI) reserve the right to make corrections, modifications, enhancements, improvements, and other changes to its products and services at any time and to discontinue any product or service without notice. Customers should obtain the latest relevant information before placing orders and should verify that such information is current and complete. All products are sold subject to TI's terms and conditions of sale supplied at the time of order acknowledgment.

TI warrants performance of its hardware products to the specifications applicable at the time of sale in accordance with TI's standard warranty. Testing and other quality control techniques are used to the extent TI deems necessary to support this warranty. Except where mandated by government requirements, testing of all parameters of each product is not necessarily performed.

TI assumes no liability for applications assistance or customer product design. Customers are responsible for their products and applications using TI components. To minimize the risks associated with customer products and applications, customers should provide adequate design and operating safeguards.

TI does not warrant or represent that any license, either express or implied, is granted under any TI patent right, copyright, mask work right, or other TI intellectual property right relating to any combination, machine, or process in which TI products or services are used. Information published by TI regarding third-party products or services does not constitute a license from TI to use such products or services or a warranty or endorsement thereof. Use of such information may require a license from a third party under the patents or other intellectual property of the third party, or a license from TI under the patents or other intellectual property of TI.

Reproduction of information in TI data books or data sheets is permissible only if reproduction is without alteration and is accompanied by all associated warranties, conditions, limitations, and notices. Reproduction of this information with alteration is an unfair and deceptive business practice. TI is not responsible or liable for such altered documentation.

Resale of TI products or services with statements different from or beyond the parameters stated by TI for that product or service voids all express and any implied warranties for the associated TI product or service and is an unfair and deceptive business practice. TI is not responsible or liable for any such statements.

Following are URLs where you can obtain information on other Texas Instruments products & application solutions:

Products		Applications	
Amplifiers	amplifier.ti.com	Audio	www.ti.com/audio
Data Converters	dataconverter.ti.com	Automotive	www.ti.com/automotive
DSP	dsp.ti.com	Broadband	www.ti.com/broadband
Interface	interface.ti.com	Digital Control	www.ti.com/digitalcontrol
Logic	logic.ti.com	Military	www.ti.com/military
Power Mgmt	power.ti.com	Optical Networking	www.ti.com/opticalnetwork
Microcontrollers	microcontroller.ti.com	Security	www.ti.com/security
		Telephony	www.ti.com/telephony
		Video & Imaging	www.ti.com/video
		Wireless	www.ti.com/wireless

Mailing Address: Texas Instruments
Post Office Box 655303 Dallas, Texas 75265

EVM IMPORTANT NOTICE

Texas Instruments (TI) provides the enclosed product(s) under the following conditions:

This evaluation kit being sold by TI is intended for use for **ENGINEERING DEVELOPMENT OR EVALUATION PURPOSES ONLY** and is not considered by TI to be fit for commercial use. As such, the goods being provided may not be complete in terms of required design-, marketing-, and/or manufacturing-related protective considerations, including product safety measures typically found in the end product incorporating the goods. As a prototype, this product does not fall within the scope of the European Union directive on electromagnetic compatibility and therefore may not meet the technical requirements of the directive.

Should this evaluation kit not meet the specifications indicated in the EVM User's Guide, the kit may be returned within 30 days from the date of delivery for a full refund. **THE FOREGOING WARRANTY IS THE EXCLUSIVE WARRANTY MADE BY SELLER TO BUYER AND IS IN LIEU OF ALL OTHER WARRANTIES, EXPRESSED, IMPLIED, OR STATUTORY, INCLUDING ANY WARRANTY OF MERCHANTABILITY OR FITNESS FOR ANY PARTICULAR PURPOSE.**

The user assumes all responsibility and liability for proper and safe handling of the goods. Further, the user indemnifies TI from all claims arising from the handling or use of the goods. Please be aware that the products received may not be regulatory compliant or agency certified (FCC, UL, CE, etc.). Due to the open construction of the product, it is the user's responsibility to take any and all appropriate precautions with regard to electrostatic discharge.

EXCEPT TO THE EXTENT OF THE INDEMNITY SET FORTH ABOVE, NEITHER PARTY SHALL BE LIABLE TO THE OTHER FOR ANY INDIRECT, SPECIAL, INCIDENTAL, OR CONSEQUENTIAL DAMAGES.

TI currently deals with a variety of customers for products, and therefore our arrangement with the user **is not exclusive**.

TI assumes **no liability for applications assistance, customer product design, software performance, or infringement of patents or services described herein**.

Please read the EVM User's Guide and, specifically, the EVM Warnings and Restrictions notice in the EVM User's Guide prior to handling the product. This notice contains important safety information about temperatures and voltages. For further safety concerns, please contact the TI application engineer.

Persons handling the product must have electronics training and observe good laboratory practice standards.

No license is granted under any patent right or other intellectual property right of TI covering or relating to any machine, process, or combination in which such TI products or services might be or are used.

Mailing Address:

Texas Instruments
Post Office Box 655303
Dallas, Texas 75265

EVM WARNINGS AND RESTRICTIONS

It is important to operate this EVM with an input voltage of 3.3 V and the output voltage range of 0.9 V to 2.5 V, or an input voltage of 5 V and the output voltage range of 0.9 V to 3.3 V.

Exceeding the specified input range may cause unexpected operation and/or irreversible damage to the EVM. If there are questions concerning the input range, please contact a TI field representative prior to connecting the input power.

Applying loads outside of the specified output range may result in unintended operation and/or possible permanent damage to the EVM. Please consult the EVM User's Guide prior to connecting any load to the EVM output. If there is uncertainty as to the load specification, please contact a TI field representative.

During normal operation, some circuit components may have case temperatures greater than 55°C. The EVM is designed to operate properly with certain components above 60°C as long as the input and output ranges are maintained. These components include but are not limited to linear regulators, switching transistors, pass transistors, and current sense resistors. These types of devices can be identified using the EVM schematic located in the EVM User's Guide. When placing measurement probes near these devices during operation, please be aware that these devices may be very warm to the touch.

Mailing Address:

Texas Instruments
Post Office Box 655303
Dallas, Texas 75265

Preface

About This Manual

This user's guide describes the characteristics, operation and use of the TPS54373EVM–237 evaluation module (EVM). The user's guide includes a schematic diagram, printout-circuit board (PCB) layouts, and bill of materials.

How to Use This Manual

- Chapter 1—Introduction
- Chapter 2—Test Setup and Results
- Chapter 3—Board Layout
- Chapter 4—Schematic and Bill of Materials

Information About Cautions and Warnings

This book may contain cautions and warnings.

This is an example of a caution statement.

A caution statement describes a situation that could potentially damage your software or equipment.

This is an example of a warning statement.

A warning statement describes a situation that could potentially cause harm to you.

Related Documentation From Texas Instruments

- TPS54373 data sheet (literature number SLVS455)

Trademarks

SWIFT is a trademark of Texas Instruments.

PowerPAD is a trademark of Texas Instruments.

Contents

1	Introduction	1-1
1.1	Background	1-2
1.2	Performance Specification Summary	1-3
1.3	Modifications	1-4
2	Test Setup and Results	2-1
2.1	Input/Output Connections	2-2
2.2	Efficiency	2-3
2.3	Power Dissipation	2-4
2.4	Output Voltage Regulation	2-5
2.5	Load Transients	2-6
2.6	Loop Characteristics	2-7
2.7	Output Voltage Ripple	2-8
2.8	Input Voltage Ripple	2-9
2.9	Start-Up	2-10
3	Board Layout	3-1
3.1	Layout	3-2
4	Schematic and Bill of Materials	4-1
4.1	Schematic	4-2
4.2	Bill of Materials	4-3

Figures

1-1	Frequency Trimming Resistor Selection Graph	1-5
2-1	Connection Diagram	2-2
2-2	Measured Efficiency, TPS54373	2-3
2-3	Measured Circuit Losses	2-4
2-4	Load Regulation	2-5
2-5	Line Regulation	2-5
2-6	Load Transient Response, TPS54373	2-6
2-7	Measured Loop Response, TPS54373, $V_I = 3\text{ V}$	2-7
2-8	Measured Loop Response, TPS54373, $V_I = 6\text{ V}$	2-7
2-9	Measured Output Voltage Ripple, TPS54373	2-8
2-10	Input Voltage Ripple, TPS54373	2-9
2-11	Measured Start-Up Waveform, TPS54373 With No Precharge	2-10
2-12	Measured Start-Up Waveform, Two Diode Precharge	2-11
2-13	Measured Start-Up Waveform, Three Diode Precharge	2-11
2-14	Measured Start-Up Waveform, Four Diode Precharge	2-12
2-15	Measured Start-Up Waveform, Four Diode Precharge and No Load	2-13
3-1	Top-Side Layout	3-2
3-2	Bottom-Side Layout (looking from top side)	3-3
3-3	Top-Side Assembly	3-3
4-1	TPS54373EVM-237 Schematic	4-2

Tables

1-1	Input Voltage and Output Current Summary	1-2
1-2	TPS54373EVM-237 Performance Specification Summary	1-3
1-3	Output Voltage Programming	1-4
4-1	TPS54373EVM-237 Bill of Materials	4-3

Introduction

This chapter contains background information for the TPS54373 as well as support documentation for the TPS54373EVM-237 evaluation module (SLVP237). The TPS54373EVM-237 performance specifications are given, with the schematic and bill of material for the TPS54373EVM-237.

Topic	Page
1.1 Background	1-2
1.2 Performance Specification Summary	1-3
1.3 Modifications	1-4

1.1 Background

The TPS54373EVM-237 evaluation module uses the TPS54373 synchronous buck regulator with disabled sink during start-up (DSDS) to provide an output voltage of from 0.9 V to 2.5 V from a nominal 3.3-V input or 0.9 V to 3.3 V for a nominal 5-V input. Rated input voltage and output current range is given in Table 1–1. This evaluation module is designed to demonstrate the small PCB areas that are achieved when designing with the TPS54373 regulator. The switching frequency is set at a nominal 700 kHz, allowing the use of a small footprint 1.0- μ H output inductor. The MOSFETs of the TPS54373 are incorporated inside the TPS54373 package. This eliminates the need for external MOSFETs and their associated drivers. The low drain-to-source on resistance of the MOSFETs gives the TPS54373 high efficiency and helps to keep the junction temperature low at high output currents. The compensation components are provided external to the IC, and allow for an adjustable output voltage and a customizable loop response. The disabled sink during start-up (DSDS) feature allows the TPS54373 regulator to be used in applications where it is necessary to prebias the output to maintain a specified difference between I/O and core voltages during start-up.

Table 1–1. Input Voltage and Output Current Summary

EVM	Input Voltage Range	Output Current Range
TPS54373EVM-237	3.0 V to 6.0 V	–3 A to 3 A

1.2 Performance Specification Summary

A summary of the TPS54373EVM-225 performance specifications is provided in Table 1–2. Specifications are given for an input voltage of 3.3 V and an output voltage of 1.8 V unless otherwise specified. The ambient temperature is 25°C for all measurements, unless otherwise noted. The data presented in Table 1–2 compiled with no precharge. The output, J3, is open and no voltage source is present on J4. Using the precharge circuitry on this EVM requires careful consideration of line and load conditions for proper operation and may limit the useful operating range of the TPS54373 device.

Table 1–2. TPS54373EVM-237 Performance Specification Summary

Specification		Test Conditions	Min	Typ	Max	Units
Input voltage range			3.0	3.3 or 5.0	6	V
Output voltage set point			0.9	1.8	3.3	V
Output current range		$V_I = 3\text{ V to }6\text{ V}$	–3		3	A
Line regulation		$I_O = 1.5\text{ A}, V_I = 3\text{ to }6\text{ V}$	± 0.5%			
Load regulation		$V_I = 3.3\text{ V}, I_O = 0\text{ A to }3\text{ A}$	±0.2%			
Load transient response	Voltage change	$I_O = 0.75\text{ A to }2.25\text{ A}$	–20			mV _{PK}
	Recovery time		160			µs
	Voltage change	$I_O = 2.25\text{ A to }0.75\text{ A}$	20			mV _{PK}
	Recovery time		160			µs
Loop bandwidth		$V_I = 3\text{ V}$	50			kHz
Phase margin		$V_I = 3\text{ V}$	62°			
Loop bandwidth		$V_I = 6\text{ V}$	80			kHz
Phase margin		$V_I = 6\text{ V}$	46°			
Input ripple voltage			80	200		mV _{PP}
Output ripple voltage			6	10		mV _{PP}
Output rise time			7			ms
Operating frequency			700			kHz
Maximum efficiency		$V_I = 3.3\text{ V}, V_O = 1.8\text{ V}, I_O = 1.0\text{ A}$	89%			–

1.3 Modifications

The TPS54373EVM-237 is designed to demonstrate the small size that can be attained when designing with the TPS54373, so many of the features, which allow for extensive modifications have been omitted from this EVM. Changing the value of R2 can change the output voltage in the range of 0.9 V to 3.3 V. The value of R2 for a specific output voltage can be calculated by using Equation 1–1. Table 1–3 list the values for R2 for some common output voltages.

Equation 1–1.

$$R2 = 10 \text{ k}\Omega \times \frac{0.891 \text{ V}}{V_O - 0.891 \text{ V}}$$

Table 1–3. Output Voltage Programming

Output Voltage (V)	R2 Value (kΩ)
0.9	1000
1.2	28.7
1.5	14.7
1.8	9.76
2.5	5.49
3.3	3.74

The minimum output voltage is limited by the minimum controllable on time of the device, 200 ns, and is dependent upon the duty cycle and operating frequency. The approximate minimum output voltage can be calculated using Equation 1–2.

Equation 1–2.

$$V_{OUTMIN} = 200 \text{ n sec} \times f_s \times V_{INMAX}$$

The switching frequency may be trimmed to any value between 280 kHz and 700 kHz by changing the value of R4. Decreasing the switching frequency results in increased output ripple unless the value of L1 is increased. A plot of the value of RT versus the switching frequency is given in Figure 1–1.

Figure 1–1. Frequency Trimming Resistor Selection Graph

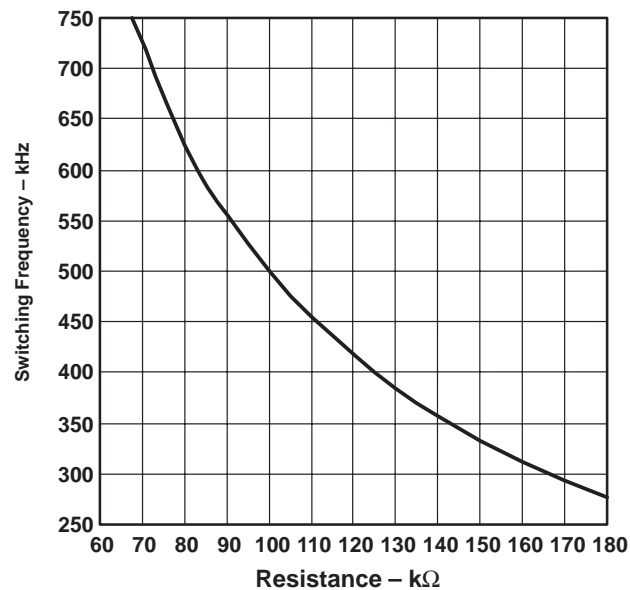

The TPS54373EVM–237 EVM supports alternate output filter configurations by means of pads located on the back side of the PCB. The positions for C15 and C16 provide space for one or two electrolytic type surface-mount capacitors as an alternative to the ceramic types provided. Since changes in the output filter affects the overall loop response, the user may find it desirable to change the values used in the compensation network (R1, R3, R5, C6, C7 and C8) the 0-Ω resistor R7 in the feedback path is provided as a convenient place to break the loop for testing any compensation value changes. While the provided compensation network can provide a stable output for a wide variety of output filter component values, it is always a good idea to verify any changes to the output filter or compensation network.

The primary intended usage for the TPS54373 device family is in applications requiring a precharge condition on the output. These types of applications include power supplies for DSPs and microprocessors where the I/O and core voltages must track each other within a certain amount during start-up. The TPS54373 incorporates disable sink during start-up to allow this type of functionality in the SWIFT family of dc/dc converters. A typical design approach is to tie the output of the core voltage to the output of the I/O voltage with a number of series diodes so that the core voltage is at a level equal to the I/O voltage minus the drop across the diodes during start-up. The TPS54373EVM-237 EVM provides four series diodes, D1 through D4, and allows the user to precharge the output from either the EVM input voltage or an external source. To use the input voltage as the precharge source, install a jumper across the J3 header. To supply an external source, use the J4 connector terminals, while leaving J3 open. Headers J5 and J6 are provided to select two, three or four series diodes. Install a jumper across the header to bypass the adjacent diode. Care must be taken to use the correct number of diodes for the application.

Warning

Under no circumstances can the output voltage be allowed to precharge to a level higher than the preset output voltage. If this condition occurs during start-up, the TPS54373 device does not begin switching.

If a voltage transient on the precharge voltage source causes the series diodes to conduct, current may be sunk through the low side FET in the device, possibly damaging the device. The actual voltage drop across the diodes during start-up depends on the initial load condition of the circuit as well as the ambient temperature.

An onboard electrolytic input capacitor may be added at C1.

Test Setup and Results

This chapter describes how to properly connect, setup, and use the TPS54373EVM-237 evaluation module. The chapter also includes test results typical for the TPS54373EVM-237 and covers efficiency, output voltage regulation, load transients, loop response, output ripple, input ripple, and start-up.

Topic	Page
2.1 Input/Output Connections	2-2
2.2 Efficiency	2-3
2.3 Power Dissipation	2-4
2.4 Output Voltage Regulation	2-5
2.5 Load Transients	2-6
2.6 Loop Characteristics	2-7
2.7 Output Voltage Ripple	2-8
2.8 Input Voltage Ripple	2-9
2.9 Start-Up	2-10

2.1 Input/Output Connections

The TPS54373EVM-237 has the following three input/output connectors: V_I J1, V_O J2 and PRECHG_IN J4. A diagram showing the connection points is shown in Figure 2–1. A power supply capable of supplying 5 A is connected to J1 through a pair of 20 AWG wires. The load is connected to J2 through a pair of 20 AWG wires. The maximum load current capability is 3 A. Wire lengths should be minimized to reduce losses in the wires. Test point TP7 provides a place to easily connect an oscilloscope voltage probe to monitor the output voltage. The TPS54373 is intended to be used as a point of load regulator. In typical applications it is usually located close to the input voltage source. When using the TPS54373EVM-237 with an external power supply as the source for V_I , an additional bulk capacitor may be required, depending upon the output impedance of the source and length of the hookup wires. The test results presented were obtained using a 470 μ F, 16-V additional input capacitor. Alternately, C1 may be populated with an input filter capacitor. Connection is shown for no precharge only. To utilize the precharge feature, connect the optional power supply to the J4 connector or connect the input voltage to the series diode array by inserting a jumper across the J3 header.

Figure 2–1. Connection Diagram

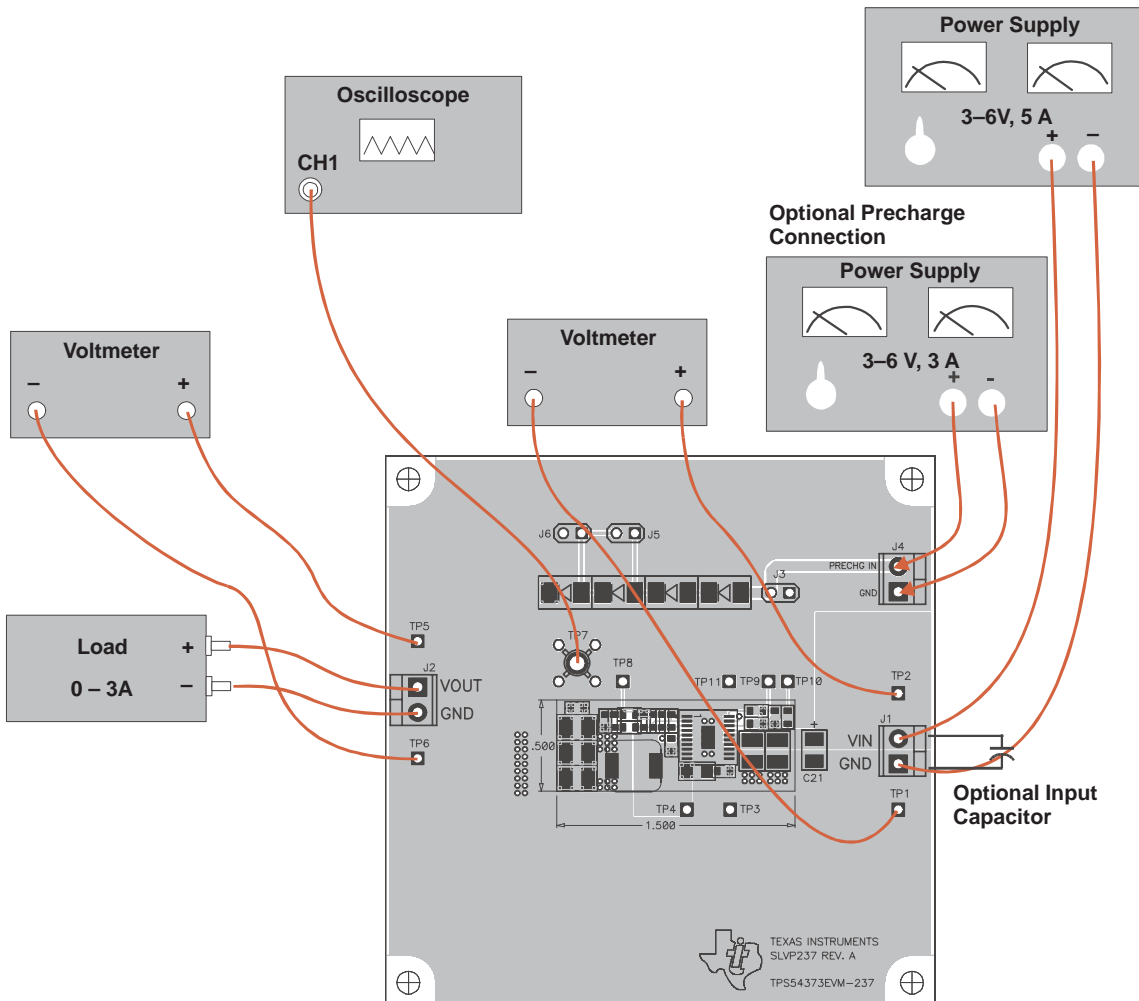

2.2 Efficiency

The TPS54373EVM-237 efficiency peaks at load current of about 1 A to 2 A, and then decreases as the load current increases towards full load. Figure 2–2 shows the efficiency for the TPS54373 at an ambient temperature of 25°C. The efficiency is lower at higher ambient temperatures, due to temperature variation in the drain-to-source resistance of the MOSFETs. The efficiency is slightly lower at 700 kHz than at lower switching frequencies, due to the gate and switching losses in the MOSFETs.

Figure 2–2. Measured Efficiency, TPS54373

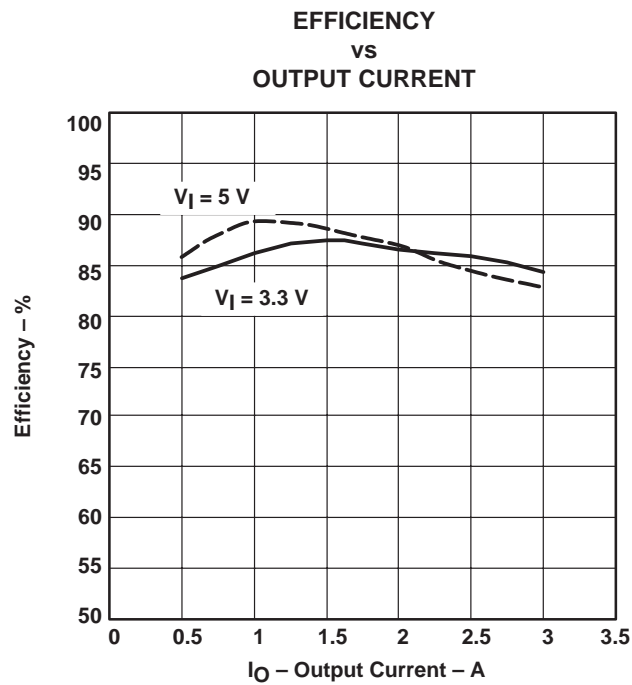

2.3 Power Dissipation

The low junction-to-case thermal resistance of the PWP package, along with a good board layout, allows the TPS54373EVM–237 EVMs to output full rated load current while maintaining safe junction temperatures. With a 3.3-V input source and a 3-A load, the junction temperature is approximately 60°C, while the case temperature is approximately 55°C. The total circuit losses at 25°C are shown in Figure 2–3. Power dissipation is shown for input voltages of 3.3 V and 5.0 V. For additional information on the dissipation ratings of the devices, see the individual product data sheets.

Figure 2–3. Measured Circuit Losses

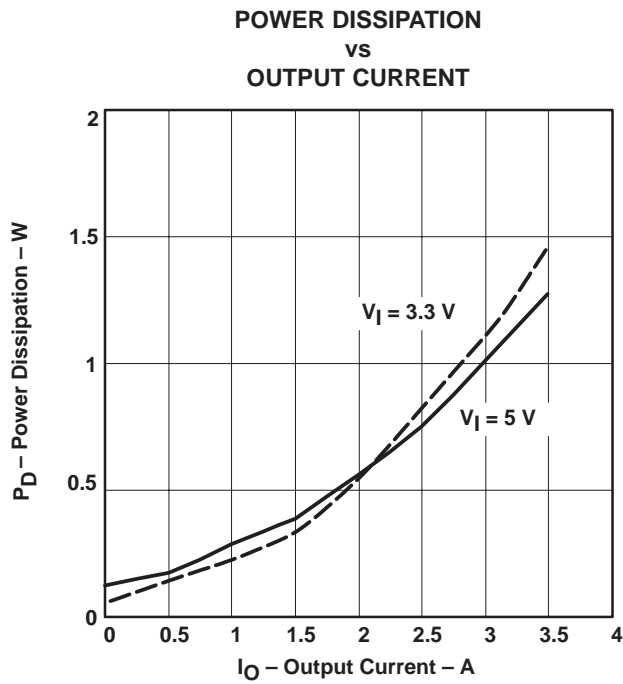

2.4 Output Voltage Regulation

The output voltage load regulation of the TPS54373EVM-237 is shown in Figure 2–4, while the output voltage line regulation is shown in Figure 2–5. Measurements are given for an ambient temperature of 25°C.

Figure 2–4. Load Regulation

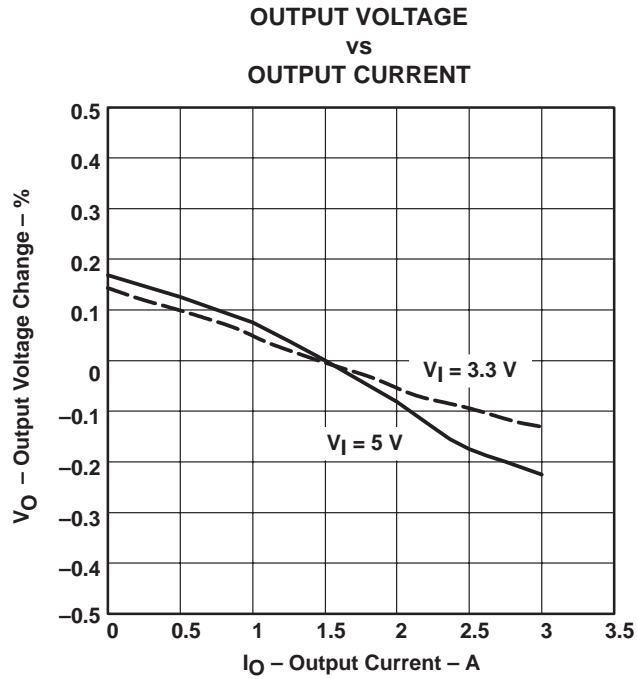
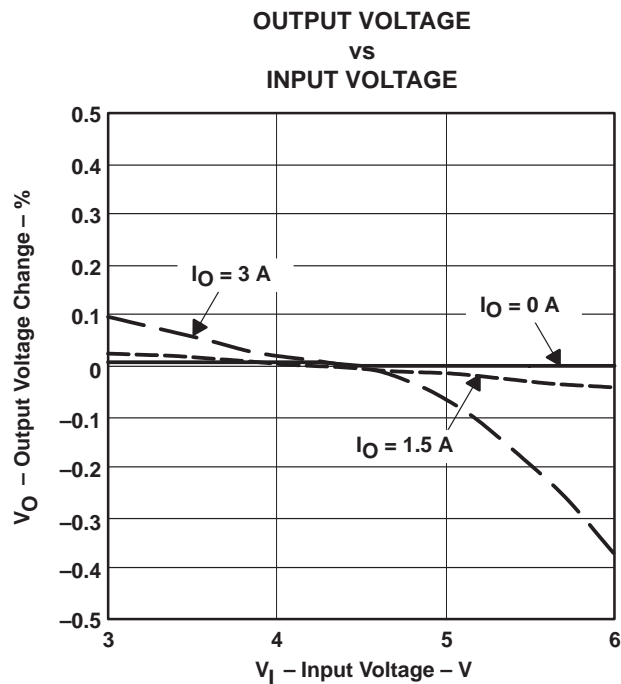

Figure 2–5. Line Regulation



2.5 Load Transients

The TPS54373EVM-237 response to load transients is shown in Figure 2–6. The current step is from 25% to 75% of maximum rated load. Total peak-to-peak voltage variation is as shown, including ripple and noise on the output.

Figure 2–6. Load Transient Response, TPS54373

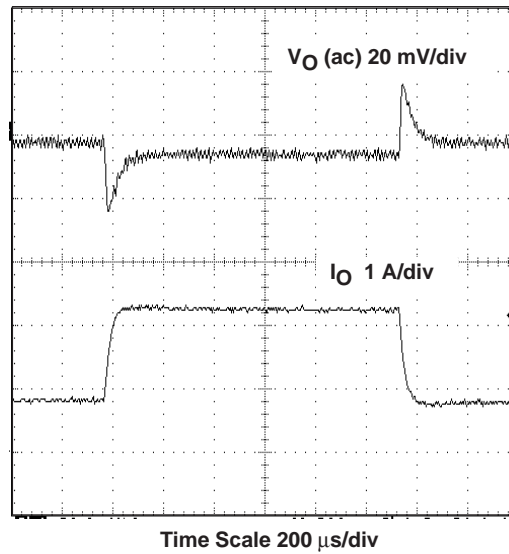

2.6 Loop Characteristics

The TPS54373EVM-237 loop response characteristics are shown in Figure 2–7 and Figure 2–8. Gain and phase plots are shown for each device at minimum and maximum operating voltage.

Figure 2–7. Measured Loop Response, TPS54373, $V_I = 3\text{ V}$

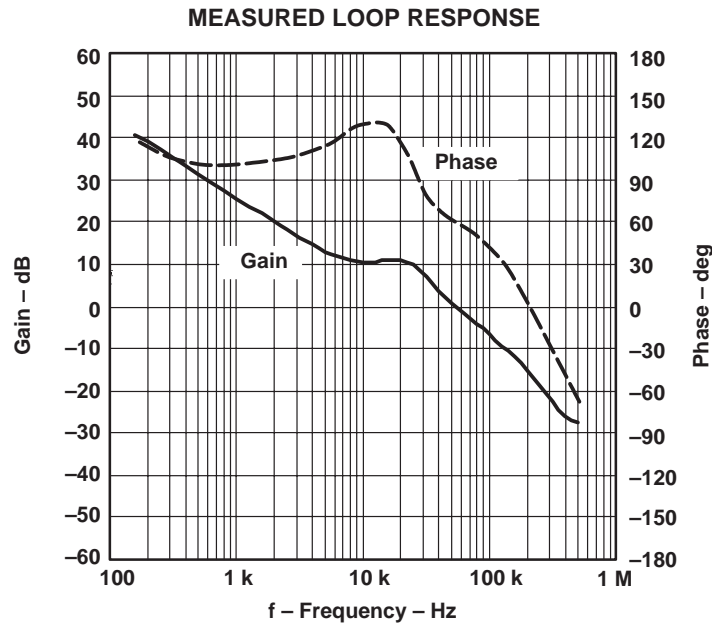
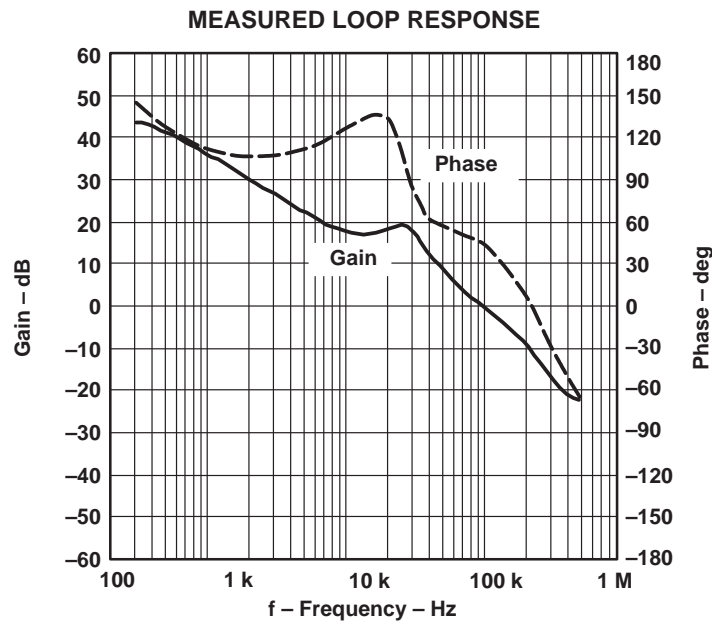

Figure 2–8. Measured Loop Response, TPS54373, $V_I = 6\text{ V}$



2.7 Output Voltage Ripple

The TPS54373EVM-237 output voltage ripple is shown in Figure 2-9. The input voltage is 3.3 V for the TPS54373. Output current is the rated full load of 3 A. Voltage is measured directly across output capacitors.

Figure 2-9. Measured Output Voltage Ripple, TPS54373

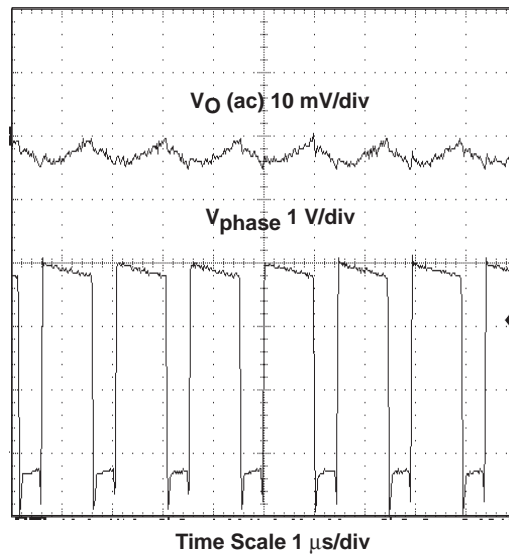

2.8 Input Voltage Ripple

The TPS54373EVM-237 output voltage ripple is shown in Figure 2-10. The input voltage is 3.3 V for the TPS54373. Output current for each device is rated full load of 3 A.

Figure 2-10. Input Voltage Ripple, TPS54373

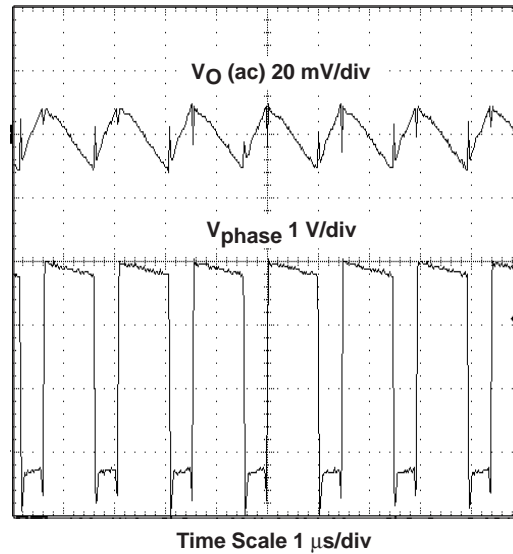

2.9 Start-Up

Start-up voltage waveforms of the TPS54373EVM–237 are shown in Figure 2–11 through Figure 2–15. Figure 2–11 shows the start-up waveform with no precharge on the output. When the V_I reaches the nominal 2.95-V UVLO threshold, the slow start capacitor C5 begins to charge. When the voltage on the SS/ENA pin reaches the enable threshold of 1.2 V, the internal reference begins to ramp up at the slow start rate. As the internal reference voltage increases relative to the voltage at VSENSE, the duty cycle of the PWM comparator output increases. The internal FETs are inhibited from switching until the output of the PWM comparator reaches maximum duty cycle. When maximum duty cycle is reached, switching starts and the output rises quickly while the output voltage catches up with the slow start ramp rate. At this point the voltage on the VSENSE pin matches the internal reference and the output continues to ramp up to the final set point value of 1.8 V at the slow start rate.

Figure 2–11. Measured Start-Up Waveform, TPS54373 With No Precharge

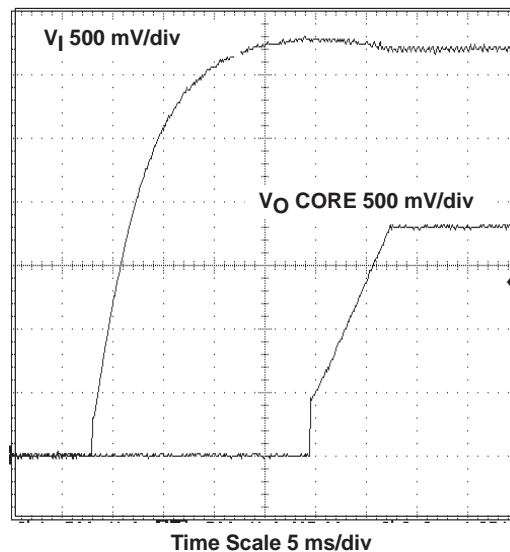

Figure 2–12 shows the start-up waveform with the output precharged and a 2- Ω load. The precharge is achieved by connecting the 3.3-V input to the output with 2 diodes in series. The start-up mechanism is the same as described above except that now the internal reference must ramp up above the voltage fed back from the precharged output to the VSENSE pin before switching starts. Once this occurs, the output continues to ramp up to the output set point of 1.8 V at the slow start rate. Figure 2–13 and Figure 2–14 show the start-up waveform with 3 and 4 diodes in series. Note the different levels that the output is precharged to with 2, 3 or 4 diodes in circuit.

Figure 2–12. Measured Start-Up Waveform, Two Diode Precharge

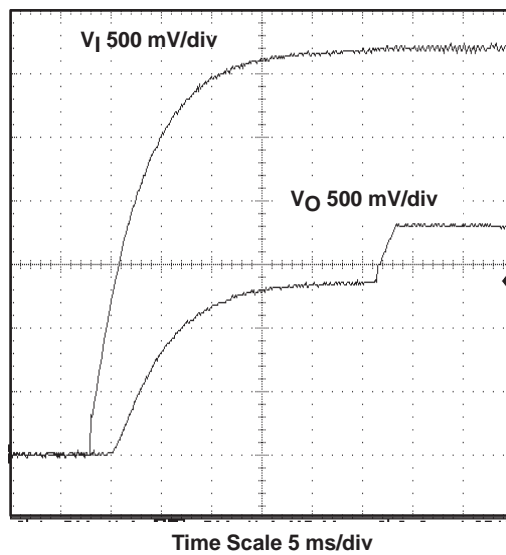

Figure 2–13. Measured Start-Up Waveform, Three Diode Precharge

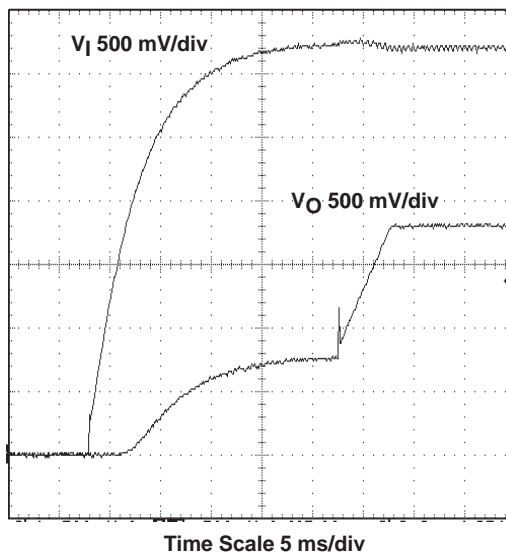

Figure 2–14. Measured Start-Up Waveform, Four Diode Precharge

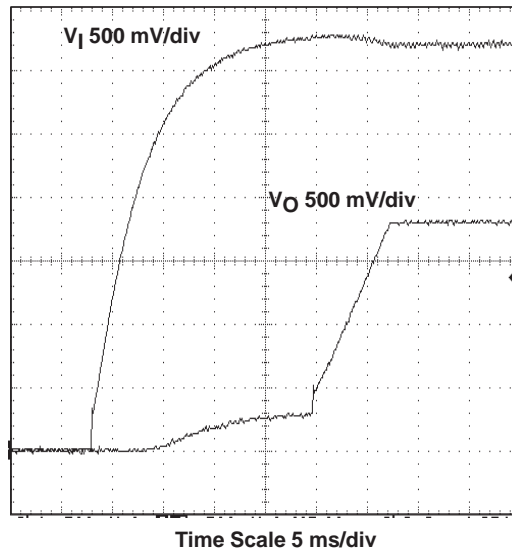
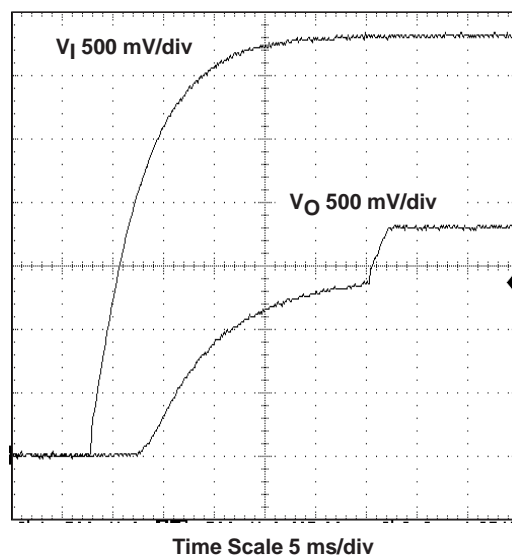

Figure 2–15 shows the start-up waveform with the output precharged through 4 diodes and no load. Compare the precharge level to that in Figure 2–14 to see how start-up load current affects the voltage drop across the diodes and the final precharge voltage. As in the previous example, when the internal reference exceeds the voltage fed back to the VSENSE pin, the output begins to ramp up to its final preset value at the slow start rate. It is important to note how the precharge level in Figure 2–15 is very close to the final output value. This would be the case if less than four diodes were used.

Warning

The precharge level must never exceed the output set point under any line or load condition for proper circuit operation.

Figure 2–15. Measured Start-Up Waveform, Four Diode Precharge and No Load





Board Layout

This chapter provides a description of the TPS54373EVM-237 board layout and layer illustrations.

Topic	Page
3.1 Layout	3-2

3.1 Layout

The board layout for the TPS54373EVM-237 is shown in Figure 3–1 through Figure 3–3. The top-side layer of the TPS54373EVM-237 is laid out in a manner typical of a user application. The bottom layer of the TPS54373EVM-237 is designed to accommodate optional alternate output filter capacitors. The top and bottom layers are 1.5 oz. copper.

The top layer contains the main power traces for V_I , V_O , and $V_{(phase)}$. Also on the top layer are connections for the remaining pins of the TPS54373 and a large area filled with ground. The bottom layer contains ground and V_O copper areas, some signal routing and pads for two optional D3 or D4 case size electrolytic capacitors. The top and bottom ground traces are connected with multiple vias placed around the board including ten directly under the TPS54373 device to provide a thermal path from the PowerPAD™ land to ground.

The input decoupling capacitors (C9 and C10), bias decoupling capacitor (C4), and bootstrap capacitor (C3) are all located as close to the IC as possible. In addition, the compensation components are kept close to the IC. The compensation circuit ties to the output voltage at the point of regulation, adjacent to the high frequency bypass output capacitor.

Figure 3–1. Top-Side Layout

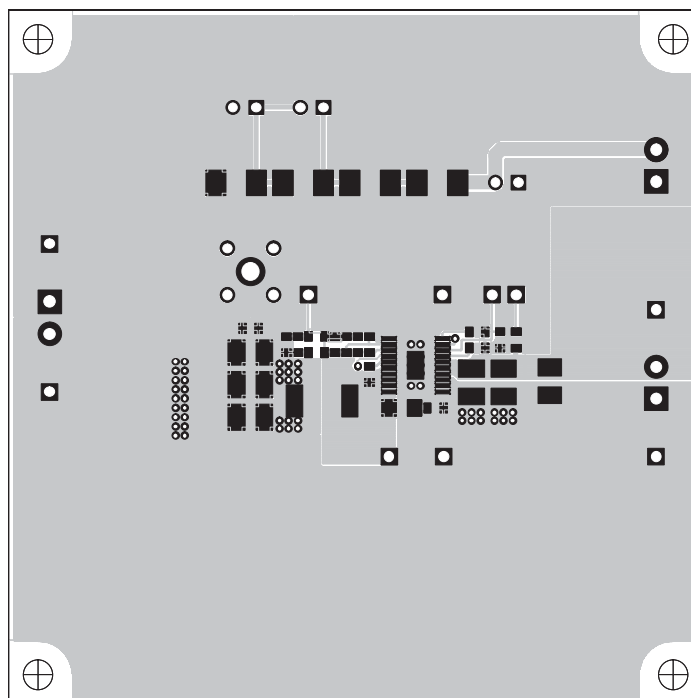

Figure 3–2. Bottom-Side Layout (looking from top side)

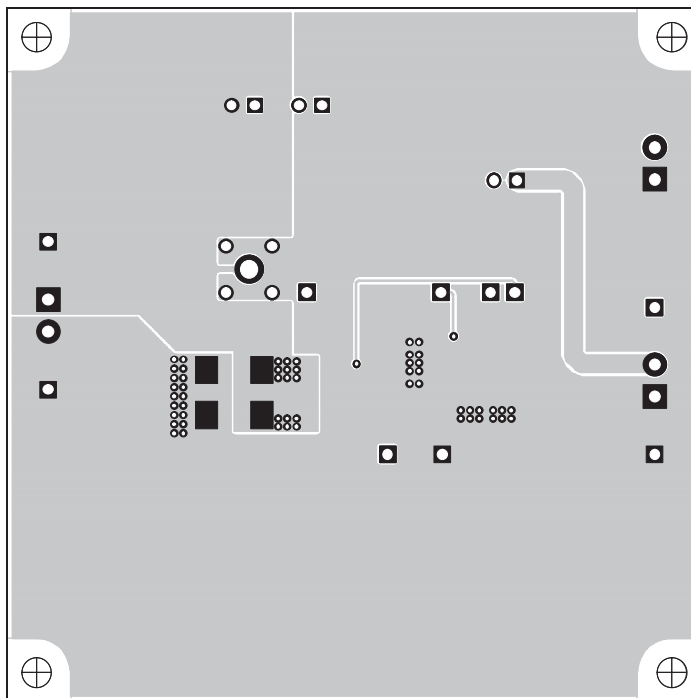
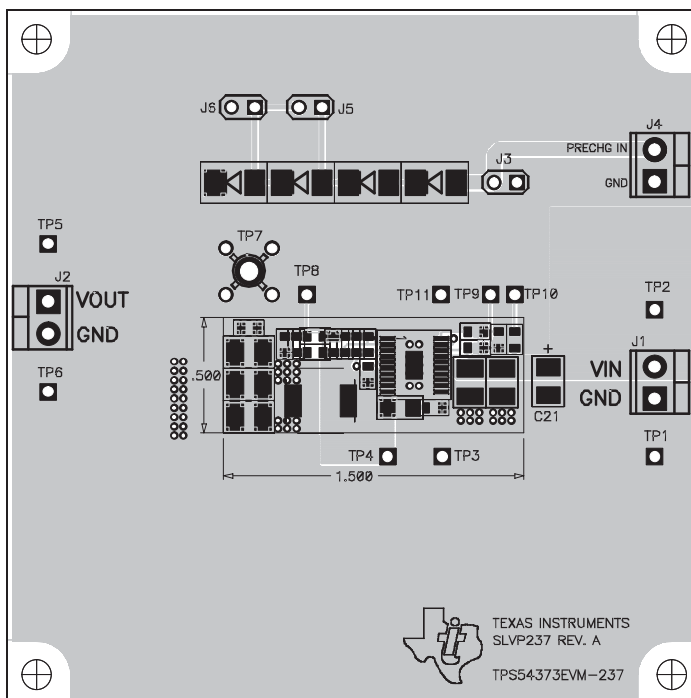

Figure 3–3. Top-Side Assembly





Schematic and Bill of Materials

The TPS54373EVM–237 schematic and bill of materials are presented in this chapter.

Topic	Page
4.1 Schematic	4-2
4.2 Bill of Materials	4-3

4.1 Schematic

The schematic for the TPS54373EVM-237 is shown in Figure 4-1.

Figure 4-1. TPS54373EVM-237 Schematic

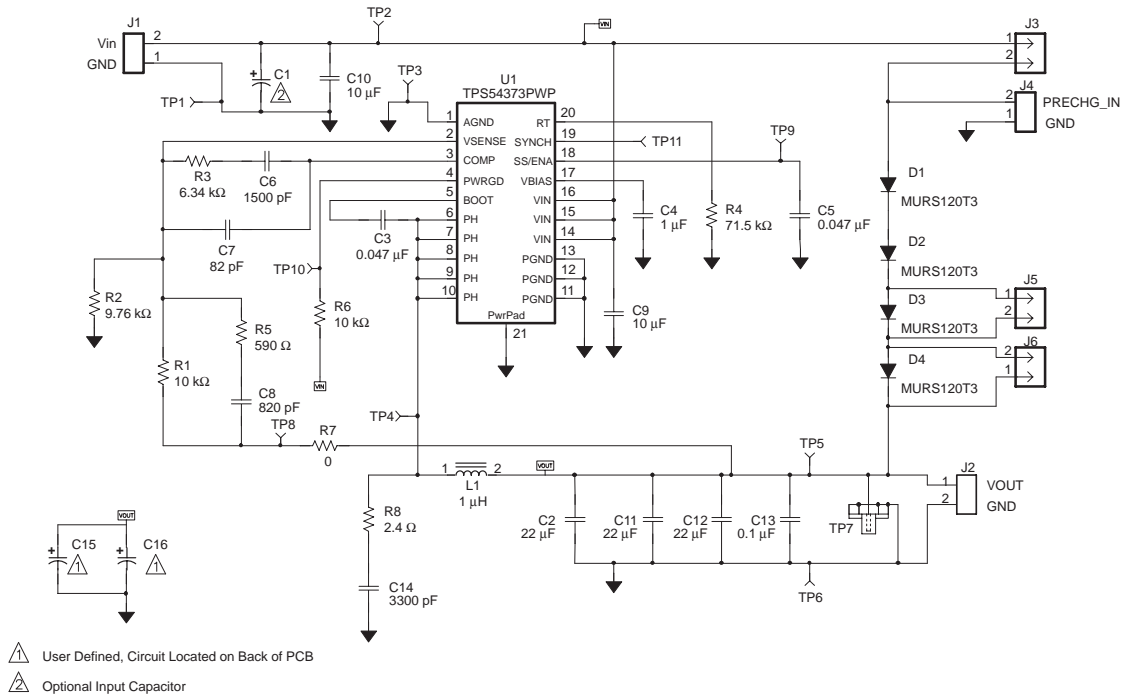

4.2 Bill of Materials

Table 4–1 contains the bill of materials for the TPS54380EVM–001.

Table 4–1. TPS54373EVM-237 Bill of Materials

Count	RefDes	Description	Size	MFR	Part Number
	C1	Capacitor, POSCAP, 220 μ F, 10 V, 40 m Ω , 20%	D4	Sanyo	10TPB220M
1	C13	Capacitor, ceramic, 0.1 μ F, 25 V, X7R, 10%	603	Std	Std
1	C14	Capacitor, ceramic, 3300 pF, 50–V, X7R, 10%	603	Std	Std
2	C15, C16	Open	62100		
3	C2, C11, C12	Capacitor, ceramic, 22 μ F, 6.3–V, X5R, 20%	1210	Taiyo Yuden	JMK325BJ226MN
2	C3, C5	Capacitor, ceramic, 0.047 μ F, 25–V, X7R, 10%	603	Std	Std
1	C4	Capacitor, ceramic, 1.0 μ F, 10–V, X5R, 20%	603	Std	Std
1	C6	Capacitor, ceramic, 1500 pF, 50–V, X7R, 10%	603	Std	Std
1	C7	Capacitor, ceramic, 82 pF, 50–V, NPO, 5%	603	Std	Std
1	C8	Capacitor, ceramic, 820 pF, 50–V, X7R, 10 %	603	Std	Std
2	C9, C10	Capacitor, ceramic, 10 μ F, 10–V, X5R, 20%	1210	Taiyo Yuden	LMK325BJ106MN
4	D1, D2, D3, D4	Diode, ultrafast rectifier, 1 A, 200 V	SMB	On Semi	MURS120T3
3	J1, J2, J4	Terminal block, 2 pin, 6 A, 3.5 mm	75525	OST	ED1514
3	J3, J5, J6	Header, 2 pin, 100 mil spacing, (36–pin strip)	0.100 x 2	Sullins	PTC36SAAN
3	—	Shunt, 100 mil, black	0.100	3M	929950–00
1	L1	Inductor, SMT, 1.0 μ H, 8.5 A, 10 m Ω	0.270 sq	Vishay	IHLP–2525CZ–01
1	R1, R6	Resistor, chip, 10.0 k Ω , 1/16 W, 1%	603	Std	Std
1	R2	Resistor, chip, 9.76 k Ω , 1/16 W, 1%	603	Std	Std
1	R3	Resistor, chip, 6.34 k Ω , 1/16 W, 1%	603	Std	Std
1	R4	Resistor, chip, 71.5 k Ω , 1/16 W, 1%	603	Std	Std
1	R5	Resistor, chip, 590 Ω , 1/16 W, 1%	603	Std	Std
1	R7	Resistor, chip, 0 Ω , 1/16 W, 1%	603	Std	Std
1	R8	Resistor, chip, 2.4 Ω , 1/8 W, 1%	1206	Std	Std
3	TP1, TP3, TP6	Test point, black, 1 mm	0.038", 6400"	Farnell	240–333
7	TP2, TP4, TP5, TP8, TP9, TP10, TP11	Test point, red, 1 mm	0.038", 6400"	Farnell	240–345
1	TP7	Adaptor, 3.5-mm probe clip (or 131–5031–00)	72900	Tektronix	131–4244–00
1	U1	IC, IFET power controller, adj V, 3A	PWP20	TI	TPS54373PWP
1	—	PCB, 3 In \times 3 In \times 0.062 In		Any	SLVP237

- Notes:**
- 1) These assemblies are ESD sensitive, ESD precautions are observed.
 - 2) These assemblies must be clean and free from flux and all contaminants. Use of no clean flux is not acceptable.
 - 3) These assemblies must comply with workmanship standards IPC–A–610 Class 2.
 - 4) Ref designators marked with an asterisk (***) cannot be substituted. All other components can be substituted with equivalent MFG's components.

