

TPS54362B EVM User's Guide

1 Introduction

The Texas Instruments TPS54362BEVM evaluation module (EVM) helps designers evaluate the operation and performance of the TPS54362B-Q1 switch-mode power-supply buck regulator. The device is configurable and can be configured to switch from 200 kHz up to 2.2 MHz. This EVM is optimized for EMI performance. For the EMI test results, see the application report *Passing CISPR25 Radiated Emissions Using TPS54362B-Q1*, [SLVA661](#).

Table 1. Device and Package Configurations

CONVERTER	IC	PACKAGE
U1	TPS54362BQPWPQ1	PWP-20

Table 2. Input and Output Summary

EVM	INPUT VOLTAGE RANGE	DEFAULT OUTPUT SETTING
TPS54362BEVM	$V_I = 3.6\text{ V to }40\text{ V}$	5 V at currents up to 3 A

1.1 Performance Summary

The TPS54362BEVM is optimized to meet the CISPR25 EMC standard for automotive components. TPS54362BEVM was tested at $V_{(BAT)} = 12\text{ V}$ an output voltage of 5 V at 2 A. The layout is designed to reduce emissions to levels deemed acceptable by the previously mentioned standard.

The switching frequency is externally set at a nominal 500 KHz. The compensation components are external to the integrated circuit (IC) and have been selected to optimize the transient performance of the device. An external divider allows for an adjustable output voltage.

[Table 3](#) lists a summary of the TPS54362BEVM performance specifications. Specifications are given for an input voltage of $V_I = 12\text{ V}$ and an output voltage of 5 V, unless otherwise specified. The TPS54362BEVM is designed and tested for $V_I = 6\text{ V to }48\text{ V}$. The ambient temperature is 25°C for all measurements, unless otherwise noted.

Table 3. TPS54362BEVM Performance Specification Summary

SPECIFICATION	TEST CONDITION	MIN	TYP	MAX	UNIT
VIN operating voltage range		6	12	48	V
Output voltage set-point			5		V
Output current range	$V_I = 7\text{ V to }48\text{ V}$	0		3	A
Operating frequency			500		kHz

2 Setup

This section describes the jumpers and connectors on the EVM as well and how to properly connect, set up, and use the TPS54362BEVM.

2.1 Input-Output Connector Description

J1 – Input — This jumper is the power input terminal for the converter. The terminal block provides a power ($V_{(BAT)}$) and ground (GND) connection to allow the user to attach the EVM to a cable harness.

J2 – Output — This jumper is the regulated output voltage for the converter. The terminal block provides a power (V_O) and ground (GND) connection to allow the user to attach the EVM to a cable harness.

J3 – Sync — This jumper is the input terminal for an optional external input clock to the converter. The external clock can be used to synchronize the switching frequency for multiple devices. The external clock frequency, if used, must meet the guideline as shown in [Equation 1](#).

$$f_s < f_{(EXT)} < 2 \times f_s$$

where

- f_s is the switching frequency (1)

JP1 – LPM — This jumper is the jumper used to enable Low Power Mode. The jumper allows LPM to be enabled or disabled. The “disabled with protection diode” selection should be used if the output voltage is programmed for voltages greater than 5 V. The external Zener will prevent over voltage damage to the LPM input.

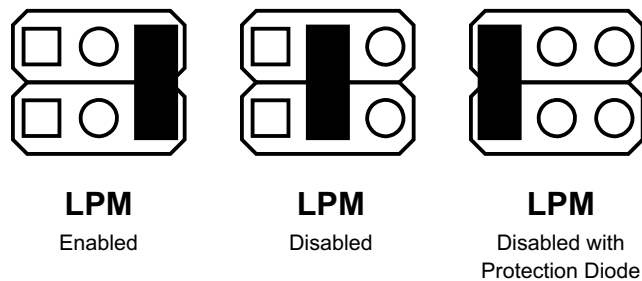

Figure 1. LPM Jumper Settings

JP2 – Enable—The converter is enabled when the EN pin is high and is disabled when the EN pin is low. The jumper placement allows the converter to be enabled or disabled.

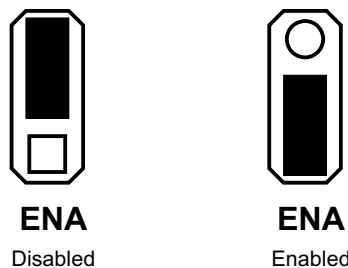

Figure 2. Enable Jumper Settings

JP3 – Slew Rate — This jumper sets the slew rate for the switch pin. The device slew rate should be set between 15 ns and 200 ns. Slower slew rates can improve EMI performance, but increase switching losses. Jumper resistors allow the slew rate to be set to four set points. The user can set a specific slew rate by changing one of the slew rate set resistors, either R8, R9, or R10.

NOTE: The slew rate should be set to 1 V, 1.2 ns if the EVM is configured for a 2-MHz switching frequency.

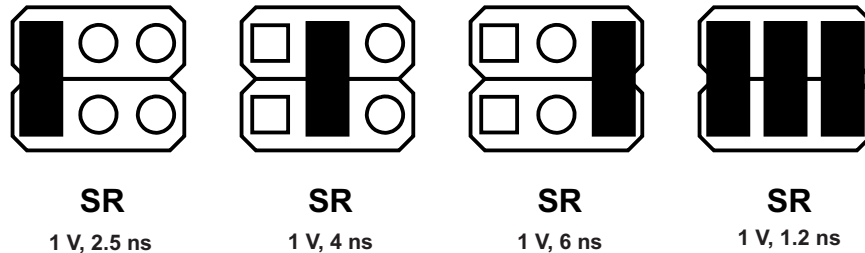

Figure 3. Slew-Rate Jumper Settings

JP4 – Delay — This jumper sets the delay time to assert the RST pin low after the supply exceeds the programmed VREG_RST voltage. The delay can be programmed in the range of 7 ms to 200 ms. Jumper capacitors allow the reset delay to be set to four set points. The user can set a specific delay time by changing one of the delay capacitors, either C13, C14, or C15. The RST signal can be monitored on the RST test point.

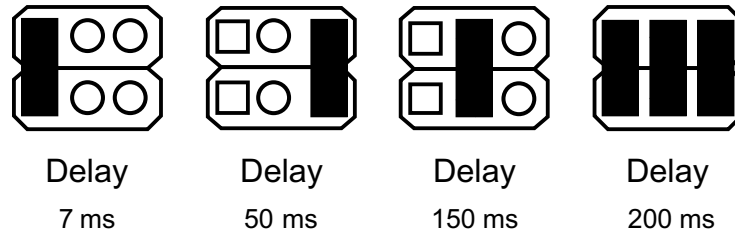

Figure 4. Reset Delay-Time Jumper Settings

2.2 Setup

The input voltage range for the converter is 3.6 V to 48 V. If the input voltage is lower than 5 V (default setting) the output voltage will track the input voltage within the drop out proportional to the load current and the internal FET on resistance.

2.3 Operation

For proper operation of the TPS54362B-Q1 device, JP1, JP2, JP3, and JP4 should be properly configured. The following lists the recommended setting which uses shorting blocks:

- JP1 to enabled
- JP2 to enabled
- JP3 to 1 V, 2.5 ns
- JP4 to 200 ms

In this configuration, the device powers up when power is applied.

Setting the R6 and R7 resistors to transition the EN input low as the supply voltage drops implements undervoltage lockout. Use Equation 2 to set the values for R6 and R7.

$$V_{dis} = ENTHRES \times (1 + R6 / R7)$$

where

- ENTHRES is around 1 V (2)

Resistor R7 is not populated on this EVM to reduce the quiescent supply current if this feature is not required.

3 Board Layout

Figure 5, Figure 6, Figure 7, Figure 8, and Figure 9 show the board layout for the TPS54362BEVM PWB. The EVM offers resistors, capacitors, and jumpers to program the switch-pin slew rate and regulator turn-on delay. Jumpers are also provided to enable the device and to enable the low power-mode option. The TPS54362B-Q1 converter offers high efficiency, but dissipates power. The PowerPAD™ package offers an exposed thermal pad to enhance thermal performance. This pad must be soldered to the copper landing on the PCB for optimal performance. The PCB provides 2-oz copper planes on the top and bottom to dissipate heat.

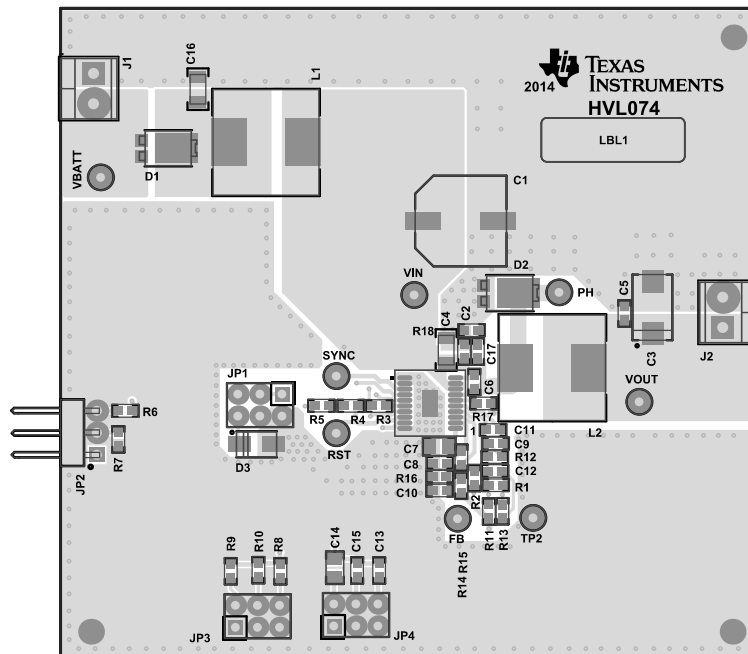

Figure 5. Top Assembly Layer

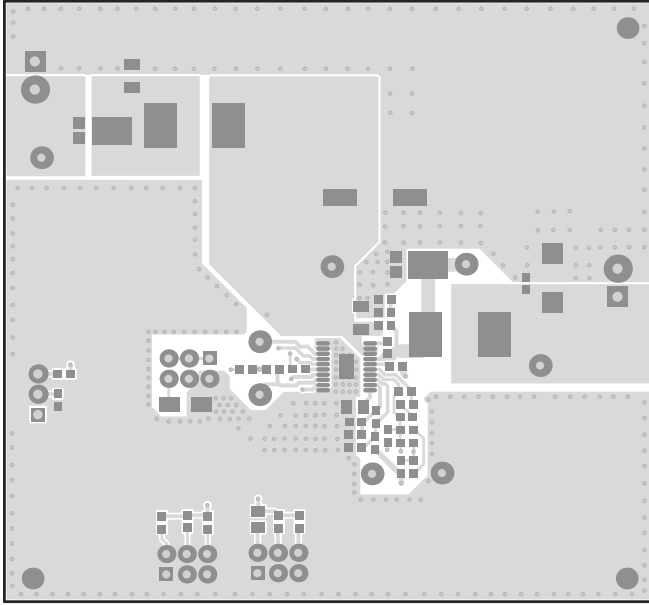

Figure 6. Top Layer Routing

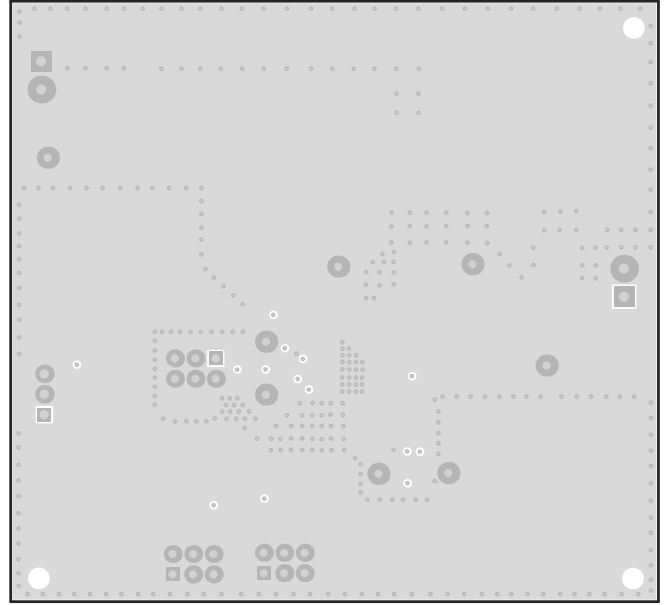

Figure 7. Inner Layer 2 (Ground Plane)

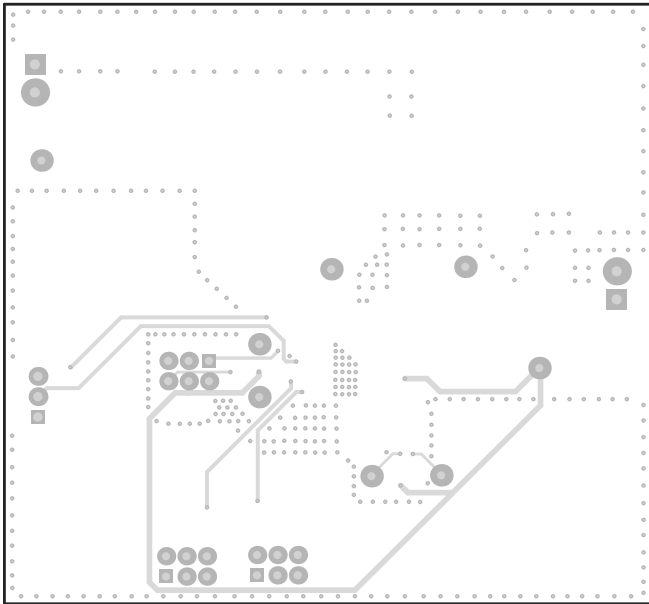

Figure 8. Inner Layer 3 Routing

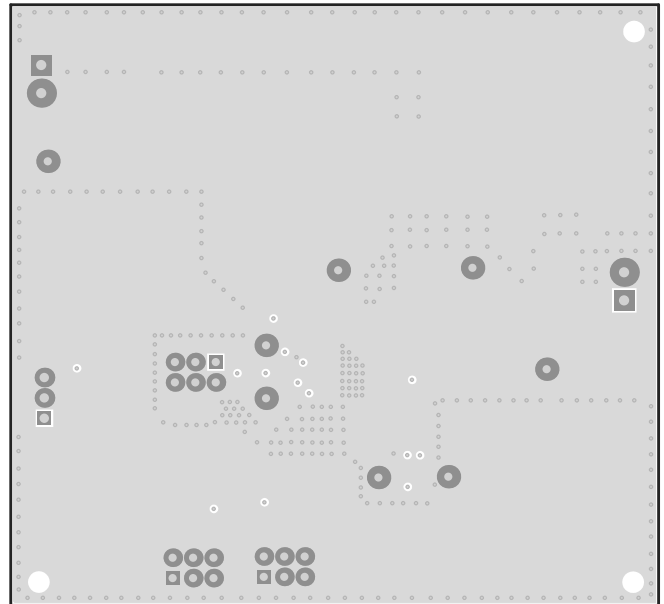
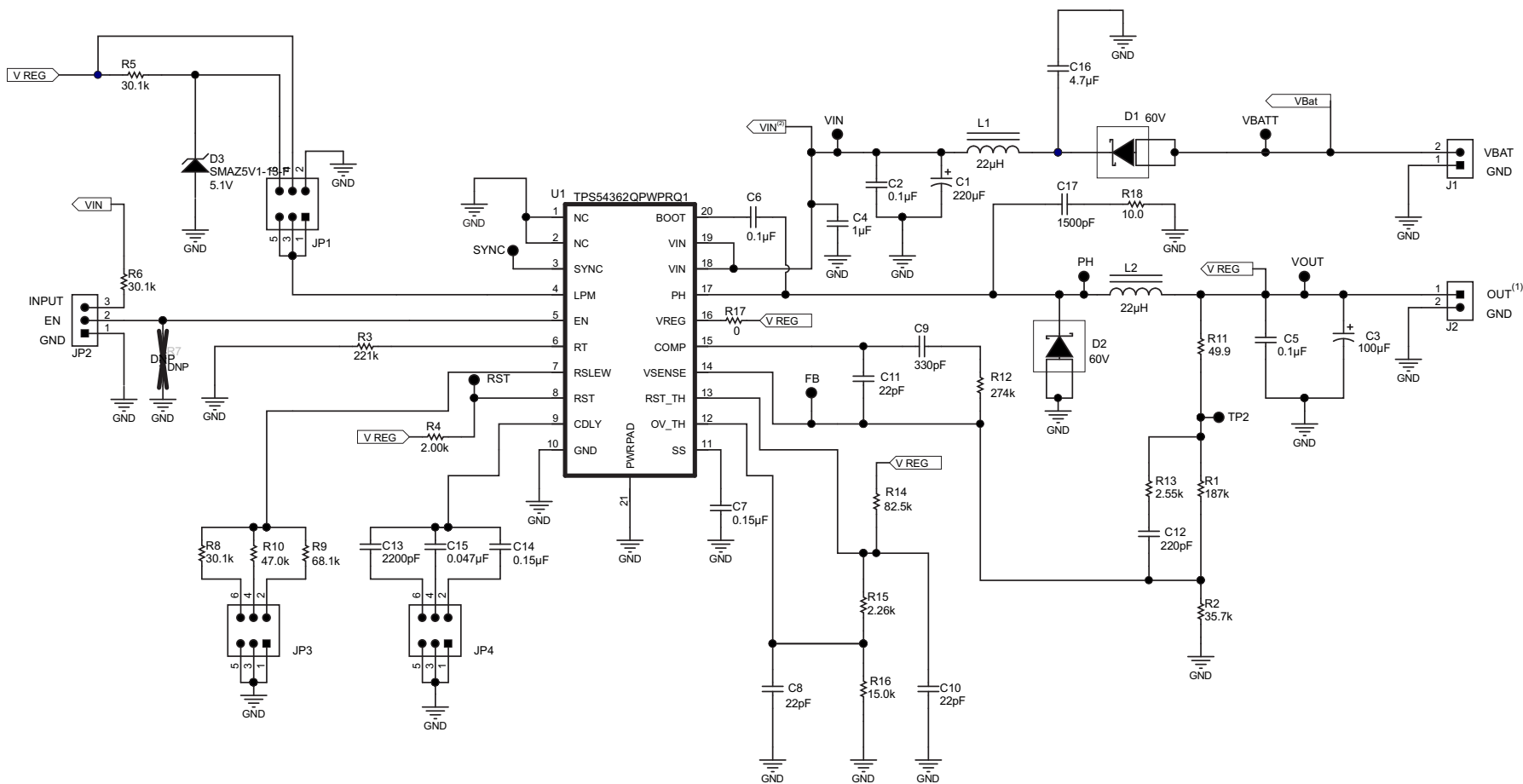

Figure 9. Bottom Layer (Ground Plane)

4 Schematic and Bill of Materials

4.1 Schematic



- (1) Output voltage = 5 V, load current = 3 A maximum
- (2) Input voltage up to 48 V

Figure 10. Schematic

4.2 Bill of Materials

Table 4. TPS54362BEVM Bill of Materials for a 500-kHz Configuration

DESIGNATOR	QUANTITY	VALUE	DESCRIPTION	PACKAGE REFERENCE	PART NUMBER	MANUFACTURER	ALTERNATE PART NUMBER	ALTERNATE MANUFACTURER
!PCB	1		Printed Circuit Board		TPS54362BEVM	Any	-	-
C1	1	220 μ F	Capacitor, AL, 220 μ F, 50 V, \pm 20%, 0.18 Ω , SMD	SMT Radial G	EEE-FK1H221P	Panasonic		
C2, C5, C6	3	0.1 μ F	Capacitor, ceramic, 0.1 μ F, 50 V, \pm 10%, X7R, 0603	0603	GRM188R71H104KA93D	MuRata		
C3	1	100 μ F	Capacitor, TA, 100 μ F, 16 V, \pm 20%, 0.06 Ω , SMD	7343-31	TPSD107M016R0060	AVX		
C4	1	1 μ F	Capacitor, ceramic, 1 μ F, 50 V, \pm 10%, X7R, 1206	1206	GRM31MR71H105KA88L	MuRata		
C7, C14	2	0.15 μ F	Capacitor, ceramic, 0.15 μ F, 25 V, \pm 10%, X7R, 0805	0805	08053C154KAT2A	AVX		
C8, C10, C11	3	22 pF	Capacitor, ceramic, 22 pF, 50 V, \pm 5%, C0G/NPO, 0603	0603	06035A220JAT2A	AVX		
C9	1	330 pF	Capacitor, ceramic, 330 pF, 50 V, \pm 5%, C0G/NPO, 0603	0603	C0603C331J5GACTU	Kemet		
C12	1	220 pF	Capacitor, ceramic, 220 pF, 50 V, \pm 5%, C0G/NPO, 0603	0603	C1608C0G1H221J	TDK		
C13	1	2200 pF	Capacitor, ceramic, 2200 pF, 50 V, \pm 5%, C0G/NPO, 0603	0603	GRM1885C1H222JA01D	MuRata		
C15	1	0.047 μ F	Capacitor, ceramic, 0.047 μ F, 50 V, \pm 10%, X7R, 0603	0603	C1608X7R1H473K	TDK		
C16	1	4.7 μ F	Capacitor, ceramic, 4.7 μ F, 50 V, \pm 10%, X7R, 1206	1206	GRM31CR71H475KA12L	MuRata		
C17	1	1500 pF	Capacitor, ceramic, 1500 pF, 50 V, \pm 10%, X7R, 0603	0603	GRM188R71H152KA01D	MuRata		
D1, D2	2	60 V	Diode, Schottky, 60 V, 3 A, PowerDI5	PowerDI5	PDS360-13	Diodes Inc.		
D3	1	5.1 V	Diode, Zener, 5.1 V, 1 W, SMA	SMA	SMAZ5V1-13-F	Diodes Inc.		
FB, PH, RST, SYNC, TP2, VBATT, VIN, VOUT	8	Red	Test Point, Miniature, Red, TH	Red Miniature Testpoint	5000	Keystone		
J1, J2	2		Terminal Block, 6 A, 3.5 mm Pitch, 2-Pos, TH	7.0x8.2x6.5mm	ED555/2DS	On-Shore Technology		
JP1, JP3, JP4	3		Header, 100 mil, 3 \times 2, Tin, TH	3x2 Header	PEC03DAAN	Sullins Connector Solutions		
JP2	1		Header, male, 3 \times 1, 100 mil, RA, TH	Header, 3x1, RA	PEC03SBAN	Sullins Connector Solutions		
L1, L2	2	22 μ H	Inductor, Shielded Drum Core, Ferrite, 22 μ H, 4 A, 0.04 Ω , SMD	MSS1278T	MSS1278T-223MLB	Coilcraft		

Table 4. TPS54362BEVM Bill of Materials for a 500-kHz Configuration (continued)

DESIGNATOR	QUANTITY	VALUE	DESCRIPTION	PACKAGE REFERENCE	PART NUMBER	MANUFACTURER	ALTERNATE PART NUMBER	ALTERNATE MANUFACTURER
LBL1	1		Thermal Transfer Printable Labels, 0.650" W x 0.200" H - 10,000 per roll	PCB Label 0.650"H x 0.200"W	THT-14-423-10	Brady	-	-
R1	1	187 kΩ	Resistor, 187 kΩ, 1%, 0.1 W, 0603	0603	RC0603FR-07187KL	Yageo America		
R2	1	35.7 kΩ	Resistor, 35.7 kΩ, 1%, 0.1 W, 0603	0603	CRCW060335K7FKEA	Vishay-Dale		
R3	1	221 kΩ	Resistor, 221 kΩ, 1%, 0.1 W, 0603	0603	RC0603FR-07221KL	Yageo America		
R4	1	2 kΩ	Resistor, 2.00 kΩ, 1%, 0.1 W, 0603	0603	CRCW06032K00FKEA	Vishay-Dale		
R5, R6, R8	3	30.1 kΩ	Resistor, 30.1 kΩ, 1%, 0.1 W, 0603	0603	CRCW060330K1FKEA	Vishay-Dale		
R9	1	68.1 kΩ	Resistor, 68.1 kΩ, 1%, 0.1 W, 0603	0603	CRCW060368K1FKEA	Vishay-Dale		
R10	1	47 kΩ	Resistor, 47 kΩ, 1%, 0.1 W, 0603	0603	RC0603FR-0747KL	Yageo America		
R11	1	49.9 Ω	Resistor, 49.9 Ω, 1%, 0.1 W, 0603	0603	CRCW060349R9FKEA	Vishay-Dale		
R12	1	274 kΩ	Resistor, 274 kΩ, 1%, 0.1 W, 0603	0603	CRCW0603274KFKEA	Vishay-Dale		
R13	1	2.55 kΩ	Resistor, 2.55 kΩ, 1%, 0.1 W, 0603	0603	CRCW06032K55FKEA	Vishay-Dale		
R14	1	82.5 kΩ	Resistor, 82.5 kΩ, 1%, 0.1 W, 0603	0603	CRCW060382K5FKEA	Vishay-Dale		
R15	1	2.26 kΩ	Resistor, 2.26 kΩ, 1%, 0.1 W, 0603	0603	CRCW06032K26FKEA	Vishay-Dale		
R16	1	15 kΩ	Resistor, 15.0 kΩ, 1%, 0.1 W, 0603	0603	CRCW060315K0FKEA	Vishay-Dale		
R17	1	0 Ω	Resistor, 0 Ω, 5%, 0.1 W, 0603	0603	CRCW06030000Z0EA	Vishay-Dale		
R18	1	10 Ω	Resistor, 10 Ω, 1%, 0.1 W, 0603	0603	RC0603FR-0710RL	Yageo America		
SH-JP1A, SH-JP1B, SH-JP1C, SH-JP2, SH-JP3A, SH-JP3B, SH-JP3C, SH-JP4A, SH-JP4B, SH-JP4C	10	1 × 2	Shunt, 100 mil, Gold plated, Black	Shunt	969102-0000-DA	3M	SNT-100-BK-G	Samtec
U1	1	TPS54362BQP WPRQ1	IC, 3 A, 60 V step down DC/DC converter with low I _Q	PWP20	TPS54362BQPWPRQ1	TI		None
FID1, FID2, FID3	0		Fiducial mark. There is nothing to buy or mount.	Fiducial	N/A	N/A		
R7	0	0	Resistor, 0 Ω, 5%, 0.1 W, 0603	0603	CRCW06030000Z0EA	Vishay-Dale		

ADDITIONAL TERMS AND CONDITIONS, WARNINGS, RESTRICTIONS, AND DISCLAIMERS FOR EVALUATION MODULES

Texas Instruments Incorporated (TI) markets, sells, and loans all evaluation boards, kits, and/or modules (EVMs) pursuant to, and user expressly acknowledges, represents, and agrees, and takes sole responsibility and risk with respect to, the following:

1. User agrees and acknowledges that EVMs are intended to be handled and used for feasibility evaluation only in laboratory and/or development environments. Notwithstanding the foregoing, in certain instances, TI makes certain EVMs available to users that do not handle and use EVMs solely for feasibility evaluation only in laboratory and/or development environments, but may use EVMs in a hobbyist environment. All EVMs made available to hobbyist users are FCC certified, as applicable. Hobbyist users acknowledge, agree, and shall comply with all applicable terms, conditions, warnings, and restrictions in this document and are subject to the disclaimer and indemnity provisions included in this document.
2. Unless otherwise indicated, EVMs are not finished products and not intended for consumer use. EVMs are intended solely for use by technically qualified electronics experts who are familiar with the dangers and application risks associated with handling electrical mechanical components, systems, and subsystems.
3. User agrees that EVMs shall not be used as, or incorporated into, all or any part of a finished product.
4. User agrees and acknowledges that certain EVMs may not be designed or manufactured by TI.
5. User must read the user's guide and all other documentation accompanying EVMs, including without limitation any warning or restriction notices, prior to handling and/or using EVMs. Such notices contain important safety information related to, for example, temperatures and voltages. For additional information on TI's environmental and/or safety programs, please visit www.ti.com/esh or contact TI.
6. User assumes all responsibility, obligation, and any corresponding liability for proper and safe handling and use of EVMs.
7. Should any EVM not meet the specifications indicated in the user's guide or other documentation accompanying such EVM, the EVM may be returned to TI within 30 days from the date of delivery for a full refund. THE FOREGOING LIMITED WARRANTY IS THE EXCLUSIVE WARRANTY MADE BY TI TO USER AND IS IN LIEU OF ALL OTHER WARRANTIES, EXPRESSED, IMPLIED, OR STATUTORY, INCLUDING ANY WARRANTY OF MERCHANTABILITY OR FITNESS FOR ANY PARTICULAR PURPOSE. TI SHALL NOT BE LIABLE TO USER FOR ANY INDIRECT, SPECIAL, INCIDENTAL, OR CONSEQUENTIAL DAMAGES RELATED TO THE HANDLING OR USE OF ANY EVM.
8. No license is granted under any patent right or other intellectual property right of TI covering or relating to any machine, process, or combination in which EVMs might be or are used. TI currently deals with a variety of customers, and therefore TI's arrangement with the user is not exclusive. TI assumes no liability for applications assistance, customer product design, software performance, or infringement of patents or services with respect to the handling or use of EVMs.
9. User assumes sole responsibility to determine whether EVMs may be subject to any applicable federal, state, or local laws and regulatory requirements (including but not limited to U.S. Food and Drug Administration regulations, if applicable) related to its handling and use of EVMs and, if applicable, compliance in all respects with such laws and regulations.
10. User has sole responsibility to ensure the safety of any activities to be conducted by it and its employees, affiliates, contractors or designees, with respect to handling and using EVMs. Further, user is responsible to ensure that any interfaces (electronic and/or mechanical) between EVMs and any human body are designed with suitable isolation and means to safely limit accessible leakage currents to minimize the risk of electrical shock hazard.
11. User shall employ reasonable safeguards to ensure that user's use of EVMs will not result in any property damage, injury or death, even if EVMs should fail to perform as described or expected.
12. User shall be solely responsible for proper disposal and recycling of EVMs consistent with all applicable federal, state, and local requirements.

Certain Instructions. User shall operate EVMs within TI's recommended specifications and environmental considerations per the user's guide, accompanying documentation, and any other applicable requirements. Exceeding the specified ratings (including but not limited to input and output voltage, current, power, and environmental ranges) for EVMs may cause property damage, personal injury or death. If there are questions concerning these ratings, user should contact a TI field representative prior to connecting interface electronics including input power and intended loads. Any loads applied outside of the specified output range may result in unintended and/or inaccurate operation and/or possible permanent damage to the EVM and/or interface electronics. Please consult the applicable EVM user's guide prior to connecting any load to the EVM output. If there is uncertainty as to the load specification, please contact a TI field representative. During normal operation, some circuit components may have case temperatures greater than 60°C as long as the input and output are maintained at a normal ambient operating temperature. These components include but are not limited to linear regulators, switching transistors, pass transistors, and current sense resistors which can be identified using EVMs' schematics located in the applicable EVM user's guide. When placing measurement probes near EVMs during normal operation, please be aware that EVMs may become very warm. As with all electronic evaluation tools, only qualified personnel knowledgeable in electronic measurement and diagnostics normally found in development environments should use EVMs.

Agreement to Defend, Indemnify and Hold Harmless. User agrees to defend, indemnify, and hold TI, its directors, officers, employees, agents, representatives, affiliates, licensors and their representatives harmless from and against any and all claims, damages, losses, expenses, costs and liabilities (collectively, "Claims") arising out of, or in connection with, any handling and/or use of EVMs. User's indemnity shall apply whether Claims arise under law of tort or contract or any other legal theory, and even if EVMs fail to perform as described or expected.

Safety-Critical or Life-Critical Applications. If user intends to use EVMs in evaluations of safety critical applications (such as life support), and a failure of a TI product considered for purchase by user for use in user's product would reasonably be expected to cause severe personal injury or death such as devices which are classified as FDA Class III or similar classification, then user must specifically notify TI of such intent and enter into a separate Assurance and Indemnity Agreement.

RADIO FREQUENCY REGULATORY COMPLIANCE INFORMATION FOR EVALUATION MODULES

Texas Instruments Incorporated (TI) evaluation boards, kits, and/or modules (EVMs) and/or accompanying hardware that is marketed, sold, or loaned to users may or may not be subject to radio frequency regulations in specific countries.

General Statement for EVMs Not Including a Radio

For EVMs not including a radio and not subject to the U.S. Federal Communications Commission (FCC) or Industry Canada (IC) regulations, TI intends EVMs to be used only for engineering development, demonstration, or evaluation purposes. EVMs are not finished products typically fit for general consumer use. EVMs may nonetheless generate, use, or radiate radio frequency energy, but have not been tested for compliance with the limits of computing devices pursuant to part 15 of FCC or the ICES-003 rules. Operation of such EVMs may cause interference with radio communications, in which case the user at his own expense will be required to take whatever measures may be required to correct this interference.

General Statement for EVMs including a radio

User Power/Frequency Use Obligations: For EVMs including a radio, the radio included in such EVMs is intended for development and/or professional use only in legally allocated frequency and power limits. Any use of radio frequencies and/or power availability in such EVMs and their development application(s) must comply with local laws governing radio spectrum allocation and power limits for such EVMs. It is the user's sole responsibility to only operate this radio in legally acceptable frequency space and within legally mandated power limitations. Any exceptions to this are strictly prohibited and unauthorized by TI unless user has obtained appropriate experimental and/or development licenses from local regulatory authorities, which is the sole responsibility of the user, including its acceptable authorization.

U.S. Federal Communications Commission Compliance

For EVMs Annotated as FCC – FEDERAL COMMUNICATIONS COMMISSION Part 15 Compliant

Caution

This device complies with part 15 of the FCC Rules. Operation is subject to the following two conditions: (1) This device may not cause harmful interference, and (2) this device must accept any interference received, including interference that may cause undesired operation. Changes or modifications could void the user's authority to operate the equipment.

FCC Interference Statement for Class A EVM devices

This equipment has been tested and found to comply with the limits for a Class A digital device, pursuant to part 15 of the FCC Rules. These limits are designed to provide reasonable protection against harmful interference when the equipment is operated in a commercial environment. This equipment generates, uses, and can radiate radio frequency energy and, if not installed and used in accordance with the instruction manual, may cause harmful interference to radio communications. Operation of this equipment in a residential area is likely to cause harmful interference in which case the user will be required to correct the interference at its own expense.

FCC Interference Statement for Class B EVM devices

This equipment has been tested and found to comply with the limits for a Class B digital device, pursuant to part 15 of the FCC Rules. These limits are designed to provide reasonable protection against harmful interference in a residential installation. This equipment generates, uses and can radiate radio frequency energy and, if not installed and used in accordance with the instructions, may cause harmful interference to radio communications. However, there is no guarantee that interference will not occur in a particular installation. If this equipment does cause harmful interference to radio or television reception, which can be determined by turning the equipment off and on, the user is encouraged to try to correct the interference by one or more of the following measures:

- Reorient or relocate the receiving antenna.
- Increase the separation between the equipment and receiver.
- Connect the equipment into an outlet on a circuit different from that to which the receiver is connected.
- Consult the dealer or an experienced radio/TV technician for help.

Industry Canada Compliance (English)

For EVMs Annotated as IC – INDUSTRY CANADA Compliant:

This Class A or B digital apparatus complies with Canadian ICES-003.

Changes or modifications not expressly approved by the party responsible for compliance could void the user's authority to operate the equipment.

Concerning EVMs Including Radio Transmitters

This device complies with Industry Canada licence-exempt RSS standard(s). Operation is subject to the following two conditions: (1) this device may not cause interference, and (2) this device must accept any interference, including interference that may cause undesired operation of the device.

Concerning EVMs Including Detachable Antennas

Under Industry Canada regulations, this radio transmitter may only operate using an antenna of a type and maximum (or lesser) gain approved for the transmitter by Industry Canada. To reduce potential radio interference to other users, the antenna type and its gain should be so chosen that the equivalent isotropically radiated power (e.i.r.p.) is not more than that necessary for successful communication.

This radio transmitter has been approved by Industry Canada to operate with the antenna types listed in the user guide with the maximum permissible gain and required antenna impedance for each antenna type indicated. Antenna types not included in this list, having a gain greater than the maximum gain indicated for that type, are strictly prohibited for use with this device.

Canada Industry Canada Compliance (French)

Cet appareil numérique de la classe A ou B est conforme à la norme NMB-003 du Canada

Les changements ou les modifications pas expressément approuvés par la partie responsable de la conformité ont pu vider l'autorité de l'utilisateur pour actionner l'équipement.

Concernant les EVMs avec appareils radio

Le présent appareil est conforme aux CNR d'Industrie Canada applicables aux appareils radio exempts de licence. L'exploitation est autorisée aux deux conditions suivantes : (1) l'appareil ne doit pas produire de brouillage, et (2) l'utilisateur de l'appareil doit accepter tout brouillage radioélectrique subi, même si le brouillage est susceptible d'en compromettre le fonctionnement.

Concernant les EVMs avec antennes détachables

Conformément à la réglementation d'Industrie Canada, le présent émetteur radio peut fonctionner avec une antenne d'un type et d'un gain maximal (ou inférieur) approuvé pour l'émetteur par Industrie Canada. Dans le but de réduire les risques de brouillage radioélectrique à l'intention des autres utilisateurs, il faut choisir le type d'antenne et son gain de sorte que la puissance isotrope rayonnée équivalente (p.i.r.e.) ne dépasse pas l'intensité nécessaire à l'établissement d'une communication satisfaisante.

Le présent émetteur radio a été approuvé par Industrie Canada pour fonctionner avec les types d'antenne énumérés dans le manuel d'usage et ayant un gain admissible maximal et l'impédance requise pour chaque type d'antenne. Les types d'antenne non inclus dans cette liste, ou dont le gain est supérieur au gain maximal indiqué, sont strictement interdits pour l'exploitation de l'émetteur.

Mailing Address: Texas Instruments, Post Office Box 655303, Dallas, Texas 75265
Copyright © 2014, Texas Instruments Incorporated

Important Notice for Users of EVMs Considered “Radio Frequency Products” in Japan

EVMs entering Japan are NOT certified by TI as conforming to Technical Regulations of Radio Law of Japan.

If user uses EVMs in Japan, user is required by Radio Law of Japan to follow the instructions below with respect to EVMs:

1. Use EVMs in a shielded room or any other test facility as defined in the notification #173 issued by Ministry of Internal Affairs and Communications on March 28, 2006, based on Sub-section 1.1 of Article 6 of the Ministry's Rule for Enforcement of Radio Law of Japan,
2. Use EVMs only after user obtains the license of Test Radio Station as provided in Radio Law of Japan with respect to EVMs, or
3. Use of EVMs only after user obtains the Technical Regulations Conformity Certification as provided in Radio Law of Japan with respect to EVMs. Also, do not transfer EVMs, unless user gives the same notice above to the transferee. Please note that if user does not follow the instructions above, user will be subject to penalties of Radio Law of Japan.

<http://www.tij.co.jp>

【無線電波を送信する製品の開発キットをお使いになる際の注意事項】 本開発キットは技術基準適合証明を受けておりません。本製品のご使用に際しては、電波法遵守のため、以下のいずれかの措置を取っていただく必要がありますのでご注意ください。

1. 電波法施行規則第6条第1項第1号に基づく平成18年3月28日総務省告示第173号で定められた電波暗室等の試験設備でご使用いただく。
2. 実験局の免許を取得後ご使用いただく。
3. 技術基準適合証明を取得後ご使用いただく。。

なお、本製品は、上記の「ご使用にあたっての注意」を譲渡先、移転先に通知しない限り、譲渡、移転できないものとします

上記を遵守頂けない場合は、電波法の罰則が適用される可能性があることをご留意ください。

日本テキサス・インスツルメンツ株式会社

東京都新宿区西新宿6丁目24番1号

西新宿三井ビル

<http://www.tij.co.jp>

Texas Instruments Japan Limited

(address) 24-1, Nishi-Shinjuku 6 chome, Shinjuku-ku, Tokyo, Japan

IMPORTANT NOTICE

Texas Instruments Incorporated and its subsidiaries (TI) reserve the right to make corrections, enhancements, improvements and other changes to its semiconductor products and services per JESD46, latest issue, and to discontinue any product or service per JESD48, latest issue. Buyers should obtain the latest relevant information before placing orders and should verify that such information is current and complete. All semiconductor products (also referred to herein as "components") are sold subject to TI's terms and conditions of sale supplied at the time of order acknowledgment.

TI warrants performance of its components to the specifications applicable at the time of sale, in accordance with the warranty in TI's terms and conditions of sale of semiconductor products. Testing and other quality control techniques are used to the extent TI deems necessary to support this warranty. Except where mandated by applicable law, testing of all parameters of each component is not necessarily performed.

TI assumes no liability for applications assistance or the design of Buyers' products. Buyers are responsible for their products and applications using TI components. To minimize the risks associated with Buyers' products and applications, Buyers should provide adequate design and operating safeguards.

TI does not warrant or represent that any license, either express or implied, is granted under any patent right, copyright, mask work right, or other intellectual property right relating to any combination, machine, or process in which TI components or services are used. Information published by TI regarding third-party products or services does not constitute a license to use such products or services or a warranty or endorsement thereof. Use of such information may require a license from a third party under the patents or other intellectual property of the third party, or a license from TI under the patents or other intellectual property of TI.

Reproduction of significant portions of TI information in TI data books or data sheets is permissible only if reproduction is without alteration and is accompanied by all associated warranties, conditions, limitations, and notices. TI is not responsible or liable for such altered documentation. Information of third parties may be subject to additional restrictions.

Resale of TI components or services with statements different from or beyond the parameters stated by TI for that component or service voids all express and any implied warranties for the associated TI component or service and is an unfair and deceptive business practice. TI is not responsible or liable for any such statements.

Buyer acknowledges and agrees that it is solely responsible for compliance with all legal, regulatory and safety-related requirements concerning its products, and any use of TI components in its applications, notwithstanding any applications-related information or support that may be provided by TI. Buyer represents and agrees that it has all the necessary expertise to create and implement safeguards which anticipate dangerous consequences of failures, monitor failures and their consequences, lessen the likelihood of failures that might cause harm and take appropriate remedial actions. Buyer will fully indemnify TI and its representatives against any damages arising out of the use of any TI components in safety-critical applications.

In some cases, TI components may be promoted specifically to facilitate safety-related applications. With such components, TI's goal is to help enable customers to design and create their own end-product solutions that meet applicable functional safety standards and requirements. Nonetheless, such components are subject to these terms.

No TI components are authorized for use in FDA Class III (or similar life-critical medical equipment) unless authorized officers of the parties have executed a special agreement specifically governing such use.

Only those TI components which TI has specifically designated as military grade or "enhanced plastic" are designed and intended for use in military/aerospace applications or environments. Buyer acknowledges and agrees that any military or aerospace use of TI components which have **not** been so designated is solely at the Buyer's risk, and that Buyer is solely responsible for compliance with all legal and regulatory requirements in connection with such use.

TI has specifically designated certain components as meeting ISO/TS16949 requirements, mainly for automotive use. In any case of use of non-designated products, TI will not be responsible for any failure to meet ISO/TS16949.

Products

Audio	www.ti.com/audio
Amplifiers	amplifier.ti.com
Data Converters	dataconverter.ti.com
DLP® Products	www.dlp.com
DSP	dsp.ti.com
Clocks and Timers	www.ti.com/clocks
Interface	interface.ti.com
Logic	logic.ti.com
Power Mgmt	power.ti.com
Microcontrollers	microcontroller.ti.com
RFID	www.ti-rfid.com
OMAP Applications Processors	www.ti.com/omap
Wireless Connectivity	www.ti.com/wirelessconnectivity

Applications

Automotive and Transportation	www.ti.com/automotive
Communications and Telecom	www.ti.com/communications
Computers and Peripherals	www.ti.com/computers
Consumer Electronics	www.ti.com/consumer-apps
Energy and Lighting	www.ti.com/energy
Industrial	www.ti.com/industrial
Medical	www.ti.com/medical
Security	www.ti.com/security
Space, Avionics and Defense	www.ti.com/space-avionics-defense
Video and Imaging	www.ti.com/video

TI E2E Community

e2e.ti.com