

Using the TPS8804EVM

1 Introduction

The TPS8804EVM is used to evaluate the TPS8804 smoke and CO detector analog front end (AFE) and power management IC. The EVM allows for easy connection from the TPS8804 to a user-supplied photoelectric chamber and carbon monoxide sensor. The TPS8804 GUI interfaces with the EVM to quickly evaluate the photo amplifier, LED driver, and CO amplifier performance, and other blocks with the register map. For a more thorough evaluation, an external microcontroller can be connected to the TPS8804EVM to create a smoke detection system.

1.1 Applications

- Smoke and CO detectors

1.2 Features

- Dual LED drivers for blue and IR LEDs
- Wide bandwidth, low offset photodiode amplifier
- Ultra-low power CO transimpedance amplifier
- LDOs for internal analog blocks and external microcontroller
- Single buffered analog output AMUX for CO and photo signals
- Serial interface for configuring amplifiers, drivers, regulators
- SLC interface for power line communication
- Under-voltage, over-temperature fault monitors
- Wide input voltage range for flexible power supply configuration

1.3 Recommended Equipment

- 4.5-V to 15.5-V power supply capable of 100mA
- USB2ANY™ interface adaptor
- TPS880x GUI software
 - Installation files are available in the TPS8804EVM product folder
- Multimeter for measuring regulator voltages and CO amplifier output
- Oscilloscope for measuring photodiode signal pulse shape

2 Setup

Specific connections on the TPS8804EVM board require configuration before starting the evaluation.

2.1 Sensor Connections

TI recommends connecting a photoelectric smoke chamber and CO sensor to the TPS8804EVM for the evaluation. The TPS8804EVM has a built-in photodiode (D7), blue LED (D8), and IR LED (D6) for functional testing. These components can be de-soldered in order to connect a photoelectric chamber photodiode, IR LED, and/or blue LED in its place. Ensure the photodiode wires are kept short to preserve signal integrity.

The CO sensor is connected to J17 screw terminals with the sensor counter terminal tied to AGND.

2.2 Jumper and Switch Configurations

The S1 switch position determines the VMCU voltage at power-up. Ensure that only one S1 sub-switch is in the ON position. [Table 1](#) displays the VMCU voltage corresponding with each S1 switch position. For proper operation with the USB2ANY adapter, set VMCU to 3.3 V with sub-switch 4.

Table 1. VMCU Power-up Voltage

S1 Switch Position	VMCU
1	1.5V
2	1.8V
3	2.5V
4	3.3V

The J2 jumper connects VSLC to VCC. A single supply connected to VCC powers the entire EVM with the jumper connected.

The J6 jumper selects the I²C device address. Connect J6 to the AGND position to set the address to 0x3F. Connect J6 to the VMCU position to set the address to 0x2A. The GUI is compatible with both options and defaults to 0x2A.

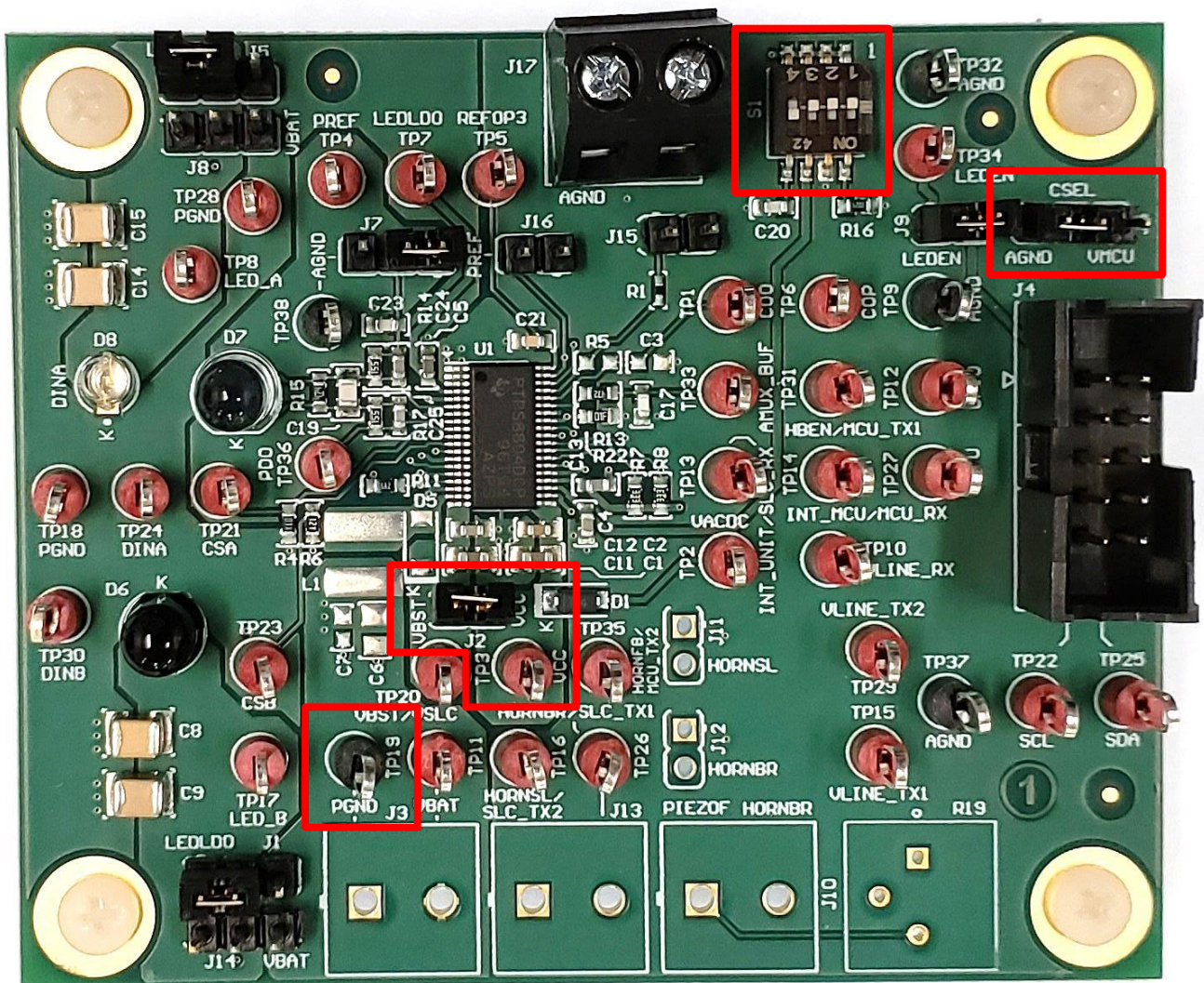

Figure 1. Switch, Jumper, and Power Connections

2.3 Power Connection

Connect the power supply to VCC and PGND. Set the power supply to 5 V, 100 mA. Enable the power supply and measure the voltage on VMCU (TP27) to ensure it is operating at the voltage option selected by S1:

- 1.5 V
- 1.8 V
- 2.5 V
- 3.3 V

See [Table 1](#) for more information on the initial VMCU voltage.

2.4 USB2ANY Connection

Use a USB cable to connect the USB2ANY adapter to a computer with the TPS880x GUI installed. Open the TPS880x GUI and verify the USB2ANY adapter is recognized (see [Figure 2](#)). With the EVM powered, connect the USB2ANY adapter to the EVM using the USB2ANY adapter 10-pin ribbon cable. Click **EXPLORE TPS8804EVM** then **QUICK START** and select the device address corresponding to the J6 jumper (see [Section 2.2](#)). Send the test command to verify the EVM, USB2ANY adapter, and GUI software are all connected.

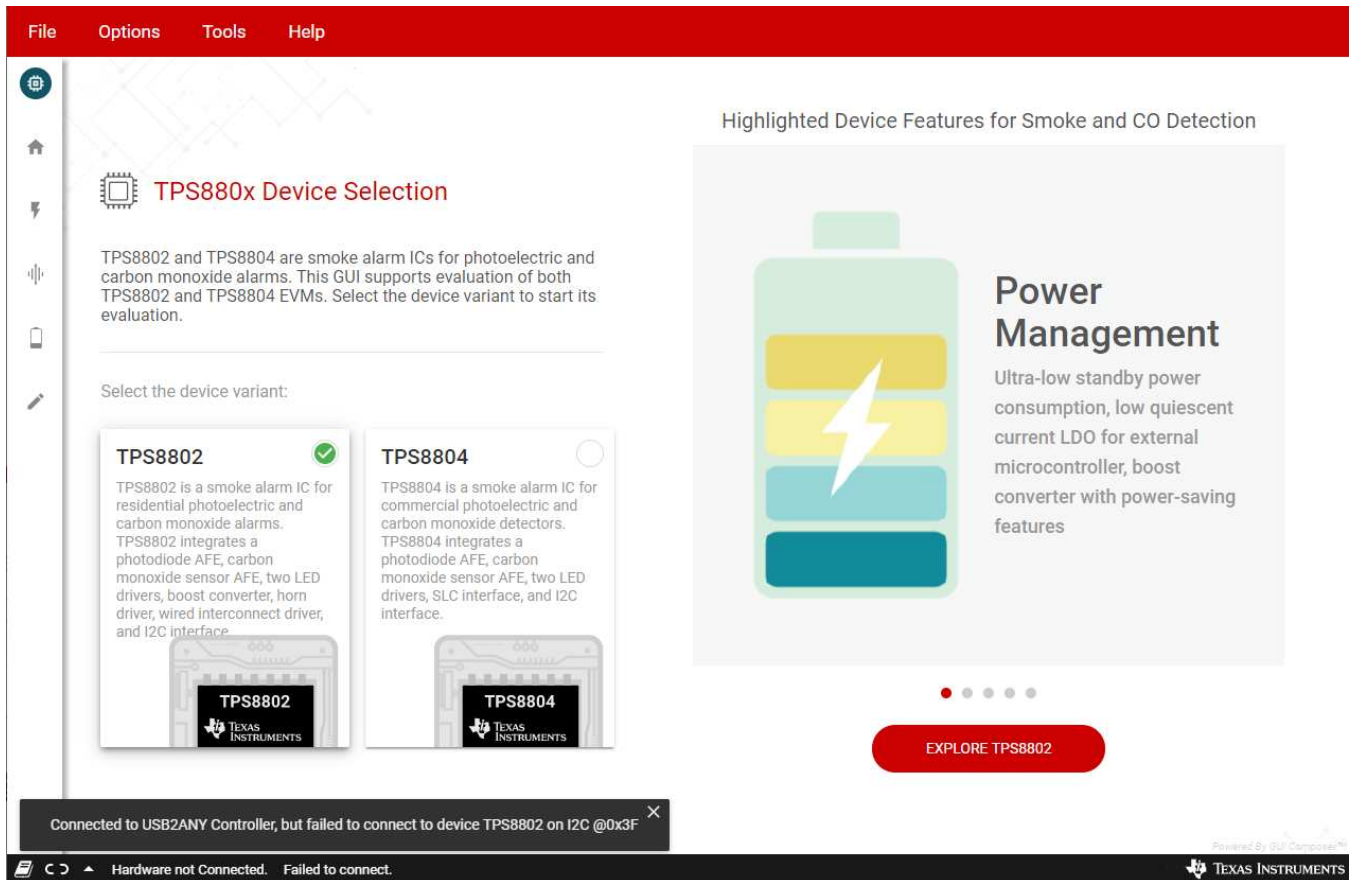

Figure 2. TPS880x GUI Connected to USB2ANY Adapter

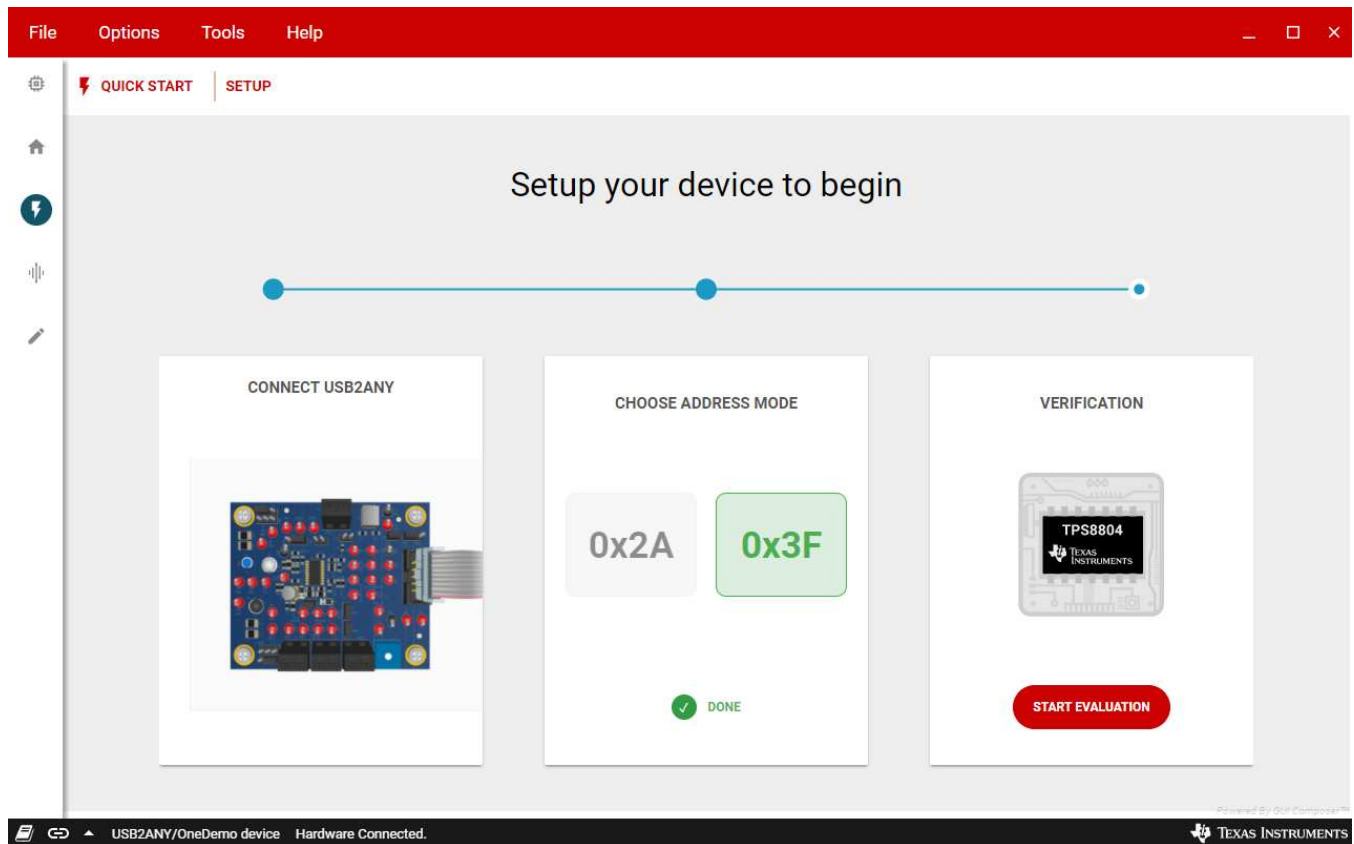

Figure 3. Test Command Successful

3 Analog Evaluation

Click **START EVALUATION** and select the feature to evaluate. The **Analog Front End** section guides the CO AFE and photo AFE evaluation. Enter the register map to evaluate the other blocks in the TPS8804 device.

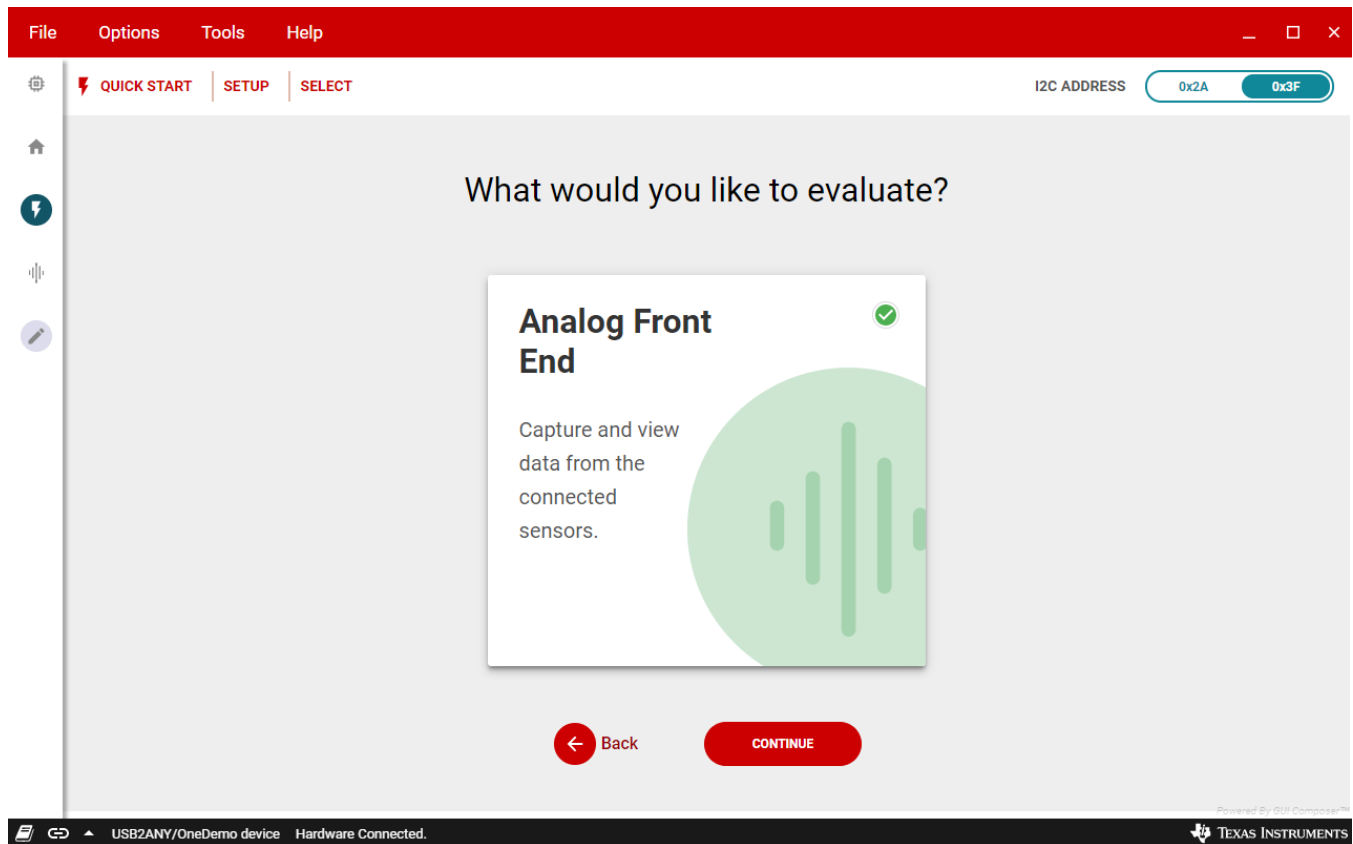

Figure 4. Evaluation Selection Menu

3.1 CO AFE Evaluation

If a CO sensor is available, connect it to the J17 terminal block. Select the feedback resistance and reference voltage in the GUI software. The TPS8804EVM default configuration uses the internal resistors and references. To use an external feedback resistor, solder a resistor to R5. To use an external input resistor, replace the R1 0-Ω resistor with the required input resistance. The output resistor filters the CO amplifier output when a capacitor is installed on C3.

Set the **AMUX SELECTION** to **CO AMPLIFIER**. Enable the CO amplifier and measure the voltage on AMUX_BUF.

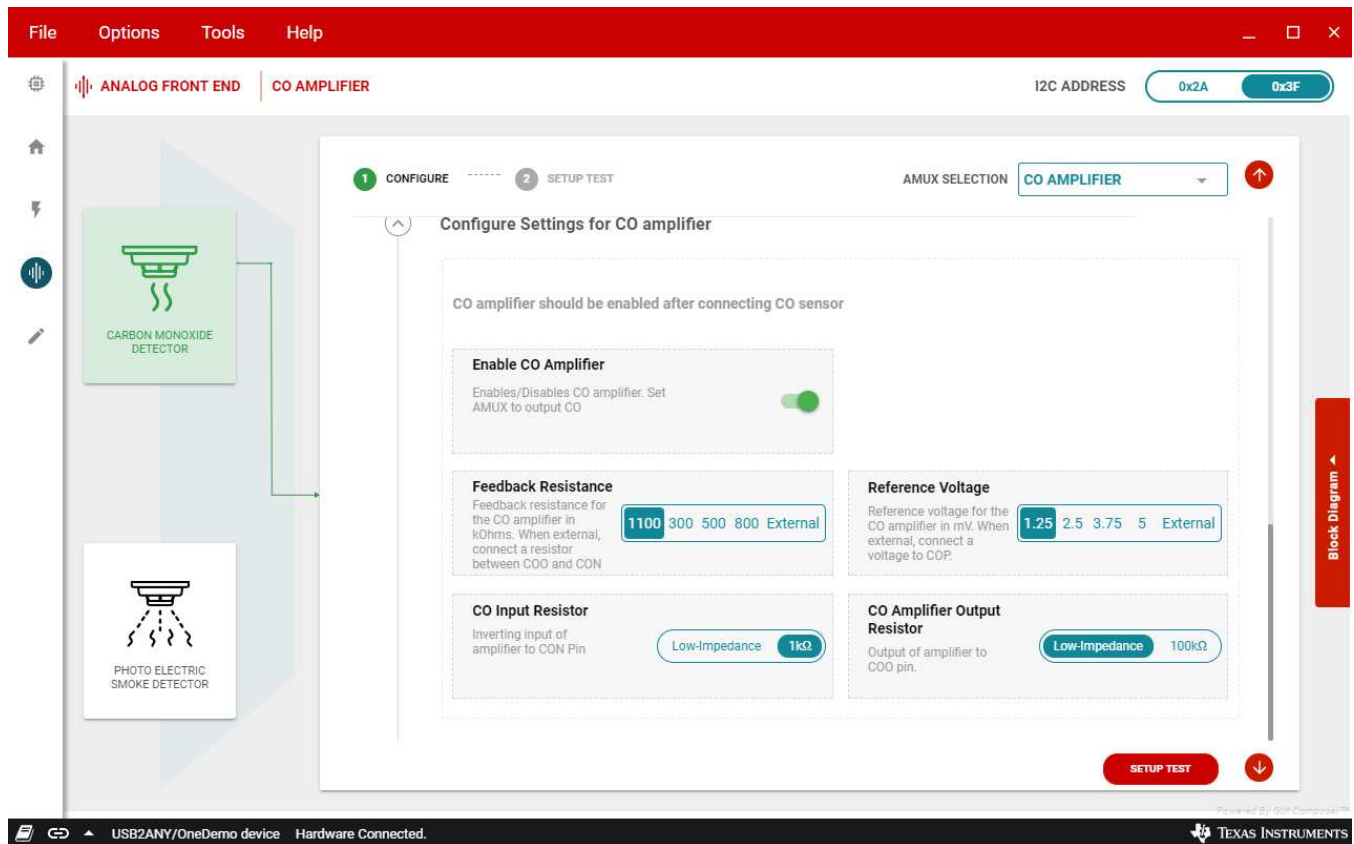

Figure 5. CO Amplifier Settings

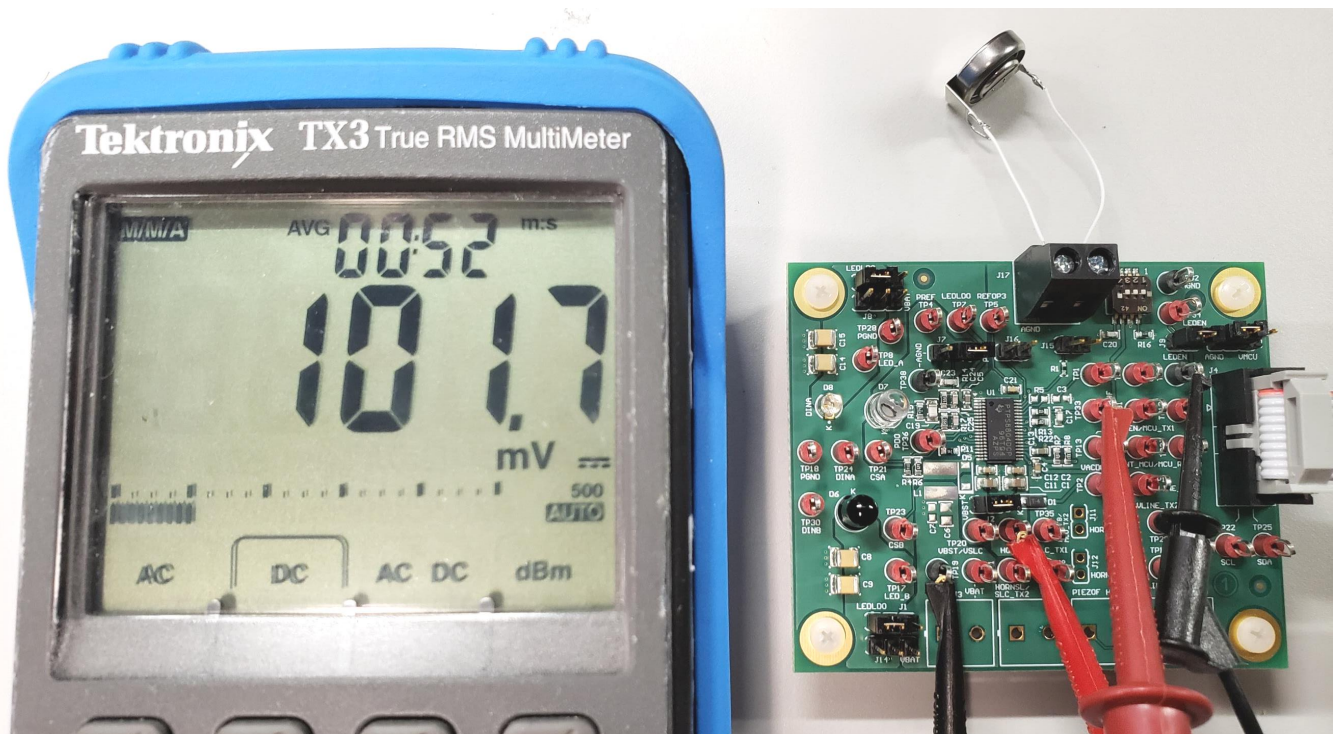

Figure 6. Clean Air CO Amplifier Output

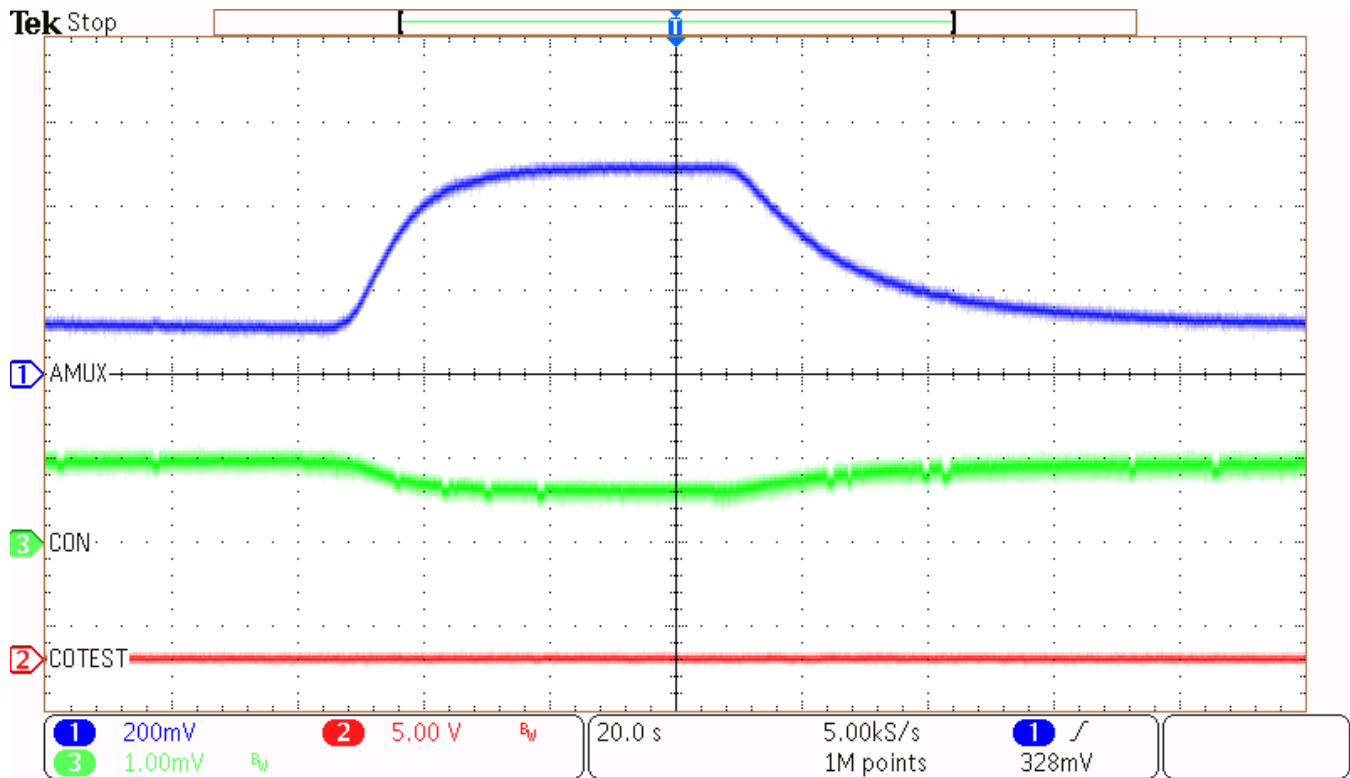

Figure 7. CO Amplifier Output with Sensor and Calibration Gas

3.1.1 CO Connectivity Test

A simple test confirms that the CO sensor is connected to the EVM. Remove the shunt connected to J7 and connect a shunt to J15 and J16. Write `COTEST_EN = 1` and measure the pulse shape on `AMUX_BUF` using an oscilloscope. When `COTEST_EN = 1`, the `PREF` pin is pulled low and injects charge into the CO sensor and amplifier. The `AMUX` pulse shape is different if the CO sensor is disconnected. Write `COTEST_EN = 0`, remove the J15 and J16 shunts, and connect the J7 shunt when finished.

The screenshot shows the Register Map tool interface. The 'Register Map' table lists various registers, with the 'CO REGISTER' at address 0x0D highlighted. The bitfield view on the right shows the 'CO REGISTER' with bits 7-0. The 'COTEST_EN' and 'COAMP_EN' bits are checked, indicating they are set to 1. The 'COTEST_EN' bit is highlighted with a blue circle.

Register Name	Address	Value	7	6	5	4	3	2	1	0
INTERRUPT MASK REGISTER	0x03	0x00	-	0	0	0	0	-	-	0
CONFIGURATION REGISTERS										
CONFIG1 REGISTER	0x04	0x38	0	0	1	1	1	-	-	-
CONFIG2 REGISTER	0x05	0x02	-	-	0	-	-	-	-	-
ENABLE REGISTERS										
ENABLE1 REGISTER	0x06	0x10	-	-	0	-	0	0	-	0
ENABLE2 REGISTER	0x07	0x00	0	-	-	-	-	0	0	-
CONTROL REGISTERS										
CONTROL REGISTER	0x08	0x00	-	-	0	0	0	0	0	-
GPIO AMUX REGISTER										
GPIO AMUX REGISTER	0x0B	0x10	0	-	0	1	-	0	0	0
CO SWITCH AND BATTERY TEST REGISTER										
CO SWITCH AND BATTERY TEST REGISTER	0x0C	0x70	0	1	1	1	-	-	-	-
CO REGISTER										
CO REGISTER	0x0D	0x03	0	0	0	0	0	0	1	1
LEDLDO REGISTER										
LEDLDO REGISTER	0x0F	0x00	-	-	-	-	0	0	0	-
PHOTO CONTROL REGISTER										
PHOTO CONTROL REGISTER	0x10	0x00	-	0	0	0	0	0	0	0
LED DAC A REGISTER										
LED DAC A REGISTER	0x11	0x00	0	0	0	0	0	0	0	0

Figure 8. COTEST_EN Register Bit



Figure 9. CO Connectivity Test without Sensor

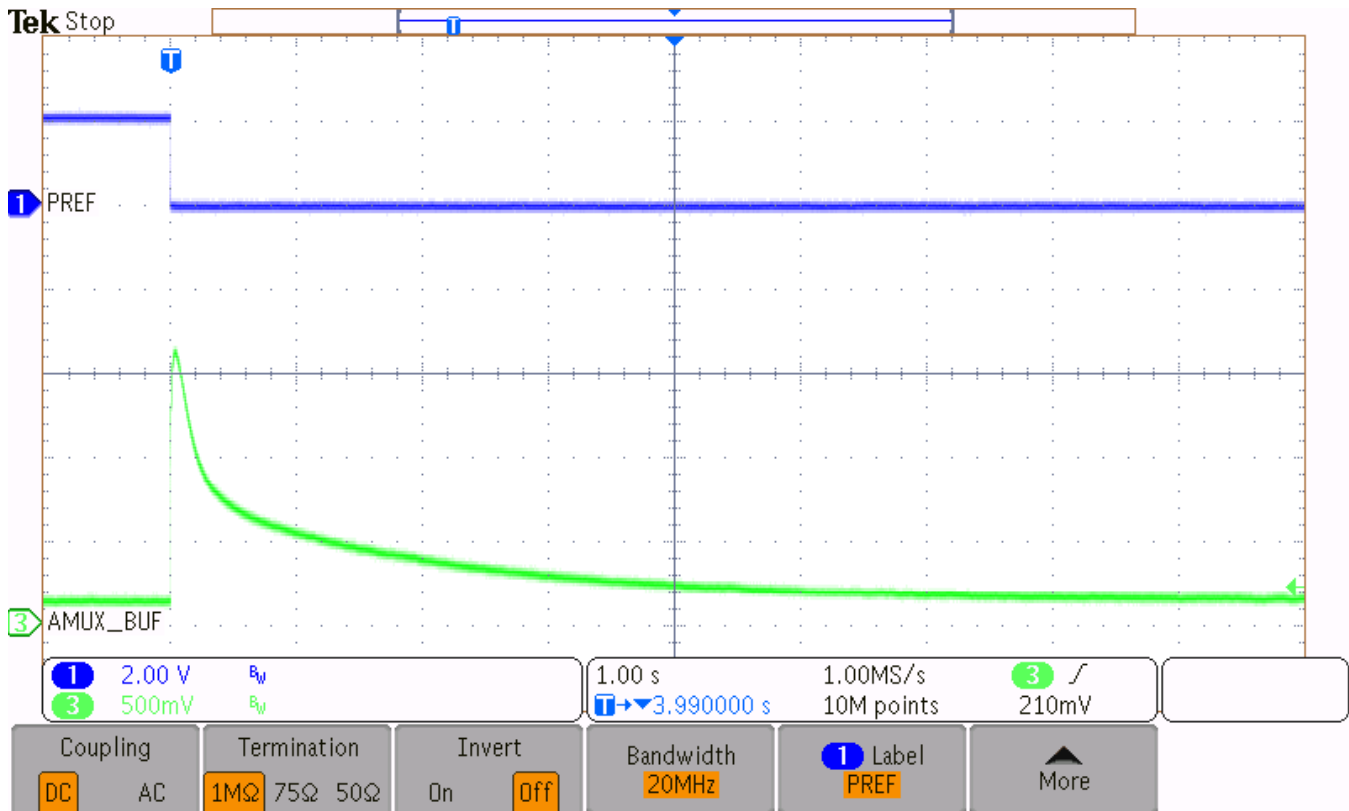

Figure 10. CO Connectivity Test with Sensor

3.2 Photo AFE Evaluation

Connect the photoelectric chamber to the EVM. If a photoelectric chamber is not available, place a box over the EVM to block ambient light and reflect the EVM LED light into the photodiode when testing the photo AFE.

Enable the photo amplifier, photo gain amplifier, and set the **AMUX SELECTION** to **PHOTO GAIN AMPLIFIER**. Select the photo reference on the EVM with jumper J7 and enable the photo reference voltage if the reference is set to PREF. Set the gain factor to the required value. If no extra gain is required, set the **AMUX SELECTION** to **PHOTO AMPLIFIER**.

It is recommended to install a 470 kΩ resistor connecting PREF to VINT if the photo gain is set to 11x, 20x, or 35x. The 470 kΩ resistor changes the PREF voltage to 70mV and prevents the gain stage output from dropping below 50mV in worst-case conditions.

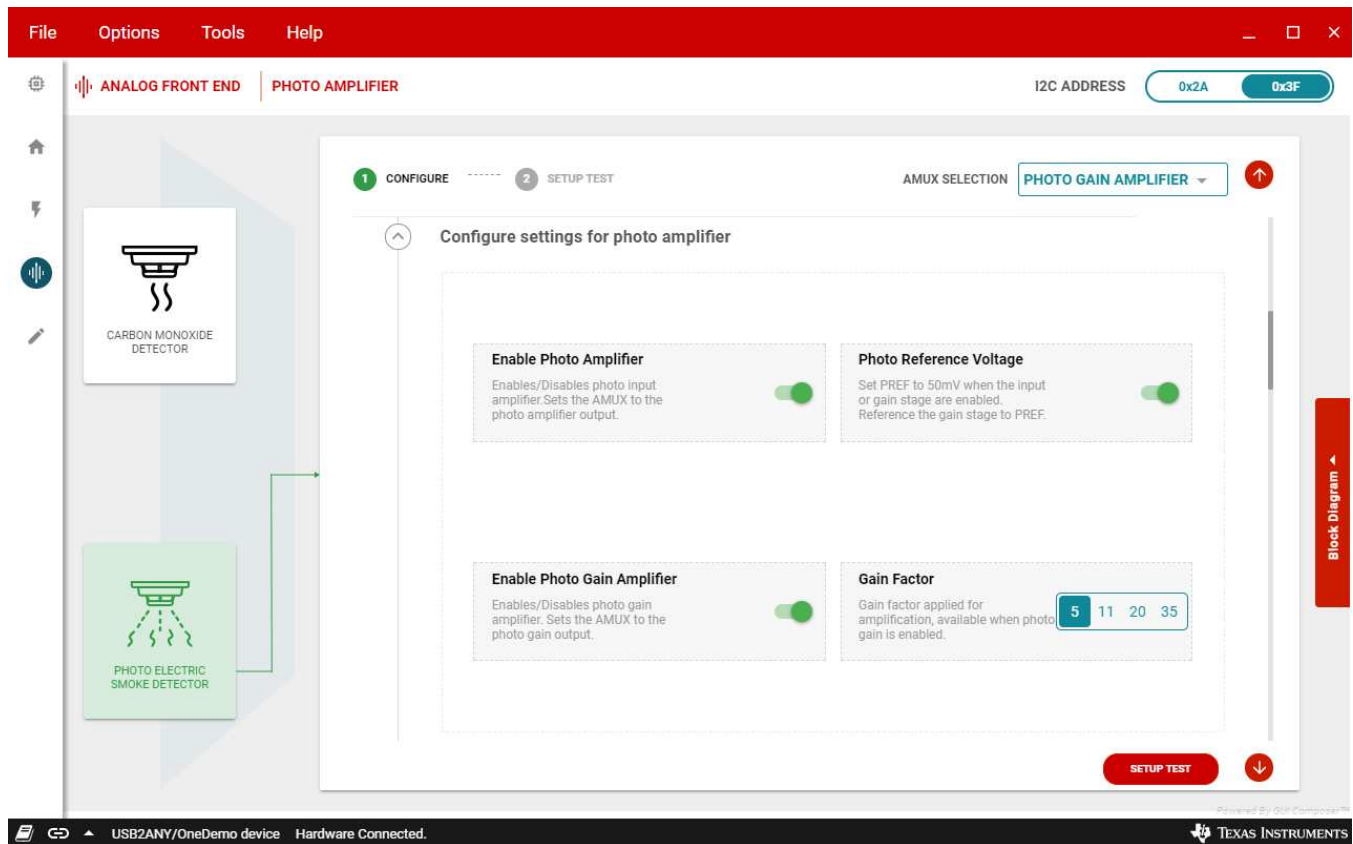

Figure 11. Photo Amplifier Settings

Configure the power to the LEDs. By default, LED A and LED B are connected to LEDLDO. Use the J1, J5, J8, and J14 jumpers to select which supply powers each LED. Enable the LEDLDO if it powers either LED.

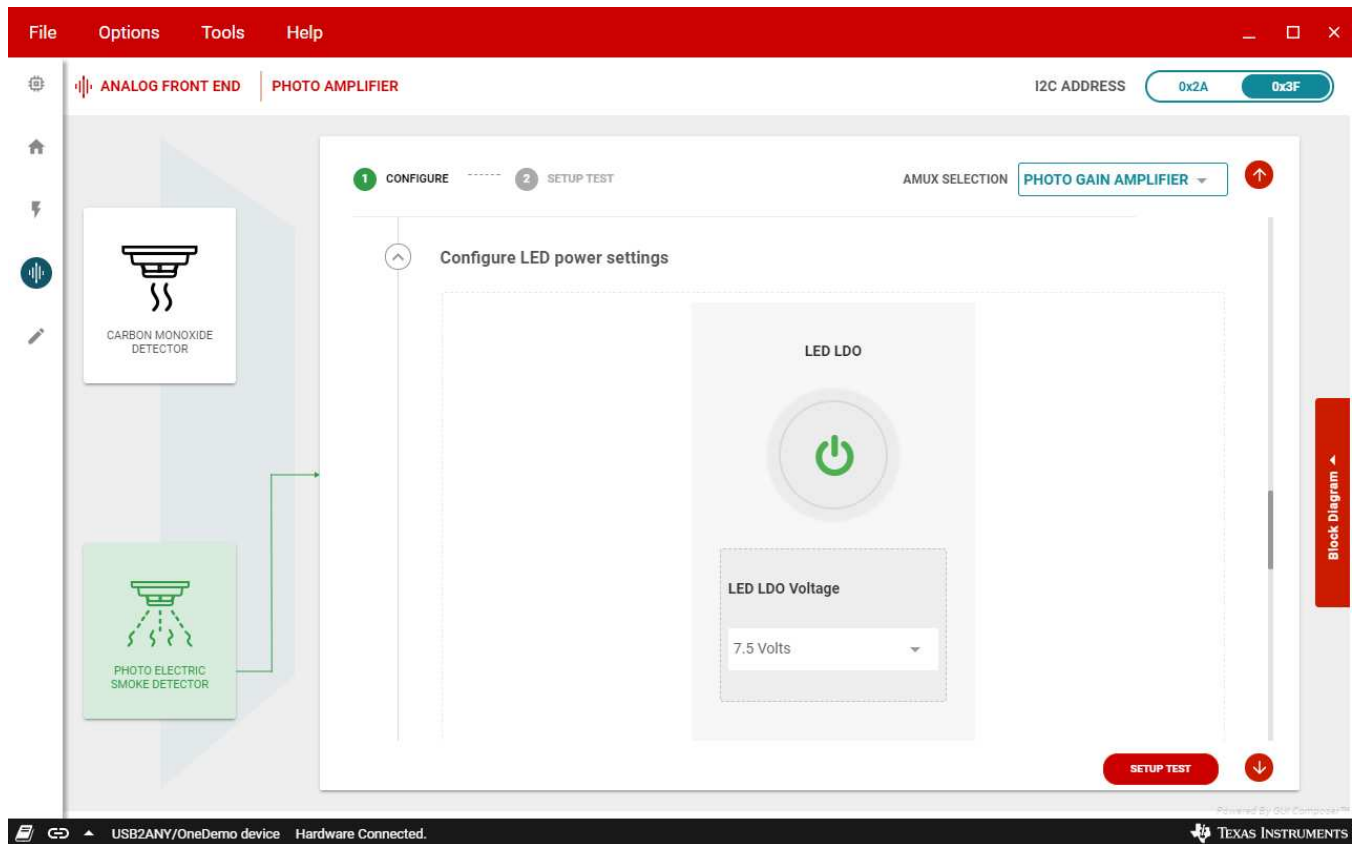

Figure 12. LED Power Supply Settings

Configure the PWM pulse settings for the LED driver. The default setting 201 ms pulse rate and 1 ms pulse width sufficiently tests the LED driver. This setting controls the PWM signal from the USB2ANY adapter to the EVM.

Configure the LED current for each driver. The default EVM CSA resistance is 10 Ω and the default EVM CSB resistance is 1.3 Ω . These resistors can be switched on the EVM to change the LED current and temperature compensation. Set the DAC voltage to fine tune the LED current. Set the temperature coefficient to the required setting. Click **SETUP TEST** after configuring the photo amplifier, LED power supply, and LED driver.

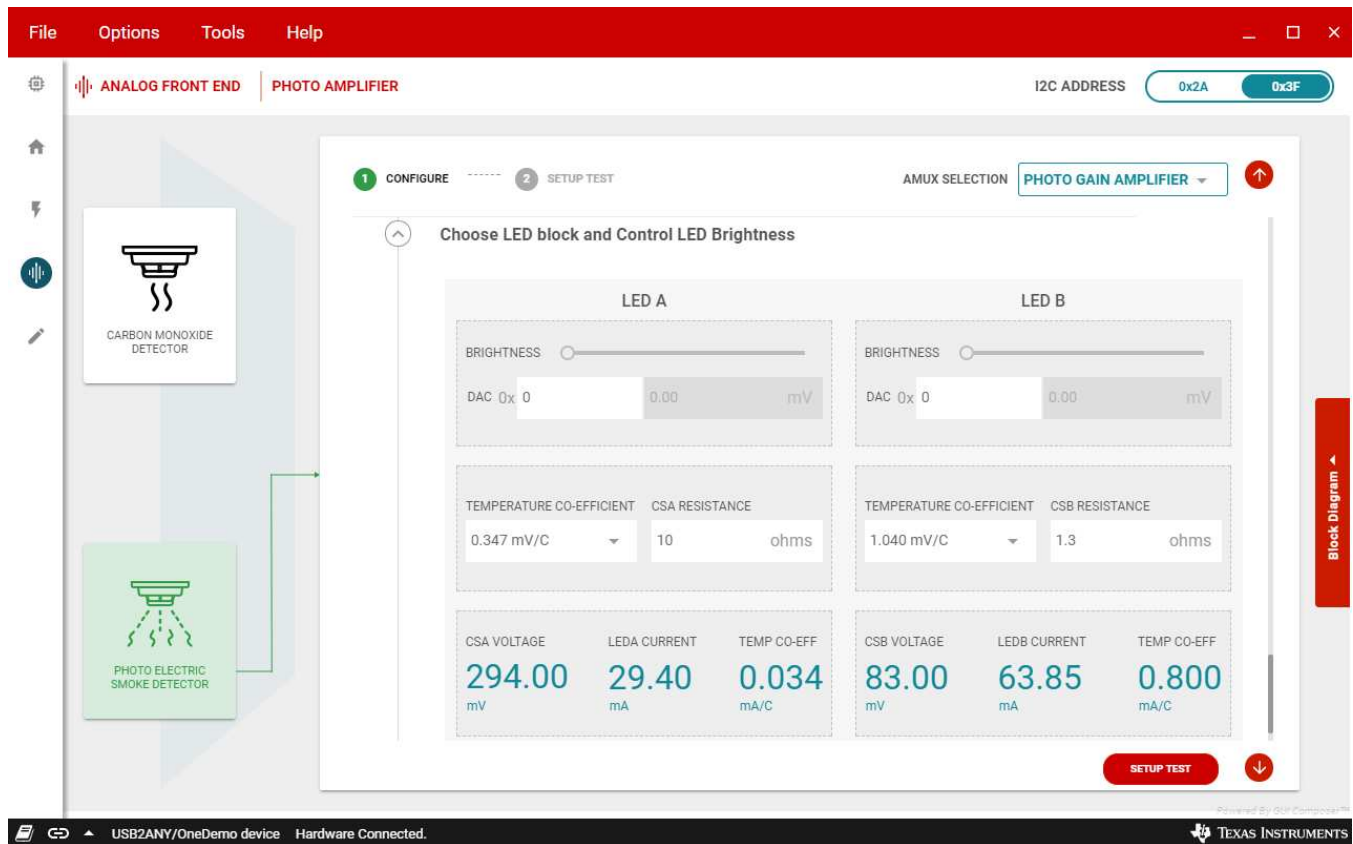

Figure 13. LED Driver Settings

Select the LED to be tested. Enable the LED PWM to send the PWM signal to the LEDEN pin. Enable LEDPIN_EN to control the LED driver using the LEDEN pin. Place a box over the EVM if the EVM LEDs and photodiode are used to block ambient light and reflect the LED light into the photodiode.

Use an oscilloscope to measure the LED current, photo input amplifier, and photo gain amplifier signals. Probe LEDEN to measure the LED control signal. Probe CSA or CSB to measure the LED driver current. Probe PDO to measure the photo input stage amplifier. Probe AMUX_BUF to measure the photo gain stage amplifier.

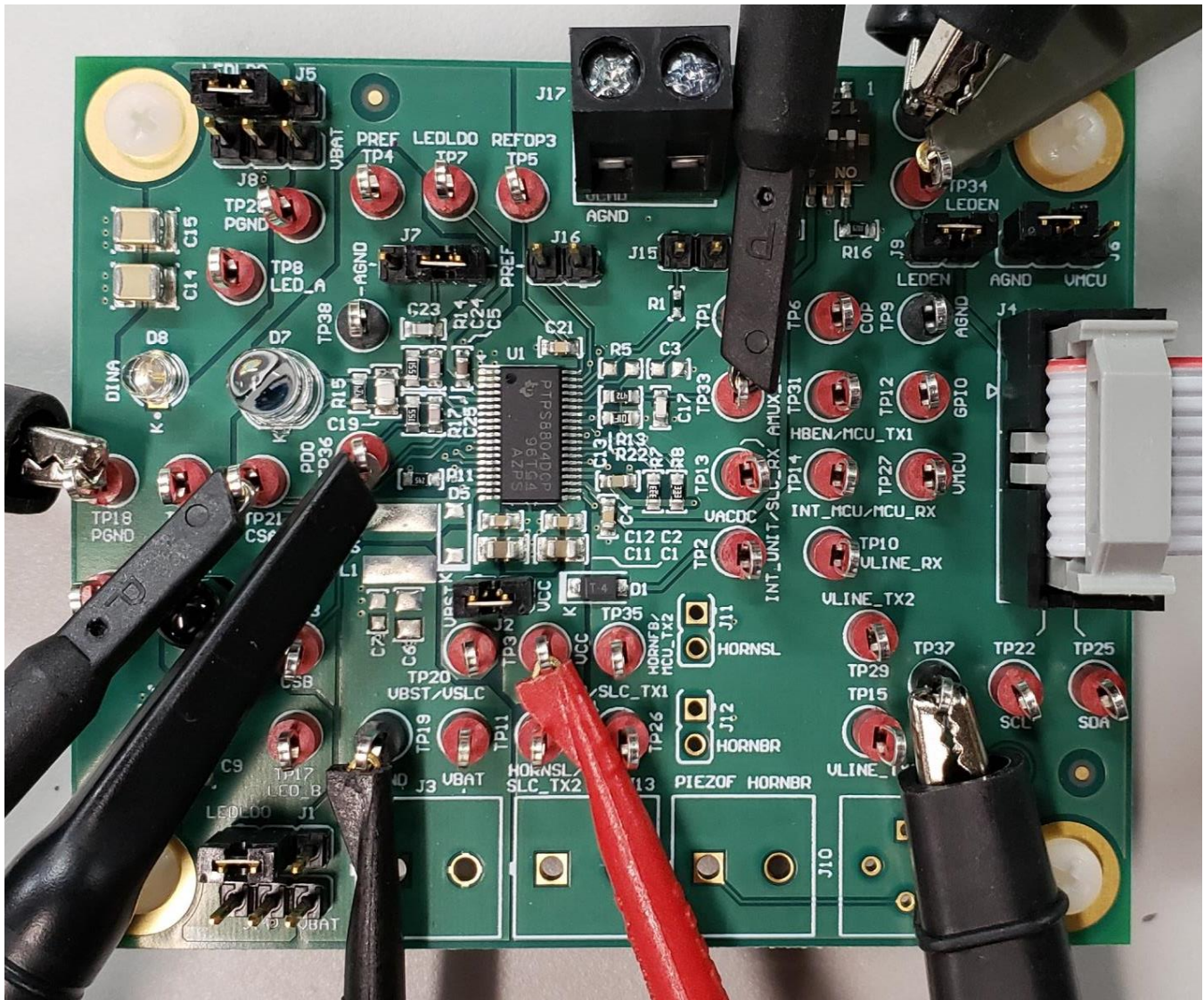

Figure 14. EVM Photo Measurement Probe Configuration

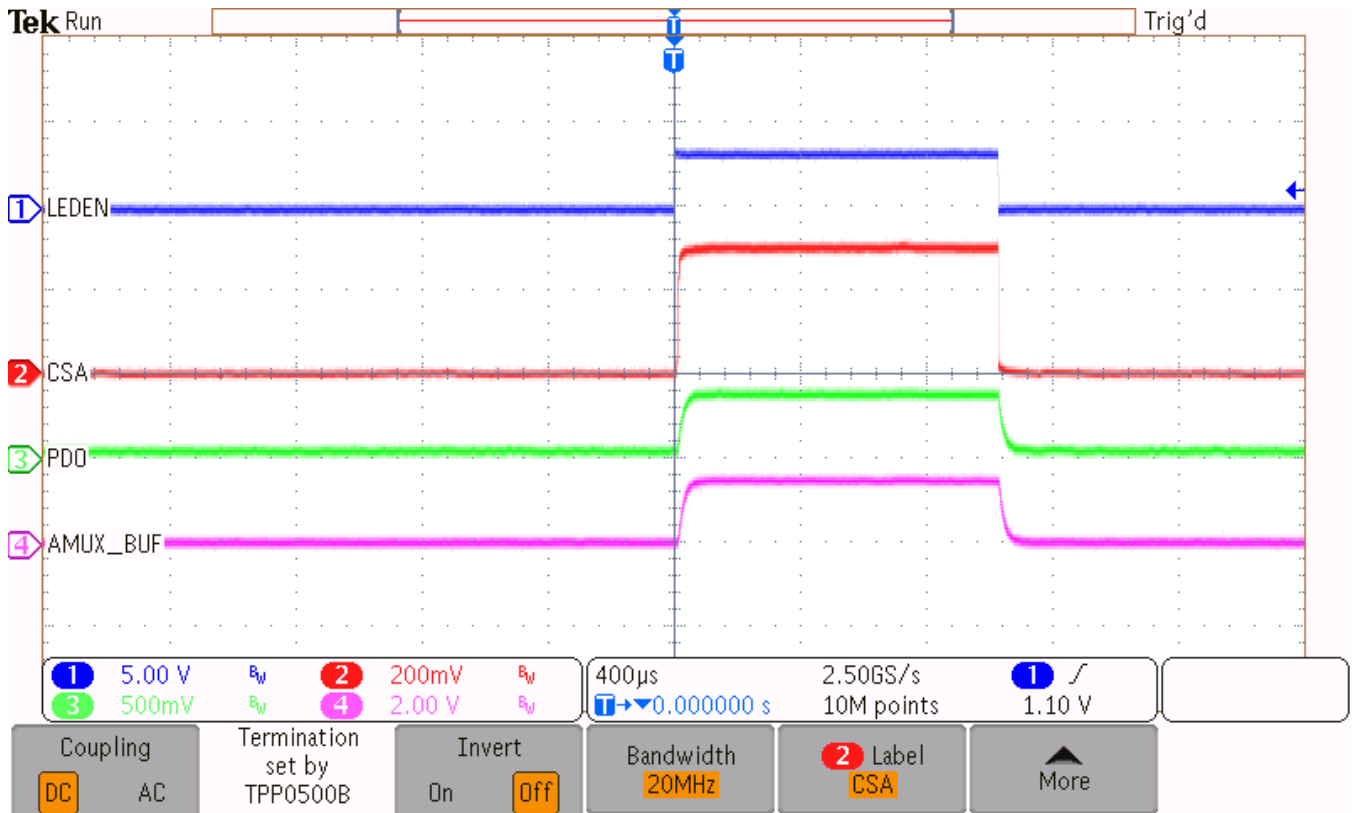

Figure 15. LED A Signals

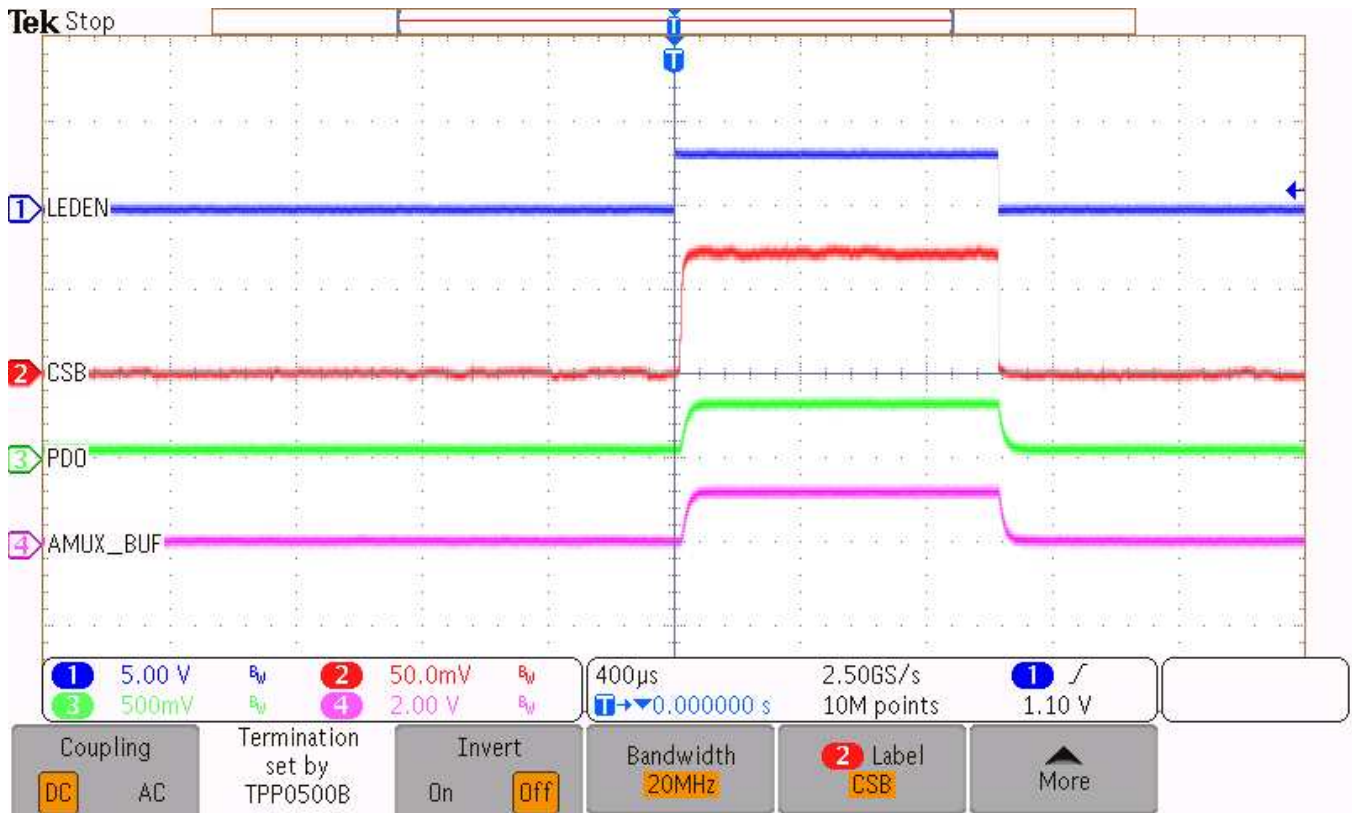

Figure 16. LED B Signals

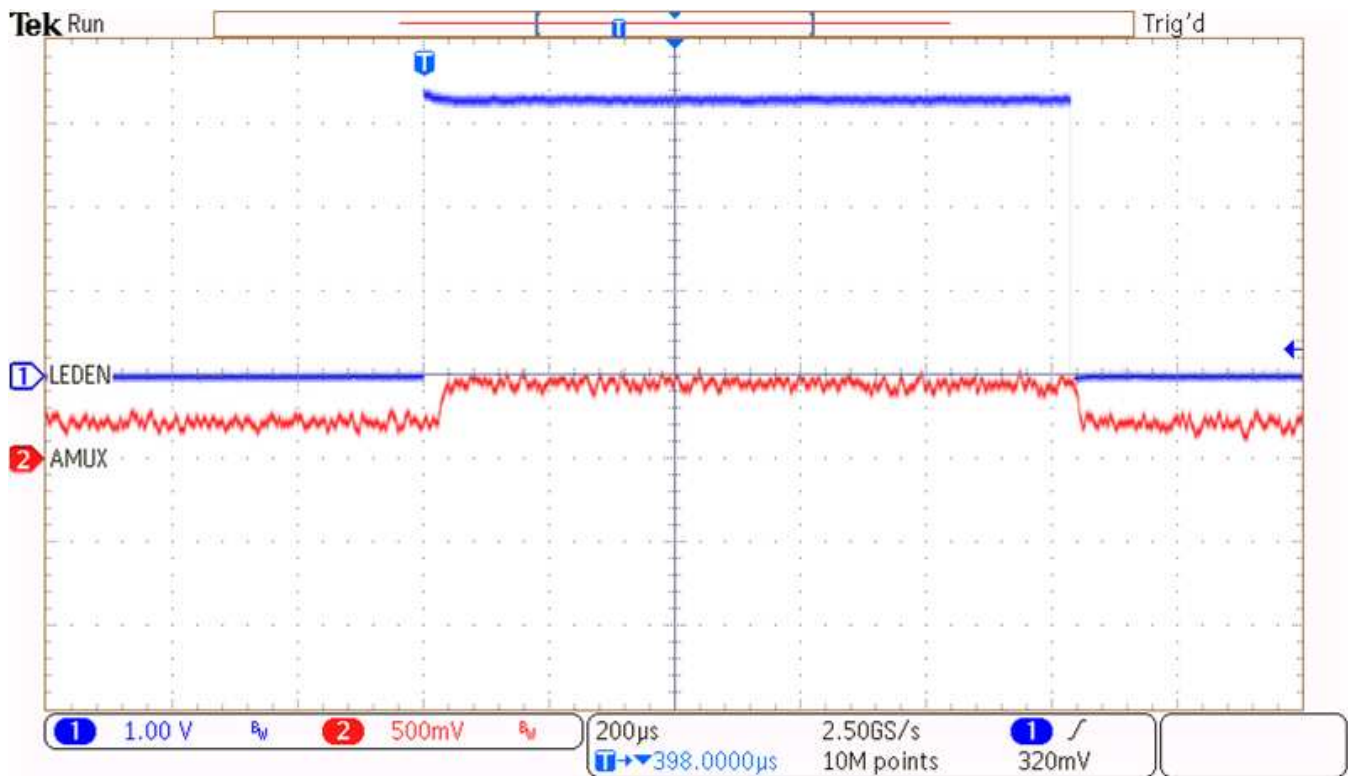

Figure 17. Photo Signal with Photo Chamber

3.3 Register Map

Use the register map to evaluate other blocks in the TPS8804. Use the search to find register bits that correspond to a certain block or function. Load and save register map configurations in the **File** menu. Click the question mark icon (?) to display more information about the selected register or bits.

The screenshot displays a software interface for a Register Map. At the top, there is a red menu bar with 'File', 'Options', 'Tools', and 'Help'. Below the menu bar, the 'Register Map' section is active, showing a search bar with 'SLC' and a 'Search Bitfields' checkbox. The main area contains a table of registers:

Register Name	Address	Value	Bits								
			7	6	5	4	3	2	1	0	
STATUS1 REGISTER	0x01	0x00	-	0	0	0	0	0	-	-	0
CONFIG1 REGISTER	0x04	0x38	0	0	1	1	1	-	-	-	-
CONFIG2 REGISTER	0x05	0x02	-	-	0	-	-	-	-	-	-
ENABLE1 REGISTER	0x06	0x1D	-	-	0	-	1	1	-	-	1
ENABLE2 REGISTER	0x07	0x04	0	-	-	-	-	-	1	0	-

To the right of the table is a 'FIELD VIEW' panel for the 'STATUS1 REGISTER'. It lists several bitfields with their bit widths:

- VCLOW (b0)
- MCULDO_ERR (b0)
- OTS_ERR (b0)
- OTS_WRN (b0)
- SLC_RX (b0)

At the bottom of the window, a status bar shows 'USB2ANY/OneDemo device Hardware Connected.' and the Texas Instruments logo.

Figure 18. Register Map Search Function

4 Board Layout

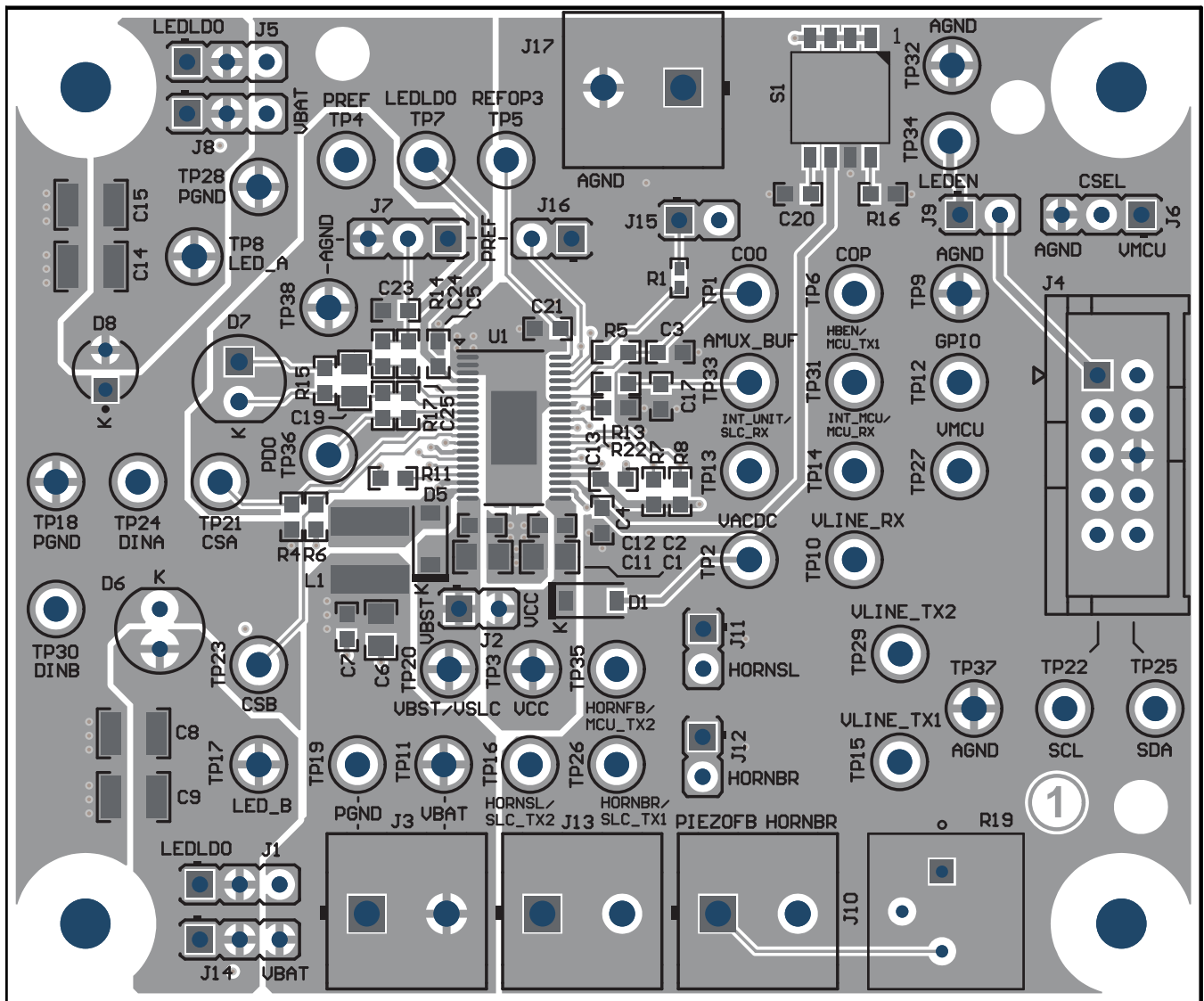

Figure 19. TPS8804EVM Top Layer PCB Layout

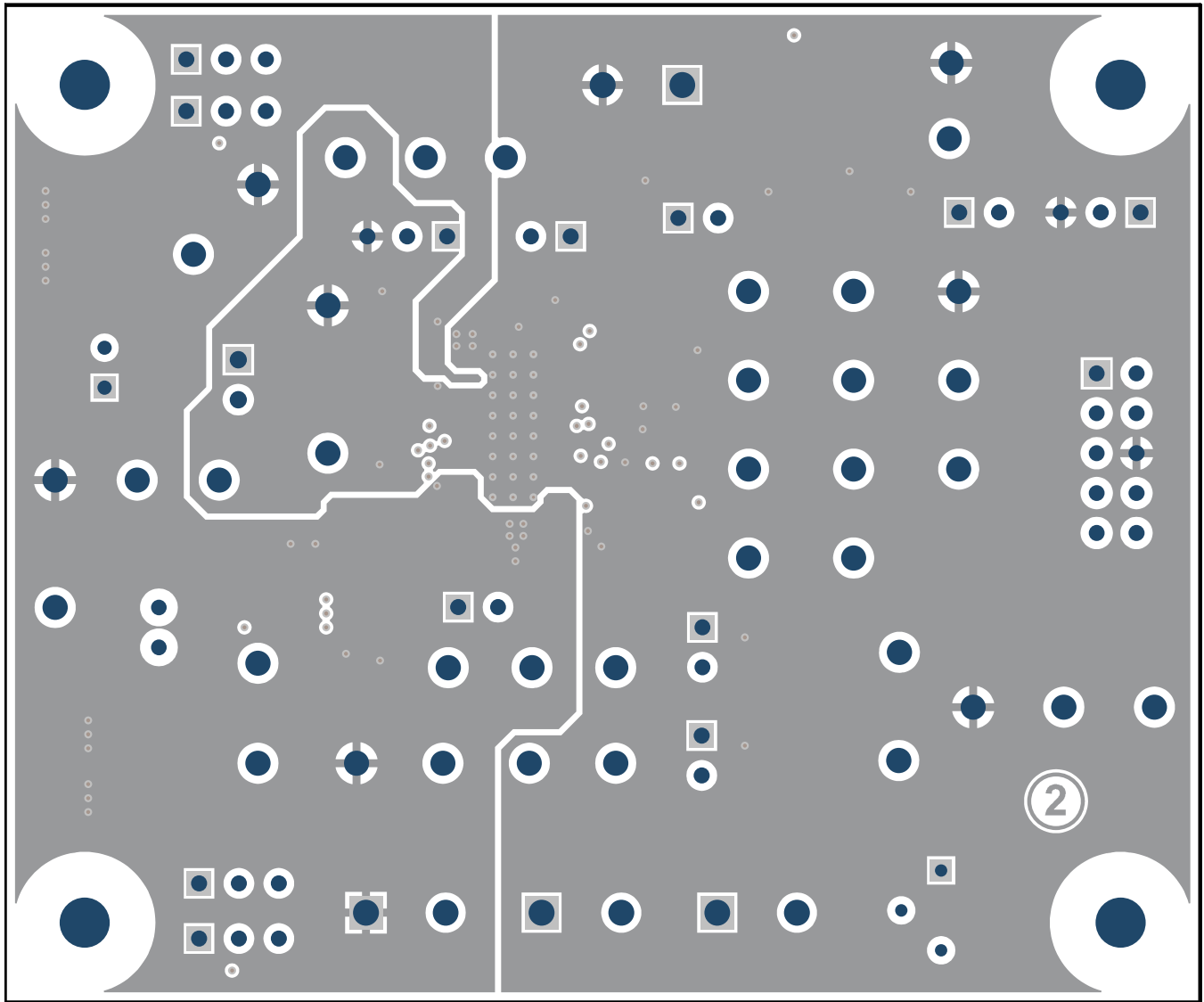

Figure 20. TPS8804EVM Ground Layer PCB Layout

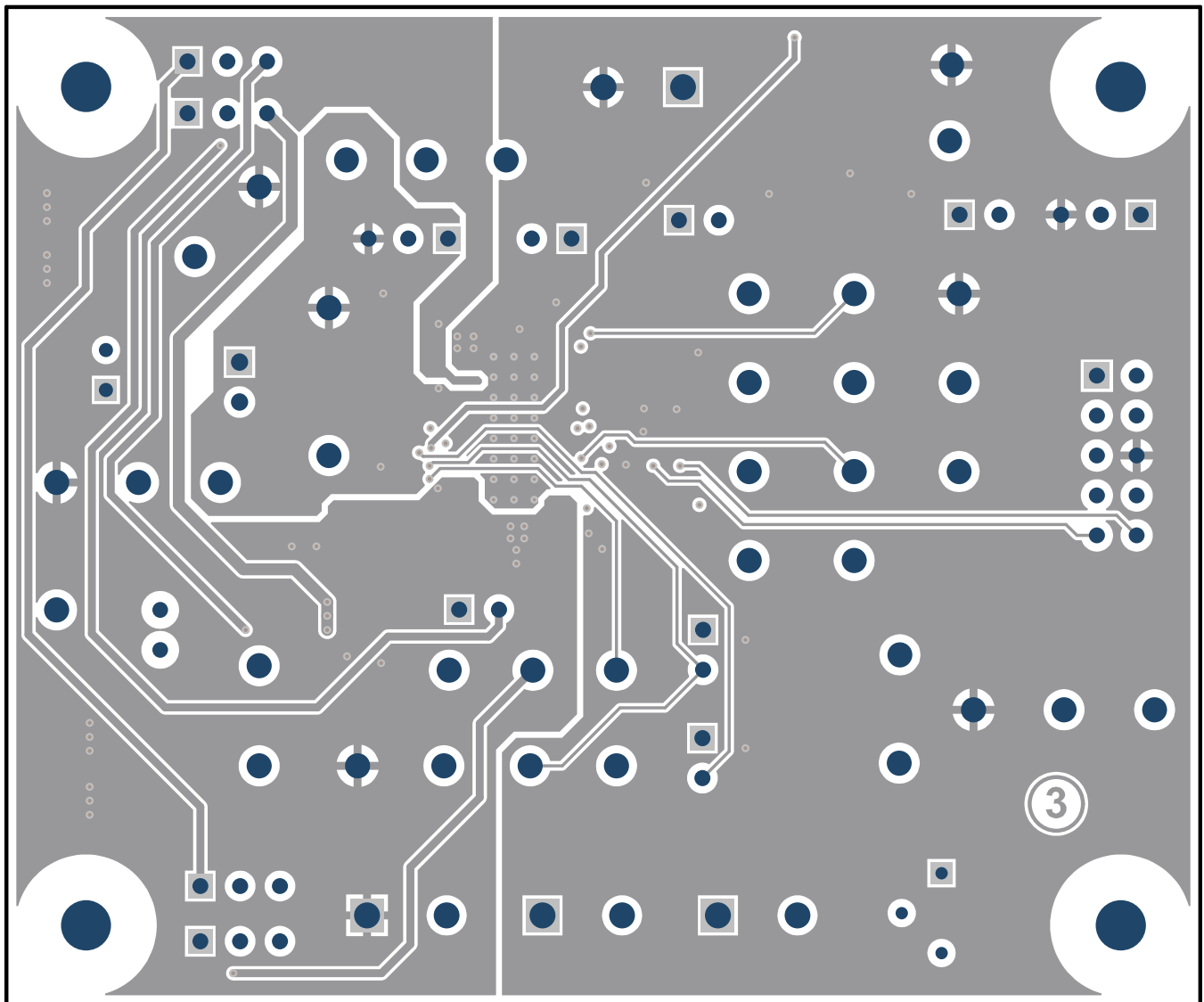

Figure 21. TPS8804EVM Power Layer PCB Layout

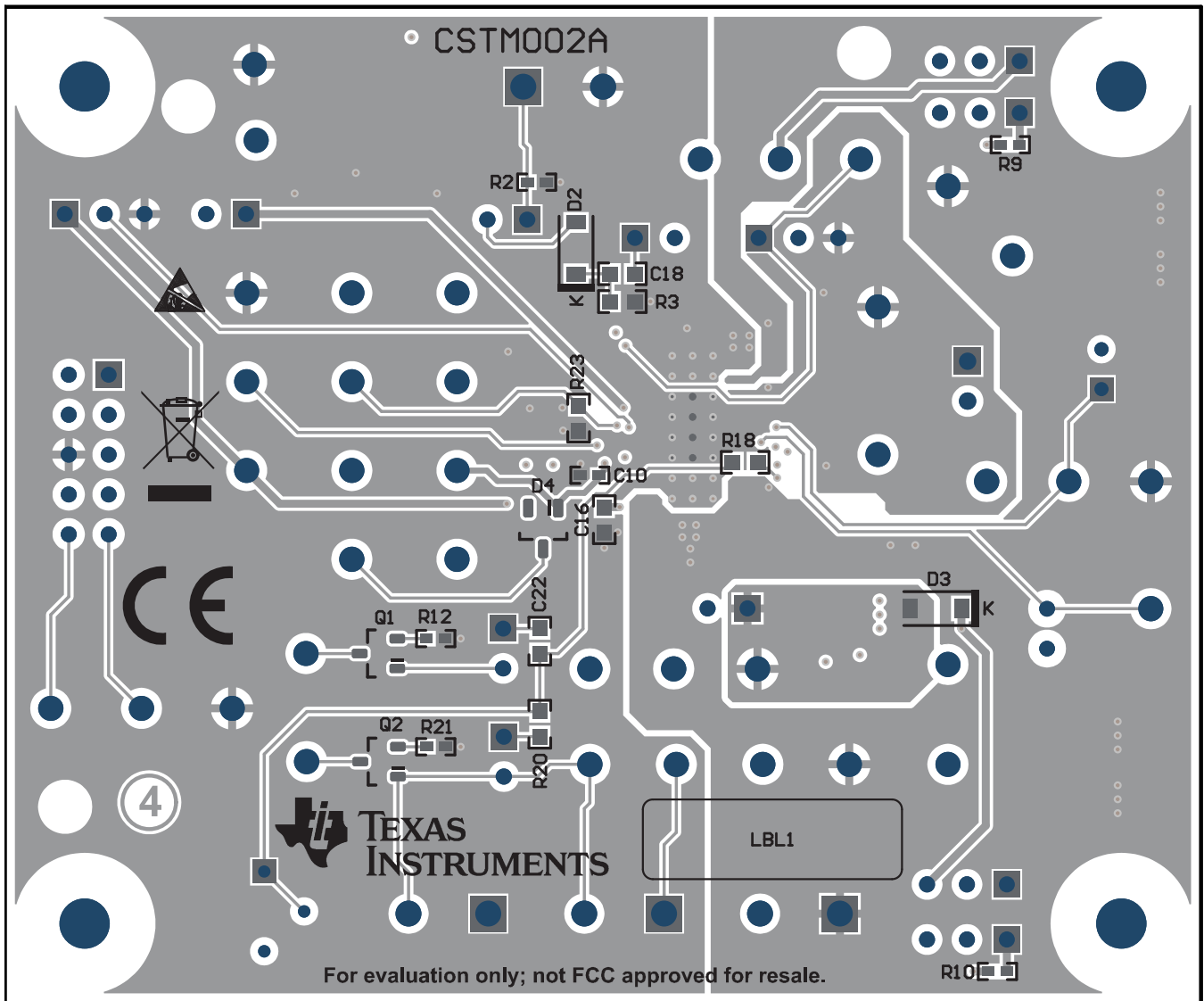
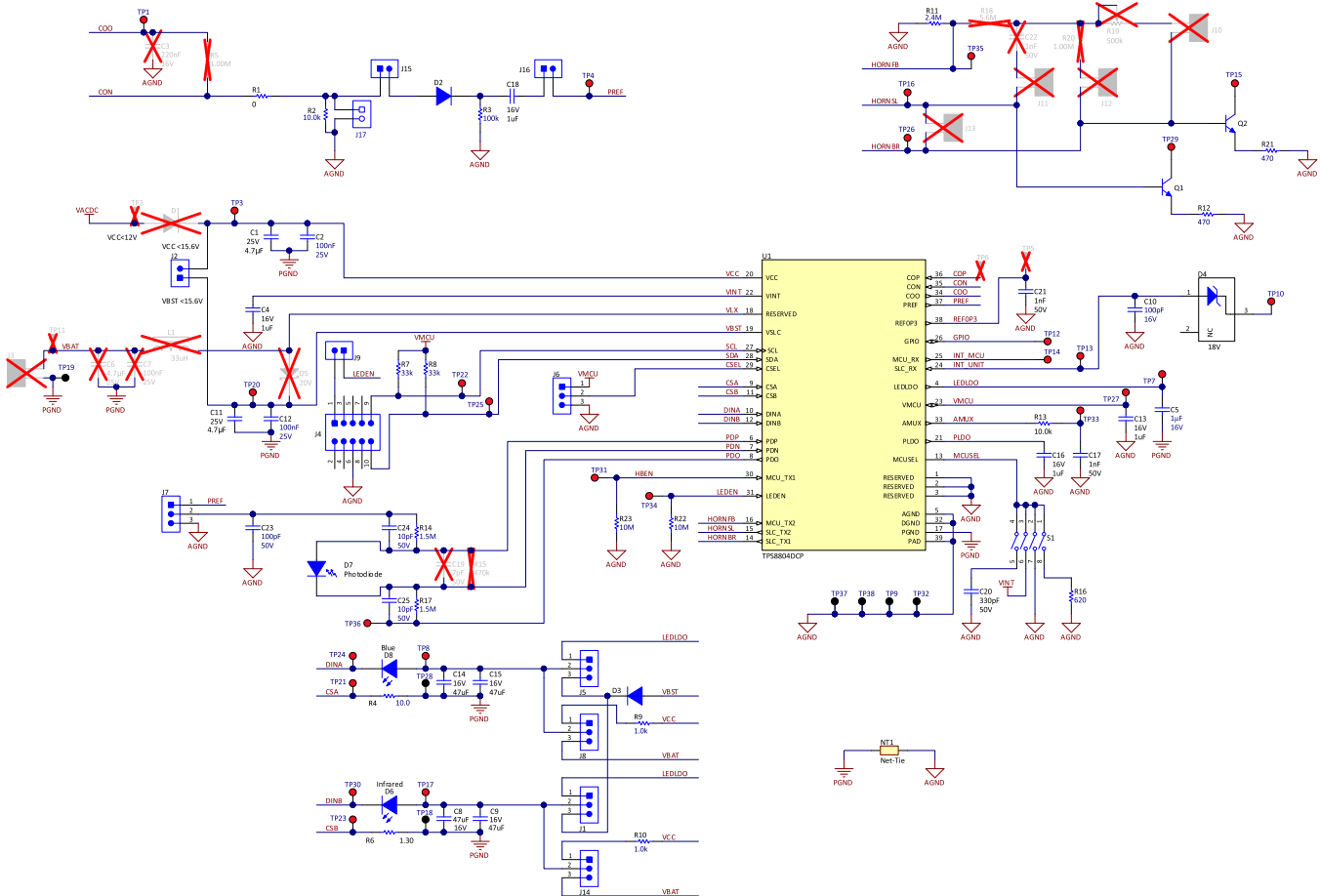

Figure 22. TPS8804EVM Bottom Layer PCB Layout

5 Schematic and Bill of Materials

5.1 Schematic



- (1) It is recommended to install a 470 kΩ resistor connecting PREF to VINT if the photo gain is set to 11x, 20x, or 35x. The 470 kΩ resistor changes the PREF voltage to 70mV and prevents the gain stage output from dropping below 50mV in worst-case conditions.

Figure 23. TPS8804EVM Schematic

5.2 Bill of Materials

Table 2. Bill of Materials

REF DES	QTY	VALUE	DESCRIPTION	SIZE	PART NUMBER
PCB1	1		Printed Circuit Board		TPS880x
C1, C11	2	4.7 μF	Capacitor, ceramic, 4.7 μF, 25 V, ±10%, X7R, 0805	0805	C2012X7R1E475K125AB
C2, C12	2	0.1 μF	Capacitor, ceramic, 0.1 μF, 25 V, ±5%, X7R, 0603	0603	06033C104JAT2A
C4, C13, C16, C18	4	1 μF	Capacitor, ceramic, 1 μF, 16 V, ±10%, X5R, 0603	0603	C0603C105K4PAC TU
C5	1	1 μF	Capacitor, ceramic, 1 μF, 16 V, ±10%, X7R, 0603	0603	EMK107B7105KA-T
C8, C9, C14, C15	4	47 μF	Capacitor, ceramic, 47 μF, 16 V, ±20%, X6S, 1210	1210	GRM32EC81C476M E15L
C10	1	100 pF	Capacitor, ceramic, 100 pF, 16 V, ±10%, X7R, 0402	0402	0402YC101KAT2A

Table 2. Bill of Materials (continued)

REF DES	QTY	VALUE	DESCRIPTION	SIZE	PART NUMBER
C17, C21	2	1000 pF	Capacitor, ceramic, 1000 pF, 50 V, ±10%, X7R, 0603	0603	C0603X102K5RAC TU
C20	1	330 pF	Capacitor, ceramic, 330 pF, 50 V, ±10%, X7R, 0603	0603	C0603C331K5RAC TU
C23	1	100 pF	Capacitor, ceramic, 100 pF, 50 V, ±5%, C0G/NP0, 0603	0603	885012006057
C24, C25	2	10 pF	Capacitor, ceramic, 10 pF, 50 V, ±5%, C0G/NP0, 0603	0603	06035A100JAT2A
D1, D2, D3	3	100 V	Diode, Switching, 100 V, 0.15 A, SOD-123	SOD-123	1N4148W-TP
D4	1	18 V	Diode, Zener, 18 V, 225 mW, SOT-23	SOT-23	BZX84C18LT1G
D6	1	Infrared	LED, Infrared, TH	D5.5 mm	SFH 4556
D7	1		Silicon PIN Photodiode, TH	D5.7xH9 mm	SFH 213
D8	1	Blue	LED, Blue, TH	D3.1 mm	LTL1CHTBK4
H1, H2, H3, H4	4		Machine Screw, Round, #4-40 x 1/4, Nylon, Philips panhead	Screw	NY PMS 440 0025 PH
H5, H6, H7, H8	4		Standoff, Hex, 0.5"L #4-40 Nylon	Standoff	1902C
J1, J5, J6, J7, J8, J14	6		Header, 2.54 mm, 3x1, Tin, TH	Header, 2.54 mm, 3x1, TH	22284033
J2, J9, J15, J16	4		Header, 2.54 mm, 2x1, Tin, TH	Header, 2.54 mm, 2x1, TH	22284023
J4	1		Header (shrouded), 100mil, 5x2, Gold, TH	5x2 Shrouded header	5103308-1
J17	1		Terminal Block, 5.08 mm, 2x1, TH	Terminal Block, 5.08 mm, 2x1, TH	039544-3002
LBL1	1		Thermal Transfer Printable Labels, 0.650" W x 0.200" H - 10,000 per roll	PCB Label 0.650 x 0.200 inch	THT-14-423-10
Q1, Q2	2	65 V	Transistor, NPN, 65 V, 0.1 A, SOT-23	SOT-23	BC846BLT1G
R1	1	0	Resistor, 0, 5%, 0.063 W, 0402	0402	RC0402JR-070RL
R2	1	10.0 kΩ	Resistor, 10.0 k, .1%, .0625 W, 0402	0402	RT0402BRD0710KL
R3	1	100 kΩ	Resistor, 100 k, 0.1%, 0.1 W, 0603	0603	RG1608P-104-B-T5
R4	1	10.0 Ω	Resistor, 10.0, 0.5%, 0.1 W, 0603	0603	RT0603DRE0710RL
R6	1	1.30 Ω	Resistor, 1.30, 0.5%, 0.1 W, 0603	0603	RT0603DRE071R3L
R7, R8	2	33 kΩ	Resistor, 33 k, 5%, 0.1 W, AEC-Q200 Grade 0, 0603	0603	CRCW060333K0JN EA
R9, R10	2	1.0 kΩ	Resistor, 1.0 k, 5%, 0.063 W, AEC-Q200 Grade 0, 0402	0402	CRCW04021K00JN ED
R11	1	2.4 MΩ	Resistor, 2.4 M, 5%, 0.1 W, AEC-Q200 Grade 0, 0603	0603	CRCW06032M40JN EA
R12, R21	2	470 Ω	Resistor, 470, 5%, 0.063 W, AEC-Q200 Grade 0, 0402	0402	CRCW0402470RJN ED
R13	1	10.0 kΩ	Resistor, 10.0 k, 1%, 0.1 W, AEC-Q200 Grade 0, 0603	0603	CRCW06034K70JN EA
R14, R17	2	1.5 MΩ	Resistor, 1.5 M, 5%, 0.1 W, AEC-Q200 Grade 0, 0603	0603	CRCW06031M50JN EA
R16	1	620 Ω	Resistor, 620, 1%, 0.1 W, 0603	0603	RC0603FR-07620RL
R22, R23	2	10MΩ	Resistor, 10 M, 5%, 0.1 W, AEC-Q200 Grade 0, 0603	0603	CRCW060310M0JN EA
S1	1		Switch, Slide, SPST 4 poles, SMT	SW, SMT Half Pitch 4SPST, 5.8x2.7x6.25 mm	218-4LPST

Table 2. Bill of Materials (continued)

REF DES	QTY	VALUE	DESCRIPTION	SIZE	PART NUMBER
SH-J1, SH-J2, SH-J3, SH-J4, SH-J7, SH-J8	6	1x2	Shunt, 100mil, Flash Gold, Black	Closed Top 100mil Shunt	SPC02SYAN
TP1, TP3, TP4, TP7, TP8, TP10, TP12, TP13, TP14, TP15, TP16, TP17, TP20, TP21, TP22, TP23, TP24, TP25, TP26, TP27, TP29, TP30, TP31, TP33, TP34, TP35, TP36	27		Test Point, Multipurpose, Red, TH	Red Multipurpose Testpoint	5010
TP9, TP18, TP19, TP28, TP32, TP37, TP38	7		Test Point, Multipurpose, Black, TH	Black Multipurpose Testpoint	5011
U1	1		TPS8804DCP, DCP0038A (HTSSOP-38)	DCP0038A	TPS8804DCP

Revision History

NOTE: Page numbers for previous revisions may differ from page numbers in the current version.

Changes from Original (October 2019) to A Revision	Page
• Added Figure 7	8
• Added recommendation to install a 470 kΩ resistor connecting PREF to VINT in Section 3.2	11
• Updated silkscreen labels in Figure 19	21
• Added Figure 20	22
• Added Figure 21	23
• Updated PCB revision to CSTM002A in Figure 22	23
• Added recommendation to install a 470 kΩ resistor connecting PREF to VINT in Figure 23	24
• Changed R13 to 10.0 kΩ, changed C17 to 1nF, de-populated R15, C19, TP5, TP6 in Figure 23	24
• Changed C17 value to 1000 pF in Table 2	25
• Changed R13 value to 10.0 kΩ in Table 2	25
• Deleted R15, C19, TP5, TP6 in Table 2	26

IMPORTANT NOTICE AND DISCLAIMER

TI PROVIDES TECHNICAL AND RELIABILITY DATA (INCLUDING DATASHEETS), DESIGN RESOURCES (INCLUDING REFERENCE DESIGNS), APPLICATION OR OTHER DESIGN ADVICE, WEB TOOLS, SAFETY INFORMATION, AND OTHER RESOURCES "AS IS" AND WITH ALL FAULTS, AND DISCLAIMS ALL WARRANTIES, EXPRESS AND IMPLIED, INCLUDING WITHOUT LIMITATION ANY IMPLIED WARRANTIES OF MERCHANTABILITY, FITNESS FOR A PARTICULAR PURPOSE OR NON-INFRINGEMENT OF THIRD PARTY INTELLECTUAL PROPERTY RIGHTS.

These resources are intended for skilled developers designing with TI products. You are solely responsible for (1) selecting the appropriate TI products for your application, (2) designing, validating and testing your application, and (3) ensuring your application meets applicable standards, and any other safety, security, or other requirements. These resources are subject to change without notice. TI grants you permission to use these resources only for development of an application that uses the TI products described in the resource. Other reproduction and display of these resources is prohibited. No license is granted to any other TI intellectual property right or to any third party intellectual property right. TI disclaims responsibility for, and you will fully indemnify TI and its representatives against, any claims, damages, costs, losses, and liabilities arising out of your use of these resources.

TI's products are provided subject to TI's Terms of Sale (www.ti.com/legal/termsofsale.html) or other applicable terms available either on ti.com or provided in conjunction with such TI products. TI's provision of these resources does not expand or otherwise alter TI's applicable warranties or warranty disclaimers for TI products.

Mailing Address: Texas Instruments, Post Office Box 655303, Dallas, Texas 75265
Copyright © 2020, Texas Instruments Incorporated