

Using the TPS92070EVM-682

User's Guide



Literature Number: SLUU698
November 2011



WARNING

Always follow TI's set-up and application instructions, including use of all interface components within their recommended electrical rated voltage and power limits. Always use electrical safety precautions to help ensure your personal safety and the safety of those working around you. Contact TI's Product Information Center <http://support.ti.com> for further information.

Save all warnings and instructions for future reference.

Failure to follow warnings and instructions may result in personal injury, property damage, or death due to electrical shock and/or burn hazards.

The term TI HV EVM refers to an electronic device typically provided as an open framed, unenclosed printed circuit board assembly. It is intended strictly for use in development laboratory environments, solely for qualified professional users having training, expertise, and knowledge of electrical safety risks in development and application of high-voltage electrical circuits. Any other use and/or application are strictly prohibited by Texas Instruments. If you are not suitably qualified, you should immediately stop from further use of the HV EVM.

1. Work Area Safety:

- (a) Keep work area clean and orderly.
- (b) Qualified observer(s) must be present anytime circuits are energized.
- (c) Effective barriers and signage must be present in the area where the TI HV EVM and its interface electronics are energized, indicating operation of accessible high voltages may be present, for the purpose of protecting inadvertent access.
- (d) All interface circuits, power supplies, evaluation modules, instruments, meters, scopes and other related apparatus used in a development environment exceeding 50 V_{RMS}/75 VDC must be electrically located within a protected Emergency Power Off (EPO) protected power strip.
- (e) Use a stable and non-conductive work surface.
- (f) Use adequately insulated clamps and wires to attach measurement probes and instruments. No freehand testing whenever possible.

2. Electrical Safety:

- (a) De-energize the TI HV EVM and all its inputs, outputs, and electrical loads before performing any electrical or other diagnostic measurements. Revalidate that TI HV EVM power has been safely de-energized.
- (b) With the EVM confirmed de-energized, proceed with required electrical circuit configurations, wiring, measurement equipment hook-ups and other application needs, while still assuming the EVM circuit and measuring instruments are electrically live.
- (c) Once EVM readiness is complete, energize the EVM as intended.

WARNING: while the EVM is energized, never touch the EVM or its electrical circuits as they could be at high voltages capable of causing electrical shock hazard.

3. Personal Safety:

- (a) Wear personal protective equipment e.g. latex gloves and/or safety glasses with side shields or protect EVM in an adequate lucent plastic box with interlocks from accidental touch.

4. Limitation for Safe Use:

- (a) EVMs are not to be used as all or part of a production unit.

Using the TPS92070EVM-682 Integrated Dimming LED Lighting Driver Converter for 115-VAC Input

1 Introduction

The TPS92070EVM-682 evaluation module (EVM) is a low-power isolated flyback converter that provides 5 on-board LEDs with 370 mA of drive current from a nominal 115-VAC input. This EVM is designed to demonstrate the TPS92070 in a typical application where LEDs can be used for general illumination applications that require dimming.

2 Description

This evaluation module uses the TPS92070 High Efficiency Integrated Dimming LED Lighting Driver Controller (TI Literature Number SLUSAN1) in a low power offline flyback converter to provide 370 mA to the on-board LED load. The input accepts a nominal 60 Hz, 115-VAC input voltage. The TPS92070EVM-682 is designed to be used with a leading edge triac dimmer switch in series with the input voltage to control the lumen output of the LEDs. The integrated dimming interface circuit on the TPS92070 provides exponentially controlled light output based on the external dimmer position.

This user's guide provides the schematic, component list, assembly drawing, and test set up necessary to evaluate the TPS92070 in an AC input LED lighting application.

2.1 Typical Applications

The TPS92070 is suited for use in low-power lighting applications such as:

- LED Light Bulb Replacement
- LED Luminaries
- LED Down Lights
- LED Wall Washers

2.2 Features

The TPS92070EVM-682 features include:

- 90-VAC to 130-VAC Input Range
- LED Current Regulation of 370 mA, Nominal
- 6-W Output at 16 V
- Advanced Integrated Dimming Interface
- Exponential Dimming Profile
- Programmable Minimum LED Current
- Valley Switching and DCM Operation
- Leading Edge Dimmer Detection
- Valley Fill Power Factor Correction
- Cycle-by-cycle Current Limit Protection

3 Electrical Performance Specifications

Table 1. TPS92070EVM-682 Electrical Performance Specifications

PARAMETER	TEST CONDITIONS	MIN	TYP	MAX	UNITS
Input Characteristics					
Voltage range, V_{IN}		90	115	130	VAC
Maximum input current, $I_{IN(max)}$	$V_{IN(typ)}$, $I_{LED} = \text{full load}^{(1)}$		100		mA
Input frequency, f_{LINE}			60		Hz
Input power factor, PF	$V_{IN(typ)}$, $I_{LED} = \text{full load}^{(1)}$		0.80		
Output Characteristics					
Output voltage, V_{OUT}	$V_{IN(min)} \leq V_{IN} \leq V_{IN(max)}$, $I_{LED} = \text{full load}^{(1)}$		16		V
Output load current set point, I_{LED}	$V_{IN(min)} \leq V_{IN} \leq V_{IN(max)}$, $I_{LED} = \text{full load}^{(1)}$	350	370	390	mA
Output current regulation	$V_{IN(min)} \leq V_{IN} \leq V_{IN(max)}$, $I_{LED} = \text{full load}^{(1)}$		5%		
Minimum LED current, $I_{LED(min)}$	$V_{IN(min)} \leq V_{IN} \leq V_{IN(max)}$, $I_{LED} = \text{full load}^{(1)}$ with dimmer capable of 10% conduction angle		13		mA
Output voltage ripple	$V_{IN(typ)}$, $I_{LED} = \text{full load}^{(1)}$		5		V_{PP}
Systems Characteristics					
Switching frequency		30		146	kHz
Peak efficiency	$V_{IN(max)}$, $I_{LED} = \text{full load}^{(1)}$		83%		
Full load efficiency	$V_{IN(typ)}$, $I_{LED} = \text{full load}^{(1)}$		82%		
Operating temperature			25		°C

⁽¹⁾ Full load is five on-board LEDs in series.

CAUTION

High voltage levels are present on the evaluation module whenever it is energized. Proper precautions must be taken when working with the EVM. Serious injury can occur if proper safety precautions are not followed.

4 Schematic

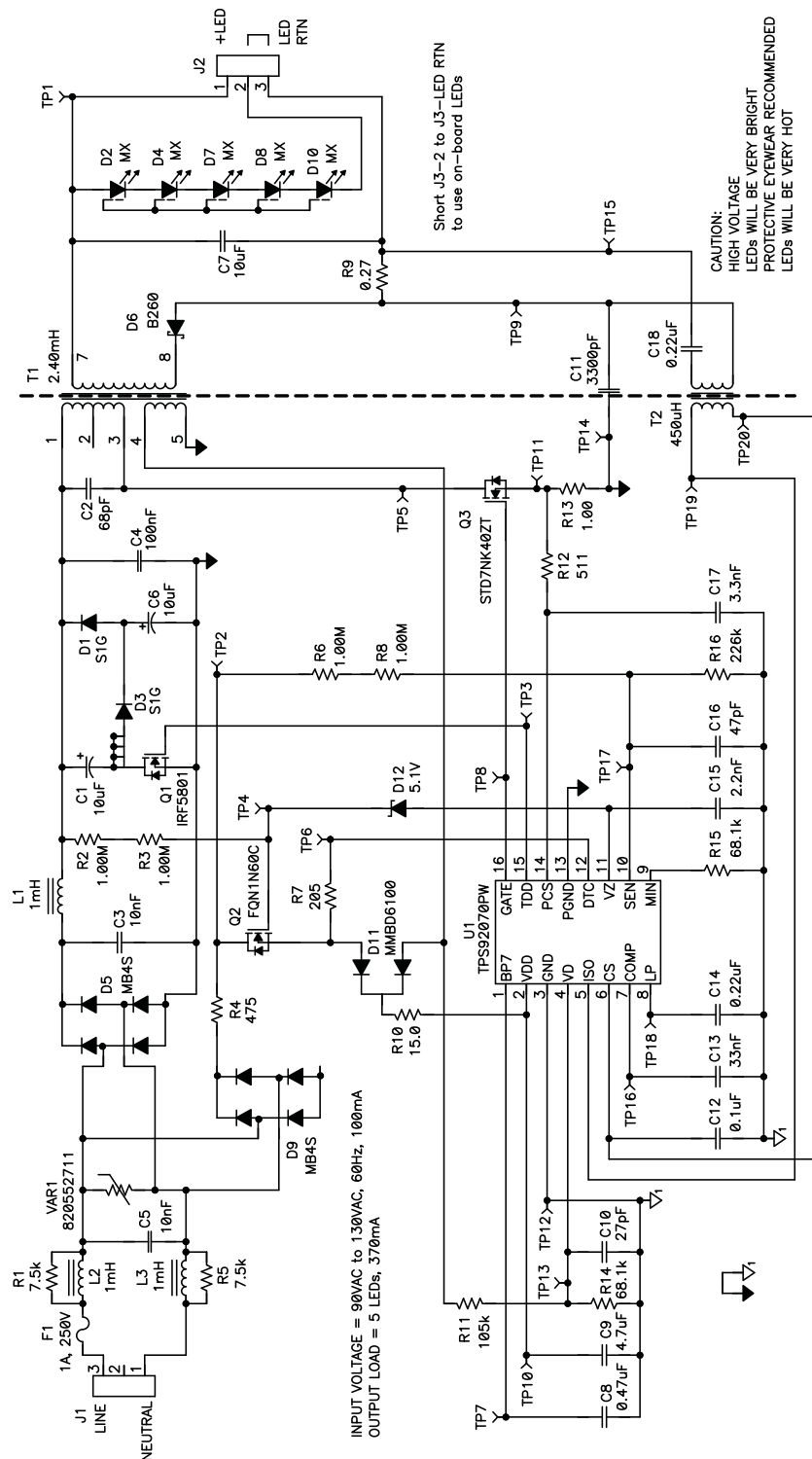

Figure 1. TPS92070EVM-682 Schematic

5 Test Setup

5.1 Test Equipment

Voltage Source: The input voltage source shall be an isolated variable AC source capable of supplying between 90 VAC and 130 VAC at no less than 10 W and connected as shown in [Figure 2](#). (example: Hewlett Packard 6813B AC power source).

Power Meter: For accurate efficiency calculations, a power meter should be inserted between the AC source and the EVM. For highest accuracy, connect the voltage terminals of the power meter directly across the Line and Neutral terminals of the EVM. (example: Voltech PM100 Single Phase Power Analyzer).

Multimeters: Two digital multimeters are used to measure the LED voltage (DMM V_{LED}) and load current (DMM A_{LED}). (example: Fluke 45 Digital Multimeter)

Output Load: By connecting a jumper wire from J2 pin 2 to J2 pin 3 (LED RTN) the 5 Cree™ MX series white LEDs that are on the EVM may be used as the load. The EVM can also be used to drive the user's external LED load by connecting the jumper wire from J2 pin 1 (+LED) to external 370 mA, 3.2-V LEDs and return them to J2 pin 3 (LED RTN).

Oscilloscope: A 200-MHz digital oscilloscope with 4 isolated channels for differential mode measurements is required. Non-isolated probes may result in flickering. A high-voltage probe and a current probe are also recommended. (examples: Tektronix TPS2024B Four Channel Digital Storage Oscilloscope, Tektronix P5205A High-Voltage Differential Probe, Tektronix TCPA300 Amplifier AC/DC Current Probe)

Dimmer: A leading edge dimmer, rated for 115 VAC can be used to controlling the LED light output.

Fan: Forced air cooling is not required.

Recommended Wire Gauge: A minimum of AWG 22 wire is recommended to connect the AC voltage source to the EVM at less than three feet long.

WARNING

High voltages that may cause injury exist on this evaluation module (EVM). Please ensure all safety procedures are followed when working on this EVM. Never leave a powered EVM unattended.

LEDs will be very hot and very bright! Shaded protective eyewear is recommended.

5.2 Recommended Test Setup

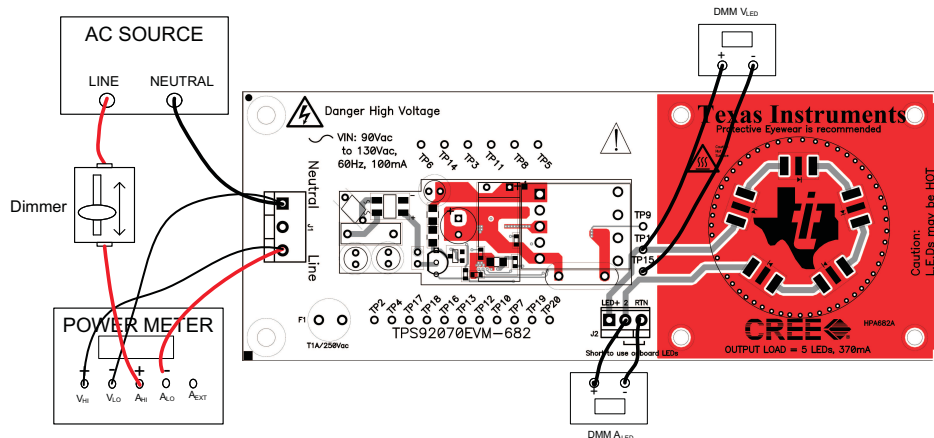

Figure 2. TPS92070EVM-682 Recommended Test Set Up

5.3 List of Test Points

It is important to note that differential probes are required when observing these test points. Differential probes reduce noise injection commonly seen when using a standard oscilloscope with an isolation transformer. Noise injection by probing with a standard oscilloscope may result in flickering.

Table 2. The Function of Each Test Point

TEST POINTS	NAME	DESCRIPTION
TP1	LED+	LED output voltage, reference to TP15
TP2	Q2 drain	Phase detection circuit, reference to TP12
TP3	TDD	TRIAC dimmer detect, reference to TP14
TP4	Q2 gate	Phase detection circuit, reference to TP12
TP5	Q3 drain	High-voltage switch drain, reference to TP14
TP6	DTC	Dimmer trigger control input, reference to TP14
TP7	BP	Bypass for internal 7-V regulator, reference to TP12
TP8	GATE	Q3 gate drive, reference to TP14
TP9	SRTN	Secondary side return
TP10	VDD	Bias pin, reference to TP12
TP11	Q3 source	Primary current sense access, reference to TP14
TP12	GND	Ground, reference for TP2, TP4, TP7, TP10, TP13, TP16, TP17, TP18, TP19, TP20
TP13	VD	Valley detect, reference to TP12
TP14	PGND	Power ground, reference for TP3, TP5, TP6, TP8, TP11
TP15	LED RTN	Return for LED load, reference for TP1
TP16	COMP	Loop compensation, reference to TP12
TP17	SEN	Dimmer sense input, reference to TP12
TP18	LP	Pole for DTC low pass filter, reference to TP12
TP19	ISO	Inverting input to LED current sense comparator, reference to TP12
TP20	CS	Non-inverting input to LED current sense comparator, reference to TP12

NOTE: Differential probes are required when observing these test points.

6 Test Procedure

6.1 Line Regulation and Efficiency Measurement Procedure

1. With the dimmer removed from the test set up, set the AC voltage source to 90 VAC, 60 Hz.
2. The LEDs should be lit and the LED current should be within regulation per [Table 1](#).
3. Adjust AC voltage up to 130 VAC.
4. LEDs should be lit and the current should remain within regulation per [Table 1](#) with no flicker.
5. Efficiency data should be taken without the dimmer in circuit and input measurements taken from the power meter.
6. Turn off AC power. LEDs should turn off with no flashing or flicker.

6.2 Dimming

1. With dimmer in circuit, set the AC voltage source between 90 VAC and 130 VAC, 60 Hz.
2. Adjust the dimmer to control light output.

6.3 Equipment Shutdown

1. Turn off AC voltage source.

7 Performance Data and Typical Characteristic Curves

Figure 3 through Figure 18 present typical performance curves for the TPS92070EVM-682. Since actual performance data can be affected by measurement techniques and environmental variables, these curves are presented for reference and may differ from actual field measurements.

7.1 Efficiency

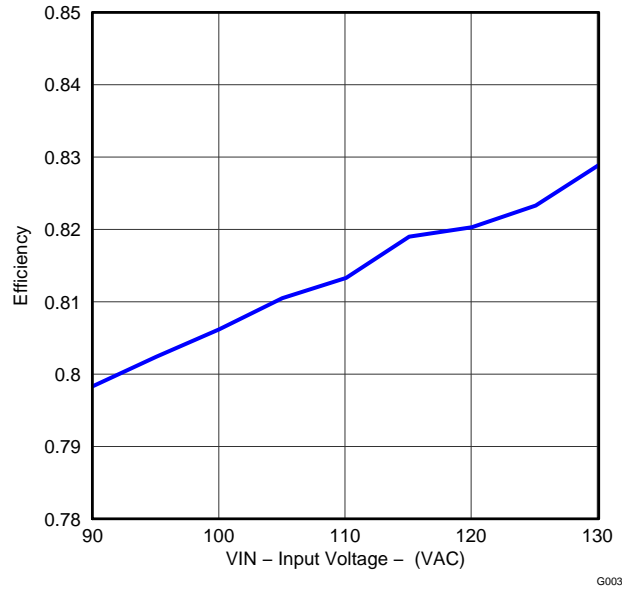

Figure 3. TPS92070EVM-682 Efficiency with Respect to Line Voltage, No Dimmer

7.2 LED Regulation

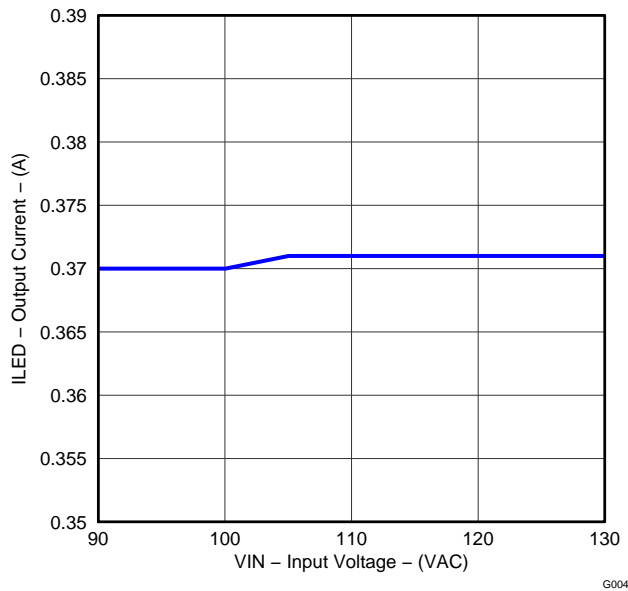
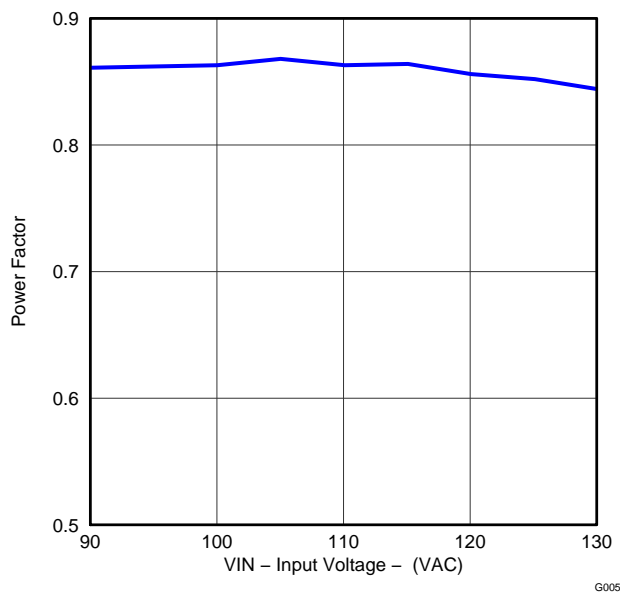

Figure 4. TPS92070EVM-682 LED Current Regulation with Respect to Line Voltage, No Dimmer

7.3 Power Factor



G005

Figure 5. TPS92070EVM-682 Power Factor with Respect to Line Voltage, No Dimmer

7.4 Average Conduction

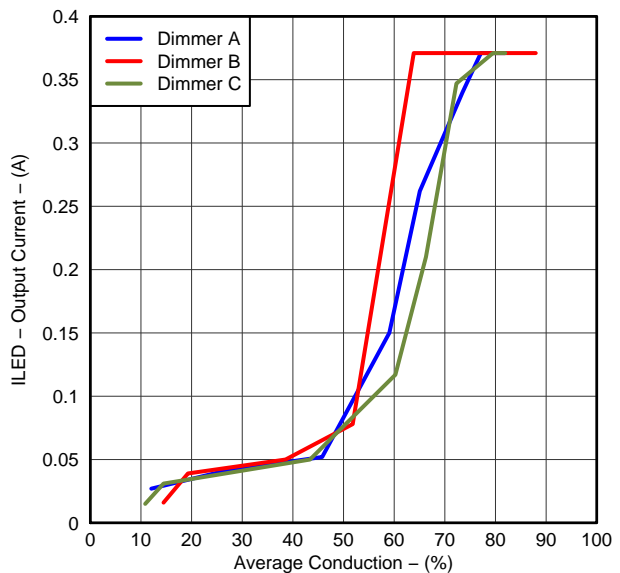

G006

Figure 6. LED Current with Respect to Average Dimmer Conduction

7.5 Turn On

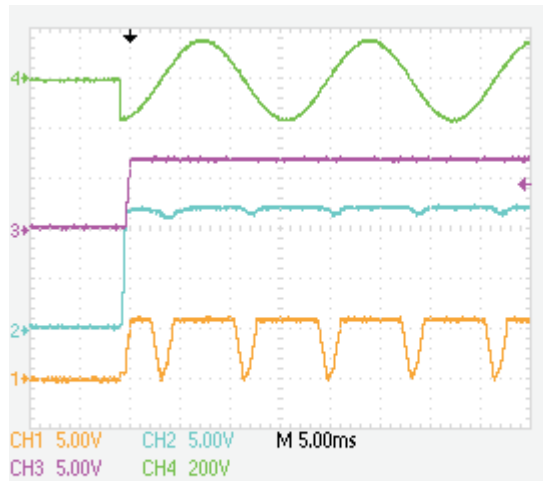

Figure 7. Turn On, Full Load, No Dimmer
(CH1 = SEN, CH2 = VDD, CH3 = BP, CH4 = VIN (115 VAC))

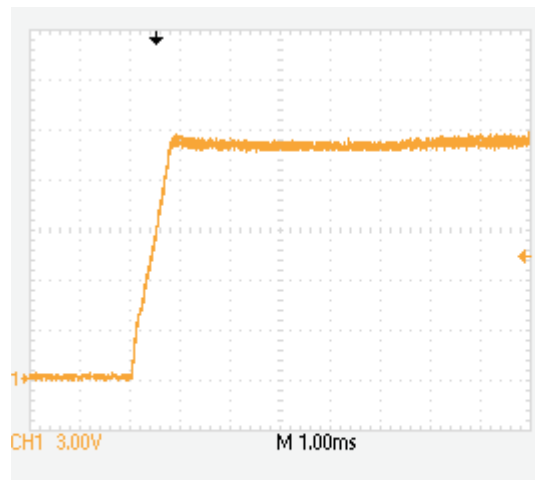

Figure 8. LED Turn On, Full Load, No Dimmer
(VIN = 115 VAC, CH1 = VOUT)

7.6 AC Input



Figure 9. Input AC Voltage and Current, Full Load, No Dimmer
(CH1 = I_{IN} , CH3 = V_{IN} (115 VAC), scale = 100 mA/div)

7.7 Output Voltage Ripple

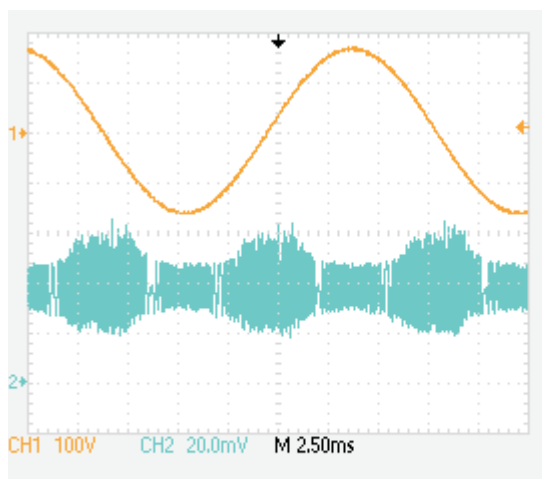

Figure 10. LED Output Voltage Ripple, Full Load, No Dimmer
(V_{IN} = 115 VAC, CH1 = V_{OUT})

7.8 Output Current Ripple

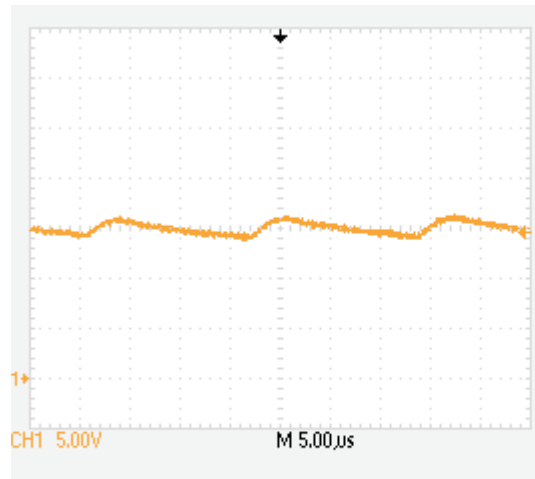

Figure 11. LED Output Current Ripple, Full Load, No Dimmer (CH1 = VIN (115 VAC), CH2 = I_{LED}, scale = 200 mA/div)

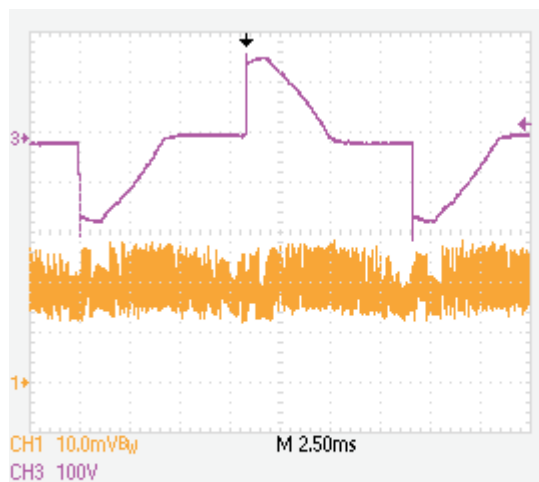

Figure 12. LED Output Current Ripple, With Dimmer (CH1 = I_{LED}, scale = 50 mA/div, CH3 = VIN (115 VAC))

7.9 Switching Waveform

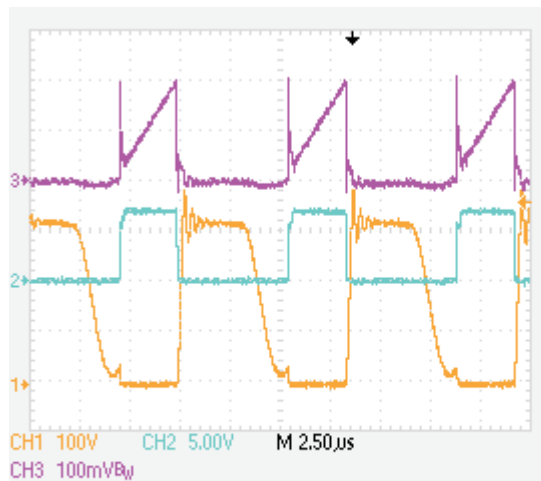

Figure 13. Switching Waveforms, Full Load, No Dimmer
(VIN = 115 VAC, CH1 = Q3 Drain, CH2 = GATE, CH3 = PCS)

7.10 TDD, No Dimmer

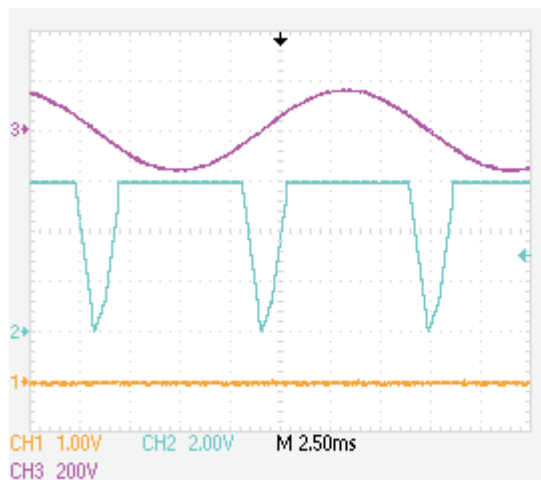

Figure 14. TDD, Full Load, No Dimmer
(CH1 = TDD, CH2 = SEN, CH3 = VIN (115 VAC))
(TDD signal low when there is no dimmer detected on the input, Valley Fill PFC is enabled)

7.11 TDD, With Dimmer

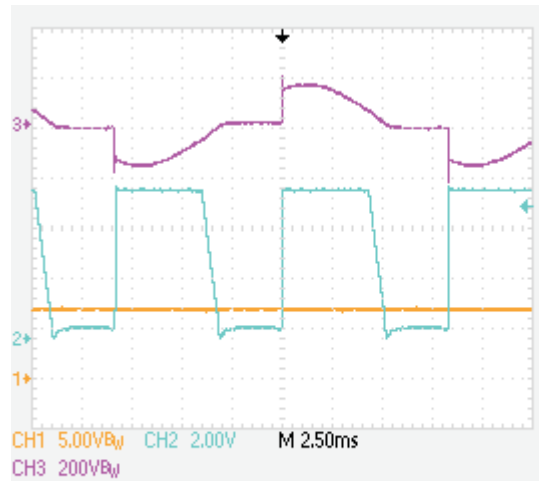

Figure 15. TDD, With Dimmer
 (CH1 = TDD, CH2 = SEN, CH3 = VIN (115 VAC))
 (TDD signal high when there is a dimmer detected on the input, Valley Fill PFC is disabled)

7.12 Valley Detect

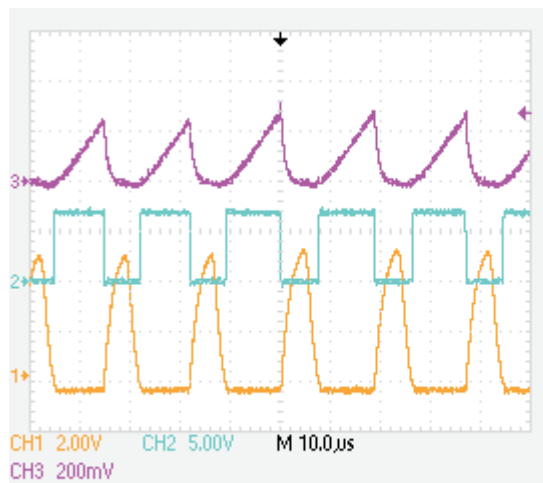

Figure 16. Valley Detect, Full Load, No Dimmer
 (VIN = 115 VAC, CH1 = VD, CH2 = GATE, CH3 = PCS)

7.13 Turn Off

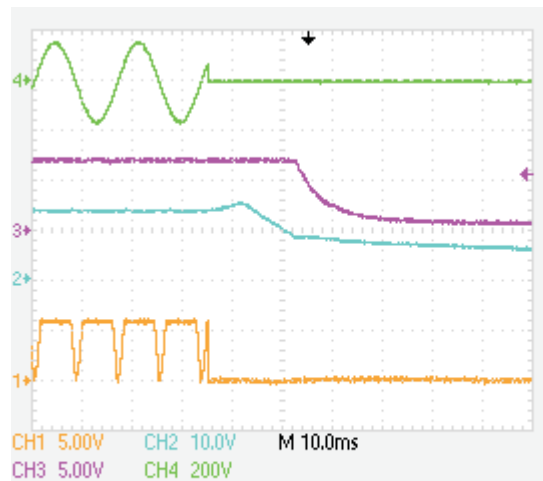

Figure 17. Turn Off, Full Load, No Dimmer
(CH 1 = SEN, CH2 = VDD, CH3 = BP, CH4 = VIN (115 VAC))

7.14 Dimmer Detection

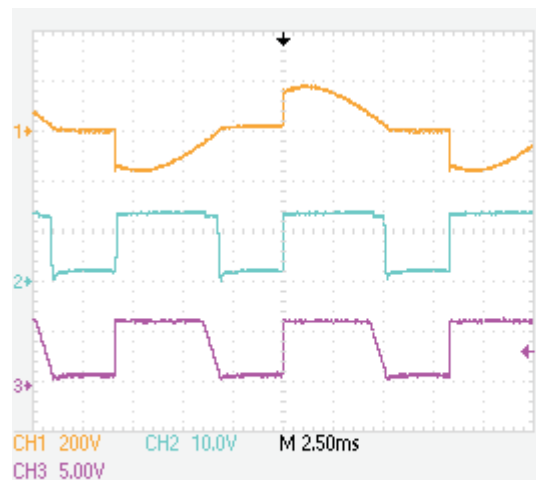

Figure 18. Dimmer Detection, With Dimmer
(CH1 = VIN (115 VAC), CH2 = DTC, CH3 = SEN)
(DTC sinks current during AC zero crossing to allow the TRIAC timing circuit to charge, initiating next TRIAC firing)

8 EVM Assembly Drawing and PCB Layout

The following figures (Figure 19 through Figure 26) show the design of the TPS92070EVM-682 printed circuit board.

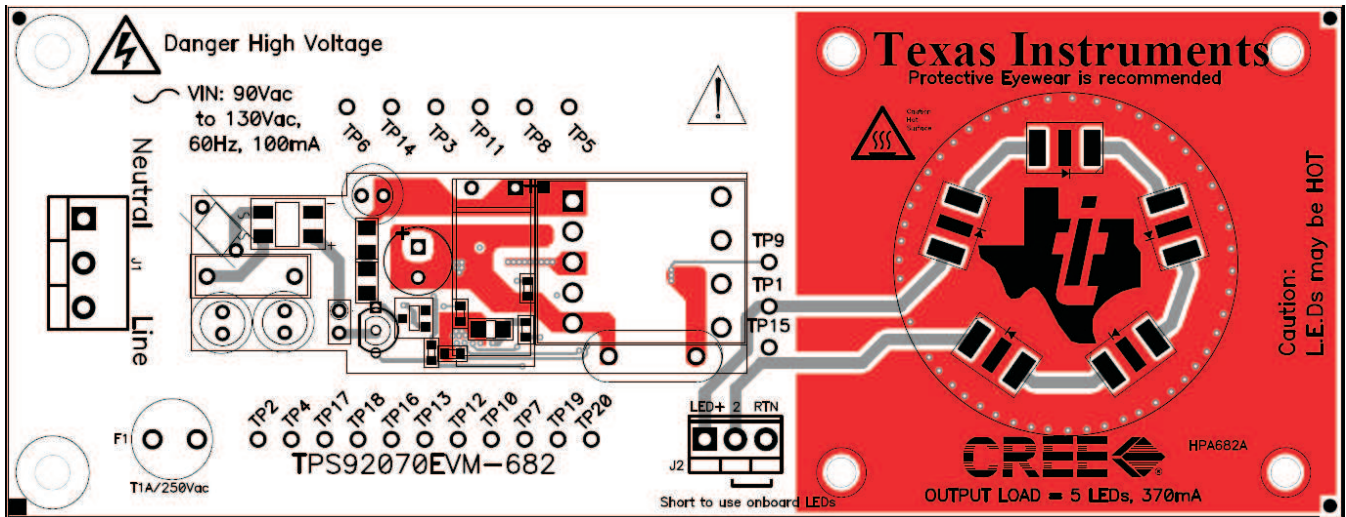

Figure 19. TPS92070EVM-682 (top view)

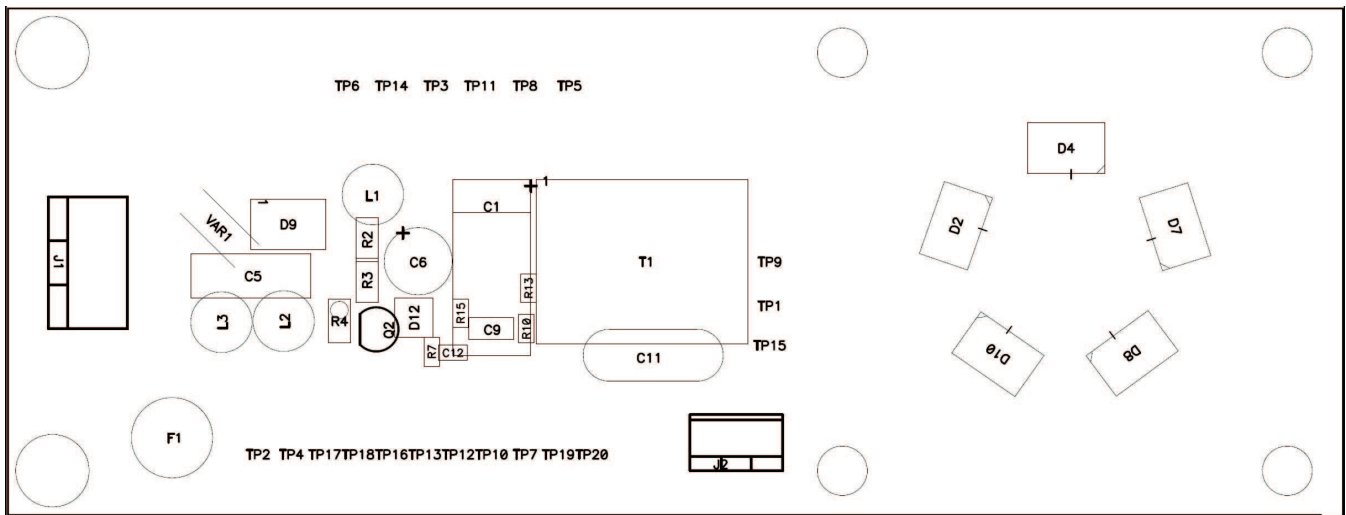

Figure 20. TPS92070EVM-682 Top Layer Assembly Drawing (top view)

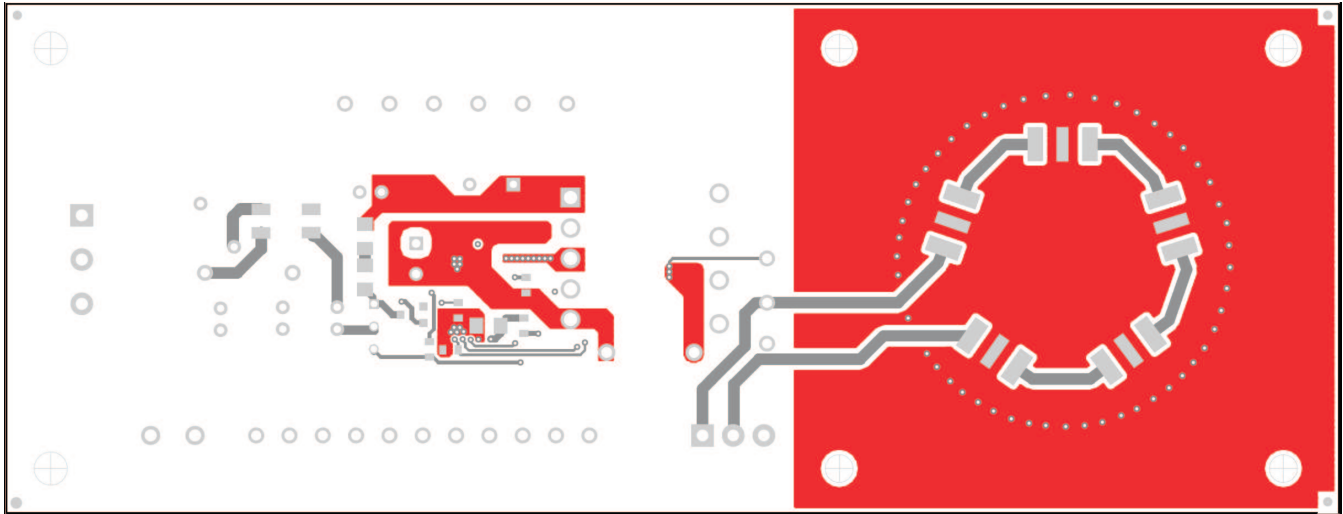

Figure 21. TPS92070EVM-682 Top Copper (top view)

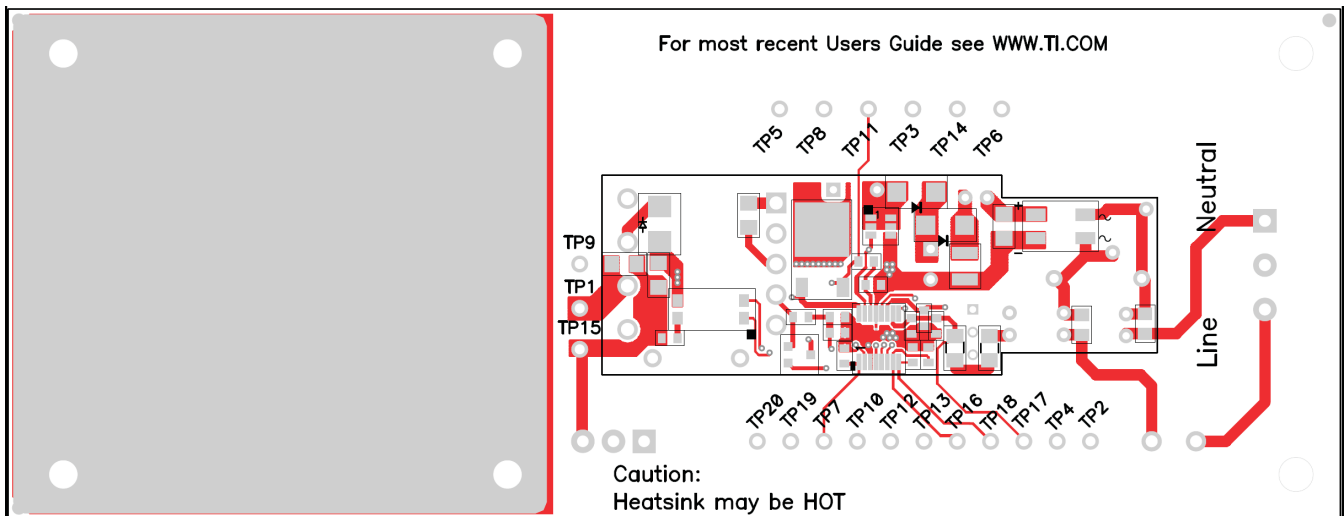

Figure 22. TPS92070EVM-682 (bottom view)

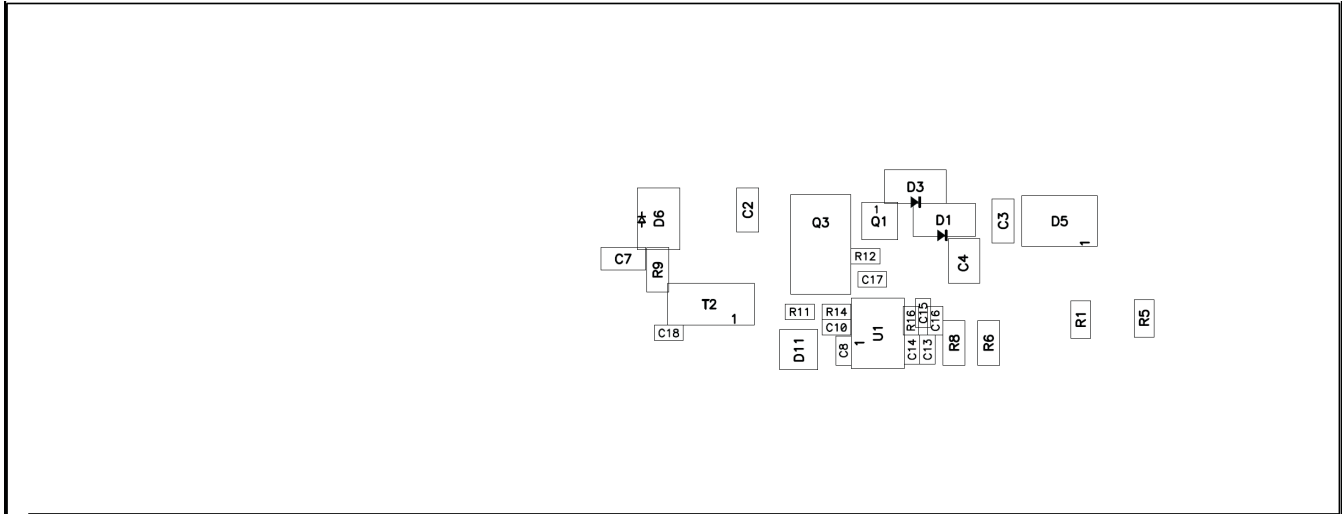

Figure 23. TPS92070EVM-682 Bottom Layer Assembly Drawing (bottom view)

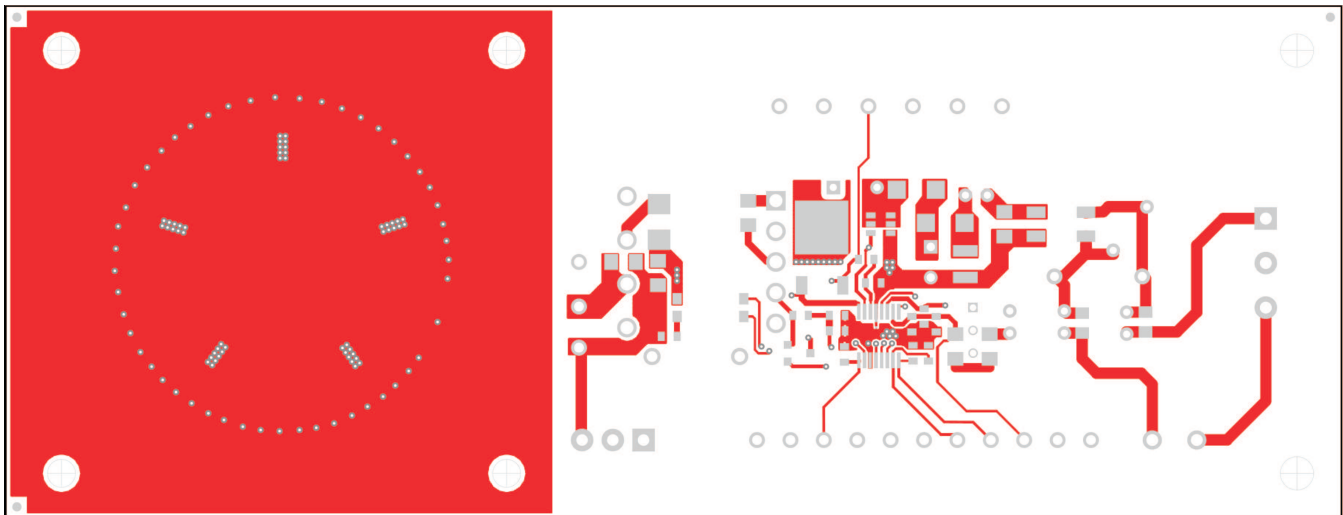

Figure 24. TPS92070EVM-682 Bottom Copper (bottom view)

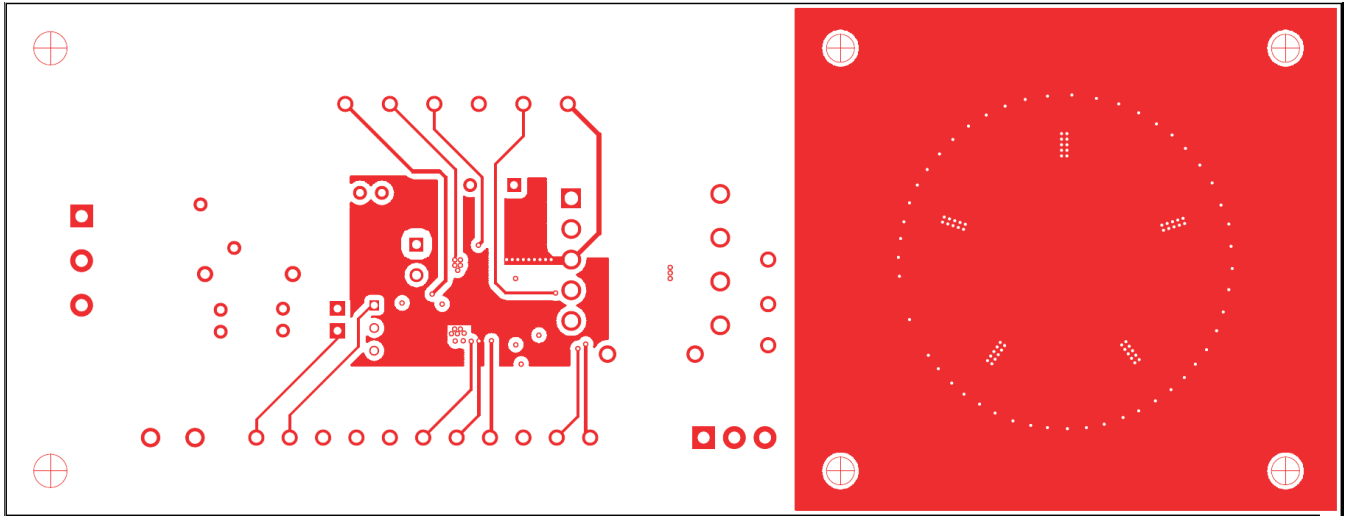

Figure 25. TPS92070EVM-682 Internal Layer 1 (top view)

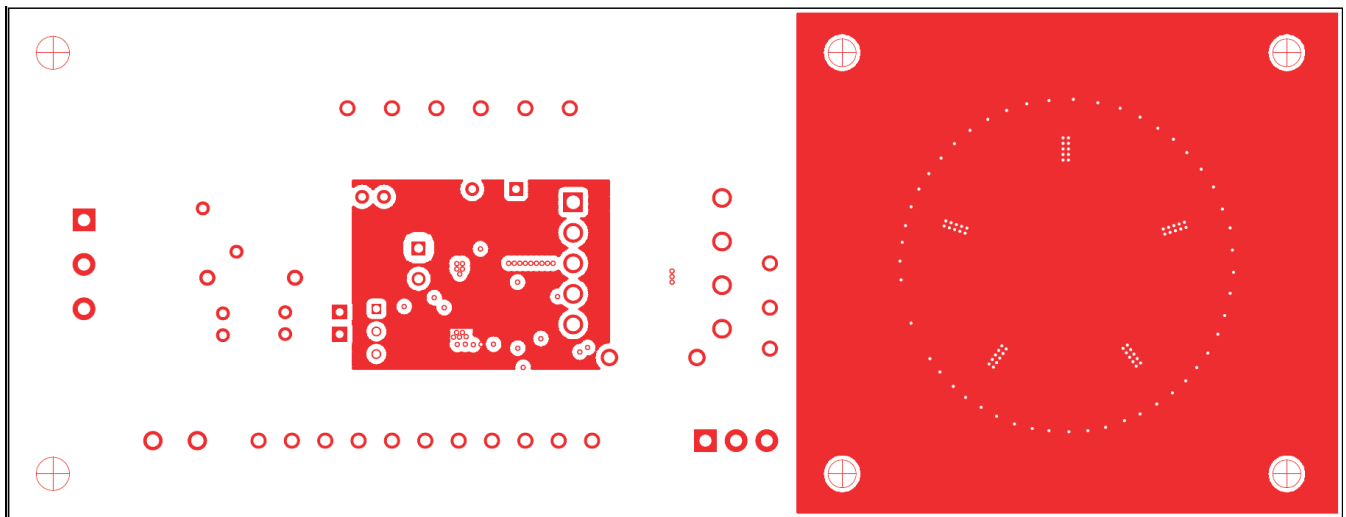

Figure 26. TPS92070EVM-682 Internal Layer 2 (top view)

9 List of Materials

Table 3. The EVM Components List According to the Schematic Shown in Figure 1

QTY	REF DES	DESCRIPTION	MFR	PART NUMBER
1	C1	Capacitor, aluminum electrolytic, 10 μ F, 200 V, -40°C to 105°C, \pm 20%, 10.00-mm diameter	United Chemi-Con	EKXG201ELL100MJ16S
1	C2	Capacitor, ceramic, 68 pF, 1000 V, U2J, \pm 5%, 1206	Murata Electronics	GRM31A7U3A680JW31D
1	C3	Capacitor, ceramic, 10 nF, 630 V, X7R, \pm 10%, 1206	Murata Electronics	GRM31BR72J103KW01L
1	C4	Capacitor, ceramic, 100 nF, 250 V, X7R, \pm 10%, 1210	TDK Corporation	C3225X7R2E104K
1	C5	Capacitor, metalized polypropylene film, 10 nF, 305 VAC, X2, \pm 20%, 0.157 inch x 0.512 inch	Epcos Inc.	B32921C3103M
1	C6	Capacitor, aluminum electrolytic, 10 μ F, 160 V, -40°C to 105°C, \pm 20%, 8.00-mm diameter	United Chemi-Con	UVZ2C100MPD
1	C7	Capacitor, ceramic, 10 μ F, 25 V, X7R, \pm 10%, 1206	Taiyo Yuden	TMK316B7106KL-TD
1	C8	Capacitor, ceramic, 0.47 μ F, 16 V, X7R, \pm 10%, 0603	Std	Std
1	C9	Capacitor, ceramic, 4.7 μ F, 25 V, X7R, \pm 10%, 1206	Murata Electronics	GRM31CR71E475KA88L
1	C10	Capacitor, ceramic, 27 pF, 50 V, C0G, NP0, \pm 5%, 0603	Std	Std
1	C11	Capacitor, ceramic disc, 3300 pF, 500 VAC, X1Y1, \pm 20%, 15-mm diameter	Vishay/BC Components	VY1332M59Y5UQ63V0
1	C12	Capacitor, ceramic, 0.1 μ F, 25 V, X7R, \pm 10%, 0603	Std	Std
1	C13	Capacitor, ceramic, 33 nF, 25 V, X7R, \pm 10%, 0603	Std	Std
2	C14, C18	Capacitor, ceramic, 0.22 μ F, 16 V, X7R, \pm 10%, 0603	Std	Std
1	C15	Capacitor, ceramic, 2.2 nF, 50 V, X7R, \pm 10%, 0603	Std	Std
1	C16	Capacitor, ceramic, 47 pF, 50 V, C0G, NP0, \pm 10%, 0603	Std	Std
1	C17	Capacitor, ceramic, 3.3 nF, 50 V, X7R, \pm 10%, 0603	Std	Std
2	D1, D3	Diode, rectifier, 1 A, 400 V, SMA	Fairchild Semiconductor	S1G
5	D2, D4, D7, D8, D10	LED, Xlamp, 1 A max, white, 5.0 mm x 6.0 mm	Cree	MX6AWT-B1-7B3-Q5-D-00001 or MX6AWT-B1-7D2-Q4-D-00001
2	D5, D9	Diode, bridge rectifier, 0.5 A, 400 V, SO-4	Fairchild Semiconductor	MB4S
1	D6	Diode, Schottky, 2 A, 60 V, SMB	Diodes, Inc.	B260-13-F
1	D11	Diode, switching, dual, 200 mA, 70 V, SOT-23	On Semiconductor	MMBD6100LT1G
1	D12	Diode, Zener, 5.1 V, 250 mW, SOT-23	NXP Semiconductors	BZX84-C5V1,215
1	F1	Fuse, slow blow, 1 A, 250 V, 0.335 inch	Littelfuse / Wickmann	38211000410
3	L1, L2, L3	Inductor, filter choke, 1 mH, \pm 10%, 6-mm diameter	Würth Midcom	7447462102V

Table 3. The EVM Components List According to the Schematic Shown in Figure 1 (continued)

QTY	REF DES	DESCRIPTION	MFR	PART NUMBER
1	Q1	MOSFET, N-channel, 200 V, 600 mA, 2.2 Ω , TSOP-6	International Rectifier	IRF5801TRPBF
1	Q2	MOSFET, N-channel, 600 V, 0.3 A, 11.5 Ω , TO-92	Fairchild Semiconductor	FQN1N60CTA
1	Q3	MOSFET, N-channel, 400 V, 5.4 A, 0.85 Ω , DPAK	STMicroelectronics	STD7NK40ZT
2	R1, R5	Resistor, chip, 7.5 k Ω , 1/10 W, \pm 1%, 0805	Std	Std
4	R2, R3, R6, R8	Resistor, thick film, 1.00 M Ω , 1/4 W, \pm 1%, 1206	Std	Std
1	R4	Resistor, metal film, 475 Ω , 1/4 W, \pm 1%, 0.250 inch x 0.093 inch diameter	Stackpole Electronics Inc.	RNF14FTD475R
1	R7	Resistor, chip, 205 Ω , 1/10 W, \pm 1%, 0603	Std	Std
1	R9	Resistor, thick film, 0.27 Ω , 1/2 W, \pm 1%, 1206	Vishay/Dale	RCWE1206R270FKEA
1	R10	Resistor, chip, 15 Ω , 1/10 W, \pm 1%, 0603	Std	Std
1	R11	Resistor, chip, 105 k Ω , 1/10 W, \pm 1%, 0603	Std	Std
1	R12	Resistor, chip, 511 Ω , 1/10 W, \pm 1%, 0603	Std	Std
1	R13	Resistor, chip, 1.00 Ω , 1/10 W, \pm 1%, 0603	Std	Std
2	R14, R15	Resistor, chip, 68.1 k Ω , 1/10 W, \pm 1%, 0603	Std	Std
1	R16	Resistor, chip, 226 k Ω , 1/10 W, \pm 1%, 0603	Std	Std
1	T1	Transformer, 2.40 mH, \pm 10%, 20.3 mm x 24.38 mm	Würth Midcom	750813045
1	T2	Transformer, 450 μ H, 1:1, 0.173 inch x 0.360 inch	Würth Midcom	750082157
1	U1	Dimmable Quasi-Resonant LED Lighting Controller, TSSOP	Texas Instruments	TPS92070PW
1	VAR1	Varistor, disk, 275 VAC, 5-mm radial, D size	Würth Elektronik	820552711
1	--	PCB, 6 inch x 2.3 inch x 0.6 inch	Any	HPA682
1	--	Heatsink, DC/DC half brick vertical fin, 2.40 inch x 2.28 inch x 0.45 inch	Wakefield Thermal Solutions	528-45AB
1	--	Jumper wire, u-shape, 0.200 inch x 22 AWG	3M	923345-02-C

Evaluation Board/Kit Important Notice

Texas Instruments (TI) provides the enclosed product(s) under the following conditions:

This evaluation board/kit is intended for use for **ENGINEERING DEVELOPMENT, DEMONSTRATION, OR EVALUATION PURPOSES ONLY** and is not considered by TI to be a finished end-product fit for general consumer use. Persons handling the product(s) must have electronics training and observe good engineering practice standards. As such, the goods being provided are not intended to be complete in terms of required design-, marketing-, and/or manufacturing-related protective considerations, including product safety and environmental measures typically found in end products that incorporate such semiconductor components or circuit boards. This evaluation board/kit does not fall within the scope of the European Union directives regarding electromagnetic compatibility, restricted substances (RoHS), recycling (WEEE), FCC, CE or UL, and therefore may not meet the technical requirements of these directives or other related directives.

Should this evaluation board/kit not meet the specifications indicated in the User's Guide, the board/kit may be returned within 30 days from the date of delivery for a full refund. **THE FOREGOING WARRANTY IS THE EXCLUSIVE WARRANTY MADE BY SELLER TO BUYER AND IS IN LIEU OF ALL OTHER WARRANTIES, EXPRESSED, IMPLIED, OR STATUTORY, INCLUDING ANY WARRANTY OF MERCHANTABILITY OR FITNESS FOR ANY PARTICULAR PURPOSE.**

The user assumes all responsibility and liability for proper and safe handling of the goods. Further, the user indemnifies TI from all claims arising from the handling or use of the goods. Due to the open construction of the product, it is the user's responsibility to take any and all appropriate precautions with regard to electrostatic discharge.

EXCEPT TO THE EXTENT OF THE INDEMNITY SET FORTH ABOVE, NEITHER PARTY SHALL BE LIABLE TO THE OTHER FOR ANY INDIRECT, SPECIAL, INCIDENTAL, OR CONSEQUENTIAL DAMAGES.

TI currently deals with a variety of customers for products, and therefore our arrangement with the user **is not exclusive.**

TI assumes **no liability for applications assistance, customer product design, software performance, or infringement of patents or services described herein.**

Please read the User's Guide and, specifically, the Warnings and Restrictions notice in the User's Guide prior to handling the product. This notice contains important safety information about temperatures and voltages. For additional information on TI's environmental and/or safety programs, please contact the TI application engineer or visit www.ti.com/esh.

No license is granted under any patent right or other intellectual property right of TI covering or relating to any machine, process, or combination in which such TI products or services might be or are used.

FCC Warning

This evaluation board/kit is intended for use for **ENGINEERING DEVELOPMENT, DEMONSTRATION, OR EVALUATION PURPOSES ONLY** and is not considered by TI to be a finished end-product fit for general consumer use. It generates, uses, and can radiate radio frequency energy and has not been tested for compliance with the limits of computing devices pursuant to part 15 of FCC rules, which are designed to provide reasonable protection against radio frequency interference. Operation of this equipment in other environments may cause interference with radio communications, in which case the user at his own expense will be required to take whatever measures may be required to correct this interference.

EVM Warnings and Restrictions

It is important to operate this EVM within the input voltage range of 90 VAC to 130 VAC and the output voltage range of 14 V to 19 V.

Exceeding the specified input range may cause unexpected operation and/or irreversible damage to the EVM. If there are questions concerning the input range, please contact a TI field representative prior to connecting the input power.

Applying loads outside of the specified output range may result in unintended operation and/or possible permanent damage to the EVM. Please consult the EVM User's Guide prior to connecting any load to the EVM output. If there is uncertainty as to the load specification, please contact a TI field representative.

During normal operation, some circuit components may have case temperatures greater than 85° C. The EVM is designed to operate properly with certain components above 85° C as long as the input and output ranges are maintained. These components include but are not limited to linear regulators, switching transistors, pass transistors, and current sense resistors. These types of devices can be identified using the EVM schematic located in the EVM User's Guide. When placing measurement probes near these devices during operation, please be aware that these devices may be very warm to the touch.

EVALUATION BOARD/KIT/MODULE (EVM) ADDITIONAL TERMS

Texas Instruments (TI) provides the enclosed Evaluation Board/Kit/Module (EVM) under the following conditions:

The user assumes all responsibility and liability for proper and safe handling of the goods. Further, the user indemnifies TI from all claims arising from the handling or use of the goods.

Should this evaluation board/kit not meet the specifications indicated in the User's Guide, the board/kit may be returned within 30 days from the date of delivery for a full refund. THE FOREGOING LIMITED WARRANTY IS THE EXCLUSIVE WARRANTY MADE BY SELLER TO BUYER AND IS IN LIEU OF ALL OTHER WARRANTIES, EXPRESSED, IMPLIED, OR STATUTORY, INCLUDING ANY WARRANTY OF MERCHANTABILITY OR FITNESS FOR ANY PARTICULAR PURPOSE. EXCEPT TO THE EXTENT OF THE INDEMNITY SET FORTH ABOVE, NEITHER PARTY SHALL BE LIABLE TO THE OTHER FOR ANY INDIRECT, SPECIAL, INCIDENTAL, OR CONSEQUENTIAL DAMAGES.

Please read the User's Guide and, specifically, the Warnings and Restrictions notice in the User's Guide prior to handling the product. This notice contains important safety information about temperatures and voltages. For additional information on TI's environmental and/or safety programs, please visit www.ti.com/esh or contact TI.

No license is granted under any patent right or other intellectual property right of TI covering or relating to any machine, process, or combination in which such TI products or services might be or are used. TI currently deals with a variety of customers for products, and therefore our arrangement with the user is not exclusive. TI assumes no liability for applications assistance, customer product design, software performance, or infringement of patents or services described herein.

REGULATORY COMPLIANCE INFORMATION

As noted in the EVM User's Guide and/or EVM itself, this EVM and/or accompanying hardware may or may not be subject to the Federal Communications Commission (FCC) and Industry Canada (IC) rules.

For EVMs **not** subject to the above rules, this evaluation board/kit/module is intended for use for ENGINEERING DEVELOPMENT, DEMONSTRATION OR EVALUATION PURPOSES ONLY and is not considered by TI to be a finished end product fit for general consumer use. It generates, uses, and can radiate radio frequency energy and has not been tested for compliance with the limits of computing devices pursuant to part 15 of FCC or ICES-003 rules, which are designed to provide reasonable protection against radio frequency interference. Operation of the equipment may cause interference with radio communications, in which case the user at his own expense will be required to take whatever measures may be required to correct this interference.

General Statement for EVMs including a radio

User Power/Frequency Use Obligations: This radio is intended for development/professional use only in legally allocated frequency and power limits. Any use of radio frequencies and/or power availability of this EVM and its development application(s) must comply with local laws governing radio spectrum allocation and power limits for this evaluation module. It is the user's sole responsibility to only operate this radio in legally acceptable frequency space and within legally mandated power limitations. Any exceptions to this are strictly prohibited and unauthorized by Texas Instruments unless user has obtained appropriate experimental/development licenses from local regulatory authorities, which is responsibility of user including its acceptable authorization.

For EVMs annotated as FCC – FEDERAL COMMUNICATIONS COMMISSION Part 15 Compliant

Caution

This device complies with part 15 of the FCC Rules. Operation is subject to the following two conditions: (1) This device may not cause harmful interference, and (2) this device must accept any interference received, including interference that may cause undesired operation.

Changes or modifications not expressly approved by the party responsible for compliance could void the user's authority to operate the equipment.

FCC Interference Statement for Class A EVM devices

This equipment has been tested and found to comply with the limits for a Class A digital device, pursuant to part 15 of the FCC Rules. These limits are designed to provide reasonable protection against harmful interference when the equipment is operated in a commercial environment. This equipment generates, uses, and can radiate radio frequency energy and, if not installed and used in accordance with the instruction manual, may cause harmful interference to radio communications. Operation of this equipment in a residential area is likely to cause harmful interference in which case the user will be required to correct the interference at his own expense.

FCC Interference Statement for Class B EVM devices

This equipment has been tested and found to comply with the limits for a Class B digital device, pursuant to part 15 of the FCC Rules. These limits are designed to provide reasonable protection against harmful interference in a residential installation. This equipment generates, uses and can radiate radio frequency energy and, if not installed and used in accordance with the instructions, may cause harmful interference to radio communications. However, there is no guarantee that interference will not occur in a particular installation. If this equipment does cause harmful interference to radio or television reception, which can be determined by turning the equipment off and on, the user is encouraged to try to correct the interference by one or more of the following measures:

- Reorient or relocate the receiving antenna.
- Increase the separation between the equipment and receiver.
- Connect the equipment into an outlet on a circuit different from that to which the receiver is connected.
- Consult the dealer or an experienced radio/TV technician for help.

For EVMs annotated as IC – INDUSTRY CANADA Compliant

This Class A or B digital apparatus complies with Canadian ICES-003.

Changes or modifications not expressly approved by the party responsible for compliance could void the user's authority to operate the equipment.

Concerning EVMs including radio transmitters

This device complies with Industry Canada licence-exempt RSS standard(s). Operation is subject to the following two conditions: (1) this device may not cause interference, and (2) this device must accept any interference, including interference that may cause undesired operation of the device.

Concerning EVMs including detachable antennas

Under Industry Canada regulations, this radio transmitter may only operate using an antenna of a type and maximum (or lesser) gain approved for the transmitter by Industry Canada. To reduce potential radio interference to other users, the antenna type and its gain should be so chosen that the equivalent isotropically radiated power (e.i.r.p.) is not more than that necessary for successful communication.

This radio transmitter has been approved by Industry Canada to operate with the antenna types listed in the user guide with the maximum permissible gain and required antenna impedance for each antenna type indicated. Antenna types not included in this list, having a gain greater than the maximum gain indicated for that type, are strictly prohibited for use with this device.

Cet appareil numérique de la classe A ou B est conforme à la norme NMB-003 du Canada.

Les changements ou les modifications pas expressément approuvés par la partie responsable de la conformité ont pu vider l'autorité de l'utilisateur pour actionner l'équipement.

Concernant les EVMs avec appareils radio

Le présent appareil est conforme aux CNR d'Industrie Canada applicables aux appareils radio exempts de licence. L'exploitation est autorisée aux deux conditions suivantes : (1) l'appareil ne doit pas produire de brouillage, et (2) l'utilisateur de l'appareil doit accepter tout brouillage radioélectrique subi, même si le brouillage est susceptible d'en compromettre le fonctionnement.

Concernant les EVMs avec antennes détachables

Conformément à la réglementation d'Industrie Canada, le présent émetteur radio peut fonctionner avec une antenne d'un type et d'un gain maximal (ou inférieur) approuvé pour l'émetteur par Industrie Canada. Dans le but de réduire les risques de brouillage radioélectrique à l'intention des autres utilisateurs, il faut choisir le type d'antenne et son gain de sorte que la puissance isotrope rayonnée équivalente (p.i.r.e.) ne dépasse pas l'intensité nécessaire à l'établissement d'une communication satisfaisante.

Le présent émetteur radio a été approuvé par Industrie Canada pour fonctionner avec les types d'antenne énumérés dans le manuel d'usage et ayant un gain admissible maximal et l'impédance requise pour chaque type d'antenne. Les types d'antenne non inclus dans cette liste, ou dont le gain est supérieur au gain maximal indiqué, sont strictement interdits pour l'exploitation de l'émetteur.

【Important Notice for Users of this Product in Japan】

This development kit is NOT certified as Confirming to Technical Regulations of Radio Law of Japan

If you use this product in Japan, you are required by Radio Law of Japan to follow the instructions below with respect to this product:

1. Use this product in a shielded room or any other test facility as defined in the notification #173 issued by Ministry of Internal Affairs and Communications on March 28, 2006, based on Sub-section 1.1 of Article 6 of the Ministry's Rule for Enforcement of Radio Law of Japan,
2. Use this product only after you obtained the license of Test Radio Station as provided in Radio Law of Japan with respect to this product, or
3. Use of this product only after you obtained the Technical Regulations Conformity Certification as provided in Radio Law of Japan with respect to this product. Also, please do not transfer this product, unless you give the same notice above to the transferee. Please note that if you could not follow the instructions above, you will be subject to penalties of Radio Law of Japan.

Texas Instruments Japan Limited
(address) 24-1, Nishi-Shinjuku 6 chome, Shinjuku-ku, Tokyo, Japan

<http://www.tij.co.jp>

【ご使用にあたっての注】

本開発キットは技術基準適合証明を受けておりません。

本製品のご使用に際しては、電波法遵守のため、以下のいずれかの措置を取っていただく必要がありますのでご注意ください。

1. 電波法施行規則第6条第1項第1号に基づく平成18年3月28日総務省告示第173号で定められた電波暗室等の試験設備でご使用いただく。
2. 実験局の免許を取得後ご使用いただく。
3. 技術基準適合証明を取得後ご使用いただく。

なお、本製品は、上記の「ご使用にあたっての注意」を譲渡先、移転先に通知しない限り、譲渡、移転できないものとします。

上記を遵守頂けない場合は、電波法の罰則が適用される可能性があることをご留意ください。

日本テキサス・インスツルメンツ株式会社
東京都新宿区西新宿6丁目2-4番1号
西新宿三井ビル

<http://www.tij.co.jp>

EVALUATION BOARD/KIT/MODULE (EVM) WARNINGS, RESTRICTIONS AND DISCLAIMERS

For Feasibility Evaluation Only, in Laboratory/Development Environments. Unless otherwise indicated, this EVM is not a finished electrical equipment and not intended for consumer use. It is intended solely for use for preliminary feasibility evaluation in laboratory/development environments by technically qualified electronics experts who are familiar with the dangers and application risks associated with handling electrical mechanical components, systems and subsystems. It should not be used as all or part of a finished end product.

Your Sole Responsibility and Risk. You acknowledge, represent and agree that:

1. You have unique knowledge concerning Federal, State and local regulatory requirements (including but not limited to Food and Drug Administration regulations, if applicable) which relate to your products and which relate to your use (and/or that of your employees, affiliates, contractors or designees) of the EVM for evaluation, testing and other purposes.
2. You have full and exclusive responsibility to assure the safety and compliance of your products with all such laws and other applicable regulatory requirements, and also to assure the safety of any activities to be conducted by you and/or your employees, affiliates, contractors or designees, using the EVM. Further, you are responsible to assure that any interfaces (electronic and/or mechanical) between the EVM and any human body are designed with suitable isolation and means to safely limit accessible leakage currents to minimize the risk of electrical shock hazard.
3. You will employ reasonable safeguards to ensure that your use of the EVM will not result in any property damage, injury or death, even if the EVM should fail to perform as described or expected.
4. You will take care of proper disposal and recycling of the EVM's electronic components and packing materials.

Certain Instructions. It is important to operate this EVM within TI's recommended specifications and environmental considerations per the user guidelines. Exceeding the specified EVM ratings (including but not limited to input and output voltage, current, power, and environmental ranges) may cause property damage, personal injury or death. If there are questions concerning these ratings please contact a TI field representative prior to connecting interface electronics including input power and intended loads. Any loads applied outside of the specified output range may result in unintended and/or inaccurate operation and/or possible permanent damage to the EVM and/or interface electronics. Please consult the EVM User's Guide prior to connecting any load to the EVM output. If there is uncertainty as to the load specification, please contact a TI field representative. During normal operation, some circuit components may have case temperatures greater than 60°C as long as the input and output are maintained at a normal ambient operating temperature. These components include but are not limited to linear regulators, switching transistors, pass transistors, and current sense resistors which can be identified using the EVM schematic located in the EVM User's Guide. When placing measurement probes near these devices during normal operation, please be aware that these devices may be very warm to the touch. As with all electronic evaluation tools, only qualified personnel knowledgeable in electronic measurement and diagnostics normally found in development environments should use these EVMs.

Agreement to Defend, Indemnify and Hold Harmless. You agree to defend, indemnify and hold TI, its licensors and their representatives harmless from and against any and all claims, damages, losses, expenses, costs and liabilities (collectively, "Claims") arising out of or in connection with any use of the EVM that is not in accordance with the terms of the agreement. This obligation shall apply whether Claims arise under law of tort or contract or any other legal theory, and even if the EVM fails to perform as described or expected.

Safety-Critical or Life-Critical Applications. If you intend to evaluate the components for possible use in safety critical applications (such as life support) where a failure of the TI product would reasonably be expected to cause severe personal injury or death, such as devices which are classified as FDA Class III or similar classification, then you must specifically notify TI of such intent and enter into a separate Assurance and Indemnity Agreement.

Mailing Address: Texas Instruments, Post Office Box 655303, Dallas, Texas 75265
Copyright © 2012, Texas Instruments Incorporated

IMPORTANT NOTICE

Texas Instruments Incorporated and its subsidiaries (TI) reserve the right to make corrections, enhancements, improvements and other changes to its semiconductor products and services per JESD46, latest issue, and to discontinue any product or service per JESD48, latest issue. Buyers should obtain the latest relevant information before placing orders and should verify that such information is current and complete. All semiconductor products (also referred to herein as "components") are sold subject to TI's terms and conditions of sale supplied at the time of order acknowledgment.

TI warrants performance of its components to the specifications applicable at the time of sale, in accordance with the warranty in TI's terms and conditions of sale of semiconductor products. Testing and other quality control techniques are used to the extent TI deems necessary to support this warranty. Except where mandated by applicable law, testing of all parameters of each component is not necessarily performed.

TI assumes no liability for applications assistance or the design of Buyers' products. Buyers are responsible for their products and applications using TI components. To minimize the risks associated with Buyers' products and applications, Buyers should provide adequate design and operating safeguards.

TI does not warrant or represent that any license, either express or implied, is granted under any patent right, copyright, mask work right, or other intellectual property right relating to any combination, machine, or process in which TI components or services are used. Information published by TI regarding third-party products or services does not constitute a license to use such products or services or a warranty or endorsement thereof. Use of such information may require a license from a third party under the patents or other intellectual property of the third party, or a license from TI under the patents or other intellectual property of TI.

Reproduction of significant portions of TI information in TI data books or data sheets is permissible only if reproduction is without alteration and is accompanied by all associated warranties, conditions, limitations, and notices. TI is not responsible or liable for such altered documentation. Information of third parties may be subject to additional restrictions.

Resale of TI components or services with statements different from or beyond the parameters stated by TI for that component or service voids all express and any implied warranties for the associated TI component or service and is an unfair and deceptive business practice. TI is not responsible or liable for any such statements.

Buyer acknowledges and agrees that it is solely responsible for compliance with all legal, regulatory and safety-related requirements concerning its products, and any use of TI components in its applications, notwithstanding any applications-related information or support that may be provided by TI. Buyer represents and agrees that it has all the necessary expertise to create and implement safeguards which anticipate dangerous consequences of failures, monitor failures and their consequences, lessen the likelihood of failures that might cause harm and take appropriate remedial actions. Buyer will fully indemnify TI and its representatives against any damages arising out of the use of any TI components in safety-critical applications.

In some cases, TI components may be promoted specifically to facilitate safety-related applications. With such components, TI's goal is to help enable customers to design and create their own end-product solutions that meet applicable functional safety standards and requirements. Nonetheless, such components are subject to these terms.

No TI components are authorized for use in FDA Class III (or similar life-critical medical equipment) unless authorized officers of the parties have executed a special agreement specifically governing such use.

Only those TI components which TI has specifically designated as military grade or "enhanced plastic" are designed and intended for use in military/aerospace applications or environments. Buyer acknowledges and agrees that any military or aerospace use of TI components which have **not** been so designated is solely at the Buyer's risk, and that Buyer is solely responsible for compliance with all legal and regulatory requirements in connection with such use.

TI has specifically designated certain components which meet ISO/TS16949 requirements, mainly for automotive use. Components which have not been so designated are neither designed nor intended for automotive use; and TI will not be responsible for any failure of such components to meet such requirements.

Products

Audio	www.ti.com/audio
Amplifiers	amplifier.ti.com
Data Converters	dataconverter.ti.com
DLP® Products	www.dlp.com
DSP	dsp.ti.com
Clocks and Timers	www.ti.com/clocks
Interface	interface.ti.com
Logic	logic.ti.com
Power Mgmt	power.ti.com
Microcontrollers	microcontroller.ti.com
RFID	www.ti-rfid.com
OMAP Applications Processors	www.ti.com/omap
Wireless Connectivity	www.ti.com/wirelessconnectivity

Applications

Automotive and Transportation	www.ti.com/automotive
Communications and Telecom	www.ti.com/communications
Computers and Peripherals	www.ti.com/computers
Consumer Electronics	www.ti.com/consumer-apps
Energy and Lighting	www.ti.com/energy
Industrial	www.ti.com/industrial
Medical	www.ti.com/medical
Security	www.ti.com/security
Space, Avionics and Defense	www.ti.com/space-avionics-defense
Video and Imaging	www.ti.com/video

TI E2E Community

e2e.ti.com