

SN54365A THRU SN54368A, SN54LS365A THRU SN54LS368A SN74365A THRU SN74368A, SN74LS365A THRU SN74LS368A HEX BUS DRIVERS WITH 3-STATE OUTPUTS

DECEMBER 1983—REVISED MARCH 1988

- 3-State Outputs Drive Bus Lines or Buffer Memory Address Registers
 - Choice of True or Inverting Outputs
 - Package Options Include Plastic "Small Outline" Packages, Ceramic Chip Carriers and Flat Packages, and Plastic and Ceramic DIPs
 - Dependable Texas Instruments Quality and Reliability
- '365A, '367A, 'LS365A, 'LS367A True Outputs
'366A, '368A, 'LS366A, 'LS368A Inverting Outputs

SN54365A, 366A, SN54LS365A, 366A . . . J PACKAGE
SN74365A, 366A . . . N PACKAGE
SN74LS365A, SN74LS366A . . . D OR N PACKAGE

(TOP VIEW)

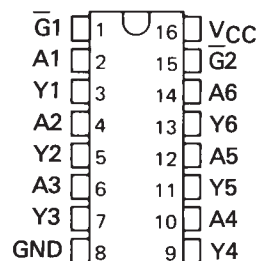

SN54LS365A, SN54LS366A . . . FK PACKAGE

(TOP VIEW)

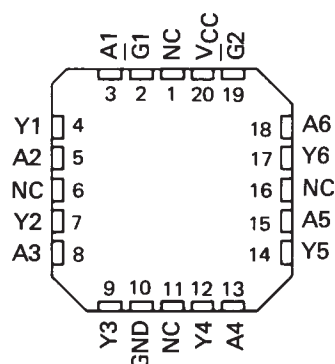

SN54367A, 368A, SN54LS367A, 368A . . . J PACKAGE
SN74367A, 368A . . . N PACKAGE
SN74LS367A, SN74LS368A . . . D OR N PACKAGE

(TOP VIEW)

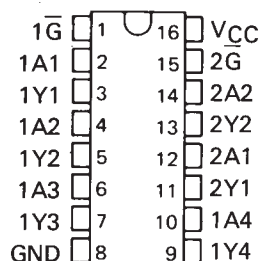

SN54LS367A, SN54LS368A . . . FK PACKAGE

(TOP VIEW)

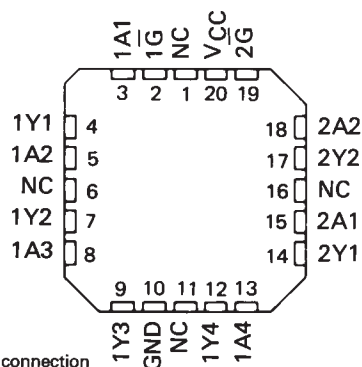

NC - No internal connection

description

These Hex buffers and line drivers are designed specifically to improve both the performance and density of three-state memory address drivers, clock drivers, and bus oriented receivers and transmitters. The designer has choice of selected combinations of inverting and noninverting outputs, symmetrical \bar{G} (active-low control) inputs.

These devices feature high fan-out, improved fan-in, and can be used to drive terminated lines down to 133 ohms.

The SN54365A thru SN54368A and SN54LS365A thru SN54LS368A are characterized for operation over the full military temperature range of -55°C to 125°C . The SN74365A thru SN74368A and SN74LS365A thru SN74LS368A are characterized for operation from 0°C to 70°C .

2

TTL Devices

PRODUCTION DATA documents contain information current as of publication date. Products conform to specifications per the terms of Texas Instruments standard warranty. Production processing does not necessarily include testing of all parameters.



POST OFFICE BOX 655012 • DALLAS, TEXAS 75265

SN54365A THRU SN54368A, SN54LS365A THRU SN54LS368A SN74365A THRU SN74368A, SN74LS365A THRU SN74LS368A HEX BUS DRIVERS WITH 3-STATE OUTPUTS

schematics of inputs and outputs

'365A thru '368A



'LS365A thru 'LS368A



2

TTL Devices

logic diagrams (positive logic)



Pin numbers shown are for D, J, and N packages.

**SN54365A THRU SN54368A, SN54LS365A THRU SN54LS368A
SN74365A THRU SN74368A, SN74LS365A THRU SN74LS368A
HEX BUS DRIVERS WITH 3-STATE OUTPUTS**

logic symbols†



†These symbols are in accordance with ANSI/IEEE Std 91-1984 and IEC Publication 617-12.
Pin numbers shown are for D, J, and N packages.

absolute maximum ratings over operating free-air temperature range (unless otherwise noted)

Supply voltage, V_{CC} (see Note 1)	7 V
Input voltage: '365A, '366A, '367A, '368A	5.5 V
'LS365A, 'LS366A, 'LS367A, 'LS368A	7 V
Voltage applied to a disabled 3-state output	5.5 V
Operating free-air temperature: SN54'	-55°C to 125°C
SN74'	0°C to 70°C
Storage temperature range	-65°C to 150°C

NOTE 1: Voltage values are with respect to network ground terminal.

SN54365A, SN54367A
SN74365A, SN74367A
HEX BUS DRIVERS WITH 3-STATE OUTPUTS

recommended operating conditions

	SN54365A SN54367A			SN74365A SN74367A			UNIT
	MIN	NOM	MAX	MIN	NOM	MAX	
V _{CC} Supply voltage	4.5	5	5.5	4.75	5	5.25	V
V _{IH} High-level input voltage	2			2			V
V _{IL} Low-level input voltage	0.8			0.8			V
I _{OH} High-level output current	-2			-5.2			mA
I _{OL} Low-level output current	32			32			mA
T _A Operating free-air temperature	-55			125			0 70 °C

electrical characteristics over recommended operating free-air temperature range (unless otherwise noted)

PARAMETER	TEST CONDITIONS†	SN54365A SN54367A			SN74365A SN74367A			UNIT
		MIN	TYP‡	MAX	MIN	TYP‡	MAX	
V _{IK}	V _{CC} = MIN, I _I = -12 mA	-1.5			-1.5			V
V _{OH}	V _{CC} = MIN, V _{IH} = 2 V, V _{IL} = 0.8 V, I _{OH} = MAX	2.4	3.3		2.4	3.1		V
V _{OL}	V _{CC} = MIN, V _{IH} = 2 V, V _{IL} = 0.8 V, I _{OL} = 32 mA	0.4			0.4			V
I _{OZ}	V _{CC} = MAX, V _{IH} = 2 V, V _{IL} = 0.8 V, V _O = 2.4 V	40			40			μA
	V _{CC} = MAX, V _{IH} = 2 V, V _{IL} = 0.8 V, V _O = 0.4 V	-40			-40			
I _I	V _{CC} = MAX, V _I = 5.5 V	1			1			mA
I _{IH}	V _{CC} = MAX, V _I = 2.4 V	40			40			μA
I _{IL}	A Inputs V _{CC} = MAX, V _I = 0.5 V, Either \bar{G} input at 2 V	-40			-40			μA
	V _{CC} = MAX, V _I = 0.4 V, Both \bar{G} inputs at 0.4 V	-1.6			-1.6			
\bar{G} Inputs	V _{CC} = MAX, V _I = 0.4 V	-1.6			-1.6			mA
I _{OS} §	V _{CC} = MAX	-40	-130		-40	-130		mA
I _{CC}	V _{CC} = MAX, Data inputs = 0 V, Output controls = 4.5 V	65	85		65	85		mA

† For conditions shown as MIN or MAX, use the appropriate value specified under recommended operating conditions.

‡ All typical values are at V_{CC} = 5 V, T_A = 25°C.

§ Not more than one output should be shorted at a time.

switching characteristics, V_{CC} = 5 V, T_A = 25°C (see note 2)

PARAMETER	FROM (INPUT)	TO (OUTPUT)	TEST CONDITIONS	MIN	TYP	MAX	UNIT
t _{PLH}	Any	Y	R _L = 400 Ω, C _L = 50 pF	16			ns
t _{PHL}				22			ns
t _{PZH}				35			ns
t _{PZL}				37			ns
t _{PHZ}				11			ns
t _{PLZ}				27			ns

NOTE 2: Load circuits and voltage waveforms are shown in Section 1.

SN54366A, SN54368A
SN74366A, SN74368A
HEX BUS DRIVERS WITH 3-STATE OUTPUTS

recommended operating conditions

	SN54366A SN54368A			SN74366A SN74368A			UNIT
	MIN	NOM	MAX	MIN	NOM	MAX	
V _{CC} Supply voltage	4.5	5	5.5	4.75	5	5.25	V
V _{IH} High-level input voltage	2			2			V
V _{IL} Low-level input voltage			0.8			0.8	V
I _{OH} High-level output current			-2			-5.2	mA
I _{OL} Low-level output current			32			32	mA
T _A Operating free-air temperature	-55		125	0		70	°C

electrical characteristics over recommended operating free-air temperature range (unless otherwise noted)

PARAMETER	TEST CONDITIONS†	SN54366A SN54368A			SN74366A SN74368A			UNIT
		MIN	TYP‡	MAX	MIN	TYP‡	MAX	
V _{IK}	V _{CC} = MIN, I _I = -12 mA			-1.5			-1.5	V
V _{OH}	V _{CC} = MIN, V _{IH} = 2 V, V _{IL} = 0.8 V, I _{OH} = MAX	2.4	3.3		2.4	3.1		V
V _{OL}	V _{CC} = MIN, V _{IH} = 2 V, V _{IL} = 0.8 V, I _{OL} = 32 mA			0.4			0.4	V
I _{OZ}	V _{CC} = MAX, V _{IH} = 2 V, V _{IL} = 0.8 V, V _O = 2.4 V			40			40	μA
	V _{CC} = MAX, V _{IH} = 2 V, V _{IL} = 0.8 V, V _O = 0.4 V			-40			-40	
I _I	V _{CC} = MAX, V _I = 5.5 V			1			1	mA
I _{IH}	V _{CC} = MAX, V _I = 2.4 V			40			40	μA
I _{IL}	A Inputs	V _{CC} = MAX, V _I = 0.5 V, Either \bar{G} input at 2 V			-40		-40	μA
		V _{CC} = MAX, V _I = 0.4 V, Both \bar{G} inputs at 0.4 V			-1.6		-1.6	
	\bar{G} Inputs	V _{CC} = MAX, V _I = 0.4 V			-1.6		-1.6	mA
I _{OS} §	V _{CC} = MAX	-40		-130	-40		-130	mA
I _{CC}	V _{CC} = MAX, Data inputs = 0 V, Output controls = 4.5 V,		59	77		59	77	mA

† For conditions shown as MIN or MAX, use the appropriate value specified under recommended operating conditions.

‡ All typical values are at V_{CC} = 5 V, T_A = 25°C.

§ Not more than one output should be shorted at a time.

switching characteristics, V_{CC} = 5 V, T_A = 25°C (see note 2)

PARAMETER	FROM (INPUT)	TO (OUTPUT)	TEST CONDITIONS	MIN	TYP	MAX	UNIT	
t _{PLH}	Any	Y	R _L = 400 Ω, C _L = 50 pF			17	ns	
t _{PHL}						16	ns	
t _{PZH}						35	ns	
t _{PZL}						37	ns	
t _{PHZ}			R _L = 400 Ω, C _L = 5 pF				11	ns
t _{PLZ}							27	ns

NOTE 2: Load circuits and voltage waveforms are shown in Section 1.

2
TTL Devices



**SN54LS365A, SN54LS367A
SN74LS365A, SN74LS367A
HEX BUS DRIVERS WITH 3-STATE OUTPUTS**

recommended operating conditions

	SN54LS365A SN54LS367A			SN74LS365A SN74LS367A			UNIT
	MIN	NOM	MAX	MIN	NOM	MAX	
V _{CC} Supply voltage	4.5	5	5.5	4.75	5	5.25	V
V _{IH} High-level input voltage	2			2			V
V _{IL} Low-level input voltage			0.7			0.8	V
I _{OH} High-level output current			-1			-2.6	mA
I _{OL} Low-level output current			12			24	mA
T _A Operating free-air temperature	-55		125	0		70	°C

electrical characteristics over recommended operating free-air temperature range (unless otherwise noted)

PARAMETER	TEST CONDITIONS†	SN54LS365A SN54LS367A		SN74LS365A SN74LS367A		UNIT		
		MIN	TYP‡	MAX	MIN		TYP‡	MAX
V _{IK}	V _{CC} = MIN, I _I = -18 mA			-1.5		-1.5	V	
V _{OH}	V _{CC} = MIN, V _{IH} = 2 V, V _{IL} = MAX, I _{OH} = MAX	2.4	3.3		2.4	3.1	V	
V _{OL}	V _{CC} = MIN, V _{IH} = 2 V, V _{IL} = MAX, I _{OL} = 12 mA		0.25	0.4		0.25	0.4	V
	V _{CC} = MIN, V _{IH} = 2 V, V _{IL} = 0.8 V, I _{OL} = 24 mA					0.35	0.5	
I _{OZ}	V _{CC} = MAX, V _{IH} = 2 V, V _{IL} = MAX, V _O = 2.4 V			20		20	μA	
	V _{CC} = MAX, V _{IH} = 2 V, V _{IL} = MAX, V _O = 0.4 V			-20		-20		
I _I	V _{CC} = MAX, V _I = 7 V			0.1		0.1	mA	
I _{IH}	V _{CC} = MAX, V _I = 2.7 V			20		20	μA	
I _{IL}	A Inputs	V _{CC} = MAX, V _I = 0.5 V, Either \bar{G} input at 2 V			-20		-20	μA
		V _{CC} = MAX, V _I = 0.4 V, Both \bar{G} inputs at 0.4 V			-0.4		-0.4	
	\bar{G} Inputs	V _{CC} = MAX, V _I = 0.4 V			-0.2		-0.2	mA
I _{OS} §	V _{CC} = MAX	-40		-225	-40		-225	mA
I _{CC}	V _{CC} = MAX, Data inputs = 0 V, Output controls = 4.5 V,		14	24		14	24	mA

† For conditions shown as MIN or MAX, use the appropriate value specified under recommended operating conditions.

‡ All typical values are at V_{CC} = 5 V, T_A = 25°C.

§ Not more than one output should be shorted at a time, and the duration of the short circuit should not exceed one second.

2

TTL Devices

SN54LS365A, SN54LS367A
SN74LS365A, SN74LS367A
HEX BUS DRIVERS WITH 3-STATE OUTPUTS

switching characteristics, $V_{CC} = 5\text{ V}$, $T_A = 25^\circ\text{C}$ (see note 2)

PARAMETER	FROM (INPUT)	TO (OUTPUT)	TEST CONDITIONS	MIN	TYP	MAX	UNIT	
t_{PLH}	Any	Y	$R_L = 667\ \Omega$, $C_L = 45\ \text{pF}$		10	16	ns	
t_{PHL}					9	22	ns	
t_{PZH}					19	35	ns	
t_{PZL}					24	40	ns	
t_{PHZ}			$R_L = 667\ \Omega$, $C_L = 5\ \text{pF}$				30	ns
t_{PLZ}							35	ns

NOTE 2: Load circuits and voltage waveforms are shown in Section 1.

**SN54LS366A, SN54LS368A
SN74LS366A, SN74LS368A
HEX BUS DRIVERS WITH 3-STATE OUTPUTS**

recommended operating conditions

	SN54LS366A SN54LS368A			SN74LS366A SN74LS368A			UNIT
	MIN	NOM	MAX	MIN	NOM	MAX	
V _{CC} Supply voltage	4.5	5	5.5	4.75	5	5.25	V
V _{IH} High-level input voltage	2			2			V
V _{IL} Low-level input voltage			0.7			0.8	V
I _{OH} High-level output current			-1			-2.6	mA
I _{OL} Low-level output current			12			24	mA
T _A Operating free-air temperature	-55		125	0		70	°C

electrical characteristics over recommended operating free-air temperature range (unless otherwise noted)

2

TTL Devices

PARAMETER	TEST CONDITIONS†	SN54LS366A SN54LS368A			SN74LS366A SN74LS368A			UNIT
		MIN	TYP‡	MAX	MIN	TYP‡	MAX	
V _{IK}	V _{CC} = MIN, I _I = -18 mA			-1.5			-1.5	V
V _{OH}	V _{CC} = MIN, V _{IH} = 2 V, V _{IL} = MAX, I _{OH} = MAX	2.4	3.3		2.4	3.1		V
V _{OL}	V _{CC} = MIN, V _{IH} = 2 V, V _{IL} = MAX, I _{OL} = 12 mA		0.25	0.4		0.25	0.4	V
	V _{CC} = MIN, V _{IH} = 2 V, V _{IL} = 0.8 V, I _{OL} = 24 mA					0.35	0.5	
I _{OZ}	V _{CC} = MAX, V _{IH} = 2 V, V _{IL} = MAX, V _O = 2.4 V			20			20	μA
	V _{CC} = MAX, V _{IH} = 2 V, V _{IL} = MAX, V _O = 0.4 V			-20			-20	
I _I	V _{CC} = MAX, V _I = 7 V			0.1			0.1	mA
I _{IH}	V _{CC} = MAX, V _I = 2.7 V			20			20	μA
I _{IL}	A Inputs	V _{CC} = MAX, V _I = 0.5 V, Either \bar{G} input at 2 V			-20		-20	μA
		V _{CC} = MAX, V _I = 0.4 V, Both \bar{G} inputs at 0.4 V			-0.4		-0.4	
	\bar{G} Inputs	V _{CC} = MAX, V _I = 0.4 V			-0.2		-0.2	mA
I _{OS} §	V _{CC} = MAX	-40		-225	-40		-225	mA
I _{CC}	V _{CC} = MAX, Data inputs = 0 V, Output controls = 4.5 V,		12	21		12	21	mA

† For conditions shown as MIN or MAX, use the appropriate value specified under recommended operating conditions.

‡ All typical values are at V_{CC} = 5 V, T_A = 25°C.

§ Not more than one output should be shorted at a time, and the duration of the short circuit should not exceed one second.

SN54LS366A, SN54LS368A
SN74LS366A, SN74LS368A
HEX BUS DRIVERS WITH 3-STATE OUTPUTS

switching characteristics, $V_{CC} = 5\text{ V}$, $T_A = 25^\circ\text{ C}$ (see note 2)

PARAMETER	FROM (INPUT)	TO (OUTPUT)	TEST CONDITIONS	MIN	TYP	MAX	UNIT
t_{PLH}	Any	Y	$R_L = 667\ \Omega$, $C_L = 45\ \text{pF}$	7		15	ns
t_{PHL}				12		18	ns
t_{PZH}				18		35	ns
t_{PZL}				28		45	ns
t_{PHZ}			$R_L = 667\ \Omega$, $C_L = 5\ \text{pF}$			32	ns
t_{PLZ}						35	ns

NOTE 2: Load circuits and voltage waveforms are shown in Section 1.

PACKAGING INFORMATION

Orderable Device	Status (1)	Package Type	Package Drawing	Pins	Package Qty	Eco Plan (2)	Lead finish/ Ball material (6)	MSL Peak Temp (3)	Op Temp (°C)	Device Marking (4/5)	Samples
JM38510/32201B2A	ACTIVE	LCCC	FK	20	55	Non-RoHS & Green	SNPB	N / A for Pkg Type	-55 to 125	JM38510/ 32201B2A	Samples
JM38510/32201BEA	ACTIVE	CDIP	J	16	25	Non-RoHS & Green	SNPB	N / A for Pkg Type	-55 to 125	JM38510/ 32201BEA	Samples
JM38510/32201BEA	ACTIVE	CDIP	J	16	25	Non-RoHS & Green	SNPB	N / A for Pkg Type	-55 to 125	JM38510/ 32201BEA	Samples
JM38510/32203B2A	ACTIVE	LCCC	FK	20	55	Non-RoHS & Green	SNPB	N / A for Pkg Type	-55 to 125	JM38510/ 32203B2A	Samples
JM38510/32203B2A	ACTIVE	LCCC	FK	20	55	Non-RoHS & Green	SNPB	N / A for Pkg Type	-55 to 125	JM38510/ 32203B2A	Samples
JM38510/32203BEA	ACTIVE	CDIP	J	16	25	Non-RoHS & Green	SNPB	N / A for Pkg Type	-55 to 125	JM38510/ 32203BEA	Samples
JM38510/32203BEA	ACTIVE	CDIP	J	16	25	Non-RoHS & Green	SNPB	N / A for Pkg Type	-55 to 125	JM38510/ 32203BEA	Samples
JM38510/32203BFA	ACTIVE	CFP	W	16	25	Non-RoHS & Green	SNPB	N / A for Pkg Type	-55 to 125	JM38510/ 32203BFA	Samples
JM38510/32203BFA	ACTIVE	CFP	W	16	25	Non-RoHS & Green	SNPB	N / A for Pkg Type	-55 to 125	JM38510/ 32203BFA	Samples
M38510/32201B2A	ACTIVE	LCCC	FK	20	55	Non-RoHS & Green	SNPB	N / A for Pkg Type	-55 to 125	JM38510/ 32201B2A	Samples
M38510/32201B2A	ACTIVE	LCCC	FK	20	55	Non-RoHS & Green	SNPB	N / A for Pkg Type	-55 to 125	JM38510/ 32201B2A	Samples
M38510/32201BEA	ACTIVE	CDIP	J	16	25	Non-RoHS & Green	SNPB	N / A for Pkg Type	-55 to 125	JM38510/ 32201BEA	Samples
M38510/32201BEA	ACTIVE	CDIP	J	16	25	Non-RoHS & Green	SNPB	N / A for Pkg Type	-55 to 125	JM38510/ 32201BEA	Samples
M38510/32203B2A	ACTIVE	LCCC	FK	20	55	Non-RoHS & Green	SNPB	N / A for Pkg Type	-55 to 125	JM38510/ 32203B2A	Samples
M38510/32203B2A	ACTIVE	LCCC	FK	20	55	Non-RoHS & Green	SNPB	N / A for Pkg Type	-55 to 125	JM38510/ 32203B2A	Samples
M38510/32203BEA	ACTIVE	CDIP	J	16	25	Non-RoHS & Green	SNPB	N / A for Pkg Type	-55 to 125	JM38510/ 32203BEA	Samples

Orderable Device	Status (1)	Package Type	Package Drawing	Pins	Package Qty	Eco Plan (2)	Lead finish/ Ball material (6)	MSL Peak Temp (3)	Op Temp (°C)	Device Marking (4/5)	Samples
M38510/32203BEA	ACTIVE	CDIP	J	16	25	Non-RoHS & Green	SNPB	N / A for Pkg Type	-55 to 125	JM38510/ 32203BEA	Samples
M38510/32203BFA	ACTIVE	CFP	W	16	25	Non-RoHS & Green	SNPB	N / A for Pkg Type	-55 to 125	JM38510/ 32203BFA	Samples
M38510/32203BFA	ACTIVE	CFP	W	16	25	Non-RoHS & Green	SNPB	N / A for Pkg Type	-55 to 125	JM38510/ 32203BFA	Samples
SN54LS365AJ	ACTIVE	CDIP	J	16	25	Non-RoHS & Green	SNPB	N / A for Pkg Type	-55 to 125	SN54LS365AJ	Samples
SN54LS365AJ	ACTIVE	CDIP	J	16	25	Non-RoHS & Green	SNPB	N / A for Pkg Type	-55 to 125	SN54LS365AJ	Samples
SN54LS366AJ	ACTIVE	CDIP	J	16	25	Non-RoHS & Green	SNPB	N / A for Pkg Type	-55 to 125	SN54LS366AJ	Samples
SN54LS366AJ	ACTIVE	CDIP	J	16	25	Non-RoHS & Green	SNPB	N / A for Pkg Type	-55 to 125	SN54LS366AJ	Samples
SN54LS367AJ	ACTIVE	CDIP	J	16	25	Non-RoHS & Green	SNPB	N / A for Pkg Type	-55 to 125	SN54LS367AJ	Samples
SN54LS367AJ	ACTIVE	CDIP	J	16	25	Non-RoHS & Green	SNPB	N / A for Pkg Type	-55 to 125	SN54LS367AJ	Samples
SN54LS368AJ	ACTIVE	CDIP	J	16	25	Non-RoHS & Green	SNPB	N / A for Pkg Type	-55 to 125	SN54LS368AJ	Samples
SN54LS368AJ	ACTIVE	CDIP	J	16	25	Non-RoHS & Green	SNPB	N / A for Pkg Type	-55 to 125	SN54LS368AJ	Samples
SN74LS365AD	OBSOLETE	SOIC	D	16		TBD	Call TI	Call TI	0 to 70	LS365A	
SN74LS365AD	OBSOLETE	SOIC	D	16		TBD	Call TI	Call TI	0 to 70	LS365A	
SN74LS365ADR	ACTIVE	SOIC	D	16	2500	RoHS & Green	NIPDAU	Level-1-260C-UNLIM	0 to 70	LS365A	Samples
SN74LS365ADR	ACTIVE	SOIC	D	16	2500	RoHS & Green	NIPDAU	Level-1-260C-UNLIM	0 to 70	LS365A	Samples
SN74LS365AN	ACTIVE	PDIP	N	16	25	RoHS & Green	NIPDAU	N / A for Pkg Type	0 to 70	SN74LS365AN	Samples
SN74LS365AN	ACTIVE	PDIP	N	16	25	RoHS & Green	NIPDAU	N / A for Pkg Type	0 to 70	SN74LS365AN	Samples
SN74LS365ANSR	ACTIVE	SOP	NS	16	2000	RoHS & Green	NIPDAU	Level-1-260C-UNLIM	0 to 70	74LS365A	Samples
SN74LS365ANSR	ACTIVE	SOP	NS	16	2000	RoHS & Green	NIPDAU	Level-1-260C-UNLIM	0 to 70	74LS365A	Samples
SN74LS367AD	OBSOLETE	SOIC	D	16		TBD	Call TI	Call TI	0 to 70	LS367A	

Orderable Device	Status (1)	Package Type	Package Drawing	Pins	Package Qty	Eco Plan (2)	Lead finish/ Ball material (6)	MSL Peak Temp (3)	Op Temp (°C)	Device Marking (4/5)	Samples
SN74LS367AD	OBSOLETE	SOIC	D	16		TBD	Call TI	Call TI	0 to 70	LS367A	
SN74LS367ADR	ACTIVE	SOIC	D	16	2500	RoHS & Green	NIPDAU	Level-1-260C-UNLIM	0 to 70	LS367A	Samples
SN74LS367ADR	ACTIVE	SOIC	D	16	2500	RoHS & Green	NIPDAU	Level-1-260C-UNLIM	0 to 70	LS367A	Samples
SN74LS367AN	ACTIVE	PDIP	N	16	25	RoHS & Green	NIPDAU	N / A for Pkg Type	0 to 70	SN74LS367AN	Samples
SN74LS367AN	ACTIVE	PDIP	N	16	25	RoHS & Green	NIPDAU	N / A for Pkg Type	0 to 70	SN74LS367AN	Samples
SN74LS367ANE4	ACTIVE	PDIP	N	16	25	RoHS & Green	NIPDAU	N / A for Pkg Type	0 to 70	SN74LS367AN	Samples
SN74LS367ANE4	ACTIVE	PDIP	N	16	25	RoHS & Green	NIPDAU	N / A for Pkg Type	0 to 70	SN74LS367AN	Samples
SN74LS367ANSR	ACTIVE	SOP	NS	16	2000	RoHS & Green	NIPDAU	Level-1-260C-UNLIM	0 to 70	74LS367A	Samples
SN74LS367ANSR	ACTIVE	SOP	NS	16	2000	RoHS & Green	NIPDAU	Level-1-260C-UNLIM	0 to 70	74LS367A	Samples
SN74LS368AD	ACTIVE	SOIC	D	16	40	RoHS & Green	NIPDAU	Level-1-260C-UNLIM	0 to 70	LS368A	Samples
SN74LS368AD	ACTIVE	SOIC	D	16	40	RoHS & Green	NIPDAU	Level-1-260C-UNLIM	0 to 70	LS368A	Samples
SN74LS368AN	ACTIVE	PDIP	N	16	25	RoHS & Green	NIPDAU	N / A for Pkg Type	0 to 70	SN74LS368AN	Samples
SN74LS368AN	ACTIVE	PDIP	N	16	25	RoHS & Green	NIPDAU	N / A for Pkg Type	0 to 70	SN74LS368AN	Samples
SN74LS368ANSR	ACTIVE	SOP	NS	16	2000	RoHS & Green	NIPDAU	Level-1-260C-UNLIM	0 to 70	74LS368A	Samples
SN74LS368ANSR	ACTIVE	SOP	NS	16	2000	RoHS & Green	NIPDAU	Level-1-260C-UNLIM	0 to 70	74LS368A	Samples
SNJ54LS365AFK	ACTIVE	LCCC	FK	20	55	Non-RoHS & Green	SNPB	N / A for Pkg Type	-55 to 125	SNJ54LS 365AFK	Samples
SNJ54LS365AFK	ACTIVE	LCCC	FK	20	55	Non-RoHS & Green	SNPB	N / A for Pkg Type	-55 to 125	SNJ54LS 365AFK	Samples
SNJ54LS365AJ	ACTIVE	CDIP	J	16	25	Non-RoHS & Green	SNPB	N / A for Pkg Type	-55 to 125	SNJ54LS365AJ	Samples
SNJ54LS365AJ	ACTIVE	CDIP	J	16	25	Non-RoHS & Green	SNPB	N / A for Pkg Type	-55 to 125	SNJ54LS365AJ	Samples
SNJ54LS366AFK	ACTIVE	LCCC	FK	20	55	Non-RoHS & Green	SNPB	N / A for Pkg Type	-55 to 125	SNJ54LS 366AFK	Samples

Orderable Device	Status (1)	Package Type	Package Drawing	Pins	Package Qty	Eco Plan (2)	Lead finish/ Ball material (6)	MSL Peak Temp (3)	Op Temp (°C)	Device Marking (4/5)	Samples
SNJ54LS366AFK	ACTIVE	LCCC	FK	20	55	Non-RoHS & Green	SNPB	N / A for Pkg Type	-55 to 125	SNJ54LS366AFK	Samples
SNJ54LS366AJ	ACTIVE	CDIP	J	16	25	Non-RoHS & Green	SNPB	N / A for Pkg Type	-55 to 125	SNJ54LS366AJ	Samples
SNJ54LS366AJ	ACTIVE	CDIP	J	16	25	Non-RoHS & Green	SNPB	N / A for Pkg Type	-55 to 125	SNJ54LS366AJ	Samples
SNJ54LS367AJ	ACTIVE	CDIP	J	16	25	Non-RoHS & Green	SNPB	N / A for Pkg Type	-55 to 125	SNJ54LS367AJ	Samples
SNJ54LS367AJ	ACTIVE	CDIP	J	16	25	Non-RoHS & Green	SNPB	N / A for Pkg Type	-55 to 125	SNJ54LS367AJ	Samples
SNJ54LS368AJ	ACTIVE	CDIP	J	16	25	Non-RoHS & Green	SNPB	N / A for Pkg Type	-55 to 125	SNJ54LS368AJ	Samples
SNJ54LS368AJ	ACTIVE	CDIP	J	16	25	Non-RoHS & Green	SNPB	N / A for Pkg Type	-55 to 125	SNJ54LS368AJ	Samples
SNJ54LS368AW	ACTIVE	CFP	W	16	25	Non-RoHS & Green	SNPB	N / A for Pkg Type	-55 to 125	SNJ54LS368AW	Samples
SNJ54LS368AW	ACTIVE	CFP	W	16	25	Non-RoHS & Green	SNPB	N / A for Pkg Type	-55 to 125	SNJ54LS368AW	Samples

(1) The marketing status values are defined as follows:

ACTIVE: Product device recommended for new designs.

LIFEBUY: TI has announced that the device will be discontinued, and a lifetime-buy period is in effect.

NRND: Not recommended for new designs. Device is in production to support existing customers, but TI does not recommend using this part in a new design.

PREVIEW: Device has been announced but is not in production. Samples may or may not be available.

OBSELETE: TI has discontinued the production of the device.

(2) **RoHS:** TI defines "RoHS" to mean semiconductor products that are compliant with the current EU RoHS requirements for all 10 RoHS substances, including the requirement that RoHS substance do not exceed 0.1% by weight in homogeneous materials. Where designed to be soldered at high temperatures, "RoHS" products are suitable for use in specified lead-free processes. TI may reference these types of products as "Pb-Free".

RoHS Exempt: TI defines "RoHS Exempt" to mean products that contain lead but are compliant with EU RoHS pursuant to a specific EU RoHS exemption.

Green: TI defines "Green" to mean the content of Chlorine (Cl) and Bromine (Br) based flame retardants meet JS709B low halogen requirements of <=1000ppm threshold. Antimony trioxide based flame retardants must also meet the <=1000ppm threshold requirement.

(3) MSL, Peak Temp. - The Moisture Sensitivity Level rating according to the JEDEC industry standard classifications, and peak solder temperature.

(4) There may be additional marking, which relates to the logo, the lot trace code information, or the environmental category on the device.

⁽⁵⁾ Multiple Device Markings will be inside parentheses. Only one Device Marking contained in parentheses and separated by a "~" will appear on a device. If a line is indented then it is a continuation of the previous line and the two combined represent the entire Device Marking for that device.

⁽⁶⁾ Lead finish/Ball material - Orderable Devices may have multiple material finish options. Finish options are separated by a vertical ruled line. Lead finish/Ball material values may wrap to two lines if the finish value exceeds the maximum column width.

Important Information and Disclaimer:The information provided on this page represents TI's knowledge and belief as of the date that it is provided. TI bases its knowledge and belief on information provided by third parties, and makes no representation or warranty as to the accuracy of such information. Efforts are underway to better integrate information from third parties. TI has taken and continues to take reasonable steps to provide representative and accurate information but may not have conducted destructive testing or chemical analysis on incoming materials and chemicals. TI and TI suppliers consider certain information to be proprietary, and thus CAS numbers and other limited information may not be available for release.

In no event shall TI's liability arising out of such information exceed the total purchase price of the TI part(s) at issue in this document sold by TI to Customer on an annual basis.

OTHER QUALIFIED VERSIONS OF SN54LS365A, SN54LS367A, SN54LS368A, SN74LS365A, SN74LS367A, SN74LS368A :

- Catalog : [SN74LS365A](#), [SN74LS367A](#), [SN74LS368A](#)
- Military : [SN54LS365A](#), [SN54LS367A](#), [SN54LS368A](#)

NOTE: Qualified Version Definitions:

- Catalog - TI's standard catalog product
- Military - QML certified for Military and Defense Applications

TAPE AND REEL INFORMATION

QUADRANT ASSIGNMENTS FOR PIN 1 ORIENTATION IN TAPE



*All dimensions are nominal

Device	Package Type	Package Drawing	Pins	SPQ	Reel Diameter (mm)	Reel Width W1 (mm)	A0 (mm)	B0 (mm)	K0 (mm)	P1 (mm)	W (mm)	Pin1 Quadrant
SN74LS365ADR	SOIC	D	16	2500	330.0	16.4	6.5	10.3	2.1	8.0	16.0	Q1
SN74LS365ANSR	SOP	NS	16	2000	330.0	16.4	8.2	10.5	2.5	12.0	16.0	Q1
SN74LS367ADR	SOIC	D	16	2500	330.0	16.4	6.5	10.3	2.1	8.0	16.0	Q1
SN74LS367ANSR	SOP	NS	16	2000	330.0	16.4	8.2	10.5	2.5	12.0	16.0	Q1
SN74LS368ANSR	SOP	NS	16	2000	330.0	16.4	8.2	10.5	2.5	12.0	16.0	Q1

TAPE AND REEL BOX DIMENSIONS

*All dimensions are nominal

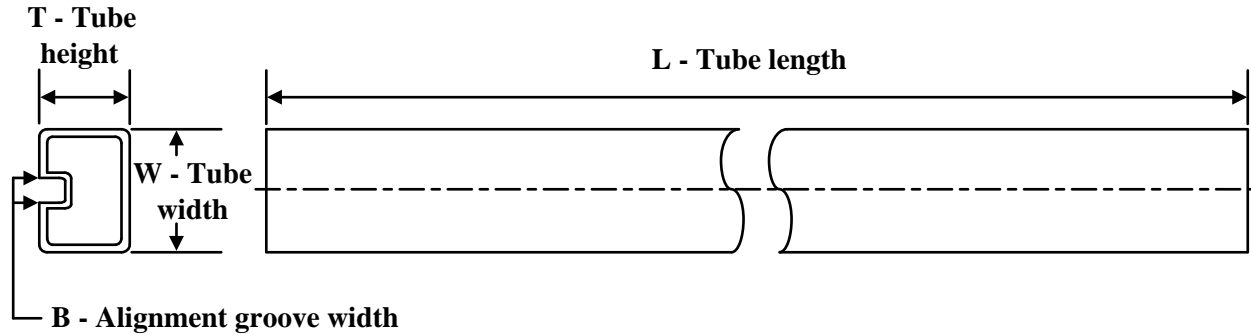
Device	Package Type	Package Drawing	Pins	SPQ	Length (mm)	Width (mm)	Height (mm)
SN74LS365ADR	SOIC	D	16	2500	353.0	353.0	32.0
SN74LS365ANSR	SOP	NS	16	2000	356.0	356.0	35.0
SN74LS367ADR	SOIC	D	16	2500	340.5	336.1	32.0
SN74LS367ANSR	SOP	NS	16	2000	356.0	356.0	35.0
SN74LS368ANSR	SOP	NS	16	2000	356.0	356.0	35.0

TUBE

*All dimensions are nominal

Device	Package Name	Package Type	Pins	SPQ	L (mm)	W (mm)	T (μm)	B (mm)
JM38510/32201B2A	FK	LCCC	20	55	506.98	12.06	2030	NA
JM38510/32203B2A	FK	LCCC	20	55	506.98	12.06	2030	NA
JM38510/32203BFBA	W	CFP	16	25	506.98	26.16	6220	NA
M38510/32201B2A	FK	LCCC	20	55	506.98	12.06	2030	NA
M38510/32203B2A	FK	LCCC	20	55	506.98	12.06	2030	NA
M38510/32203BFBA	W	CFP	16	25	506.98	26.16	6220	NA
SN74LS365AN	N	PDIP	16	25	506	13.97	11230	4.32
SN74LS365AN	N	PDIP	16	25	506	13.97	11230	4.32
SN74LS367AN	N	PDIP	16	25	506	13.97	11230	4.32
SN74LS367AN	N	PDIP	16	25	506	13.97	11230	4.32
SN74LS367ANE4	N	PDIP	16	25	506	13.97	11230	4.32
SN74LS367ANE4	N	PDIP	16	25	506	13.97	11230	4.32
SN74LS368AD	D	SOIC	16	40	507	8	3940	4.32
SN74LS368AN	N	PDIP	16	25	506	13.97	11230	4.32
SN74LS368AN	N	PDIP	16	25	506	13.97	11230	4.32
SNJ54LS365AFK	FK	LCCC	20	55	506.98	12.06	2030	NA
SNJ54LS366AFK	FK	LCCC	20	55	506.98	12.06	2030	NA
SNJ54LS368AW	W	CFP	16	25	506.98	26.16	6220	NA

W (R-GDFP-F16)

CERAMIC DUAL FLATPACK

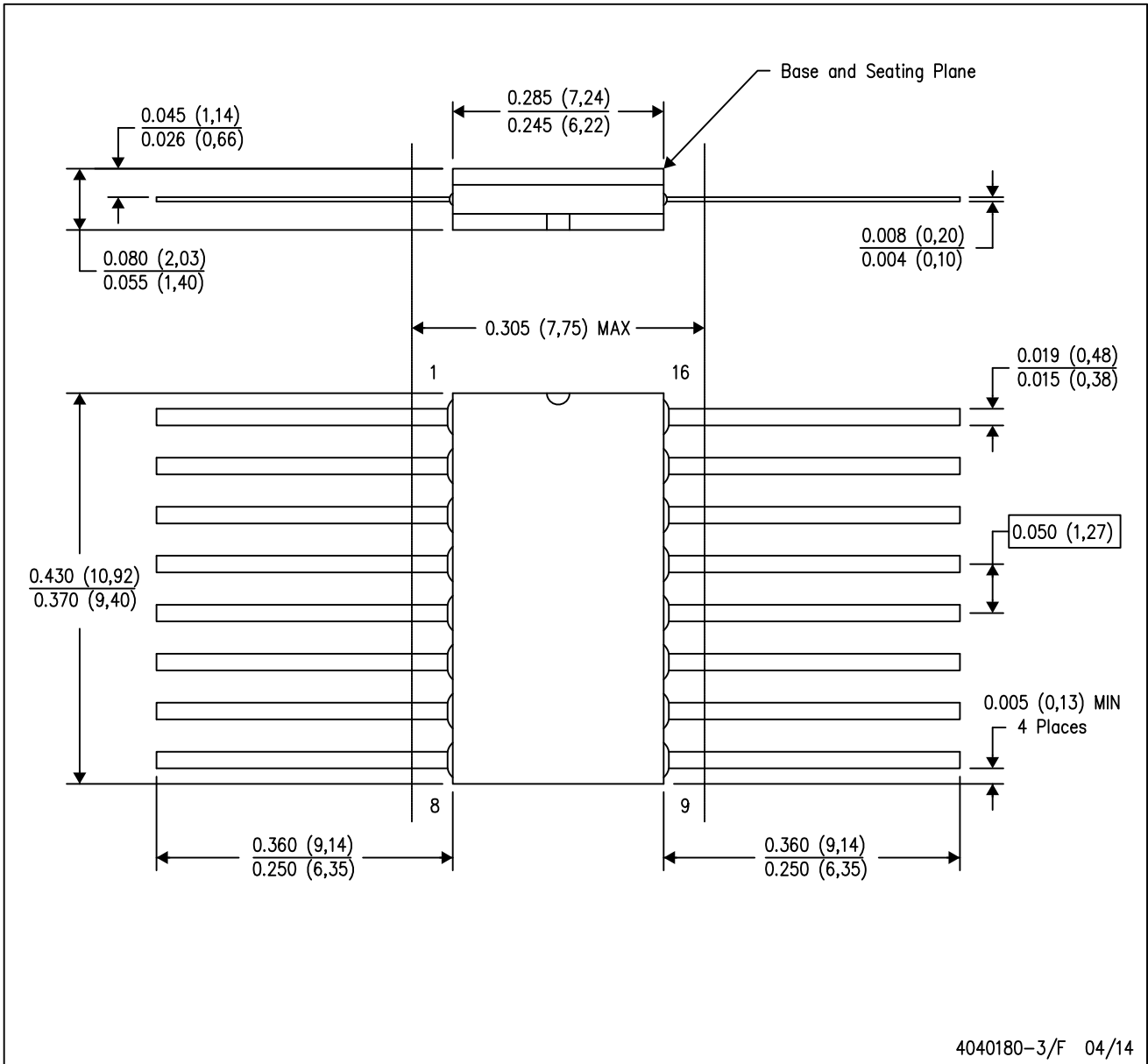

- NOTES:
- A. All linear dimensions are in inches (millimeters).
 - B. This drawing is subject to change without notice.
 - C. This package can be hermetically sealed with a ceramic lid using glass frit.
 - D. Index point is provided on cap for terminal identification only.
 - E. Falls within MIL STD 1835 GDFP2-F16

GENERIC PACKAGE VIEW

FK 20

LCCC - 2.03 mm max height

8.89 x 8.89, 1.27 mm pitch

LEADLESS CERAMIC CHIP CARRIER

This image is a representation of the package family, actual package may vary.
Refer to the product data sheet for package details.

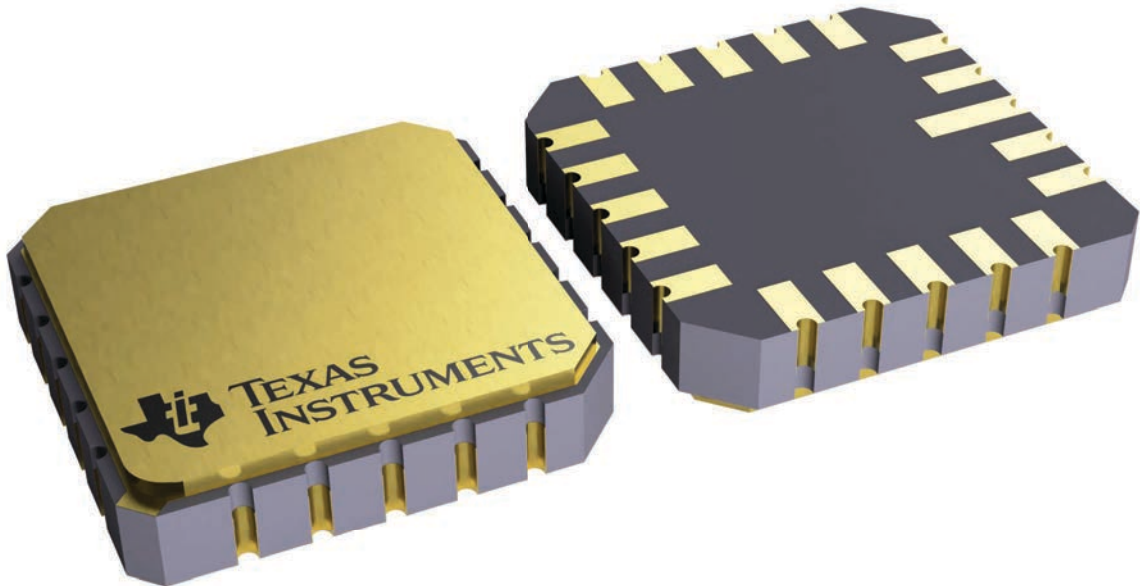

4229370VA\

J (R-GDIP-T**)

14 LEADS SHOWN

CERAMIC DUAL IN-LINE PACKAGE



DIM \ PINS **	14	16	18	20
A	0.300 (7,62) BSC	0.300 (7,62) BSC	0.300 (7,62) BSC	0.300 (7,62) BSC
B MAX	0.785 (19,94)	.840 (21,34)	0.960 (24,38)	1.060 (26,92)
B MIN	—	—	—	—
C MAX	0.300 (7,62)	0.300 (7,62)	0.310 (7,87)	0.300 (7,62)
C MIN	0.245 (6,22)	0.245 (6,22)	0.220 (5,59)	0.245 (6,22)



4040083/F 03/03

- NOTES:
- All linear dimensions are in inches (millimeters).
 - This drawing is subject to change without notice.
 - This package is hermetically sealed with a ceramic lid using glass frit.
 - Index point is provided on cap for terminal identification only on press ceramic glass frit seal only.
 - Falls within MIL STD 1835 GDIP1-T14, GDIP1-T16, GDIP1-T18 and GDIP1-T20.

N (R-PDIP-T**)

PLASTIC DUAL-IN-LINE PACKAGE

16 PINS SHOWN



- NOTES:
- A. All linear dimensions are in inches (millimeters).
 - B. This drawing is subject to change without notice.
 - Falls within JEDEC MS-001, except 18 and 20 pin minimum body length (Dim A).
 - The 20 pin end lead shoulder width is a vendor option, either half or full width.



PACKAGE OUTLINE

NS0016A

SOP - 2.00 mm max height

SOP



4220735/A 12/2021

NOTES:

1. All linear dimensions are in millimeters. Dimensions in parenthesis are for reference only. Dimensioning and tolerancing per ASME Y14.5M.
2. This drawing is subject to change without notice.
3. This dimension does not include mold flash, protrusions, or gate burrs. Mold flash, protrusions, or gate burrs shall not exceed 0.15 mm, per side.
4. This dimension does not include interlead flash. Interlead flash shall not exceed 0.25 mm, per side.

EXAMPLE BOARD LAYOUT

NS0016A

SOP - 2.00 mm max height

SOP



SOLDER MASK DETAILS

4220735/A 12/2021

NOTES: (continued)

5. Publication IPC-7351 may have alternate designs.

6. Solder mask tolerances between and around signal pads can vary based on board fabrication site.

EXAMPLE STENCIL DESIGN

NS0016A

SOP - 2.00 mm max height

SOP



SOLDER PASTE EXAMPLE
BASED ON 0.125 mm THICK STENCIL
SCALE:7X

4220735/A 12/2021

NOTES: (continued)

7. Laser cutting apertures with trapezoidal walls and rounded corners may offer better paste release. IPC-7525 may have alternate design recommendations.
8. Board assembly site may have different recommendations for stencil design.

D (R-PDSO-G16)

PLASTIC SMALL OUTLINE



- NOTES:
- A. All linear dimensions are in inches (millimeters).
 - B. This drawing is subject to change without notice.
 - C. Body length does not include mold flash, protrusions, or gate burrs. Mold flash, protrusions, or gate burrs shall not exceed 0.006 (0,15) each side.
 - D. Body width does not include interlead flash. Interlead flash shall not exceed 0.017 (0,43) each side.
 - E. Reference JEDEC MS-012 variation AC.

MECHANICAL DATA

NS (R-PDSO-G**)

PLASTIC SMALL-OUTLINE PACKAGE

14-PINS SHOWN



- NOTES:
- A. All linear dimensions are in millimeters.
 - B. This drawing is subject to change without notice.
 - C. Body dimensions do not include mold flash or protrusion, not to exceed 0,15.

IMPORTANT NOTICE AND DISCLAIMER

TI PROVIDES TECHNICAL AND RELIABILITY DATA (INCLUDING DATA SHEETS), DESIGN RESOURCES (INCLUDING REFERENCE DESIGNS), APPLICATION OR OTHER DESIGN ADVICE, WEB TOOLS, SAFETY INFORMATION, AND OTHER RESOURCES "AS IS" AND WITH ALL FAULTS, AND DISCLAIMS ALL WARRANTIES, EXPRESS AND IMPLIED, INCLUDING WITHOUT LIMITATION ANY IMPLIED WARRANTIES OF MERCHANTABILITY, FITNESS FOR A PARTICULAR PURPOSE OR NON-INFRINGEMENT OF THIRD PARTY INTELLECTUAL PROPERTY RIGHTS.

These resources are intended for skilled developers designing with TI products. You are solely responsible for (1) selecting the appropriate TI products for your application, (2) designing, validating and testing your application, and (3) ensuring your application meets applicable standards, and any other safety, security, regulatory or other requirements.

These resources are subject to change without notice. TI grants you permission to use these resources only for development of an application that uses the TI products described in the resource. Other reproduction and display of these resources is prohibited. No license is granted to any other TI intellectual property right or to any third party intellectual property right. TI disclaims responsibility for, and you will fully indemnify TI and its representatives against, any claims, damages, costs, losses, and liabilities arising out of your use of these resources.

TI's products are provided subject to [TI's Terms of Sale](#) or other applicable terms available either on [ti.com](https://www.ti.com) or provided in conjunction with such TI products. TI's provision of these resources does not expand or otherwise alter TI's applicable warranties or warranty disclaimers for TI products.

TI objects to and rejects any additional or different terms you may have proposed.

Mailing Address: Texas Instruments, Post Office Box 655303, Dallas, Texas 75265

Copyright © 2025, Texas Instruments Incorporated