



## 具有 600mA 开关的 90% 高效同步升压转换器

 查询样品: [TPS61070](#), [TPS61071](#), [TPS61072](#), [TPS61073](#)

### 特性

- **90%** 高效同步升压转换器
  - 在 **3.3 V** 电压下可提供 **75 mA** 输出电流 (采用 **0.9 V** 输入时)
  - 在 **3.3 V** 电压下可提供 **150 mA** 输出电流 (采用 **1.8 V** 输入时)
- 器件静态电流: **19  $\mu$ A** (典型值)
- 输入电压范围: **0.9V 至 5.5V**
- 可调输出电压高达 **5.5 V**
- 可提供省电模式版本, 以改善低输出功率时的效率
- 停机期间负载断开
- 过温保护
- 小型 **6 引脚 Thin SOT23** 封装

### 应用

- 所有一节、两节和三节碱性、镍镉或镍氢电池供电型产品或单节锂电池供电型产品
- 便携式音频播放器
- **PDA**
- 蜂窝电话
- 个人医疗产品
- 白光 **LED** 照明

### 说明

TPS6107x 器件为那些采用单节、双节或三节碱性电池、镍镉电池或镍氢电池供电的产品或单节锂离子电池或锂聚合物电池供电的产品提供了一款电源解决方案。当采用单节碱性电池时, 输出电流可变至高达 **75 mA**, 并将电池放电到低至 **0.9 V**。它还可用于依靠一个 **3.3V** 电压轨或单节锂离子电池产生 **5V/200mA** 输出。升压转换器基于一个采用同步整流器的固定频率、脉宽调制 (PWM) 控制器, 旨在实现最高的效率。在低负载电流条件下, TPS61070 和 TPS61073 进入省电模式, 以在宽负载电流范围内保持高效率。在 TPS61071 和 TPS61072 中, 省电模式被停用, 因而强制转换器在某个固定的开关频率条件下操作。升压开关中的最大峰值电流通常被限制为 **600 mA**。

TPS6107x 的输出电压由一个外部电阻分压器来设置。可以停用转换器以最大限度地减少电池消耗。在停机期间, 将负载与电池完全断开。该器件采用 **6 引脚薄型 SOT23 封装 (DDC)**。

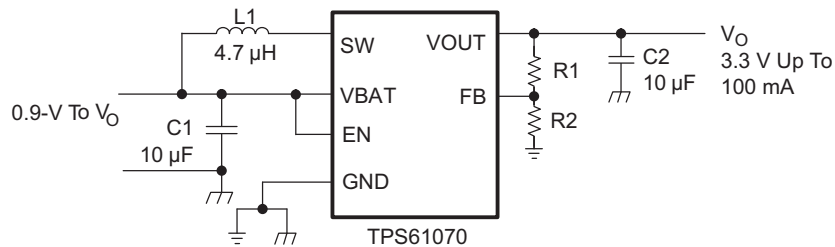

Please be aware that an important notice concerning availability, standard warranty, and use in critical applications of Texas Instruments semiconductor products and disclaimers thereto appears at the end of this data sheet.



This integrated circuit can be damaged by ESD. Texas Instruments recommends that all integrated circuits be handled with appropriate precautions. Failure to observe proper handling and installation procedures can cause damage.

ESD damage can range from subtle performance degradation to complete device failure. Precision integrated circuits may be more susceptible to damage because very small parametric changes could cause the device not to meet its published specifications.

### AVAILABLE OUTPUT VOLTAGE OPTIONS<sup>(1)</sup>

T <sub>A</sub>	OUTPUT VOLTAGE DC/DC	POWER-SAVE MODE	OPERATING FREQUENCY	EN THRESHOLD REFERENCE VOLTAGE	PACKAGE MARKING	PACKAGE	PART NUMBER <sup>(2)</sup>
- 40°C to 85°C	Adjustable	Enabled	1200 kHz	VBAT	AUH	6-Pin TSOT23	TPS61070DDC
	Adjustable	Disabled	1200 kHz	VBAT	AUJ		TPS61071DDC
	Adjustable	Disabled	600 kHz	VBAT	BUM		TPS61072DDC
	Adjustable	Enabled	1200 kHz	1.8 V Logic	BUN		TPS61073DDC

- (1) For the most current package and ordering information, see the Package Option Addendum at the end of this document, or see the TI website at [www.ti.com](http://www.ti.com).
- (2) The DDC package is available taped and reeled. Add R suffix to device type (e.g., TPS61070DDCR) to order quantities of 3000 devices per reel. Add T suffix to device type (e.g., TPS61070DDCT) to order quantities of 250 devices per reel.

### ABSOLUTE MAXIMUM RATINGS

over operating free-air temperature range (unless otherwise noted)<sup>(1)</sup>

	TPS6107x
Input voltage range on SW, VOUT, VBAT, EN, FB	-0.3 V to 7 V
Operating virtual junction temperature range, T <sub>J</sub>	-40°C to 150°C
Storage temperature range T <sub>stg</sub>	-65°C to 150°C

- (1) Stresses beyond those listed under *Absolute Maximum Ratings* may cause permanent damage to the device. These are stress ratings only, and functional operation of the device at these or any other conditions beyond those indicated under *Recommended Operating Conditions* is not implied. Exposure to absolute-maximum-rated conditions for extended periods may affect device reliability.

### DISSIPATION RATINGS TABLE<sup>(1)</sup>

PACKAGE	THERMAL RESISTANCE			POWER RATING T <sub>A</sub> ≤ 25°C	DERATING FACTOR ABOVE T <sub>A</sub> = 25°C
	Θ <sub>JA</sub>	Θ <sub>JB</sub>	Θ <sub>JC</sub>		
DDC	130 °C/W	27 °C/W	41 °C/W	769 mW	7.7 mW/°C

- (1) This thermal data is based on assembly of the device on a JEDEC high K board. Exceeding the maximum junction temperature will force the device into thermal shutdown.

### RECOMMENDED OPERATING CONDITIONS

	MIN	NOM	MAX	UNIT
Supply voltage at VBAT, V <sub>I</sub> (TPS61070, TPS61071, TPS61072)	0.9		5.5	V
Supply voltage at VBAT, V <sub>I</sub> (TPS61073)	2.3		5.5	V
Operating free air temperature range, T <sub>A</sub>	-40		85	°C
Operating virtual junction temperature range, T <sub>J</sub>	-40		125	°C

## ELECTRICAL CHARACTERISTICS

over recommended free-air temperature range and over recommended input voltage range (typical at an ambient temperature range of 25°C) (unless otherwise noted)

DC/DC STAGE							
PARAMETER		TEST CONDITIONS	MIN	TYP	MAX	UNIT	
V <sub>I</sub>	Minimum input voltage range for start-up (TPS61070, TPS61071, TPS61072)	R <sub>L</sub> = 270 Ω		1.1	1.2	V	
	Minimum input voltage range for start-up (TPS61073)	R <sub>L</sub> = 270 Ω			2.3		
	Input voltage range, after start-up (TPS61070, TPS61071, TPS61072)	T <sub>A</sub> = 25°C	0.9		5.5		
	Input voltage range, after start-up (TPS61073)		2.3		5.5		
V <sub>O</sub>	Output voltage range (TPS61070, TPS61071, TPS61072)		1.8		5.5	V	
	Output voltage range (TPS61073)		2.3		5.5		
V <sub>(FB)</sub>	Feedback voltage		495	500	505	mV	
f	Oscillator frequency (TPS61070, TPS61071, TPS61073)		960	1200	1440	kHz	
	Oscillator frequency (TPS61072)		480	600	720		
I <sub>(SW)</sub>	Switch current limit	V <sub>OUT</sub> = 3.3 V	500	600	700	mA	
	Start-up current limit			0.5 × I <sub>SW</sub>			
	Boost switch-on resistance	V <sub>OUT</sub> = 3.3 V		480			
	Rectifying switch-on resistance	V <sub>OUT</sub> = 3.3 V		600			
	Total accuracy (including line and load regulation)				3%		
	Line regulation				1%		
	Load regulation				1%		
	Quiescent current (TPS61070, TPS61071, TPS61072)	VBAT	I <sub>O</sub> = 0 mA, V <sub>(EN)</sub> = V <sub>BAT</sub> = 1.2 V, V <sub>OUT</sub> = 3.3 V, T <sub>A</sub> = 25°C		0.5	1	μA
		V <sub>OUT</sub>			19	30	μA
	Quiescent current (TPS61073)	VBAT	I <sub>O</sub> = 0 mA, V <sub>(EN)</sub> = 1.8 V, V <sub>BAT</sub> = 2.4 V, V <sub>OUT</sub> = 5 V, T <sub>A</sub> = 25°C		1	1.5	μA
		V <sub>OUT</sub>			30	50	μA
	Shutdown current (TPS61070, TPS61071, TPS61072)	V <sub>(EN)</sub> = 0 V, V <sub>BAT</sub> = 1.2 V, T <sub>A</sub> = 25°C		0.05	0.5	μA	
				V <sub>(EN)</sub> = 0 V, V <sub>BAT</sub> = 3.6 V, T <sub>A</sub> = 25°C		0.05	1.5

CONTROL STAGE						
PARAMETER		TEST CONDITIONS	MIN	TYP	MAX	UNIT
V <sub>(UVLO)</sub>	Undervoltage lockout threshold	V <sub>(BAT)</sub> voltage decreasing		0.8		V
V <sub>IL</sub>	EN input low voltage (TPS61070, TPS61071, TPS61072)			0.2 × V <sub>BAT</sub>		
	EN input low voltage (TPS61073)				0.4	V
V <sub>IH</sub>	EN input high voltage (TPS61070, TPS61071, TPS61072)		0.8 × V <sub>BAT</sub>			
	EN input high voltage (TPS61073)		1.2			V
	EN input current (TPS61070, TPS61071, TPS61072)	Clamped on GND or V <sub>BAT</sub>		0.01	0.1	μA
	EN input current (TPS61073)	Clamped on GND or V <sub>BAT</sub>		0.01	0.3	μA
	Overtemperature protection			140		°C
	Overtemperature hysteresis			20		°C

## PIN ASSIGNMENTS

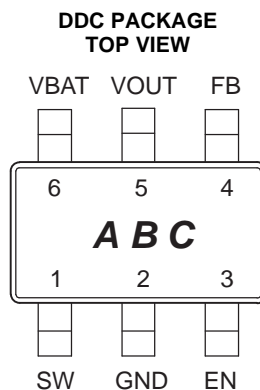

### Terminal Functions

TERMINAL NAME	TERMINAL NO.	I/O	DESCRIPTION
EN	3	I	Enable input (1/VBAT enabled, 0/GND disabled)
FB	4	I	Voltage feedback for programming the output voltage
GND	2		IC ground connection for logic and power
SW	1	I	Boost and rectifying switch input
VBAT	6	I	Supply voltage
VOUT	5	O	Boost converter output

FUNCTIONAL BLOCK DIAGRAM (TPS61070)

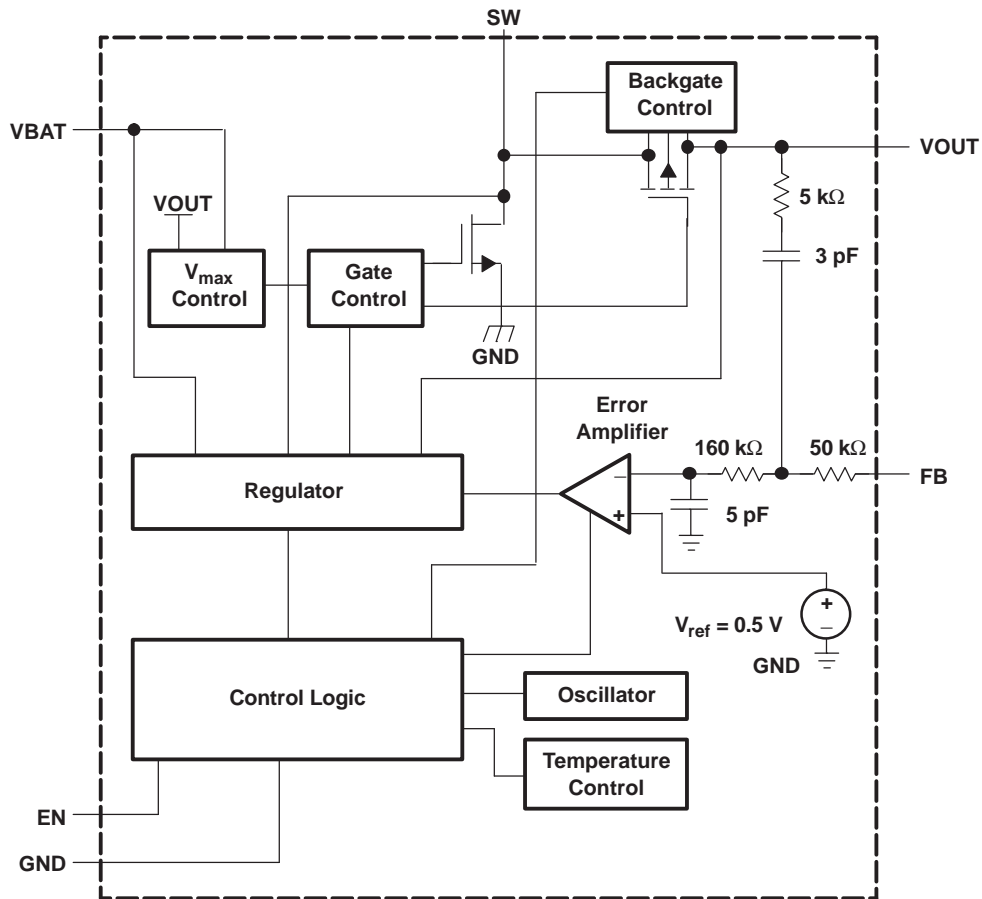

Parameter Measurement Information

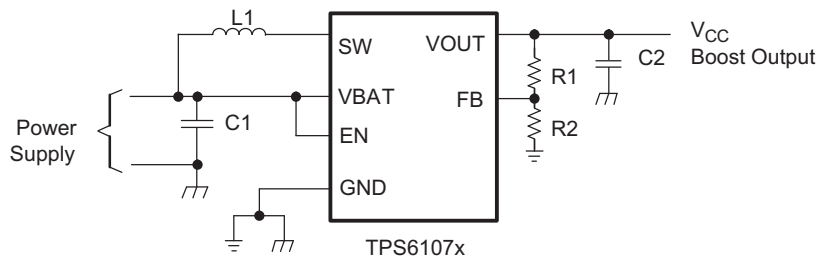

- List of Components:  
 U1 = TPS61070DDC  
 L1 = 4.7  $\mu$ H Wurth Elektronik 744031004  
 C1 = 2 x 4.7  $\mu$ F, 0603, X7R/X5R Ceramic  
 C2 = 4 x 4.7  $\mu$ F, 0603, X7R/X5R Ceramic

## TYPICAL CHARACTERISTICS

### Table of Graphs

		FIGURE
Maximum output current	vs Input voltage	1
Efficiency	vs Output current	2
	vs Output current	3
	vs Output current	4
	vs Input voltage	5
	vs Input voltage	6
	vs Input voltage	7
Output voltage	vs Output current	8
	vs Output current	9
No load supply current into VOUT	vs Input voltage	10
Waveforms	Output voltage in continuous mode (TPS61071)	11
	Output voltage in continuous mode (TPS61071)	12
	Output voltage in power-save mode (TPS61070)	13
	Output voltage in power-save mode (TPS61070)	14
	Load transient response (TPS61071)	15
	Load transient response (TPS61071)	16
	Line transient response (TPS61071)	17
	Line transient response (TPS61071)	18
	Start-up after enable (TPS61070)	19
	Start-up after enable (TPS61070)	20
	Start-up after enable (TPS61071)	21
	Start-up after enable (TPS61071)	22
	Start-up after enable (TPS61071)	23
	Start-up after enable (TPS61071)	24

## TYPICAL CHARACTERISTICS

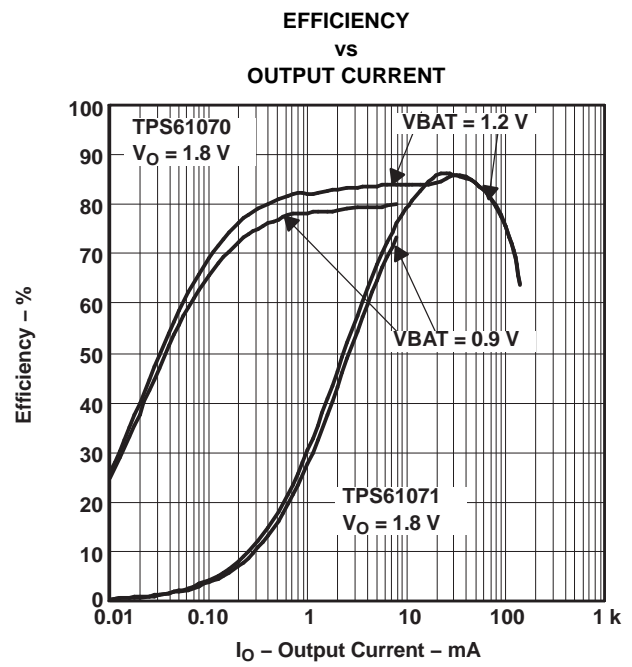
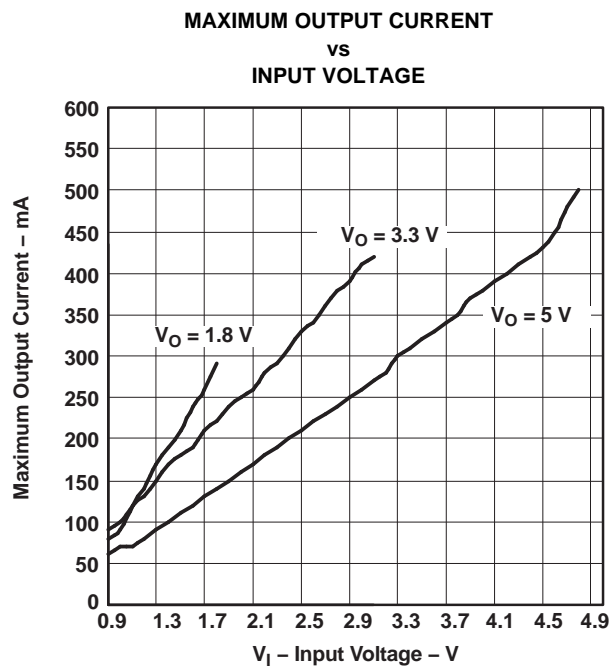

TYPICAL CHARACTERISTICS (continued)

EFFICIENCY  
vs  
OUTPUT CURRENT

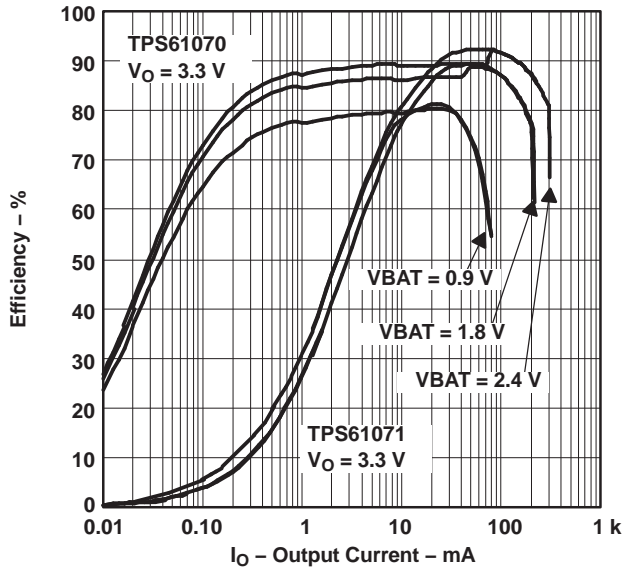

Figure 3.

EFFICIENCY  
vs  
OUTPUT CURRENT

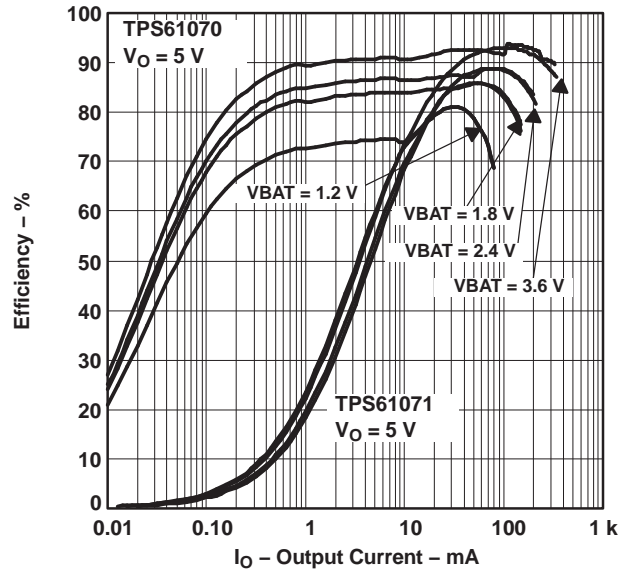

Figure 4.

EFFICIENCY  
vs  
INPUT VOLTAGE

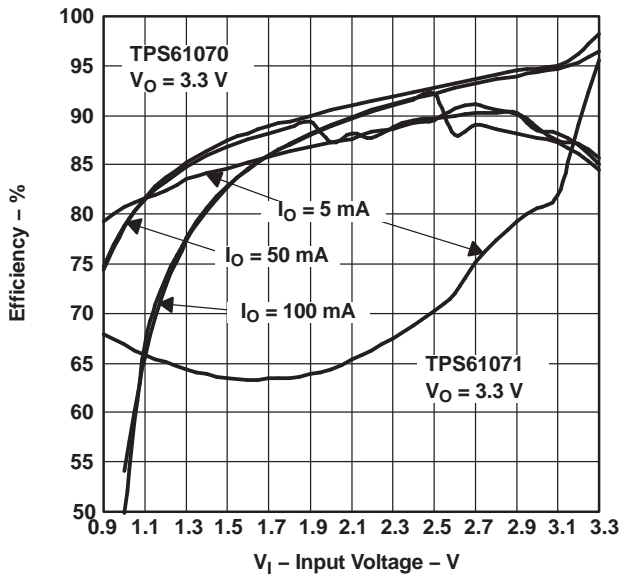

Figure 5.

EFFICIENCY  
vs  
INPUT VOLTAGE

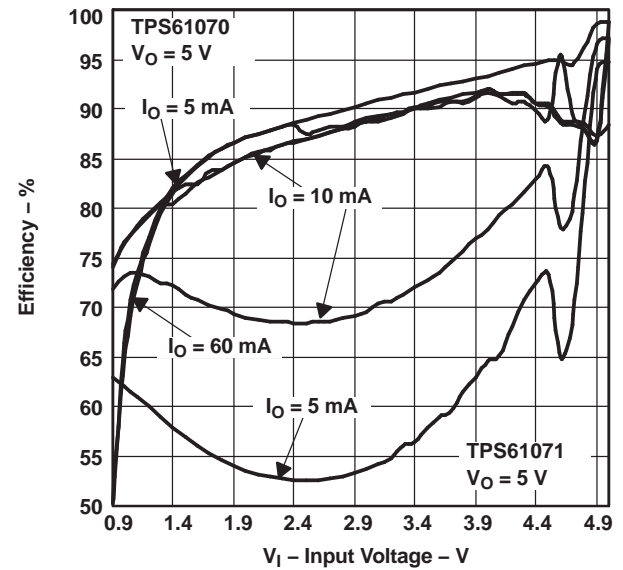

Figure 6.

**TYPICAL CHARACTERISTICS (continued)**

**OUTPUT VOLTAGE  
 vs  
 OUTPUT CURRENT**

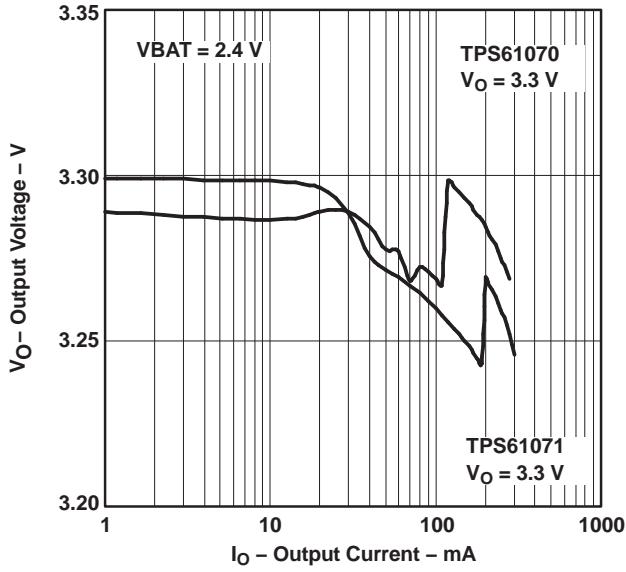

Figure 7.

**OUTPUT VOLTAGE  
 vs  
 OUTPUT CURRENT**

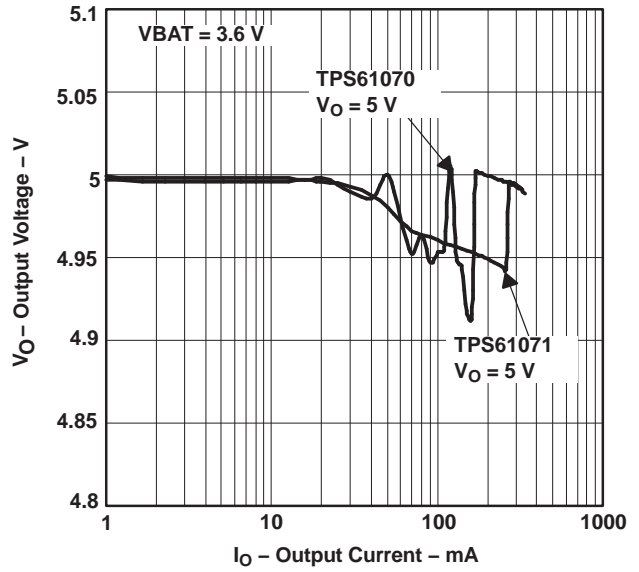

Figure 8.

**NO LOAD SUPPLY CURRENT INTO VOUT  
 vs  
 INPUT VOLTAGE**

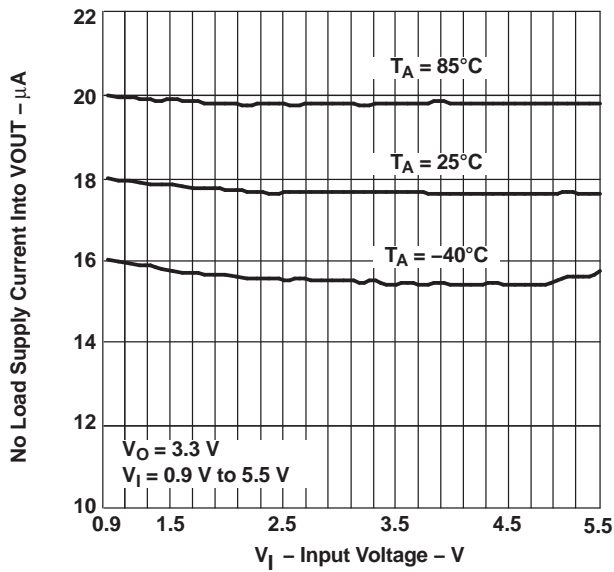

Figure 9.

**TPS61071  
 OUTPUT VOLTAGE IN CONTINUOUS MODE**

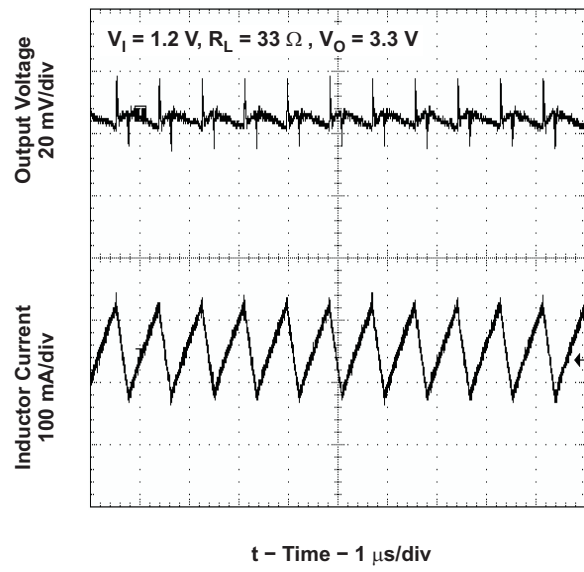
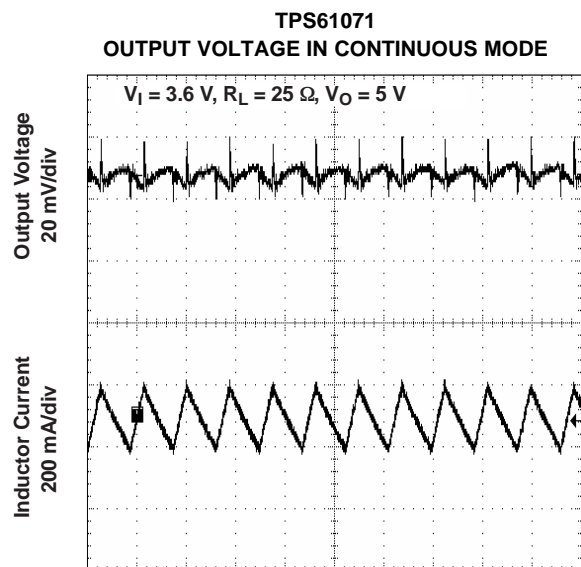

Figure 10.



TYPICAL CHARACTERISTICS (continued)



t – Time – 1  $\mu\text{s}/\text{div}$

Figure 11.

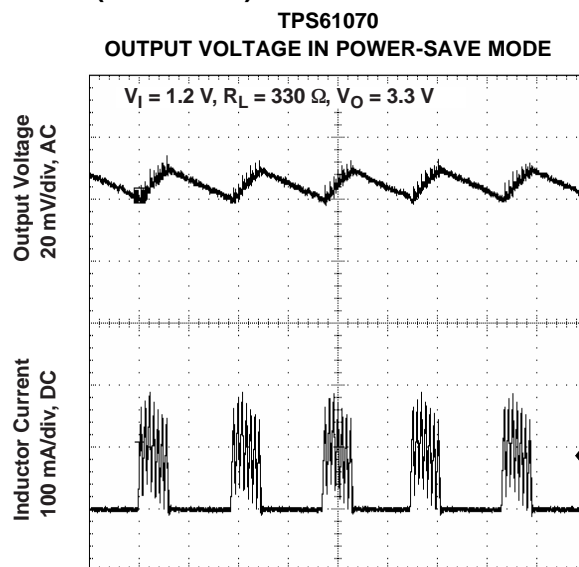

t – Time – 10  $\mu\text{s}/\text{div}$

Figure 12.

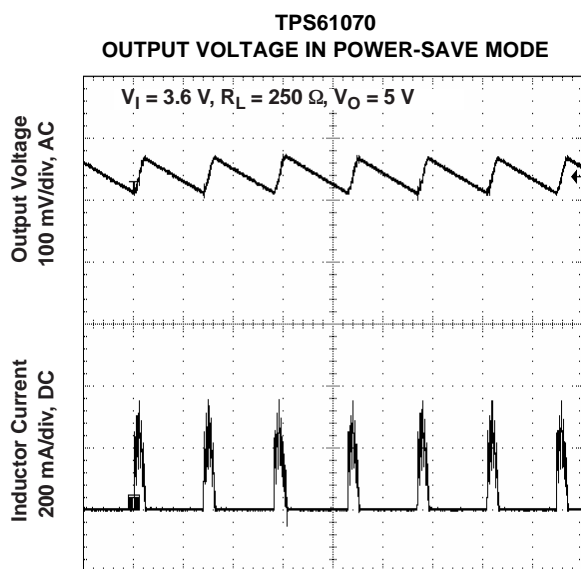

t – Time – 20  $\mu\text{s}/\text{div}$

Figure 13.

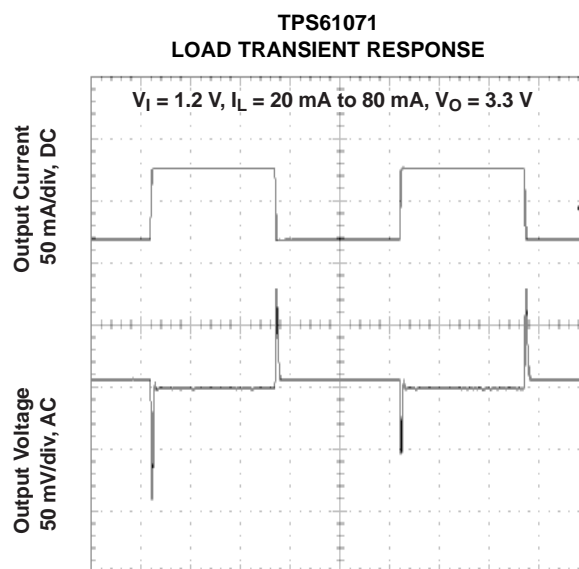

t – Time – 2 ms/div

Figure 14.

**TYPICAL CHARACTERISTICS (continued)**

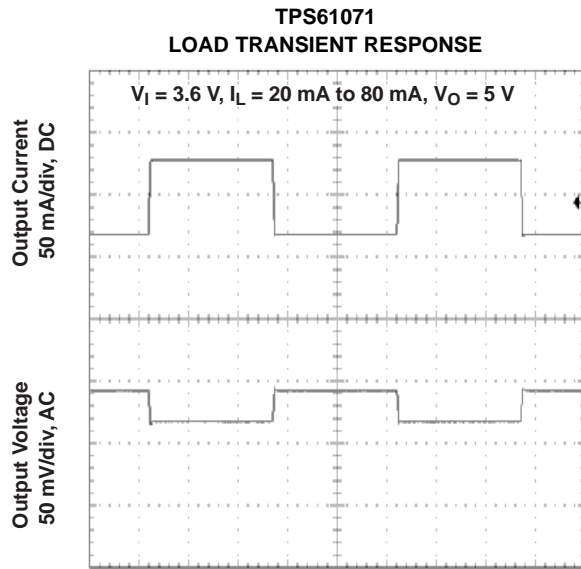

Figure 15.

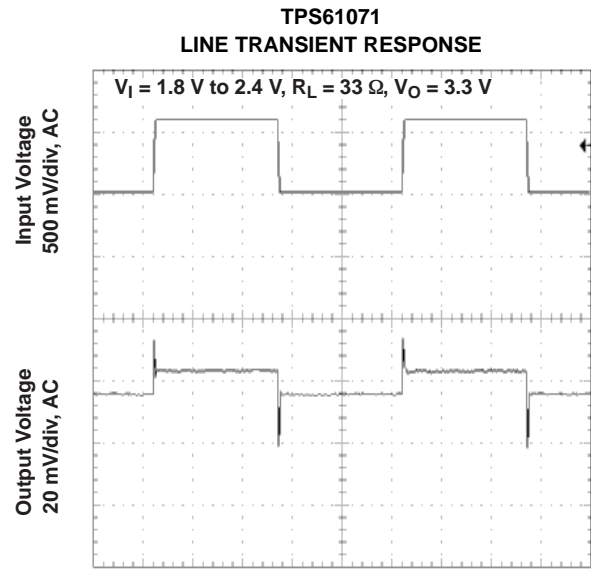

Figure 16.

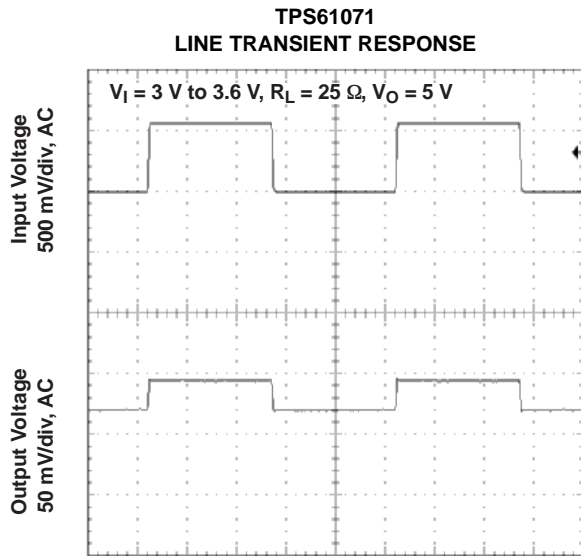

Figure 17.

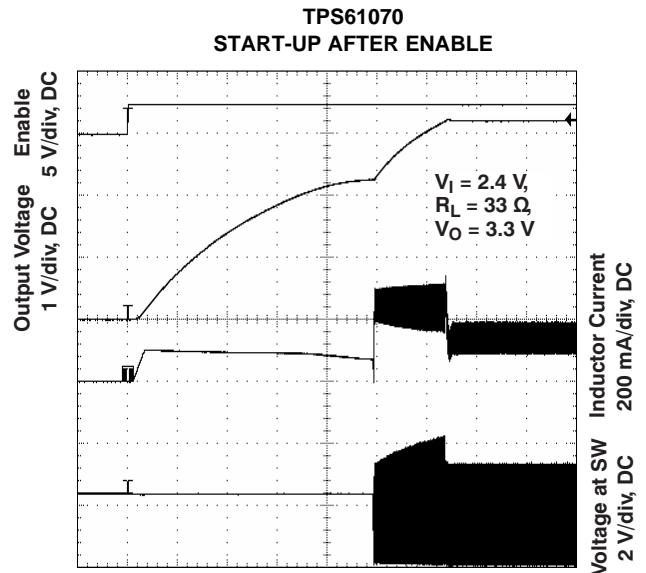
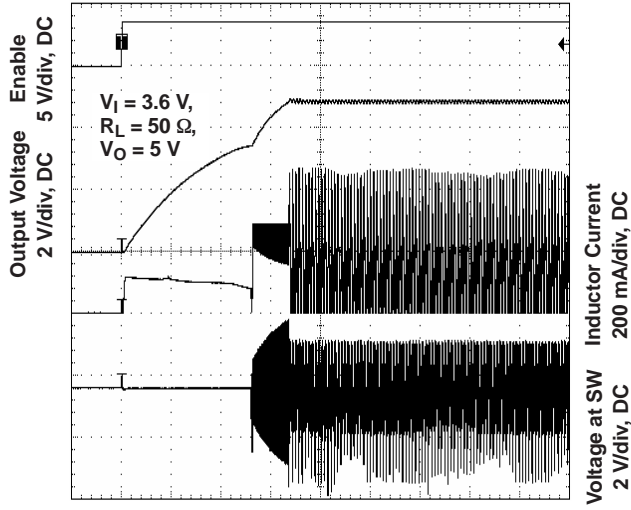

Figure 18.

TYPICAL CHARACTERISTICS (continued)

TPS61070  
START-UP AFTER ENABLE



t – Time – 400 μs/div

Figure 19.

TPS61071  
START-UP AFTER ENABLE

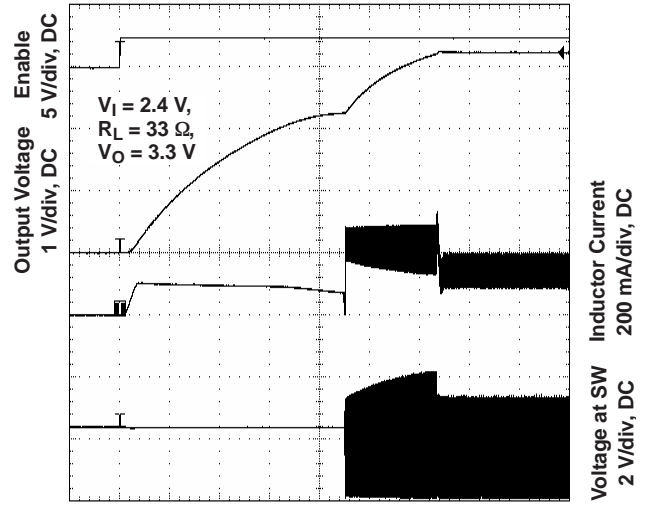

t – Time – 200 μs/div

Figure 20.

TPS61071  
START-UP AFTER ENABLE

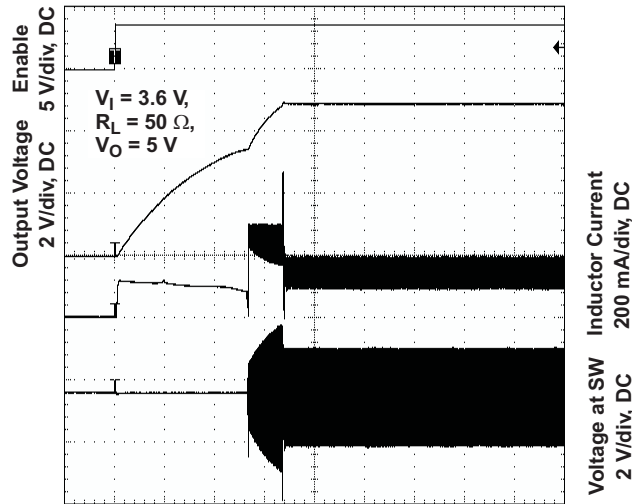

t – Time – 400 μs/div

Figure 21.

## DETAILED DESCRIPTION

### CONTROLLER CIRCUIT

The controller circuit of the device is based on a fixed frequency multiple feedforward controller topology. Input voltage, output voltage, and voltage drop on the NMOS switch are monitored and forwarded to the regulator. So, changes in the operating conditions of the converter directly affect the duty cycle and must not take the indirect and slow way through the control loop and the error amplifier. The control loop, determined by the error amplifier, only has to handle small signal errors. The input for it is the feedback voltage on the FB pin. It is compared with the internal reference voltage to generate an accurate and stable output voltage.

The peak current of the NMOS switch is also sensed to limit the maximum current flowing through the switch and the inductor. The typical peak-current limit is set to 600 mA. An internal temperature sensor prevents the device from getting overheated in case of excessive power dissipation.

### Synchronous Rectifier

The device integrates an N-channel and a P-channel MOSFET transistor to realize a synchronous rectifier. Because the commonly used discrete Schottky rectifier is replaced with a low  $R_{DS(on)}$  PMOS switch, the power conversion efficiency reaches values above 90%. A special circuit is applied to disconnect the load from the input during shutdown of the converter. In conventional synchronous rectifier circuits, the backgate diode of the high-side PMOS is forward biased in shutdown and allows current flowing from the battery to the output. However, this device uses a special circuit which takes the cathode of the backgate diode of the high-side PMOS and disconnects it from the source when the regulator is not enabled ( $EN = low$ ).

The benefit of this feature for the system design engineer is that the battery is not depleted during shutdown of the converter. No additional components must be added to the design to make sure that the battery is disconnected from the output of the converter.

### Device Enable

The device is put into operation when EN is set high. It is put into a shutdown mode when EN is set to GND. In shutdown mode, the regulator stops switching, all internal control circuitry is switched off, and the load is isolated from the input (as described in the *Synchronous Rectifier Section*). This also means that the output voltage can drop below the input voltage during shutdown. During start-up of the converter, the duty cycle and the peak current are limited in order to avoid high-peak currents drawn from the battery.

### Undervoltage Lockout

An undervoltage lockout function prevents the device from operating if the supply voltage on VBAT is lower than approximately 0.8 V. When in operation and the battery is being discharged, the device automatically enters the shutdown mode if the voltage on VBAT drops below approximately 0.8 V. This undervoltage lockout function is implemented in order to prevent the malfunctioning of the converter.

### Soft Start and Short-Circuit Protection

When the device enables, the internal start-up cycle starts with the first step, the precharge phase. During precharge, the rectifying switch is turned on until the output capacitor is charged to a value close to the input voltage. The rectifying switch is current limited during this phase. The current limit increases with the output voltage. This circuit also limits the output current under short-circuit conditions at the output. [Figure 22](#) shows the typical precharge current vs output voltage for specific input voltages:

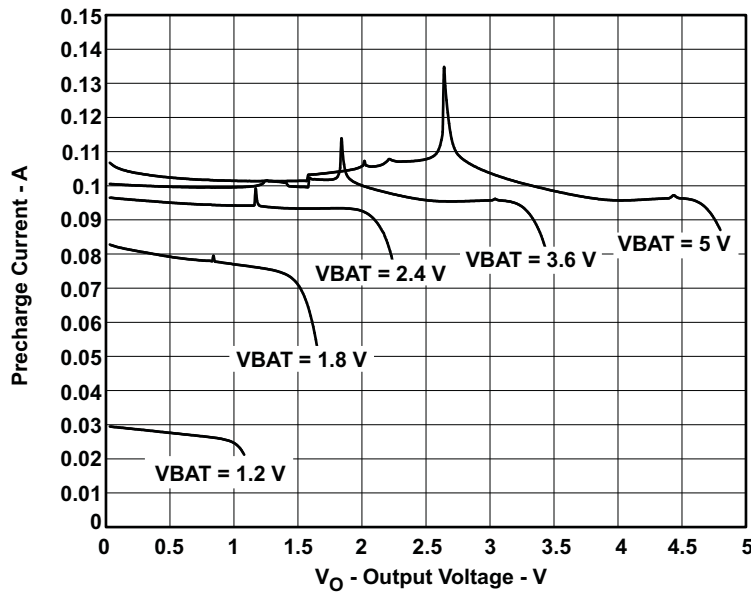

Figure 22. Precharge and Short-Circuit Current

After charging the output capacitor to the input voltage, the device starts switching. If the input voltage is below 1.8 V, the device works with a fixed duty cycle of 70% until the output voltage reaches 1.8 V. After that the duty cycle is set depending on the input output voltage ratio. Until the output voltage reaches its nominal value, the boost switch current limit is set to 50% of its nominal value to avoid high peak currents at the battery during start-up. As soon as the output voltage is reached, the regulator takes control, and the switch current limit is set back to 100%.

### Power-Save Mode

The TPS61070 and TPS61073 are capable of operating in two different modes. At light loads, when the inductor current becomes zero, they automatically enter the power-save mode to improve efficiency. In the power-save mode, the converters only operate when the output voltage trips below a set threshold voltage. It ramps up the output voltage with one or several pulses and returns to the power-save mode once the output voltage exceeds the set threshold voltage. If output power demand increases and the inductor current no longer goes below zero, the device again enters the fixed PWM mode. In this mode, there is no difference between the PWM only versions TPS61071 and TPS61072 and the power-save mode enabled versions TPS61070 and TPS61073.

## APPLICATION INFORMATION

### DESIGN PROCEDURE

The TPS6107x dc/dc converters are intended for systems powered by a single-cell, up to triple-cell alkaline, NiCd, NiMH battery with a typical terminal voltage between 0.9 V and 5.5 V. They can also be used in systems powered by one-cell Li-ion or Li-polymer with a typical voltage between 2.5 V and 4.2 V. Additionally, any other voltage source with a typical output voltage between 0.9 V and 5.5 V can power systems where the TPS6107x is used. Due to the nature of boost converters, the output voltage regulation is only maintained when the input voltage applied is lower than the programmed output voltage.

### Programming the Output Voltage

The output voltage of the TPS6107x dc/dc converter can be adjusted with an external resistor divider. The typical value of the voltage at the FB pin is 500 mV. The maximum recommended value for the output voltage is 5.5 V. The current through the resistive divider should be about 100 times greater than the current into the FB pin. The typical current into the FB pin is 0.01  $\mu$ A, and the voltage across R2 is typically 500 mV. Based on those two values, the recommended value for R2 should be lower than 500 k $\Omega$ , in order to set the divider current at 1  $\mu$ A or higher. Because of internal compensation circuitry, the value for this resistor should be in the range of 200 k $\Omega$ . From that, the value of resistor R1, depending on the needed output voltage ( $V_O$ ), is calculated using [Equation 1](#):

$$R1 = R2 \times \left( \frac{V_O}{V_{FB}} - 1 \right) = 180 \text{ k}\Omega \times \left( \frac{V_O}{500 \text{ mV}} - 1 \right) \quad (1)$$

For example, if an output voltage of 3.3 V is needed, a 1 M $\Omega$  resistor should be chosen for R1. If for any reason the value chosen for R2 is significantly lower than 200 k $\Omega$ , additional capacitance in parallel to R1 is recommended, if the device shows instable regulation of the output voltage. The required capacitance value is calculated using [Equation 2](#):

$$C_{\text{parR1}} = 3 \text{ pF} \times \left( \frac{200 \text{ k}\Omega}{R2} - 1 \right) \quad (2)$$

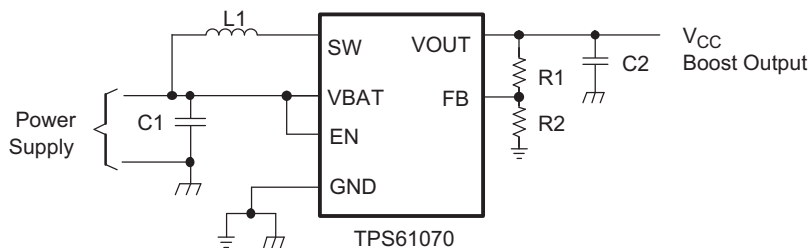

Figure 23. Typical Application Circuit for Adjustable Output Voltage Option

### Inductor Selection

A boost converter normally requires two main passive components for storing energy during the conversion. A boost inductor and a storage capacitor at the output are required. To select the boost inductor, it is recommended to keep the possible peak inductor current below the current limit threshold of the power switch in the chosen configuration. For example, the current limit threshold of the TPS6107x's switch is 600 mA. The highest peak current through the inductor and the switch depends on the output load, the input ( $V_{BAT}$ ), and the output voltage ( $V_{OUT}$ ). Estimation of the maximum average inductor current is done using [Equation 3](#):

$$I_L = I_O \times \frac{V_{OUT}}{V_{BAT} \times 0.8} \quad (3)$$

For example, for an output current of 75 mA at 3.3 V, at least 340 mA of average current flows through the inductor at a minimum input voltage of 0.9 V.

The second parameter for choosing the inductor is the desired current ripple in the inductor. Normally, it is advisable to work with a ripple of less than 20% of the average inductor current. A smaller ripple reduces the magnetic hysteresis losses in the inductor, as well as output voltage ripple and EMI. But in the same way, regulation time rises at load changes. In addition, a larger inductor increases the total system costs. With these parameters, it is possible to calculate the value for the inductor by using [Equation 4](#):

$$L = \frac{V_{BAT} \times (V_{OUT} - V_{BAT})}{\Delta I_L \times f \times V_{OUT}} \quad (4)$$

Parameter  $f$  is the switching frequency and  $\Delta I_L$  is the ripple current in the inductor, i.e., 40%  $\Delta I_L$ . In this example, the desired inductor has the value of 4  $\mu\text{H}$ . With this calculated value and the calculated currents, it is possible to choose a suitable inductor. In typical applications, a 4.7  $\mu\text{H}$  inductance is recommended. The device has been optimized to operate with inductance values between 2.2  $\mu\text{H}$  and 10  $\mu\text{H}$ . Nevertheless, operation with higher inductance values may be possible in some applications. Detailed stability analysis is then recommended. Care must be taken because load transients and losses in the circuit can lead to higher currents as estimated in [Equation 4](#). Also, the losses in the inductor caused by magnetic hysteresis losses and copper losses are a major parameter for total circuit efficiency.

The following inductor series from different suppliers have been used with the TPS6107x converters:

**Table 1. List of Inductors**

VENDOR	INDUCTOR SERIES
TDK	VLF3010
	VLF4012
Würth Elektronik	744031xxx
	744042xxx
EPCOS	B82462-G4
Cooper Electronics Technologies	SD18
	SD20
Taiyo Yuden	CB2016B xxx
	CB2518B xxx

## Capacitor Selection

### Input Capacitor

At least a 10  $\mu\text{F}$  input capacitor is recommended to improve transient behavior of the regulator and EMI behavior of the total power supply circuit. A ceramic capacitor or a tantalum capacitor with a 100-nF ceramic capacitor in parallel, placed close to the IC, is recommended.

### Output Capacitor

The major parameter necessary to define the output capacitor is the maximum allowed output voltage ripple of the converter. This ripple is determined by two parameters of the capacitor, the capacitance and the ESR. It is possible to calculate the minimum capacitance needed for the defined ripple, supposing that the ESR is zero, by using [Equation 5](#):

$$C_{\min} = \frac{I_O \times (V_{OUT} - V_{BAT})}{f \times \Delta V \times V_{OUT}} \quad (5)$$

Parameter  $f$  is the switching frequency and  $\Delta V$  is the maximum allowed ripple.

With a chosen ripple voltage of 10 mV, a minimum capacitance of 4.5  $\mu\text{F}$  is needed. In this value range, ceramic capacitors are a good choice. The ESR and the additional ripple created are negligible. It is calculated using [Equation 6](#):

$$\Delta V_{\text{ESR}} = I_O \times R_{\text{ESR}} \quad (6)$$

The total ripple is the sum of the ripple caused by the capacitance and the ripple caused by the ESR of the capacitor. Additional ripple is caused by load transients. This means that the output capacitor has to completely supply the load during the charging phase of the inductor. The value of the output capacitance depends on the speed of the load transients and the load current during the load change. With the calculated minimum value of 4.5  $\mu\text{F}$  and load transient considerations, the recommended output capacitance value is in a 10  $\mu\text{F}$  range.

Care must be taken on capacitance loss caused by derating due to the applied dc voltage and the frequency characteristic of the capacitor. For example, larger form factor capacitors (in 1206 size) have their self resonant frequencies in the same frequency range as the TPS6107x operating frequency. So the effective capacitance of the capacitors used may be significantly lower. Therefore, the recommendation is to use smaller capacitors in parallel instead of one larger capacitor.

### Small Signal Stability

To analyze small signal stability in more detail, the small signal transfer function of the error amplifier and the regulator, which is given in Equation 7, can be used:

$$A_{(\text{REG})} = \frac{d}{V_{(\text{FB})}} = \frac{5 \times (R1 + R2)}{R2 \times (1 + i \times \omega \times 0.8 \mu\text{s})} \quad (7)$$

### Layout Considerations

As for all switching power supplies, the layout is an important step in the design, especially at high-peak currents and high switching frequencies. If the layout is not carefully done, the regulator could show stability problems as well as EMI problems. Therefore, use wide and short traces for the main current path and for the power ground tracks. The input capacitor, output capacitor, and the inductor should be placed as close as possible to the IC. Use a common ground node for power ground and a different one for control ground to minimize the effects of ground noise. Connect these ground nodes at any place close to the ground pin of the IC.

The feedback divider should be placed as close as possible to the ground pin of the IC. To lay out the control ground, it is recommended to use short traces as well, separated from the power ground traces. This avoids ground shift problems, which can occur due to superimposition of power ground current and control ground current.

### APPLICATION EXAMPLES

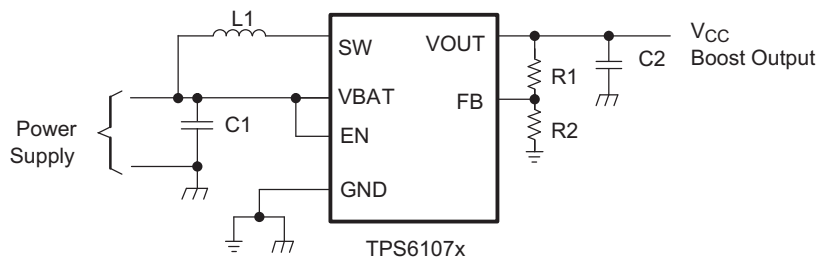

- List of Components:  
 U1 = TPS61070DDC  
 L1 = 4.7  $\mu\text{H}$  Würth Elektronik 744031004  
 C1 = 2 x 4.7  $\mu\text{F}$ , 0603, X7R/X5R Ceramic  
 C2 = 2 x 4.7  $\mu\text{F}$ , 0603, X7R/X5R Ceramic

**Figure 24. Power Supply Solution for Maximum Output Power Operating from a Single or Dual Alkaline Cell**



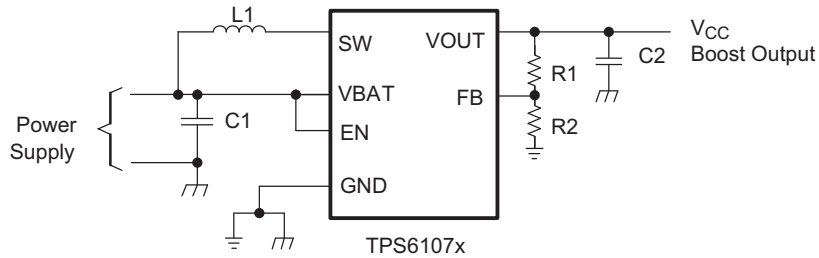

- List of Components:  
 U1 = TPS61070DDC  
 L1 = 4.7  $\mu$ H Taiyo Yuden CB2016B4R7M  
 C1 = 1 x 4.7  $\mu$ F, 0603, X7R/X5R Ceramic  
 C2 = 2 x 4.7  $\mu$ F, 0603, X7R/X5R Ceramic

Figure 25. Power Supply Solution Having Small Total Solution Size

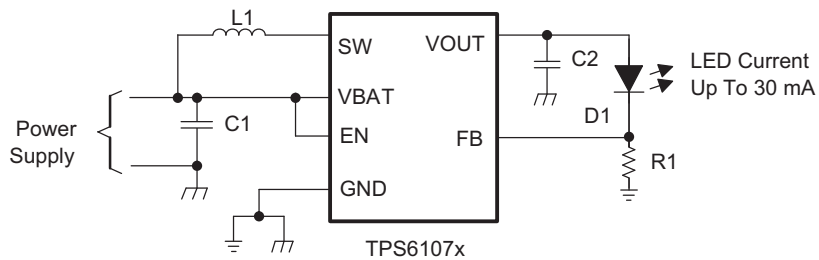

- List of Components:  
 U1 = TPS61070DDC  
 L1 = 4.7  $\mu$ H Taiyo Yuden CB2016B4R7M  
 C1 = 1 x 4.7  $\mu$ F, 0603, X7R/X5R Ceramic  
 C2 = 2 x 4.7  $\mu$ F, 0603, X7R/X5R Ceramic

Figure 26. Power Supply Solution for Powering White LEDs in Lighting Applications

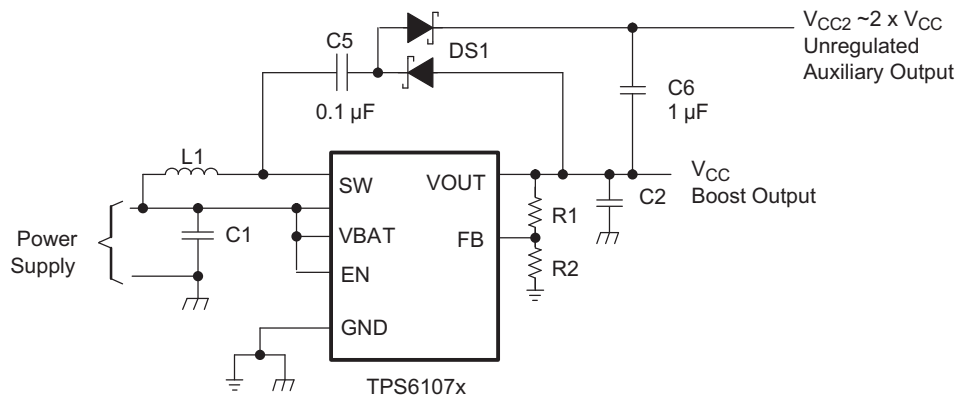

- List of Components:  
 U1 = TPS61070DDC  
 L1 = 4.7  $\mu$ H Wurth Elektronik 744031004  
 C1 = 2 x 4.7  $\mu$ F, 0603, X7R/X5R Ceramic  
 C2 = 2 x 4.7  $\mu$ F, 0603, X7R/X5R Ceramic

Figure 27. Power Supply Solution With Auxiliary Positive Output Voltage

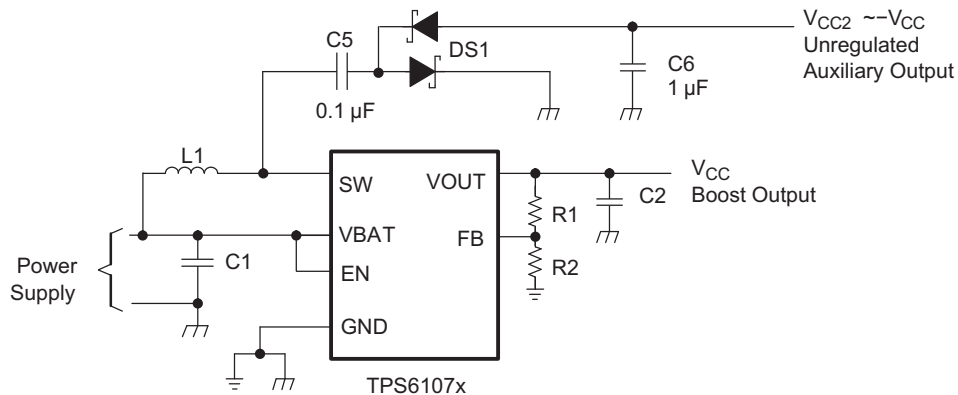

- List of Components:  
 U1 = TPS61070DDC  
 L1 = 4.7 μH Würth Elektronik 744031004  
 C1 = 2 x 4.7 μF, 0603, X7R/X5R Ceramic  
 C2 = 2 x 4.7 μF, 0603, X7R/X5R Ceramic

**Figure 28. Power Supply Solution With Auxiliary Negative Output Voltage**

## THERMAL INFORMATION

Implementation of integrated circuits in low-profile and fine-pitch surface-mount packages typically requires special attention to power dissipation. Many system-dependent issues such as thermal coupling, airflow, added heat sinks and convection surfaces, and the presence of other heat-generating components affect the power-dissipation limits of a given component.

Three basic approaches for enhancing thermal performance follow.

- Improving the power dissipation capability of the PCB design
- Improving the thermal coupling of the component to the PCB
- Introducing airflow in the system

The maximum recommended junction temperature ( $T_J$ ) of the TPS6107x devices is 125°C. The thermal resistance of the 6-pin thin SOT package (DDC) is  $R_{\theta JA} = 130^\circ\text{C/W}$ . Specified regulator operation is assured to a maximum ambient temperature  $T_A$  of 85°C. Therefore, the maximum power dissipation is about 308 mW. More power can be dissipated if the maximum ambient temperature of the application is lower.

$$P_{D(\text{MAX})} = \frac{T_{J(\text{MAX})} - T_A}{R_{\theta JA}} = \frac{125^\circ\text{C} - 85^\circ\text{C}}{130^\circ\text{C/W}} = 308 \text{ mW} \quad (8)$$

**PACKAGING INFORMATION**

Orderable Device	Status (1)	Package Type	Package Drawing	Pins	Package Qty	Eco Plan (2)	Lead finish/ Ball material (6)	MSL Peak Temp (3)	Op Temp (°C)	Device Marking (4/5)	Samples
TPS61070DDCR	ACTIVE	SOT-23-THIN	DDC	6	3000	RoHS & Green	NIPDAU	Level-1-260C-UNLIM	-40 to 125	AUH	<a href="#">Samples</a>
TPS61070DDCRG4	ACTIVE	SOT-23-THIN	DDC	6	3000	RoHS & Green	NIPDAU	Level-1-260C-UNLIM	-40 to 85	AUH	<a href="#">Samples</a>
TPS61071DDCR	ACTIVE	SOT-23-THIN	DDC	6	3000	RoHS & Green	NIPDAU	Level-1-260C-UNLIM	-40 to 125	AUJ	<a href="#">Samples</a>
TPS61071DDCRG4	ACTIVE	SOT-23-THIN	DDC	6	3000	RoHS & Green	NIPDAU	Level-1-260C-UNLIM	-40 to 85	AUJ	<a href="#">Samples</a>
TPS61072DDCR	ACTIVE	SOT-23-THIN	DDC	6	3000	RoHS & Green	NIPDAU	Level-1-260C-UNLIM	-40 to 125	BUM	<a href="#">Samples</a>
TPS61073DDCR	ACTIVE	SOT-23-THIN	DDC	6	3000	RoHS & Green	NIPDAU	Level-1-260C-UNLIM	-40 to 125	BUN	<a href="#">Samples</a>

(1) The marketing status values are defined as follows:

**ACTIVE:** Product device recommended for new designs.

**LIFEBUY:** TI has announced that the device will be discontinued, and a lifetime-buy period is in effect.

**NRND:** Not recommended for new designs. Device is in production to support existing customers, but TI does not recommend using this part in a new design.

**PREVIEW:** Device has been announced but is not in production. Samples may or may not be available.

**OBSELETE:** TI has discontinued the production of the device.

(2) **RoHS:** TI defines "RoHS" to mean semiconductor products that are compliant with the current EU RoHS requirements for all 10 RoHS substances, including the requirement that RoHS substance do not exceed 0.1% by weight in homogeneous materials. Where designed to be soldered at high temperatures, "RoHS" products are suitable for use in specified lead-free processes. TI may reference these types of products as "Pb-Free".

**RoHS Exempt:** TI defines "RoHS Exempt" to mean products that contain lead but are compliant with EU RoHS pursuant to a specific EU RoHS exemption.

**Green:** TI defines "Green" to mean the content of Chlorine (Cl) and Bromine (Br) based flame retardants meet JS709B low halogen requirements of <=1000ppm threshold. Antimony trioxide based flame retardants must also meet the <=1000ppm threshold requirement.

(3) MSL, Peak Temp. - The Moisture Sensitivity Level rating according to the JEDEC industry standard classifications, and peak solder temperature.

(4) There may be additional marking, which relates to the logo, the lot trace code information, or the environmental category on the device.

(5) Multiple Device Markings will be inside parentheses. Only one Device Marking contained in parentheses and separated by a "-" will appear on a device. If a line is indented then it is a continuation of the previous line and the two combined represent the entire Device Marking for that device.

(6) Lead finish/Ball material - Orderable Devices may have multiple material finish options. Finish options are separated by a vertical ruled line. Lead finish/Ball material values may wrap to two lines if the finish value exceeds the maximum column width.

**Important Information and Disclaimer:** The information provided on this page represents TI's knowledge and belief as of the date that it is provided. TI bases its knowledge and belief on information provided by third parties, and makes no representation or warranty as to the accuracy of such information. Efforts are underway to better integrate information from third parties. TI has taken and continues to take reasonable steps to provide representative and accurate information but may not have conducted destructive testing or chemical analysis on incoming materials and chemicals. TI and TI suppliers consider certain information to be proprietary, and thus CAS numbers and other limited information may not be available for release.

In no event shall TI's liability arising out of such information exceed the total purchase price of the TI part(s) at issue in this document sold by TI to Customer on an annual basis.

**OTHER QUALIFIED VERSIONS OF TPS61071 :**

- Automotive : [TPS61071-Q1](#)

NOTE: Qualified Version Definitions:

- Automotive - Q100 devices qualified for high-reliability automotive applications targeting zero defects

## TAPE AND REEL INFORMATION



### QUADRANT ASSIGNMENTS FOR PIN 1 ORIENTATION IN TAPE



\*All dimensions are nominal

Device	Package Type	Package Drawing	Pins	SPQ	Reel Diameter (mm)	Reel Width W1 (mm)	A0 (mm)	B0 (mm)	K0 (mm)	P1 (mm)	W (mm)	Pin1 Quadrant
TPS61070DDCR	SOT-23-THIN	DDC	6	3000	179.0	8.4	3.2	3.2	1.4	4.0	8.0	Q3
TPS61071DDCR	SOT-23-THIN	DDC	6	3000	179.0	8.4	3.2	3.2	1.4	4.0	8.0	Q3
TPS61072DDCR	SOT-23-THIN	DDC	6	3000	179.0	8.4	3.2	3.2	1.4	4.0	8.0	Q3
TPS61073DDCR	SOT-23-THIN	DDC	6	3000	179.0	8.4	3.2	3.2	1.4	4.0	8.0	Q3

**TAPE AND REEL BOX DIMENSIONS**



\*All dimensions are nominal

Device	Package Type	Package Drawing	Pins	SPQ	Length (mm)	Width (mm)	Height (mm)
TPS61070DDCR	SOT-23-THIN	DDC	6	3000	200.0	183.0	25.0
TPS61071DDCR	SOT-23-THIN	DDC	6	3000	200.0	183.0	25.0
TPS61072DDCR	SOT-23-THIN	DDC	6	3000	200.0	183.0	25.0
TPS61073DDCR	SOT-23-THIN	DDC	6	3000	200.0	183.0	25.0

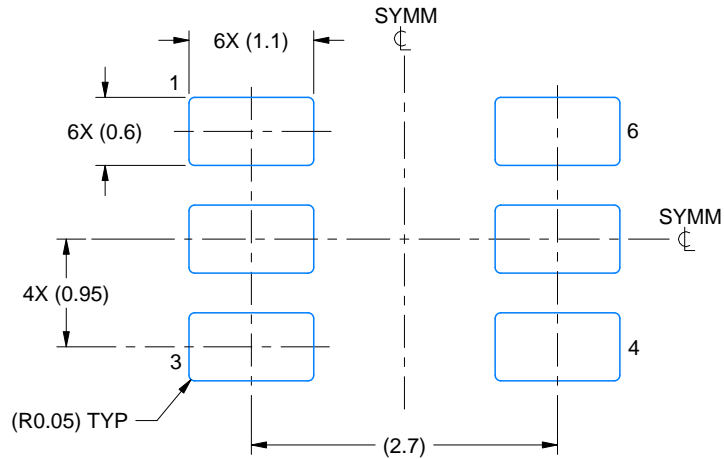

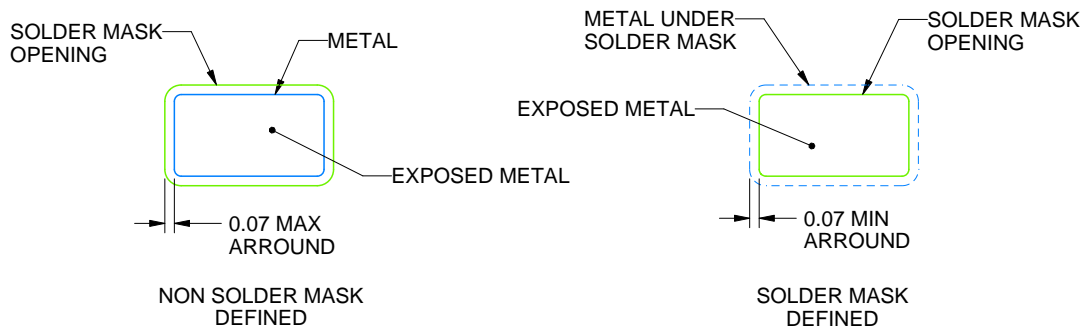

LAND PATTERN EXAMPLE  
EXPLODED METAL SHOWN  
SCALE:15X



SOLDEMASK DETAILS

4214841/E 08/2024

NOTES: (continued)

- 4. Publication IPC-7351 may have alternate designs.
- 5. Solder mask tolerances between and around signal pads can vary based on board fabrication site.



# EXAMPLE STENCIL DESIGN

DDC0006A

SOT-23 - 1.1 max height

SMALL OUTLINE TRANSISTOR

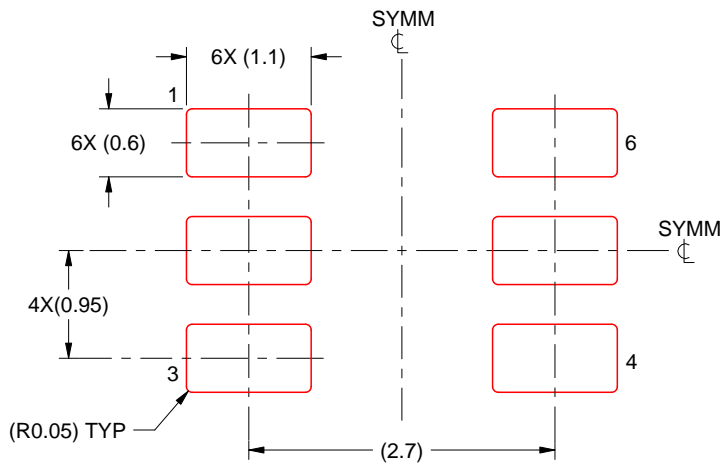

SOLDER PASTE EXAMPLE  
BASED ON 0.125 THICK STENCIL  
SCALE:15X

4214841/E 08/2024

NOTES: (continued)

6. Laser cutting apertures with trapezoidal walls and rounded corners may offer better paste release. IPC-7525 may have alternate design recommendations.
7. Board assembly site may have different recommendations for stencil design.

## 重要声明和免责声明

TI“按原样”提供技术和可靠性数据（包括数据表）、设计资源（包括参考设计）、应用或其他设计建议、网络工具、安全信息和其他资源，不保证没有瑕疵且不做任何明示或暗示的担保，包括但不限于对适销性、某特定用途方面的适用性或不侵犯任何第三方知识产权的暗示担保。

这些资源可供使用 TI 产品进行设计的熟练开发人员使用。您将自行承担以下全部责任：(1) 针对您的应用选择合适的 TI 产品，(2) 设计、验证并测试您的应用，(3) 确保您的应用满足相应标准以及任何其他功能安全、信息安全、监管或其他要求。

这些资源如有变更，恕不另行通知。TI 授权您仅可将这些资源用于研发本资源所述的 TI 产品的应用。严禁对这些资源进行其他复制或展示。您无权使用任何其他 TI 知识产权或任何第三方知识产权。您应全额赔偿因在这些资源的使用中对 TI 及其代表造成的任何索赔、损害、成本、损失和债务，TI 对此概不负责。

TI 提供的产品受 [TI 的销售条款](#) 或 [ti.com](#) 上其他适用条款/TI 产品随附的其他适用条款的约束。TI 提供这些资源并不会扩展或以其他方式更改 TI 针对 TI 产品发布的适用的担保或担保免责声明。

TI 反对并拒绝您可能提出的任何其他或不同的条款。

邮寄地址：Texas Instruments, Post Office Box 655303, Dallas, Texas 75265  
Copyright © 2024，德州仪器 (TI) 公司