



## 四通道, 250 每秒百万次采样 (MSPS) 接收器和反馈模数转换器 (ADC)

 查询样品: [ADS58H40](#)

特性	说明
<ul style="list-style-type: none"> <li>• 四通道</li> <li>• 三个不同的运行模式:                             <ul style="list-style-type: none"> <li>– 11 位: <b>250MSPS</b></li> <li>– 11 位 <b>SNRBoost<sup>3G+</sup>: 250MSPS</b></li> <li>– 14 位: <b>250MSPS</b> (突发模式)</li> </ul> </li> <li>• 最大采样数据速率: <b>250MSPS</b></li> <li>• 功率耗散:                             <ul style="list-style-type: none"> <li>– 11 位模式: 每通道 <b>365mW</b></li> </ul> </li> <li>• <b>SNRBoost<sup>3G+</sup> 带宽: 2x 45MHz 或者 90MHz</b></li> <li>• <b>170MHz IF 上的频谱性能 (典型值):</b> <ul style="list-style-type: none"> <li>– 信噪比 (SNR): 在 <b>SNRBoost<sup>3G+</sup> 的 90MHz 波段下为 70.5dBFS</b></li> <li>– 无杂散动态范围 (SFDR): <b>85dBc</b></li> </ul> </li> <li>• <b>DDR 低压差分信令 (LVDS) 数字输出接口</b></li> <li>• <b>144 热层球状引脚栅格阵列封装 (BGA) (10mm x 10mm)</b></li> </ul>	<p>ADS58H40 是一款高线性, 四通道, 14 位, 250MSPS 模数转换器 (ADC)。四个 ADC 通道被分成两块, 每块有两个 ADC。每个块可被独立配置成为三个不同的运行模式。一个运行模式包括 SNRBoost<sup>3G+</sup> 信号处理技术的实现来在只使用 11 位分辨率的情况下在高达 90MHz 带宽内提供高信噪比 (SNR)。针对低功耗和高无杂散动态范围 (SFDR) 而设计, 此 ADC 具有低噪声性能以及在宽输入频率范围内出色的 SFDR。</p>

### 应用范围

- 多载波 **GSM** 蜂窝基础设施基站
- 多载波多模式蜂窝基础设施基站
- 针对无线基础设施有源天线阵列
- 通信测试设备



Please be aware that an important notice concerning availability, standard warranty, and use in critical applications of Texas Instruments semiconductor products and disclaimers thereto appears at the end of this data sheet.

All trademarks are the property of their respective owners.



This integrated circuit can be damaged by ESD. Texas Instruments recommends that all integrated circuits be handled with appropriate precautions. Failure to observe proper handling and installation procedures can cause damage.

ESD damage can range from subtle performance degradation to complete device failure. Precision integrated circuits may be more susceptible to damage because very small parametric changes could cause the device not to meet its published specifications.

**PACKAGE AND ORDERING INFORMATION<sup>(1)</sup>**

PRODUCT	PACKAGE-LEAD	PACKAGE DESIGNATOR	SPECIFIED TEMPERATURE RANGE	ECO PLAN <sup>(2)</sup>	LEAD AND BALL FINISH	PACKAGE MARKING	ORDERING NUMBER	TRANSPORT MEDIA
ADS58H40	BGA-144	ZCR	-40°C to +85°C	GREEN (RoHS, no SB or BR)	CuNiPdAu	ADS58H40I	ADS58H40IZCR	Tray
							ADS58H40IZCRR	Tape and Reel

- (1) For the most current package and ordering information, see the Package Option Addendum at the end of this document, or visit the device product folder at [www.ti.com](http://www.ti.com).
- (2) These packages conform to Lead (Pb)-free and green manufacturing specifications. Additional details including specific material content can be accessed at [www.ti.com/leadfree](http://www.ti.com/leadfree).  
 GREEN: TI defines Green to mean Lead (Pb)-Free and in addition, uses less package materials that do not contain halogens, including bromine (Br), or antimony (Sb) above 0.1% of total product weight.  
 N/A: Not yet available Lead (Pb)-Free; for estimated conversion dates, go to [www.ti.com/leadfree](http://www.ti.com/leadfree).  
 Pb-FREE: TI defines Lead (Pb)-Free to mean RoHS compatible, including a lead concentration that does not exceed 0.1% of total product weight, and, if designed to be soldered, suitable for use in specified lead-free soldering processes.

**ABSOLUTE MAXIMUM RATINGS<sup>(1)</sup>**

Over operating free-air temperature range, unless otherwise noted.

		VALUE	UNIT
Supply voltage range	AVDD33	-0.3 to +3.6	V
	AVDD	-0.3 to +2.1	V
	DRVDD	-0.3 to +2.1	V
Voltage between	AVSS and DRVSS	-0.3 to +0.3	V
	AVDD and DRVDD	-2.4 to +2.4	V
	AVDD33 and DRVDD	-2.4 to +3.9	V
	AVDD33 and AVDD	-2.4 to +3.9	V
Voltage applied to input pins	XINP, XINM	-0.3 to minimum (1.9, AVDD + 0.3)	V
	CLKP, CLKM <sup>(2)</sup>	-0.3 to minimum (1.9, AVDD + 0.3)	V
	RESET, SCLK, SDATA, SEN, SNRB, TRIG_EN, PDN	-0.3 to +3.9	V
Temperature	Operating free-air, T <sub>A</sub>	-40 to +85	°C
	Operating junction, T <sub>J</sub>	+150	°C
	Storage, T <sub>stg</sub>	-65 to +150	°C
Electrostatic discharge (ESD) ratings	Human body model (HBM)	2	kV

- (1) Stresses above these ratings may cause permanent damage. Exposure to absolute maximum conditions for extended periods may degrade device reliability. These are stress ratings only, and functional operation of the device at these or any other conditions beyond those specified is not implied.
- (2) When AVDD is turned off, TI recommends switching off the input clock (or ensuring the voltage on CLKP and CLKM is less than |0.3 V |). This recommendation prevents the ESD protection diodes at the clock input pins from turning on.

## THERMAL INFORMATION

THERMAL METRIC <sup>(1)</sup>		ADS58H40	UNITS
		ZCR (BGA)	
		144 PINS	
$\theta_{JA}$	Junction-to-ambient thermal resistance	35.9	°C/W
$\theta_{JCTop}$	Junction-to-case (top) thermal resistance	5.1	
$\theta_{JB}$	Junction-to-board thermal resistance	12.6	
$\psi_{JT}$	Junction-to-top characterization parameter	0.1	
$\psi_{JB}$	Junction-to-board characterization parameter	12.4	
$\theta_{JCbott}$	Junction-to-case (bottom) thermal resistance	N/A	

(1) 有关传统和新的热 度量的更多信息，请参阅 IC 封装热量应用报告， [SPRA953](#)。

## RECOMMENDED OPERATING CONDITIONS

		MIN	NOM	MAX	UNIT	
<b>SUPPLIES</b>						
AVDD33	Supply voltage	3.15	3.3	3.45	V	
AVDD		1.8	1.9	2.0	V	
DRVDD		1.7	1.8	2.0	V	
<b>ANALOG INPUTS</b>						
Differential input voltage range		2			$V_{PP}$	
Input common-mode voltage		$V_{CM} \pm 0.025$			V	
Analog input common-mode current (per input pin of each channel)		1.5			$\mu\text{A}/\text{MSPS}$	
VCM current capability		5			mA	
Maximum analog input frequency	2- $V_{PP}$ input amplitude <sup>(1)</sup>	400			MHz	
	1.4- $V_{PP}$ input amplitude	500			MHz	
<b>CLOCK INPUTS</b>						
Input clock sample rate		184 <sup>(2)</sup>		250	MSPS	
Input clock amplitude differential ( $V_{CLKP} - V_{CLKM}$ )	Sine wave, ac-coupled	0.2	1.5		$V_{PP}$	
	LVPECL, ac-coupled		1.6		$V_{PP}$	
	LVDS, ac-coupled		0.7		$V_{PP}$	
	LVC MOS, single-ended, ac-coupled		1.8		$V_{PP}$	
Input clock duty cycle		40%	50%	60%		
<b>DIGITAL OUTPUTS</b>						
$C_{LOAD}$	Maximum external load capacitance from each output pin to DRVSS (default strength)	3.3			pF	
$R_{LOAD}$	Differential load resistance between the LVDS output pairs (LVDS mode)	100			$\Omega$	
<b>TEMPERATURE RANGE</b>						
$T_A$	Operating free-air temperature	-40		+85	°C	
$T_J$	Operating junction temperature	Recommended			+105	°C
		Maximum rated <sup>(3)</sup>			+125	°C

(1) See the [Theory of Operation](#) section.

(2) The minimum *functional clock speed* can be 10 MSPS after writing the following special modes: address 4Ah, value 01h; address 62h, value 01h; address 92h, value 01h; and address 7Ah, value 01h. See the SPECIAL MODE[17:14] bits in [Table 4](#) of the [Serial Interface Registers](#) section.

(3) Prolonged use at this junction temperature may increase the device failure-in-time (FIT) rate.

**Table 1. High-Performance Modes Summary<sup>(1)(2)</sup>**

ADDRESS (Hex)	DATA (Hex)	$f_S = 245.76$ MSPS				$f_S = 184.32$ MSPS	
		$R_S = 50$ ZONE = 2	$R_S = 100$ ZONE = 2	$R_S = 50$ ZONE = 3	$R_S = 100$ ZONE = 3	$R_S = 50$ ZONE = 2	$R_S = 100$ ZONE = 2
D4	80				√		
D5	80				√		
D6	80	√	√	√	√	√	
D7	0C	√	√	√		√	√
DB	30				√		
F0	38					√	√
F1	20	√		√		√	
F5	42				√		

- (1)  $R_S$  refers to the source impedance. Zone refers to the Nyquist zone in which the signal band lies. Zone = 2 corresponds to the signal band that lies between  $f_S / 2$  and  $f_S$ . Zone = 3 corresponds to the signal band that lies between  $f_S$  and  $3 \times f_S / 2$ .
- (2) Best performance can be achieved by writing these modes depending upon source impedance, band of operation, and sampling speed.

**ELECTRICAL CHARACTERISTICS**

Typical values are at  $T_A = +25^\circ\text{C}$ , full temperature range is  $T_{MIN} = -40^\circ\text{C}$  to  $T_{MAX} = +85^\circ\text{C}$ , ADC clock frequency = 250 MHz, 50% clock duty cycle, AVDD33V = 3.3 V, AVDD = 1.9 V, DRVDD = 1.8 V, and -1-dBFS differential input, unless otherwise noted.

PARAMETER		TEST CONDITIONS	MIN	TYP	MAX	UNITS
<b>RESOLUTION</b>						
Default resolution				11		Bits
<b>ANALOG INPUTS</b>						
Differential input full-scale				2		$V_{PP}$
VCM	Common mode input voltage			1.15		V
$R_{IN}$	Input resistance, differential	At 170-MHz input frequency		700		$\Omega$
$C_{IN}$	Input capacitance, differential	At 170-MHz input frequency		3.3		pF
Analog input bandwidth, 3 dB		With a 50- $\Omega$ source driving the ADC analog inputs		500		MHz
<b>DYNAMIC ACCURACY</b>						
$E_O$	Offset error	Specified across devices and channels	-15		15	mV
$E_G$	Gain error <sup>(1)</sup>	As a result of internal reference inaccuracy alone	Specified across devices and channels	-5		5 %FS
		Of channel alone	Specified across channels within a device		$\pm 0.2$	%FS
Channel gain error temperature coefficient <sup>(1)</sup>				0.001		$\Delta\%/^\circ\text{C}$
<b>POWER SUPPLY<sup>(2)</sup></b>						
$I_{AVDD33}$	Supply current	3.3-V analog supply		51		mA
$I_{AVDD}$		1.9-V analog supply		350		mA
$I_{DRVDD}$		1.8-V digital supply	11-bit operation		340	
	SNRBoost <sup>3G+</sup> enabled (90 MHz)			400		mA
	14-bit burst mode			355		mA
$P_{TOTAL}$	Power dissipation	Total	11-bit operation	1.45	1.6	W
			SNRBoost <sup>3G+</sup> enabled	1.55	1.8	W
			14-bit burst mode	1.47		W
$P_{DISS(standby)}$		Standby		400		mW
$P_{DISS(global)}$		Global power-down		6	52	mW

- (1) There are two sources of gain error: internal reference inaccuracy and channel gain error.
- (2) A 185-MHz, full-scale, sine-wave input signal is applied to all four channels.

**ELECTRICAL CHARACTERISTICS (continued)**

Typical values are at  $T_A = +25^\circ\text{C}$ , full temperature range is  $T_{\text{MIN}} = -40^\circ\text{C}$  to  $T_{\text{MAX}} = +85^\circ\text{C}$ , ADC clock frequency = 250 MHz, 50% clock duty cycle, AVDD33V = 3.3 V, AVDD = 1.9 V, DRVDD = 1.8 V, and –1-dBFS differential input, unless otherwise noted.

PARAMETER		TEST CONDITIONS	MIN	TYP	MAX	UNITS	
<b>DYNAMIC AC CHARACTERISTICS<sup>(3)(4)</sup></b>							
SNR	Signal-to-noise ratio	11-bit SNRBoost <sup>3G+</sup> , 90-MHz BW	$f_{\text{IN}} = 140 \text{ MHz}, A_{\text{IN}} = -1 \text{ dBFS}$	71		dBFS	
			$f_{\text{IN}} = 170 \text{ MHz}, A_{\text{IN}} = -1 \text{ dBFS}$	69	70.5	dBFS	
		11-bit SNRBoost <sup>3G+</sup> , 60-MHz BW	$f_{\text{IN}} = 220 \text{ MHz}, A_{\text{IN}} = -1 \text{ dBFS}$		70		dBFS
			$f_{\text{IN}} = 307 \text{ MHz}, A_{\text{IN}} = -3 \text{ dBFS}$		71.7		dBFS
SINAD	Signal-to-noise and distortion ratio	11-bit SNRBoost <sup>3G+</sup> , 90-MHz BW	$f_{\text{IN}} = 350 \text{ MHz}, A_{\text{IN}} = -3 \text{ dBFS}$		71.5	dBFS	
			$f_{\text{IN}} = 140 \text{ MHz}, A_{\text{IN}} = -1 \text{ dBFS}$		70.6	dBFS	
		11-bit SNRBoost <sup>3G+</sup> , 60-MHz BW	$f_{\text{IN}} = 170 \text{ MHz}, A_{\text{IN}} = -1 \text{ dBFS}$	68	70.1	dBFS	
			$f_{\text{IN}} = 220 \text{ MHz}, A_{\text{IN}} = -1 \text{ dBFS}$		69.5	dBFS	
SFDR	Spurious-free dynamic range		$f_{\text{IN}} = 307 \text{ MHz}, A_{\text{IN}} = -3 \text{ dBFS}$		69.7	dBFS	
			$f_{\text{IN}} = 350 \text{ MHz}, A_{\text{IN}} = -3 \text{ dBFS}$		69.2	dBFS	
			$f_{\text{IN}} = 140 \text{ MHz}, A_{\text{IN}} = -1 \text{ dBFS}$		85	dBc	
			$f_{\text{IN}} = 170 \text{ MHz}, A_{\text{IN}} = -1 \text{ dBFS}$	80	85	dBc	
			$f_{\text{IN}} = 220 \text{ MHz}, A_{\text{IN}} = -1 \text{ dBFS}$		82	dBc	
THD	Total harmonic distortion		$f_{\text{IN}} = 307 \text{ MHz}, A_{\text{IN}} = -3 \text{ dBFS}$		78	dBc	
			$f_{\text{IN}} = 350 \text{ MHz}, A_{\text{IN}} = -3 \text{ dBFS}$		77	dBc	
			$f_{\text{IN}} = 140 \text{ MHz}, A_{\text{IN}} = -1 \text{ dBFS}$		82	dBc	
			$f_{\text{IN}} = 170 \text{ MHz}, A_{\text{IN}} = -1 \text{ dBFS}$	77	82	dBc	
			$f_{\text{IN}} = 220 \text{ MHz}, A_{\text{IN}} = -1 \text{ dBFS}$		80	dBc	
HD2	Second-order harmonic distortion <sup>(5)</sup>		$f_{\text{IN}} = 307 \text{ MHz}, A_{\text{IN}} = -3 \text{ dBFS}$		77	dBc	
			$f_{\text{IN}} = 350 \text{ MHz}, A_{\text{IN}} = -3 \text{ dBFS}$		76	dBc	
			$f_{\text{IN}} = 140 \text{ MHz}, A_{\text{IN}} = -1 \text{ dBFS}$		86	dBc	
			$f_{\text{IN}} = 170 \text{ MHz}, A_{\text{IN}} = -1 \text{ dBFS}$	80	85	dBc	
			$f_{\text{IN}} = 220 \text{ MHz}, A_{\text{IN}} = -1 \text{ dBFS}$		82	dBc	
HD3	Third-order harmonic distortion		$f_{\text{IN}} = 307 \text{ MHz}, A_{\text{IN}} = -3 \text{ dBFS}$		78	dBc	
			$f_{\text{IN}} = 350 \text{ MHz}, A_{\text{IN}} = -3 \text{ dBFS}$		77	dBc	
			$f_{\text{IN}} = 140 \text{ MHz}, A_{\text{IN}} = -1 \text{ dBFS}$		85	dBc	
			$f_{\text{IN}} = 170 \text{ MHz}, A_{\text{IN}} = -1 \text{ dBFS}$	82	85	dBc	
			$f_{\text{IN}} = 220 \text{ MHz}, A_{\text{IN}} = -1 \text{ dBFS}$		85	dBc	
Worst spur (non HD2, HD3)			$f_{\text{IN}} = 307 \text{ MHz}, A_{\text{IN}} = -3 \text{ dBFS}$		85	dBc	
			$f_{\text{IN}} = 350 \text{ MHz}, A_{\text{IN}} = -3 \text{ dBFS}$		83	dBc	
			$f_{\text{IN}} = 140 \text{ MHz}, A_{\text{IN}} = -1 \text{ dBFS}$		95	dBc	
			$f_{\text{IN}} = 170 \text{ MHz}, A_{\text{IN}} = -1 \text{ dBFS}$	87	95	dBc	
			$f_{\text{IN}} = 220 \text{ MHz}, A_{\text{IN}} = -1 \text{ dBFS}$		95	dBc	
DNL	Differential nonlinearity		–0.95	±0.5	1.6	LSBs	
INL	Integral nonlinearity			±1.5	±5.25	LSBs	
	Input overload recovery	Recovery to within 1% (of final value) for 6-dB output overload with sine-wave input		1		Clock cycle	
	Crosstalk	With a full-scale, 220-MHz signal on aggressor channel and no signal on victim channel		90		dB	
PSRR	AC power-supply rejection ratio	For 50-mV <sub>PP</sub> signal on AVDD supply		< 30		dB	

(3) Phase and amplitude imbalances onboard must be minimized to obtain good performance.

(4) Dynamic ac characteristics are taken with respect to the 14-bit burst mode, unless otherwise noted.

(5) The minimum value across temperature is ensured by bench characterization.

### DIGITAL CHARACTERISTICS

The dc specifications refer to the condition where the digital outputs are not switching, but are permanently at a valid logic level '0' or '1'. AVDD33 = 3.3 V, AVDD = 1.9 V, and DRVDD = 1.8 V, unless otherwise noted.

PARAMETER		TEST CONDITIONS	MIN	TYP	MAX	UNIT	
<b>DIGITAL INPUTS<sup>(1)</sup> (RESET, SCLK, SDATA, SEN, PDN, SNRB, TRIG_EN)</b>							
V <sub>IH</sub>	High-level input voltage	All digital inputs support 1.8-V logic levels. SPI supports 3.3-V logic levels.	1.25			V	
V <sub>IL</sub>	Low-level input voltage	All digital inputs support 1.8-V logic levels. SPI supports 3.3-V logic levels.			0.45		
I <sub>IH</sub>	High-level input current	RESET, SCLK, PDN, SNRB, TRIG_EN pins	V <sub>HIGH</sub> = 1.8 V	10		μA	
		SEN <sup>(2)</sup> pin	V <sub>HIGH</sub> = 1.8 V	0		μA	
I <sub>IL</sub>	Low-level input current	RESET, SCLK, PDN, SNRB, TRIG_EN pins	V <sub>LOW</sub> = 0 V	0		μA	
		SEN pin	V <sub>LOW</sub> = 0 V	10		μA	
<b>DIGITAL OUTPUTS (SDOUT, HIRES, TRIG_RDY)</b>							
V <sub>OH</sub>	High-level output voltage		DRVDD – 0.1	DRVDD		V	
V <sub>OL</sub>	Low-level output voltage			0	0.1	V	
<b>DIGITAL OUTPUTS, LVDS INTERFACE (DAB[13:0]P, DAB[13:0]M, DCD[13:0]P, DCD[13:0]M, CLKOUTABP, CLKOUTABM, CLKOUTCDP, CLKOUTCDM)</b>							
V <sub>ODH</sub>	Output differential voltage	High <sup>(3)</sup>	Standard-swing LVDS	270	350	465	mV
V <sub>ODL</sub>		Low	Standard-swing LVDS	–465	–350	–270	mV
V <sub>OCM</sub>	Output common-mode voltage			1.05		V	

- (1) RESET, SDATA, SCLK, TRIG\_EN, and SNRB have an internal 150-kΩ pull-down resistor.
- (2) SEN has an internal 150-kΩ pull-up resistor to DRVDD.
- (3) With an external 100-Ω termination.

## TIMING REQUIREMENTS<sup>(1)</sup>

Typical values are at +25°C, AVDD33 = 3.3 V, AVDD = 1.9 V, DRVDD = 1.8 V, sine-wave input clock, C<sub>LOAD</sub> = 3.3 pF<sup>(2)</sup>, and R<sub>LOAD</sub> = 100 Ω<sup>(3)</sup>, unless otherwise noted.

Minimum and maximum values are across the full temperature range of T<sub>MIN</sub> = –40°C to T<sub>MAX</sub> = +85°C.

PARAMETER	TEST CONDITIONS	MIN	TYP	MAX	UNIT		
t <sub>A</sub>	Aperture delay	0.7	1.2	1.6	ns		
	Aperture delay matching	Between any two channels of the same device			ps		
	Variation of aperture delay	Between two devices at the same temperature and DRVDD supply			ps		
t <sub>J</sub>	Aperture jitter		140		fs rms		
Wake up time	Time to valid data after coming out of global power down		100		μs		
	Time to valid data after coming out of channel power down		10		μs		
ADC latency <sup>(4)(5)</sup>	Default latency in 11-bit mode		10		Output clock cycles		
	Digital gain enabled		13		Output clock cycles		
	Digital gain and offset correction enabled		14		Output clock cycles		
	SNRBoost <sup>3G+</sup> (90-MHz BW) enabled alone		13		Output clock cycles		
	SNRBoost <sup>3G+</sup> (90-MHz BW), digital gain, and offset correction enabled		17		Output clock cycles		
	SNRBoost <sup>3G+</sup> (45-MHz BW) enabled alone		15		Output clock cycles		
	SNRBoost <sup>3G+</sup> (45-MHz BW), digital gain, and offset correction enabled		19		Output clock cycles		
<b>OUTPUT TIMING<sup>(6)</sup></b>							
t <sub>SU</sub>	Data setup time <sup>(7)(8)(9)</sup>	Data valid to CLKOUTxxP zero-crossing		0.6	0.85	ns	
t <sub>H</sub>	Data hold time <sup>(7)(8)(9)</sup>	CLKOUTxxP zero-crossing to data becoming invalid		0.6	0.84	ns	
	LVDS bit clock duty cycle	Differential clock duty cycle (CLKOUTxxP – CLKOUTxxM)		50%			
t <sub>PDI</sub>	Clock propagation delay <sup>(5)</sup>	Input clock falling edge cross-over to output clock falling edge cross-over, 184 MSPS ≤ sampling frequency ≤ 250 MSPS		0.25 × t <sub>S</sub> + t <sub>delay</sub>		ns	
t <sub>delay</sub>	Delay time	Input clock falling edge cross-over to output clock falling edge cross-over, 184 MSPS ≤ sampling frequency ≤ 250 MSPS		6.9	8.65	10.5	ns
t <sub>RISE</sub> , t <sub>FALL</sub>	Data rise and fall time	Rise time measured from –100 mV to +100 mV		0.1		ns	
t <sub>CLKRISE</sub> , t <sub>CLKFALL</sub>	Output clock rise and fall time	Rise time measured from –100 mV to +100 mV		0.1		ns	

(1) Timing parameters are ensured by design and characterization and are not tested in production.

(2) C<sub>LOAD</sub> is the effective external single-ended load capacitance between each output pin and ground.

(3) R<sub>LOAD</sub> is the differential load resistance between the LVDS output pair.

(4) ADC latency is given for channels B and D. For channels A and C, latency reduces by half of the output clock cycles.

(5) Overall latency = ADC latency + t<sub>PDI</sub>.

(6) Measurements are done with a transmission line of 100-Ω characteristic impedance between the device and load. Setup and hold time specifications take into account the effect of jitter on the output data and clock.

(7) Data valid refers to a logic high of +100 mV and a logic low of –100 mV.

(8) Note that these numbers are taken with delayed output clocks by writing the following registers: **address A9h, value 02h; and address ACh, value 60h**. Refer to the [Serial Interface Registers](#) section. By default after reset, minimum setup time and minimum hold times are 520 ps each.

(9) The setup and hold times of a channel are measured with respect to the same channel output clock.

**Table 2. LVDS Timings Across Lower Sampling Frequencies**

SAMPLING FREQUENCY (MSPS)	SETUP TIME (ns)			HOLD TIME (ns)		
	MIN	TYP	MAX	MIN	TYP	MAX
210	0.89	1.03		0.82	1.01	
185	1.06	1.21		0.95	1.15	

PARAMETRIC MEASUREMENT INFORMATION

LVDS OUTPUT TIMING

Figure 1 shows a timing diagram of the LVDS output voltage levels. Figure 2 shows the latency described in the Timing Requirements table.

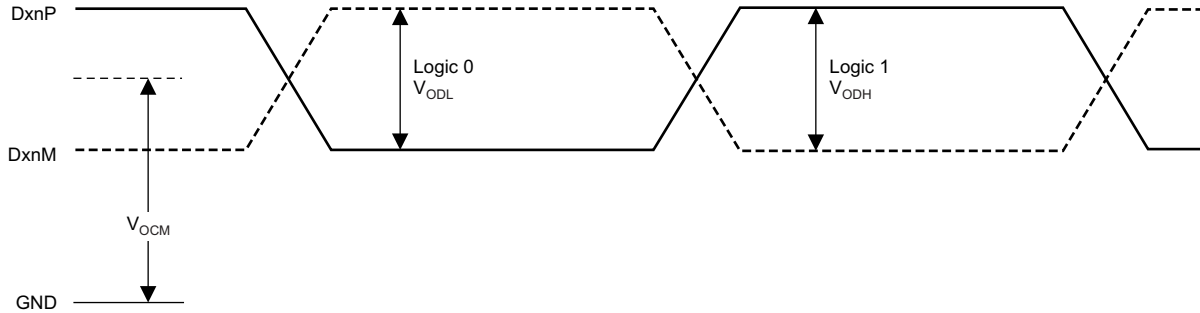

Figure 1. LVDS Output Voltage Levels

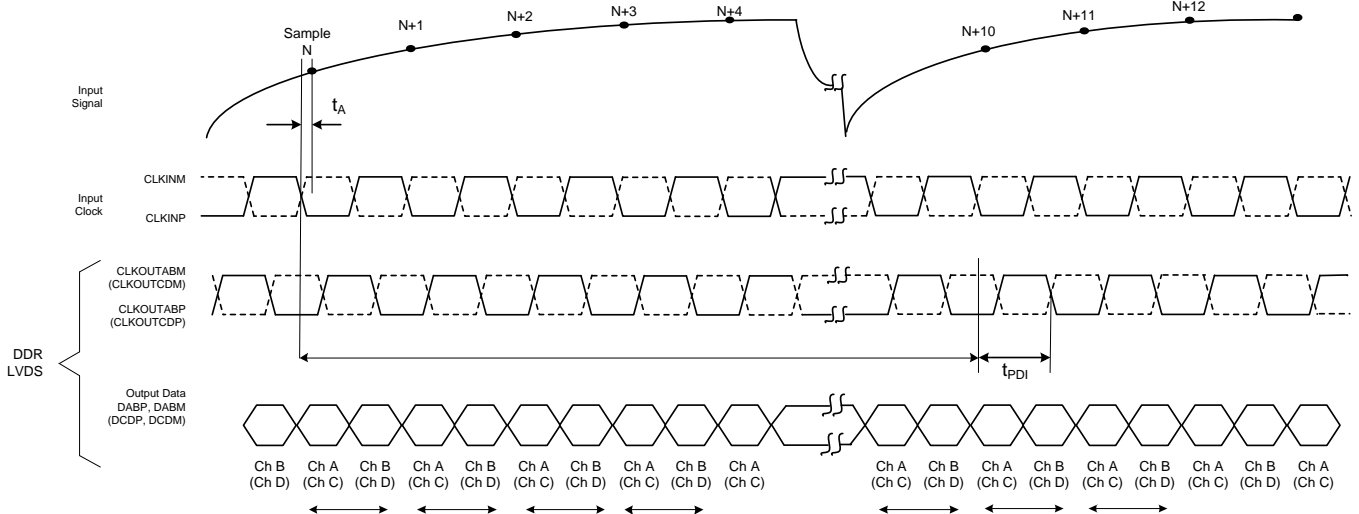
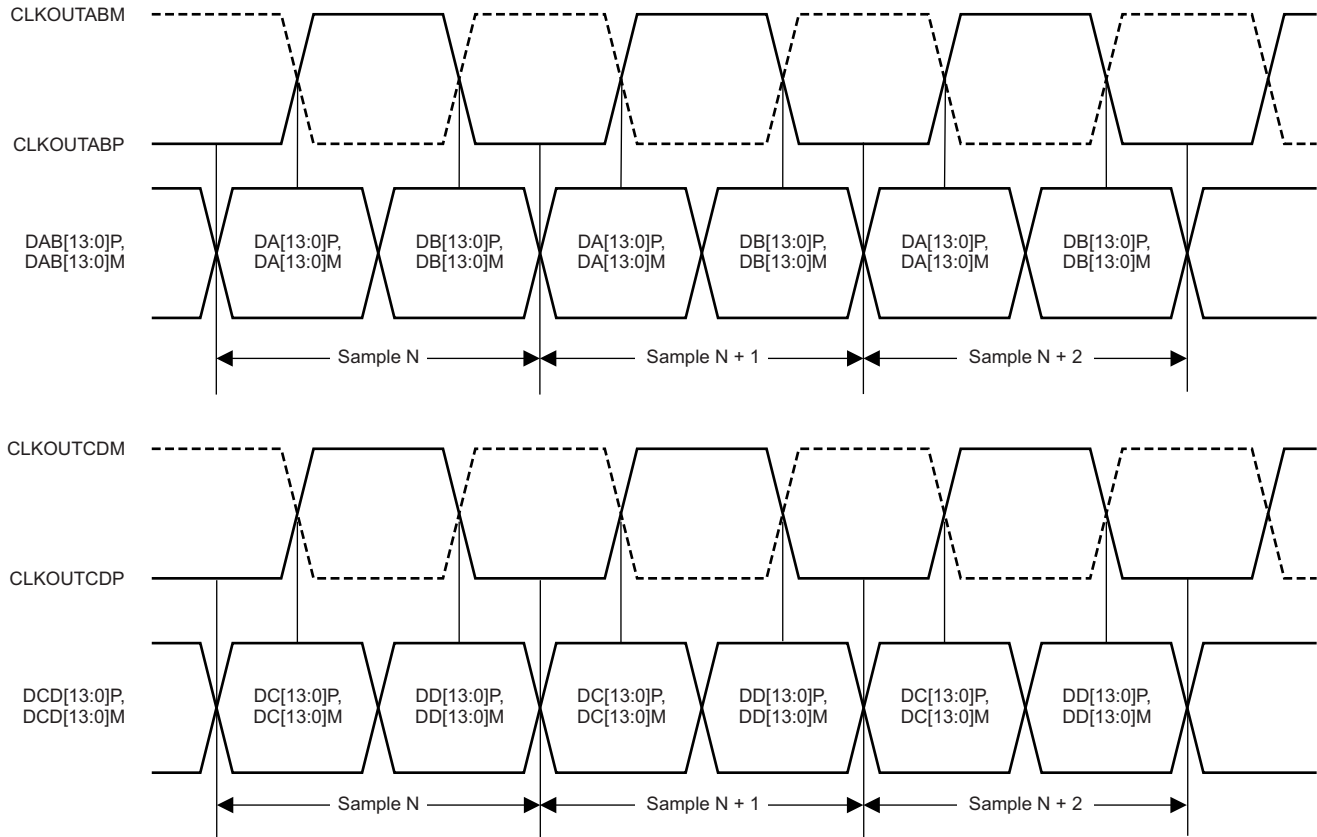

Figure 2. Latency Timing



**PARAMETRIC MEASUREMENT INFORMATION (continued)**

All 14 data bits of one channel (11 data bits in default SNRBoost<sup>3G+</sup> mode) are included in the digital output interface at the same time, as shown in Figure 3. Channel A and C data are output on the rising edge of the output clock while channels B and D are output on the falling edge of the output clock.



**Figure 3. LVDS Output Interface Timing**

**PIN CONFIGURATION**

**ZCR PACKAGE  
BGA-144  
(TOP VIEW)**

	1	2	3	4	5	6	7	8	9	10	11	12
A	AVDD	AVDD	CINM	CINP	AVDD	VCM	VCM	AVDD	BINM	BINP	AVDD	AVDD
B	DINP	AVSS	AVDD	AVDD	AVSS	AVDD33	AVDD33	AVSS	AVDD	AVDD	AVSS	AINM
C	DINM	AVSS	AVSS	AVSS	AVSS	CLKINM	CLKINP	AVSS	AVSS	AVSS	AVSS	AINP
D	AVDD	AVDD	VCM	AVSS	AVSS	AVSS	AVSS	AVSS	AVSS	VCM	AVDD	AVDD
E	AVDD33	AVDD33	SNRB	DRVSS	DRVSS	DRVSS	DRVSS	DRVSS	DRVSS	PDN	AVDD33	AVDD33
F	DCD13M	DCD13P	DRVDD	DRVSS	DRVSS	DRVSS	DRVSS	DRVSS	DRVSS	DRVDD	DAB13P	DAB13M
G	DCD12M	DCD12P	TRIG_EN	TRIG_RDY	HIRES	RESET	SCLK	SDATA	SEN	SDOUT	DAB12P	DAB12M
H	DCD11M	DCD11P	DCD6P	DCD6M	DRVDD	DRVDD	DRVDD	DRVDD	DAB6M	DAB6P	DAB11P	DAB11M
J	DCD10M	DCD10P	DCD5P	DCD5M	DCD2P	DRVDD	DRVDD	DAB2M	DAB5M	DAB5P	DAB10P	DAB10M
K	DCD9M	DCD9P	DCD4P	DCD4M	DCD2M	DRVDD	DRVDD	DAB2P	DAB4M	DAB4P	DAB9P	DAB9M
L	DCD8M	DCD8P	DCD3P	DCD3M	DCD1P	DCD1M	DAB1M	DAB1P	DAB3M	DAB3P	DAB8P	DAB8M
M	DCD7M	DCD7P	CLKOUT CDP	CLKOUT CDM	DCD0P/ OVRCDP	DCD0M/ OVRCDM	DAB0M/ OVRABM	DAB0P/ OVRABP	CLKOUT ABM	CLKOUT ABP	DAB7P	DAB7M

**PIN FUNCTIONS**

PIN		I/O	DESCRIPTION
NAME	NUMBER		
AINM	B12	I	Negative differential analog input for channel A
AINP	C12	I	Positive differential analog input for channel A
AVDD33	B6, B7, E1, E2, E11, E12	I	Analog 3.3-V power supply
AVDD	A1, A2, A5, A8, A11, A12, B3, B4, B9, B10, D1, D2, D11, D12	I	Analog 1.9-V power supply
AVSS	B2, B5, B8, B11, C2-C5, C8-C11, D4-D9	I	Analog ground
BINM	A9	I	Negative differential analog input for channel B
BINP	A10	I	Positive differential analog input for channel B
CINM	A3	I	Negative differential analog input for channel C
CINP	A4	I	Positive differential analog input for channel C
CLKINM	C6	I	Negative differential clock input
CLKINP	C7	I	Positive differential clock input
CLKOUTABM	M9	O	Negative differential LVDS clock output for channel A and B
CLKOUTABP	M10	O	Positive differential LVDS clock output for channel A and B
CLKOUTCDM	M4	O	Negative differential LVDS clock output for channels C and D
CLKOUTCDP	M3	O	Positive differential LVDS clock output for channels C and D
DAB[13:1]P, DAB0P/OVRABP, DAB[13:1]M, DAB0M/OVRABM	F11, F12, G11, G12, H9-H12, J8-J12, K8-K12, L7-L12, M7, M8, M11, M12	O	DDR LVDS outputs for channels A and B. In 11-bit mode, DAB13 is the MSB, DAB3 is the LSB, and DAB0 is the over-range (OVR) bit. In 14-bit burst mode, DAB13 is the MSB and DAB0 is the LSB. There is no OVR bit in this mode.
DCD[13:1]P, DCD0P/OVRCDP, DCD[13:1]M, DCD0M/OVRCDM	F1, F2, G1, G2, H1-H4, J1-J5, K1-K5, L1-L6, M1, M2, M5, M6	O	DDR LVDS outputs for channels C and D. In 11-bit mode, DCD13 is the MSB, DCD3 is the LSB, and DCD0 is the OVR bit. In 14-bit burst mode, DCD13 is the MSB and DCD0 is the LSB. There is no OVR bit in this mode.
DINM	C1	I	Negative differential analog input for channel D
DINP	B1	I	Positive differential analog input for channel D
DRVDD	F3, F10, H5-H8, J6, J7, K6, K7	I	Digital 1.8-V power supply
DRVSS	E4-E9, F4-F9	I	Digital ground
HIRES	G5	O	Indication in burst mode if output data is high or low resolution
PDN	E10	I	Power-down control; active high. Logic high is power down.
RESET	G6	I	Hardware reset; active high
SCLK	G7	I	Serial interface clock input
SDATA	G8	I	Serial interface data input
SDOUT	G10	O	Serial interface data output
SEN	G9	I	Serial interface enable
SNRB	E3	I	SNRB enable; active high
TRIG_EN	G3	I	Trigger burst mode; active high
TRIG_RDY	G4	O	Indication if ADC is ready for another high-resolution burst mode
VCM	A6, A7, D3, D10	O	Common-mode voltage for analog inputs. All VCM pins are internally connected together.

**FUNCTIONAL BLOCK DIAGRAM**

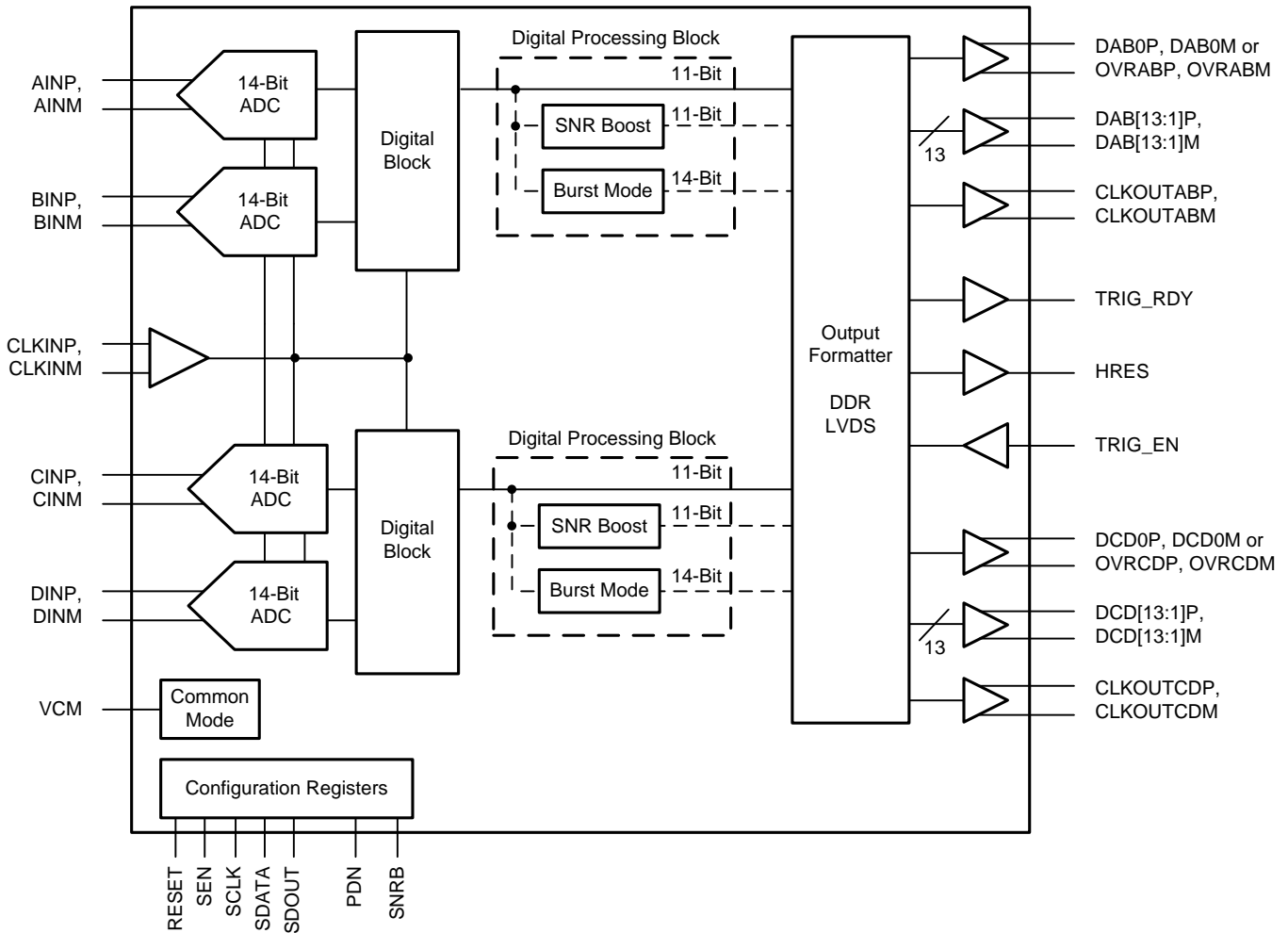

**TYPICAL CHARACTERISTICS**

At +25°C, AVDD = 1.9 V, AVDD3V = 3.3 V, DRVDD = 1.8 V, rated sampling frequency, 0-dB gain, 14-bit burst mode, sine wave input clock, 1.5-V<sub>PP</sub> differential clock amplitude, 50% clock duty cycle, -1-dBFS differential analog input, DDR LVDS output interface, and 32k-point FFT, unless otherwise noted.

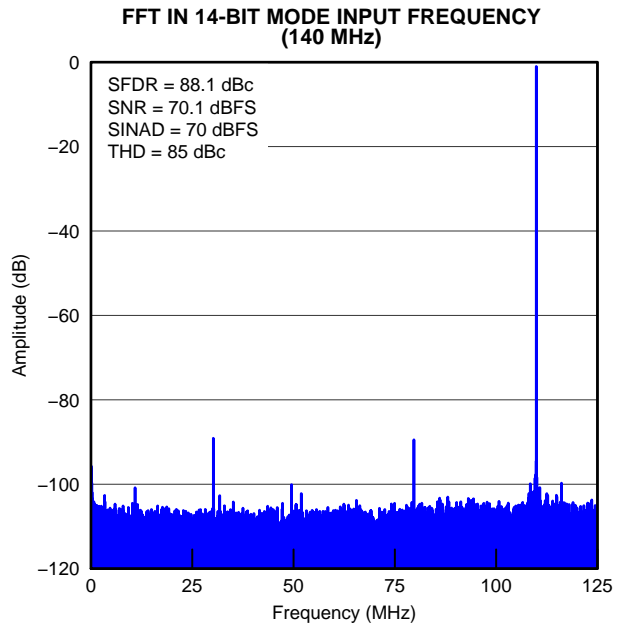

Figure 4.

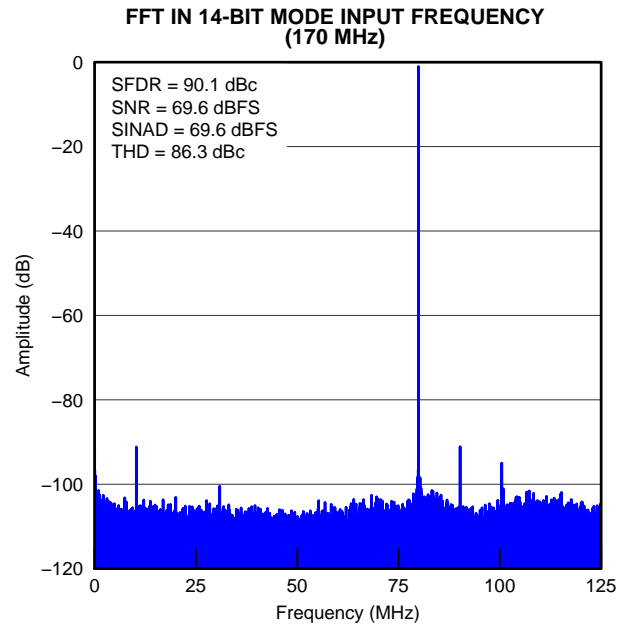

Figure 5.

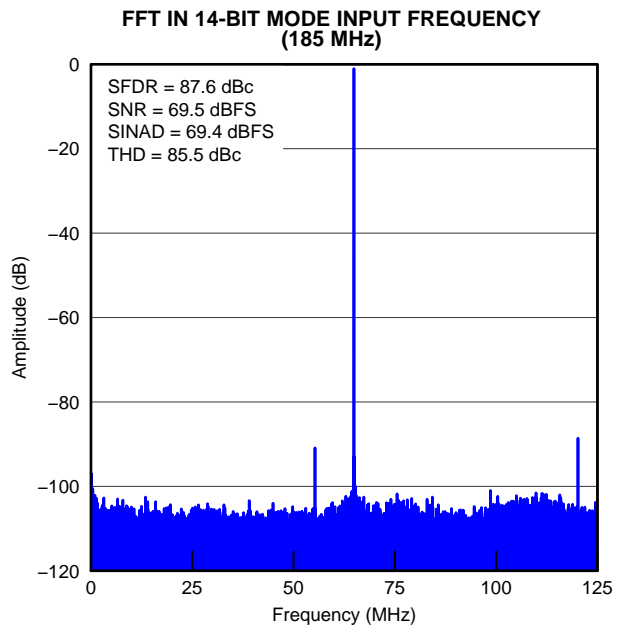

Figure 6.

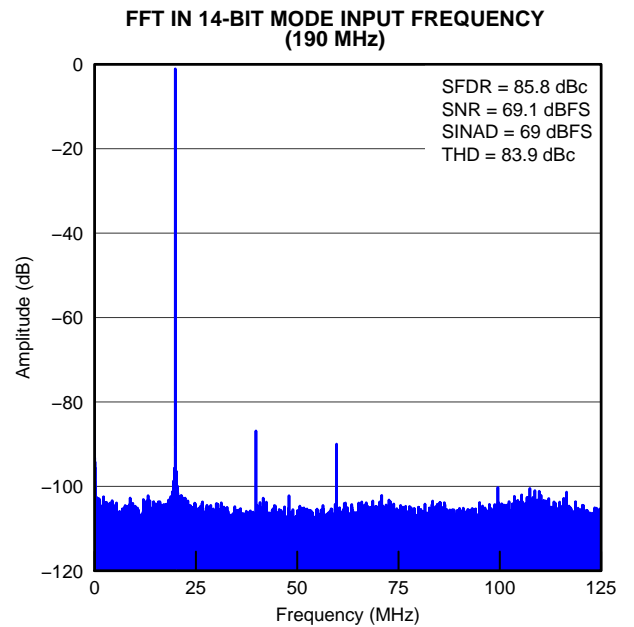

Figure 7.

**TYPICAL CHARACTERISTICS (continued)**

At +25°C, AVDD = 1.9 V, AVDD3V = 3.3 V, DRVDD = 1.8 V, rated sampling frequency, 0-dB gain, 14-bit burst mode, sine wave input clock, 1.5-V<sub>PP</sub> differential clock amplitude, 50% clock duty cycle, -1-dBFS differential analog input, DDR LVDS output interface, and 32k-point FFT, unless otherwise noted.

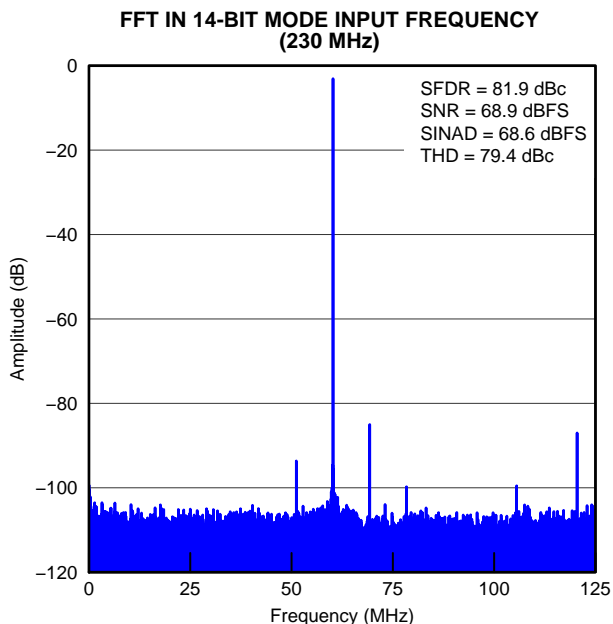

Figure 8.

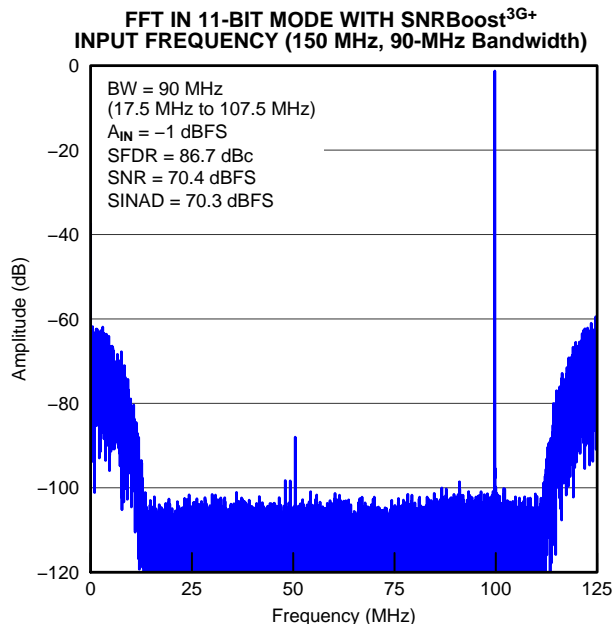

Figure 9.

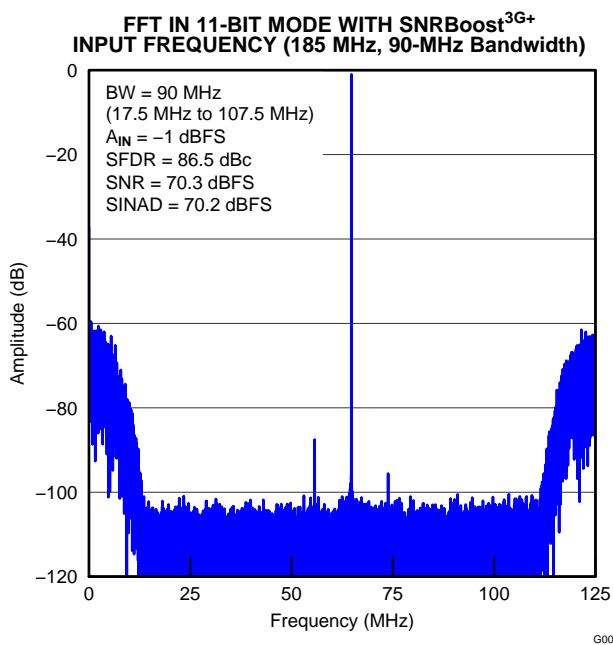

Figure 10.

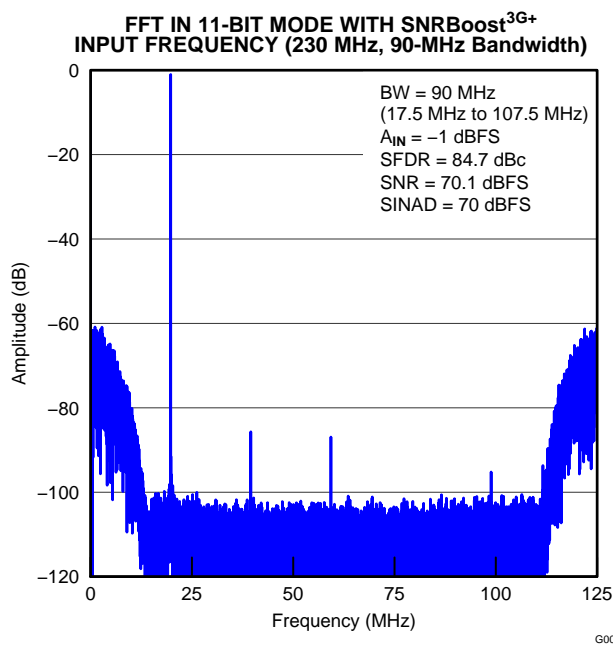
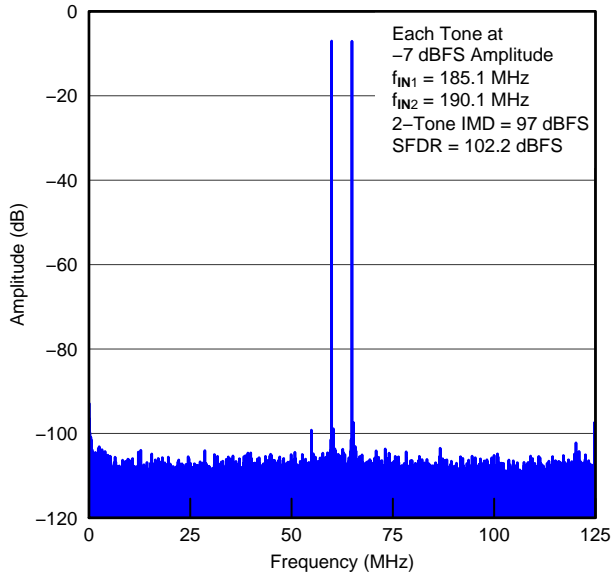

Figure 11.

**TYPICAL CHARACTERISTICS (continued)**

At +25°C, AVDD = 1.9 V, AVDD3V = 3.3 V, DRVDD = 1.8 V, rated sampling frequency, 0-dB gain, 14-bit burst mode, sine wave input clock, 1.5-V<sub>PP</sub> differential clock amplitude, 50% clock duty cycle, -1-dBFS differential analog input, DDR LVDS output interface, and 32k-point FFT, unless otherwise noted.

**FFT FOR -7-dBFS, TWO-TONE INPUT SIGNAL IN 14-BIT MODE**



**Figure 12.**

**FFT FOR -36-dBFS, TWO-TONE INPUT SIGNAL IN 14-BIT MODE**

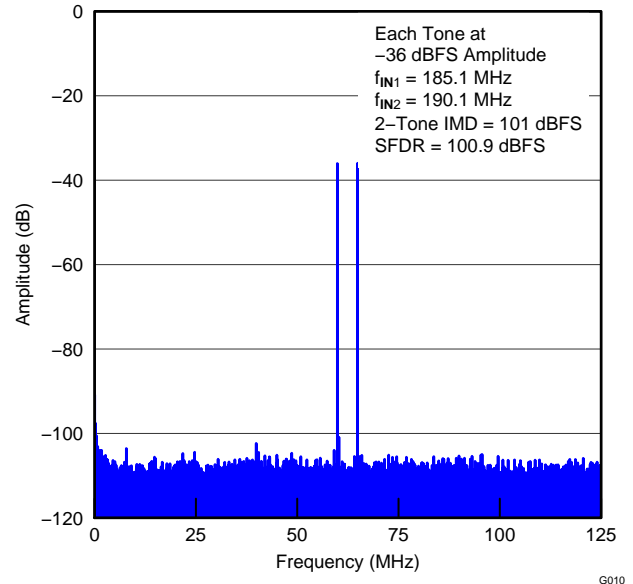

**Figure 13.**

**SPURIOUS-FREE DYNAMIC RANGE vs INPUT FREQUENCY**

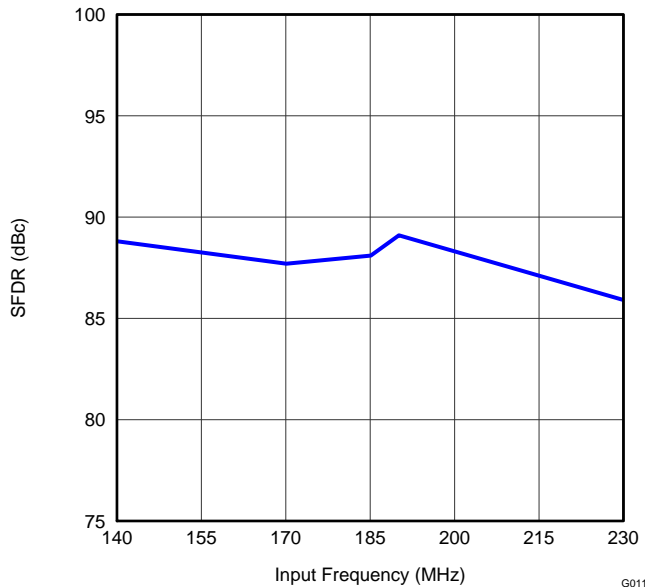

**Figure 14.**

**SIGNAL-TO-NOISE RATIO vs INPUT FREQUENCY**

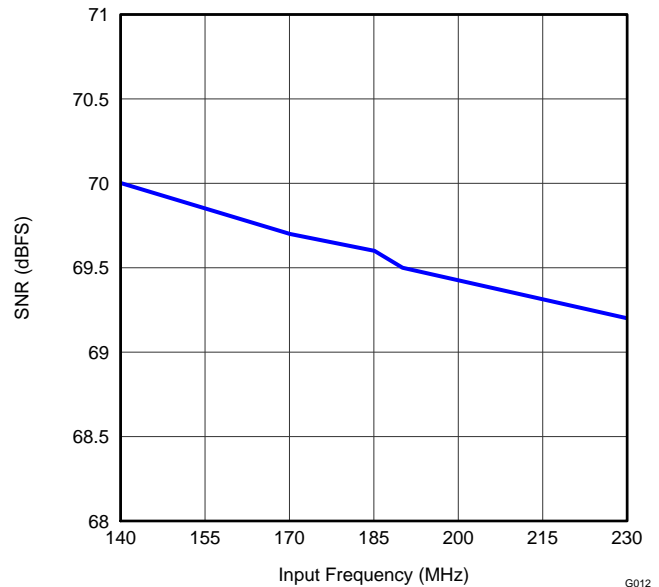

**Figure 15.**

**TYPICAL CHARACTERISTICS (continued)**

At +25°C, AVDD = 1.9 V, AVDD3V = 3.3 V, DRVDD = 1.8 V, rated sampling frequency, 0-dB gain, 14-bit burst mode, sine wave input clock, 1.5-V<sub>PP</sub> differential clock amplitude, 50% clock duty cycle, -1-dBFS differential analog input, DDR LVDS output interface, and 32k-point FFT, unless otherwise noted.

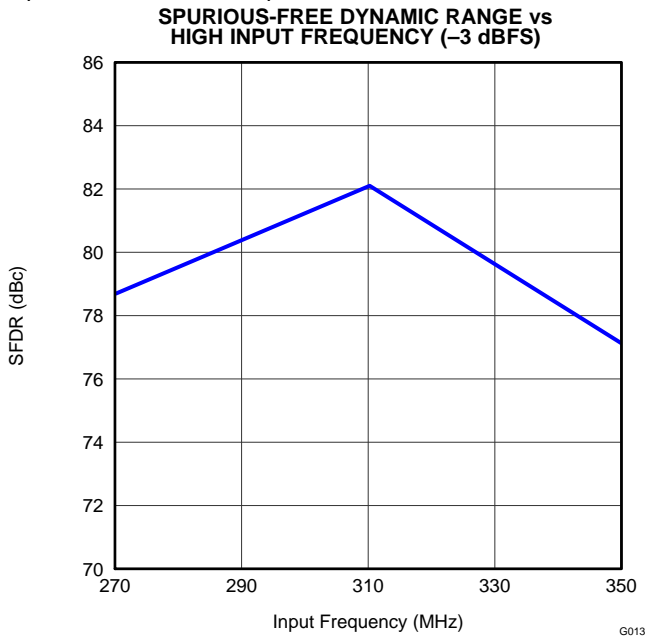

Figure 16.

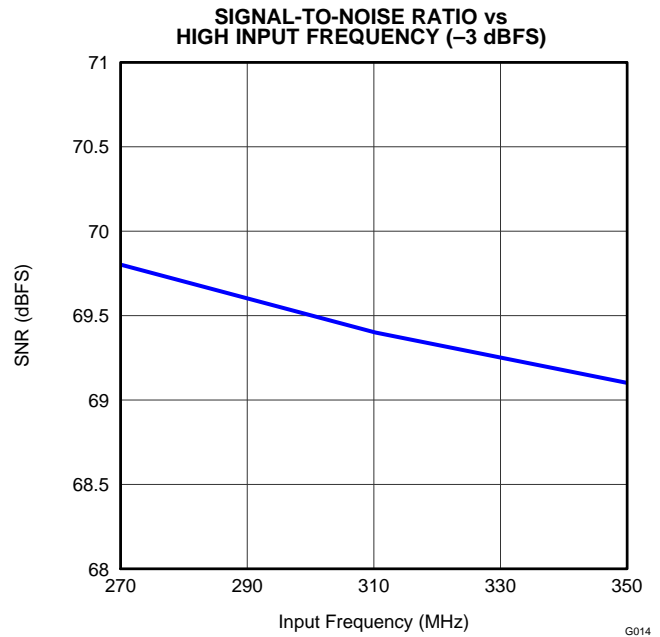

Figure 17.

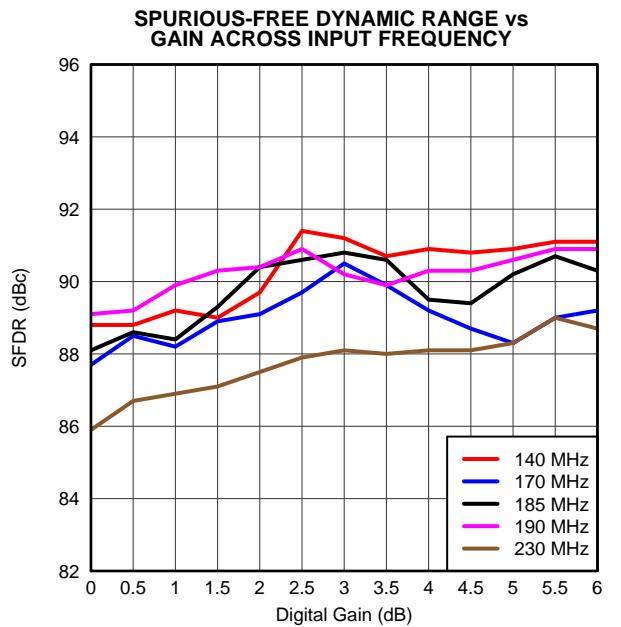

Figure 18.

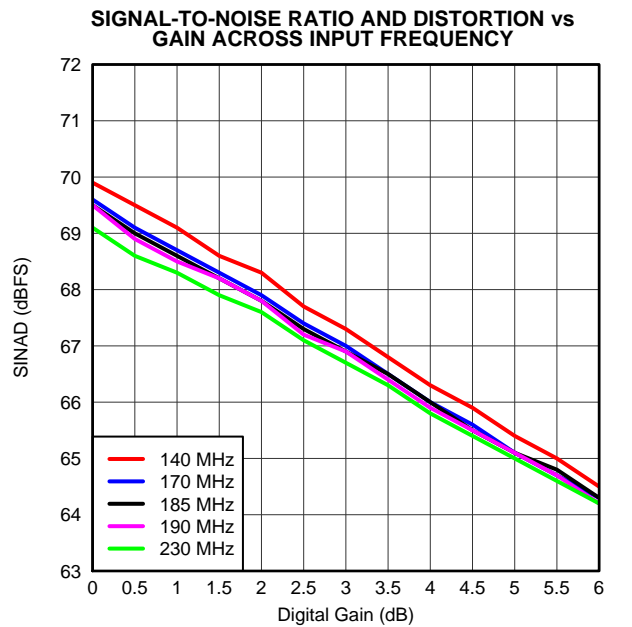

Figure 19.



**TYPICAL CHARACTERISTICS (continued)**

At +25°C, AVDD = 1.9 V, AVDD3V = 3.3 V, DRVDD = 1.8 V, rated sampling frequency, 0-dB gain, 14-bit burst mode, sine wave input clock, 1.5-V<sub>PP</sub> differential clock amplitude, 50% clock duty cycle, -1-dBFS differential analog input, DDR LVDS output interface, and 32k-point FFT, unless otherwise noted.

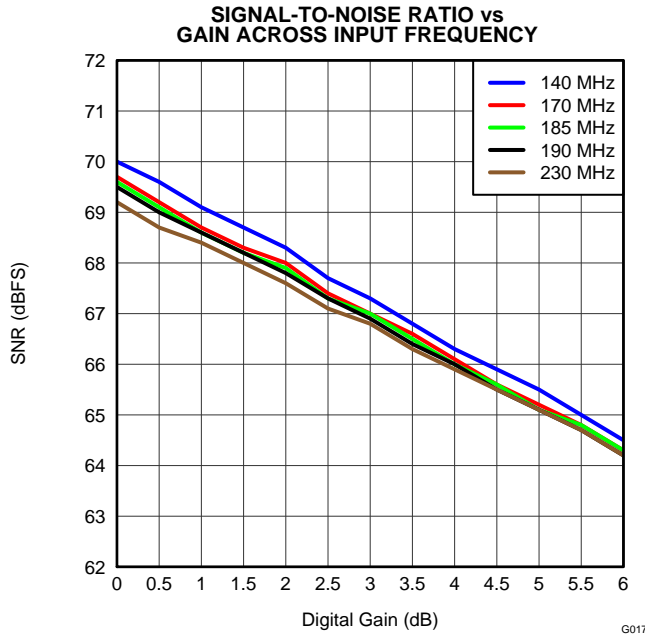

Figure 20.

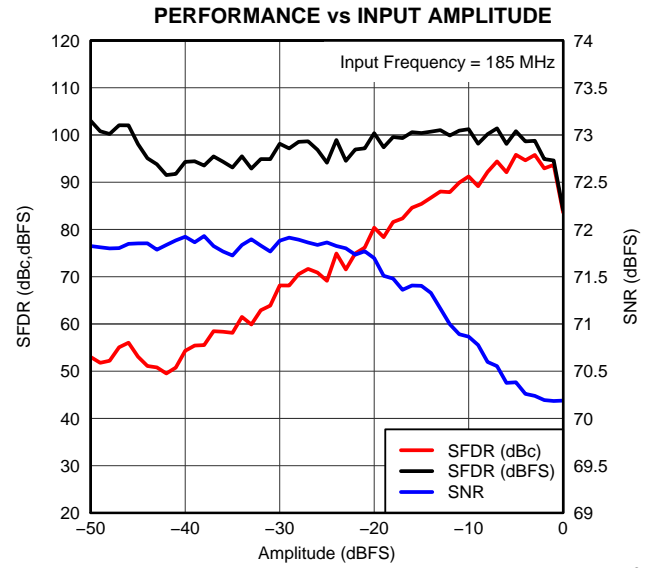

Figure 21.

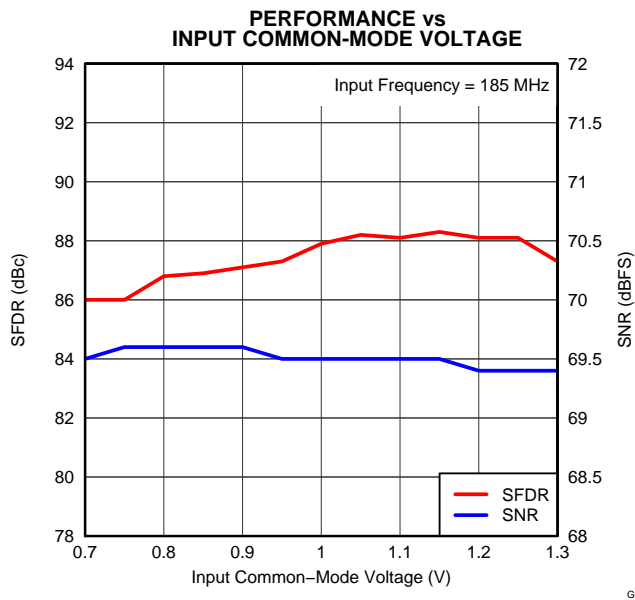

Figure 22.

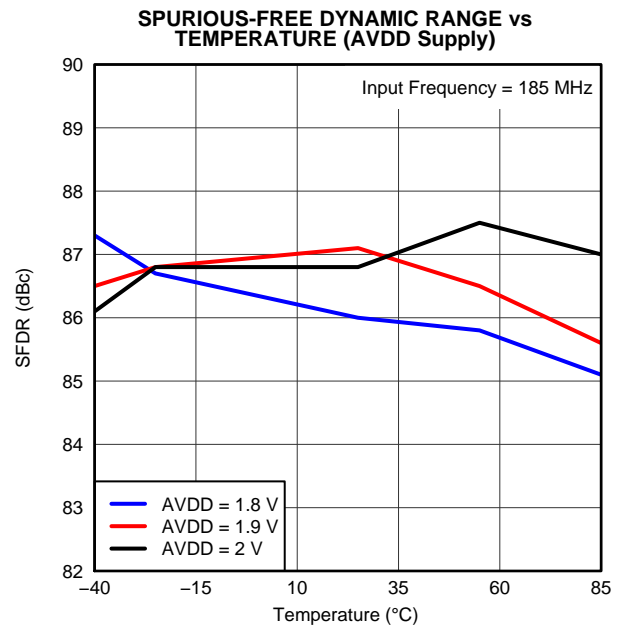

Figure 23.

**TYPICAL CHARACTERISTICS (continued)**

At +25°C, AVDD = 1.9 V, AVDD3V = 3.3 V, DRVDD = 1.8 V, rated sampling frequency, 0-dB gain, 14-bit burst mode, sine wave input clock, 1.5-V<sub>PP</sub> differential clock amplitude, 50% clock duty cycle, -1-dBFS differential analog input, DDR LVDS output interface, and 32k-point FFT, unless otherwise noted.

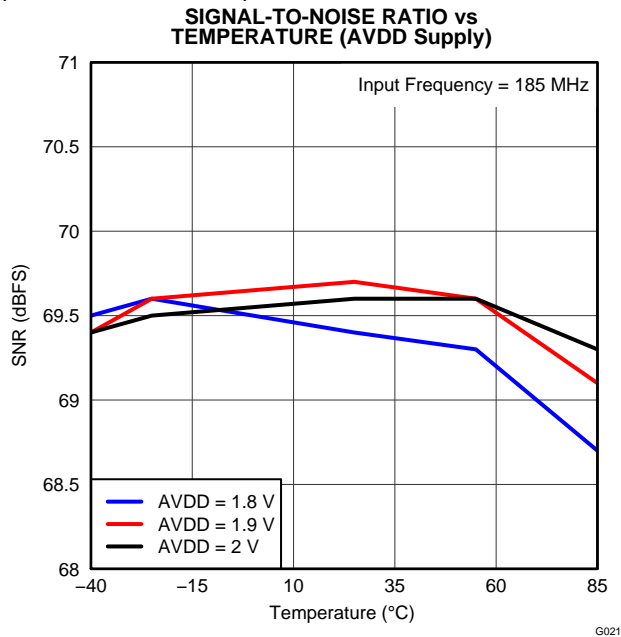

Figure 24.

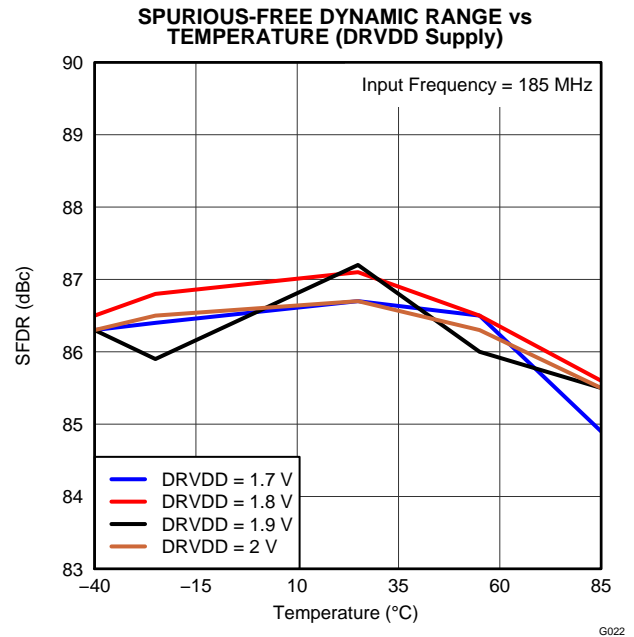

Figure 25.

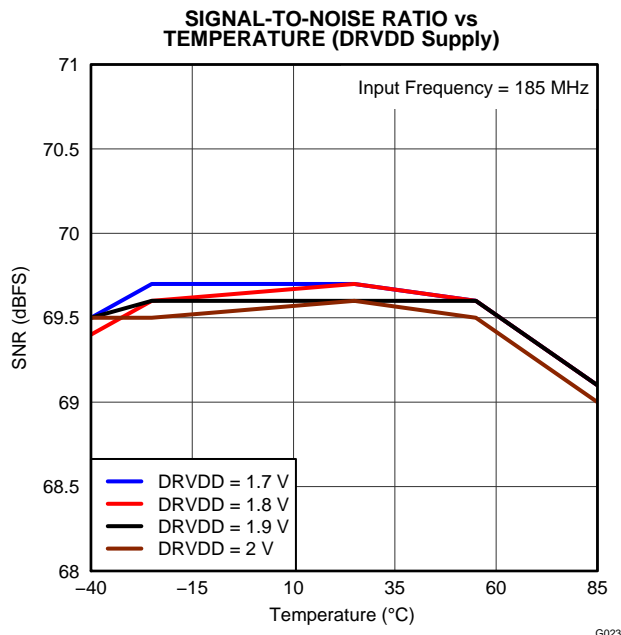

Figure 26.

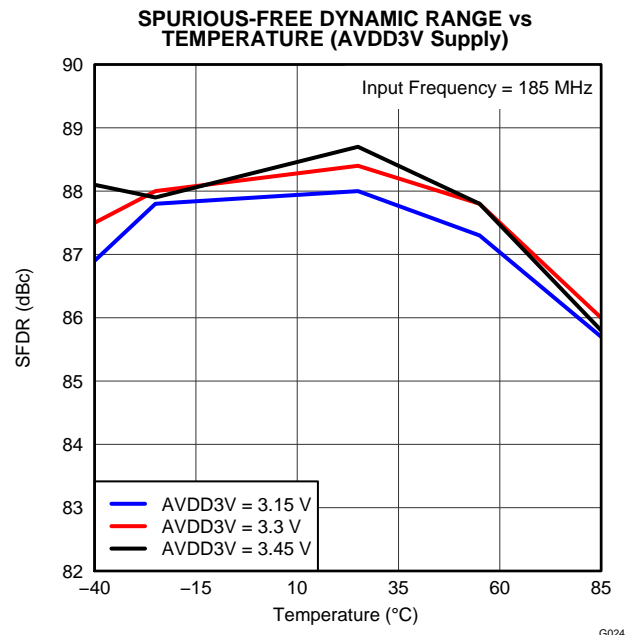

Figure 27.

**TYPICAL CHARACTERISTICS (continued)**

At +25°C, AVDD = 1.9 V, AVDD3V = 3.3 V, DRVDD = 1.8 V, rated sampling frequency, 0-dB gain, 14-bit burst mode, sine wave input clock, 1.5-V<sub>PP</sub> differential clock amplitude, 50% clock duty cycle, -1-dBFS differential analog input, DDR LVDS output interface, and 32k-point FFT, unless otherwise noted.

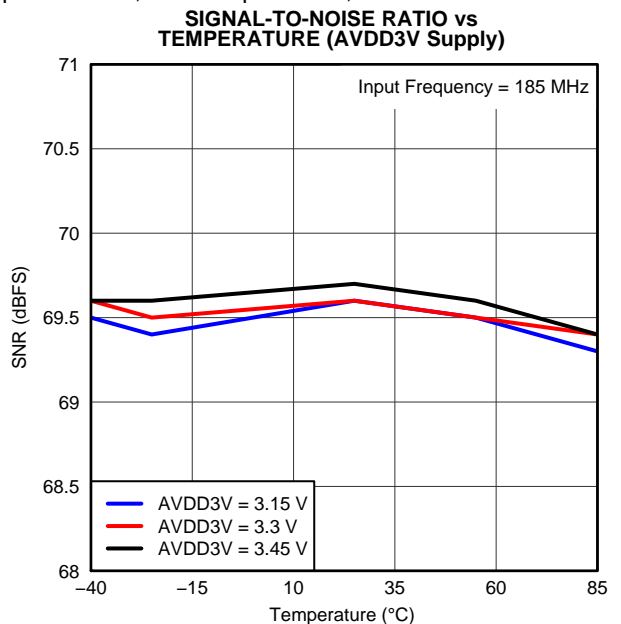

Figure 28.

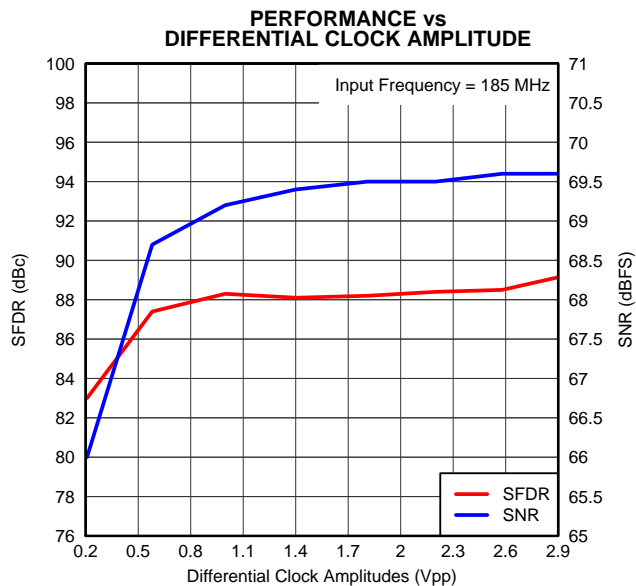

Figure 29.

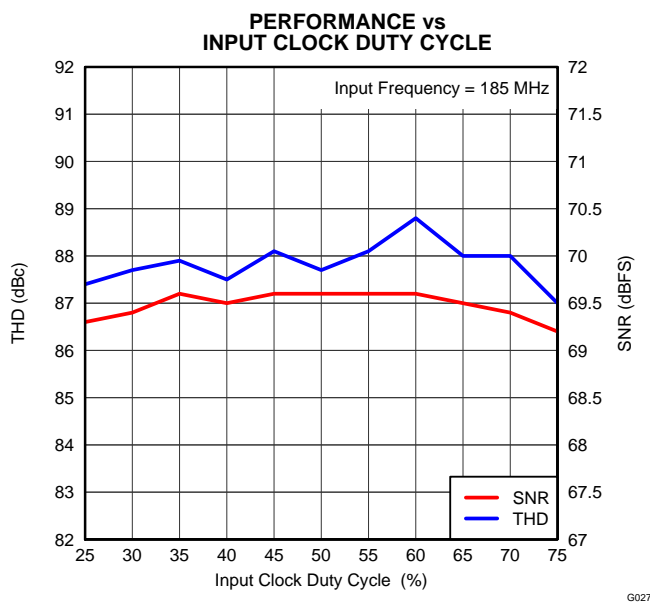

Figure 30.

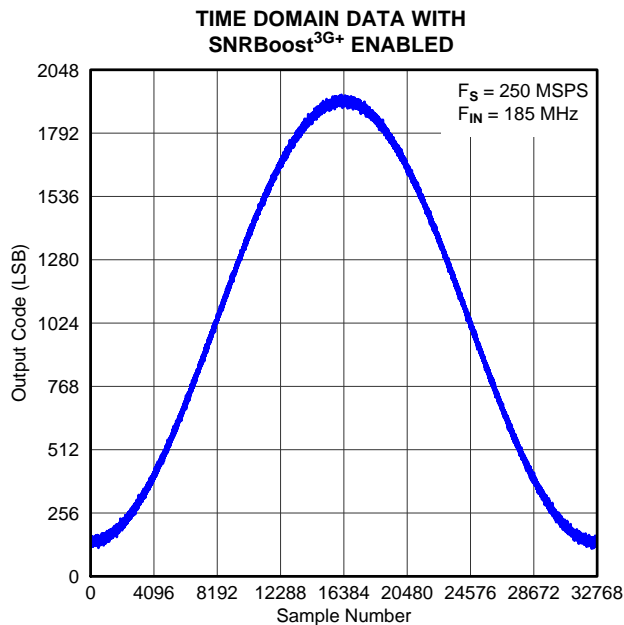

Figure 31.

**TYPICAL CHARACTERISTICS (continued)**

At +25°C, AVDD = 1.9 V, AVDD3V = 3.3 V, DRVDD = 1.8 V, rated sampling frequency, 0-dB gain, 14-bit burst mode, sine wave input clock, 1.5-V<sub>PP</sub> differential clock amplitude, 50% clock duty cycle, -1-dBFS differential analog input, DDR LVDS output interface, and 32k-point FFT, unless otherwise noted.

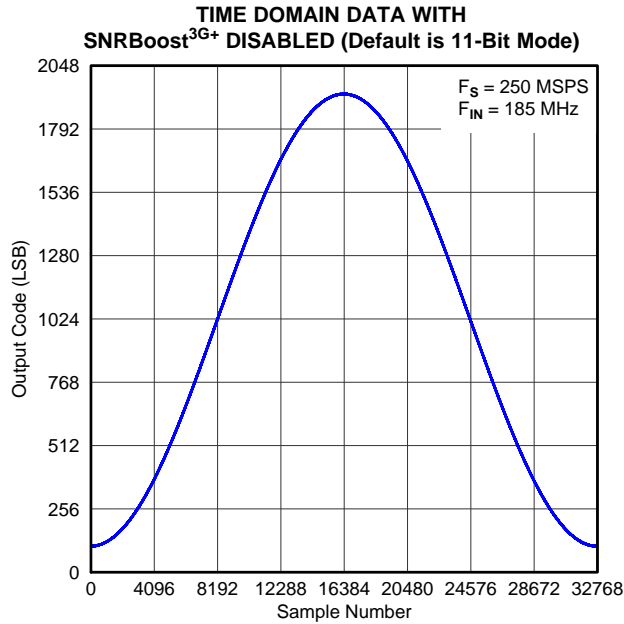

Figure 32.

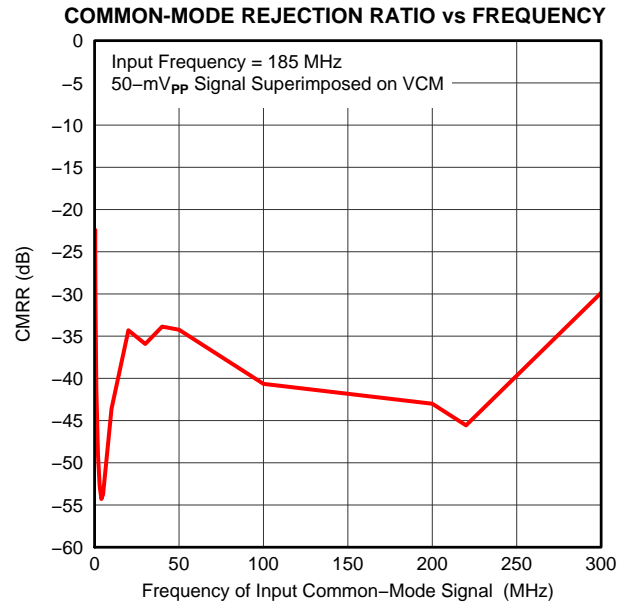

Figure 33.

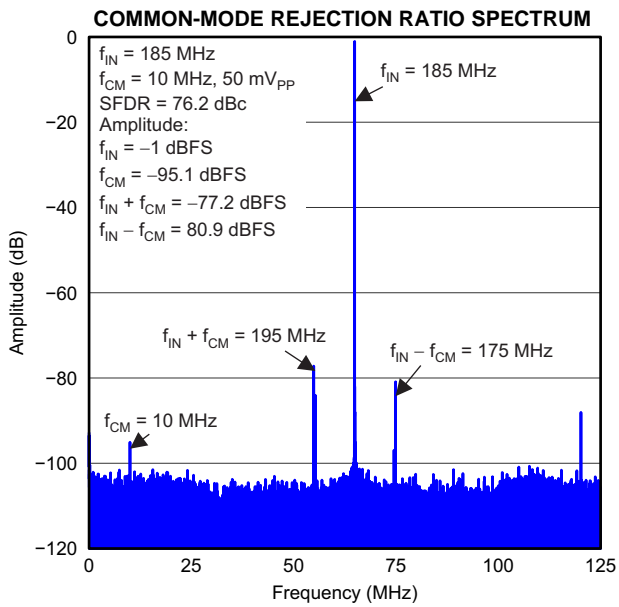

Figure 34.

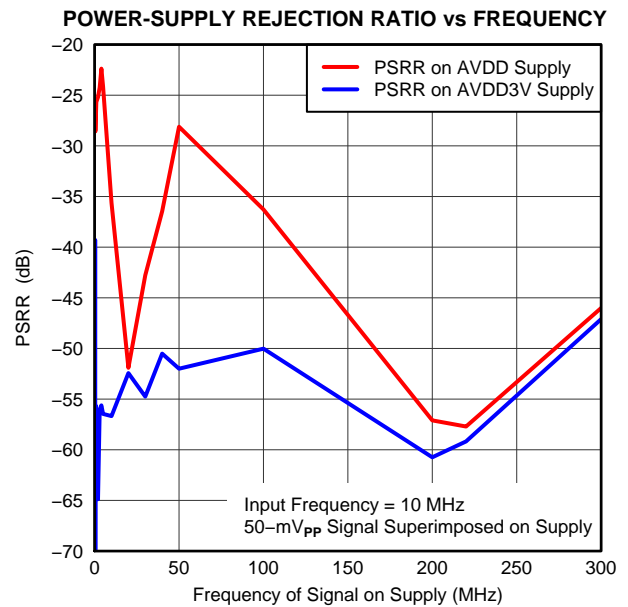

Figure 35.

**TYPICAL CHARACTERISTICS (continued)**

At +25°C, AVDD = 1.9 V, AVDD3V = 3.3 V, DRVDD = 1.8 V, rated sampling frequency, 0-dB gain, 14-bit burst mode, sine wave input clock, 1.5-V<sub>PP</sub> differential clock amplitude, 50% clock duty cycle, -1-dBFS differential analog input, DDR LVDS output interface, and 32k-point FFT, unless otherwise noted.

**ZOOMED VIEW OF POWER-SUPPLY REJECTION RATIO SPECTRUM**

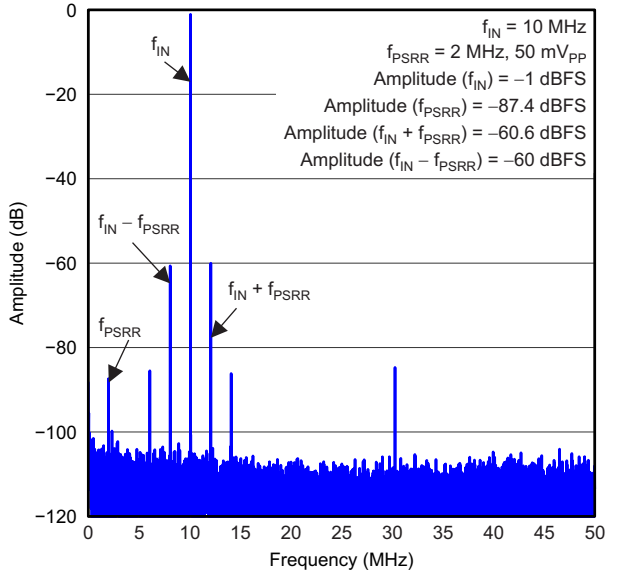

Figure 36.

**TOTAL POWER vs SAMPLING RATE**

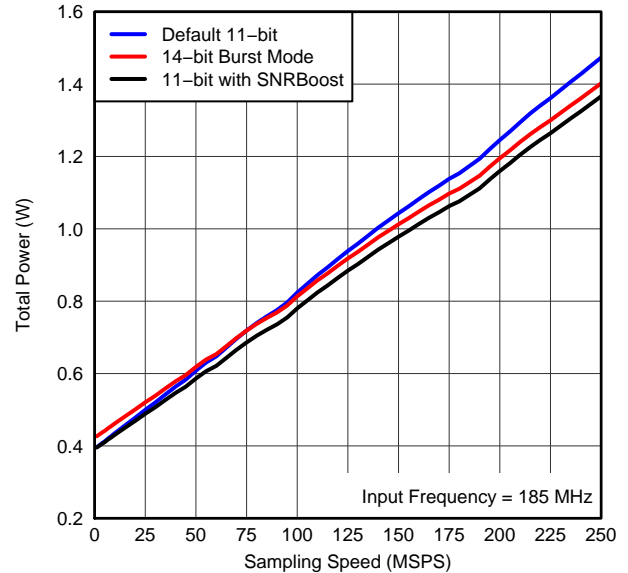

Figure 37.

**ANALOG POWER vs SAMPLING RATE**

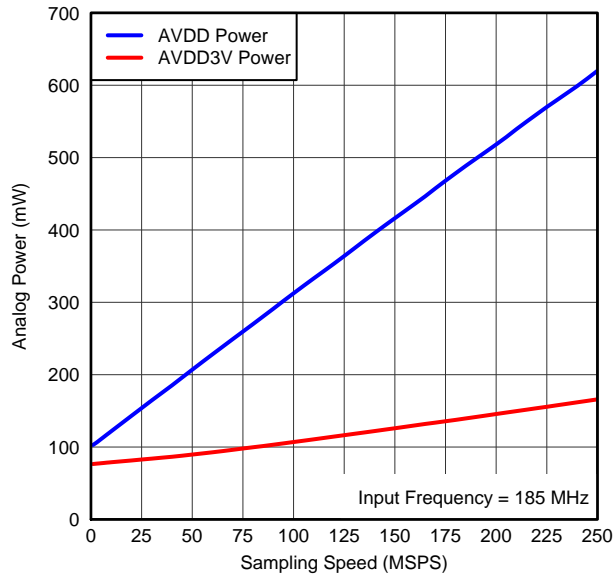

Figure 38.

**DRVDD POWER vs SAMPLING RATE IN VARIOUS DIGITAL MODES**

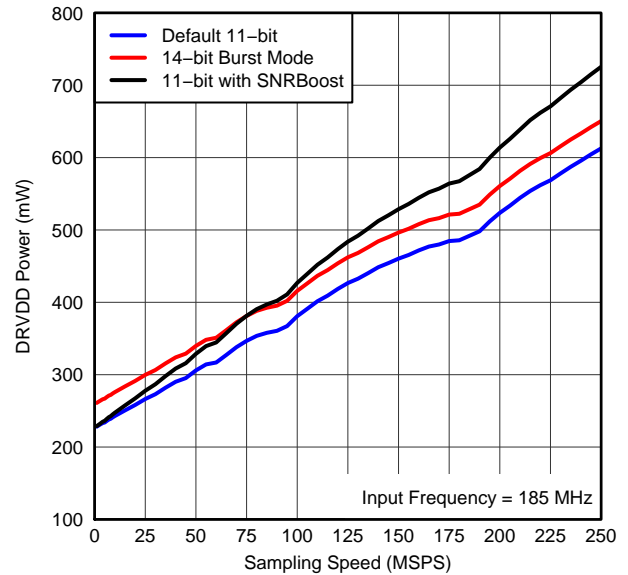

Figure 39.

## DEVICE CONFIGURATION

The ADS58H40 can be configured with a serial programming interface (SPI), as described in the [Serial Interface](#) section. In addition, the device has control pins that control power-down and SNRBoost<sup>3G+</sup> operation.

### SERIAL INTERFACE

The ADC has a set of internal registers that can be accessed by the serial interface formed by the SEN (serial interface enable), SCLK (serial interface clock), SDATA (serial interface input data), and SDOUT (serial interface read back data) pins. The serial shift of bits into the device is enabled when SEN is low. Serial data (SDATA) are latched at every SCLK falling edge when SEN is active (low). The serial data are loaded into the register at every 16th SCLK falling edge when SEN is low. When the word length exceeds a multiple of 16 bits, the excess bits are ignored. Data can be loaded in multiples of 16-bit words within a single active SEN pulse. The first eight bits form the register address and the remaining eight bits are the register data. The interface can function with SCLK frequencies from 20 MHz down to very low speeds (of a few hertz) and also with a non-50% SCLK duty cycle.

### Register Initialization

After power-up, the internal registers must be initialized to the default values. This initialization can be accomplished in one of two ways:

1. Either through a hardware reset by applying a high pulse on the RESET pin (of widths greater than 10 ns), as shown in [Figure 40](#); or
2. By applying a software reset. When using the serial interface, set the RESET bit (D1 in register 00h) high. This setting initializes the internal registers to the default values and then self-resets the RESET bit low. In this case, the RESET pin is kept low.

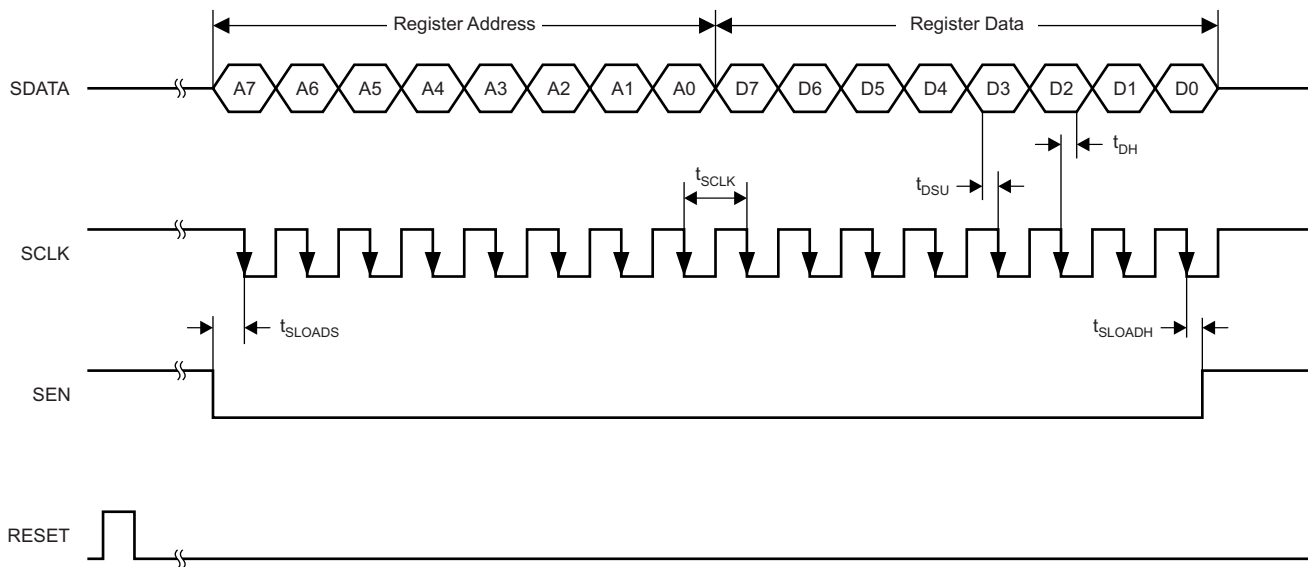

Figure 40. Serial Interface Timing

Table 3. Timing Characteristics for [Figure 40](#)

PARAMETER	MIN	TYP	MAX	UNIT
f <sub>SCLK</sub>	> dc		20	MHz
t <sub>SLOADS</sub>	25			ns
t <sub>SLOADH</sub>	25			ns
t <sub>DSU</sub>	25			ns
t <sub>DH</sub>	25			ns

### Serial Register Readout

The device includes a mode where the contents of the internal registers can be read back, as shown in Figure 41. This read-back mode can be useful as a diagnostic check to verify the serial interface communication between the external controller and ADC.

1. Set the READOUT register bit to '1'. This setting disables any further writes to the registers except register address 00h.
2. Initiate a serial interface cycle specifying the address of the register (A[7:0]) whose content must be read.
3. The device outputs the contents (D[7:0]) of the selected register on the SDOUT pin (pin G10).
4. The external controller can latch the contents at the SCLK falling edge.
5. To enable register writes, reset the READOUT register bit to '0'.

Note that the contents of register 00h cannot be read back because the register contains RESET and READOUT bits. When the READOUT bit is disabled, the SDOUT pin is in a high-impedance state. If serial readout is not used, the SDOUT pin must not be connected (must float).

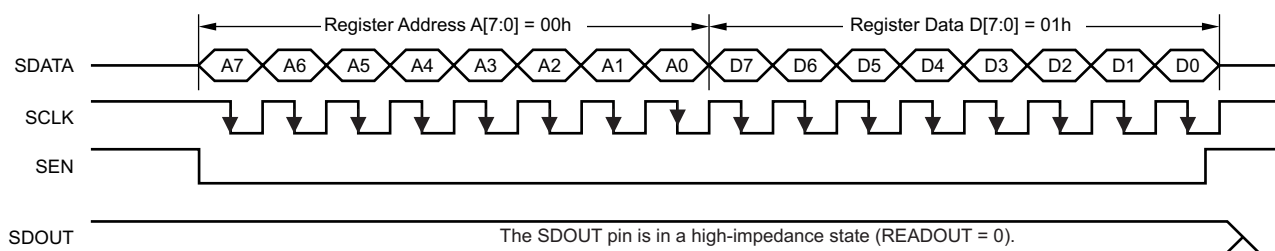

a) Enable serial readout (READOUT = 1)

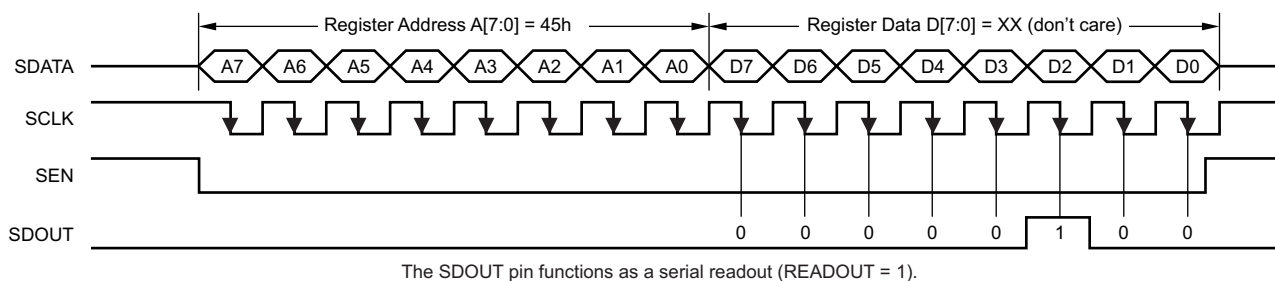

b) Read contents of Register 45h. This register is initialized with 04h.

Figure 41. Serial Readout Timing Diagram

SDOUT comes out at the SCLK rising edge with an approximate delay ( $t_{SD\_DELAY}$ ) of 8 ns, as shown in Figure 42.

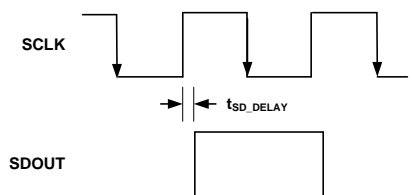

Figure 42. SDOUT Delay Timing

## SERIAL INTERFACE REGISTERS

Table 4 summarizes the ADS58H40 registers.

**Table 4. Register Map**

REGISTER ADDRESS A[7:0] (Hex)	REGISTER DATA							
	D7	D6	D5	D4	D3	D2	D1	D0
00	0	0	0	0	0	0	RESET	READOUT
01	LVDS SWING						0	0
25	DIGITAL GAIN CH B				DIGITAL GAIN BYPASS CH B	TEST PATTERN CH B		
2B	DIGITAL GAIN CH A				DIGITAL GAIN BYPASS CH A	TEST PATTERN CH A		
31	DIGITAL GAIN CH D				DIGITAL GAIN BYPASS CH D	TEST PATTERN CH D		
37	DIGITAL GAIN CH C				DIGITAL GAIN BYPASS CH C	TEST PATTERN CH C		
3D	0	0	SEL OFFSET CORR	0	0	0	0	0
3F	0	0	CUSTOM PATTERN[13:8]					
40	CUSTOM PATTERN[7:0]							
41	0	0	0	HIGH RESOLUTION SAMPLES, NH				AUTO BURST ENABLE
42	0	0	0	0	DIGITAL ENABLE	SNRB 45/95MHz	LOW RESOLUTION SAMPLES, NL	
44	BMODE EN CH CD	BMODE EN CH AB	0	0	0	BMODE OVR ENABLE	0	DIS SNRB
45	0	0	0	0	SEL OVR	GLOBAL POWER DOWN	0	CONFIG PDN PIN
A9	0	0	0	0	CLOCKOUT DELAY PROG CH AB			
AC	0	CLOCKOUT DELAY PROG CH CD				0	0	0
C3	FAST OVR THRESH PROG							
C4	EN FAST OVR THRESH	0	0	0	0	0	0	0
CF	0	0	0	0	SPECIAL MODE 0	0	0	0
D4	SPECIAL MODE 1	0	0	0	0	0	0	0
D5	SPECIAL MODE 2	0	0	0	0	0	0	0
D6	SPECIAL MODE 3	0	0	0	0	0	0	0
D7	0	0	0	0	SPECIAL MODE 5	SPECIAL MODE 4	0	0
DB	0	0	SPECIAL MODE 7	SPECIAL MODE 6	0	0	0	0
F0	0	0	SPECIAL MODE 10	SPECIAL MODE 9	SPECIAL MODE 8	0	0	0
F1	0	0	SPECIAL MODE 11	0	0	ENABLE LVDS SWING PROG		
F5	0	SPECIAL MODE 13	0	0	0	0	SPECIAL MODE 12	0
4A	0	0	0	0	0	0	0	SPECIAL MODE 14
62	0	0	0	0	0	0	0	SPECIAL MODE 15
92	0	0	0	0	0	0	0	SPECIAL MODE 16
7A	0	0	0	0	0	0	0	SPECIAL MODE 17
EA	SNRB PIN OVRD	0	0	0	0	0	0	0
FE	0	0	0	0	0	PDN CH D	PDN CH C	PDN CH A
								PDN CH B



**DESCRIPTION OF SERIAL REGISTERS**
**Register Address 00h (Default = 00h)**

D7	D6	D5	D4	D3	D2	D1	D0
0	0	0	0	0	0	RESET	READOUT

**Bits D[7:2]**      **Always write '0'**

**Bit D1**      **RESET: Software reset applied**

This bit resets all internal registers to the default values and self-clears to '0'.

**Bit D0**      **READOUT: Serial readout**

This bit sets the serial readout of the registers.

0 = Serial readout of registers disabled; the SDOOUT pin is placed in a high-impedance state.

1 = Serial readout enabled; the SDOOUT pin functions as a serial data readout with CMOS logic levels running from the DRVDD supply.

**Register Address 01h (Default = 00h)**

D7	D6	D5	D4	D3	D2	D1	D0
LVDS SWING						0	0

**Bits D[7:2]**      **LVDS SWING: LVDS swing programmability**

These bits program the LVDS swing only after the ENABLE LVDS SWING PROG bits are set to '11'.

000000 = Default LVDS swing;  $\pm 350$  mV with an external 100- $\Omega$  termination

011011 =  $\pm 420$ -mV LVDS swing with an external 100- $\Omega$  termination

110010 =  $\pm 470$ -mV LVDS swing with an external 100- $\Omega$  termination

010100 =  $\pm 560$ -mV LVDS swing with an external 100- $\Omega$  termination

001111 =  $\pm 160$ -mV LVDS swing with an external 100- $\Omega$  termination

**Bits D[1:0]**      **Always write '0'**

**Register Address 25h (Default = 00h)**

D7	D6	D5	D4	D3	D2	D1	D0
DIGITAL GAIN CH B				DIGITAL GAIN BYPASS CH B		TEST PATTERN CH B	

**Bits D[7:4]**

**DIGITAL GAIN CH B: Channel B digital gain programmability**

These bits set the digital gain programmability from 0 dB to 6 dB in 0.5-dB steps for channel B. Set the DIGITAL ENABLE bit to '1' beforehand to enable this feature.

- 0000 = 0-dB gain
- 0001 = 0.5-dB gain
- 0010 = 1-dB gain
- 0011 = 1.5-dB gain
- 0100 = 2-dB gain
- 0101 = 2.5-dB gain
- 0110 = 3-dB gain
- 0111 = 3.5-dB gain
- 1000 = 4-dB gain
- 1001 = 4.5-dB gain
- 1010 = 5-dB gain
- 1011 = 5.5-dB gain
- 1100 = 6-dB gain

**Bit D3**

**DIGITAL GAIN BYPASS CH B: Channel B digital gain bypass**

- 0 = Normal operation
- 1 = Digital gain feature for channel B is bypassed

**Bits D[2:0]**

**TEST PATTERN CH B: Channel B test pattern programmability**

These bits program the test pattern for channel B.

- 000 = Normal operation
- 001 = Outputs all 0s
- 010 = Outputs all 1s
- 011 = Outputs toggle pattern

In 11-bit mode, output data (D[10:0]) are an alternating sequence of *10101010101* and *01010101010*.

In 14-bit burst mode, output data ([D:0]) are an alternating sequence of *01010101010101* and *10101010101010*.

- 100 = Outputs digital ramp

In 11-bit mode, output data increments by one 11-bit LSB every 8th clock cycle from code 0 to code 2047.

In 14-bit burst mode, output data increments by one 14-bit LSB every clock cycle from code 0 to code 16383

- 101 = Outputs custom pattern

To program a pattern in 11-bit mode, use the CUSTOM PATTERN D[13:3] bits of registers 3Fh and 40h.

To program a pattern in 14-bit mode, use the CUSTOM PATTERN D[13:0] bits of registers 3Fh and 40h.

- 110 = Unused
- 111 = Unused

**Register Address 2Bh (Default = 00h)**

D7	D6	D5	D4	D3	D2	D1	D0
DIGITAL GAIN CH A				DIGITAL GAIN BYPASS CH A		TEST PATTERN CH A	

**Bits D[7:4]**
**DIGITAL GAIN CH A: Channel A digital gain programmability**

These bits set the digital gain programmability from 0 dB to 6 dB in 0.5-dB steps for channel A. Set the DIGITAL ENABLE bit to '1' beforehand to enable this feature.

0000 = 0-dB gain  
 0001 = 0.5-dB gain  
 0010 = 1-dB gain  
 0011 = 1.5-dB gain  
 0100 = 2-dB gain  
 0101 = 2.5-dB gain  
 0110 = 3-dB gain  
 0111 = 3.5-dB gain  
 1000 = 4-dB gain  
 1001 = 4.5-dB gain  
 1010 = 5-dB gain  
 1011 = 5.5-dB gain  
 1100 = 6-dB gain

**Bit D3**
**DIGITAL GAIN BYPASS CH A: Channel A digital gain bypass**

0 = Normal operation  
 1 = Digital gain feature for channel A is bypassed

**Bits D[2:0]**
**TEST PATTERN CH A: Channel A test pattern programmability**

These bits program the test pattern for channel A.

000 = Normal operation  
 001 = Outputs all 0s  
 010 = Outputs all 1s  
 011 = Outputs toggle pattern

In 11-bit mode, output data (D[10:0]) are an alternating sequence of *10101010101* and *01010101010*.

In 14-bit burst mode, output data ([D:0]) are an alternating sequence of *01010101010101* and *10101010101010*.

100 = Outputs digital ramp

In 11-bit mode, output data increments by one 11-bit LSB every 8th clock cycle from code 0 to code 2047.

In 14-bit burst mode, output data increments by one 14-bit LSB every clock cycle from code 0 to code 16383

101 = Outputs custom pattern

To program a pattern in 11-bit mode, use the CUSTOM PATTERN D[13:3] bits of registers 3Fh and 40h.

To program a pattern in 14-bit mode, use the CUSTOM PATTERN D[13:0] bits of registers 3Fh and 40h.

110 = Unused  
 111 = Unused

**Register Address 31h (Default = 00h)**

D7	D6	D5	D4	D3	D2	D1	D0
DIGITAL GAIN CH D				DIGITAL GAIN BYPASS CH D		TEST PATTERN CH D	

**Bits D[7:4]**

**DIGITAL GAIN CH D: Channel D digital gain programmability**

These bits set the digital gain programmability from 0 dB to 6 dB in 0.5-dB steps for channel D. Set the DIGITAL ENABLE bit to '1' beforehand to enable this feature.

- 0000 = 0-dB gain
- 0001 = 0.5-dB gain
- 0010 = 1-dB gain
- 0011 = 1.5-dB gain
- 0100 = 2-dB gain
- 0101 = 2.5-dB gain
- 0110 = 3-dB gain
- 0111 = 3.5-dB gain
- 1000 = 4-dB gain
- 1001 = 4.5-dB gain
- 1010 = 5-dB gain
- 1011 = 5.5-dB gain
- 1100 = 6-dB gain

**Bit D3**

**DIGITAL GAIN BYPASS CH D: Channel D digital gain bypass**

- 0 = Normal operation
- 1 = Digital gain feature for channel A is bypassed

**Bits D[2:0]**

**TEST PATTERN CH D: Channel D test pattern programmability**

These bits program the test pattern for channel D.

- 000 = Normal operation
- 001 = Outputs all 0s
- 010 = Outputs all 1s
- 011 = Outputs toggle pattern

In 11-bit mode, output data (D[10:0]) are an alternating sequence of *10101010101* and *01010101010*.

In 14-bit burst mode, output data ([D:0]) are an alternating sequence of *01010101010101* and *10101010101010*.

- 100 = Outputs digital ramp

In 11-bit mode, output data increments by one 11-bit LSB every 8th clock cycle from code 0 to code 2047.

In 14-bit burst mode, output data increments by one 14-bit LSB every clock cycle from code 0 to code 16383

- 101 = Outputs custom pattern

To program a pattern in 11-bit mode, use the CUSTOM PATTERN D[13:3] bits of registers 3Fh and 40h.

To program a pattern in 14-bit mode, use the CUSTOM PATTERN D[13:0] bits of registers 3Fh and 40h.

- 110 = Unused
- 111 = Unused

**Register Address 37h (Default = 00h)**

D7	D6	D5	D4	D3	D2	D1	D0
DIGITAL GAIN CH C			DIGITAL GAIN BYPASS CH C			TEST PATTERN CH C	

**Bits D[7:4]**
**DIGITAL GAIN CH C: Channel C digital gain programmability**

These bits set the digital gain programmability from 0 dB to 6 dB in 0.5-dB steps for channel C. Set the DIGITAL ENABLE bit to '1' beforehand to enable this feature.

0000 = 0-dB gain

0001 = 0.5-dB gain

0010 = 1-dB gain

0011 = 1.5-dB gain

0100 = 2-dB gain

0101 = 2.5-dB gain

0110 = 3-dB gain

0111 = 3.5-dB gain

1000 = 4-dB gain

1001 = 4.5-dB gain

1010 = 5-dB gain

1011 = 5.5-dB gain

1100 = 6-dB gain

**Bit D3**
**DIGITAL GAIN BYPASS CH C: Channel C digital gain bypass**

0 = Normal operation

1 = Digital gain feature for channel A is bypassed

**Bits D[2:0]**
**TEST PATTERN CH C: Channel C test pattern programmability**

These bits program the test pattern for channel C.

000 = Normal operation

001 = Outputs all 0s

010 = Outputs all 1s

011 = Outputs toggle pattern

In 11-bit mode, output data (D[10:0]) are an alternating sequence of *10101010101* and *01010101010*.

In 14-bit burst mode, output data ([D:0]) are an alternating sequence of *01010101010101* and *10101010101010*.

100 = Outputs digital ramp

In 11-bit mode, output data increments by one 11-bit LSB every 8th clock cycle from code 0 to code 2047.

In 14-bit burst mode, output data increments by one 14-bit LSB every clock cycle from code 0 to code 16383

101 = Outputs custom pattern

To program a pattern in 11-bit mode, use the CUSTOM PATTERN D[13:3] bits of registers 3Fh and 40h.

To program a pattern in 14-bit mode, use the CUSTOM PATTERN D[13:0] bits of registers 3Fh and 40h.

110 = Unused

111 = Unused

**Register Address 3Dh (Default = 00h)**

D7	D6	D5	D4	D3	D2	D1	D0
0	0	SEL OFFSET CORR	0	0	0	0	0

**Bits D[7:6]** Always write '0'

**Bit D5** SEL OFFSET CORR: Offset correction setting

This bit enables the offset correction feature for all four channels after the DIGITAL ENABLE bit is set to '1,' correcting mid-code to 1023. In addition, write the SPECIAL MODE 0 bit (register CFh, value 08h) for proper operation of the offset correction feature. Note that the offset correction feature should only be used in the default 11-bit mode.

0 = Offset correction disabled

1 = Offset correction enabled

**Bits D[4:0]** Always write '0'

**Register Address 3Fh (Default = 00h)**

D7	D6	D5	D4	D3	D2	D1	D0
0	0	CUSTOM PATTERN D13	CUSTOM PATTERN D12	CUSTOM PATTERN D11	CUSTOM PATTERN D10	CUSTOM PATTERN D9	CUSTOM PATTERN D8

**Bits D[7:6]** Always write '0'

**Bits D[5:0]** CUSTOM PATTERN D[13:8]

Set the custom pattern using these bits for all four channels.

**Register Address 40h (Default = 00h)**

D7	D6	D5	D4	D3	D2	D1	D0
CUSTOM PATTERN D7	CUSTOM PATTERN D6	CUSTOM PATTERN D5	CUSTOM PATTERN D4	CUSTOM PATTERN D3	CUSTOM PATTERN D2	CUSTOM PATTERN D1	CUSTOM PATTERN D0

**Bits D[7:0]** CUSTOM PATTERN D[7:0]

Set the custom pattern using these bits for all four channels.

**Register Address 41h (Default = 00h)**

D7	D6	D5	D4	D3	D2	D1	D0
0	0	0	HIGH RESOLUTION SAMPLES, NH			AUTO BURST ENABLE	

**Bits D[7:5]**
**Always write '0'**
**Bits D[4:1]**
**HIGH RESOLUTION SAMPLES, NH**

These bits control the number of high-resolution samples in 14-bit burst mode with

[Equation 1:](#)

$$2^{10 + \text{NH}} \quad (1)$$

0000: NH = 0  
 0001: NH = 1  
 0010: NH = 2  
 0011: NH = 3  
 0100: NH = 4  
 0101: NH = 5  
 0110: NH = 6  
 0111: NH = 7  
 1000: NH = 8  
 1001: NH = 9  
 1010: NH = 10  
 1011: NH = 11  
 1100: NH = 12  
 1101: NH = 13  
 1110: NH = 14  
 1111: NH = 15

**Bit D0**
**AUTO BURST ENABLE**

0 = 14-bit burst mode disabled

1 = 14-bit burst mode auto-enabled

**Register Address 42h (Default = 00h)**

D7	D6	D5	D4	D3	D2	D1	D0
0	0	0	0	DIGITAL ENABLE	SNRB 45/90MHz	LOW RESOLUTION SAMPLES, NL	

**Bits D[7:4]**

**Always write '0'**

**Bit D3**

**DIGITAL ENABLE**

1 = Digital gain and offset correction features disabled  
 1 = Digital gain and offset correction features enabled

**Bit D2**

**SNRB 45/90MHz: SNRBoost<sup>3G+</sup> enable**

0 = SNRBoost<sup>3G+</sup> enabled with 90-MHz bandwidth (default after reset)  
 1 = SNRBoost<sup>3G+</sup> enabled with 45-MHz bandwidth

**Bits D[1:0]**

**LOW RESOLUTION SAMPLES, NL**

These bits control the number of low-resolution samples in 14-bit burst mode with

[Equation 2:](#)

$$2^{13 + NH + NL}$$

(2)

00: NL = 0  
 01: NL = 1  
 10: NL = 2  
 11: NL = 3

**Register Address 44h (Default = 00h)**

D7	D6	D5	D4	D3	D2	D1	D0
BMODE EN CH CD	BMODE EN CH AB	0	0	0	BMODE OVR ENABLE	0	DIS SNRB

**Bit D7**

**BMODE EN CH CD**

0 = 14-bit burst mode disabled for channels C and D  
 1 = 14-bit burst mode enabled for channels C and D

**Bit D6**

**BMODE EN CH AB**

0 = 14-bit burst mode disabled for channels A and B  
 1 = 14-bit burst mode enabled for channels A and B

**Bits D[5:3]**

**Always write '0'**

**Bit D2**

**BMODE OVR ENABLE**

This bit can only be used in 14-bit burst mode.  
 0 = 14-bit data comes out without an OVR  
 1 = The ADC data out bit (Dxx[0]) becomes OVRxx. See the [Overrange Indication \(OVRxx\)](#) section for details.

**Bit D1**

**Always write '0'**

**Bit D0**

**DIS SNRB: Disable SNRBoost**

This bit only functions when SNRB PIN OVRD is set.  
 0 = Default  
 1 = SNRBoost<sup>3G+</sup> is disabled for all four channels.



**Register Address 45h (Default = 00h)**

D7	D6	D5	D4	D3	D2	D1	D0
0	0	0	0	SEL OVR	GLOBAL POWER DOWN	0	CONFIG PDN PIN

**Bits D[7:4]**
**Always write '0'**
**Bit D3**
**SEL OVR: OVR selection**

0 = Fast OVR selected

 1 = Normal OVR selected. See the [Overrange Indication \(OVRxx\)](#) section for details.

**Bit D2**
**GLOBAL POWER DOWN**

0 = Normal operation

 1 = Global power down. All ADC channels, internal references, and output buffers are powered down. Wakeup time from this mode is slow (100  $\mu$ s).

**Bit D1**
**Always write '0'**
**Bit D0**
**CONFIG PDN PIN**

Use this bit to configure PDN pin.

 0 = The PDN pin functions as a standby pin. All channels are put in standby. Wake-up time from standby mode is fast (10  $\mu$ s).

 1 = The PDN pin functions as a global power-down pin. All ADC channels, internal references, and output buffers are powered down. Wake-up time from global power mode is slow (100  $\mu$ s).

**Register Address A9h (Default = 00h)**

D7	D6	D5	D4	D3	D2	D1	D0
0	0	0	0	CLOCKOUT DELAY PROG CH AB			

**Bits D[7:4]**
**Always write '0'**
**Bits D[6:3]**
**CLOCKOUT DELAY PROG CH AB**

 These bits program the clock out delay for channels A and B, see [Table 5](#).

**Register Address ACh (Default = 00h)**

D7	D6	D5	D4	D3	D2	D1	D0
0	CLOCKOUT DELAY PROG CH CD				0	0	0

**Bit D7** Always write '0'

**Bits D[7:4]** **CLOCKOUT DELAY PROG CH CD**

These bits program the clock out delay for channels C and D, as shown in [Table 5](#).

**Bits D[2:0]** Always write '0'

**Table 5. Clock Out Delay Programmability for All Channels**

CLOCKOUT DELAY PROG CHxx	DELAY (ps)
0000	0
0001	-30
0010	70
0011	30
0100	-150
0101	-180
0110	-70
0111	-110
1000	270
1001	230
1010	340
1011	300
1100	140
1101	110
1110	200
1111	170

**Register Address C3h (Default = 00h)**

D7	D6	D5	D4	D3	D2	D1	D0
FAST OVR THRESH PROG							

**Bits D[7:0]** **FAST OVR THRESH PROG**

The ADS58H40 has a fast OVR mode that indicates an overload condition at the ADC input. The input voltage level at which the overload is detected is referred to as the threshold and is programmable using the FAST OVR THRESH PROG bits. FAST OVR is triggered seven output clock cycles after the overload condition occurs. To enable the FAST OVR programmability, enable the EN FAST OVR THRESH register bit. The threshold at which fast OVR is triggered is (full-scale × [the decimal value of the FAST OVR THRESH PROG bits] / 255). After reset, when EN FAST OVR THRESH PROG is set, the default value of the FAST OVR THRESH PROG bits is 230 (decimal).

**Register Address C4h (Default = 00h)**

D7	D6	D5	D4	D3	D2	D1	D0
EN FAST OVR THRESH	0	0	0	0	0	0	0

**Bit D7 EN FAST OVR THRESH**

This bit enables the ADS58H40 to be programmed to select the fast OVR threshold.

**Bits D[6:0] Always write '0'**
**Register Address CFh (Default = 00h)**

D7	D6	D5	D4	D3	D2	D1	D0
0	0	0	0	SPECIAL MODE 0	0	0	0

**Bits D[7:4] Always write '0'**
**Bit D3 SPECIAL MODE 0**

This bit must be set to '1' when the SEL OFFSET CORR bit is selected.

**Bits D[2:0] Always write '0'**
**Register Address D4h (Default = 00h)**

D7	D6	D5	D4	D3	D2	D1	D0
SPECIAL MODE 1	0	0	0	0	0	0	0

**Bit D7 SPECIAL MODE 1**

Refer to [Table 1](#) for optimal performance in a given frequency band and source impedance.

**Bits D[6:0] Always write '0'**
**Register Address D5h (Default = 00h)**

D7	D6	D5	D4	D3	D2	D1	D0
SPECIAL MODE 2	0	0	0	0	0	0	0

**Bit D7 SPECIAL MODE 2**

Refer to [Table 1](#) for optimal performance in a given frequency band and source impedance.

**Bits D[6:0] Always write '0'**
**Register Address D6h (Default = 00h)**

D7	D6	D5	D4	D3	D2	D1	D0
SPECIAL MODE 3	0	0	0	0	0	0	0

**Bit D7 SPECIAL MODE 3**

Refer to [Table 1](#) for optimal performance in a given frequency band and source impedance.

**Bits D[6:0] Always write '0'**

**Register Address D7h (Default = 00h)**

D7	D6	D5	D4	D3	D2	D1	D0
0	0	0	0	SPECIAL MODE 5	SPECIAL MODE 4	0	0

**Bits D[7:4]**

**Always write '0'**

**Bit D3**

**SPECIAL MODE 5**

Refer to [Table 1](#) for optimal performance in a given frequency band and source impedance.

**Bit D2**

**SPECIAL MODE 4**

Refer to [Table 1](#) for optimal performance in a given frequency band and source impedance.

**Bits D[1:0]**

**Always write '0'**

**Register Address DBh (Default = 00h)**

D7	D6	D5	D4	D3	D2	D1	D0
0	0	SPECIAL MODE 7	SPECIAL MODE 6	0	0	0	0

**Bits D[7:6]**

**Always write '0'**

**Bit D5**

**SPECIAL MODE 7**

Refer to [Table 1](#) for optimal performance in a given frequency band and source impedance.

**Bit D4**

**SPECIAL MODE 6**

Refer to [Table 1](#) for optimal performance in a given frequency band and source impedance.

**Bits D[3:0]**

**Always write '0'**

**Register Address F0h (Default = 00h)**

D7	D6	D5	D4	D3	D2	D1	D0
0	0	SPECIAL MODE 10	SPECIAL MODE 9	SPECIAL MODE 8	0	0	0

**Bits D[7:6]**

**Always write '0'**

**Bit D5**

**SPECIAL MODE 10**

Refer to [Table 1](#) for optimal performance in a given frequency band and source impedance.

**Bit D4**

**SPECIAL MODE 9**

Refer to [Table 1](#) for optimal performance in a given frequency band and source impedance.

**Bit D3**

**SPECIAL MODE 8**

Refer to [Table 1](#) for optimal performance in a given frequency band and source impedance.

**Bits D[2:0]**

**Always write '0'**

**Register Address F1h (Default = 00h)**

D7	D6	D5	D4	D3	D2	D1	D0
0	0	SPECIAL MODE 11	0	0	ENABLE LVDS SWING PROG		

**Bits D[7:6]**
**Always write '0'**
**Bit D7**
**SPECIAL MODE 11**

 Refer to [Table 1](#) for optimal performance in a given frequency band and source impedance.

**Bits D[4:3]**
**Always write '0'**
**Bits D[2:0]**
**ENABLE LVDS SWING PROG**

This bit enables the LVDS swing control with the LVDS SWING bits.

00 = LVDS swing control disabled

01 = Do not use

10 = Do not use

11 = LVDS swing control enabled

**Register Address F5h (Default = 00h)**

D7	D6	D5	D4	D3	D2	D1	D0
0	SPECIAL MODE 13	0	0	0	0	SPECIAL MODE 12	0

**Bit D7**
**Always write '0'**
**Bit D6**
**SPECIAL MODE 13**

 Refer to [Table 1](#) for optimal performance in a given frequency band and source impedance.

**Bits D[5:2]**
**Always write '0'**
**Bit D1**
**SPECIAL MODE 12**

 Refer to [Table 1](#) for optimal performance in a given frequency band and source impedance.

**Bit D0**
**Always write '0'**
**Register Address 4Ah (Default = 00h)**

D7	D6	D5	D4	D3	D2	D1	D0
0	0	0	0	0	0	0	SPECIAL MODE 14

**Bits D[7:1]**
**Always write '0'**
**Bit D0**
**SPECIAL MODE 14**

Set the SPECIAL MODE[17:14] bits high to reduce the minimum functional clock speed to 10 MSPS. Usage of these bits should be limited to functional checks only because performance degrades when these bits are set high.

**Register Address 62h (Default = 00h)**

D7	D6	D5	D4	D3	D2	D1	D0
0	0	0	0	0	0	0	SPECIAL MODE 15

**Bits D[7:1]**

**Always write '0'**

**Bit D0**

**SPECIAL MODE 15**

Set the SPECIAL MODE[17:14] bits high to reduce the minimum functional clock speed to 10 MSPS. Usage of these bits should be limited to functional checks only because performance degrades when these bits are set high.

**Register Address 92h (Default = 00h)**

D7	D6	D5	D4	D3	D2	D1	D0
0	0	0	0	0	0	0	SPECIAL MODE 16

**Bits D[7:1]**

**Always write '0'**

**Bit D0**

**SPECIAL MODE 16**

Set the SPECIAL MODE[17:14] bits high to reduce the minimum functional clock speed to 10 MSPS. Usage of these bits should be limited to functional checks only because performance degrades when these bits are set high.

**Register Address 7Ah (Default = 00h)**

D7	D6	D5	D4	D3	D2	D1	D0
0	0	0	0	0	0	0	SPECIAL MODE 17

**Bits D[7:1]**

**Always write '0'**

**Bit D0**

**SPECIAL MODE 17**

Set the SPECIAL MODE[17:14] bits high to reduce the minimum functional clock speed to 10 MSPS. Usage of these bits should be limited to functional checks only because performance degrades when these bits are set high.

**Register Address EAh (Default = 00h)**

D7	D6	D5	D4	D3	D2	D1	D0
SNRB PIN OVRD	0	0	0	0	0	0	0

**Bit D7 SNRB PIN OVRD**

0 = SNRBoost<sup>3G+</sup> is controlled by the SNRB pin.  
 1 = SNRBoost<sup>3G+</sup> is controlled by the DIS SNRB register bit.

**Bits D[6:0] Always write '0'**
**Register Address FEh (Default = 00h)**

D7	D6	D5	D4	D3	D2	D1	D0
0	0	0	0	PDN CH D	PDN CH C	PDN CH A	PDN CH B

**Bits D[7:4] Always write '0'**
**Bit D3 PDN CH D: Power-down channel D**

Channel D is powered down.

**Bit D2 PDN CH C: Power-down channel C**

Channel C is powered down.

**Bit D1 PDN CH B: Power-down channel A**

Channel B is powered down.

**Bit D0 PDN CH A: Power-down channel B**

Channel A is powered down.

## APPLICATION INFORMATION

### THEORY OF OPERATION

The ADS58H40 is a quad-channel, 11-bit, analog-to-digital converter (ADC) with sampling rates up to 250 MSPS. At every falling edge of the input clock, the analog input signal for each channel is sampled simultaneously. The sampled signal in each channel is converted by a pipeline of low-resolution stages. In each stage, the sampled-and-held signal is converted by a high-speed, low-resolution, flash sub-ADC. The difference (residue) between the stage input and its quantized equivalent is gained and propagates to the next stage. At every clock, each subsequent stage resolves the sampled input with greater accuracy. The digital outputs from all stages are combined in a digital correction logic block and digitally processed to create the final code, after a data latency of 10 clock cycles. The digital output is available in a double data rate (DDR) low-voltage differential signaling (LVDS) interface and is coded in binary twos complement format.

### ANALOG INPUT

The analog input consists of a switched-capacitor-based differential sample-and-hold architecture. This differential topology results in very good ac performance even for high input frequencies at high sampling rates.

The INP and INM pins must be externally biased around a common-mode voltage of 1.15 V, available on the VCM pin. For a full-scale differential input, each input pin (INP, INM) must swing symmetrically between  $V_{CM} + 0.5\text{ V}$  and  $V_{CM} - 0.5\text{ V}$ , resulting in a  $2\text{-}V_{PP}$  differential input swing.

The input sampling circuit has a high 3-dB bandwidth that extends up to 500 MHz when a 50- $\Omega$  source drives the ADC analog inputs.

#### Drive Circuit Requirements

For optimum performance, the analog inputs must be driven differentially. This configuration improves the common-mode noise immunity and even-order harmonic rejection. A 5- $\Omega$  to 15- $\Omega$  resistor in series with each input pin is recommended to damp out ringing caused by package parasitics.

Spurious-free dynamic range (SFDR) performance can be limited because of several reasons (such as the effect of sampling glitches, sampling circuit nonlinearity, and quantizer nonlinearity that follows the sampling circuit). Depending on the input frequency, sampling rate, and input amplitude, one of these metrics plays a dominant part in limiting performance. At very high input frequencies, SFDR is determined largely by the device sampling circuit nonlinearity. At low input amplitudes, the quantizer nonlinearity typically limits performance.

Glitches are caused by opening and closing the sampling switches. The driving circuit should present a low source impedance to absorb these glitches, otherwise these glitches may limit performance. A low impedance path between the analog input pins and VCM is required from the common-mode switching currents perspective as well. This impedance can be achieved by using two resistors from each input terminated to the common-mode voltage (VCM).

The ADS58H40 includes an internal R-C filter from each input to ground. The purpose of this filter is to absorb the sampling glitches inside the device itself. The R-C component values are also optimized to support high input bandwidth (up to 500 MHz). However, using an R-LC-R filter (refer to [Figure 46](#), [Figure 47](#), [Figure 48](#), [Figure 49](#), and [Figure 50](#)) improves glitch filtering, thus further resulting in better performance.



In addition, the drive circuit may have to be designed to provide a low insertion loss over the desired frequency range and matched source impedance. In doing so, the ADC input impedance must be considered. Figure 43, Figure 44, and Figure 45 show the impedance ( $Z_{IN} = R_{IN} \parallel C_{IN}$ ) at the ADC input pins.

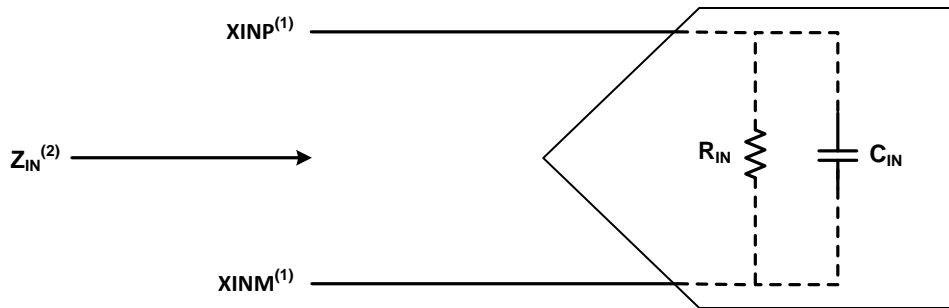

- (1) X = A, B, C, or D.
- (2)  $Z_{IN} = R_{IN} \parallel (1/j\omega C_{IN})$ .

Figure 43. ADC Equivalent Input Impedance

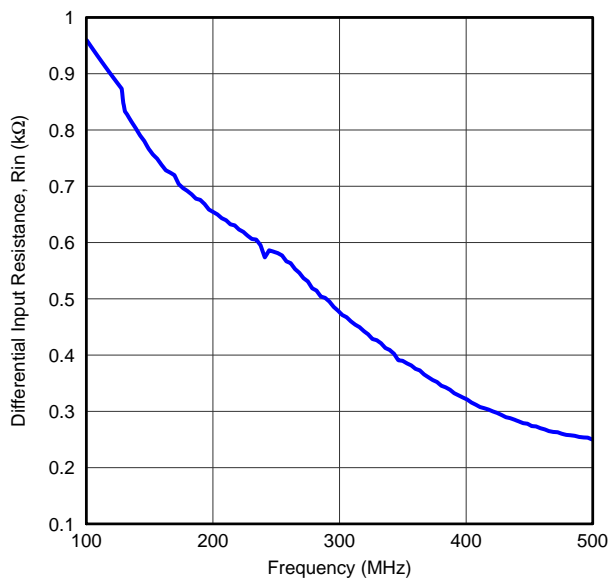

Figure 44. ADC Analog Input Resistance ( $R_{IN}$ ) vs Frequency

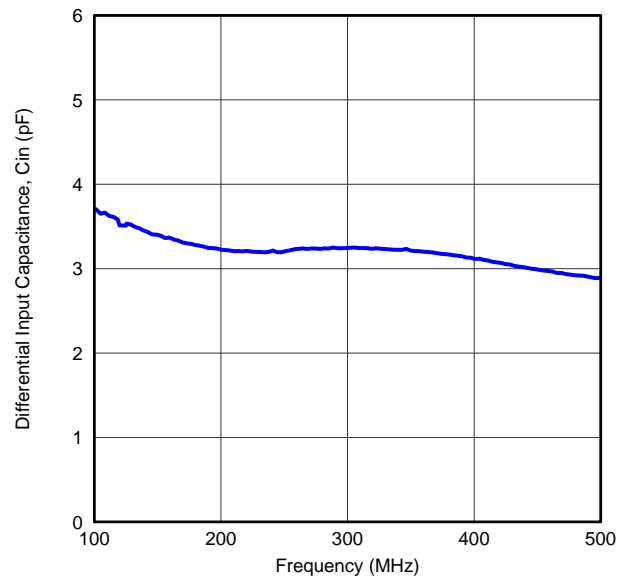

Figure 45. ADC Analog Input Capacitance ( $C_{IN}$ ) vs Frequency

**Driving Circuit**

Two example driving circuits with a 50-Ω source impedance are shown in Figure 46 and Figure 47. The driving circuit in Figure 46 is optimized for input frequencies in the second Nyquist zone (centered at 185 MHz), whereas the circuit in Figure 47 is optimized for input frequencies in third Nyquist zone (centered at 310 MHz).

Note that both drive circuits are terminated by 50 Ω near the ADC side. This termination is accomplished with a 25-Ω resistor from each input to the 1.15-V common-mode (VCM) from the device. This architecture allows the analog inputs to be biased around the required common-mode voltage.

The mismatch in the transformer parasitic capacitance (between the windings) results in degraded even-order harmonic performance. Connecting two identical RF transformers back-to-back helps minimize this mismatch and good performance is obtained for high-frequency input signals.

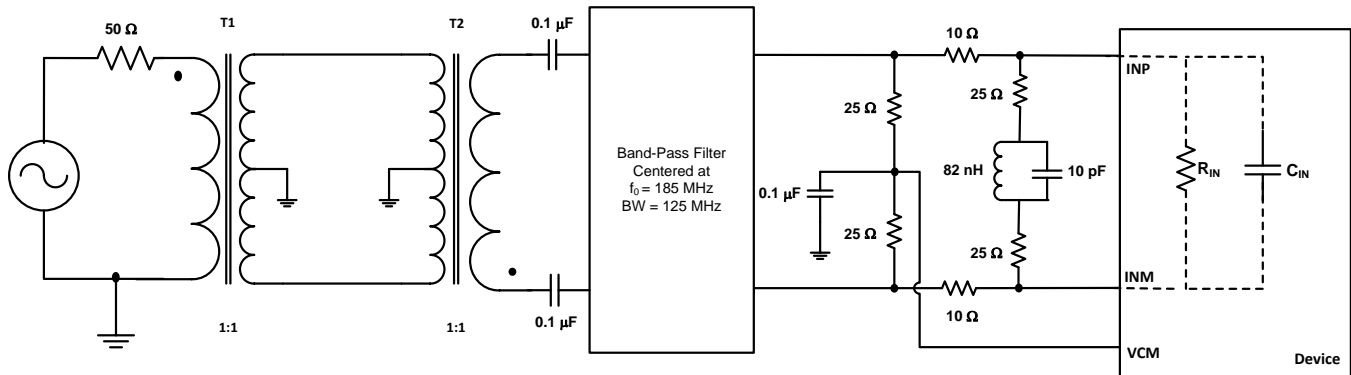

**Figure 46. Driving Circuit for a 50-Ω Source Impedance and Input Frequencies in the Second Nyquist Zone**

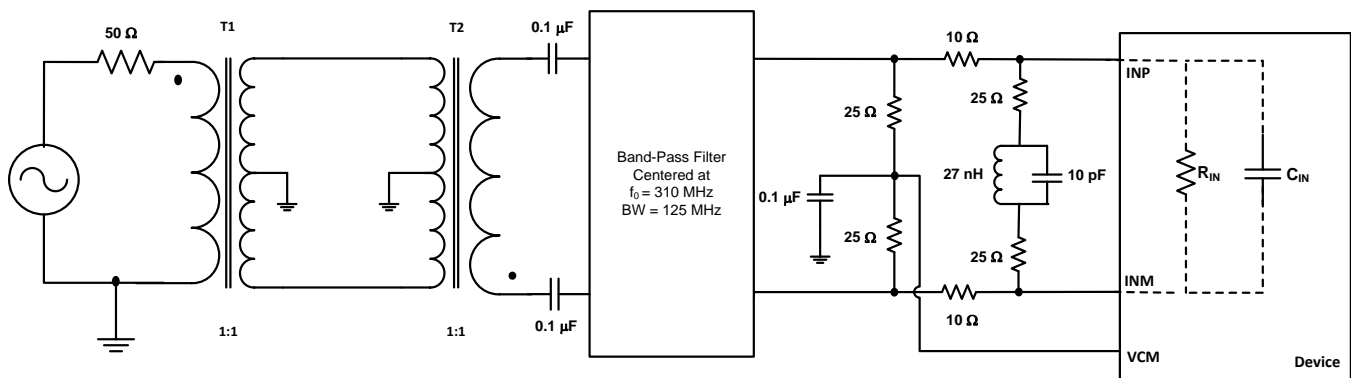

**Figure 47. Driving Circuit for a 50-Ω Source Impedance and Input Frequencies in the Third Nyquist Zone**

Appropriate high-performance modes must be written to ensure best performance in a given Nyquist zone and source impedance. Table 6 summarizes all available high-performance modes.

**Table 6. High-Performance Modes Summary<sup>(1)(2)</sup>**

ADDRESS (Hex)	DATA (Hex)	$f_S = 245.76$ MSPS				$f_S = 184.32$ MSPS	
		$R_S = 50$ ZONE = 2	$R_S = 100$ ZONE = 2	$R_S = 50$ ZONE = 3	$R_S = 100$ ZONE = 3	$R_S = 50$ ZONE = 2	$R_S = 100$ ZONE = 2
D4	80				√		
D5	80				√		
D6	80	√	√	√	√	√	
D7	0C	√	√	√		√	√
DB	30				√		
F0	38					√	√
F1	20	√		√		√	
F5	42				√		

- (1)  $R_S$  refers to the source impedance. Zone refers to the Nyquist zone in which the signal band lies. Zone = 2 corresponds to the signal band that lies between  $f_S / 2$  and  $f_S$ . Zone = 3 corresponds to the signal band that lies between  $f_S$  and  $3 \times f_S / 2$ .
- (2) Best performance can be achieved by writing these modes depending upon source impedance, band of operation, and sampling speed.

Two example driving circuits with 100-Ω differential termination are shown in Figure 48 and Figure 49. In these example circuits, the 1:2 transformer (T1) is used to transform the 50-Ω source impedance into a differential 100 Ω at the input of the band-pass filter. In Figure 48, the parallel combination of two 68-Ω resistors and one 120-nH inductor and two 100-Ω resistors is used (100-Ω is the effective impedance in pass-band) for better performance. The required high-performance modes for these applications are given in Table 6.

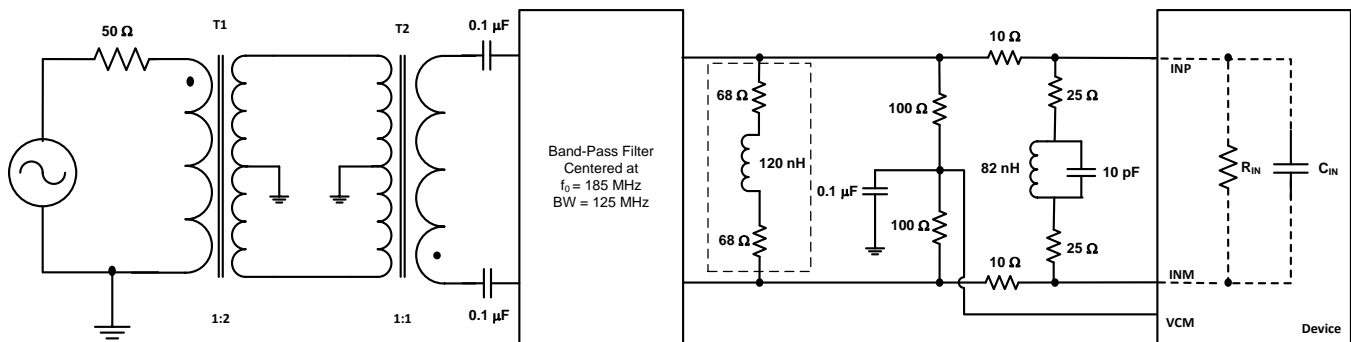

**Figure 48. Driving Circuit for a 100-Ω Source Impedance and Input Frequencies in the Second Nyquist Zone**

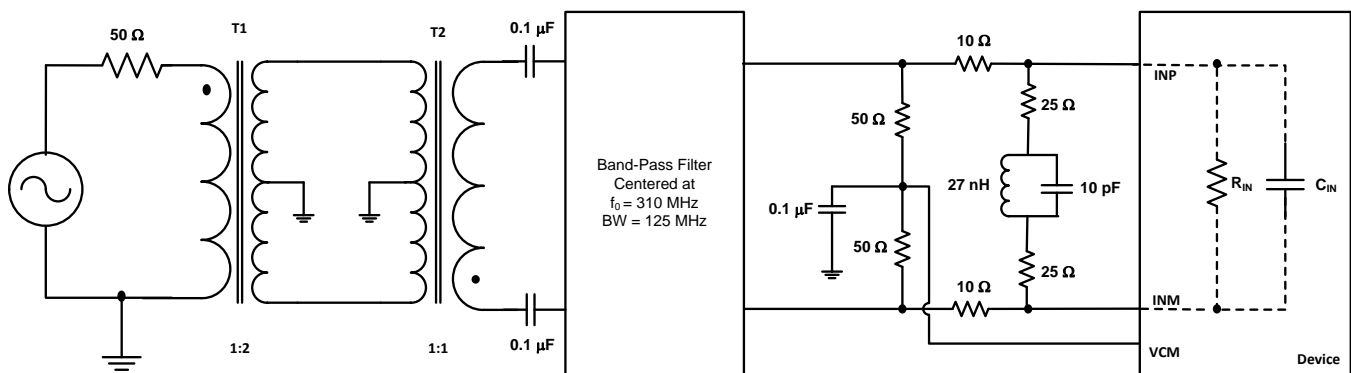

**Figure 49. Driving Circuit for a 100-Ω Source Impedance and Input Frequencies in the Third Nyquist Zone**

### Input Common Mode

To ensure a low-noise, common-mode reference, the VCM pin should be filtered with a 0.1- $\mu\text{F}$  low-inductance capacitor connected to ground. The VCM pin is designed to directly bias the ADC inputs (refer to [Figure 46](#) to [Figure 49](#)).

Each ADC input pin sinks a common-mode current of approximately 1.5  $\mu\text{A}$  per MSPS of clock frequency. When a differential amplifier is used to drive the ADC (with dc-coupling), ensure that the output common-mode of the amplifier is within the acceptable input common-mode range of the ADC inputs ( $V_{\text{CM}} \pm 25 \text{ mV}$ ).

### Clock Input

The ADS58H40 clock inputs can be driven differentially with a sine, LVPECL, or LVDS source with little or no difference in performance between them. The common-mode voltage of the clock inputs is set to 0.95 V using internal 5-k $\Omega$  resistors, as shown in [Figure 50](#). This setting allows the use of transformer-coupled drive circuits for sine-wave clock or ac-coupling for LVPECL, LVDS, and LVCMOS clock sources (see [Figure 51](#), [Figure 52](#), and [Figure 53](#)).

For best performance, the clock inputs must be driven differentially, thereby reducing susceptibility to common-mode noise. TI recommends keeping the differential voltage between clock inputs less than 1.8  $V_{\text{PP}}$  to obtain best performance. A clock source with very low jitter is recommended for high input frequency sampling. Band-pass filtering of the clock source can help reduce the effects of jitter. There is no change in performance with a non-50% duty cycle clock input.

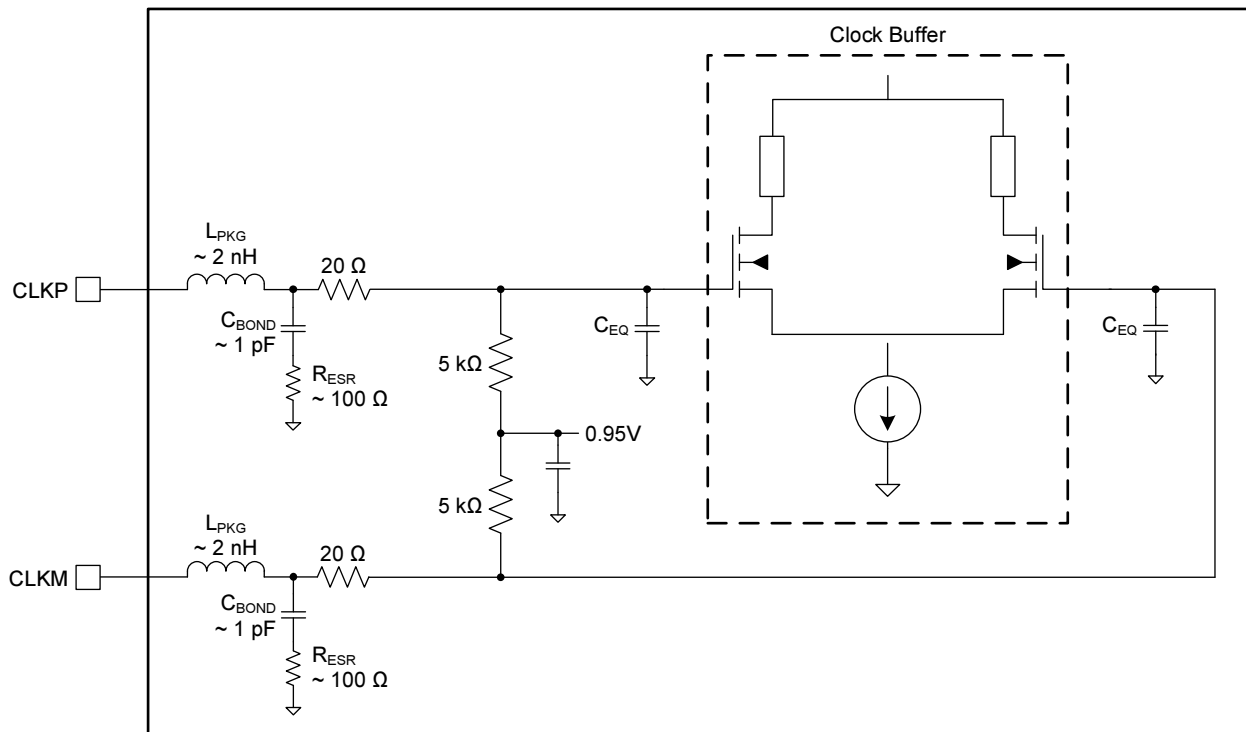

$C_{\text{EQ}}$  is 1 pF to 3 pF and is the equivalent input capacitance of the clock buffer.

**Figure 50. Internal Clock Buffer**

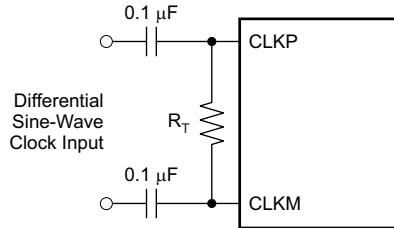

(1)  $R_T$  is the termination resistor (optional).

**Figure 51. Differential Sine-Wave Clock Driving Circuit**

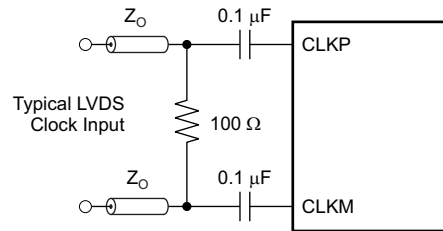

**Figure 53. LVDS Clock Driving Circuit**

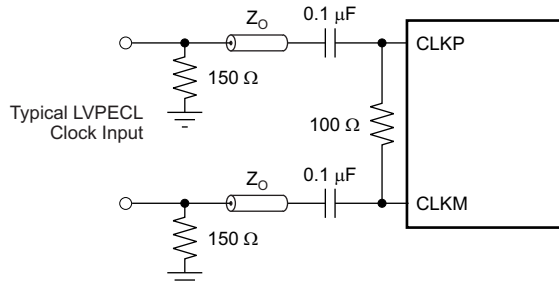

**Figure 52. LVPECL Clock Driving Circuit**

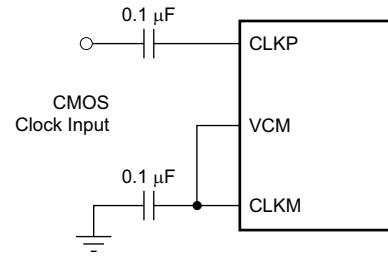

**Figure 54. Typical LVCMOS Clock Driving Circuit**

## OVERVIEW OF OPERATING MODES

There are three available operating modes: 11-bit, 250-MSPS mode; 11-bit SNRBoost<sup>3G+</sup>, 250-MSPS mode; and 14-bit, 250-MSPS mode (burst mode). Table 7 shows a summary of the operating modes.

**Table 7. Operating Mode Summary**

PIN SETTING	REGISTER SETTING	RESULTING MODE OF OPERATION	
		CHANNELS A AND B	CHANNELS C AND D
Default (after power up)	—	11 bit, 250 MSPS	11 bit, 250 MSPS
Set SNRB pin high	—	SNRBoost <sup>3G+</sup> , 90 MHz	SNRBoost <sup>3G+</sup> , 90 MHz
	Set SNRB 45/95MHz bit (register 42h, value 4h)	SNRBoost <sup>3G+</sup> , 45 MHz	SNRBoost <sup>3G+</sup> , 45 MHz
Set SNRB pin high	Set BMODE EN CH AB bit (register 44h, value 40h)	Burst mode: Low resolution = 11 bits at 250 MSPS High resolution = 14 bits at 250 MSPS	SNRBoost <sup>3G+</sup> , 90 MHz
Set SNRB pin high	Set BMODE EN CH CD bit (register 44h, value 80h)	SNRBoost <sup>3G+</sup> , 90 MHz	Burst mode: Low resolution = 11 bits at 250 MSPS High resolution = 14 bits at 250 MSPS
Set SNRB pin low (default)	Set both BMODE EN CH AB and BMODE EN CH CD bits (register 44h, value C0h)	Burst mode: Low resolution = 11 bits at 250 MSPS High resolution = 14 bits at 250 MSPS	Burst mode: Low resolution = 11 bits at 250 MSPS High resolution = 14 bits at 250 MSPS

**11-Bit, 250-MSPS Mode:** Output of the 11 MSBs on the digital DDR LVDS interface.

**11-Bit SNRBoost<sup>3G+</sup>, 250-MSPS Mode:** 11-bit output using SNRBoost<sup>3G+</sup> signal processing.

- 90-MHz wide (centered on  $f_s / 4$ )
- 45-MHz wide (centered on  $f_s / 8$  and  $3 f_s / 8$ )

**14-Bit, 250-MSPS (Burst) Mode:** In burst mode, the 14-bit, 250-MSPS digital output data stream alternates between high resolution (14-bit) and low resolution (11-bit). The high-resolution sample can be transmitted using the burst trigger input (TRIG\_EN). The HIRES output flag indicates high-resolution data. The amount of high-resolution samples is programmable.

There are two different options available in burst mode: auto-trigger and manual-trigger.

- *Auto-Trigger Mode:* After transmission of the final low-resolution sample, the ADS58H40 immediately begins sending the high-resolution samples. However, auto-trigger mode requires an initial trigger at the TRIG\_EN pin to start the high-resolution process. Thereafter, all subsequent triggers are automated.
- *Manual-Trigger Mode:* After transmission of the final low-resolution sample, the ADS58H40 is ready for the manual trigger of a high-resolution data burst indicated by the TRIG\_RDY flag. The high-resolution samples are triggered every time by the rising edge of the pulse on the TRIG\_EN pin.

The default mode of operation is 11-bit resolution. A set of two channels (channels A and B and channels C and D) can be in either SNRBoost<sup>3G+</sup> mode or in burst mode, separately.

SNRBoost<sup>3G+</sup> can be enabled by the SNRB pin or by the SPI bit (SNRB PIN OVRD). However, burst mode can only be enabled by using an SPI register bit. In burst mode, the automatic trigger can be enabled by setting the SPI register bit AUTO BURST ENABLE (register 41h, bit 0) and the manual trigger can be enabled through the TRIG\_EN pin. [Table 7](#) summarizes the process for enabling SNRBoost<sup>3G+</sup> from pin settings and enabling burst mode from the SPI registers on different channels.

### Burst Mode

After enabling burst mode, the device is limited to 11-bit (low-resolution) samples until a trigger is asserted through the TRIG\_EN pin. A TRIG\_EN rising edge causes the device to output a set of 14-bit (high-resolution) samples, followed by another set of 11-bit (low-resolution) samples.

In auto-trigger mode (set using the SPI register), this cycle repeats as long as the device is in burst mode. In manual-trigger mode, this cycle is followed by a delay until the next rising edge on the TRIG\_EN pin occurs. During this cycle (high-resolution samples followed by low-resolution samples), any edge on TRIG\_EN is ignored.

The HIRES output flag is set high when the device outputs high-resolution, 14-bit data; otherwise, HIRES is '0'. The TRIG\_RDY output flag is set high while the device waits for a rising edge on the TRIG\_EN pin; otherwise, this flag is cleared.

The ratio of high-resolution, 14-bit samples to low-resolution, 11-bit samples is programmable between 1:8 and 1:64. The number of high-resolution, 14-bit samples is also programmable.

The number of 14-bit, high-resolution samples is shown in [Equation 3](#):

$$2^{10 + NH}$$

where:

$$0 \leq NH \leq 15 \quad (3)$$

The number of 11-bit, low-resolution samples is shown in [Equation 4](#):

$$2^{13 + NH + NL}$$

where:

$$0 \leq NL \leq 3 \quad (4)$$

Both NH and NL parameters can be programmed through the SPI at any time, but are internally updated at the end of the high-resolution data transmission.

### Manual-Trigger Mode

Figure 55 shows a timing diagram for this mode.

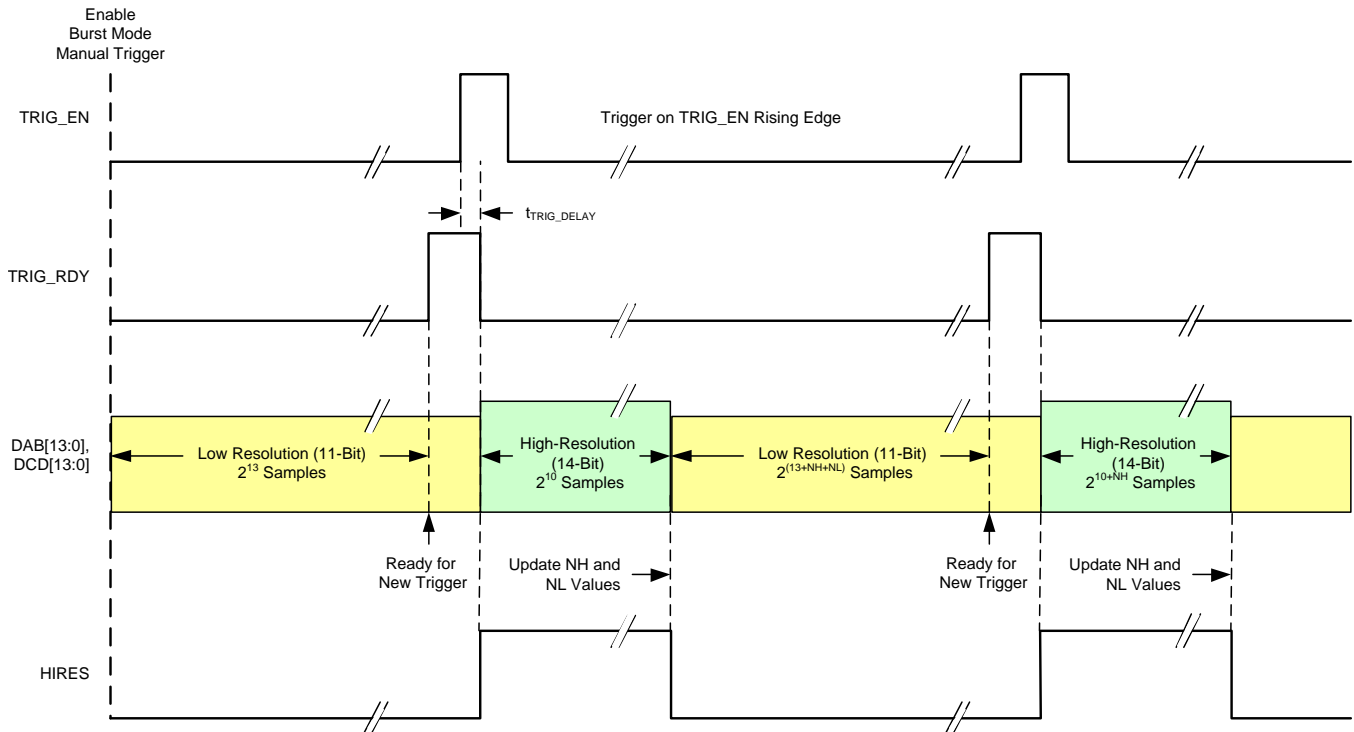

Figure 55. Timing For Manual-Trigger Mode

### Auto-Trigger Mode

In this mode, the output data cycles automatically between 11-bit and 14-bit resolution, as shown in Figure 56. After the first rising edge of the pulse on TRIG\_EN that turns the 14-bit burst mode on, the device continues to provide high-resolution samples interlaced with low-resolution samples and any subsequent edge on TRIG\_EN is ignored. The TRIG\_RDY output flag is invalid in this mode.

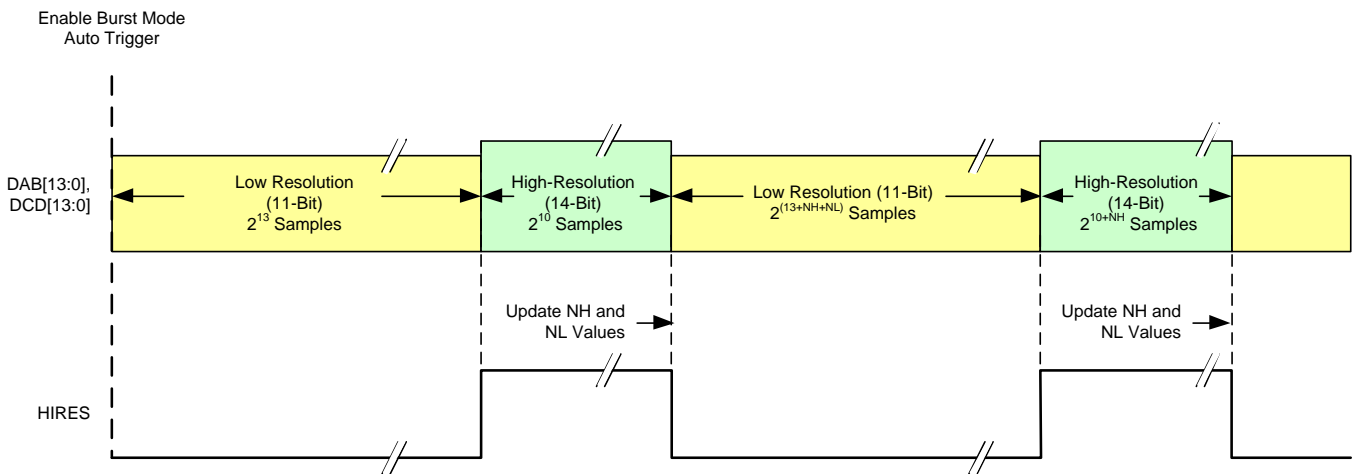
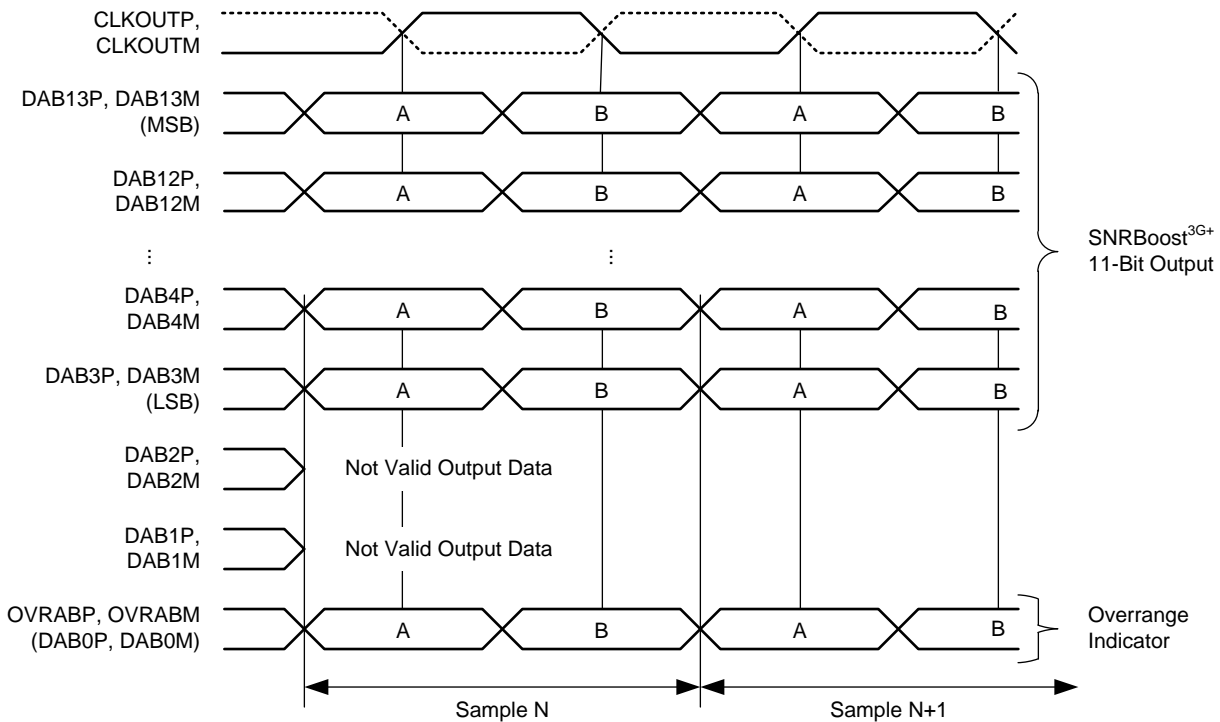

Figure 56. Timing for Auto-Trigger Mode

### Overrange Indication (OVRxx)

The ADS58H40 outputs overrange information on the Dxx0P and Dxx0M pins (where xx = channels A and B or channels C and D) of the digital output interface. When transmitting high-resolution (14-bit) output data in burst mode, Dxx0P and Dxx0M transmit the output data LSB instead. An OVR timing diagram is shown in [Figure 57](#).



**Figure 57. Overrange Indicator (OVR) Timing**

Normal overrange indication (OVR) shows the event of the ADS58H40 digital output being saturated when the input signal exceeds the ADC full-scale range. Normal OVR has the same latency as digital output data. However, an overrange event can be indicated earlier (than normal latency) by using the fast OVR mode. The fast OVR mode (enabled by default) is triggered seven clock cycles after the overrange condition that occurred at the ADC input. The fast OVR thresholds are programmable with the FAST OVR THRESH PROG bits (refer to [Table 4](#), register address C3h). At any time, either normal or fast OVR mode can be programmed on the Dxx0P and Dxx0M pins. A block diagram indicating required register writes to enable OVR is shown in [Figure 58](#).

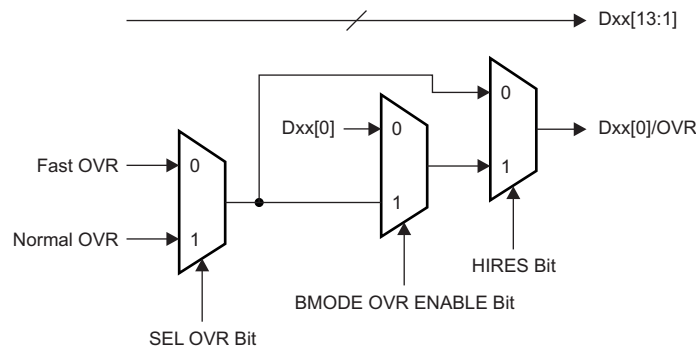

**Figure 58. OVR Block Diagram**



### SNRBoost<sup>3G+</sup> Implementation

There are two possible filter configurations in SNRBoost<sup>3G+</sup> mode. The SNRBoost<sup>3G+</sup> bandwidth can be set to 90 MHz (Figure 59) or 45 MHz (Figure 60). In the 45-MHz mode, there are two 45-MHz filter bands available simultaneously. One band is centered on  $f_S / 8$  (low side) and the other band is centered on  $3 f_S / 8$  (high side). The filter configurations are detailed in Table 8.

**Table 8. SNRBoost<sup>3G+</sup> Filter Configurations**

BANDWIDTH (MHz)	CORNER FREQUENCIES		CENTER FREQUENCY
	START	STOP	
90	$0.06 \times f_S$	$0.44 \times f_S$	$f_S / 4$
45 (low side)	$0.03 \times f_S$	$0.216 \times f_S$	$f_S / 8$
45 (high side)	$0.286 \times f_S$	$0.466 \times f_S$	$3 \times f_S / 8$

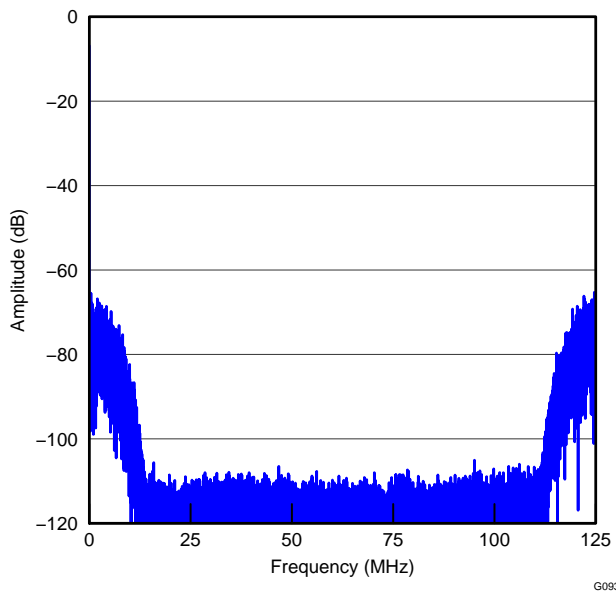

**Figure 59. 90-MHz SNRBoost<sup>3G+</sup> Filter Bandwidth Centered on  $f_S / 4$**

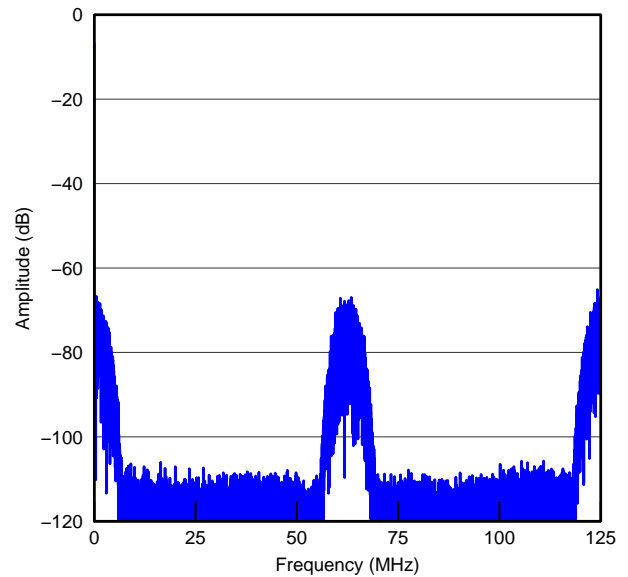

**Figure 60. 45-MHz SNRBoost<sup>3G+</sup> Filter Bandwidth Centered on  $f_S / 8$  and  $3 f_S / 8$**

## GAIN FOR SFDR AND SNR TRADE-OFF

The ADS58H40 includes gain settings that can be used to obtain improved SFDR performance. The gain is programmable from 0 dB to 6 dB (in 0.5-dB steps) using the DIGITAL GAIN CH X register bits. For each gain setting, the analog input full-scale range scales proportionally, as shown in [Table 9](#).

**Table 9. Full-Scale Range Across Gains**

GAIN (dB)	TYPE	FULL-SCALE ( $V_{PP}$ )
0	Default after reset	2
1	Fine, programmable	1.78
2	Fine, programmable	1.59
3	Fine, programmable	1.42
4	Fine, programmable	1.26
5	Fine, programmable	1.12
6	Fine, programmable	1

SFDR improvement is achieved at the expense of SNR; for each gain setting, SNR degrades by approximately 0.5 dB to 1 dB. SNR degradation is diminished at high input frequencies. As a result, the fine gain is very useful at high input frequencies because SFDR improvement is significant with marginal degradation in SNR. Therefore, fine gain can be used to trade-off between SFDR and SNR.

After a reset, the gain function is disabled. To use fine gain:

- First, program the DIGITAL ENABLE bits to enable digital functions.
- This setting enables the gain for all four channels and places the device in a 0-dB gain mode.
- For other gain settings, program the DIGITAL GAIN CH X register bits.

## DIGITAL OUTPUT INFORMATION

The ADS58H40 provides 11-bit (or 14-bit in burst mode) digital data for each channel and two output clocks in LVDS mode. Output pins are shared by a pair of channels that are accompanied by one dedicated output clock.

### DDR LVDS Outputs

In the LVDS interface mode, the data bits and clock are output using LVDS levels. The data bits of two channels are multiplexed and output on each LVDS differential pair of pins; see [Figure 61](#) and [Figure 62](#).

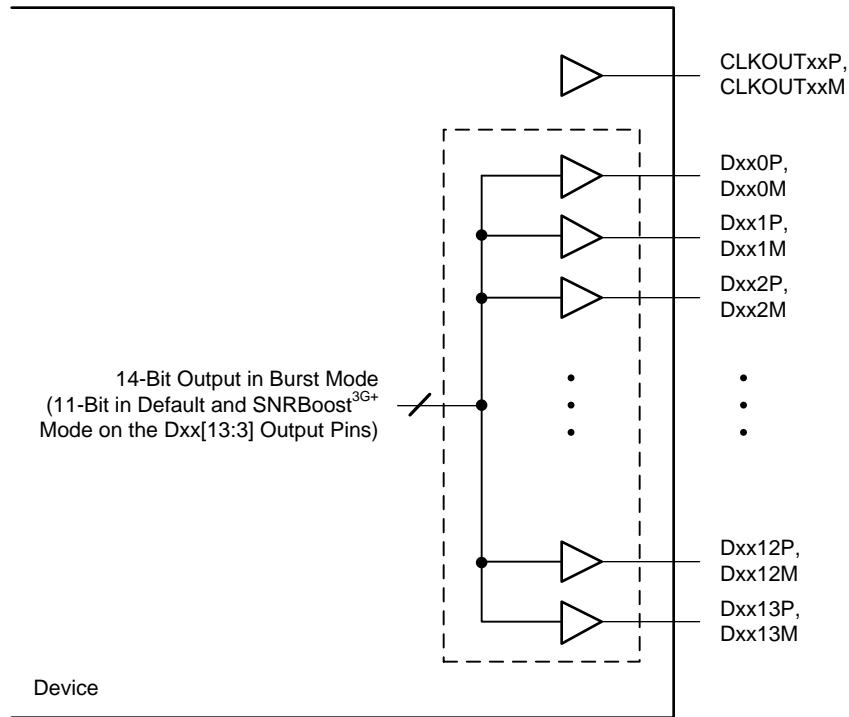

NOTE: xx = channels A and B or C and D.

Figure 61. DDR LVDS Interface

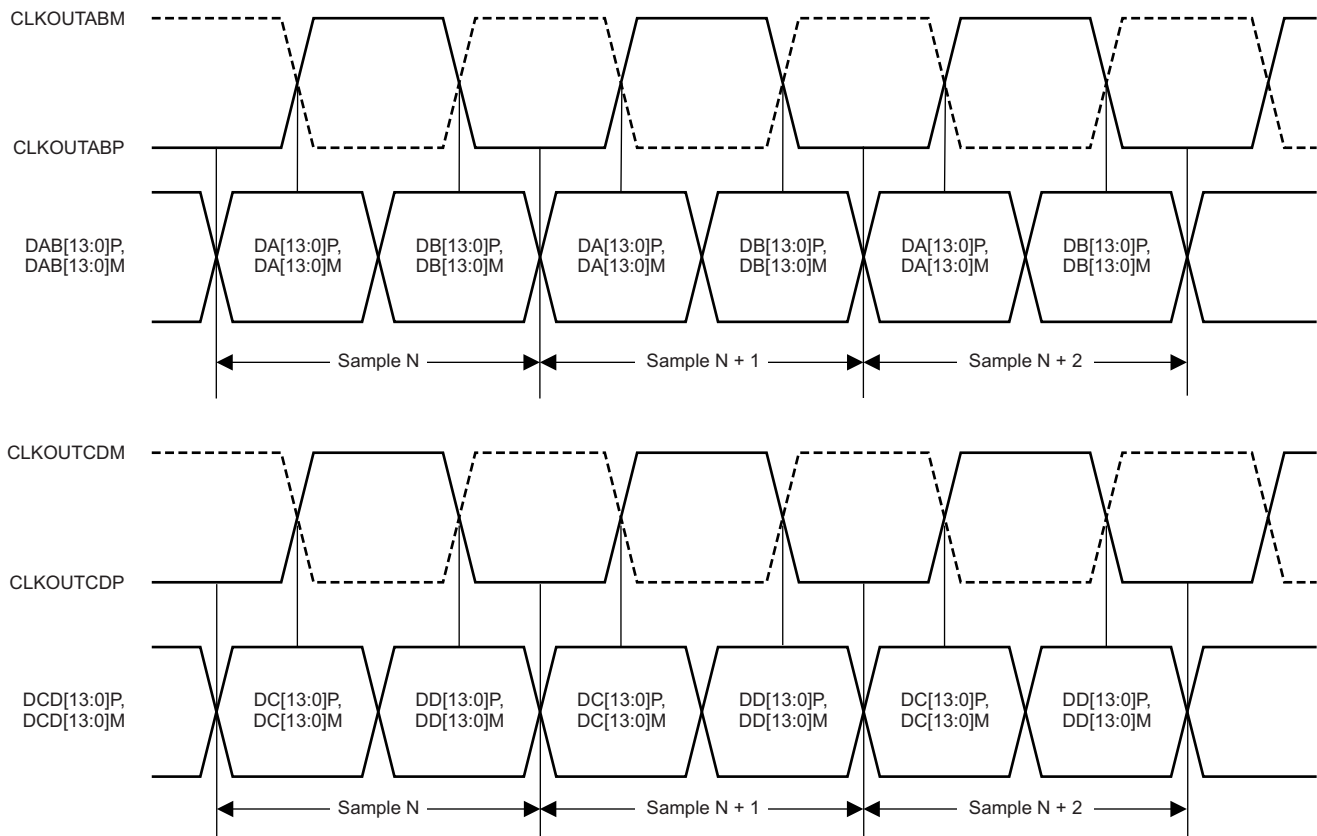
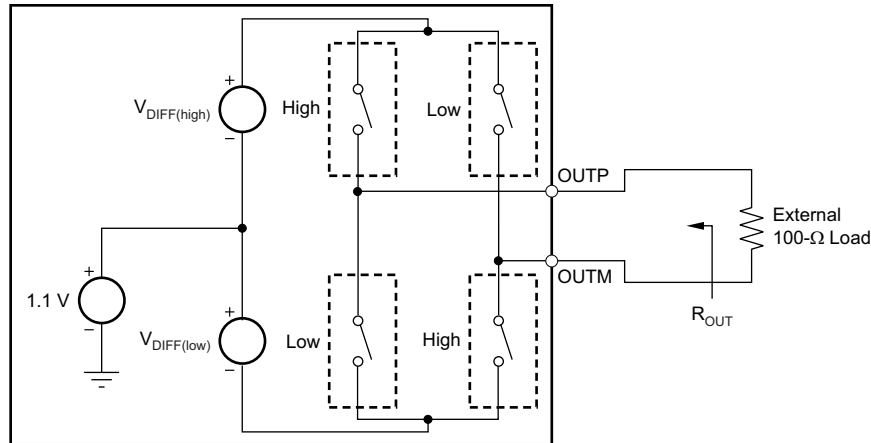

Figure 62. DDR LVDS Interface Timing Diagram

### LVDS Output Data and Clock Buffers

The equivalent circuit of each LVDS output buffer is shown in [Figure 63](#). After reset, the buffer presents an output impedance of 100  $\Omega$  to match with the external 100- $\Omega$  termination.

The  $V_{DIFF}$  voltage is nominally 350 mV, resulting in an output swing of  $\pm 350$  mV with 100- $\Omega$  external termination. The  $V_{DIFF}$  voltage is programmable using the LVDS SWING register bits (refer to [Table 4](#), register address 01h). The buffer output impedance behaves similar to a source-side series termination. By absorbing reflections from the receiver end, the source-side termination helps to improve signal integrity.



**Figure 63. LVDS Buffer Equivalent Circuit**

### Output Data Format

The ADS58H40 transmits data in binary twos complement format. In the event of an input voltage overdrive, the digital outputs go to the appropriate full-scale level. For a positive overdrive, the output code is 3FFh. For a negative input overdrive, the output code is 400h.

## BOARD DESIGN CONSIDERATIONS

For evaluation module (EVM) board information, refer to the [ADS58H40 EVM User's Guide \(SLAU455\)](#).

### Grounding

A single ground plane is sufficient to provide good performance, as long as the analog, digital, and clock sections of the board are cleanly partitioned. See the [ADS58H40 EVM User's Guide \(SLAU455\)](#) for details on layout and grounding.

## DEFINITION OF SPECIFICATIONS

**Analog Bandwidth** – The analog input frequency at which the power of the fundamental is reduced by 3 dB with respect to the low-frequency value.

**Aperture Delay** – The delay in time between the rising edge of the input sampling clock and the actual time at which the sampling occurs. This delay is different across channels. The maximum variation is specified as aperture delay variation (channel-to-channel).

**Aperture Uncertainty (Jitter)** – The sample-to-sample variation in aperture delay.

**Clock Pulse Width and Duty Cycle** – The duty cycle of a clock signal is the ratio of the time the clock signal remains at a logic high (clock pulse width) to the period of the clock signal. Duty cycle is typically expressed as a percentage. A perfect differential sine-wave clock results in a 50% duty cycle.

**Maximum Conversion Rate** – The maximum sampling rate at which specified operation is given. All parametric testing is performed at this sampling rate unless otherwise noted.

**Minimum Conversion Rate** – The minimum sampling rate at which the ADC functions.

**Differential Nonlinearity (DNL)** – An ideal ADC exhibits code transitions at analog input values spaced exactly 1 LSB apart. DNL is the deviation of any single step from this ideal value, measured in units of LSBs.

**Integral Nonlinearity (INL)** – INL is the deviation of the ADC transfer function from a best-fit line determined by a least-squares curve fit of that transfer function, measured in units of LSBs.

**Gain Error** – Gain error is the deviation of the ADC actual input full-scale range from the ideal value. Gain error is given as a percentage of the ideal input full-scale range. Gain error has two components: error as a result of reference inaccuracy and error as a result of the channel. Both errors are specified independently as  $E_{GREF}$  and  $E_{GCHAN}$ .

To a first-order approximation, the total gain error is  $E_{TOTAL} \sim E_{GREF} + E_{GCHAN}$ .

For example, if  $E_{TOTAL} = \pm 0.5\%$ , the full-scale input varies from  $(1 - 0.5 / 100) \times f_{S \text{ ideal}}$  to  $(1 + 0.5 / 100) \times f_{S \text{ ideal}}$ .

**Offset Error** – Offset error is the difference, given in number of LSBs, between the ADC actual average idle channel output code and the ideal average idle channel output code. This quantity is often mapped into millivolts.

**Temperature Drift** – The temperature drift coefficient (with respect to gain error and offset error) specifies the change per degree Celsius of the parameter from  $T_{MIN}$  to  $T_{MAX}$ . The coefficient is calculated by dividing the maximum deviation of the parameter across the  $T_{MIN}$  to  $T_{MAX}$  range by the difference  $T_{MAX} - T_{MIN}$ .

**Signal-to-Noise Ratio** – SNR is the ratio of the power of the fundamental ( $P_S$ ) to the noise floor power ( $P_N$ ), excluding the power at dc and the first nine harmonics.

$$SNR = 10 \log_{10} \frac{P_S}{P_N} \quad (5)$$

SNR is either given in units of dBc (dB to carrier) when the absolute power of the fundamental is used as the reference, or dBFS (dB to full-scale) when the power of the fundamental is extrapolated to the converter full-scale range.

**Signal-to-Noise and Distortion (SINAD)** – SINAD is the ratio of the power of the fundamental ( $P_S$ ) to the power of all the other spectral components including noise ( $P_N$ ) and distortion ( $P_D$ ), but excluding dc.

$$SINAD = 10 \log_{10} \frac{P_S}{P_N + P_D} \quad (6)$$

SINAD is either given in units of dBc (dB to carrier) when the absolute power of the fundamental is used as the reference, or dBFS (dB to full-scale) when the power of the fundamental is extrapolated to the converter full-scale range.

### REVISION HISTORY

NOTE: Page numbers for previous revisions may differ from page numbers in the current version.

<b>Changes from Revision A (August 2012) to Revision B</b>	<b>Page</b>
• Changed footnote 8 in Timing Requirements table .....	<a href="#">7</a>

**PACKAGING INFORMATION**

Orderable Device	Status (1)	Package Type	Package Drawing	Pins	Package Qty	Eco Plan (2)	Lead finish/ Ball material (6)	MSL Peak Temp (3)	Op Temp (°C)	Device Marking (4/5)	Samples
ADS58H40IZCR	ACTIVE	NFBGA	ZCR	144	184	RoHS & Green	SNAGCU	Level-3-260C-168 HR	-40 to 85	ADS58H40I	<a href="#">Samples</a>
ADS58H40IZCRR	ACTIVE	NFBGA	ZCR	144	1000	RoHS & Green	SNAGCU	Level-3-260C-168 HR	-40 to 85	ADS58H40I	<a href="#">Samples</a>

(1) The marketing status values are defined as follows:

**ACTIVE:** Product device recommended for new designs.

**LIFEBUY:** TI has announced that the device will be discontinued, and a lifetime-buy period is in effect.

**NRND:** Not recommended for new designs. Device is in production to support existing customers, but TI does not recommend using this part in a new design.

**PREVIEW:** Device has been announced but is not in production. Samples may or may not be available.

**OBSOLETE:** TI has discontinued the production of the device.

(2) **RoHS:** TI defines "RoHS" to mean semiconductor products that are compliant with the current EU RoHS requirements for all 10 RoHS substances, including the requirement that RoHS substance do not exceed 0.1% by weight in homogeneous materials. Where designed to be soldered at high temperatures, "RoHS" products are suitable for use in specified lead-free processes. TI may reference these types of products as "Pb-Free".

**RoHS Exempt:** TI defines "RoHS Exempt" to mean products that contain lead but are compliant with EU RoHS pursuant to a specific EU RoHS exemption.

**Green:** TI defines "Green" to mean the content of Chlorine (Cl) and Bromine (Br) based flame retardants meet JS709B low halogen requirements of <=1000ppm threshold. Antimony trioxide based flame retardants must also meet the <=1000ppm threshold requirement.

(3) MSL, Peak Temp. - The Moisture Sensitivity Level rating according to the JEDEC industry standard classifications, and peak solder temperature.

(4) There may be additional marking, which relates to the logo, the lot trace code information, or the environmental category on the device.

(5) Multiple Device Markings will be inside parentheses. Only one Device Marking contained in parentheses and separated by a "~" will appear on a device. If a line is indented then it is a continuation of the previous line and the two combined represent the entire Device Marking for that device.

(6) Lead finish/Ball material - Orderable Devices may have multiple material finish options. Finish options are separated by a vertical ruled line. Lead finish/Ball material values may wrap to two lines if the finish value exceeds the maximum column width.

**Important Information and Disclaimer:**The information provided on this page represents TI's knowledge and belief as of the date that it is provided. TI bases its knowledge and belief on information provided by third parties, and makes no representation or warranty as to the accuracy of such information. Efforts are underway to better integrate information from third parties. TI has taken and continues to take reasonable steps to provide representative and accurate information but may not have conducted destructive testing or chemical analysis on incoming materials and chemicals. TI and TI suppliers consider certain information to be proprietary, and thus CAS numbers and other limited information may not be available for release.

In no event shall TI's liability arising out of such information exceed the total purchase price of the TI part(s) at issue in this document sold by TI to Customer on an annual basis.





**TAPE AND REEL INFORMATION**

**QUADRANT ASSIGNMENTS FOR PIN 1 ORIENTATION IN TAPE**

\*All dimensions are nominal

Device	Package Type	Package Drawing	Pins	SPQ	Reel Diameter (mm)	Reel Width W1 (mm)	A0 (mm)	B0 (mm)	K0 (mm)	P1 (mm)	W (mm)	Pin1 Quadrant
ADS58H40IZCRR	NFBGA	ZCR	144	1000	330.0	24.4	10.25	10.25	2.25	16.0	24.0	Q1

**TAPE AND REEL BOX DIMENSIONS**

\*All dimensions are nominal

Device	Package Type	Package Drawing	Pins	SPQ	Length (mm)	Width (mm)	Height (mm)
ADS58H40IZCRR	NFBGA	ZCR	144	1000	350.0	350.0	43.0

**TRAY**

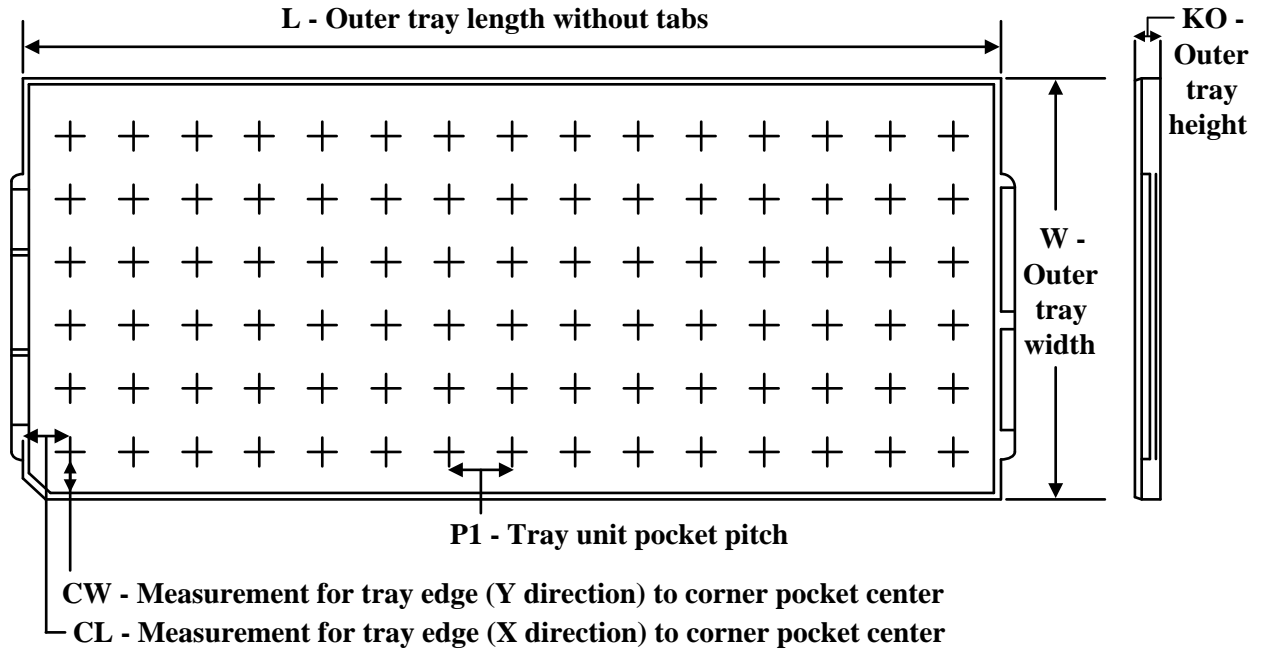

Chamfer on Tray corner indicates Pin 1 orientation of packed units.

\*All dimensions are nominal

Device	Package Name	Package Type	Pins	SPQ	Unit array matrix	Max temperature (°C)	L (mm)	W (mm)	K0 (µm)	P1 (mm)	CL (mm)	CW (mm)
ADS58H40IZCR	ZCR	NFBGA	144	184	8 x 23	150	315	135.9	7620	13.4	10.1	19.65

## GENERIC PACKAGE VIEW

**ZCR 144**

**NFBGA - 1.5 mm max height**

10 x 10 mm, 0.8 mm pitch

PLASTIC BALL GRID ARRAY

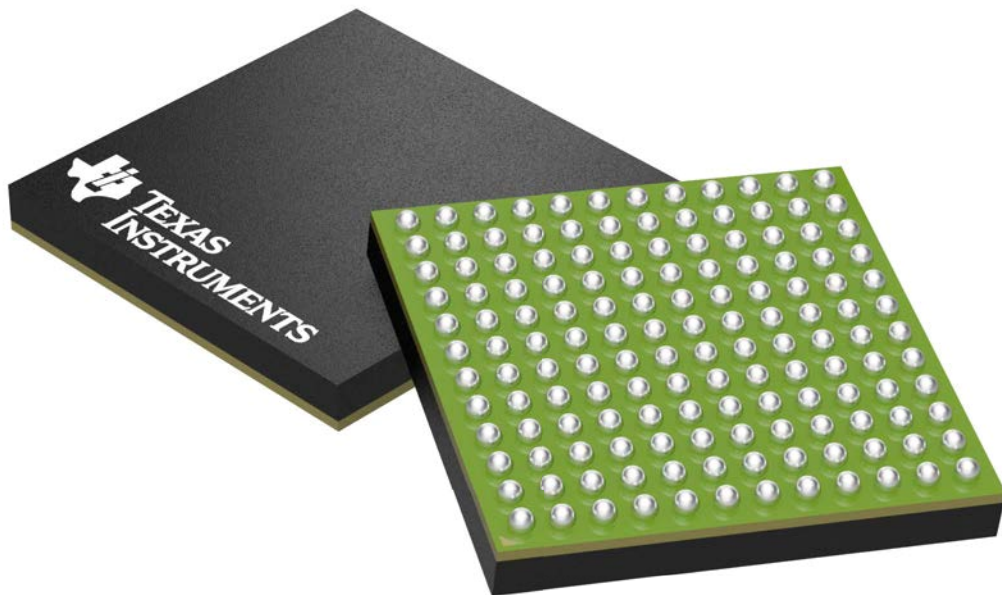

Images above are just a representation of the package family, actual package may vary.  
Refer to the product data sheet for package details.

4210272/D

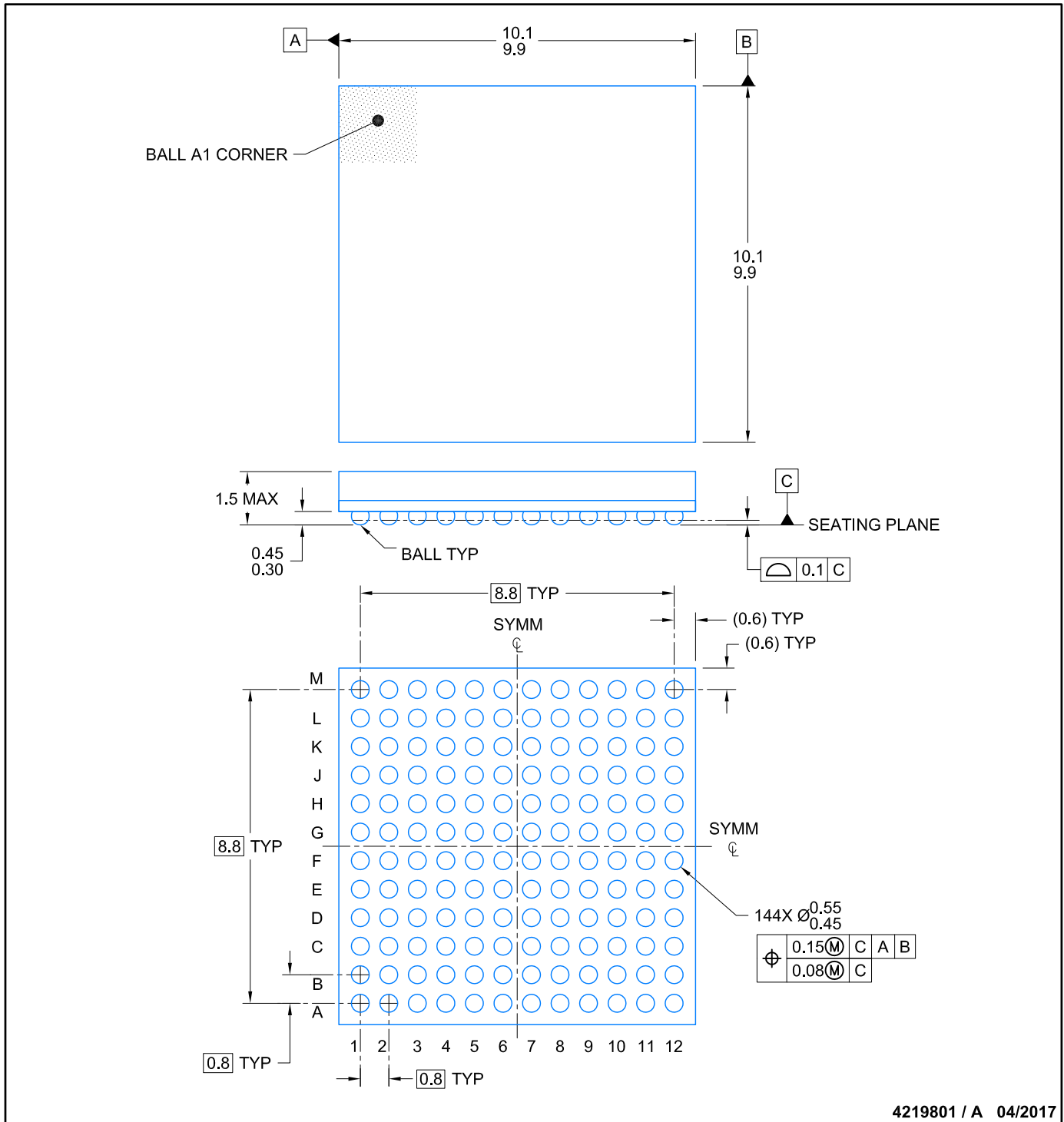

4219801 / A 04/2017

NOTES:

1. All linear dimensions are in millimeters. Any dimensions in parenthesis are for reference only. Dimensioning and tolerancing per ASME Y14.5M.
2. This drawing is subject to change without notice.

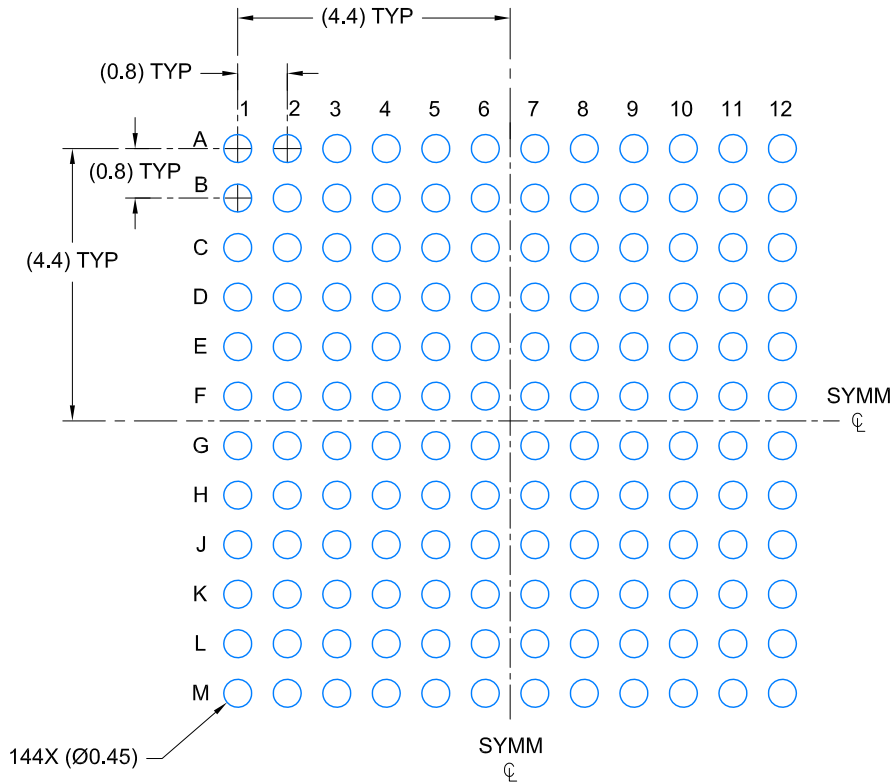

LAND PATTERN EXAMPLE  
EXPOSED METAL SHOWN  
SCALE:8X

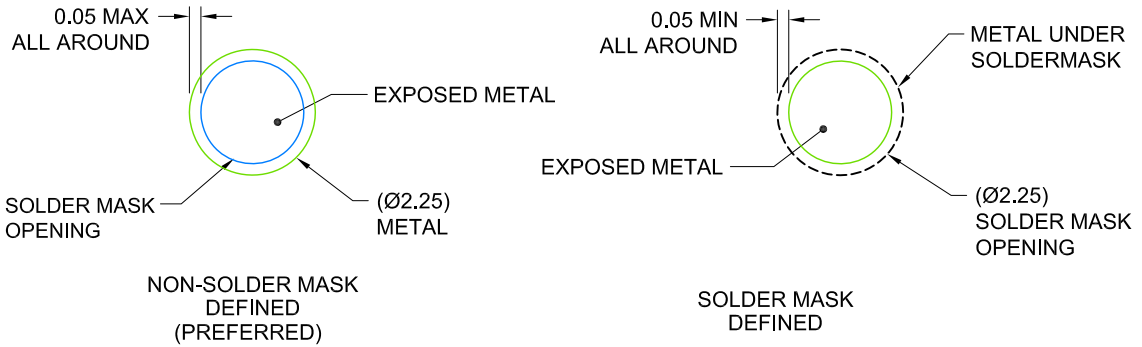

SOLDER MASK DETAILS  
NOT TO SCALE

4219801 / A 04/2017

NOTES: (continued)

- Final dimensions may vary due to manufacturing tolerance considerations and also routing constraints. Refer to Texas Instruments Literature number SPRAA99 ([www.ti.com/lit/spraa99](http://www.ti.com/lit/spraa99)).

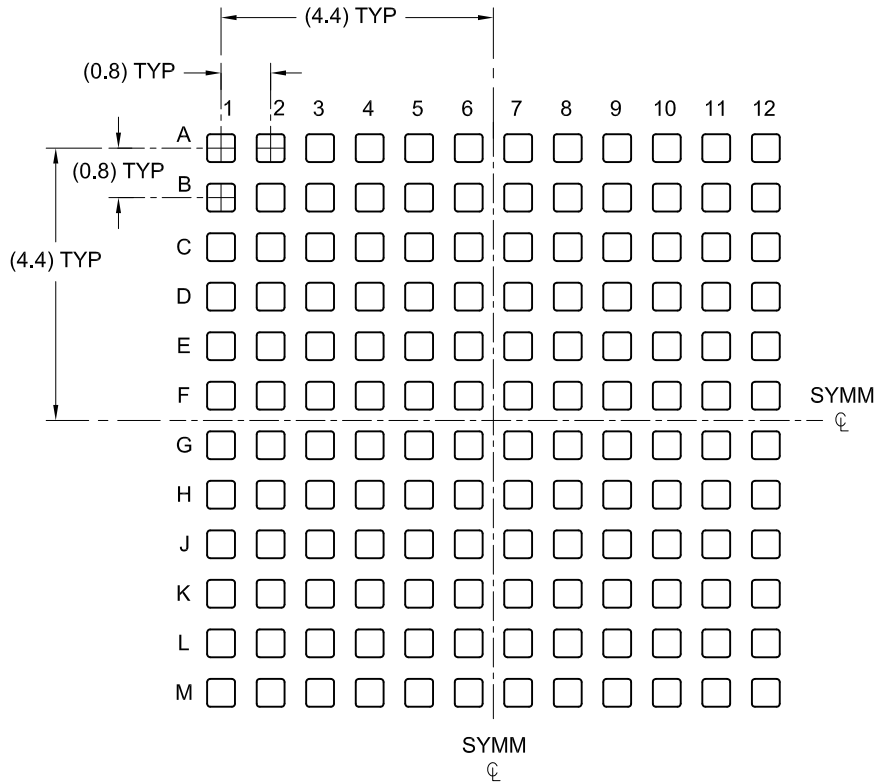

SOLDER PASTE EXAMPLE  
BASED ON 0.15 mm THICK STENCIL  
SCALE: 8X

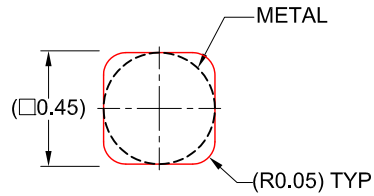

DETAIL  
SCALE:32X

4219801 / A 04/2017

NOTES: (continued)

4. Laser cutting apertures with trapezoidal walls and rounded corners may offer better paste release.

## 重要声明和免责声明

TI“按原样”提供技术和可靠性数据（包括数据表）、设计资源（包括参考设计）、应用或其他设计建议、网络工具、安全信息和其他资源，不保证没有瑕疵且不做任何明示或暗示的担保，包括但不限于对适销性、某特定用途方面的适用性或不侵犯任何第三方知识产权的暗示担保。

这些资源可供使用 TI 产品进行设计的熟练开发人员使用。您将自行承担以下全部责任：(1) 针对您的应用选择合适的 TI 产品，(2) 设计、验证并测试您的应用，(3) 确保您的应用满足相应标准以及任何其他功能安全、信息安全、监管或其他要求。

这些资源如有变更，恕不另行通知。TI 授权您仅可将这些资源用于研发本资源所述的 TI 产品的应用。严禁对这些资源进行其他复制或展示。您无权使用任何其他 TI 知识产权或任何第三方知识产权。您应全额赔偿因在这些资源的使用中对 TI 及其代表造成的任何索赔、损害、成本、损失和债务，TI 对此概不负责。

TI 提供的产品受 [TI 的销售条款](#) 或 [ti.com](#) 上其他适用条款/TI 产品随附的其他适用条款的约束。TI 提供这些资源并不会扩展或以其他方式更改 TI 针对 TI 产品发布的适用的担保或担保免责声明。

TI 反对并拒绝您可能提出的任何其他或不同的条款。

邮寄地址：Texas Instruments, Post Office Box 655303, Dallas, Texas 75265

Copyright © 2023，德州仪器 (TI) 公司