

Table of Contents

1 特性	1	8.2 Functional Block Diagram.....	20
2 应用	1	8.3 Feature Description.....	20
3 说明	1	8.4 Device Functional Modes.....	23
4 Revision History	2	8.5 Programming.....	23
5 Device Comparison Table	3	8.6 Register Map.....	30
6 Pin Configuration and Functions	3	9 Application and Implementation	34
7 Specifications	4	9.1 Application Information.....	34
7.1 Absolute Maximum Ratings.....	4	9.2 Typical Application.....	34
7.2 ESD Ratings.....	4	9.3 Power Supply Recommendations.....	37
7.3 Recommended Operating Conditions.....	4	9.4 Layout.....	37
7.4 Thermal Information.....	5	10 Device and Documentation Support	38
7.5 Electrical Characteristics.....	5	10.1 Documentation Support.....	38
7.6 Timing Requirements: SPI Mode.....	9	10.2 接收文档更新通知.....	38
7.7 Timing Requirements: I ² C Standard Mode.....	9	10.3 支持资源.....	38
7.8 Timing Requirements: I ² C Fast Mode.....	9	10.4 Trademarks.....	38
7.9 Timing Requirements: I ² C Fast-Mode Plus.....	10	10.5 静电放电警告.....	38
7.10 Timing Diagrams.....	10	10.6 术语表.....	38
7.11 Typical Characteristics.....	11	11 Mechanical, Packaging, and Orderable Information	38
8 Detailed Description	20		
8.1 Overview.....	20		

4 Revision History

注：以前版本的页码可能与当前版本的页码不同

Changes from Revision D (February 2020) to Revision E (August 2023)	Page
• 更新了整个文档中的表格、图和交叉参考的编号格式.....	1
• Added two rows for input current in <i>Absolute Maximum Ratings</i>	4
• Changed output voltage drift vs time test conditions under <i>Voltage Reference Output</i> from T _A = 35°C, 1900 hr to T _A = 25°C, 1600 hr in the <i>Electrical Characteristics</i>	5
• Changed output voltage drift vs time value under <i>Voltage Reference Output</i> from 20 μV to 50 ppm in the <i>Electrical Characteristics</i>	5
• Changed Figure 7-48, <i>Internal Reference Voltage vs Temperature</i>	11
• Changed Figure 7-49, <i>Internal Reference Voltage vs Supply Voltage</i>	11
• Added text to end of paragraph to clarify phase margin in <i>Output Amplifier</i> section.....	21
• Changed text in <i>Internal Reference</i> section for clarity.....	21
• Changed all instances of legacy terminology to controller and target where I ² C is mentioned.....	24
• Changed section 8.6.2, <i>DEVID Register</i> , to clarify and correct reset values.....	30
Changes from Revision C (November 2019) to Revision D (February 2020)	Page
• Changed Figure 29 to remove broken text from x axis (typo).....	11
• Changed Figures 33, 34 and 35; updated for clarity.....	11
Changes from Revision B (August 2019) to Revision C (November 2019)	Page
• 将 DGS (VSSOP) 封装从预发布更改为量产数据 (正在供货)	1
• Added TUE parameter for DGS package to electrical characteristics table.....	5
• Added gain error parameter for DGS package to electrical characteristics table.....	5
• Added full-scale error parameter for DGS package to electrical characteristics table.....	5
Changes from Revision A (August 2019) to Revision B (August 2019)	Page
• 将 DAC70501 和 DAC60501 器件从预发布更改为量产数据 (正在供货)	1

5 Device Comparison Table

DEVICE	RESOLUTION	REFERENCE	POWER-ON RESET
DAC80501Z	16-bit	Internal (default) or external	Zero scale
DAC80501M	16-bit	Internal (default) or external	Midscale
DAC70501Z	14-bit	Internal (default) or external	Zero scale
DAC70501M	14-bit	Internal (default) or external	Midscale
DAC60501Z	12-bit	Internal (default) or external	Zero scale
DAC60501M	12-bit	Internal (default) or external	Midscale

6 Pin Configuration and Functions



图 6-1. DGS Package, 10-Pin VSSOP (Top View)



图 6-2. DQF Package, 8-Pin WSON (Top View)

表 6-1. Pin Functions

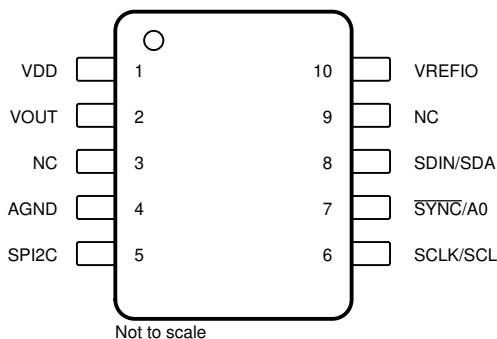
NAME	PIN		TYPE	DESCRIPTION
	DGS (VSSOP)	DQF (WSON)		
AGND	4	3	Ground	Ground reference point for all circuitry on the device.
NC	3	—	—	No connection. Leave floating.
NC	9	—	—	No connection. Leave floating.
SCLK/SCL	6	5	Input	Serial interface clock. SPI or I ² C mode.
SDIN/SDA	8	7	Input/output	SPI mode: Serial interface data input. Data are clocked into the input shift register on each falling edge of the SCLK pin. I ² C mode: Data are clocked into or out of the input register. This pin is a bidirectional, SDA drain data line that must be connected to the supply voltage with an external pullup resistor.
SPI2C	5	4	Input	Interface select pin. Digital interface in SPI mode if SPI2C = 0 Digital interface in I ² C mode if SPI2C = 1 SPI2C pin must be kept static after device powers up.
SYNC/A0	7	6	Input	SPI mode: Active low serial data enable. This input is the frame synchronization signal for the serial data. When the signal goes low, the serial interface input shift register is enabled. I ² C mode: Four-state address input 0.
VDD	1	1	Power	Analog supply voltage (2.7 V to 5.5 V)
VOUT	2	2	Output	Analog output voltage from the DAC
VREFIO	10	8	Input/output	When using the internal reference, this pin is the reference output voltage pin (default). Reference input to the device when operating with external reference.

7 Specifications

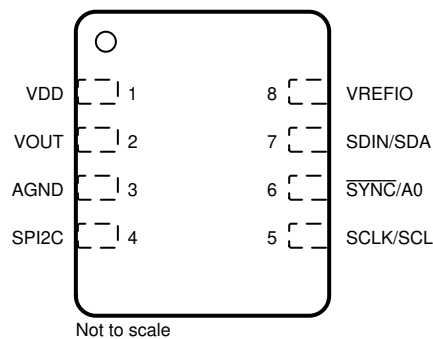
7.1 Absolute Maximum Ratings

over operating free-air temperature range (unless otherwise noted)⁽¹⁾

			MIN	MAX	UNIT
Input voltage	VDD to AGND		- 0.3	6	V
	VREFIO to AGND		- 0.3	VDD + 0.3	
	Digital inputs to AGND		- 0.3	VDD + 0.3	
Output voltage	VOUT to AGND		- 0.3	VDD + 0.3	V
Input current	Current into any digital pins		- 10	10	mA
	Current into VDD, AGND, VOUT		- 30	30	mA
	Current into VREFIO		- 100	100	mA
T _J	Junction temperature		- 40	150	°C
T _{stg}	Storage temperature		- 65	150	°C

- (1) Stresses beyond those listed under Absolute Maximum Ratings may cause permanent damage to the device. These are stress ratings only, which do not imply functional operation of the device at these or any other conditions beyond those indicated under Recommended Operating Conditions. Exposure to absolute-maximum-rated conditions for extended periods may affect device reliability.

7.2 ESD Ratings

			VALUE	UNIT
V _(ESD)	Electrostatic discharge	Human body model (HBM), per ANSI/ESDA/JEDEC JS-001, all pins ⁽¹⁾	±2000	V
		Charged device model (CDM), per JEDEC specification JESD22-C101, all pins ⁽²⁾	±1000	

- (1) JEDEC document JEP155 states that 500-V HBM allows safe manufacturing with a standard ESD control process.
(2) JEDEC document JEP157 states that 250-V CDM allows safe manufacturing with a standard ESD control process.

7.3 Recommended Operating Conditions

over operating free-air temperature range (unless otherwise noted)

		MIN	NOM	MAX	UNIT
POWER SUPPLY					
VDD to AGND	Positive supply voltage to ground	2.7		5.5	V
DIGITAL INPUTS					
VIH	Input high voltage	1.62			V
VIL	Input low voltage			0.45	V
REFERENCE INPUT					
VREFIO to AGND	2.7 V ≤ VDD < 3.3 V, reference divider disabled (REF-DIV bit = 0)	1.2		0.5 × (VDD - 0.2)	V
VREFIO to AGND	2.7 V ≤ VDD < 3.3 V, reference divider enabled (REF-DIV bit = 1)	2.4		(VDD - 0.2)	V
VREFIO to AGND	3.3 V ≤ VDD ≤ 5.5 V, reference divider disabled (REF-DIV bit = 0)	1.2		0.5 × VDD	V
VREFIO to AGND	3.3 V ≤ VDD ≤ 5.5 V, reference divider enabled (REF-DIV bit = 1)	2.4		VDD	V
TEMPERATURE					
T _A	Operating temperature	- 40		125	°C

7.4 Thermal Information

THERMAL METRIC ⁽¹⁾		DACx0501		UNIT
		DGS (VSSOP)	DQF (WSON)	
		10 PINS	8 PINS	
R _{θJA}	Junction-to-ambient thermal resistance	170.1	122.6	°C/W
R _{θJC(top)}	Junction-to-case (top) thermal resistance	60.5	58.3	°C/W
R _{θJB}	Junction-to-board thermal resistance	92.6	50	°C/W
Ψ _{JT}	Junction-to-top characterization parameter	7.8	1.5	°C/W
Ψ _{JB}	Junction-to-board characterization parameter	90.7	49.8	°C/W

(1) For more information about traditional and new thermal metrics, see the [Semiconductor and IC Package Thermal Metrics application report](#).

7.5 Electrical Characteristics

all minimum and maximum values at T_A = -40°C to +125°C; all typical values at T_A = 25°C, 2.7 V ≤ VDD ≤ 5.5 V, external or internal VREFIO = 1.25 V to 5.5 V, R_{LOAD} = 2 kΩ to AGND, C_{LOAD} = 200 pF to AGND, and digital inputs at VDD or AGND (unless otherwise noted)

PARAMETER		TEST CONDITIONS	MIN	TYP	MAX	UNIT
STATIC PERFORMANCE						
	Resolution	DAC80501	16			Bits
		DAC70501	14			
		DAC60501	12			
INL	Integral nonlinearity ⁽¹⁾		-1		1	LSB
DNL	Differential nonlinearity ⁽¹⁾		-1		1	LSB
TUE	Total unadjusted error ⁽¹⁾	DAC80501, reference divider disabled (REF-DIV bit = 0)	-0.08	-0.02	0.08	%FSR
		DAC80501, reference divider enabled (REF-DIV bit = 1)	-0.06	0.025	0.06	
		DAC80501, DGS package reference divider enabled (REF-DIV bit = 1)	-0.07	0.025	0.07	
		DAC70501, DAC60501	-0.1	0.04	0.1	
	Zero code error ⁽¹⁾	DAC loaded with zero scale code	-1.5	0.5	1.5	mV
	Zero code error temperature coefficient ⁽¹⁾			±2		μV/°C
	Offset error ⁽¹⁾		-1.5	0.5	1.5	mV
	Offset error temperature coefficient ⁽¹⁾			±2		μV/°C
	Gain error ⁽¹⁾	DAC80501, reference divider disabled (REF-DIV bit = 0)	-0.08	-0.02	0.08	%FSR
		DAC80501, reference divider enabled (REF-DIV bit = 1)	-0.06	0.025	0.06	
		DAC80501, DGS package reference divider enabled (REF-DIV bit = 1)	-0.07	0.025	0.07	
		DAC70501, DAC60501	-0.1	0.04	0.1	
	Gain error temperature coefficient ⁽¹⁾			±1		ppm FSR/°C

7.5 Electrical Characteristics (continued)

all minimum and maximum values at $T_A = -40^\circ\text{C}$ to $+125^\circ\text{C}$; all typical values at $T_A = 25^\circ\text{C}$, $2.7\text{ V} \leq V_{DD} \leq 5.5\text{ V}$, external or internal $V_{REFIO} = 1.25\text{ V}$ to 5.5 V , $R_{LOAD} = 2\text{ k}\Omega$ to AGND, $C_{LOAD} = 200\text{ pF}$ to AGND, and digital inputs at V_{DD} or AGND (unless otherwise noted)

PARAMETER		TEST CONDITIONS	MIN	TYP	MAX	UNIT
	Full-scale error ⁽¹⁾	DAC80501, DAC loaded with full scale, reference divider disabled (REF-DIV bit = 0)	-0.08	-0.02	0.08	%FSR
		DAC80501, DAC loaded with full scale, reference divider enabled (REF-DIV bit = 1)	-0.06	0.025	0.06	
		DAC80501, DGS package reference divider enabled (REF-DIV bit = 1)	-0.07	0.025	0.07	
		DAC70501, DAC60501	-0.1	0.04	0.1	
	Full-scale error temperature coefficient ⁽¹⁾			±2		ppm FSR/°C
OUTPUT CHARACTERISTICS						
V_O	Output voltage	BUFF-GAIN bit set to 1, REF-DIV bit set to 0	0		$2 \times V_{REFIO}$	V
		BUFF-GAIN bit set to 1, REF-DIV bit set to 1	0		V_{REFIO}	
		BUFF-GAIN bit set to 0, REF-DIV bit set to 1	0		$0.5 \times V_{REFIO}$	
R_{LOAD}	Resistive load ⁽²⁾	$V_{DD} = 2.7\text{ V}$	0.25			kΩ
		$V_{DD} = 5.5\text{ V}$	0.5			
C_{LOAD}	Capacitive load ⁽²⁾	$R_{LOAD} = \text{infinite}$			2	nF
		$R_{LOAD} = 2\text{ k}\Omega$			10	
	Load regulation	DAC at midscale, $-10\text{ mA} \leq I_{OUT} \leq 10\text{ mA}$		80		μV/mA
	Short circuit current	Full scale output shorted to AGND		30		mA
		Zero output shorted to VDD		30		
	Output voltage headroom	to VDD, DAC at full code, $I_{OUT} = 10\text{ mA}$ (sourcing)	0.3	0.1		V
	Output voltage footroom	to AGND, DAC at zero code, $I_{OUT} = 10\text{ mA}$ (sinking)	0.3			V
Z_O	DC small signal output impedance	DAC at midscale		0.1		Ω
		DAC at code 256		10		
		DAC at code 65279		10		
	Power supply rejection ratio (DC)	DAC at midscale; $V_{DD} = 5\text{ V} \pm 10\%$		0.15		mV/V
	Output voltage drift vs time	$T_A = 35^\circ\text{C}$, $V_{OUT} = \text{midscale}$, 1900 hr		20		ppm of FSR
VOLTAGE REFERENCE INPUT						
Z_{VREFIO}	Reference input impedance (VREFIO)			100		kΩ
C_{VREFIO}	Reference input capacitance (VREFIO)			5		pF

7.5 Electrical Characteristics (continued)

all minimum and maximum values at $T_A = -40^\circ\text{C}$ to $+125^\circ\text{C}$; all typical values at $T_A = 25^\circ\text{C}$, $2.7\text{ V} \leq V_{DD} \leq 5.5\text{ V}$, external or internal $V_{REFIO} = 1.25\text{ V}$ to 5.5 V , $R_{LOAD} = 2\text{ k}\Omega$ to AGND, $C_{LOAD} = 200\text{ pF}$ to AGND, and digital inputs at V_{DD} or AGND (unless otherwise noted)

PARAMETER		TEST CONDITIONS	MIN	TYP	MAX	UNIT
VOLTAGE REFERENCE OUTPUT						
	Output (initial accuracy) ⁽³⁾	$T_A = 25^\circ\text{C}$	2.4975		2.5025	V
	Output drift ⁽³⁾	DAC80501			5	ppm/ $^\circ\text{C}$
		DAC70501, DAC60501			10	
	Output impedance ⁽³⁾			0.1		Ω
	Output noise ⁽³⁾	0.1 Hz to 10 Hz		14		μV_{PP}
	Output noise density ⁽³⁾	Measured at 10 kHz, reference load = 10 nF		140		$\text{nV}/\sqrt{\text{Hz}}$
	Load current ⁽³⁾	$-0.5\text{ mV} < \Delta V_{ref} < 0.5\text{ mV}$		± 5		mA
	Load regulation ⁽³⁾	Sourcing and sinking		90		$\mu\text{V}/\text{mA}$
	Line regulation ⁽³⁾			20		$\mu\text{V}/\text{V}$
	Output voltage drift vs time ⁽³⁾	$T_A = 25^\circ\text{C}$, 1600 hr		50		ppm of FSR
	Thermal hysteresis ⁽³⁾	1st cycle		500		μV
		Additional cycle			25	
DYNAMIC PERFORMANCE						
t_s	Output voltage settling time ⁽⁴⁾	$1/4$ to $3/4$ scale and $3/4$ to $1/4$ scale settling to ± 2 LSB, $V_{DD} = 5.5\text{ V}$, $V_{REFIO} = 2.5\text{ V}$		5		μs
		10-mV settling to ± 2 LSB, $V_{DD} = 5.5\text{ V}$, $V_{REFIO} = 2.5\text{ V}$		3		
	Slew rate ⁽⁴⁾	$V_{DD} = 5.5\text{ V}$, $V_{REFIO} = 2.5\text{ V}$		2		$\text{V}/\mu\text{s}$
	Power on glitch magnitude	$C_{LOAD} = 50\text{ pF}$		200		mV
V_n	Output noise ⁽⁴⁾	0.1 Hz to 10 Hz, DAC at midscale, $V_{DD} = 5.5\text{ V}$, external $V_{REFIO} = 2.5\text{ V}$		14		μV_{PP}
		100-kHz Bandwidth, DAC at midscale, $V_{DD} = 5.5\text{ V}$, external $V_{REFIO} = 2.5\text{ V}$		23		μV_{rms}
V_n	Output noise density	Measured at 1 kHz, DAC at midscale, $V_{DD} = 5.5\text{ V}$, external $V_{REFIO} = 2.5\text{ V}$, gain = $2 \times$ (BUFF-GAIN bit = 1)		78		$\text{nV}/\sqrt{\text{Hz}}$
		Measured at 10 kHz, DAC at midscale, $V_{DD} = 5.5\text{ V}$, external $V_{REFIO} = 2.5\text{ V}$, gain = $2 \times$ (BUFF-GAIN bit = 1)		74		
		Measured at 1 kHz, DAC at full scale, $V_{DD} = 2.7\text{ V}$, external $V_{REFIO} = 2.5\text{ V}$, gain = $1 \times$ (BUFF-GAIN bit = 0)		55		
		Measured at 10 kHz, DAC at full scale, $V_{DD} = 2.7\text{ V}$, external $V_{REFIO} = 2.5\text{ V}$, gain = $1 \times$ (BUFF-GAIN bit = 0)		50		
SFDR	Spurious free dynamic range	1-kHz sinusoid at DAC output, DAC updated at 500 kHz, include up to 7th harmonics, no filter on DAC output		70		dB
THD	Total harmonic distortion	1-kHz sinusoid at DAC output, DAC updated at 500 kHz, include up to 7th harmonics, no filter on DAC output		70		dB
	Power supply rejection ratio (ac)	200-mV 50-Hz to 60-Hz sine wave superimposed on power supply voltage, DAC at midscale. (ac analysis)		85		dB
	Code change glitch impulse	Midcode ± 1 LSB (including feedthrough)		4		nV-s

7.5 Electrical Characteristics (continued)

all minimum and maximum values at $T_A = -40^\circ\text{C}$ to $+125^\circ\text{C}$; all typical values at $T_A = 25^\circ\text{C}$, $2.7\text{ V} \leq V_{DD} \leq 5.5\text{ V}$, external or internal $V_{REFIO} = 1.25\text{ V}$ to 5.5 V , $R_{LOAD} = 2\text{ k}\Omega$ to AGND, $C_{LOAD} = 200\text{ pF}$ to AGND, and digital inputs at V_{DD} or AGND (unless otherwise noted)

PARAMETER		TEST CONDITIONS	MIN	TYP	MAX	UNIT
	Code change glitch magnitude	Midcode ± 1 LSB (including feedthrough) gain = $1 \times$ (BUFF-GAIN bit = 0)		7.5		mV
	Digital feedthrough	At SCLK = 1 MHz, DAC output at midscale		4		nV-s
DIGITAL INPUTS						
	Hysteresis voltage			0.4		V
	Input current		- 5		5	μA
	Pin capacitance	Per pin		10		pF
POWER REQUIREMENTS						
I_{VDD}	Current flowing into VDD	Normal mode, internal reference enabled, DAC at full scale, SPI static		1.5	2.0	mA
		Normal mode, external reference = 2.5 V, DAC at full scale, SPI static		1	1.4	
		DAC and Internal reference power-down		15		μA
I_{VREFIO}	Current flowing into VREFIO	0-V to 5-V range, midscale code		25		μA

- (1) End point fit between code 256 to code 64,511 for 16-bit, code 64 to code 16,127 for 14-bit, code 16 to code 4031 for 12 bit, DAC output unloaded, performance under resistive and capacitance load conditions are specified by design and characterization, DAC output range $\geq 2.5\text{ V}$.
- (2) Not production tested.
- (3) Characterized on 8-pin DQF package.
- (4) Output buffer in gain = $2 \times$ setting (BUFF-GAIN bit = 1).

7.6 Timing Requirements: SPI Mode

all input signals are specified with $t_R = t_F = 1 \text{ ns/V}$ and timed from a voltage level of $(V_{IL} + V_{IH}) / 2$. $2.7 \text{ V} \leq V_{DD} \leq 5.5 \text{ V}$, $V_{IH} = 1.62 \text{ V}$, $V_{IL} = 0.15 \text{ V}$, $V_{REFIO} = 1.25 \text{ V to } 5.5 \text{ V}$, and $T_A = -40^\circ\text{C to } +125^\circ\text{C}$ (unless otherwise noted)

		MIN	NOM	MAX	UNIT
f_{SCLK}	SCLK frequency			50	MHz
$t_{SCLKHIGH}$	SCLK high time	9			ns
$t_{SCLKLOW}$	SCLK low time	9			ns
t_{SDIS}	SDIN setup	5			ns
t_{SDIH}	SDIN hold	10			ns
t_{SYNCS}	\overline{SYNC} falling edge to SCLK falling edge setup	13			ns
t_{SYNCH}	SCLK falling edge to \overline{SYNC} rising edge	10			ns
$t_{SYNCHIGH}$	\overline{SYNC} high time	160			ns
$t_{SYNCIGNORE}$	SCLK falling edge to \overline{SYNC} ignore	15			ns
$t_{DACWAIT}$	Sequential DAC update wait time	1			μs

7.7 Timing Requirements: I²C Standard Mode

all input signals are specified with $t_R = t_F = 1 \text{ ns/V}$ and timed from a voltage level of $(V_{IL} + V_{IH}) / 2$. $2.7 \text{ V} \leq V_{DD} \leq 5.5 \text{ V}$, $V_{IH} = 1.62 \text{ V}$, $V_{IL} = 0.45 \text{ V}$, $V_{REFIO} = 1.25 \text{ V to } 5.5 \text{ V}$, and $T_A = -40^\circ\text{C to } +125^\circ\text{C}$ (unless otherwise noted)

		MIN	NOM	MAX	UNIT
f_{SCLK}	SCL frequency			0.1	MHz
t_{BUF}	Bus free time between stop and start conditions	4.7			μs
t_{HDSTA}	Hold time after repeated start	4			μs
t_{SUSTA}	Repeated start setup time	4.7			μs
t_{SUSTO}	Stop condition setup time	4			μs
t_{HDDAT}	Data hold time	0			ns
t_{SUDAT}	Data setup time	250			ns
t_{LOW}	SCL clock low period	4700			ns
t_{HIGH}	SCL clock high period	4000			ns
t_R	Clock and data fall time			300	ns
t_F	Clock and data rise time			1000	ns
t_{UPDATE}	Sequential DAC update wait time	1			μs

7.8 Timing Requirements: I²C Fast Mode

all input signals are specified with $t_R = t_F = 1 \text{ ns/V}$ and timed from a voltage level of $(V_{IL} + V_{IH}) / 2$. $2.7 \text{ V} \leq V_{DD} \leq 5.5 \text{ V}$, $V_{IH} = 1.62 \text{ V}$, $V_{IL} = 0.45 \text{ V}$, $V_{REFIO} = 1.25 \text{ V to } 5.5 \text{ V}$, and $T_A = -40^\circ\text{C to } +125^\circ\text{C}$ (unless otherwise noted)

		MIN	NOM	MAX	UNIT
f_{SCLK}	SCL frequency			0.4	MHz
t_{BUF}	Bus free time between stop and start conditions	1.3			μs
t_{HDSTA}	Hold time after repeated start	0.6			μs
t_{SUSTA}	Repeated start setup time	0.6			μs
t_{SUSTO}	Stop condition setup time	0.6			μs
t_{HDDAT}	Data hold time	0			ns
t_{SUDAT}	Data setup time	100			ns
t_{LOW}	SCL clock low period	1300			ns
t_{HIGH}	SCL clock high period	600			ns
t_R	Clock and data fall time			300	ns
t_F	Clock and data rise time			300	ns
t_{UPDATE}	Sequential DAC update wait time	1			μs

7.9 Timing Requirements: I²C Fast-Mode Plus

all input signals are specified with $t_R = t_F = 1 \text{ ns/V}$ and timed from a voltage level of $(V_{IL} + V_{IH}) / 2$. $2.7 \text{ V} \leq V_{DD} \leq 5.5 \text{ V}$, $V_{IH} = 1.62 \text{ V}$, $V_{IL} = 0.45 \text{ V}$, $V_{REFIO} = 1.25 \text{ V to } 5.5 \text{ V}$, and $T_A = -40^\circ\text{C to } +125^\circ\text{C}$ (unless otherwise noted)

		MIN	NOM	MAX	UNIT
f_{SCLK}	SCL frequency			1	MHz
t_{BUF}	Bus free time between stop and start conditions	0.5			μs
t_{HDSTA}	Hold time after repeated start	0.26			μs
t_{SUSTA}	Repeated start setup time	0.26			μs
t_{SUSTO}	Stop condition setup time	0.26			μs
t_{HDDAT}	Data hold time	0			ns
t_{SUDAT}	Data setup time	50			ns
t_{LOW}	SCL clock low period	500			ns
t_{HIGH}	SCL clock high period	260			ns
t_R	Clock and data fall time			120	ns
t_F	Clock and data rise time			120	ns
t_{UPDATE}	Sequential DAC update wait time	1			μs

7.10 Timing Diagrams



图 7-1. SPI Mode Timing



图 7-2. I²C Mode Timing

7.11 Typical Characteristics

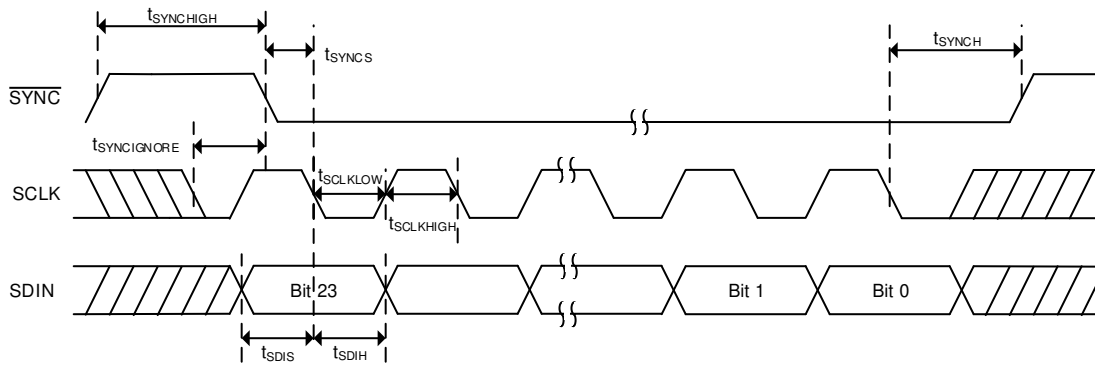
at $T_A = 25^\circ\text{C}$, $V_{DD} = 5.5\text{ V}$, Internal reference = 2.5 V, REF-DIV = 0 and BUFF-GAIN = 1, and DAC outputs unloaded (unless otherwise noted)

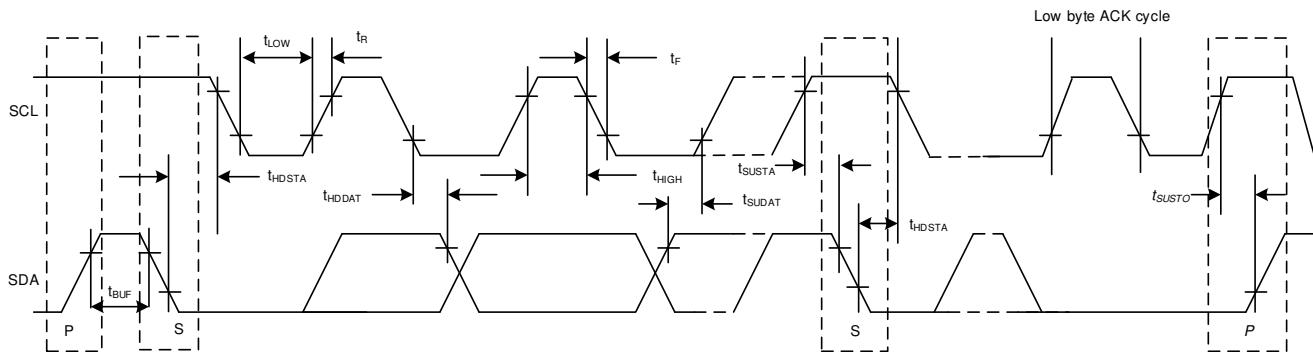

图 7-3. Integral Linearity Error vs Digital Input Code



图 7-4. Differential Linearity Error vs Digital Input Code

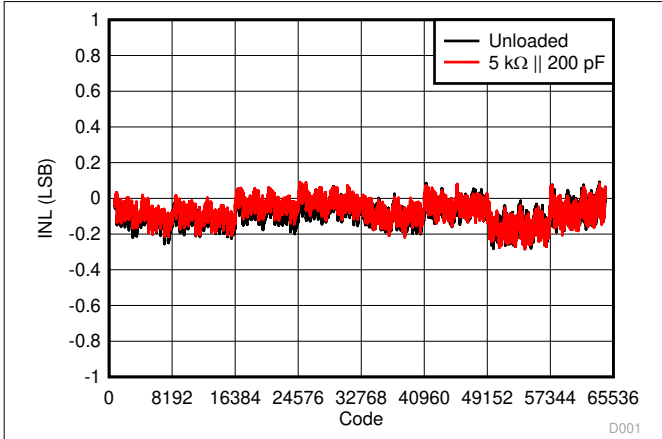

图 7-5. Total Unadjusted Error vs Digital Input Code

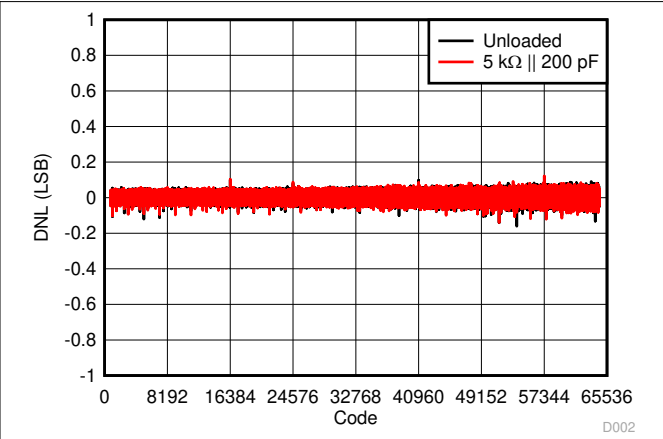

图 7-6. Integral Linearity Error vs Temperature

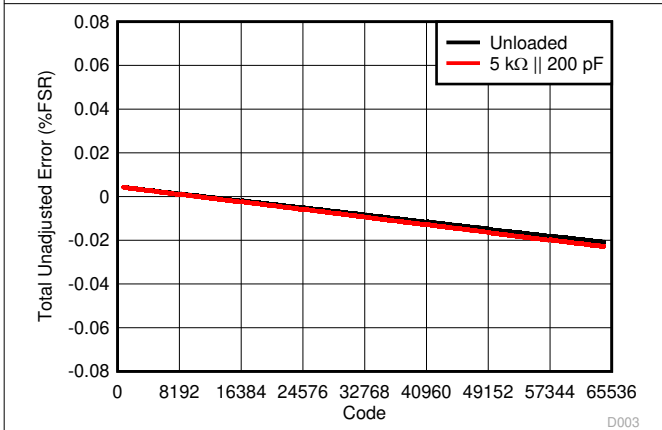

图 7-7. Differential Linearity Error vs Temperature

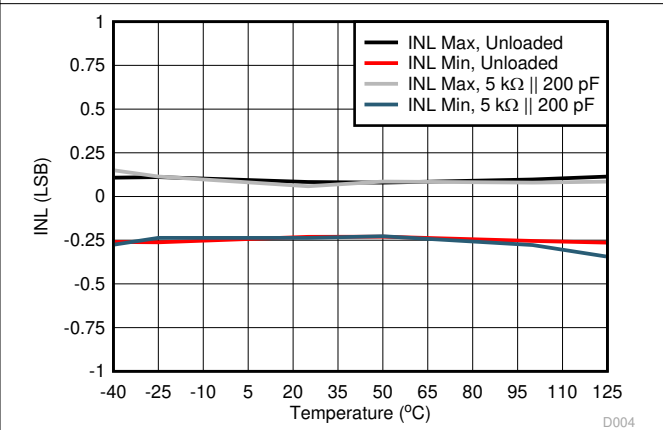

图 7-8. Total Unadjusted Error vs Temperature

7.11 Typical Characteristics (continued)

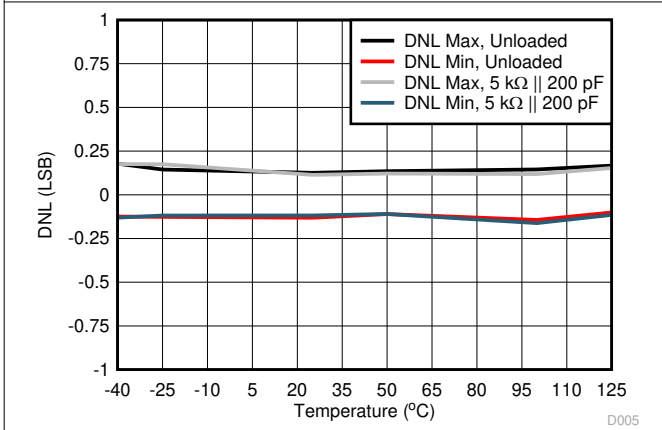
at $T_A = 25^\circ\text{C}$, $V_{DD} = 5.5\text{ V}$, Internal reference = 2.5 V, REF-DIV = 0 and BUFF-GAIN = 1, and DAC outputs unloaded (unless otherwise noted)

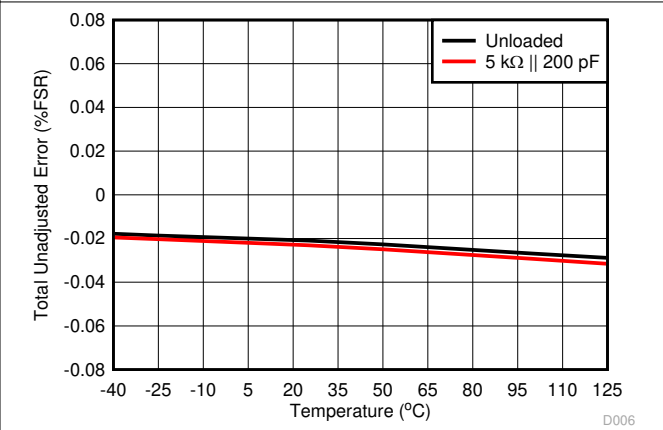

图 7-9. Zero Code Error vs Temperature



图 7-10. Offset Error vs Temperature

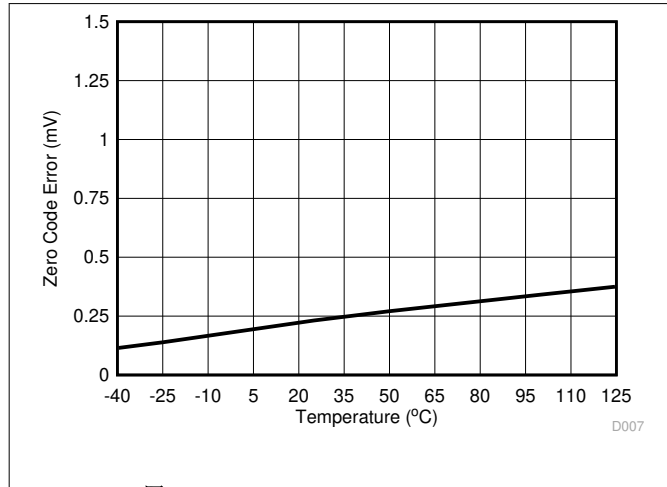

图 7-11. Full Scale Error vs Temperature

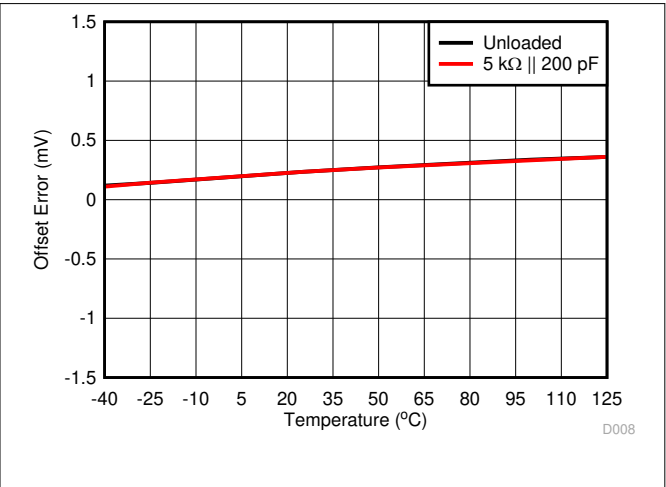

图 7-12. Gain Error vs Temperature

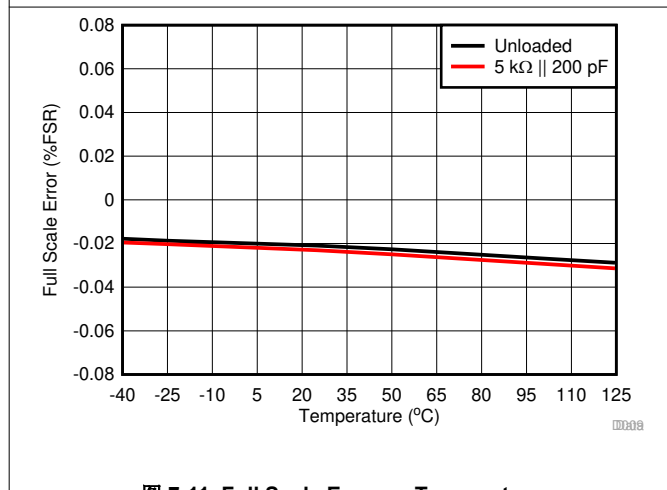

图 7-13. Integral Linearity Error vs Supply Voltage

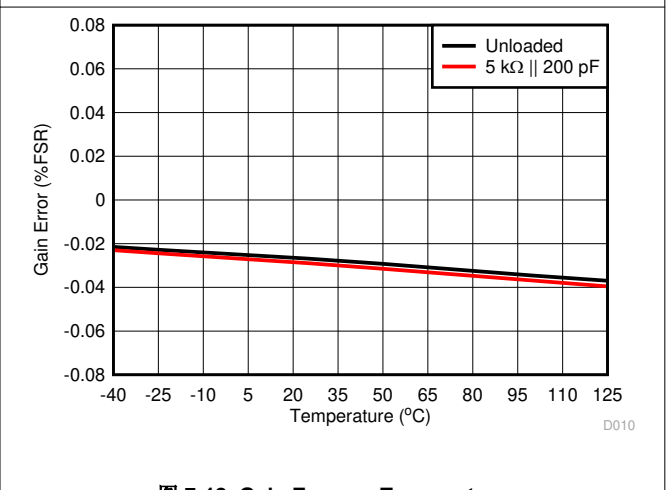

图 7-14. Differential Linearity Error vs Supply Voltage

7.11 Typical Characteristics (continued)

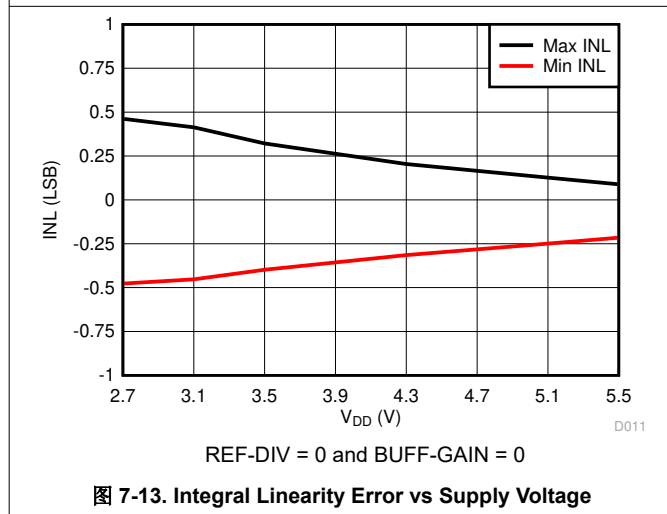
at $T_A = 25^\circ\text{C}$, $V_{DD} = 5.5\text{ V}$, Internal reference = 2.5 V, REF-DIV = 0 and BUFF-GAIN = 1, and DAC outputs unloaded (unless otherwise noted)

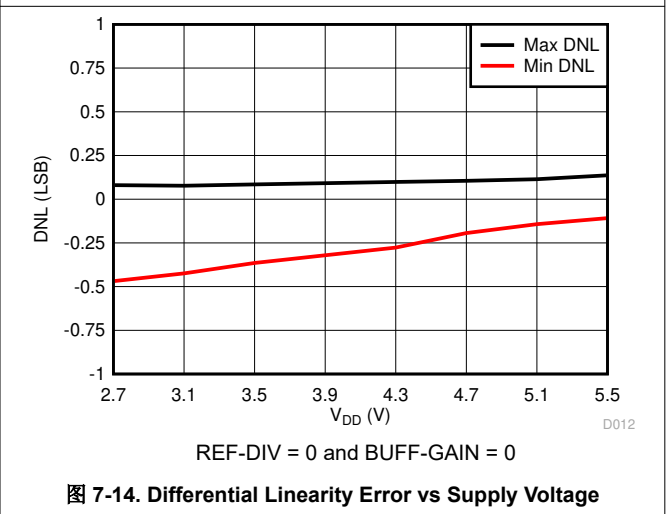

图 7-15. Total Unadjusted Error vs Supply Voltage



图 7-16. Zero Code Error vs Supply Voltage

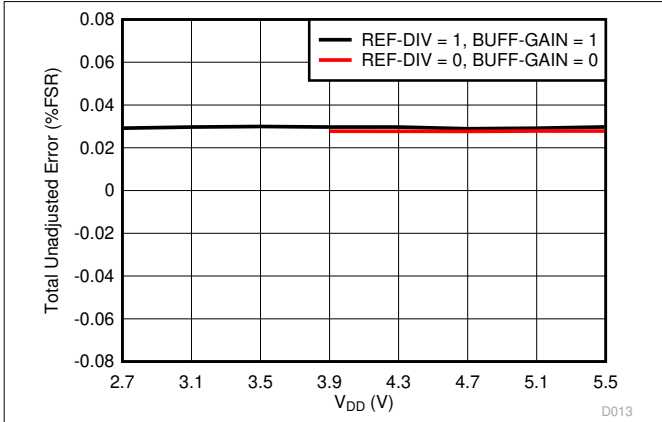

图 7-17. Offset Error vs Supply Voltage

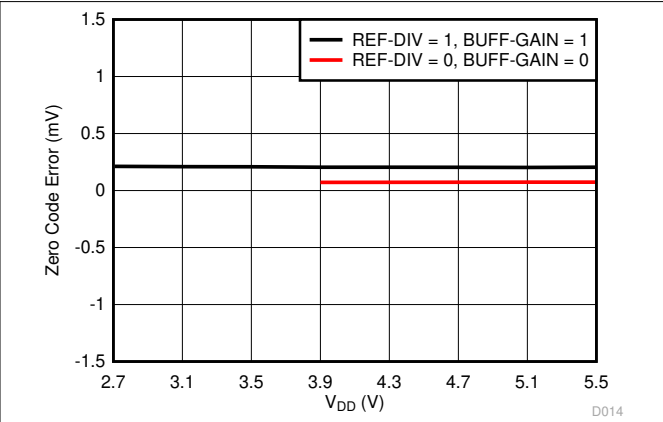

图 7-18. Gain Error vs Supply Voltage

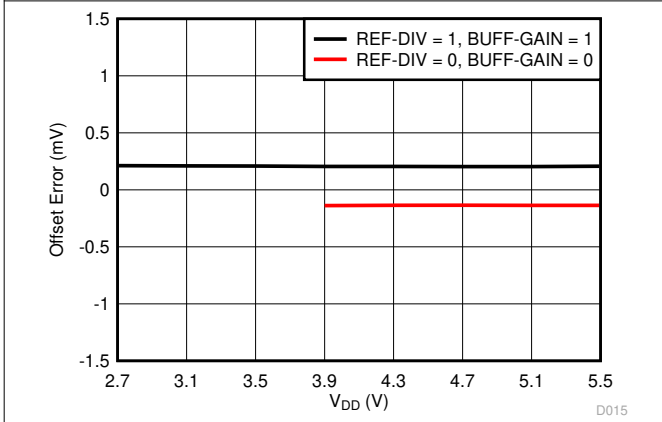

图 7-19. Full Scale Error vs Supply Voltage

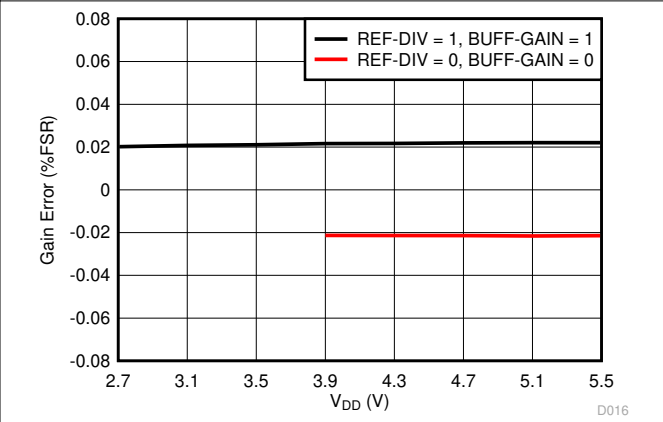

图 7-20. Integral Linearity Error vs Reference Voltage

7.11 Typical Characteristics (continued)

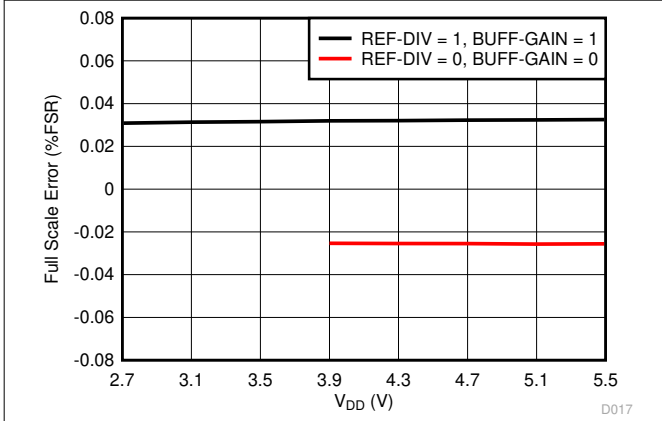
at $T_A = 25^\circ\text{C}$, $V_{DD} = 5.5\text{ V}$, Internal reference = 2.5 V, REF-DIV = 0 and BUFF-GAIN = 1, and DAC outputs unloaded (unless otherwise noted)

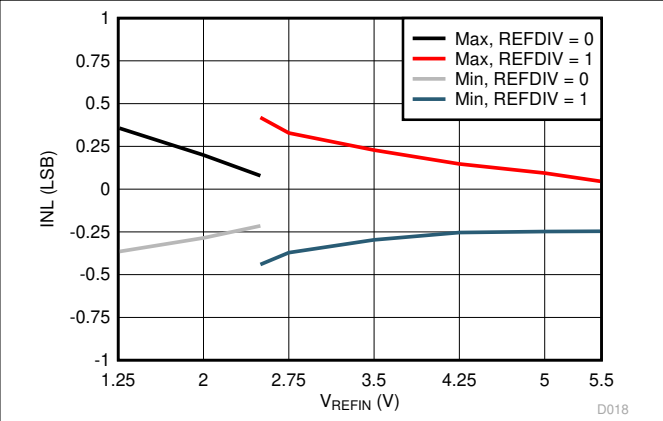

图 7-21. Differential Linearity Error vs Reference Voltage



图 7-22. Total Unadjusted Error vs Reference Voltage

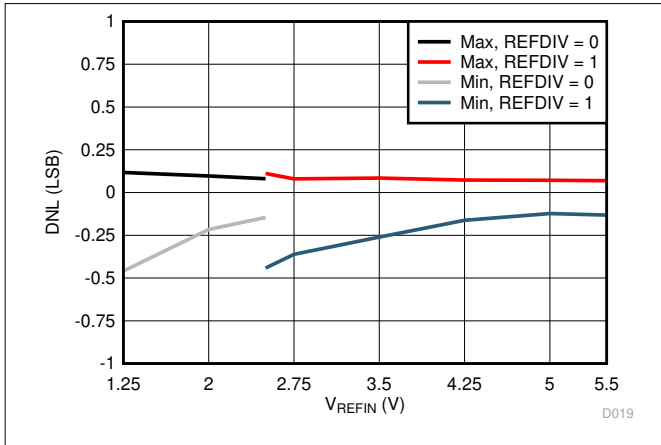

图 7-23. Zero Code Error vs Reference Voltage

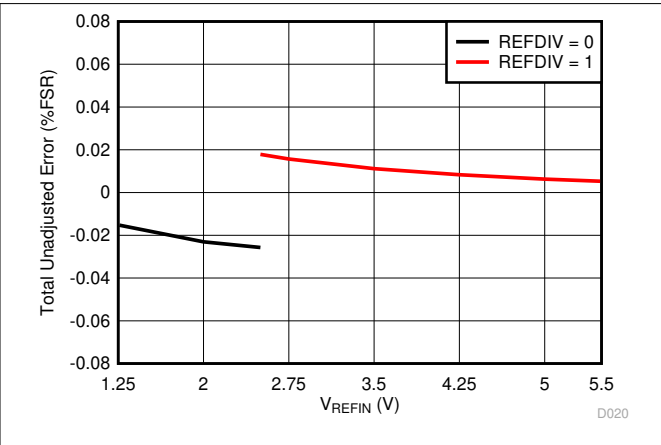

图 7-24. Offset Error vs Reference Voltage

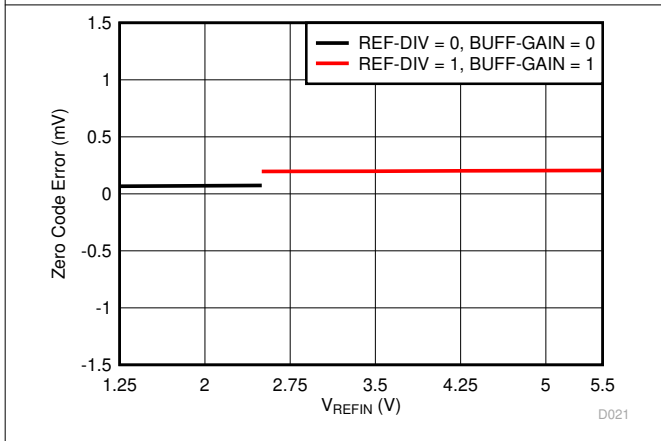

图 7-25. Gain Error vs Reference Voltage

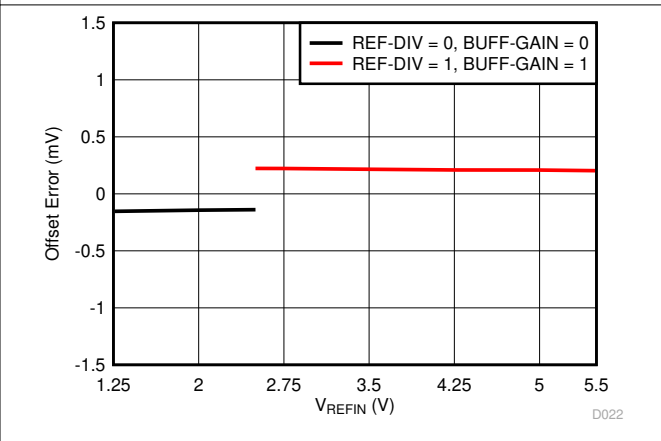

图 7-26. Full Scale Error vs Reference Voltage

7.11 Typical Characteristics (continued)

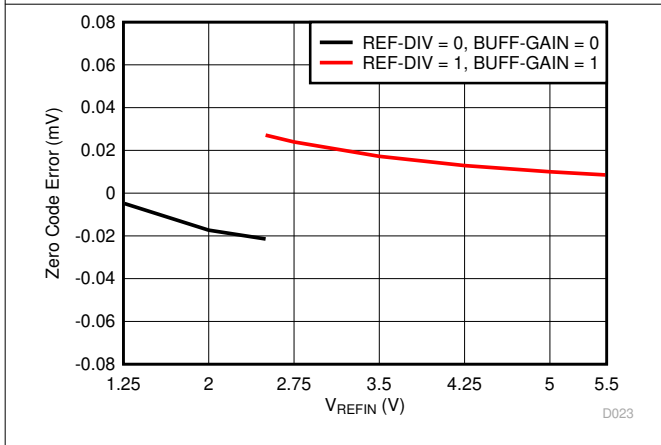
at $T_A = 25^\circ\text{C}$, $V_{DD} = 5.5\text{ V}$, Internal reference = 2.5 V, REF-DIV = 0 and BUFF-GAIN = 1, and DAC outputs unloaded (unless otherwise noted)

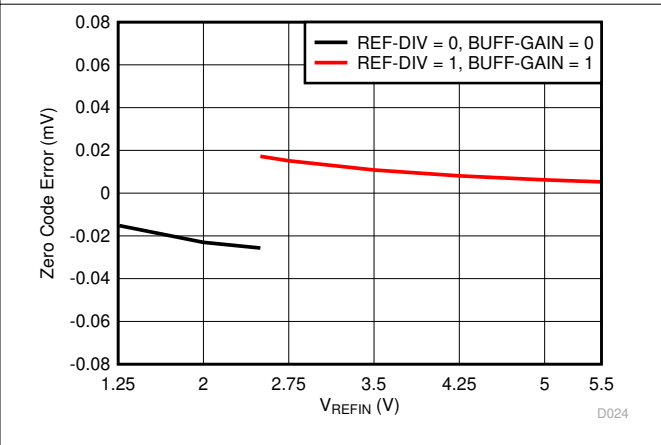

图 7-27. Supply Current vs Digital Input Code



图 7-28. Supply Current vs Temperature

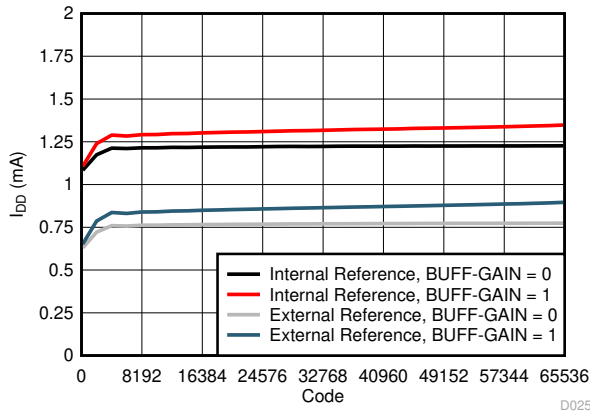

图 7-29. Supply Current vs Supply Voltage

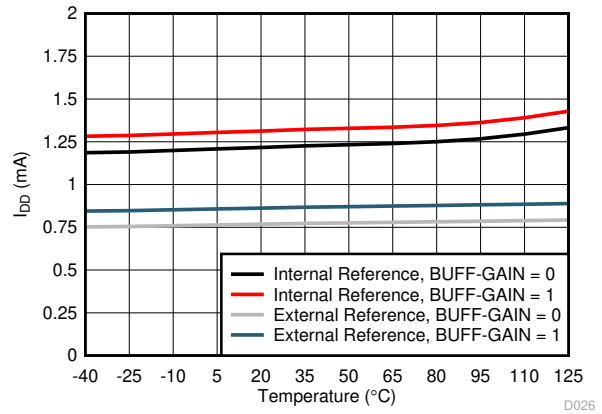

图 7-30. Power Down Current vs Temperature

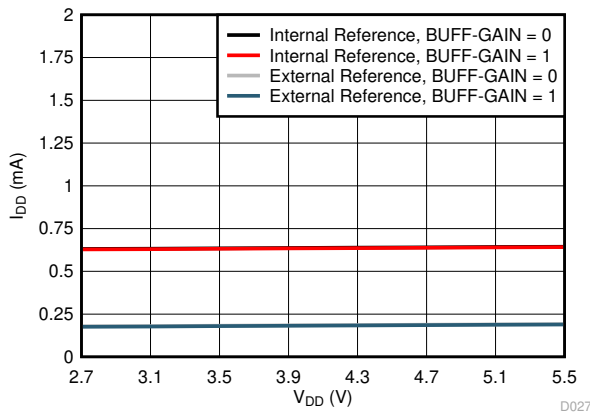

图 7-31. Power Down Current vs Supply Voltage

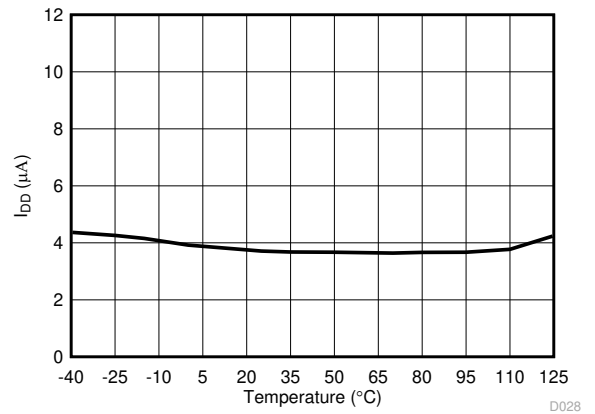

图 7-32. Headroom and Footroom vs Load Current

7.11 Typical Characteristics (continued)

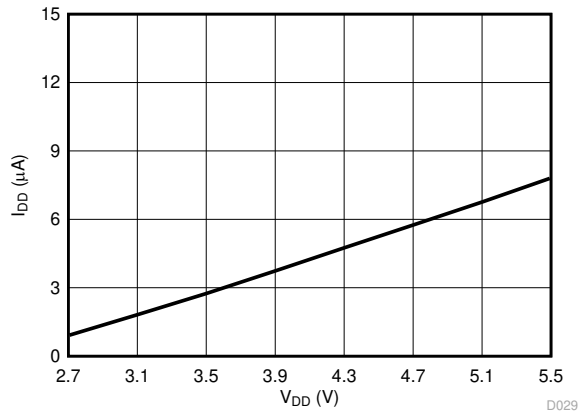
at $T_A = 25^\circ\text{C}$, $V_{DD} = 5.5\text{ V}$, Internal reference = 2.5 V, REF-DIV = 0 and BUFF-GAIN = 1, and DAC outputs unloaded (unless otherwise noted)

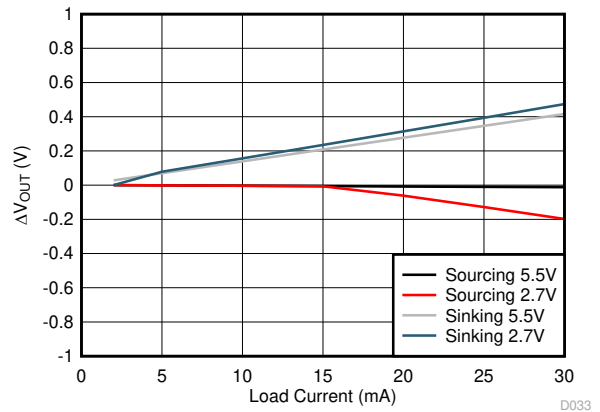
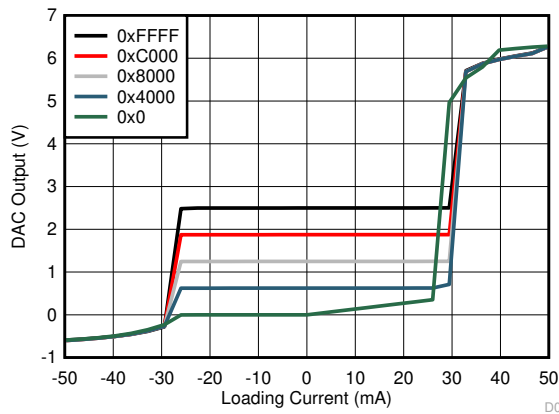

REF-DIV = 0 and BUFF-GAIN = 0

图 7-33. Source and Sink Capability

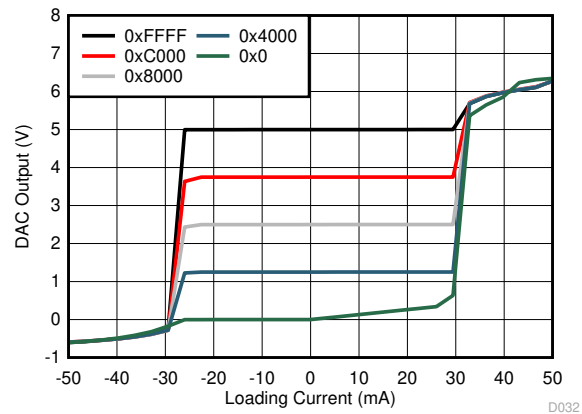

REF-DIV = 0 and BUFF-GAIN = 1

图 7-34. Source and Sink Capability

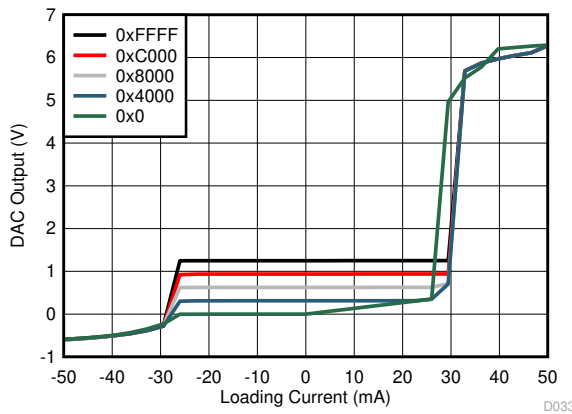

REF-DIV = 1 and BUFF-GAIN = 0

图 7-35. Source and Sink Capability

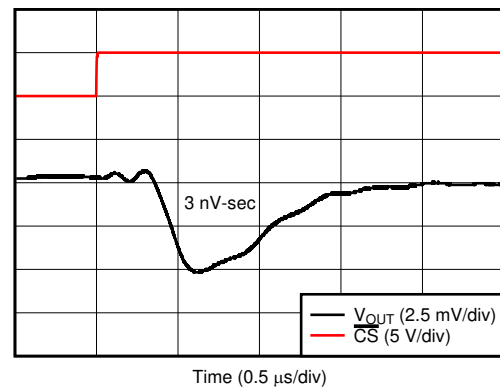

DAC code transition from midscale - 1 to midscale LSB,
REF-DIV = 0 and BUFF-GAIN = 0

图 7-36. Glitch Impulse, Rising Edge, 1-LSB Step

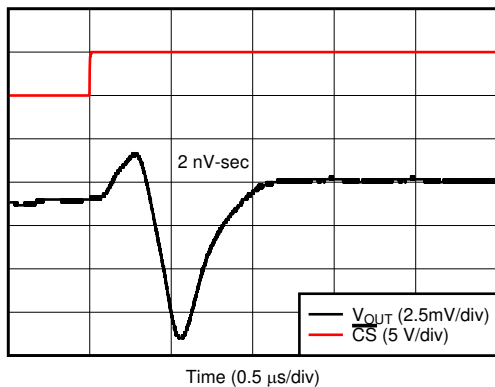

DAC code transition from midscale to midscale - 1 LSB,
REF-DIV = 0 and BUFF-GAIN = 0

图 7-37. Glitch Impulse, Falling Edge, 1-LSB Step

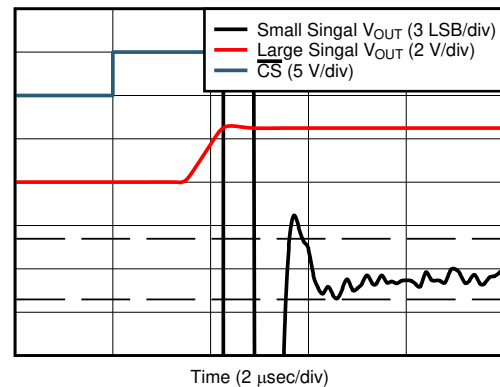

REF-DIV = 0 and BUFF-GAIN = 0

图 7-38. Full-Scale Settling Time, Rising Edge

7.11 Typical Characteristics (continued)

at $T_A = 25^\circ\text{C}$, $V_{DD} = 5.5\text{ V}$, Internal reference = 2.5 V, REF-DIV = 0 and BUFF-GAIN = 1, and DAC outputs unloaded (unless otherwise noted)

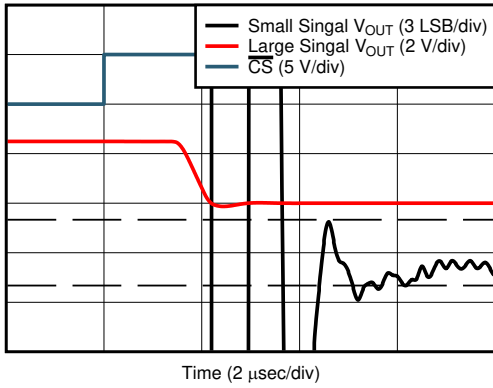

REF-DIV = 0 and BUFF-GAIN = 0

图 7-39. Full-Scale Settling Time, Falling Edge

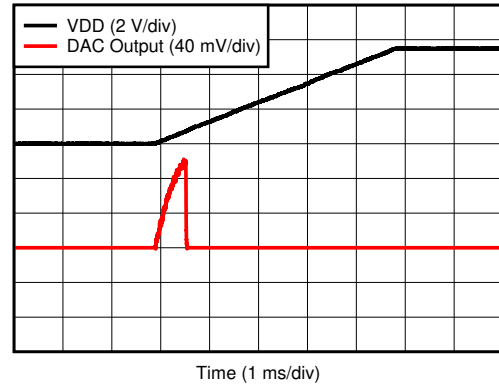

REF-DIV = 0 and BUFF-GAIN = 0

图 7-40. Power-on Glitch

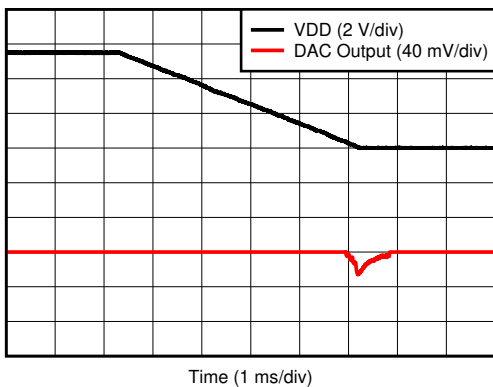

REF-DIV = 0 and BUFF-GAIN = 0

图 7-41. Power-off Glitch

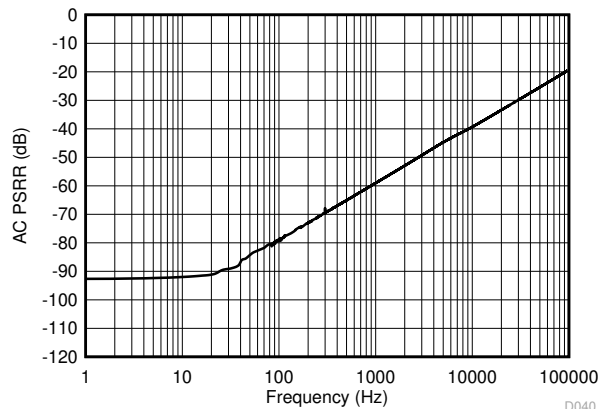

DAC code at midscale, $V_{DD} = 5.0\text{ V} + 0.2\text{ V}_{PP}$,
REF-DIV = 0 and BUFF-GAIN = 0

图 7-42. DAC Output AC PSRR vs Frequency

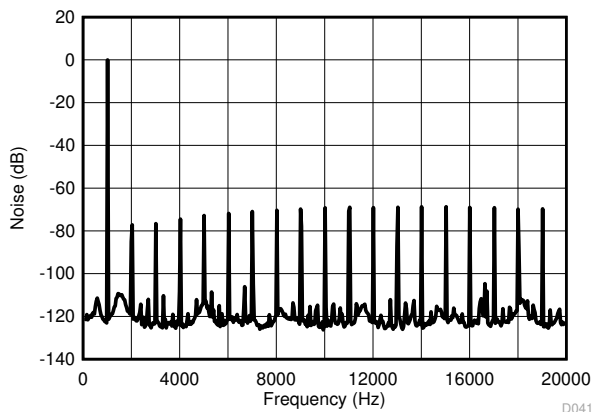

$f_o = 1\text{ kHz}$, $f_s = 400\text{ kHz}$, includes 7 harmonics,
measurement bandwidth = 20 kHz, external reference = 2.5 V,
REF-DIV = 0 and BUFF-GAIN = 0

图 7-43. DAC Output THD+N vs Frequency

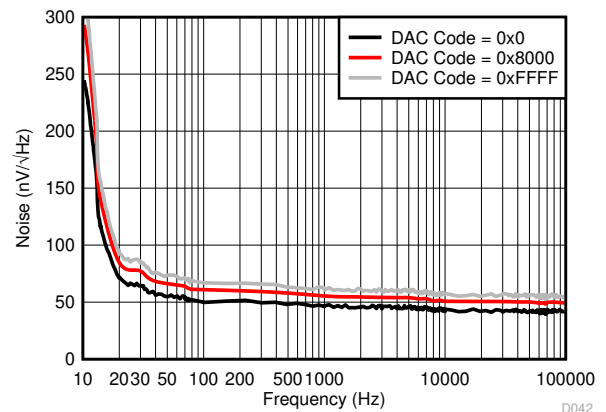

Gain = 1X (REF-DIV = 1 and BUFF-GAIN = 1),
external reference = 2.5 V,
REF-DIV = 0 and BUFF-GAIN = 0

图 7-44. DAC Output Noise Spectral Density

7.11 Typical Characteristics (continued)

at $T_A = 25^\circ\text{C}$, $V_{DD} = 5.5\text{ V}$, Internal reference = 2.5 V, REF-DIV = 0 and BUFF-GAIN = 1, and DAC outputs unloaded (unless otherwise noted)

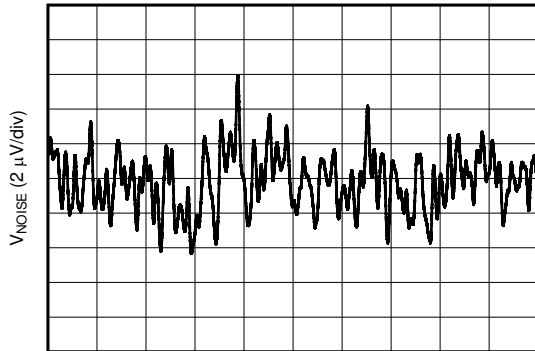

D043

DAC code at midscale, external reference = 2.5 V,
REF-DIV = 0 and BUFF-GAIN = 0

图 7-45. DAC Output Noise 0.1 Hz to 10 Hz

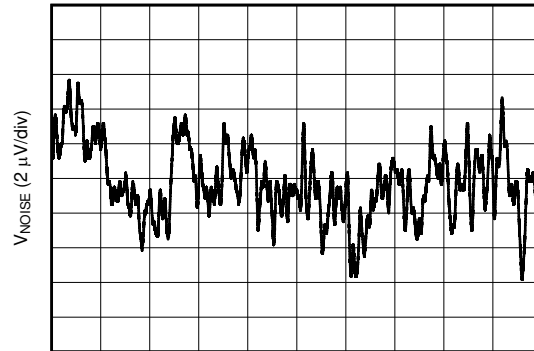

D044

DAC code at midscale, internal reference = 2.5 V,
REF-DIV = 0 and BUFF-GAIN = 0

图 7-46. DAC Output Noise 0.1 Hz to 10 Hz

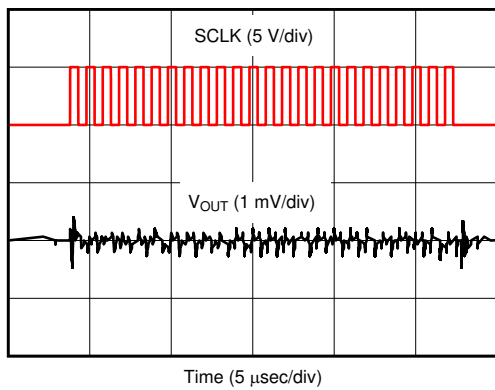

D045

DAC code at midscale, external reference = 2.5 V,
SCLK = 1 MHz, REF-DIV = 0 and BUFF-GAIN = 0

图 7-47. Clock Feedthrough

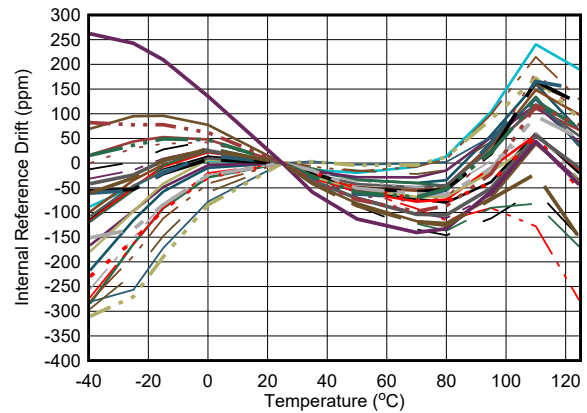

30 units

图 7-48. Internal Reference Voltage vs Temperature



图 7-49. Internal Reference Voltage vs Supply Voltage



图 7-50. Internal Reference Voltage vs Time

7.11 Typical Characteristics (continued)

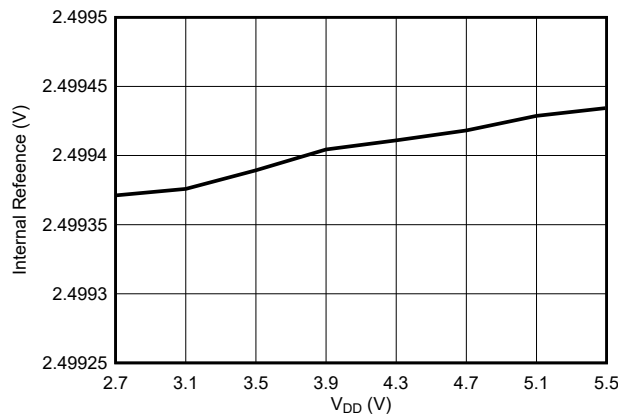
at $T_A = 25^\circ\text{C}$, $V_{DD} = 5.5\text{ V}$, Internal reference = 2.5 V , REF-DIV = 0 and BUFF-GAIN = 1, and DAC outputs unloaded (unless otherwise noted)

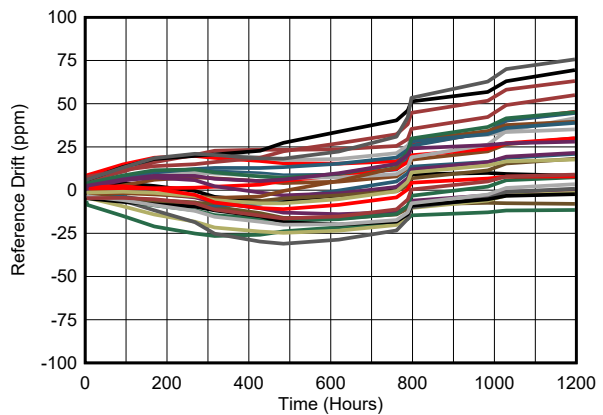

图 7-51. Internal Reference Noise Density vs Frequency



图 7-52. Internal Reference Noise, 0.1 Hz to 10 Hz

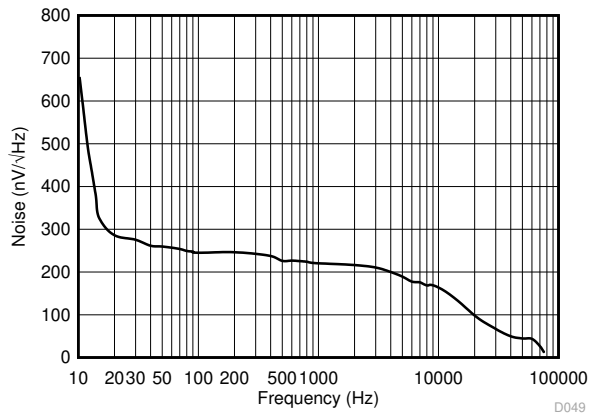

图 7-53. Internal Reference Temperature Drift Histogram

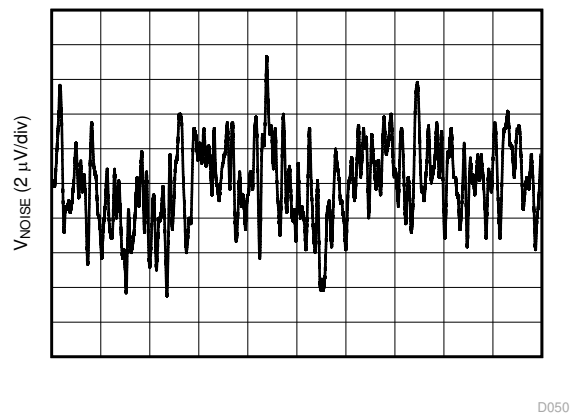

图 7-54. Internal Reference Initial Accuracy (Pre- and Post-Solder) Histogram

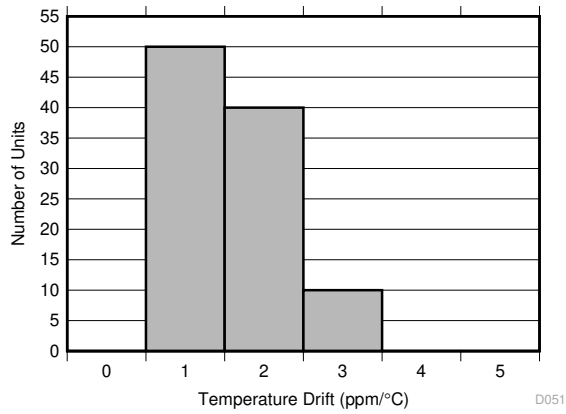

图 7-55. Internal Reference Temperature Drift (Pre- and Post-Solder) Histogram

8 Detailed Description

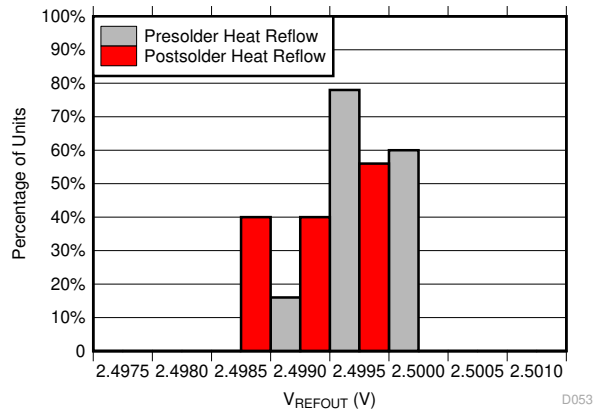
8.1 Overview

The DAC80501, DAC70501, DAC60501 (DACx0501) family of devices are buffered voltage output, 16-bit, 14-bit, or 12-bit digital-to-analog converters (DACs), respectively. These devices include a 2.5-V, 5-ppm/°C internal reference, giving full-scale output voltage ranges of 1.25 V, 2.5 V, or 5 V. The DACx0501 devices incorporate a power-on-reset circuit that makes sure that the DAC output powers up at zero scale or midscale, and remains at that scale until a valid code is written to the device.

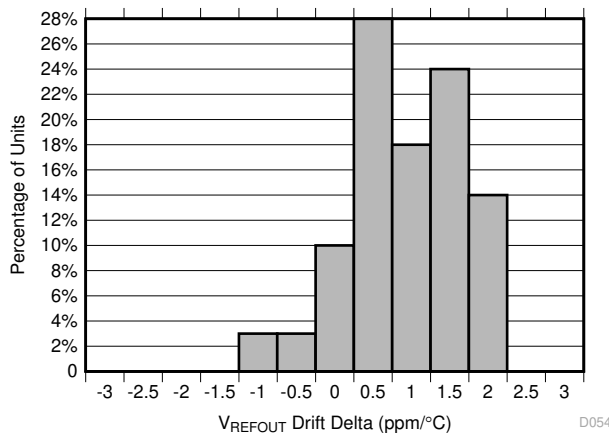
The digital interface of the DACx0501 can be configured to SPI or I²C mode using the SPI2C pin. In SPI mode, the DACx0501 family uses a 3-wire serial interface that operates at clock rates up to 50 MHz. In I²C mode, the DACx0501 devices operate in standard mode (100Kbps), fast mode (400Kbps), and fast mode plus (1.0Mbps).

8.2 Functional Block Diagram

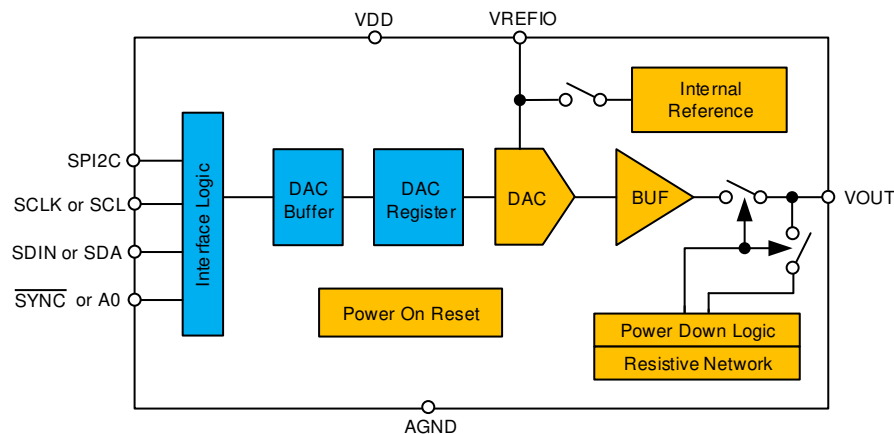

8.3 Feature Description

8.3.1 DAC Architecture

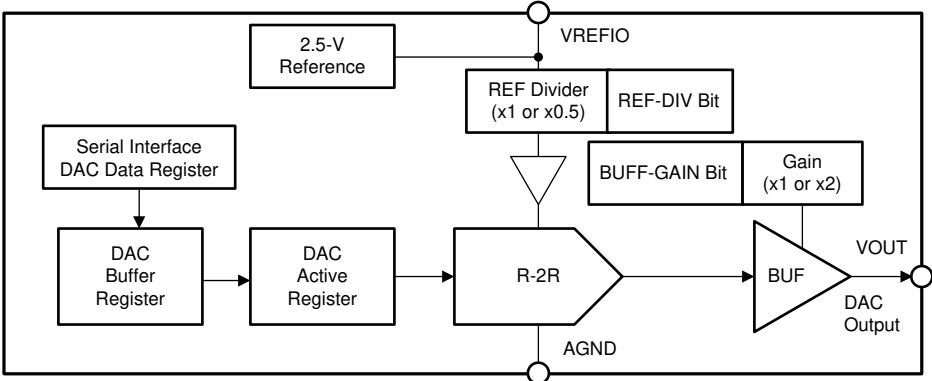
The output channel in the DACx0501 family of devices consists of a rail-to-rail ladder architecture with an output buffer amplifier. The devices include an internal 2.5-V reference.  shows a block diagram of the DAC architecture.



图 8-1. DACx0501 DAC Block Diagram

8.3.1.1 DAC Transfer Function

The input data writes to the individual DAC data registers in straight binary format. After a power-on or a reset event, all DAC registers are set to zero code (DACx0501Z devices) or midscale code (DACx0501M devices). The DAC transfer function is shown by [方程式 1](#).

$$V_{\text{OUT}} = \frac{\text{DAC_DATA}}{2^N} \times \frac{\text{VREFIO}}{\text{DIV}} \times \text{GAIN} \quad (1)$$

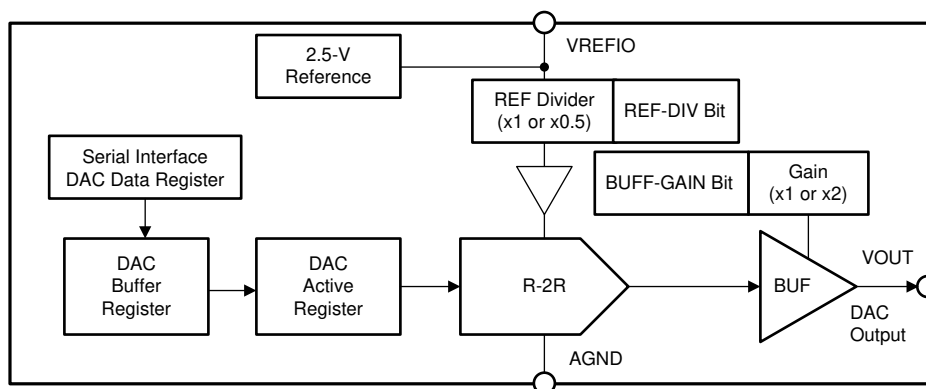
where:

- N = resolution in bits = either 12 (DAC60501), 14 (DAC70501) or 16 (DAC80501).
- DAC_DATA = decimal equivalent of the binary code that is loaded to the DAC register (address 8h). DAC_DATA ranges from 0 to $2^N - 1$.
- VREFIO = DAC reference voltage at the VREFIO pin. Either VREFIO from the internal 2.5-V reference or VREFIO from an external reference.
- DIV = 1 (default) or 2, as set by the REF-DIV bit in the GAIN register (address 4h).
- GAIN = 1 or 2 (default), as set by the BUFF-GAIN bit in the GAIN register (address 4h).

8.3.1.2 DAC Register Structure

Data written to the DAC data registers are initially stored in the DAC buffer registers. The update mode of the DAC output is determined by the status of the DAC_SYNC_EN bit (address 2h).

In asynchronous mode (default, DAC_SYNC_EN = 0), a write to the DAC buffer register results in an immediate update of the DAC active register. In SPI mode, the DAC output (VOUT pin) updates on the rising edge of SYNC. In I²C mode, the DAC output (VOUT pin) updates on the falling edge of SCL on the last acknowledge bit.

In synchronous mode (DAC_SYNC_EN = 1), writing to the DAC buffer register does not automatically update the DAC active register. Instead, the update occurs only after a software LDAC trigger event. A software LDAC trigger generates through the LDAC bit in the TRIGGER register (address 5h). When the host reads from a DAC buffer register, the value held in the DAC buffer register is returned (not the value held in the DAC active register).

8.3.1.3 Output Amplifier

The output buffer amplifier generates rail-to-rail voltages on the output, giving a maximum output range of 0 V to VDD. [方程式 1](#) shows that the full-scale output range of the DAC output is determined by the voltage on the VREFIO pin, the reference divider setting (DIV) as set by the REF-DIV bit (address 4h), and the gain configuration for that channel set by the corresponding BUFF-GAIN bit (address 4h). The buffer amplifier is designed to have a 79° phase margin (nominal) at 380 kHz at room temperature.

8.3.2 Internal Reference

The DAX0501 family of devices includes a 2.5-V precision band-gap reference that is enabled by default. Operation from an external reference is supported by disabling the internal reference in the REF_PWDWN bit (address 3h). The internal reference is externally available at the VREFIO pin, and can be used to drive external circuitry. At power-on reset, the internal reference is enabled. This enabled reference can result in current being sunk or sourced from the device to an external reference source. When using an external reference, use a series resistance that is larger than 1 kΩ to reduce the current at start-up to be less than 5 mA. After the internal reference is disabled, the input becomes high impedance. For noise filtering, use a minimum 150-nF capacitor between the reference output and AGND.

The reference voltage to the device, either from the internal reference or an external one, can be divided by a factor of two by setting the REF-DIV bit (address 4h) to 1. The REF-DIV bit provides additional flexibility in setting the full-scale output range of the DAC output. Make sure to configure REF-DIV so that there is sufficient headroom from VDD to the DAC operating reference voltage, VREFIO (see [方程式 1](#)). See [节 7.3](#) for more information. The short-circuit current of the internal reference is limited by design to approximately 100 mA.

Improper configuration of the reference divider triggers a reference alarm condition. In this case, the reference buffer is shut down, and all the DAC outputs go to 0 V. The DAC data registers are unaffected by the alarm condition, thus enabling the DAC output to return to normal operation after the reference divider is configured correctly.

8.3.2.1 Solder Heat Reflow

A known behavior of IC reference voltage circuits is the shift induced by the soldering process. [图 7-54](#) and [图 7-55](#) show the effect of solder heat reflow for the DACx0501 internal reference.

8.3.3 Power-On-Reset (POR)

The DACx0501 family of devices includes a power-on reset (POR) function that controls the output voltage at power up. After the VDD supply has been established, a POR event is issued. The POR causes all registers to initialize to default values, and communication with the device is valid only after a 250- μ s POR delay. The default value for the DAC data registers is zero-code for the DACx0501Z devices and midscale code for the DACx0501M devices. The DAC output remains at the power-up voltage until a valid command is written to a channel.

When the device powers up, a POR circuit sets the device to the default mode. The POR circuit requires specific VDD levels, as indicated in [图 8-2](#), to make sure that the internal capacitors discharge and reset the device at power up. To make sure that a POR occurs, VDD must be less than 0.7 V for at least 1 ms. When VDD drops to less than 2.2 V but remains greater than 0.7 V (shown as the undefined region), the device may or may not reset under all specified temperature and power-supply conditions. In this case, initiate a POR. When VDD remains greater than 2.2 V, a POR does not occur.



图 8-2. Threshold Levels for VDD POR Circuit

8.3.4 Software Reset

A device software reset event is initiated by writing the reserved code 0x1010 to the SOFT-RESET bit in the TRIGGER register (address 5h). A software reset initiates a POR event.

8.4 Device Functional Modes

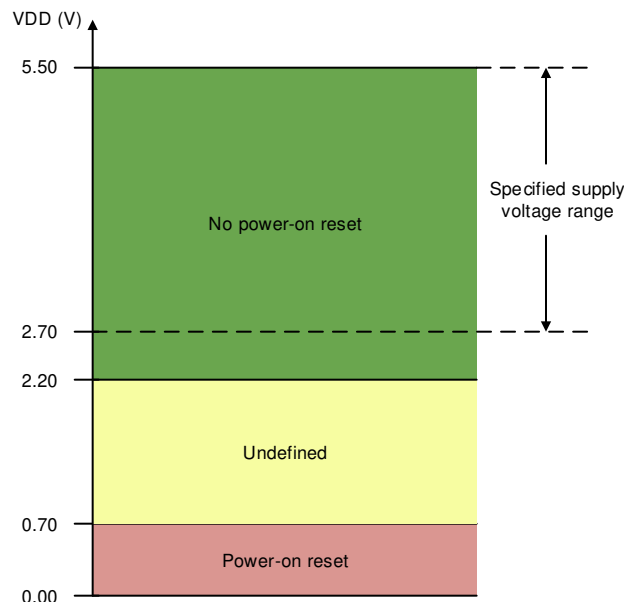
The DACx0501 has two modes of operation: normal and power-down.

8.4.1 Power-Down Mode

The DACx0501 output amplifiers and internal reference can be independently powered down through the CONFIG register (3h). At power up, the DAC output and the internal reference are active by default. In power-down mode, the DAC output (VOUT pin) is internally connected to AGND through a 1-k Ω resistor.

8.5 Programming

8.5.1 Serial Interface

The DACx0501 family of devices is controlled through either a 3-wire SPI or a 2-wire I²C interface. The type of interface is determined at device power up based on the logic level of the SPI2C pin. A logic 0 on the SPI2C pin puts the DACx0501 in SPI mode; whereas, logic 1 on SPI2C puts the DACx0501 in I²C mode. The SPI2C pin must be kept static after the device powers up.

8.5.1.1 SPI Mode

The DACx0501 digital interface is programmed to work in SPI mode when the logic level of the SPI2C pin is 0 at power up. In SPI mode, the DACx0501 have a 3-wire serial interface: $\overline{\text{SYNC}}$, SCLK, and SDIN, as shown in [Figure 6](#). The serial interface is compatible with SPI, QSPI, and Microwire interface standards, and most digital signal processors (DSPs). The serial interface operates at up to 50 MHz. The input shift register is 24 bits wide.

The serial clock SCLK is a continuous or a gated clock. The first falling edge of $\overline{\text{SYNC}}$ starts the operation cycle. When $\overline{\text{SYNC}}$ is high, the SCLK and SDIN signals are blocked. The device internal registers are updated from the shift register on the rising edge of $\overline{\text{SYNC}}$.

8.5.1.1.1 $\overline{\text{SYNC}}$ Interrupt

For SPI-mode operation, the $\overline{\text{SYNC}}$ line stays low for at least 24 falling edges of SCLK and the addressed DAC register updates on the $\overline{\text{SYNC}}$ rising edge. However, if the $\overline{\text{SYNC}}$ line is brought high before the 24th SCLK falling edge, this event acts as an interrupt to the write sequence. The shift register resets and the write sequence is discarded. Neither an update of the data buffer or DAC register contents, nor a change in the operating mode occurs, as shown in [Figure 8-3](#).



图 8-3. $\overline{\text{SYNC}}$ Interrupt

8.5.1.2 I²C Mode

The DACx0501 digital interface is programmed to work in I²C mode when the logic level of the SPI2C pin is 1 at power up. In I²C mode, the DACx0501 have a 2-wire serial interface: SCL, SDA, and one address pin, A0, as shown in [Figure 6](#). The I²C bus consists of a data line (SDA) and a clock line (SCL) with pull-up structures. When the bus is idle, both the SDA and SCL lines are pulled high. All the I²C-compatible devices connect to the I²C bus through the open-drain I/O pins, SDA and SCL.

The I²C specification states that the device that controls communication is called a *controller*, and the devices that are controlled by the controller are called *targets*. The controller device generates the SCL signal. The controller device also generates special timing conditions (start condition, repeated start condition, and stop condition) on the bus to indicate the start or stop of a data transfer. Device addressing is completed by the controller. The controller device on an I²C bus is typically a microcontroller or DSP. The DACx0501 operate as a target device on the I²C bus. A target device acknowledges controller commands, and upon controller control, receives or transmits data.

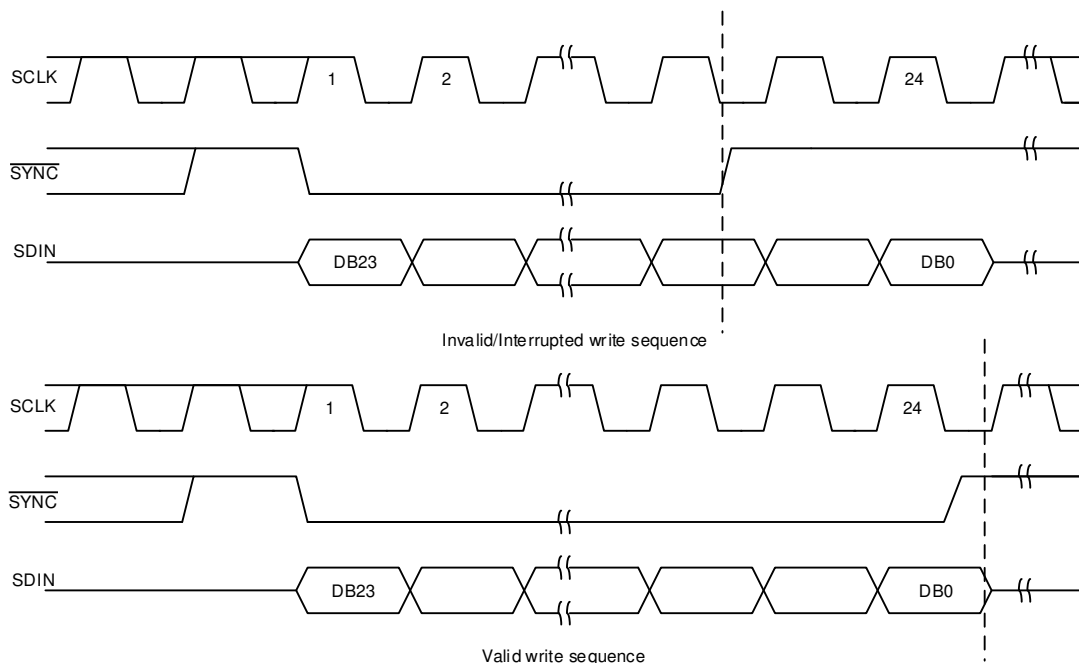
Typically, the DACx0501 operate as a target receiver. A controller device writes to the DACx0501, a target receiver. However, if a controller device requires the DACx0501 internal register data, the DACx0501 operate as a target transmitter. In this case, the controller device reads from the DACx0501. According to I²C terminology, read and write refer to the controller device.

The DACx0501 are target devices that support the following data transfer modes:

1. Standard mode (100Kbps)
2. Fast mode (400Kbps)
3. Fast mode plus (1.0Mbps)

The data transfer protocol for standard and fast modes is exactly the same; therefore, these modes are referred to as F/S-mode in this document. The fast-mode plus (FM+) protocol is supported in terms of data transfer speed, but not output current. The low-level output current is 3 mA, similar to the case of standard and fast modes. The DACx0501 support 7-bit addressing. The 10-bit addressing mode is not supported. These devices support the general call reset function. Send the following sequence to initiate a software reset within the device: Start/Repeated Start, 0x00, 0x06, Stop. The reset is asserted within the device on the falling edge of the ACK bit, following the second byte.

Other than specific timing signals, the I²C interface works with serial bytes. At the end of each byte, a ninth clock cycle generates and detects an acknowledge signal. Acknowledge is when the SDA line is pulled low during the high period of the ninth clock cycle. A not-acknowledge is when the SDA line is left high during the high period of the ninth clock cycle as shown in [Figure 8-4](#).



图 8-4. Acknowledge and Not Acknowledge on the I²C Bus

8.5.1.2.1 F/S Mode Protocol

1. The controller initiates data transfer by generating a start condition. The start condition is when a high to-low transition occurs on the SDA line while SCL is high, as shown in 图 8-5. All I²C-compatible devices recognize a start condition.

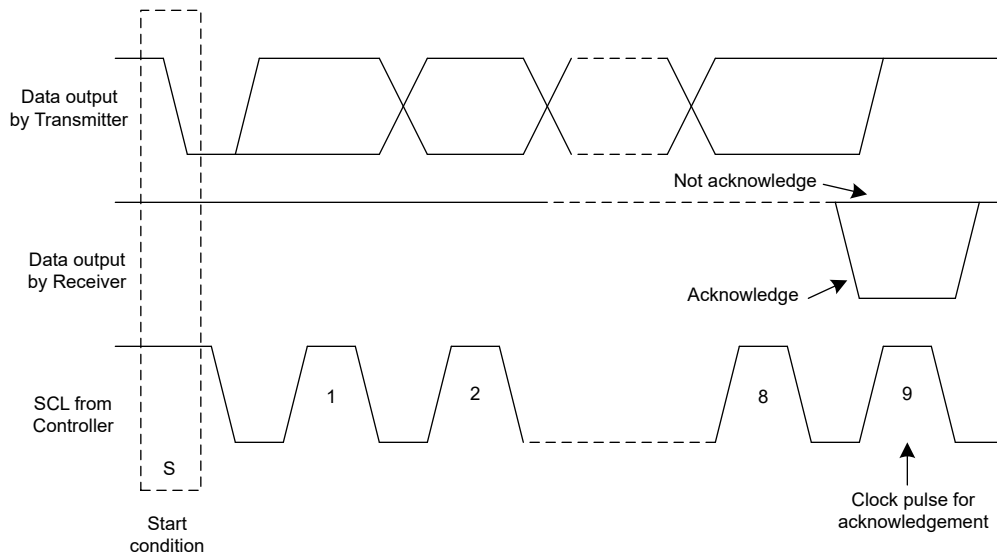

图 8-5. Start and Stop Conditions



图 8-6. Bit Transfer on the I²C Bus

2. The controller then generates the SCL pulses, and transmits the 7-bit address and the read/write direction bit (R/W) on the SDA line. During all transmissions, the controller makes sure that data are valid. 图 8-6 shows that a valid data condition requires the SDA line to be stable during the entire high period of the clock pulse. All devices recognize the address sent by the controller and compare the address to the internal fixed addresses. Only the target device with a matching address generates an acknowledge by pulling the SDA line low during the entire high period of the ninth SCL cycle; see also 图 8-4 by pulling the SDA line low during the entire high period of the ninth SCL cycle. Upon detecting this acknowledge, the controller knows the communication link with a target has been established.
3. The controller generates further SCL cycles to transmit (R/W bit 0) or receive (R/W bit 1) data to the target. In either case, the receiver must acknowledge the data sent by the transmitter. Therefore, the acknowledge signal can be generated by the controller or by the target, depending on which one is the receiver. The 9-bit valid data sequences consists of 8-data bits and 1 acknowledge-bit, and can continue as long as necessary.
4. To signal the end of the data transfer, the controller generates a stop condition by pulling the SDA line from low to high while the SCL line is high (see 图 8-5). This action releases the bus and stops the communication link with the addressed target. All I²C-compatible devices recognize the stop condition. Upon receipt of a stop condition, the bus is released, and all target devices then wait for a start condition followed by a matching address.

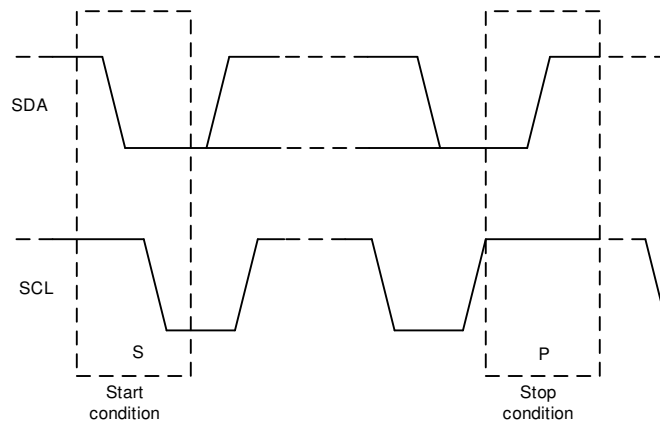
8.5.1.2.2 I²C Update Sequence

For a single update, the DACx0501 requires a start condition, a valid I²C address byte, a command byte, and two data bytes: the most significant data byte (MSDB), and least significant data byte (LSDB), as listed in 表 8-1.

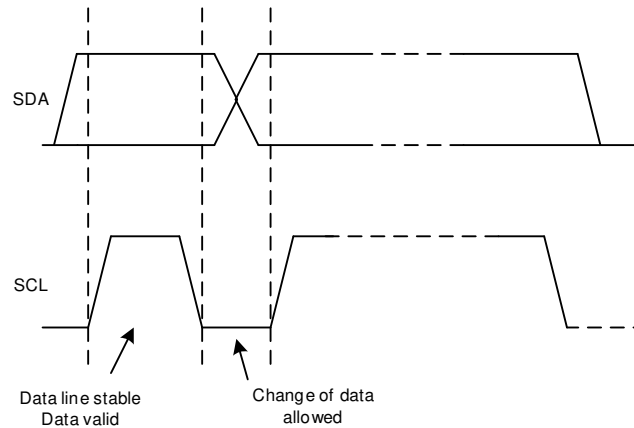
表 8-1. Update Sequence

MSB	LSB	ACK	MSB	...	LSB	ACK	MSB	...	LSB	ACK	MSB	...	LSB	ACK
Address (A) byte				Command byte				MSDB				LSDB			
DB [32:24]				DB [23:16]				DB [15:8]				DB [7:0]			

After each byte is received, the DACx0501 acknowledge the byte by pulling the SDA line low during the high period of a single clock pulse, as shown in 图 8-7. These four bytes and acknowledge cycles make up the 36 clock cycles required for a single update to occur. A valid I²C address byte selects the DACx0501 devices.



图 8-7. I²C Bus Protocol

The command byte sets the operational mode of the selected DACx0501 device. When the operational mode is selected by this byte, the DACx0501 must receive two data bytes, the most significant data byte (MSDB) and least significant data byte (LSDB), for a data update to occur. The DACx0501 devices perform an update on the falling edge of the acknowledge signal that follows the LSDB.

When using fast mode (clock = 400 kHz), the maximum DAC update rate is limited to 11.11 kSPS. Using the fast-mode plus (clock = 1 MHz), the maximum DAC update rate is limited to 27.77 kSPS. When a stop condition is received, the DACx0501 release the I²C bus and await a new start condition.

8.5.1.2.2.1 Address Byte

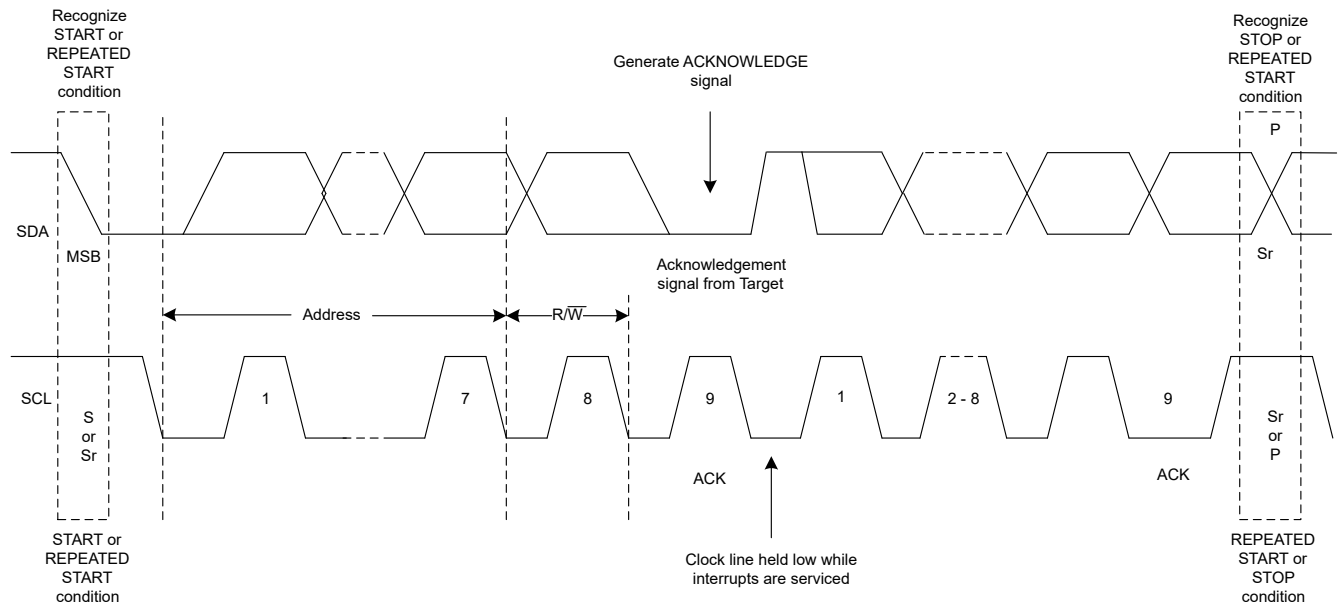
表 8-2 shows that the address byte is the first byte received following the START condition from the controller device. The first four bits (MSBs) of the address are factory preset to 1001. The next three bits of the address are controlled by the A0 pin. The A0 pin input can be connected to VDD, AGND, SCL, or SDA. The A0 pin is sampled during the first byte of each data frame to determine the address. The device latches the value of the address pin, and consequently, responds to that particular address according to 表 8-3.

表 8-2. DACx0501 Address Byte

ADDRESS TYPE	MSB							LSB
	AD6	AD5	AD4	AD3	AD2	AD1	AD0	R/ W
General address	1	0	0	1	See 表 8-3 (target address column)			0 or 1

表 8-3. Address Format

TARGET ADDRESS	A0 PIN
1001 000	AGND
1001 001	VDD
1001 010	SDA
1001 011	SCL

8.5.1.2.2.2 Command Byte

The DACx0501 command byte (shown in 表 8-4) controls which command is executed and which register is being accessed when writing to or reading from the DACx0501 series.

表 8-4. DACx0501 Command Byte

B23	B22	B21	B20	B19	B18	B17	B16	REGISTER
0	0	0	0	0	0	0	0	NOOP
0	0	0	0	0	0	0	1	DEVID
0	0	0	0	0	0	1	0	SYNC
0	0	0	0	0	0	1	1	CONFIG
0	0	0	0	0	1	0	0	GAIN
0	0	0	0	0	1	0	1	TRIGGER
0	0	0	0	0	1	1	1	STATUS
0	0	0	0	1	0	0	0	DAC DATA

8.5.1.2.2.3 Data Byte (MSDB and LSDB)

The MSDB and LSDB contain the data that are passed to the register or registers specified by the command byte, as shown in 表 8-5. The DACx0501 update at the falling edge of the acknowledge signal that follows the LSDB[0] bit.

表 8-5. DACx0501 Data Byte

REGISTER	COMMAND BITS				DATA BITS																
					NOOP								LSDB								
	B19	B18	B17	B16	B15	B14	B13	B12	B11	B10	B9	B8	B7	B6	B5	B4	B3	B2	B1	B0	
NOOP	0	0	0	0	NOOP																
DEVID	0	0	0	1	0	RESOLUTION		0	0	1	0	RSTSEL	0	0	1	0	1	0	1		
SYNC	0	0	1	0	RESERVED																DAC_SYNC_EN
CONFIG	0	0	1	1	RESERVED						REF-PWDWN	RESERVED						DAC_PWDWN			
GAIN	0	1	0	0	RESERVED						REF-DIV	RESERVED						BUF-GAIN			
TRIGGER	0	1	0	1											LDAC	SOFT-RESET [3:0]					
STATUS	0	1	1	1	RESERVED														REF-ALARM		
DAC DATA	1	0	0	0	DAC-DATA [15:0] for 16-bit, DAC-DATA [13:0] for 14-bit, DAC-DATA [11:0] for 12-bit, left aligned																

8.6 Register Map

表 8-7. Register Map

OFFSET	REGISTER NAME	REGISTER DESCRIPTION	SECTION
0h	NOOP	No operation	NOOP Register
1h	DEVID	Device identification	DEVID Register
2h	SYNC	Synchronization	SYNC Register
3h	CONFIG	Configuration	CONFIG Register
4h	GAIN	Gain	GAIN Register
5h	TRIGGER	Trigger	TRIGGER Register
7h	STATUS	Status	STATUS Register
8h	DAC	Digital-to-analog converter	DAC Register

NOOP Register (offset = 0h) [reset = 0000h]

图 8-8. NOOP Register

15	14	13	12	11	10	9	8	7	6	5	4	3	2	1	0
NOOP															
W-0h															

表 8-8. NOOP Register Field Descriptions

Bit	Field	Type	Reset	Description
15-0	No operation	W	0h	No Operation command

DEVID Register (offset = 1h) [reset = 0115h for DAC80501Z, reset = 1115h for DAC70501Z, reset = 2115h for DAC60501Z, reset = 0195h for DAC80501M, reset = 1195h for DAC70501M, or reset = 2195h for DAC60501M]

图 8-9. DEVID Register

15	14	13	12	11	10	9	8	7	6	5	4	3	2	1	0
0	RESOLUTION	0	0	0	0	1	RSTSEL	0	0	1	0	1	0	1	
R-0h	R-000b (DAC80501) or 001b (DAC70501) or 010b (DAC60501)	R-0h	R-0h	R-0h	R-1h	R-0h	(DACx0501Z) or 1h (DACx0501M)	R-0h	R-0h	R-1h	R-0h	R-1h	R-0h	R-1h	

表 8-9. DEVID Register Field Descriptions

Bit	Field	Type	Reset	Description
15	RESERVED	R	0h	RESERVED
14-12	RESOLUTION	R	000b for DAC80501 001b for DAC70501 010b for DAC60501	DAC Resolution: 000b (DAC80501 16-bit) 001b (DAC70501 14-bit) 010b (DAC60501 12-bit)
11-8	RESERVED	R	1h	RESERVED
7	RSTSEL	R	0h for DACx0501Z 1h for DACx0501M	DAC Power on Reset: 0h (DACx0501Z reset to zero scale) 1h (DACx0501M reset to midscale)
6-0	RESERVED	R	15h	RESERVED

SYNC Register (offset = 2h) [reset = 0000h]

图 8-10. SYNC Register

15	14	13	12	11	10	9	8	7	6	5	4	3	2	1	0
RESERVED														DAC_SYNC_EN	
R/W-0h														R/W-0h	

表 8-10. SYNC Register Field Descriptions

Bit	Field	Type	Reset	Description
15-1	RESERVED	RW	0h	RESERVED
0	DAC_SYNC_EN	RW	0h	When set to 1, the DAC output is set to update in response to an LDAC trigger (synchronous mode). When cleared to 0, the DAC output is set to update immediately (asynchronous mode), default.

CONFIG Register (offset = 3h) [reset = 0000h]

图 8-11. CONFIG Register

15	14	13	12	11	10	9	8	7	6	5	4	3	2	1	0
RESERVED							REF_PWDWN	RESERVED						DAC_PWDWN	
R/W-0h							R/W-0h	R/W-0h						R/W-0h	

表 8-11. CONFIG Register Field Descriptions

Bit	Field	Type	Reset	Description
15-9	RESERVED	RW	0h	RESERVED
8	REF_PWDWN	RW	0h	When set to 1, this bit disables the device internal reference.
7-1	RESERVED	RW	0h	RESERVED
0	DAC_PWDWN	RW	0h	When set to 1, the DAC in power-down mode and the DAC output is connected to GND through a 1-kΩ internal resistor.

GAIN Register (offset = 4h) [reset = 0001h]

图 8-12. GAIN Register

15	14	13	12	11	10	9	8	7	6	5	4	3	2	1	0
RESERVED							REF-DIV	RESERVED							BUFF-GAIN
R/W-0h							R/W-0h	R/W-0h							R/W-1h

表 8-12. GAIN Register Field Descriptions

Bit	Field	Type	Reset	Description
15-9	RESERVED	RW	0h	RESERVED
8	REF-DIV	RW	0h	The reference voltage to the device (either from the internal or external reference) can be divided by a factor of two by setting the REF-DIV bit to 1. Make sure to configure REF-DIV so that there is sufficient headroom from VDD to the DAC operating reference voltage. Improper configuration of the reference divider triggers a reference alarm condition. In the case of an alarm condition, the reference buffer is shut down, and all the DAC outputs go to 0 V. The DAC data registers are unaffected by the alarm condition, and thus enable the DAC output to return to normal operation after the reference divider is configured correctly. When REF-DIV set to 1, the reference voltage is internally divided by a factor of 2. When REF-DIV is cleared to 0, the reference voltage is unaffected.
7-1	RESERVED	RW	0h	RESERVED
0	BUFF-GAIN	RW	1h	When set to 1, the buffer amplifier for corresponding DAC has a gain of 2. When cleared to 0, the buffer amplifier for corresponding DAC has a gain of 1.

TRIGGER Register (offset = 5h) [reset = 0000h]

图 8-13. TRIGGER Register

15	14	13	12	11	10	9	8	7	6	5	4	3	2	1	0
RESERVED											LDAC	SOFT-RESET [3:0]			
R/W-0h											W-0h	W-0h			

表 8-13. TRIGGER Register Field Descriptions

Bit	Field	Type	Reset	Description
15-5	RESERVED	RW	0h	RESERVED
4	LDAC	W	0h	Set this bit to 1 to synchronously load the DAC in synchronous mode. This bit is self resetting.
3-0	SOFT-RESET [3:0]	W	0h	When set to the reserved code of 1010, this bit resets the device to the default state. These bits are self resetting.

STATUS Register (offset = 7h) [reset = 0000h]

图 8-14. STATUS Register

15	14	13	12	11	10	9	8	7	6	5	4	3	2	1	0
RESERVED														REF-ALARM	
R/W-0h														R-0h	

表 8-14. STATUS Register Field Descriptions

Bit	Field	Type	Reset	Description
15-1	RESERVED	RW	0h	RESERVED
0	REF-ALARM	R	0	REF-ALARM bit. Reads 1 when the difference between the reference and supply pins is below a minimum analog threshold. Reads 0 otherwise. When 1, the reference buffer is shut down, and the DAC outputs are all zero volts. The DAC codes are unaffected, and the DAC output returns to normal when the difference is above the analog threshold.

DAC Register (offset = 8h) [reset = 0000h for DACx0501Z or reset = 8000h for DACx0501M]

图 8-15. DAC Register

15	14	13	12	11	10	9	8	7	6	5	4	3	2	1	0
DAC-DATA [15:0]															
R/W-0000h (DACx0501Z) or 8000h (DACx0501M)															

表 8-15. DAC Register Field Descriptions

Bit	Field	Type	Reset	Description
15-0	DAC-DATA [15:0]	RW	0000h for DACx0501Z 8000h for DACx0501M	DAC data register. Data are MSB aligned in straight binary format, and use the following format: DAC80501: DATA[15:0] DAC70501: DATA[13:0], 0, 0 DAC60501: DATA[11:0], 0, 0, 0, 0

9 Application and Implementation

备注

以下应用部分中的信息不属于 TI 器件规格的范围，TI 不担保其准确性和完整性。TI 的客户应负责确定器件是否适用于其应用。客户应验证并测试其设计，以确保系统功能。

9.1 Application Information

Applications that incorporate analog circuits often require trimming, control, biasing, or a combination of all three. These functions require high-accuracy, simple-to-implement compact solutions. The DACx0501 family of precision DACs are an excellent choice for such applications. The DACx0501 tiny package, high resolution, and simple interface make these devices an excellent choice for applications such as offset and gain control, VCO tuning, programmable reference, and more. With the aforementioned features, this family of DACs caters to a wide range of end equipment, such as battery testers, communications equipment, factory automation and control, test and measurement, and more.

9.2 Typical Application

End equipment, such as oscilloscopes, battery test equipment, and other lab instruments require precision calibration and control signals to tune the system accuracy. Precision DACs are typically used to generate these signals. The complexity and accuracy of these systems are driving the need for multiple precision signals to be generated in the system. The common approach for generating these signal is by using a multichannel DAC. An alternative way to generate these signal is to use a single-channel DAC with a sample-and-hold circuit to produce multichannel output. Using this approach, users can generate a customized number of channels instead of using a fixed number of channels available in multichannel DACs.



图 9-1. Multichannel Sample-and-Hold Circuit

9.2.1 Design Requirements

The design requirements for this circuit are as follows:

- Output range: 0-V to 5-V
- Channels: 10
- Output offset error: ± 3 -mV

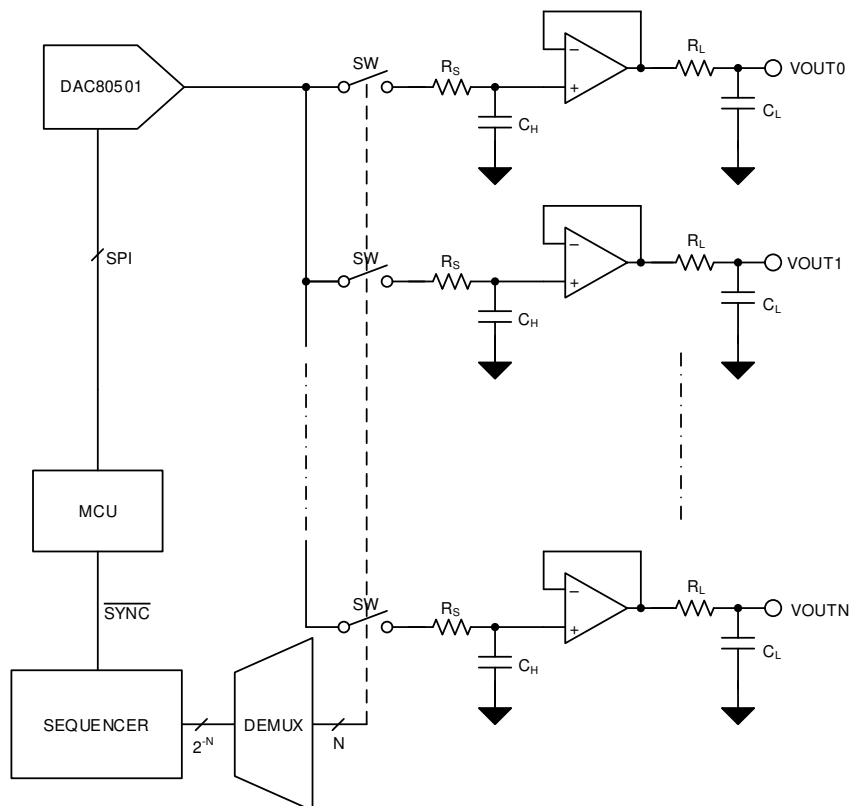
9.2.2 Detailed Design Procedure

A basic sample-and-hold circuit consists of a voltage source (DAC in this case), a switch, a capacitor, and a buffer. As the name implies, this circuit has two modes of operation: *sample* and *hold*. In sample mode, the switch is closed connecting the DAC output to the hold capacitor, C_H . In hold mode, the switch opens, disconnecting the DAC output from C_H . Thus, the final output is held to the sampled value because of the charge stored on hold capacitor C_H . The output buffer is needed for delivering the required current. In a practical circuit, the switch leakage and the amplifier bias current make the capacitor drift from the stored value. Therefore, the sample-and-hold circuit must be refreshed, even if the DAC value does not change. The key design parameters of a sample-and-hold circuit are charge injection and voltage droop.

9.2.2.1 Charge Injection

During the sample-to-hold transition, a small amount of charge is injected onto the hold capacitor, mostly because of the stray capacitance of the switch that creates small level changes when transitioning between states. The resulting dc offset is typically referred to as pedestal error. This error contributes to the offset error of the system. The pedestal error, ΔV_{OUT} , is the measured offset voltage resulting from charge injection when the switch transitions to hold state. ΔV_{OUT} is related to charge injection through [方程式 2](#).

$$\Delta V_{OUT} = \frac{Q}{C} \quad (2)$$

where

- Q is the injected charge coulombs.
- C is the value of the hold capacitor in farads.

In most solid-state switch data sheets, charge injection is graphed with respect to supply voltage, analog input, or temperature. A charge injection value of 3 pC is typical in many solid-state switches under the conditions: 25°C, 5-V supply, and 0-V analog input.

9.2.2.2 Voltage Droop

In hold mode, the voltage across C_H that usually remains constant suffers a droop because of the leakage resistance of the switch and the amplifier bias current. A simplified equation for calculating the voltage droop is given by [方程式 3](#)

$$\frac{\Delta V}{\Delta t} = \frac{(I_{LEAK} + I_{BIAS})}{C} \quad (3)$$

where

- I_{LEAK} is the leakage current through the switch in amperes.
- I_{BIAS} is the bias current of the amplifier in amperes.
- C is the value of the hold capacitance in farads.

9.2.2.3 Output Offset Error

The output offset error of a sample-and-hold channel is the cumulative error contributed by the DAC offset error, amplifier offset error, and sample-and-hold pedestal error due to charge injection. The amplifier offset error can be made negligible by choosing a low-offset amplifier, such as the [OPA4317](#). The OPA4317 has a maximum offset error of 0.1 mV. The DAC80501 has a maximum offset error of ± 1.5 mV. Thus, to achieve a total offset error less than ± 3 mV, limit the offset error contributed by the sample-and-hold circuit to ± 1.5 mV.

Considering the bias current of 300 pA in the OPA4317, and a typical switch leakage current of 1 nA, a 2-nF hold capacitor results in a droop rate of 0.65 V/s. When the sample-and-hold circuit refreshes at a rate of more than 100 μ s, the voltage droop is 65 μ V. This small offset error can be ignored for the simplicity of calculation. Thus, the only contributor to the sample-and-hold offset error is the pedestal error. For a charge injection of 3 pC and a pedestal error of 1.5 mV, the value of the hold capacitor is calculated as 2 nF, according to [方程式 2](#). A capacitive load of 2 nF can be handled by the DAC80501. The switch-on resistance and optional series resistance R_S further helps in the stability of the DAC output amplifier. R_S can be omitted for better settling time.

9.2.2.4 Switch Selection

The switch in the design must feature low on-state resistance and low off leakage, and must conduct rail-to-rail analog signals. Very low charge injection is also a primary factor for selecting the switch. The [TS12A4515](#) are single pole and single throw (SPST), low-voltage, single-supply CMOS analog switches with 20- Ω on-state resistance, 3 pC of charge-injection (5-V supply), and an off-Leakage current value of 1 nA.

9.2.2.5 Amplifier Selection

The key parameters for the amplifier in this system are low offset voltage and low input bias current. The OPA4317 is a quad amplifier that has a max offset voltage of 100 μ V and a max bias current of 300 pA. As a result of the quad package, less board area is used.

9.2.2.6 Hold Capacitor Selection

Use a hold capacitor that has high insulation resistance, low temperature coefficient, and low dielectric absorption. Low temperature coefficient NP0/C0G ceramic capacitors are a great choice for this purpose. As calculated in [方程式 2](#), a 2-nF capacitor provides a total offset error of ± 3 mV per channel.

9.2.3 Application Curves



图 9-2. Sample-and-Hold Pedestal Error With 3-pC Charge Injection

9.3 Power Supply Recommendations

The DACx0501 operate within the specified VDD supply range of 2.7 V to 5.5 V. The DACx0501 do not require specific supply sequencing.

The VDD supply must be well regulated and low noise. Switching power supplies and DC/DC converters often have high-frequency glitches or spikes riding on the output voltage. In addition, digital components create similar high-frequency spikes. This noise can easily couple into the DAC output voltage through various paths between the power connections and analog output. To further minimize noise from the power supply, include a 1- μ F to 10- μ F capacitor and 0.1- μ F bypass capacitor. The current consumption on the VDD pin, the short-circuit current limit, and the load current for the device is listed in [§ 7.5](#). The power supply must meet the aforementioned current requirements.

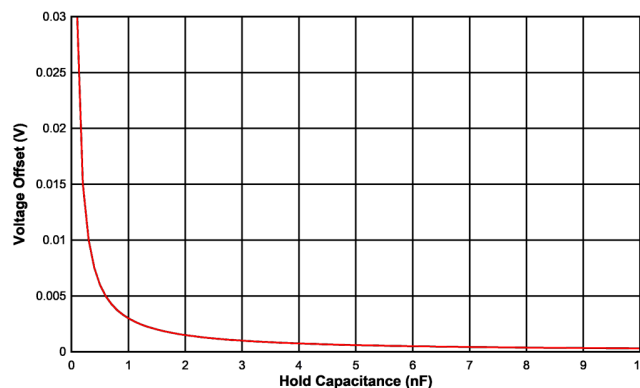
9.4 Layout

9.4.1 Layout Guidelines

A precision analog component requires careful layout. The following list provides some insight into good layout practices.

- Bypass the VDD to ground with a low ESR ceramic bypass capacitor. The typical recommended bypass capacitance is 0.1- μ F to 0.22- μ F ceramic capacitor, with a X7R or NP0 dielectric.
- Place power supplies and REF bypass capacitors close to the pins to minimize inductance and optimize performance.
- Use a high-quality, ceramic-type NP0 or X7R for optimal performance across temperature, and a very low dissipation factor.
- The digital and analog sections must have proper placement with respect to the digital pins and analog pins of the DACx0501 devices. The separation of analog and digital blocks minimizes coupling into neighboring blocks, as well as interaction between analog and digital return currents.

9.4.2 Layout Example



图 9-3. Layout Example

10 Device and Documentation Support

10.1 Documentation Support

10.1.1 Related Documentation

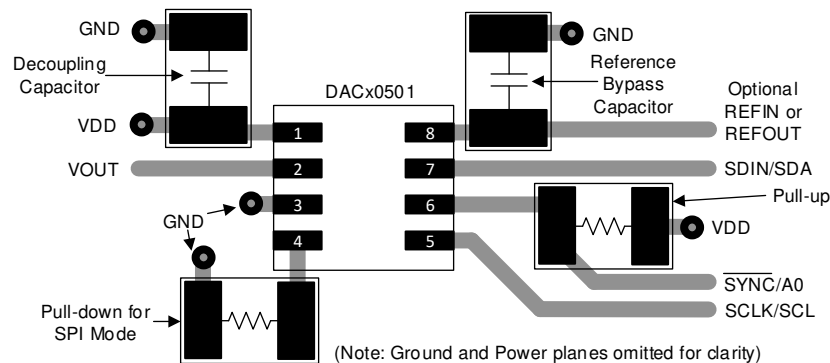
For related documentation see the following: Texas Instruments, [DAC80501EVM user's guide](#)

10.2 接收文档更新通知

要接收文档更新通知，请导航至 [ti.com](#) 上的器件产品文件夹。点击 [订阅更新](#) 进行注册，即可每周接收产品信息更改摘要。有关更改的详细信息，请查看任何已修订文档中包含的修订历史记录。

10.3 支持资源

[TI E2E™ 支持论坛](#) 是工程师的重要参考资料，可直接从专家获得快速、经过验证的解答和设计帮助。搜索现有解答或提出自己的问题可获得所需的快速设计帮助。

链接的内容由各个贡献者“按原样”提供。这些内容并不构成 TI 技术规范，并且不一定反映 TI 的观点；请参阅 TI 的《[使用条款](#)》。

10.4 Trademarks

TI E2E™ is a trademark of Texas Instruments.

所有商标均为其各自所有者的财产。

10.5 静电放电警告



静电放电 (ESD) 会损坏这个集成电路。德州仪器 (TI) 建议通过适当的预防措施处理所有集成电路。如果不遵守正确的处理和安装程序，可能会损坏集成电路。

ESD 的损坏小至导致微小的性能降级，大至整个器件故障。精密的集成电路可能更容易受到损坏，这是因为非常细微的参数更改都可能会导致器件与其发布的规格不相符。

10.6 术语表

[TI 术语表](#) 本术语表列出并解释了术语、首字母缩略词和定义。

11 Mechanical, Packaging, and Orderable Information

The following pages include mechanical, packaging, and orderable information. This information is the most current data available for the designated devices. This data is subject to change without notice and revision of this document. For browser-based versions of this data sheet, refer to the left-hand navigation.

PACKAGING INFORMATION

Orderable Device	Status (1)	Package Type	Package Drawing	Pins	Package Qty	Eco Plan (2)	Lead finish/ Ball material (6)	MSL Peak Temp (3)	Op Temp (°C)	Device Marking (4/5)	Samples
DAC60501MDGSR	ACTIVE	VSSOP	DGS	10	2500	RoHS & Green	NIPDAUAG SN	Level-2-260C-1 YEAR	-40 to 125	651M	Samples
DAC60501MDGST	ACTIVE	VSSOP	DGS	10	250	RoHS & Green	NIPDAUAG SN	Level-2-260C-1 YEAR	-40 to 125	651M	Samples
DAC60501MDQFR	ACTIVE	WSOP	DQF	8	3000	RoHS & Green	NIPDAU	Level-2-260C-1 YEAR	-40 to 125	651M	Samples
DAC60501MDQFT	ACTIVE	WSOP	DQF	8	250	RoHS & Green	NIPDAU	Level-2-260C-1 YEAR	-40 to 125	651M	Samples
DAC60501ZDGSR	ACTIVE	VSSOP	DGS	10	2500	RoHS & Green	NIPDAUAG SN	Level-2-260C-1 YEAR	-40 to 125	651Z	Samples
DAC60501ZDGST	ACTIVE	VSSOP	DGS	10	250	RoHS & Green	NIPDAUAG SN	Level-2-260C-1 YEAR	-40 to 125	651Z	Samples
DAC60501ZDQFR	ACTIVE	WSOP	DQF	8	3000	RoHS & Green	NIPDAU	Level-2-260C-1 YEAR	-40 to 125	651Z	Samples
DAC60501ZDQFT	ACTIVE	WSOP	DQF	8	250	RoHS & Green	NIPDAU	Level-2-260C-1 YEAR	-40 to 125	651Z	Samples
DAC70501MDGSR	ACTIVE	VSSOP	DGS	10	2500	RoHS & Green	NIPDAUAG SN	Level-2-260C-1 YEAR	-40 to 125	751M	Samples
DAC70501MDGST	ACTIVE	VSSOP	DGS	10	250	RoHS & Green	NIPDAUAG SN	Level-2-260C-1 YEAR	-40 to 125	751M	Samples
DAC70501MDQFR	ACTIVE	WSOP	DQF	8	3000	RoHS & Green	NIPDAU	Level-2-260C-1 YEAR	-40 to 125	751M	Samples
DAC70501MDQFT	ACTIVE	WSOP	DQF	8	250	RoHS & Green	NIPDAU	Level-2-260C-1 YEAR	-40 to 125	751M	Samples
DAC70501ZDGSR	ACTIVE	VSSOP	DGS	10	2500	RoHS & Green	NIPDAUAG SN	Level-2-260C-1 YEAR	-40 to 125	751Z	Samples
DAC70501ZDGST	ACTIVE	VSSOP	DGS	10	250	RoHS & Green	NIPDAUAG SN	Level-2-260C-1 YEAR	-40 to 125	751Z	Samples
DAC70501ZDQFR	ACTIVE	WSOP	DQF	8	3000	RoHS & Green	NIPDAU	Level-2-260C-1 YEAR	-40 to 125	751Z	Samples
DAC70501ZDQFT	ACTIVE	WSOP	DQF	8	250	RoHS & Green	NIPDAU	Level-2-260C-1 YEAR	-40 to 125	751Z	Samples
DAC80501MDGSR	ACTIVE	VSSOP	DGS	10	2500	RoHS & Green	NIPDAUAG SN	Level-2-260C-1 YEAR	-40 to 125	851M	Samples
DAC80501MDGST	ACTIVE	VSSOP	DGS	10	250	RoHS & Green	NIPDAUAG SN	Level-2-260C-1 YEAR	-40 to 125	851M	Samples
DAC80501MDQFR	ACTIVE	WSOP	DQF	8	3000	RoHS & Green	NIPDAU	Level-2-260C-1 YEAR	-40 to 125	851M	Samples
DAC80501MDQFT	ACTIVE	WSOP	DQF	8	250	RoHS & Green	NIPDAU	Level-2-260C-1 YEAR	-40 to 125	851M	Samples

Orderable Device	Status (1)	Package Type	Package Drawing	Pins	Package Qty	Eco Plan (2)	Lead finish/ Ball material (6)	MSL Peak Temp (3)	Op Temp (°C)	Device Marking (4/5)	Samples
DAC80501ZDGSR	ACTIVE	VSSOP	DGS	10	2500	RoHS & Green	NIPDAUAG SN	Level-2-260C-1 YEAR	-40 to 125	851Z	Samples
DAC80501ZDGST	ACTIVE	VSSOP	DGS	10	250	RoHS & Green	NIPDAUAG SN	Level-2-260C-1 YEAR	-40 to 125	851Z	Samples
DAC80501ZDQFR	ACTIVE	WSON	DQF	8	3000	RoHS & Green	NIPDAU	Level-2-260C-1 YEAR	-40 to 125	851Z	Samples
DAC80501ZDQFT	ACTIVE	WSON	DQF	8	250	RoHS & Green	NIPDAU	Level-2-260C-1 YEAR	-40 to 125	851Z	Samples

(1) The marketing status values are defined as follows:

ACTIVE: Product device recommended for new designs.

LIFEBUY: TI has announced that the device will be discontinued, and a lifetime-buy period is in effect.

NRND: Not recommended for new designs. Device is in production to support existing customers, but TI does not recommend using this part in a new design.

PREVIEW: Device has been announced but is not in production. Samples may or may not be available.

OBSELETE: TI has discontinued the production of the device.

(2) **RoHS:** TI defines "RoHS" to mean semiconductor products that are compliant with the current EU RoHS requirements for all 10 RoHS substances, including the requirement that RoHS substance do not exceed 0.1% by weight in homogeneous materials. Where designed to be soldered at high temperatures, "RoHS" products are suitable for use in specified lead-free processes. TI may reference these types of products as "Pb-Free".

RoHS Exempt: TI defines "RoHS Exempt" to mean products that contain lead but are compliant with EU RoHS pursuant to a specific EU RoHS exemption.

Green: TI defines "Green" to mean the content of Chlorine (Cl) and Bromine (Br) based flame retardants meet JS709B low halogen requirements of <=1000ppm threshold. Antimony trioxide based flame retardants must also meet the <=1000ppm threshold requirement.

(3) MSL, Peak Temp. - The Moisture Sensitivity Level rating according to the JEDEC industry standard classifications, and peak solder temperature.

(4) There may be additional marking, which relates to the logo, the lot trace code information, or the environmental category on the device.

(5) Multiple Device Markings will be inside parentheses. Only one Device Marking contained in parentheses and separated by a "~" will appear on a device. If a line is indented then it is a continuation of the previous line and the two combined represent the entire Device Marking for that device.

(6) Lead finish/Ball material - Orderable Devices may have multiple material finish options. Finish options are separated by a vertical ruled line. Lead finish/Ball material values may wrap to two lines if the finish value exceeds the maximum column width.

Important Information and Disclaimer: The information provided on this page represents TI's knowledge and belief as of the date that it is provided. TI bases its knowledge and belief on information provided by third parties, and makes no representation or warranty as to the accuracy of such information. Efforts are underway to better integrate information from third parties. TI has taken and continues to take reasonable steps to provide representative and accurate information but may not have conducted destructive testing or chemical analysis on incoming materials and chemicals. TI and TI suppliers consider certain information to be proprietary, and thus CAS numbers and other limited information may not be available for release.

In no event shall TI's liability arising out of such information exceed the total purchase price of the TI part(s) at issue in this document sold by TI to Customer on an annual basis.

TAPE AND REEL INFORMATION



QUADRANT ASSIGNMENTS FOR PIN 1 ORIENTATION IN TAPE



*All dimensions are nominal

Device	Package Type	Package Drawing	Pins	SPQ	Reel Diameter (mm)	Reel Width W1 (mm)	A0 (mm)	B0 (mm)	K0 (mm)	P1 (mm)	W (mm)	Pin1 Quadrant
DAC60501MDGSR	VSSOP	DGS	10	2500	330.0	12.4	5.25	3.35	1.25	8.0	12.0	Q1
DAC60501MDGST	VSSOP	DGS	10	250	330.0	12.4	5.25	3.35	1.25	8.0	12.0	Q1
DAC60501MDQFR	WSO	DQF	8	3000	180.0	8.4	2.2	2.2	1.2	4.0	8.0	Q2
DAC60501MDQFT	WSO	DQF	8	250	180.0	8.4	2.2	2.2	1.2	4.0	8.0	Q2
DAC60501ZDGSR	VSSOP	DGS	10	2500	330.0	12.4	5.25	3.35	1.25	8.0	12.0	Q1
DAC60501ZDGST	VSSOP	DGS	10	250	330.0	12.4	5.25	3.35	1.25	8.0	12.0	Q1
DAC60501ZDQFR	WSO	DQF	8	3000	180.0	8.4	2.2	2.2	1.2	4.0	8.0	Q2
DAC60501ZDQFT	WSO	DQF	8	250	180.0	8.4	2.2	2.2	1.2	4.0	8.0	Q2
DAC70501MDGSR	VSSOP	DGS	10	2500	330.0	12.4	5.25	3.35	1.25	8.0	12.0	Q1
DAC70501MDGST	VSSOP	DGS	10	250	330.0	12.4	5.25	3.35	1.25	8.0	12.0	Q1
DAC70501MDQFR	WSO	DQF	8	3000	180.0	8.4	2.2	2.2	1.2	4.0	8.0	Q2
DAC70501MDQFT	WSO	DQF	8	250	180.0	8.4	2.2	2.2	1.2	4.0	8.0	Q2
DAC70501ZDGSR	VSSOP	DGS	10	2500	330.0	12.4	5.25	3.35	1.25	8.0	12.0	Q1
DAC70501ZDGST	VSSOP	DGS	10	250	330.0	12.4	5.25	3.35	1.25	8.0	12.0	Q1
DAC70501ZDQFR	WSO	DQF	8	3000	180.0	8.4	2.2	2.2	1.2	4.0	8.0	Q2
DAC70501ZDQFT	WSO	DQF	8	250	180.0	8.4	2.2	2.2	1.2	4.0	8.0	Q2

Device	Package Type	Package Drawing	Pins	SPQ	Reel Diameter (mm)	Reel Width W1 (mm)	A0 (mm)	B0 (mm)	K0 (mm)	P1 (mm)	W (mm)	Pin1 Quadrant
DAC80501MDGSR	VSSOP	DGS	10	2500	330.0	12.4	5.25	3.35	1.25	8.0	12.0	Q1
DAC80501MDGST	VSSOP	DGS	10	250	330.0	12.4	5.25	3.35	1.25	8.0	12.0	Q1
DAC80501MDQFR	WSO	DQF	8	3000	180.0	8.4	2.2	2.2	1.2	4.0	8.0	Q2
DAC80501MDQFT	WSO	DQF	8	250	180.0	8.4	2.2	2.2	1.2	4.0	8.0	Q2
DAC80501ZDGSR	VSSOP	DGS	10	2500	330.0	12.4	5.25	3.35	1.25	8.0	12.0	Q1
DAC80501ZDGST	VSSOP	DGS	10	250	330.0	12.4	5.25	3.35	1.25	8.0	12.0	Q1
DAC80501ZDQFR	WSO	DQF	8	3000	180.0	8.4	2.2	2.2	1.2	4.0	8.0	Q2
DAC80501ZDQFT	WSO	DQF	8	250	180.0	8.4	2.2	2.2	1.2	4.0	8.0	Q2

TAPE AND REEL BOX DIMENSIONS



*All dimensions are nominal

Device	Package Type	Package Drawing	Pins	SPQ	Length (mm)	Width (mm)	Height (mm)
DAC60501MDGSR	VSSOP	DGS	10	2500	366.0	364.0	50.0
DAC60501MDGST	VSSOP	DGS	10	250	366.0	364.0	50.0
DAC60501MDQFR	WSON	DQF	8	3000	213.0	191.0	35.0
DAC60501MDQFT	WSON	DQF	8	250	213.0	191.0	35.0
DAC60501ZDGSR	VSSOP	DGS	10	2500	366.0	364.0	50.0
DAC60501ZDGST	VSSOP	DGS	10	250	366.0	364.0	50.0
DAC60501ZDQFR	WSON	DQF	8	3000	213.0	191.0	35.0
DAC60501ZDQFT	WSON	DQF	8	250	213.0	191.0	35.0
DAC70501MDGSR	VSSOP	DGS	10	2500	366.0	364.0	50.0
DAC70501MDGST	VSSOP	DGS	10	250	366.0	364.0	50.0
DAC70501MDQFR	WSON	DQF	8	3000	213.0	191.0	35.0
DAC70501MDQFT	WSON	DQF	8	250	213.0	191.0	35.0
DAC70501ZDGSR	VSSOP	DGS	10	2500	366.0	364.0	50.0
DAC70501ZDGST	VSSOP	DGS	10	250	366.0	364.0	50.0
DAC70501ZDQFR	WSON	DQF	8	3000	213.0	191.0	35.0
DAC70501ZDQFT	WSON	DQF	8	250	213.0	191.0	35.0
DAC80501MDGSR	VSSOP	DGS	10	2500	366.0	364.0	50.0
DAC80501MDGST	VSSOP	DGS	10	250	366.0	364.0	50.0

Device	Package Type	Package Drawing	Pins	SPQ	Length (mm)	Width (mm)	Height (mm)
DAC80501MDQFR	WSON	DQF	8	3000	213.0	191.0	35.0
DAC80501MDQFT	WSON	DQF	8	250	213.0	191.0	35.0
DAC80501ZDGSR	VSSOP	DGS	10	2500	366.0	364.0	50.0
DAC80501ZDGST	VSSOP	DGS	10	250	366.0	364.0	50.0
DAC80501ZDQFR	WSON	DQF	8	3000	213.0	191.0	35.0
DAC80501ZDQFT	WSON	DQF	8	250	213.0	191.0	35.0

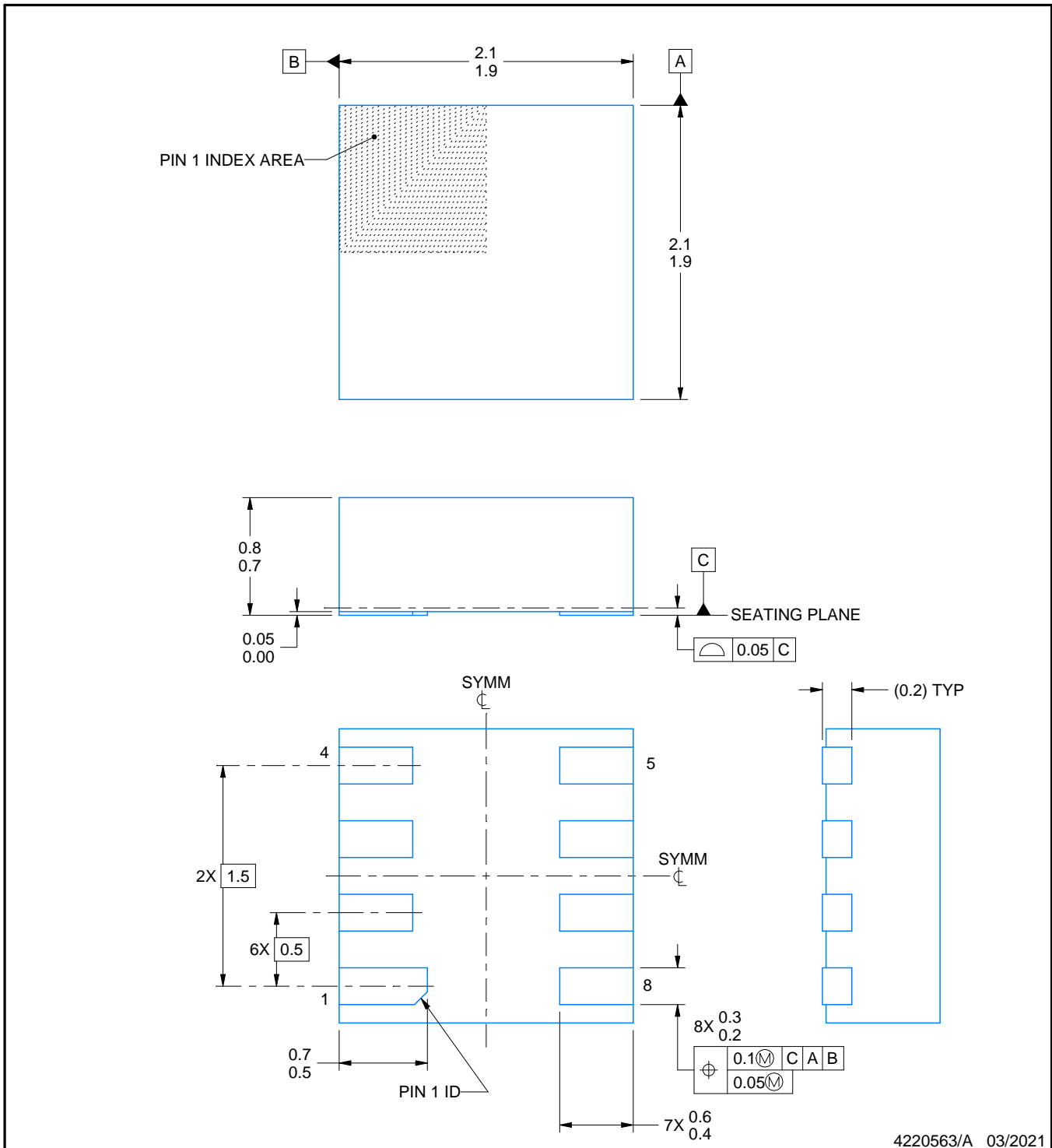
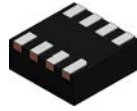

NOTES:

1. All linear dimensions are in millimeters. Any dimensions in parenthesis are for reference only. Dimensioning and tolerancing per ASME Y14.5M.
2. This drawing is subject to change without notice.

EXAMPLE BOARD LAYOUT

DQF0008A

WSON - 0.8 mm max height

PLASTIC SMALL OUTLINE - NO LEAD

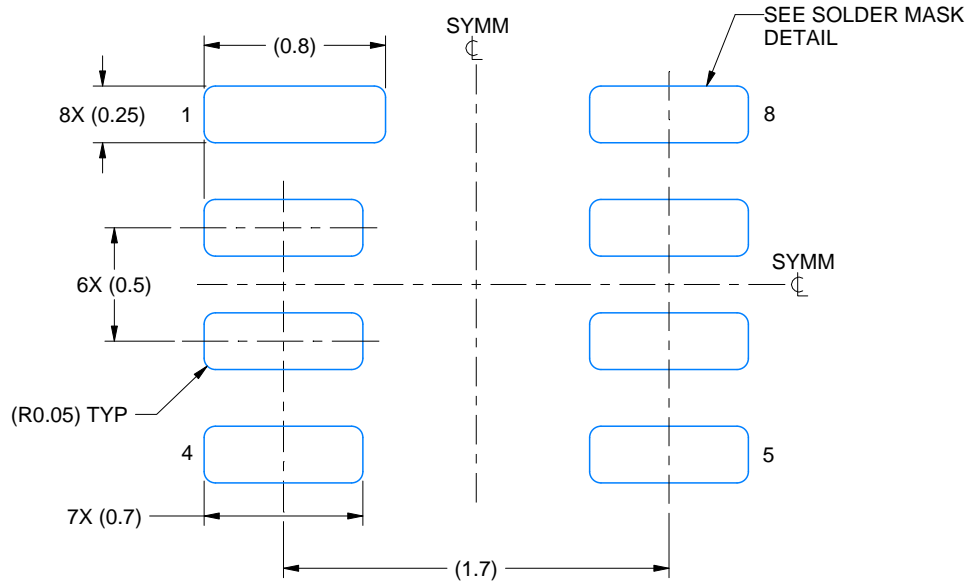

LAND PATTERN EXAMPLE
EXPOSED METAL SHOWN
SCALE: 30X

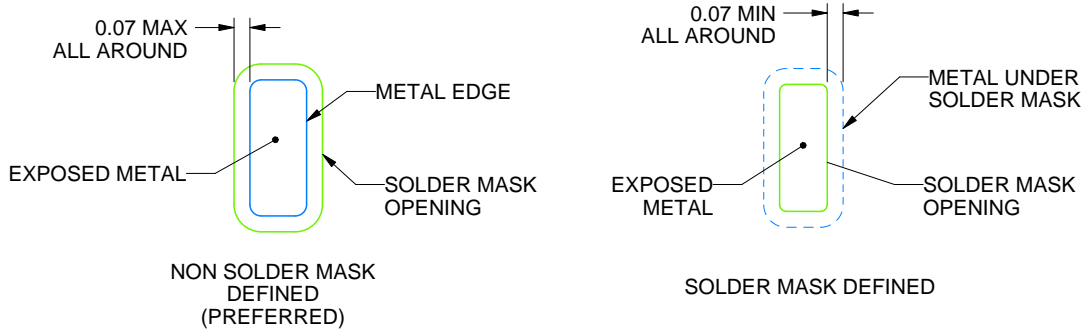

SOLDER MASK DETAILS

4220563/A 03/2021

NOTES: (continued)

- This package is designed to be soldered to a thermal pad on the board. For more information, see Texas Instruments literature number SLUA271 (www.ti.com/lit/slua271).

EXAMPLE STENCIL DESIGN

DQF0008A

WSON - 0.8 mm max height

PLASTIC SMALL OUTLINE - NO LEAD

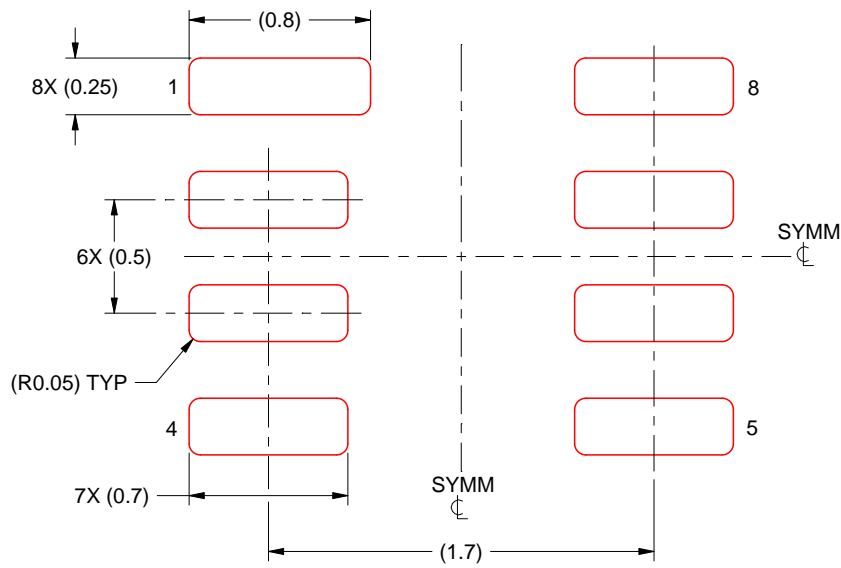

SOLDER PASTE EXAMPLE
BASED ON 0.125 MM THICK STENCIL
SCALE: 30X

4220563/A 03/2021

NOTES: (continued)

4. Laser cutting apertures with trapezoidal walls and rounded corners may offer better paste release. IPC-7525 may have alternate design recommendations.

DGS0010A



PACKAGE OUTLINE

VSSOP - 1.1 mm max height

SMALL OUTLINE PACKAGE



4221984/A 05/2015

NOTES:

1. All linear dimensions are in millimeters. Any dimensions in parenthesis are for reference only. Dimensioning and tolerancing per ASME Y14.5M.
2. This drawing is subject to change without notice.
3. This dimension does not include mold flash, protrusions, or gate burrs. Mold flash, protrusions, or gate burrs shall not exceed 0.15 mm per side.
4. This dimension does not include interlead flash. Interlead flash shall not exceed 0.25 mm per side.
5. Reference JEDEC registration MO-187, variation BA.

EXAMPLE BOARD LAYOUT

DGS0010A

VSSOP - 1.1 mm max height

SMALL OUTLINE PACKAGE



LAND PATTERN EXAMPLE
SCALE:10X



SOLDER MASK DETAILS
NOT TO SCALE

4221984/A 05/2015

NOTES: (continued)

- 6. Publication IPC-7351 may have alternate designs.
- 7. Solder mask tolerances between and around signal pads can vary based on board fabrication site.

EXAMPLE STENCIL DESIGN

DGS0010A

VSSOP - 1.1 mm max height

SMALL OUTLINE PACKAGE



SOLDER PASTE EXAMPLE
BASED ON 0.125 mm THICK STENCIL
SCALE:10X

4221984/A 05/2015

NOTES: (continued)

8. Laser cutting apertures with trapezoidal walls and rounded corners may offer better paste release. IPC-7525 may have alternate design recommendations.
9. Board assembly site may have different recommendations for stencil design.

重要声明和免责声明

TI“按原样”提供技术和可靠性数据（包括数据表）、设计资源（包括参考设计）、应用或其他设计建议、网络工具、安全信息和其他资源，不保证没有瑕疵且不做任何明示或暗示的担保，包括但不限于对适销性、某特定用途方面的适用性或不侵犯任何第三方知识产权的暗示担保。

这些资源可供使用 TI 产品进行设计的熟练开发人员使用。您将自行承担以下全部责任：(1) 针对您的应用选择合适的 TI 产品，(2) 设计、验证并测试您的应用，(3) 确保您的应用满足相应标准以及任何其他功能安全、信息安全、监管或其他要求。

这些资源如有变更，恕不另行通知。TI 授权您仅可将这些资源用于研发本资源所述的 TI 产品的应用。严禁对这些资源进行其他复制或展示。您无权使用任何其他 TI 知识产权或任何第三方知识产权。您应全额赔偿因在这些资源的使用中对 TI 及其代表造成的任何索赔、损害、成本、损失和债务，TI 对此概不负责。

TI 提供的产品受 [TI 的销售条款](#) 或 [ti.com](#) 上其他适用条款/TI 产品随附的其他适用条款的约束。TI 提供这些资源并不会扩展或以其他方式更改 TI 针对 TI 产品发布的适用的担保或担保免责声明。

TI 反对并拒绝您可能提出的任何其他或不同的条款。

邮寄地址：Texas Instruments, Post Office Box 655303, Dallas, Texas 75265

Copyright © 2024，德州仪器 (TI) 公司