

LM2937 500-mA Low Dropout Regulator

1 Features

- Fully Specified for Operation Over -40°C to 125°C
- Output Current in Excess of 500 mA
- Output Trimmed for 5% Tolerance Under all Operating Conditions
- Typical Dropout Voltage of 0.5 V at Full Rated Load Current
- Wide Output Capacitor ESR Range, up to $3\ \Omega$
- Internal Short Circuit and Thermal Overload Protection
- Reverse Battery Protection
- 60-V Input Transient Protection
- Mirror Image Insertion Protection

2 Applications

- Automotive
- Industrial Control
- Point-of-Load regulation

3 Description

The LM2937 is a positive voltage regulator capable of supplying up to 500 mA of load current. The use of a PNP power transistor provides a low dropout voltage characteristic. With a load current of 500 mA the minimum input to output voltage differential required for the output to remain in regulation is typically 0.5 V (1-V ensured maximum over the full operating temperature range). Special circuitry has been incorporated to minimize the quiescent current to typically only 10 mA with a full 500-mA load current when the input to output voltage differential is greater than 3 V.

The LM2937 requires an output bypass capacitor for stability. As with most low dropout regulators, the ESR of this capacitor remains a critical design parameter, but the LM2937 includes special compensation circuitry that relaxes ESR requirements. The device is stable for all ESR below $3\ \Omega$. This allows the use of low ESR chip capacitors.

Ideally suited for automotive applications, the LM2937 will protect itself and any load circuitry from reverse battery connections, two-battery jumps, and up to 60-V/-50-V load dump transients. Familiar regulator features such as short circuit and thermal shutdown protection are also built in.

Simplified Schematic

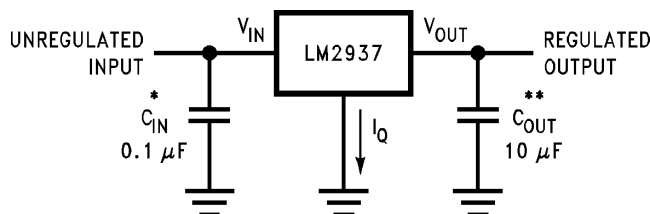

Device Information⁽¹⁾

PART NUMBER	PACKAGE	BODY SIZE (NOM)
LM2937	TO-220 (3)	14.986 mm x 10.66 mm
	SOT (4)	6.50 mm x 3.5 mm
	TO-263 (3)	10.18 mm x 8.41 mm

(1) For all available packages, see the orderable addendum at the end of the datasheet.



Table of Contents

1 Features 1 2 Applications 1 3 Description 1 4 Revision History 2 5 Pin Configuration and Functions 3 6 Specifications 4 6.1 Absolute Maximum Ratings 4 6.2 Handling Ratings 4 6.3 Recommended Operating Conditions 4 6.4 Thermal Information 4 6.5 Electrical Characteristics: LM2937-5 5 6.6 Electrical Characteristics: LM2937-8 5 6.7 Electrical Characteristics: LM2937-10 5 6.8 Electrical Characteristics: LM2937-12 7 6.9 Electrical Characteristics: LM2937-15 7 6.10 Typical Characteristics 8 7 Detailed Description 11	7.1 Overview 11 7.2 Functional Block Diagram 11 7.3 Feature Description 11 7.4 Device Functional Modes 12 8 Application and Implementation 13 8.1 Application Information 13 8.2 Typical Application 13 9 Power Supply Recommendations 17 10 Layout 18 10.1 Layout Guidelines 18 10.2 Layout Example 18 11 Device and Documentation Support 19 11.1 Trademarks 19 11.2 Electrostatic Discharge Caution 19 11.3 Glossary 19 12 Mechanical, Packaging, and Orderable Information 19
--	---

4 Revision History

NOTE: Page numbers for previous revisions may differ from page numbers in the current version.

Changes from Revision E (June 2013) to Revision F	Page
<ul style="list-style-type: none"> • Changed format to meet new TI standards; added Device Information and Handling Ratings tables; updated connection drawings; rename Functional Description and Applications sections, reformat and add new information, add Devices and Documentation section 1 	1

5 Pin Configuration and Functions

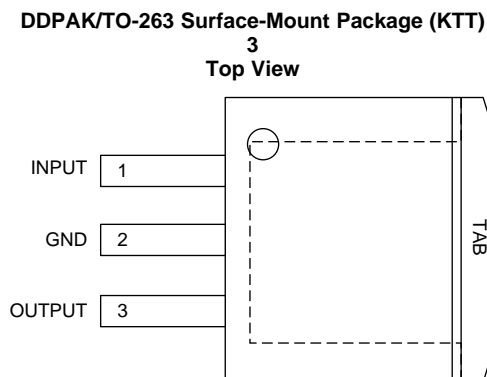
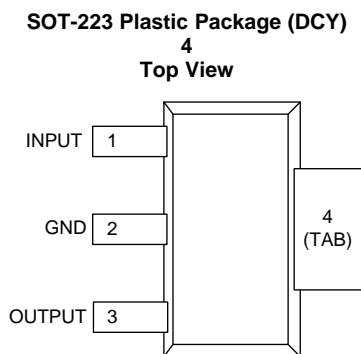
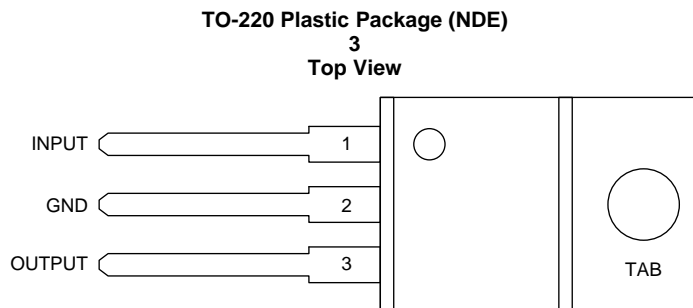

Pin Functions

NAME	PIN			I/O	DESCRIPTION
	NDE	KTT	DCY		
INPUT	1	1	1	I	Unregulated voltage input
GND	2	2	2	—	Ground
OUTPUT	3	3	3	O	Regulated voltage output. This pin requires an output capacitor to maintain stability. See the Detailed Design Procedure section for output capacitor details.
GND	TAB	TAB	4	—	Thermal and ground connection. Connect the TAB to a large copper area to remove heat from the device. The TAB is internally connected to device pin 2 (GND). Connect the TAB to GND or leave floating. Do not connect the TAB to any potential other than GND at device pin 2.

6 Specifications

6.1 Absolute Maximum Ratings⁽¹⁾⁽²⁾

over operating free-air temperature range (unless otherwise noted)

		MIN	MAX	UNIT
Input voltage (V_{IN})	Continuous		26	V
	Transient ($t \leq 100$ ms)		60	
Internal power dissipation ⁽³⁾		Internally limited		
Maximum junction temperature			150	°C

- (1) Stresses beyond those listed under *Absolute Maximum Ratings* may cause permanent damage to the device. These are stress ratings only, which do not imply functional operation of the device at these or any other conditions beyond those indicated under *Recommended Operating Conditions*. Exposure to absolute-maximum-rated conditions for extended periods may affect device reliability.
- (2) If Military/Aerospace specified devices are required, please contact the Texas Instruments Sales Office/Distributors for availability and specifications.
- (3) The maximum allowable power dissipation at any ambient temperature is $P_{MAX} = (125^\circ\text{C} - T_A)/R_{\theta JA}$, where 125 is the maximum junction temperature for operation, T_A is the ambient temperature, and $R_{\theta JA}$ is the junction-to-ambient thermal resistance. If this dissipation is exceeded, the die temperature will rise above 125°C and the electrical specifications do not apply. If the die temperature rises above 150°C, the LM2937 will go into thermal shutdown.

6.2 Handling Ratings

			MIN	MAX	UNIT
T_{stg}	Storage temperature range		-65	150	°C
$V_{(ESD)}$	Electrostatic discharge	Human body model (HBM), per ANSI/ESDA/JEDEC JS-001, all pins ⁽¹⁾	-2000	2000	V

- (1) JEDEC document JEP155 states that 500-V HBM allows safe manufacturing with a standard ESD control process.

6.3 Recommended Operating Conditions⁽¹⁾

over operating free-air temperature range (unless otherwise noted)

		MIN	NOM	MAX	UNIT
Junction temperature (T_J) ⁽²⁾	LM2937ET (NDE), LM2937ES (KTT)	-40		125	°C
	LM2937IMP (DCY)	-40		85	
Input voltage (V_{IN})		$V_{OUT} + 1V$		26	V

- (1) Stresses beyond those listed under *Absolute Maximum Ratings* may cause permanent damage to the device. These are stress ratings only, which do not imply functional operation of the device at these or any other conditions beyond those indicated under *Recommended Operating Conditions*. Exposure to absolute-maximum-rated conditions for extended periods may affect device reliability.
- (2) The maximum allowable power dissipation at any ambient temperature is $P_{MAX} = (125^\circ\text{C} - T_A)/R_{\theta JA}$, where 125°C is the maximum junction temperature for operation, T_A is the ambient temperature, and $R_{\theta JA}$ is the junction-to-ambient thermal resistance. If this dissipation is exceeded, the die temperature will rise above 125°C and the electrical specifications do not apply. If the die temperature rises above 150°C, the LM2937 will go into thermal shutdown.

6.4 Thermal Information

THERMAL METRIC ⁽¹⁾		LM2937			UNIT
		NDE ⁽²⁾	KTT	DCY	
		3 PINS	3 PINS	4 PINS	
$R_{\theta JA}$	Junction-to-ambient thermal resistance	77.9	41.8	58.3	°C/W
$R_{\theta JC(top)}$	Junction-to-case (top) thermal resistance	35.5	43.5	39.2	
$R_{\theta JB}$	Junction-to-board thermal resistance	70.6	0.8	N/A	
Ψ_{JT}	Junction-to-top characterization parameter	13	23.5	7	
Ψ_{JB}	Junction-to-board characterization parameter	70.6	10.3	1.6	
$R_{\theta JC(bot)}$	Junction-to-case (bottom) thermal resistance	1	22.5	22.5	

- (1) For more information about traditional and new thermal metrics, see the *IC Package Thermal Metrics* application report, [SPRA953](#).
- (2) Thermal information for the TO-220 package is for a free-standing package vertically mounted in the middle of a PCB which is compliant to the JEDEC HIGH-K 2s2p (JESD51-7) specifications. No additional heat sink is attached. See [Heatsinking TO-220 Package Parts](#) section for more information.

6.5 Electrical Characteristics: LM2937-5

Unless otherwise specified: $V_{IN} = V_{OUT(NOM)} + 5\text{ V}$; $I_{OUT(MAX)} = 500\text{ mA}$ for the TO-220 and DDPAK/TO-263 packages; $I_{OUT(MAX)} = 400\text{ mA}$ for the SOT-223 package; and $C_{OUT} = 10\text{ }\mu\text{F}$. Conditions and the associated minimum and maximum limits apply over the Recommended Operating temperature range for the specific package, unless otherwise noted.

PARAMETER	CONDITIONS	MIN	TYP	MAX	UNIT
Output voltage	$T_A = T_J = 25^\circ\text{C}$, $5\text{ mA} \leq I_{OUT} \leq I_{OUT(MAX)}$	4.85	5	5.15	V
	$5\text{ mA} \leq I_{OUT} \leq I_{OUT(MAX)}$	4.75	5	5.25	V
Line regulation	$(V_{OUT} + 2\text{ V}) \leq V_{IN} \leq 26\text{ V}$, $I_{OUT} = 5\text{ mA}$		15	50	mV
Load regulation	$5\text{ mA} \leq I_{OUT} \leq I_{OUT(MAX)}$		5	50	mV
Quiescent Current	$(V_{OUT} + 2\text{ V}) \leq V_{IN} \leq 26\text{ V}$, $I_{OUT} = 5\text{ mA}$		2	10	mA
	$V_{IN} = (V_{OUT} + 5\text{ V})$, $I_{OUT} = I_{OUT(MAX)}$		10	20	mA
Output noise voltage	10 Hz to 100 kHz, $I_{OUT} = 5\text{ mA}$		150		μVrms
Long-term stability	1000 Hrs.		20		mV
Dropout voltage	$I_{OUT} = I_{OUT(MAX)}$		0.5	1	V
	$I_{OUT} = 50\text{ mA}$		110	250	mV
Short-circuit current		0.6	1		A
Peak line transient voltage	$t_f < 100\text{ ms}$, $R_L = 100\text{ }\Omega$	60	75		V
Maximum operational input voltage		26			V
Reverse DC input voltage	$V_{OUT} \geq -0.6\text{ V}$, $R_L = 100\text{ }\Omega$	-15	-30		V
Reverse transient input voltage	$t_r < 1\text{ ms}$, $R_L = 100\text{ }\Omega$	-50	-75		V

6.6 Electrical Characteristics: LM2937-8

Unless otherwise specified: $V_{IN} = V_{OUT(NOM)} + 5\text{ V}$; $I_{OUT(MAX)} = 500\text{ mA}$ for the TO-220 and DDPAK/TO-263 packages; $I_{OUT(MAX)} = 400\text{ mA}$ for the SOT-223 package; and $C_{OUT} = 10\text{ }\mu\text{F}$. Conditions and the associated Minimum and Maximum limits apply over the Recommended Operating temperature range for the specific package, unless otherwise noted.

PARAMETER	CONDITIONS	MIN	TYP	MAX	UNIT
Output voltage	$T_A = T_J = 25^\circ\text{C}$, $5\text{ mA} \leq I_{OUT} \leq I_{OUT(MAX)}$	7.76	8	8.24	V
	$5\text{ mA} \leq I_{OUT} \leq I_{OUT(MAX)}$	7.6	8	8.4	V
Line regulation	$(V_{OUT} + 2\text{ V}) \leq V_{IN} \leq 26\text{ V}$, $I_{OUT} = 5\text{ mA}$		24	80	mV
Load regulation	$5\text{ mA} \leq I_{OUT} \leq I_{OUT(MAX)}$		8	80	mV
Quiescent Current	$(V_{OUT} + 2\text{ V}) \leq V_{IN} \leq 26\text{ V}$, $I_{OUT} = 5\text{ mA}$		2	10	mA
	$V_{IN} = (V_{OUT} + 5\text{ V})$, $I_{OUT} = I_{OUT(MAX)}$		10	20	mA
Output noise voltage	10 Hz to 100 kHz, $I_{OUT} = 5\text{ mA}$		240		μVrms
Long-term stability	1000 Hrs.		32		mV
Dropout voltage	$I_{OUT} = I_{OUT(MAX)}$		0.5	1	V
	$I_{OUT} = 50\text{ mA}$		110	250	mV
Short-circuit current		0.6	1		A
Peak line transient voltage	$t_f < 100\text{ ms}$, $R_L = 100\text{ }\Omega$	60	75		V
Maximum operational input voltage		26			V
Reverse DC input voltage	$V_{OUT} \geq -0.6\text{ V}$, $R_L = 100\text{ }\Omega$	-15	-30		V
Reverse transient input voltage	$t_r < 1\text{ ms}$, $R_L = 100\text{ }\Omega$	-50	-75		V

6.7 Electrical Characteristics: LM2937-10

Unless otherwise specified: $V_{IN} = V_{OUT(NOM)} + 5\text{ V}$; $I_{OUT(MAX)} = 500\text{ mA}$ for the TO-220 and DDPAK/TO-263 packages; $I_{OUT(MAX)} = 400\text{ mA}$ for the SOT-223 package; and $C_{OUT} = 10\text{ }\mu\text{F}$. Conditions and the associated Minimum and Maximum limits apply over the Recommended Operating temperature range for the specific package, unless otherwise noted.

PARAMETER	CONDITIONS	MIN	TYP	MAX	UNIT
Output voltage	$T_A = T_J = 25^\circ\text{C}$, $5\text{ mA} \leq I_{OUT} \leq I_{OUT(MAX)}$	9.7	10	10.3	V
	$5\text{ mA} \leq I_{OUT} \leq I_{OUT(MAX)}$	9.5	10	10.5	V
Line regulation	$(V_{OUT} + 2\text{ V}) \leq V_{IN} \leq 26\text{ V}$, $I_{OUT} = 5\text{ mA}$		30	100	mV

Electrical Characteristics: LM2937-10 (continued)

Unless otherwise specified: $V_{IN} = V_{OUT(NOM)} + 5\text{ V}$; $I_{OUT(MAX)} = 500\text{ mA}$ for the TO-220 and DDPACK/TO-263 packages; $I_{OUT(MAX)} = 400\text{ mA}$ for the SOT-223 package; and $C_{OUT} = 10\text{ }\mu\text{F}$. Conditions and the associated Minimum and Maximum limits apply over the Recommended Operating temperature range for the specific package, unless otherwise noted.

PARAMETER	CONDITIONS	MIN	TYP	MAX	UNIT
Load regulation	$5\text{ mA} \leq I_{OUT} \leq I_{OUT(MAX)}$		10	100	mV
Quiescent Current	$(V_{OUT} + 2\text{V}) \leq V_{IN} \leq 26\text{V}$, $I_{OUT} = 5\text{ mA}$		2	10	mA
	$V_{IN} = (V_{OUT} + 5\text{V})$, $I_{OUT} = I_{OUT(MAX)}$		10	20	mA
Output noise voltage	10 Hz to 100 kHz, $I_{OUT} = 5\text{ mA}$		300		μVrms
Long-term stability	1000 Hrs.		40		mV
Dropout voltage	$I_{OUT} = I_{OUT(MAX)}$		0.5	1	V
	$I_{OUT} = 50\text{ mA}$		110	250	mV
Short-circuit current		0.6	1		A
Peak line transient voltage	$t_f < 100\text{ ms}$, $R_L = 100\text{ }\Omega$	60	75		V
Maximum operational input voltage		26			V
Reverse DC input voltage	$V_{OUT} \geq -0.6\text{ V}$, $R_L = 100\text{ }\Omega$	-15	-30		V
Reverse transient input voltage	$t_r < 1\text{ ms}$, $R_L = 100\text{ }\Omega$	-50	-75		V

6.8 Electrical Characteristics: LM2937-12

Unless otherwise specified: $V_{IN} = V_{OUT(NOM)} + 5\text{ V}$; $I_{OUT(MAX)} = 500\text{ mA}$ for the TO-220 and DDPAK/TO-263 packages; $I_{OUT(MAX)} = 400\text{ mA}$ for the SOT-223 package; and $C_{OUT} = 10\text{ }\mu\text{F}$. Conditions and the associated Minimum and Maximum limits apply over the Recommended Operating temperature range for the specific package, unless otherwise noted.

PARAMETER	CONDITIONS	MIN	TYP	MAX	UNIT
Output voltage	$T_A = T_J = 25^\circ\text{C}$, $5\text{ mA} \leq I_{OUT} \leq I_{OUT(MAX)}$	11.64	12	12.36	V
	$5\text{ mA} \leq I_{OUT} \leq I_{OUT(MAX)}$	11.4	12	12.6	V
Line regulation	$(V_{OUT} + 2\text{V}) \leq V_{IN} \leq 26\text{V}$, $I_{OUT} = 5\text{ mA}$		36	120	mV
Load regulation	$5\text{ mA} \leq I_{OUT} \leq I_{OUT(MAX)}$		12	120	mV
Quiescent Current	$(V_{OUT} + 2\text{V}) \leq V_{IN} \leq 26\text{V}$, $I_{OUT} = 5\text{ mA}$		2	10	mA
	$V_{IN} = (V_{OUT} + 5\text{V})$, $I_{OUT} = I_{OUT(MAX)}$		10	20	mA
Output noise voltage	10 Hz to 100 kHz, $I_{OUT} = 5\text{ mA}$		360		μVrms
Long-term stability	1000 Hrs.		44		mV
Dropout voltage	$I_{OUT} = I_{OUT(MAX)}$		0.5	1	V
	$I_{OUT} = 50\text{ mA}$		110	250	mV
Short-circuit current		0.6	1		A
Peak line transient voltage	$t_f < 100\text{ ms}$, $R_L = 100\text{ }\Omega$	60	75		V
Maximum operational input voltage		26			V
Reverse DC input voltage	$V_{OUT} \geq -0.6\text{ V}$, $R_L = 100\text{ }\Omega$	-15	-30		V
Reverse transient input voltage	$t_r < 1\text{ ms}$, $R_L = 100\text{ }\Omega$	-50	-75		V

6.9 Electrical Characteristics: LM2937-15

Unless otherwise specified: $V_{IN} = V_{OUT(NOM)} + 5\text{ V}$; $I_{OUT(MAX)} = 500\text{ mA}$ for the TO-220 and DDPAK/TO-263 packages; $I_{OUT(MAX)} = 400\text{ mA}$ for the SOT-223 package; and $C_{OUT} = 10\text{ }\mu\text{F}$. Conditions and the associated Minimum and Maximum limits apply over the Recommended Operating temperature range for the specific package, unless otherwise noted.

PARAMETER	CONDITIONS	MIN	TYP	MAX	UNIT
Output voltage	$T_A = T_J = 25^\circ\text{C}$, $5\text{ mA} \leq I_{OUT} \leq I_{OUT(MAX)}$	14.55	15	15.45	V
	$5\text{ mA} \leq I_{OUT} \leq I_{OUT(MAX)}$	14.25	15	15.75	V
Line regulation	$(V_{OUT} + 2\text{V}) \leq V_{IN} \leq 26\text{V}$, $I_{OUT} = 5\text{ mA}$		45	150	mV
Load regulation	$5\text{ mA} \leq I_{OUT} \leq I_{OUT(MAX)}$		15	150	mV
Quiescent Current	$(V_{OUT} + 2\text{V}) \leq V_{IN} \leq 26\text{V}$, $I_{OUT} = 5\text{ mA}$		2	10	mA
	$V_{IN} = (V_{OUT} + 5\text{V})$, $I_{OUT} = I_{OUT(MAX)}$		10	20	mA
Output noise voltage	10 Hz to 100 kHz, $I_{OUT} = 5\text{ mA}$		450		μVrms
Long-term stability	1000 Hrs.		56		mV
Dropout voltage	$I_{OUT} = I_{OUT(MAX)}$		0.5	1	V
	$I_{OUT} = 50\text{ mA}$		110	250	mV
Short-circuit current		0.6	1		A
Peak line transient voltage	$t_f < 100\text{ ms}$, $R_L = 100\text{ }\Omega$	60	75		V
Maximum operational input voltage		26			V
Reverse DC input voltage	$V_{OUT} \geq -0.6\text{ V}$, $R_L = 100\text{ }\Omega$	-15	-30		V
Reverse transient input voltage	$t_r < 1\text{ ms}$, $R_L = 100\text{ }\Omega$	-50	-75		V

6.10 Typical Characteristics

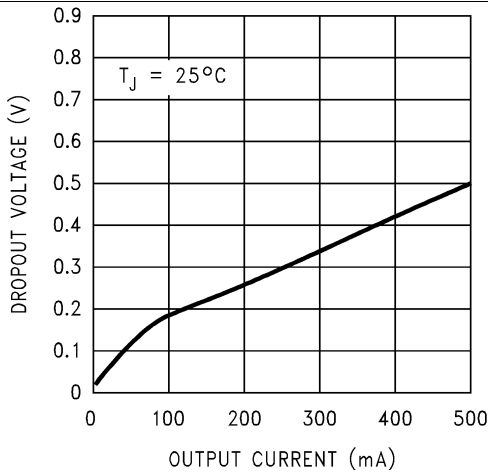

Figure 1. Dropout Voltage vs. Output Current

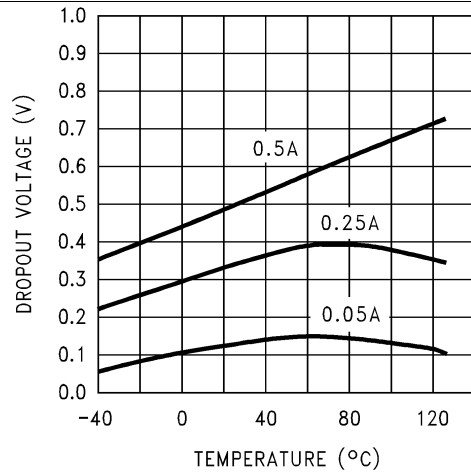

Figure 2. Dropout Voltage vs. Temperature

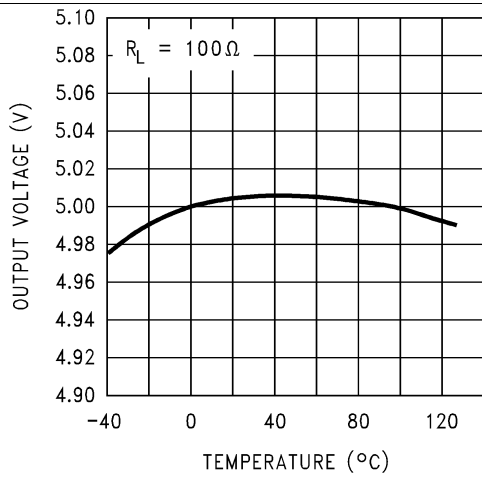

Figure 3. Output Voltage vs. Temperature

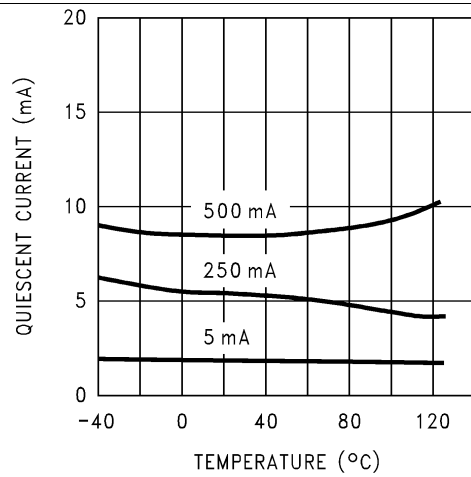

Figure 4. Quiescent Current vs. Temperature

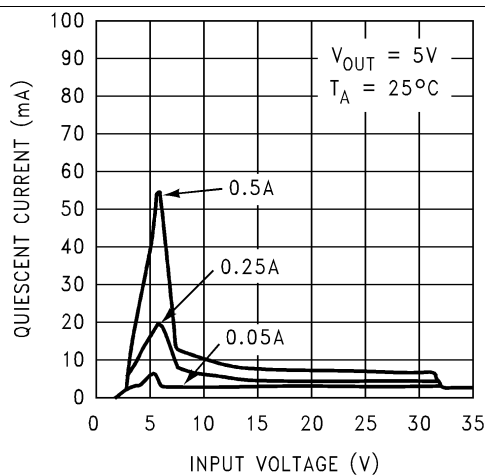

Figure 5. Quiescent Current vs. Input Voltage

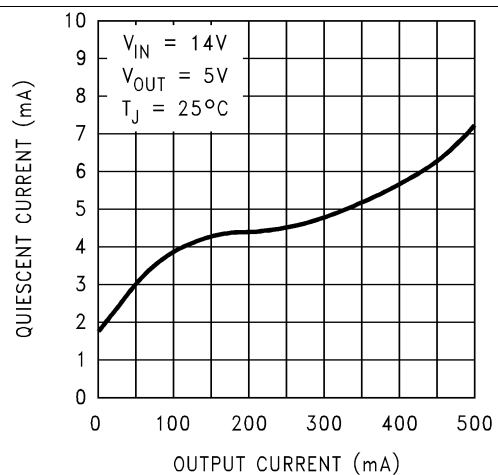

Figure 6. Quiescent Current vs. Output Current

Typical Characteristics (continued)

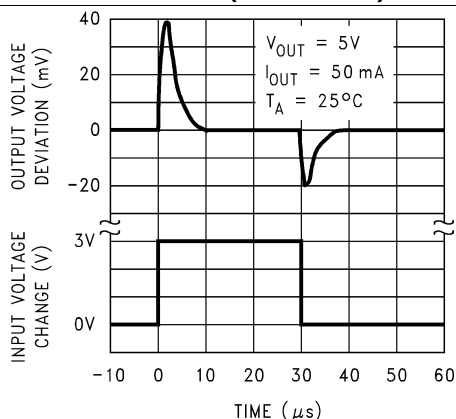

Figure 7. Line Transient Response

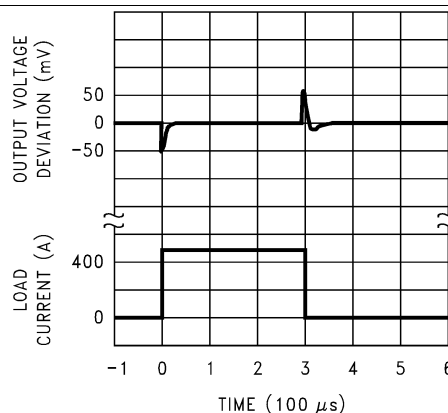

Figure 8. Load Transient Response

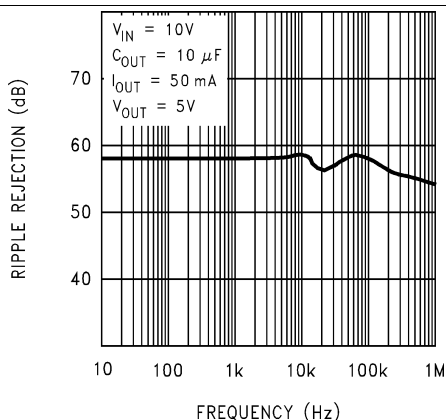

Figure 9. Ripple Rejection

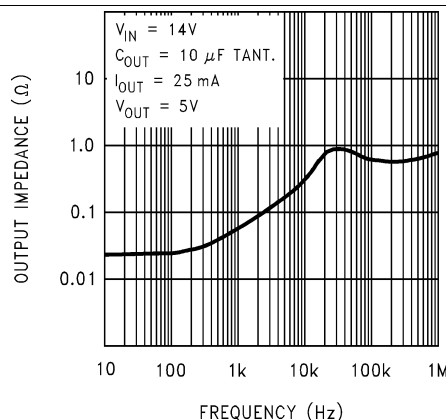

Figure 10. Output Impedance

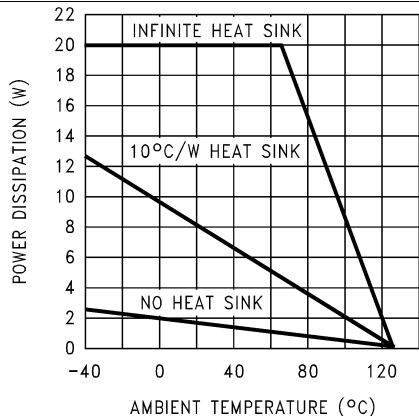

Figure 11. Maximum Power Dissipation (TO-220)¹

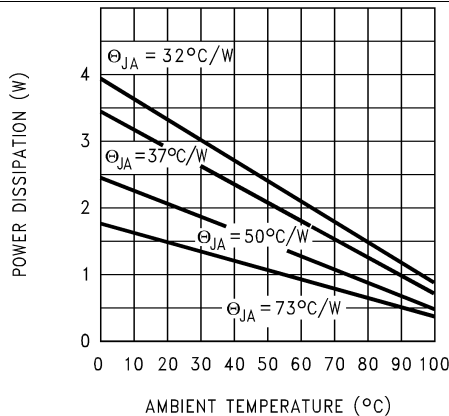

Figure 12. Maximum Power Dissipation (DDPAK/TO-263)

1. The maximum allowable power dissipation at any ambient temperature is $P_{MAX} = (125^{\circ}\text{C} - T_A)/R_{\theta JA}$, where 125 is the maximum junction temperature for operation, T_A is the ambient temperature, and $R_{\theta JA}$ is the junction-to-ambient thermal resistance. If this dissipation is exceeded, the die temperature will rise above 125°C and the electrical specifications do not apply. If the die temperature rises above 150°C , the LM2937 will go into thermal shutdown.

Typical Characteristics (continued)

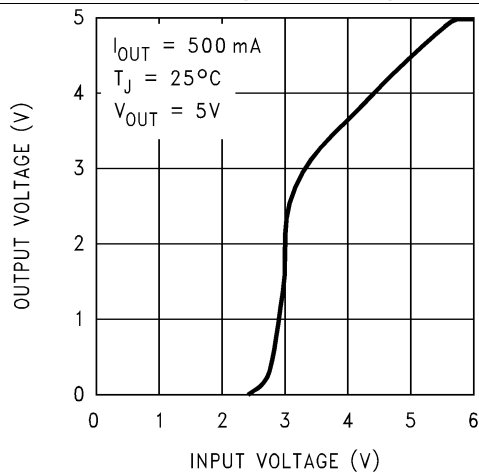

Figure 13. Low-Voltage Behavior

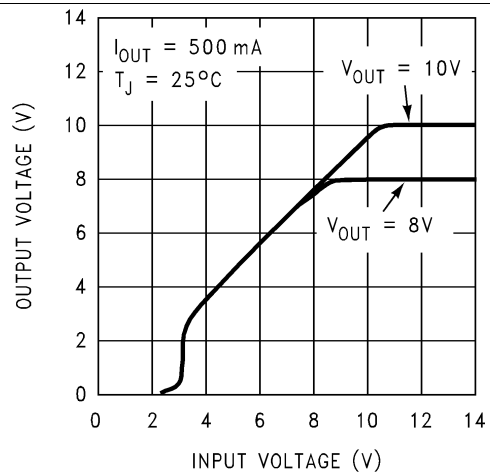

Figure 14. Low-Voltage Behavior

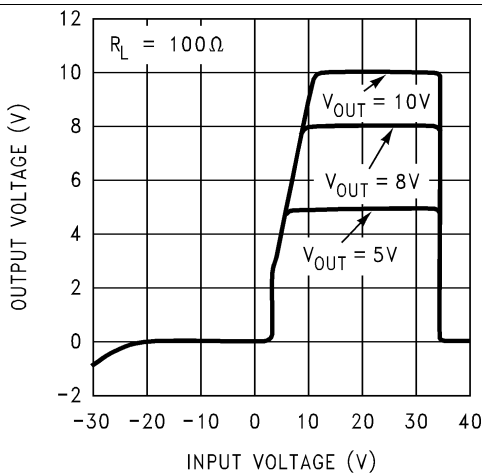

Figure 15. Output at Voltage Extremes

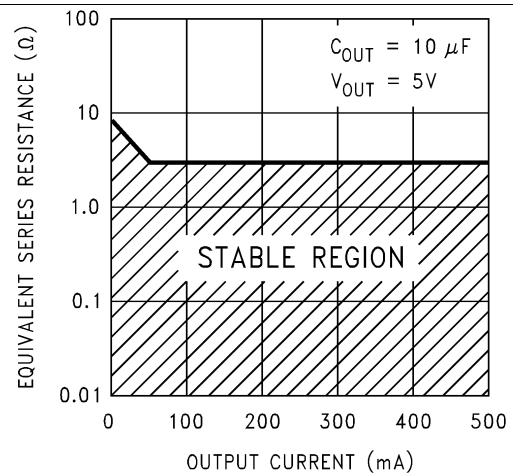

Figure 16. Output Capacitor ESR

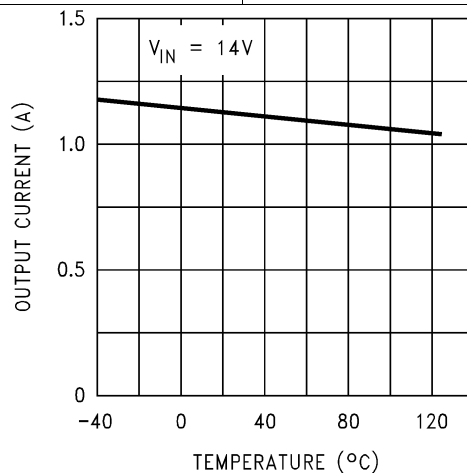

Figure 17. Peak Output Current

7 Detailed Description

7.1 Overview

The LM2937 is a positive voltage regulator capable of supplying up to 500 mA of load current. The use of a PNP power transistor provides a low dropout voltage characteristic. With a load current of 500 mA the minimum input to output voltage differential required for the output to remain in regulation is typically 0.5 V (1 V ensured maximum over the full operating temperature range). Special circuitry has been incorporated to minimize the quiescent current to typically only 10 mA with a full 500-mA load current when the input to output voltage differential is greater than 3 V.

7.2 Functional Block Diagram

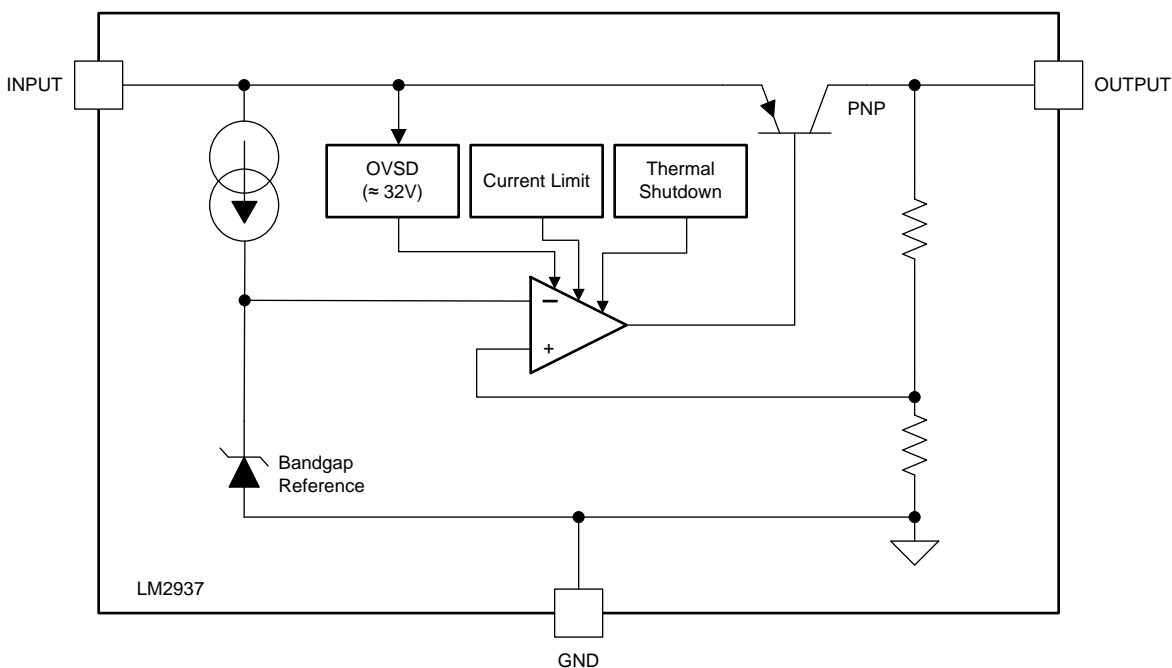

7.3 Feature Description

7.3.1 Thermal Shutdown (TSD)

The Thermal Shutdown circuitry of the LM2937 has been designed to protect the device against temporary thermal overload conditions. The TSD circuitry is not intended to replace proper heat-sinking. Continuously running the LM2937 device at thermal shutdown may degrade device reliability as the junction temperature will be exceeding the absolute maximum junction temperature rating.

7.3.2 Short Circuit Current Limit

The output current limiting circuitry of the LM2937 has been designed to limit the output current in cases where the load impedance is unusually low. This includes situations where the output may be shorted directly to ground. Continuous operation of the LM2937 at the current limit will typically result in the LM2937 transitioning into Thermal Shutdown mode.

7.3.3 Overvoltage Shutdown (OVSD)

Input voltages greater than typically 32 V will cause the LM2937 output to be disabled. When operating with the input voltage greater than the maximum recommended input voltage of 26 V the device performance is not ensured. Continuous operation with the input voltage greater than the maximum recommended input voltage is discouraged.

7.4 Device Functional Modes

The LM2937 design does not include any undervoltage lock-out (UVLO), or enable functions. Generally, the output voltage will track the input voltage until the input voltage is greater than $V_{OUT} + 1V$. When the input voltage is greater than $V_{OUT} + 1V$ the LM2937 will be in linear operation, and the output voltage will be regulated; however, the device will be sensitive to any small perturbation of the input voltage. Device dynamic performance is improved when the input voltage is at least 2 V greater than the output voltage.

8 Application and Implementation

8.1 Application Information

Figure 18 shows the typical application circuit for the LM2937. The output capacitor, C_{OUT} , must have a capacitance value of at least $10\ \mu\text{F}$ with an ESR of at least $10\ \text{m}\Omega$, but no more than $3\ \Omega$. The minimum capacitance value, and the ESR requirements apply across the entire expected operating ambient temperature range.

8.2 Typical Application

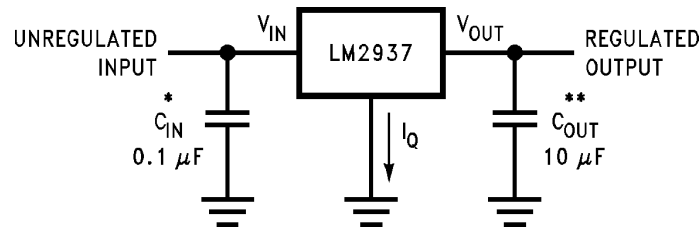

Figure 18. LM2937 Typical Application

*Required if the regulator is located more than 3 inches from the power-supply-filter capacitors.

**Required for stability. C_{OUT} must be at least $10\ \mu\text{F}$ (over full expected operating temperature range) and located as close as possible to the regulator. The equivalent series resistance, ESR, of this capacitor may be as high as $3\ \Omega$.

8.2.1 Design Requirements

For this design example, use the parameters listed in Table 1:

Table 1. Design Parameters

DESIGN PARAMETER	EXAMPLE VALUE
Output voltage	8 V
Input voltage	10 V to 26 V
Output current requirement	5 mA to $I_{OUT(MAX)}$ (see Electrical Characteristics: LM2937-5 , Electrical Characteristics: LM2937-8 , Electrical Characteristics: LM2937-10 , Electrical Characteristics: LM2937-12 , Electrical Characteristics: LM2937-15 for details)
Input capacitor value	$0.1\ \mu\text{F}$
Output capacitor capacitance value	$10\ \mu\text{F}$ minimum
Output capacitor ESR value	$0.01\ \Omega$ to $3\ \Omega$

8.2.2 Detailed Design Procedure

8.2.2.1 External Capacitors

The output capacitor is critical to maintaining regulator stability, and must meet the required conditions for both Equivalent Series Resistance (ESR) and minimum amount of capacitance.

Minimum Capacitance:

The minimum output capacitance required to maintain stability is $10\ \mu\text{F}$. (This value may be increased without limit.) Larger values of output capacitance will give improved transient response.

ESR Limits:

The ESR of the output capacitor will cause loop instability if it is too high or too low. The acceptable range of ESR plotted versus load current is shown in the graph below. **It is essential that the output capacitor meet these requirements, or oscillations can result.**

8.2.2.2 Output Capacitor ESR

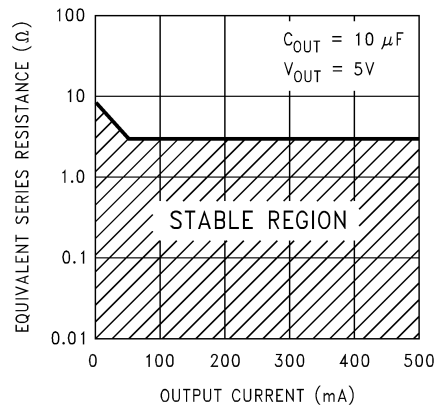

Figure 19. ESR Limits

It is important to note that for most capacitors, ESR is specified only at room temperature. However, the designer must ensure that the ESR will stay inside the limits shown over the entire operating temperature range for the design.

For aluminum electrolytic capacitors, ESR will increase by about 30X as the temperature is reduced from 25°C to -40°C. This type of capacitor is not well-suited for low temperature operation.

Solid tantalum capacitors have a more stable ESR over temperature, but are more expensive than aluminum electrolytics. A cost-effective approach sometimes used is to parallel an aluminum electrolytic with a solid Tantalum, with the total capacitance split about 75/25% with the Aluminum being the larger value.

If two capacitors are paralleled, the effective ESR is the parallel of the two individual values. The “flatter” ESR of the Tantalum will keep the effective ESR from rising as quickly at low temperatures.

8.2.2.3 Heatsinking

A heatsink may be required depending on the maximum power dissipation and maximum ambient temperature of the application. Under all possible operating conditions, the junction temperature must be within the range specified under [Absolute Maximum Ratings](#).

To determine if a heatsink is required, the power dissipated by the regulator, P_D , must be calculated.

Figure 20 below shows the voltages and currents which are present in the circuit, as well as the formula for calculating the power dissipated in the regulator:

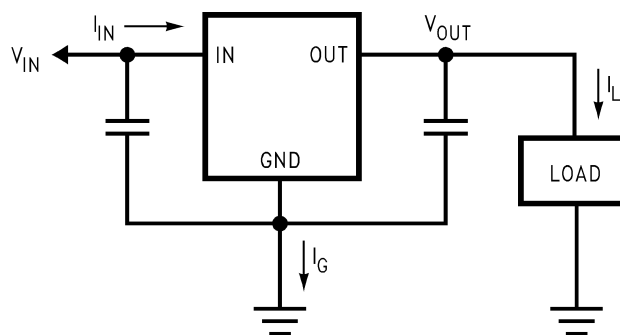

$$I_{IN} = I_L + I_G$$

$$P_D = (V_{IN} - V_{OUT}) I_L + (V_{IN}) I_G$$

Figure 20. Power Dissipation Diagram

The next parameter which must be calculated is the maximum allowable temperature rise, T_R (max). This is calculated by using the formula:

$$T_R \text{ (max)} = T_J \text{ (max)} - T_A \text{ (max)}$$

where

- T_J (max) is the maximum allowable junction temperature, which is 125°C for the TO-220 and TO-263 packages, and 85°C for the SOT-223 package.
- T_A (max) is the maximum ambient temperature which will be encountered in the application. (1)

Using the calculated values for T_R (max) and P_D , the maximum allowable value for the junction-to-ambient thermal resistance, $R_{\theta JA}$, can now be found:

$$R_{\theta JA} = T_R (\text{max})/P_D \quad (2)$$

NOTE

IMPORTANT: If the maximum allowable value for $R_{\theta JA}$ is found to be $\geq 53^\circ\text{C/W}$ for the TO-220 package, $\geq 80^\circ\text{C/W}$ for the DDPAK/TO-263 package, or $\geq 174^\circ\text{C/W}$ for the SOT-223 package, no heatsink is needed since the package alone will dissipate enough heat to satisfy these requirements.

If the calculated value for $R_{\theta JA}$ falls below these limits, a heatsink is required.

8.2.2.4 Heatsinking TO-220 Package Parts

The TO-220 can be attached to a typical heatsink, or secured to a copper plane on a PC board. If a copper plane is to be used, the values of $R_{\theta JA}$ will be the same as shown in the next section for the DDPAK/TO-263.

If a manufactured heatsink is to be selected, the value of heatsink-to-ambient thermal resistance, $R_{\theta HA}$, must first be calculated:

$$R_{\theta HA} = R_{\theta JA} - R_{\theta CH} - R_{\theta JC}$$

where

- $R_{\theta JC}$ is defined as the thermal resistance from the junction to the surface of the case. A value of 3°C/W can be assumed for $R_{\theta JC}$ for this calculation
- $R_{\theta CH}$ is defined as the thermal resistance between the case and the surface of the heatsink. The value of $R_{\theta CH}$ will vary from about 1.5°C/W to about 2.5°C/W (depending on method of attachment, insulator, etc.). If the exact value is unknown, 2°C/W should be assumed for $R_{\theta CH}$ (3)

When a value for $R_{\theta HA}$ is found using the equation shown, *a heatsink must be selected that has a value that is less than or equal to this number.*

$R_{\theta HA}$ is specified numerically by the heatsink manufacturer in the catalog, or shown in a curve that plots temperature rise vs power dissipation for the heatsink.

8.2.2.5 Heatsinking DDPAK/TO-263 and SOT-223 Package Parts

Both the DDPAK/TO-263 and SOT-223 packages use a copper plane on the PCB and the PCB itself as a heatsink. To optimize the heat sinking ability of the plane and PCB, solder the tab of the package to the plane.

Figure 21 shows for the DDPAK/TO-263 the measured values of $R_{\theta JA}$ for different copper area sizes using a typical PCB with 1 ounce copper *and no solder mask over the copper area used for heatsinking.*

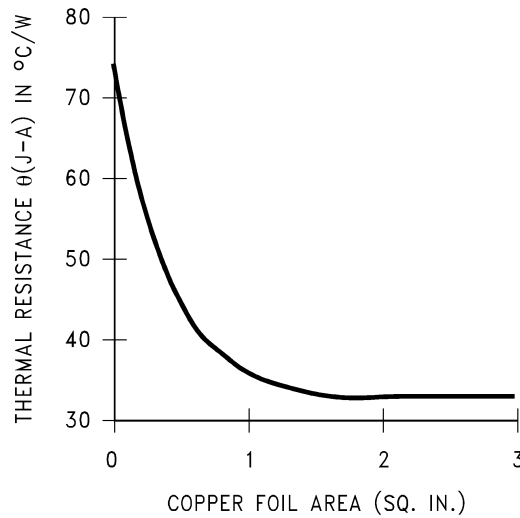

Figure 21. $R_{\theta JA}$ vs. Copper (1 ounce) Area for the DDPAK/TO-263 Package

As shown in Figure 21, increasing the copper area beyond 1 square inch produces very little improvement. It should also be observed that the minimum value of $R_{\theta JA}$ for the DDPAK/TO-263 package mounted to a PCB is 32°C/W.

As a design aid, Figure 22 shows the maximum allowable power dissipation compared to ambient temperature for the DDPAK/TO-263 device (assuming $R_{\theta JA}$ is 35°C/W and the maximum junction temperature is 125°C).

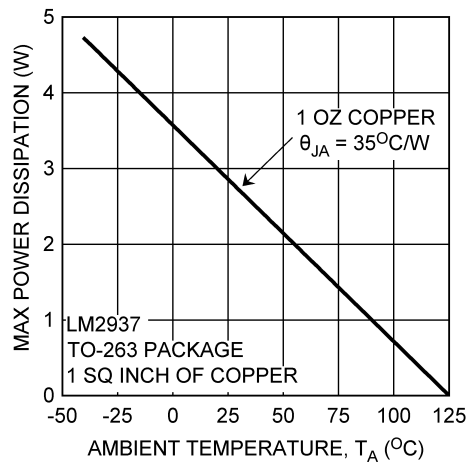

Figure 22. Maximum Power Dissipation vs. T_{AMB} for the DDPAK/TO-263 Package

Figure 23 and Figure 24 show information for the SOT-223 package. Figure 24 assumes an $R_{\theta JA}$ of 74°C/W for 1 ounce copper and 51°C/W for 2 ounce copper and a maximum junction temperature of 85°C.

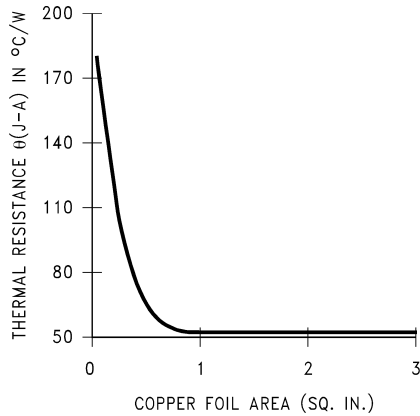

Figure 23. $R_{\theta JA}$ vs Copper (2 ounce) Area for the SOT-223 Package

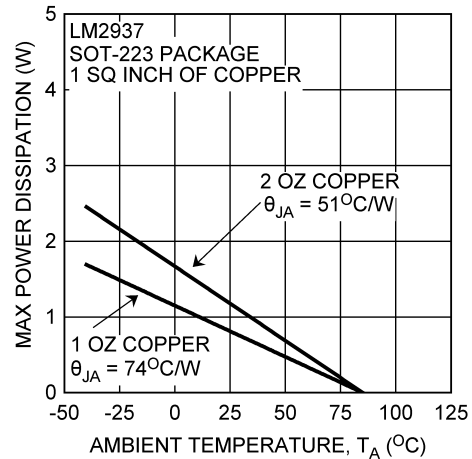

Figure 24. Maximum Power Dissipation vs T_{AMB} for the SOT-223 Package

8.2.2.6 SOT-223 Soldering Recommendations

It is not recommended to use hand soldering or wave soldering to attach the small SOT-223 package to a printed circuit board. The excessive temperatures involved may cause package cracking.

Either vapor phase or infrared reflow techniques are preferred soldering attachment methods for the SOT-223 package.

8.2.3 Application Curves

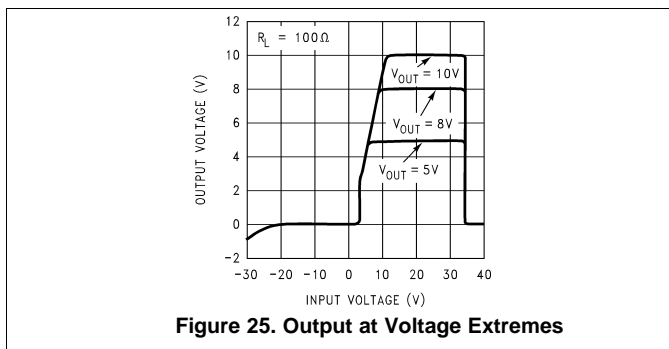

Figure 25. Output at Voltage Extremes

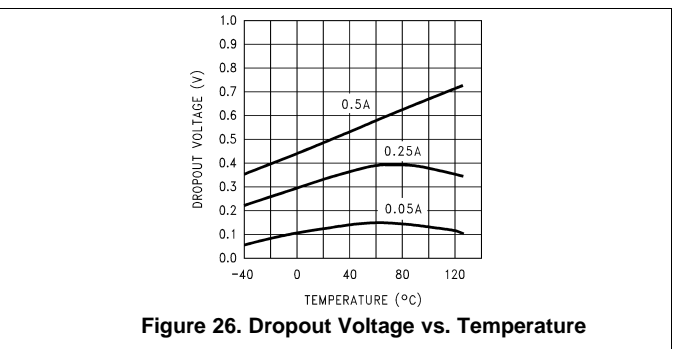

Figure 26. Dropout Voltage vs. Temperature

9 Power Supply Recommendations

This device is designed to operate from an input supply voltage from at least $V_{OUT} + 1$ V up to a maximum of 26 V. The input supply should be well regulated and free of spurious noise. To ensure that the LM2937 output voltage is well regulated the input supply should be at least $V_{OUT} + 2$ V. A capacitor at the INPUT pin may not be specifically required if the bulk input supply filter capacitors are within three inches of the INPUT pin, but adding one will not be detrimental to operation.

10 Layout

10.1 Layout Guidelines

The dynamic performance of the LM2937 is dependent on the layout of the PCB. PCB layout practices that are adequate for typical LDO's may degrade the PSRR, noise, or transient performance of the LM2937. Best performance is achieved by placing C_{IN} and C_{OUT} on the same side of the PCB as the LM2937, and as close as is practical to the package. The ground connections for C_{IN} and C_{OUT} should be back to the LM2937 ground pin using as wide, and as short, of a copper trace as is practical.

Connections using long trace lengths, narrow trace widths, and/or connections through vias should be avoided as these will add parasitic inductances and resistances that will give inferior performance, especially during transient conditions

10.2 Layout Example

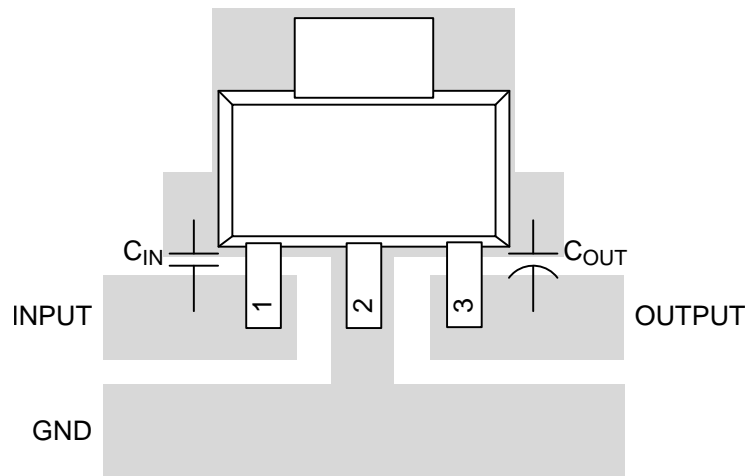

Figure 27. LM2937 SOT-223-4 Layout

11 Device and Documentation Support

11.1 Trademarks

All trademarks are the property of their respective owners.

11.2 Electrostatic Discharge Caution



These devices have limited built-in ESD protection. The leads should be shorted together or the device placed in conductive foam during storage or handling to prevent electrostatic damage to the MOS gates.

11.3 Glossary

[SLYZ022](#) — *TI Glossary*.

This glossary lists and explains terms, acronyms, and definitions.

12 Mechanical, Packaging, and Orderable Information

The following pages include mechanical, packaging, and orderable information. This information is the most current data available for the designated devices. This data is subject to change without notice and revision of this document. For browser-based versions of this data sheet, refer to the left-hand navigation.

PACKAGING INFORMATION

Orderable Device	Status (1)	Package Type	Package Drawing	Pins	Package Qty	Eco Plan (2)	Lead finish/ Ball material (6)	MSL Peak Temp (3)	Op Temp (°C)	Device Marking (4/5)	Samples
LM2937ES-10/NOPB	ACTIVE	DDPAK/ TO-263	KTT	3	45	RoHS-Exempt & Green	SN	Level-3-245C-168 HR	-40 to 125	LM2937ES -10	Samples
LM2937ES-12/NOPB	ACTIVE	DDPAK/ TO-263	KTT	3	45	RoHS-Exempt & Green	SN	Level-3-245C-168 HR	-40 to 125	LM2937ES -12	Samples
LM2937ES-15/NOPB	ACTIVE	DDPAK/ TO-263	KTT	3	45	RoHS-Exempt & Green	SN	Level-3-245C-168 HR	-40 to 125	LM2937ES -15	Samples
LM2937ES-2.5/NOPB	ACTIVE	DDPAK/ TO-263	KTT	3	45	RoHS-Exempt & Green	SN	Level-3-245C-168 HR	-40 to 125	LM2937ES -2.5	Samples
LM2937ES-3.3/NOPB	ACTIVE	DDPAK/ TO-263	KTT	3	45	RoHS-Exempt & Green	SN	Level-3-245C-168 HR	-40 to 125	LM2937ES -3.3	Samples
LM2937ES-5.0/NOPB	ACTIVE	DDPAK/ TO-263	KTT	3	45	RoHS-Exempt & Green	SN	Level-3-245C-168 HR	-40 to 125	LM2937ES -5.0	Samples
LM2937ES-8.0/NOPB	ACTIVE	DDPAK/ TO-263	KTT	3	45	RoHS-Exempt & Green	SN	Level-3-245C-168 HR	-40 to 125	LM2937ES -8.0	Samples
LM2937ESX-12/NOPB	ACTIVE	DDPAK/ TO-263	KTT	3	500	RoHS-Exempt & Green	SN	Level-3-245C-168 HR	-40 to 125	LM2937ES -12	Samples
LM2937ESX-15/NOPB	ACTIVE	DDPAK/ TO-263	KTT	3	500	RoHS-Exempt & Green	SN	Level-3-245C-168 HR	-40 to 125	LM2937ES -15	Samples
LM2937ESX-3.3/NOPB	ACTIVE	DDPAK/ TO-263	KTT	3	500	RoHS-Exempt & Green	SN	Level-3-245C-168 HR	-40 to 125	LM2937ES -3.3	Samples
LM2937ESX-5.0/NOPB	ACTIVE	DDPAK/ TO-263	KTT	3	500	RoHS-Exempt & Green	SN	Level-3-245C-168 HR	-40 to 125	LM2937ES -5.0	Samples
LM2937ESX-8.0/NOPB	ACTIVE	DDPAK/ TO-263	KTT	3	500	RoHS-Exempt & Green	SN	Level-3-245C-168 HR	-40 to 125	LM2937ES -8.0	Samples
LM2937ET-10/NOPB	ACTIVE	TO-220	NDE	3	45	RoHS & Green	SN	Level-1-NA-UNLIM	-40 to 125	LM2937ET -10	Samples
LM2937ET-12/NOPB	ACTIVE	TO-220	NDE	3	45	RoHS & Green	SN	Level-1-NA-UNLIM	-40 to 125	LM2937ET -12	Samples
LM2937ET-15/NOPB	ACTIVE	TO-220	NDE	3	45	RoHS & Green	SN	Level-1-NA-UNLIM	-40 to 125	LM2937ET -15	Samples
LM2937ET-2.5/NOPB	ACTIVE	TO-220	NDE	3	45	RoHS & Green	SN	Level-1-NA-UNLIM	-40 to 125	LM2937ET -2.5	Samples
LM2937ET-3.3/NOPB	ACTIVE	TO-220	NDE	3	45	RoHS & Green	SN	Level-1-NA-UNLIM	-40 to 125	LM2937ET	Samples

Orderable Device	Status (1)	Package Type	Package Drawing	Pins	Package Qty	Eco Plan (2)	Lead finish/ Ball material (6)	MSL Peak Temp (3)	Op Temp (°C)	Device Marking (4/5)	Samples
										-3.3	
LM2937ET-5.0/NOPB	ACTIVE	TO-220	NDE	3	45	RoHS-Exempt & Green	SN	Level-1-NA-UNLIM	-40 to 125	LM2937ET-5.0	Samples
LM2937ET-8.0/NOPB	ACTIVE	TO-220	NDE	3	45	RoHS & Green	SN	Level-1-NA-UNLIM	-40 to 125	LM2937ET-8.0	Samples
LM2937IMP-10/NOPB	ACTIVE	SOT-223	DCY	4	1000	RoHS & Green	SN	Level-1-260C-UNLIM	-40 to 85	L73B	Samples
LM2937IMP-12/NOPB	ACTIVE	SOT-223	DCY	4	1000	RoHS & Green	SN	Level-1-260C-UNLIM	-40 to 85	L74B	Samples
LM2937IMP-2.5/NOPB	ACTIVE	SOT-223	DCY	4	1000	RoHS & Green	SN	Level-1-260C-UNLIM	-40 to 85	L68B	Samples
LM2937IMP-3.3/NOPB	ACTIVE	SOT-223	DCY	4	1000	RoHS & Green	SN	Level-1-260C-UNLIM	-40 to 85	L69B	Samples
LM2937IMP-5.0/NOPB	ACTIVE	SOT-223	DCY	4	1000	RoHS & Green	SN	Level-1-260C-UNLIM	-40 to 85	L71B	Samples
LM2937IMP-8.0/NOPB	ACTIVE	SOT-223	DCY	4	1000	RoHS & Green	SN	Level-1-260C-UNLIM	-40 to 85	L72B	Samples
LM2937IMPX-10/NOPB	ACTIVE	SOT-223	DCY	4	2000	RoHS & Green	SN	Level-1-260C-UNLIM	-40 to 85	L73B	Samples
LM2937IMPX-12/NOPB	ACTIVE	SOT-223	DCY	4	2000	RoHS & Green	SN	Level-1-260C-UNLIM	-40 to 85	L74B	Samples
LM2937IMPX-15/NOPB	ACTIVE	SOT-223	DCY	4	2000	RoHS & Green	SN	Level-1-260C-UNLIM	-40 to 85	L75B	Samples
LM2937IMPX-2.5/NOPB	ACTIVE	SOT-223	DCY	4	2000	RoHS & Green	SN	Level-1-260C-UNLIM	-40 to 85	L68B	Samples
LM2937IMPX-3.3/NOPB	ACTIVE	SOT-223	DCY	4	2000	RoHS & Green	SN	Level-1-260C-UNLIM	-40 to 85	L69B	Samples
LM2937IMPX-5.0/NOPB	ACTIVE	SOT-223	DCY	4	2000	RoHS & Green	SN	Level-1-260C-UNLIM	-40 to 85	L71B	Samples
LM2937IMPX-8.0/NOPB	ACTIVE	SOT-223	DCY	4	2000	RoHS & Green	SN	Level-1-260C-UNLIM	-40 to 85	L72B	Samples

(1) The marketing status values are defined as follows:

ACTIVE: Product device recommended for new designs.

LIFEBUY: TI has announced that the device will be discontinued, and a lifetime-buy period is in effect.

NRND: Not recommended for new designs. Device is in production to support existing customers, but TI does not recommend using this part in a new design.

PREVIEW: Device has been announced but is not in production. Samples may or may not be available.

OBSOLETE: TI has discontinued the production of the device.

(2) **RoHS:** TI defines "RoHS" to mean semiconductor products that are compliant with the current EU RoHS requirements for all 10 RoHS substances, including the requirement that RoHS substance do not exceed 0.1% by weight in homogeneous materials. Where designed to be soldered at high temperatures, "RoHS" products are suitable for use in specified lead-free processes. TI may reference these types of products as "Pb-Free".

RoHS Exempt: TI defines "RoHS Exempt" to mean products that contain lead but are compliant with EU RoHS pursuant to a specific EU RoHS exemption.

Green: TI defines "Green" to mean the content of Chlorine (Cl) and Bromine (Br) based flame retardants meet JS709B low halogen requirements of ≤ 1000 ppm threshold. Antimony trioxide based flame retardants must also meet the ≤ 1000 ppm threshold requirement.

(3) MSL, Peak Temp. - The Moisture Sensitivity Level rating according to the JEDEC industry standard classifications, and peak solder temperature.

(4) There may be additional marking, which relates to the logo, the lot trace code information, or the environmental category on the device.

(5) Multiple Device Markings will be inside parentheses. Only one Device Marking contained in parentheses and separated by a "~" will appear on a device. If a line is indented then it is a continuation of the previous line and the two combined represent the entire Device Marking for that device.

(6) Lead finish/Ball material - Orderable Devices may have multiple material finish options. Finish options are separated by a vertical ruled line. Lead finish/Ball material values may wrap to two lines if the finish value exceeds the maximum column width.

Important Information and Disclaimer: The information provided on this page represents TI's knowledge and belief as of the date that it is provided. TI bases its knowledge and belief on information provided by third parties, and makes no representation or warranty as to the accuracy of such information. Efforts are underway to better integrate information from third parties. TI has taken and continues to take reasonable steps to provide representative and accurate information but may not have conducted destructive testing or chemical analysis on incoming materials and chemicals. TI and TI suppliers consider certain information to be proprietary, and thus CAS numbers and other limited information may not be available for release.

In no event shall TI's liability arising out of such information exceed the total purchase price of the TI part(s) at issue in this document sold by TI to Customer on an annual basis.

TAPE AND REEL INFORMATION

QUADRANT ASSIGNMENTS FOR PIN 1 ORIENTATION IN TAPE

*All dimensions are nominal

Device	Package Type	Package Drawing	Pins	SPQ	Reel Diameter (mm)	Reel Width W1 (mm)	A0 (mm)	B0 (mm)	K0 (mm)	P1 (mm)	W (mm)	Pin1 Quadrant
LM2937ESX-12/NOPB	DDPAK/TO-263	KTT	3	500	330.0	24.4	10.75	14.85	5.0	16.0	24.0	Q2
LM2937ESX-15/NOPB	DDPAK/TO-263	KTT	3	500	330.0	24.4	10.75	14.85	5.0	16.0	24.0	Q2
LM2937ESX-3.3/NOPB	DDPAK/TO-263	KTT	3	500	330.0	24.4	10.75	14.85	5.0	16.0	24.0	Q2
LM2937ESX-5.0/NOPB	DDPAK/TO-263	KTT	3	500	330.0	24.4	10.75	14.85	5.0	16.0	24.0	Q2
LM2937ESX-8.0/NOPB	DDPAK/TO-263	KTT	3	500	330.0	24.4	10.75	14.85	5.0	16.0	24.0	Q2
LM2937IMP-10/NOPB	SOT-223	DCY	4	1000	330.0	16.4	7.0	7.5	2.2	12.0	16.0	Q3
LM2937IMP-12/NOPB	SOT-223	DCY	4	1000	330.0	16.4	7.0	7.5	2.2	12.0	16.0	Q3
LM2937IMP-2.5/NOPB	SOT-223	DCY	4	1000	330.0	16.4	7.0	7.5	2.2	12.0	16.0	Q3
LM2937IMP-3.3/NOPB	SOT-223	DCY	4	1000	330.0	16.4	7.0	7.5	2.2	12.0	16.0	Q3
LM2937IMP-5.0/NOPB	SOT-223	DCY	4	1000	330.0	16.4	7.0	7.5	2.2	12.0	16.0	Q3
LM2937IMP-8.0/NOPB	SOT-223	DCY	4	1000	330.0	16.4	7.0	7.5	2.2	12.0	16.0	Q3
LM2937IMPX-10/NOPB	SOT-223	DCY	4	2000	330.0	16.4	7.0	7.5	2.2	12.0	16.0	Q3

Device	Package Type	Package Drawing	Pins	SPQ	Reel Diameter (mm)	Reel Width W1 (mm)	A0 (mm)	B0 (mm)	K0 (mm)	P1 (mm)	W (mm)	Pin1 Quadrant
LM2937IMPX-12/NOPB	SOT-223	DCY	4	2000	330.0	16.4	7.0	7.5	2.2	12.0	16.0	Q3
LM2937IMPX-15/NOPB	SOT-223	DCY	4	2000	330.0	16.4	7.0	7.5	2.2	12.0	16.0	Q3
LM2937IMPX-2.5/NOPB	SOT-223	DCY	4	2000	330.0	16.4	7.0	7.5	2.2	12.0	16.0	Q3
LM2937IMPX-3.3/NOPB	SOT-223	DCY	4	2000	330.0	16.4	7.0	7.5	2.2	12.0	16.0	Q3
LM2937IMPX-5.0/NOPB	SOT-223	DCY	4	2000	330.0	16.4	7.0	7.5	2.2	12.0	16.0	Q3
LM2937IMPX-8.0/NOPB	SOT-223	DCY	4	2000	330.0	16.4	7.0	7.5	2.2	12.0	16.0	Q3

TAPE AND REEL BOX DIMENSIONS

*All dimensions are nominal

Device	Package Type	Package Drawing	Pins	SPQ	Length (mm)	Width (mm)	Height (mm)
LM2937ESX-12/NOPB	DDPAK/TO-263	KTT	3	500	356.0	356.0	45.0
LM2937ESX-15/NOPB	DDPAK/TO-263	KTT	3	500	356.0	356.0	45.0
LM2937ESX-3.3/NOPB	DDPAK/TO-263	KTT	3	500	356.0	356.0	45.0
LM2937ESX-5.0/NOPB	DDPAK/TO-263	KTT	3	500	356.0	356.0	45.0
LM2937ESX-8.0/NOPB	DDPAK/TO-263	KTT	3	500	356.0	356.0	45.0
LM2937IMP-10/NOPB	SOT-223	DCY	4	1000	367.0	367.0	35.0
LM2937IMP-12/NOPB	SOT-223	DCY	4	1000	367.0	367.0	35.0
LM2937IMP-2.5/NOPB	SOT-223	DCY	4	1000	367.0	367.0	35.0
LM2937IMP-3.3/NOPB	SOT-223	DCY	4	1000	367.0	367.0	35.0
LM2937IMP-5.0/NOPB	SOT-223	DCY	4	1000	367.0	367.0	35.0
LM2937IMP-8.0/NOPB	SOT-223	DCY	4	1000	367.0	367.0	35.0
LM2937IMPX-10/NOPB	SOT-223	DCY	4	2000	367.0	367.0	35.0
LM2937IMPX-12/NOPB	SOT-223	DCY	4	2000	367.0	367.0	35.0
LM2937IMPX-15/NOPB	SOT-223	DCY	4	2000	367.0	367.0	35.0
LM2937IMPX-2.5/NOPB	SOT-223	DCY	4	2000	367.0	367.0	35.0
LM2937IMPX-3.3/NOPB	SOT-223	DCY	4	2000	367.0	367.0	35.0
LM2937IMPX-5.0/NOPB	SOT-223	DCY	4	2000	367.0	367.0	35.0
LM2937IMPX-8.0/NOPB	SOT-223	DCY	4	2000	367.0	367.0	35.0

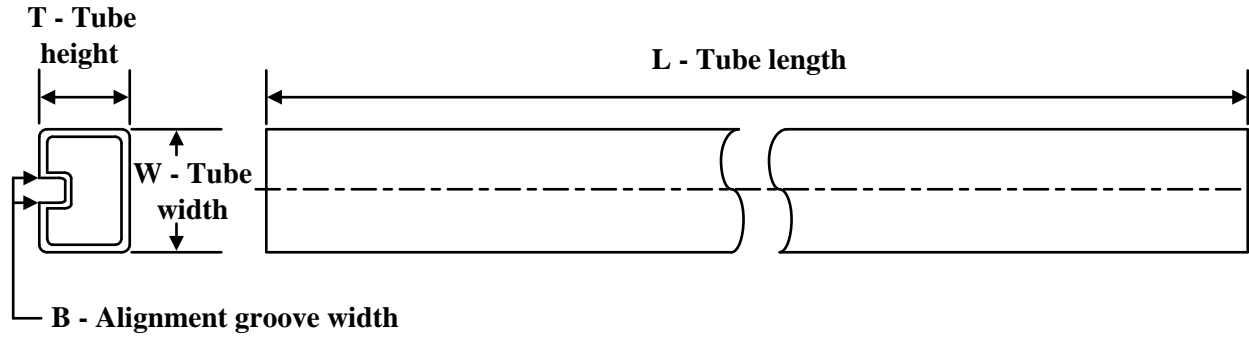
TUBE

*All dimensions are nominal

Device	Package Name	Package Type	Pins	SPQ	L (mm)	W (mm)	T (μm)	B (mm)
LM2937ES-10/NOPB	KTT	TO-263	3	45	502	25	8204.2	9.19
LM2937ES-12/NOPB	KTT	TO-263	3	45	502	25	8204.2	9.19
LM2937ES-15/NOPB	KTT	TO-263	3	45	502	25	8204.2	9.19
LM2937ES-2.5/NOPB	KTT	TO-263	3	45	502	25	8204.2	9.19
LM2937ES-3.3/NOPB	KTT	TO-263	3	45	502	25	8204.2	9.19
LM2937ES-5.0/NOPB	KTT	TO-263	3	45	502	25	8204.2	9.19
LM2937ES-8.0/NOPB	KTT	TO-263	3	45	502	25	8204.2	9.19
LM2937ET-10/NOPB	NDE	TO-220	3	45	502	33	6985	4.06
LM2937ET-12/NOPB	NDE	TO-220	3	45	502	33	6985	4.06
LM2937ET-15/NOPB	NDE	TO-220	3	45	502	33	6985	4.06
LM2937ET-2.5/NOPB	NDE	TO-220	3	45	502	33	6985	4.06
LM2937ET-3.3/NOPB	NDE	TO-220	3	45	502	33	6985	4.06
LM2937ET-5.0/NOPB	NDE	TO-220	3	45	502	33	6985	4.06
LM2937ET-8.0/NOPB	NDE	TO-220	3	45	502	33	6985	4.06

NDE0003B

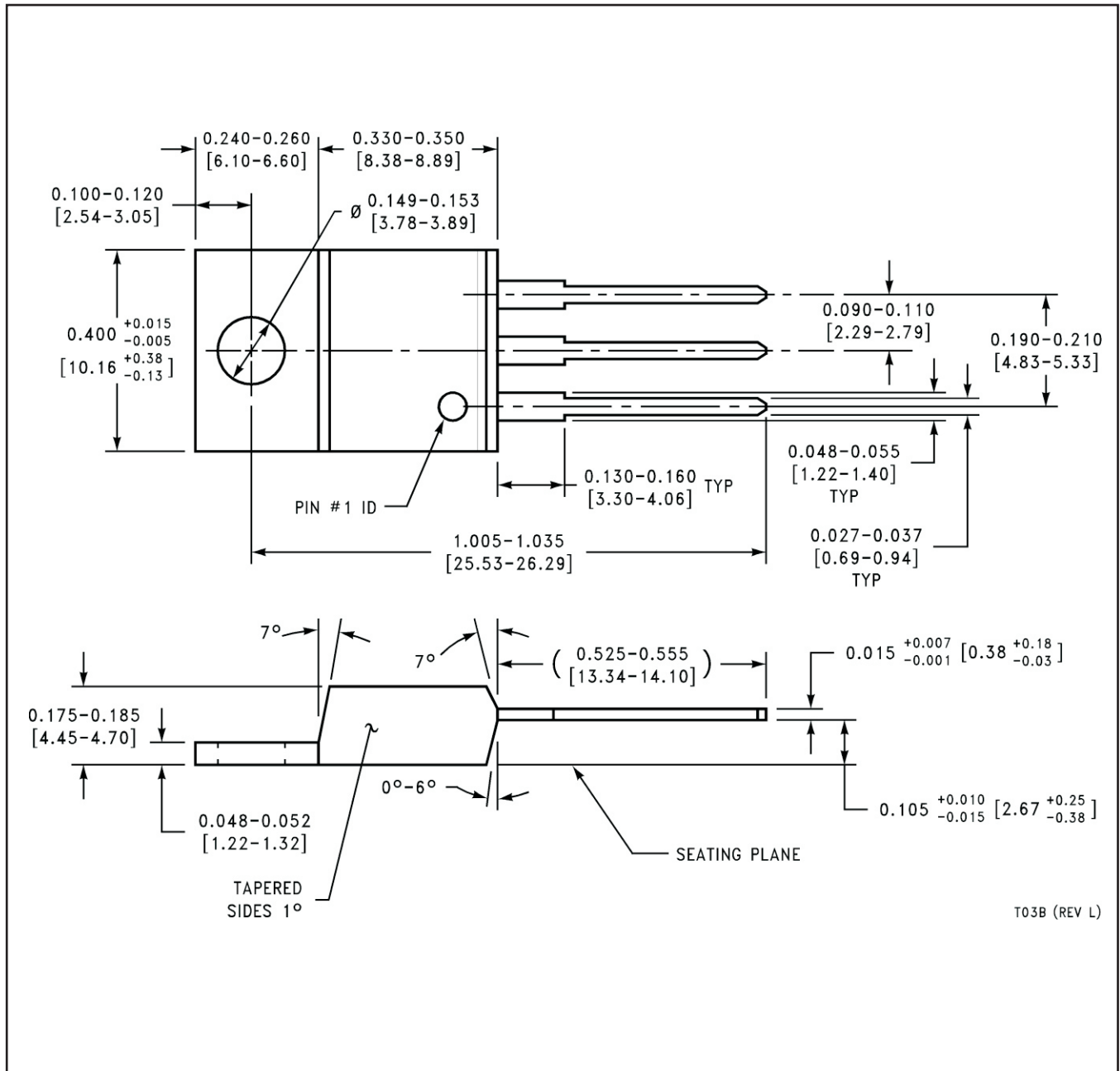

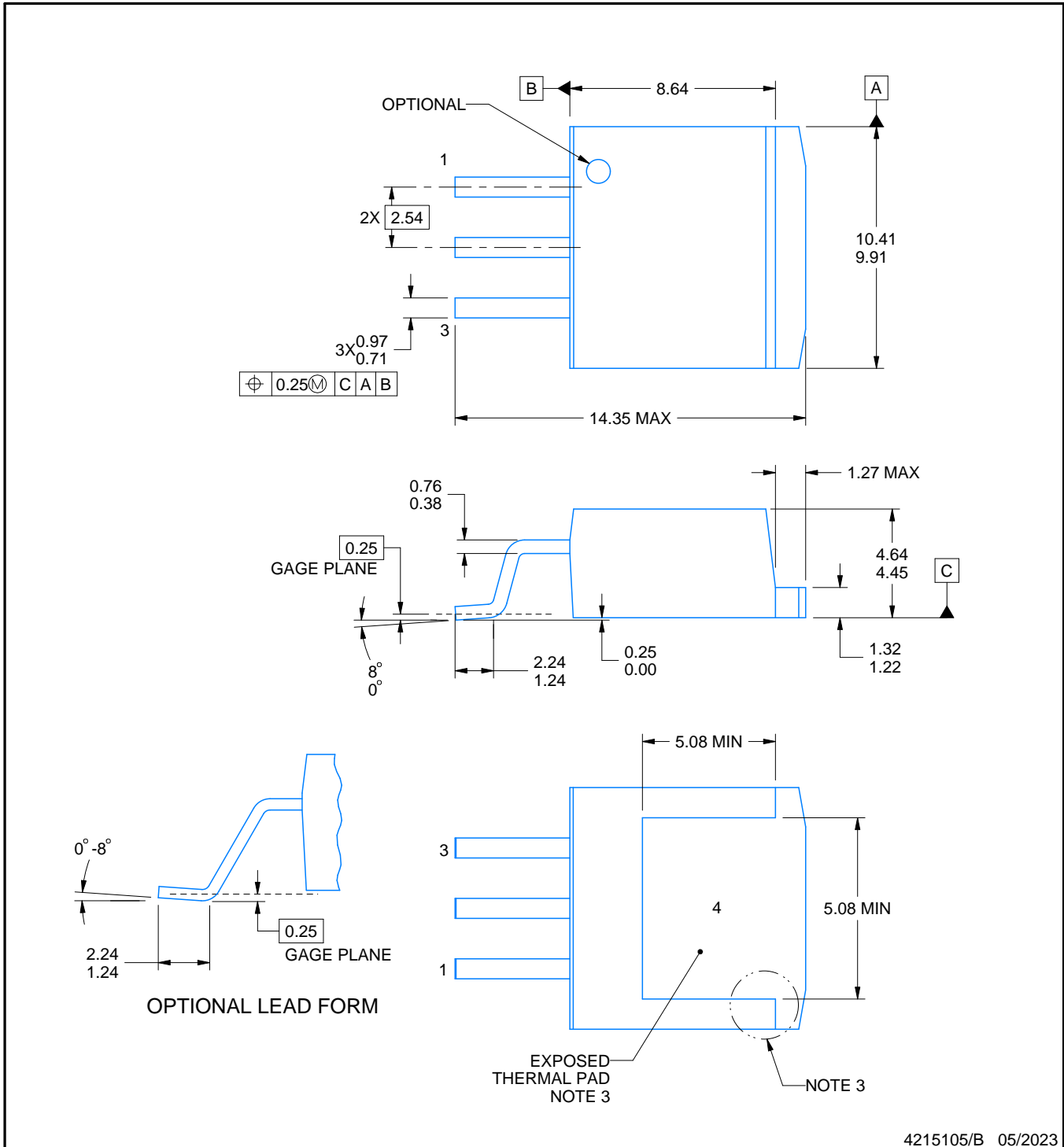

4215105/B 05/2023

NOTES:

1. All linear dimensions are in millimeters. Any dimensions in parenthesis are for reference only. Dimensioning and tolerancing per ASME Y14.5M.
2. This drawing is subject to change without notice.
3. Features may not exist and shape may vary per different assembly sites.
4. Reference JEDEC registration TO-263, except minimum lead thickness and minimum exposed pad length.

EXAMPLE BOARD LAYOUT

KTT0003B

TO-263 - 4.83 mm max height

TO-263

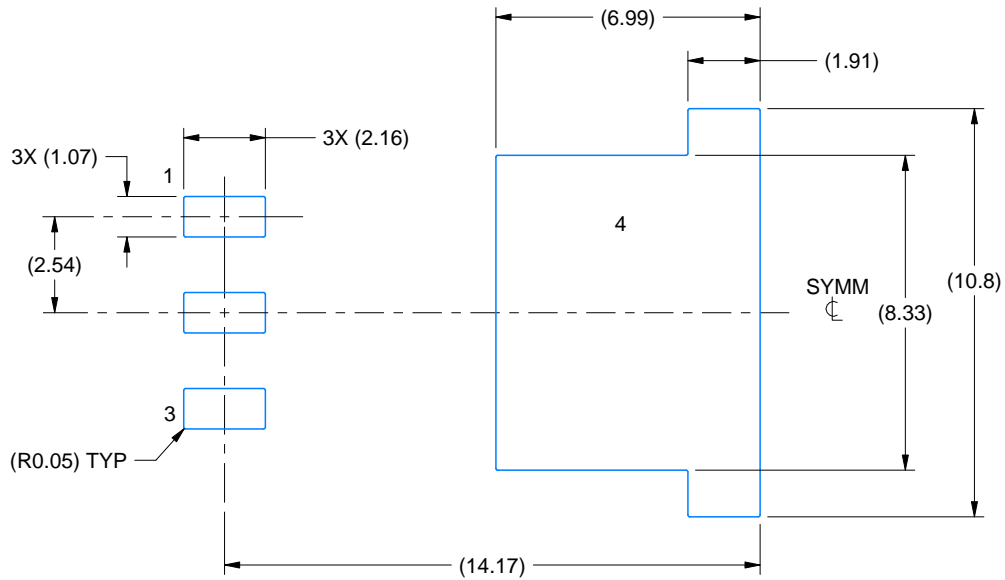

LAND PATTERN EXAMPLE
EXPOSED METAL SHOWN
SCALE:5X

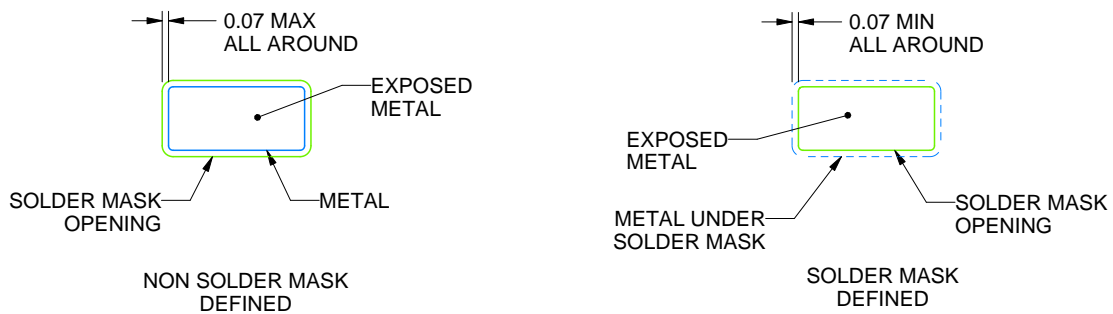

SOLDER MASK DETAILS

4215105/B 05/2023

NOTES: (continued)

5. This package is designed to be soldered to a thermal pad on the board. For more information, see Texas Instruments literature numbers SLMA002 (www.ti.com/lit/slm002) and SLMA004 (www.ti.com/lit/slma004).
6. Vias are optional depending on application, refer to device data sheet. It is recommended that vias under paste be filled, plugged or tented.

EXAMPLE STENCIL DESIGN

KTT0003B

TO-263 - 4.83 mm max height

TO-263

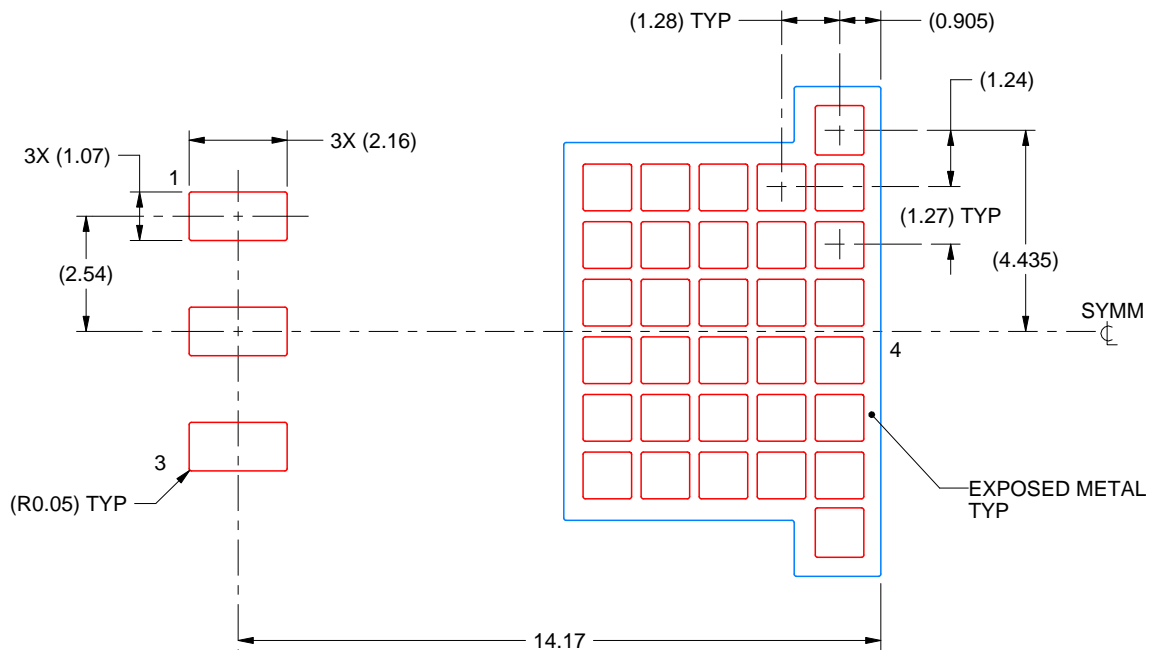

SOLDER PASTE EXAMPLE
BASED ON 0.125 mm THICK STENCIL
EXPOSED PAD
60% PRINTED SOLDER COVERAGE BY AREA
SCALE:6X

4215105/B 05/2023

NOTES: (continued)

7. Laser cutting apertures with trapezoidal walls and rounded corners may offer better paste release. IPC-7525 may have alternate design recommendations.
8. Board assembly site may have different recommendations for stencil design.

DCY (R-PDSO-G4)

PLASTIC SMALL-OUTLINE



- NOTES: A. All linear dimensions are in millimeters (inches).
 B. This drawing is subject to change without notice.
 C. Body dimensions do not include mold flash or protrusion.
 D. Falls within JEDEC TO-261 Variation AA.

IMPORTANT NOTICE AND DISCLAIMER

TI PROVIDES TECHNICAL AND RELIABILITY DATA (INCLUDING DATA SHEETS), DESIGN RESOURCES (INCLUDING REFERENCE DESIGNS), APPLICATION OR OTHER DESIGN ADVICE, WEB TOOLS, SAFETY INFORMATION, AND OTHER RESOURCES "AS IS" AND WITH ALL FAULTS, AND DISCLAIMS ALL WARRANTIES, EXPRESS AND IMPLIED, INCLUDING WITHOUT LIMITATION ANY IMPLIED WARRANTIES OF MERCHANTABILITY, FITNESS FOR A PARTICULAR PURPOSE OR NON-INFRINGEMENT OF THIRD PARTY INTELLECTUAL PROPERTY RIGHTS.

These resources are intended for skilled developers designing with TI products. You are solely responsible for (1) selecting the appropriate TI products for your application, (2) designing, validating and testing your application, and (3) ensuring your application meets applicable standards, and any other safety, security, regulatory or other requirements.

These resources are subject to change without notice. TI grants you permission to use these resources only for development of an application that uses the TI products described in the resource. Other reproduction and display of these resources is prohibited. No license is granted to any other TI intellectual property right or to any third party intellectual property right. TI disclaims responsibility for, and you will fully indemnify TI and its representatives against, any claims, damages, costs, losses, and liabilities arising out of your use of these resources.

TI's products are provided subject to [TI's Terms of Sale](#) or other applicable terms available either on [ti.com](https://www.ti.com) or provided in conjunction with such TI products. TI's provision of these resources does not expand or otherwise alter TI's applicable warranties or warranty disclaimers for TI products.

TI objects to and rejects any additional or different terms you may have proposed.

Mailing Address: Texas Instruments, Post Office Box 655303, Dallas, Texas 75265
Copyright © 2024, Texas Instruments Incorporated