

## REF35 超低功耗高精度电压基准

### 1 特性

- 超低静态电流：
  - 650nA (典型值)
- 初始精度： $\pm 0.05\%$  (最大值)
- 温度系数 (最大值)：
  - 12ppm/°C (-40°C 至 105°C, SOT23 封装)
  - 10ppm/°C (-40°C 至 85°C, WCSP 封装)
- 输出 1/f 噪声 (0.1Hz 至 10Hz)：3.3ppm<sub>p-p</sub>
- NR 引脚可降低噪声
- EN 引脚可降低关断电流消耗
- 长期稳定性：1k 小时内为 40ppm
- 热迟滞：70ppm
- 工作温度范围：-55°C 至 +125°C
- 输出电流：+10mA, -5mA
- 输入电压： $V_{REF} + V_{DO}$  至 6V
- 输出电压选项：
  - 1.024V、1.2V、1.25V、1.6V、1.8V、2.048V、2.5V、3.0V、3.3V、4.096V、5.0V
- 小型 6 引脚 SOT-23 封装
- 尺寸超小的 4 引脚 WCSP 封装

### 2 应用

- 流量变送器
- 血糖监控
- 伺服驱动器控制模块
- 电能质量分析仪
- 故障指示灯
- 示波器
- 过程分析
- 光学模块

### 3 说明

REF35 是毫微功耗、低漂移、高精度串联基准系列器件。REF35 系列具有  $\pm 0.05\%$  的初始精度，典型功耗为 650nA。该器件的温度系数 (12ppm/°C) 和长期稳定性 (1000 小时内为 40ppm) 有助于提高系统稳定性和可靠性。凭借低功耗以及高精度规格，此器件适用于多种便携式应用和低电流应用。

REF35 可提供高达 10mA 电流，噪声为 3.3ppm<sub>p-p</sub>，负载调整率为 20ppm/mA。借助这一功能集，REF35 可为精密传感器和 12 至 16 位数据转换器提供强大的低噪声高精度电源。

此系列的额定工作温度范围为 -40°C 至 105°C，并且在 -55°C 至 125°C 也可以正常运行。凭借宽温度范围，此系列适用于工业应用。

REF35 提供 1.024V 至 5.0V 的宽输出电压范围。该器件具有节省空间的 6 引脚 SOT-23 和 4 引脚 WCSP 封装选项。有关可用的电压和封装选项，请联系您当地的 TI 销售代表。

#### 封装信息

器件型号	封装 <sup>(1)</sup>	本体尺寸 (标称值) <sup>(2)</sup>
REF35xxx	SOT-23 (6)	2.90mm × 1.60mm
	WCSP (4)	1.05mm × 0.84mm

- 如需了解所有可用电压选项和封装，请参阅数据表末尾的可订购产品附录。
- 封装尺寸 (长 × 宽) 为标称值，并包括引脚 (如适用)。

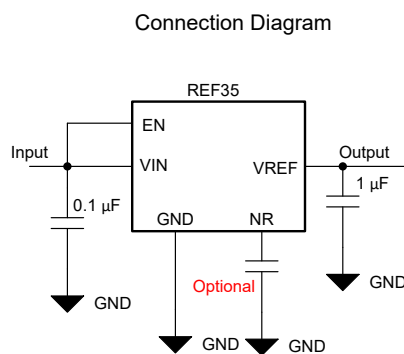

#### Typical Application Use Cases

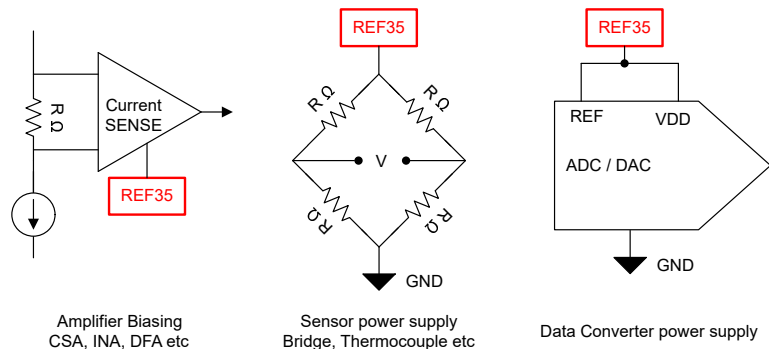

#### REF35 用例



## Table of Contents

<b>1 特性</b> .....	<b>1</b>	<b>8 Detailed Description</b> .....	<b>21</b>
<b>2 应用</b> .....	<b>1</b>	8.1 Overview.....	21
<b>3 说明</b> .....	<b>1</b>	8.2 Functional Block Diagram.....	21
<b>4 Device Comparison</b> .....	<b>3</b>	8.3 Feature Description.....	21
<b>5 Pin Configuration and Functions</b> .....	<b>3</b>	8.4 Device Functional Modes .....	22
<b>6 Specifications</b> .....	<b>4</b>	<b>9 Application and Implementation</b> .....	<b>24</b>
6.1 Absolute Maximum Ratings.....	4	9.1 Application Information.....	24
6.2 ESD Ratings.....	4	9.2 Typical Applications.....	24
6.3 Recommended Operating Conditions.....	4	9.3 Power Supply Recommendations.....	27
6.4 Thermal Information.....	4	9.4 Layout.....	27
6.5 Electrical Characteristics.....	5	<b>10 Device and Documentation Support</b> .....	<b>29</b>
6.6 Electrical Characteristics YBH package.....	6	10.1 Documentation Support.....	29
6.7 Typical Characteristics.....	8	10.2 接收文档更新通知.....	29
<b>7 Parameter Measurement Information</b> .....	<b>15</b>	10.3 支持资源.....	29
7.1 Solder Heat Shift.....	15	10.4 Trademarks.....	29
7.2 Temperature Coefficient.....	16	10.5 静电放电警告.....	29
7.3 Long-Term Stability.....	16	10.6 术语表.....	29
7.4 Thermal Hysteresis.....	17	<b>11 Revision History</b> .....	<b>29</b>
7.5 Noise Performance.....	18	<b>12 Mechanical, Packaging, and Orderable Information</b> .....	<b>30</b>
7.6 Power Dissipation.....	20		

## 4 Device Comparison

PRODUCT		V <sub>REF</sub>
SOT-23 (6)	WCSP (4)	
REF35102QDBVR	REF35102YBHR	1.024V
REF35120QDBVR	REF35120YBHR	1.2V
REF35125QDBVR	REF35125YBHR	1.25V
REF35160QDBVR	REF35160YBHR	1.6V
REF35170QDBVR	-	1.7V
REF35180QDBVR	REF35180YBHR	1.8V
REF35205QDBVR	-	2.048V
REF35250QDBVR	REF35250YBHR	2.5V
REF35300QDBVR	REF35300YBHR	3.0V
REF35330QDBVR	-	3.3V
REF35360QDBVR	-	3.6V
REF35409QDBVR	REF35409YBHR	4.096V
REF35500QDBVR	-	5.0V

## 5 Pin Configuration and Functions



图 5-1. DBV Package  
6-Pin SOT-23  
Top View



图 5-2. YBH Package  
4-Pin WCSP  
Top View

表 5-1. Pin Functions

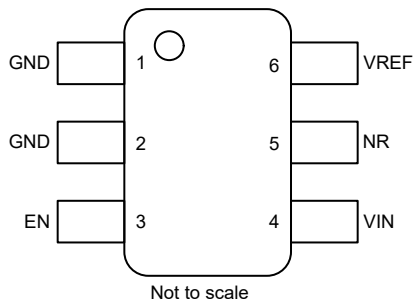
NAME	PIN		TYPE	DESCRIPTION
	SOT-23	WCSP		
GND	1	B1	Ground	Device ground connection. For DBV package pin 1 and pin 2 are internally short.
GND	2	-	Ground	Device ground connection.
EN	3	B2	Input	Enable connection. Enables or disables the device.
VIN	4	A2	Power	Input supply voltage connection.
NR	5	-	Output	Noise reduction pin. Connect a capacitor to reduce noise. This pin can be left floating.
VREF	6	A1	Output	Reference voltage output.

## 6 Specifications

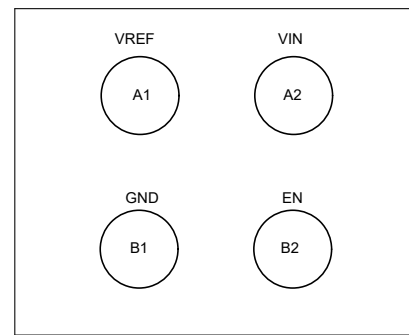
### 6.1 Absolute Maximum Ratings

over operating free-air temperature range (unless otherwise noted) <sup>(1)</sup>

		MIN	MAX	UNIT
Input voltage	IN	- 0.3	6.5	V
Enable voltage	EN	- 0.3	IN + 0.3 <sup>(2)</sup>	V
Output voltage	V <sub>REF</sub>	- 0.3	IN + 0.3 <sup>(2)</sup>	V
Output short circuit current	I <sub>SC</sub>		20	mA
Operating temperature range	T <sub>A</sub>	- 55	125	°C
Storage temperature range	T <sub>stg</sub>	- 65	170	°C

- (1) Operation outside the Absolute Maximum Ratings may cause permanent device damage. Absolute Maximum Ratings do not imply functional operation of the device at these or any other conditions beyond those listed under Recommended Operating Conditions. If used outside the Recommended Operating Conditions but within the Absolute Maximum Ratings, the device may not be fully functional, and this may affect device reliability, functionality, performance, and shorten the device lifetime.
- (2) IN + 0.3V or 6.5V, whichever is lower

### 6.2 ESD Ratings

			VALUE	UNIT
V <sub>(ESD)</sub>	Electrostatic discharge	Human body model (HBM), per ANSI/ESDA/JEDEC JS-001, all pins <sup>(1)</sup>	±2000	V
		Charged device model (CDM), per ANSI/ESDA/JEDEC JS-002, all pins <sup>(2)</sup>	±750	

- (1) JEDEC document JEP155 states that 500V HBM allows safe manufacturing with a standard ESD control process.
- (2) JEDEC document JEP157 states that 250V CDM allows safe manufacturing with a standard ESD control process.

### 6.3 Recommended Operating Conditions

over operating free-air temperature range (unless otherwise noted)

		MIN	NOM	MAX	UNIT
IN	Input voltage <sup>(1)</sup>	V <sub>OUT</sub> + V <sub>DO</sub> <sup>(2)</sup>		6	V
EN	Enable voltage	0		IN	V
I <sub>L</sub>	Output current	- 5		10	mA
T <sub>A</sub>	Operating temperature	- 40	25	125	°C

- (1) For V<sub>REF</sub> = 1.024V to 1.5V, minimum V<sub>IN</sub> = 1.7V
- (2) V<sub>DO</sub> = Dropout voltage

### 6.4 Thermal Information

THERMAL METRIC <sup>(1)</sup>		REF35		UNIT
		YBH (WCSP)	DBV (SOT-23)	
		4 PINS	6 PINS	
R <sub>θJA</sub>	Junction-to-ambient thermal resistance	178.9	164.4	°C/W
R <sub>θJC(top)</sub>	Junction-to-case (top) thermal resistance	1.1	102.5	°C/W
R <sub>θJB</sub>	Junction-to-board thermal resistance	60.3	59.6	°C/W
Ψ <sub>JT</sub>	Junction-to-top characterization parameter	0.5	44.0	°C/W
Ψ <sub>JB</sub>	Junction-to-board characterization parameter	60.2	59.4	°C/W

THERMAL METRIC <sup>(1)</sup>		REF35		UNIT
		YBH (WCSP)	DBV (SOT-23)	
		4 PINS	6 PINS	
$R_{\theta JC(bot)}$	Junction-to-case (bottom) thermal resistance	N/A	N/A	°C/W

(1) For more information about traditional and new thermal metrics, see the [Semiconductor and IC Package Thermal Metrics](#) application report.

## 6.5 Electrical Characteristics

At  $V_{IN} = V_{REF} + 0.5V$ ,  $V_{EN} = V_{IN}$ ,  $C_L = 10\mu F$ ,  $C_{IN} = 0.1\mu F$ ,  $I_L = 0mA$ , minimum and maximum specifications at  $T_A = -40^\circ C$  to  $125^\circ C$ , typical specifications  $T_A = 25^\circ C$ ; unless otherwise noted

PARAMETER	TEST CONDITION	MIN	TYP	MAX	UNIT	
<b>ACCURACY AND DRIFT</b>						
Output voltage accuracy	$T_A = 25^\circ C$	-0.05		0.05	%	
Output voltage temperature coefficient	$-40^\circ C \leq T_A \leq 105^\circ C$			12	ppm/°C	
<b>LINE AND LOAD REGULATION</b>						
$\frac{\Delta V_{REF}}{\Delta V_{IN}}$	Line regulation	$V_{REF} < 2.5V$ ; $V_{IN} = V_{REF} + V_{DO}$ to $V_{INMAX}$ ; $-40^\circ C \leq T_A \leq 105^\circ C$		40	160	ppm/V
		$V_{REF} \geq 2.5V$ ; $V_{IN} = V_{REF} + V_{DO}$ to $V_{INMAX}$ ; $-40^\circ C \leq T_A \leq 105^\circ C$		40	120	ppm/V
$\frac{\Delta V_{REF}}{\Delta I_L}$	Load regulation	$I_L = 0mA$ to $10mA$ , $V_{IN} = V_{REF} + V_{DO}$	Source	20	60	ppm/mA
		$I_L = 0mA$ to $5mA$ , $V_{IN} = V_{REF} + V_{DO}$	Sink	40	350	ppm/mA
<b>POWER SUPPLY</b>						
$V_{IN}$	Input voltage <sup>(1)</sup>	$V_{REF} + V_{DO}$		6	V	
$I_Q$	Quiescent current	Active mode	$T_A = 25^\circ C$	0.65	0.9	$\mu A$
			$-40^\circ C \leq T_A \leq 85^\circ C$		1.3	
			$-40^\circ C \leq T_A \leq 125^\circ C$		2.6	
		Shutdown mode	$T_A = 25^\circ C$	0.1		
		$-40^\circ C \leq T_A \leq 125^\circ C$		0.5		
$V_{EN}$	Enable pin voltage	Active mode (EN = 1 or Float)		$0.7 \times V_{IN}$		
		Shutdown mode (EN = 0)		$0.3 \times V_{IN}$		
$I_{EN}$	Enable pin current	$V_{EN} = V_{IN}$		0.05	0.1	$\mu A$
$V_{DO}$	Dropout voltage	$I_L = 5mA$		120		
		$I_L = 10mA$		250		
$I_{SC}$	Short circuit current, Sourcing	$V_{REF} = 0V$ , $T_A = 25^\circ C$		33		
$I_{SC}$	Short circuit current, Sinking	$V_{REF} = V_{IN} V$ , $T_A = 25^\circ C$		21		
<b>TURN-ON TIME</b>						
$t_{ON}$	Turn-on time <sup>(2)</sup>	0.1% settling, $C_L = 1\mu F$ , $V_{REF} = 2.5V$		2		
<b>NOISE</b>						
$e_n$	Output voltage noise	$f = 10Hz$ to $1kHz$ , $C_L = 1\mu F$		0.7		
$e_{np-p}$	Low-frequency noise	$f = 0.1Hz$ to $10Hz$ , $V_{REF} \geq 2.5V$		3.8		
		$f = 0.1Hz$ to $10Hz$ , $V_{REF} < 2.5V$		3.3		
<b>HYSTERESIS AND LONG-TERM STABILITY</b>						
	Long-term stability	0 to 1000h at $35^\circ C$		40		

## 6.5 Electrical Characteristics (续)

At  $V_{IN} = V_{REF} + 0.5V$ ,  $V_{EN} = V_{IN}$ ,  $C_L = 10\mu F$ ,  $C_{IN} = 0.1\mu F$ ,  $I_L = 0mA$ , minimum and maximum specifications at  $T_A = -40^\circ C$  to  $125^\circ C$ , typical specifications  $T_A = 25^\circ C$ ; unless otherwise noted

PARAMETER	TEST CONDITION	MIN	TYP	MAX	UNIT
Output voltage hysteresis	25°C, -40°C, 105°C, 25°C (cycle 1)		70		ppm
Output voltage hysteresis	25°C, -40°C, 105°C, 25°C (cycle 2)		20		ppm
Output voltage hysteresis	25°C, -40°C, 85°C, 25°C (cycle 1)		50		ppm
Output voltage hysteresis	25°C, -40°C, 85°C, 25°C (cycle 2)		13		ppm
<b>STABLE CAPACITANCE RANGE</b>					
Input capacitor range		0.1			$\mu F$
Output capacitor range <sup>(3)</sup>		0.1		10	$\mu F$

(1) For  $V_{REF} = 1.024V$  to  $1.5V$ , minimum  $V_{IN} = 1.7V$

(2) Scales linearly with  $V_{REF}$ .

(3) ESR for the capacitor  $\leq 400m\Omega$

## 6.6 Electrical Characteristics YBH package

At  $V_{IN} = V_{REF} + 0.5V$ ,  $V_{EN} = V_{IN}$ ,  $C_{REF} = 10\mu F$ ,  $C_{IN} = 0.1\mu F$ ,  $I_L = 0mA$ , minimum and maximum specifications at  $T_A = -40^\circ C$  to  $125^\circ C$ , typical specifications  $T_A = 25^\circ C$ ; unless otherwise noted

PARAMETER	TEST CONDITION	MIN	TYP	MAX	UNIT		
<b>ACCURACY AND DRIFT</b>							
Output voltage accuracy	$T_A = 25^\circ C$	-0.05		0.05	%		
Output voltage temperature coefficient	$-40^\circ C \leq T_A \leq 85^\circ C$			10	ppm/°C		
<b>LINE AND LOAD REGULATION</b>							
$\frac{\Delta V_{REF}}{\Delta V_{IN}}$	Line regulation	$V_{REF} < 2.5V$ ; $V_{IN} = V_{REF} + V_{DO}$ to $V_{INMAX}$		40	160	ppm/V	
		$V_{REF} \geq 2.5V$ ; $V_{IN} = V_{REF} + V_{DO}$ to $V_{INMAX}$		40	80	ppm/V	
$\frac{\Delta V_{REF}}{\Delta I_L}$	Load regulation	$I_L = 0mA$ to $10mA$ , $V_{IN} = V_{REF} + V_{DO}$	Source	20	60	ppm/mA	
		$I_L = 0mA$ to $5mA$ , $V_{IN} = V_{REF} + V_{DO}$	Sink	40	350	ppm/mA	
<b>POWER SUPPLY</b>							
$V_{IN}$	Input voltage <sup>(1)</sup>	$V_{REF} + V_{DO}$			6	V	
$I_Q$	Quiescent current	Active mode	$T_A = 25^\circ C$	0.65	0.9	$\mu A$	
			$-40^\circ C \leq T_A \leq 85^\circ C$		1.3		
			$-40^\circ C \leq T_A \leq 125^\circ C$		2.6		
		Shutdown mode	$T_A = 25^\circ C$		0.1		
			$-40^\circ C \leq T_A \leq 125^\circ C$		0.5		
$V_{EN}$	Enable pin voltage	Active mode (EN = 1 or Float)			$0.7 \times V_{IN}$	V	
		Shutdown mode (EN = 0)			$0.3 \times V_{IN}$		
$I_{EN}$	Enable pin current	$V_{EN} = V_{IN}$			0.05	0.1	$\mu A$
$V_{DO}$	Dropout voltage	$I_L = 5mA$			120	mV	
		$I_L = 10mA$			250		
$I_{SC}$	Short circuit current, Sourcing	$V_{REF} = 0V$ , $T_A = 25^\circ C$			30	mA	

## 6.6 Electrical Characteristics YBH package (续)

At  $V_{IN} = V_{REF} + 0.5V$ ,  $V_{EN} = V_{IN}$ ,  $C_{REF} = 10\mu F$ ,  $C_{IN} = 0.1\mu F$ ,  $I_L = 0mA$ , minimum and maximum specifications at  $T_A = -40^\circ C$  to  $125^\circ C$ , typical specifications  $T_A = 25^\circ C$ ; unless otherwise noted

PARAMETER		TEST CONDITION	MIN	TYP	MAX	UNIT
$I_{SC}$	Short circuit current, Sinking	$V_{REF} = V_{IN} V$ , $T_A = 25^\circ C$		20		mA
<b>TURNON TIME</b>						
$t_{ON}$	Turn-on time <sup>(2)</sup>	0.1% settling, $C_{REF} = 1\mu F$ , $V_{REF} = 2.048V$		2		ms
<b>NOISE</b>						
$e_n$	Output voltage noise	$f = 10Hz$ to $1kHz$		0.7		$ppm_{rms}$
$e_{np-p}$	Low frequency noise	$f = 0.1Hz$ to $10Hz$ , $V_{REF} \geq 2.5V$		3.8		$ppm_{p-p}$
		$f = 0.1Hz$ to $10Hz$ , $V_{REF} < 2.5V$		3.3		$ppm_{p-p}$
<b>HYSTERESIS AND LONG-TERM STABILITY</b>						
	Long-term stability	0 to 1000h at $35^\circ C$		40		ppm
	Output voltage hysteresis	$25^\circ C$ , $-40^\circ C$ , $125^\circ C$ , $25^\circ C$ (cycle 1)		70		ppm
<b>STABLE CAPACITANCE RANGE</b>						
	Input capacitor range		0.1			$\mu F$
	Output capacitor range <sup>(3)</sup>		0.1		10	$\mu F$

- (1) For  $V_{REF} = 1.024V$  to  $1.5V$ , minimum  $V_{IN} = 1.7V$ .
- (2) Scales linearly with  $V_{REF}$ .
- (3) ESR for the capacitor can range from  $10m\Omega$  to  $400m\Omega$ .

## 6.7 Typical Characteristics

at  $T_A = 25^\circ\text{C}$ ,  $V_{IN} = V_{EN} = V_{REF} + 0.3\text{V}$ ,  $I_L = 0\text{mA}$ ,  $C_L = 10\mu\text{F}$ ,  $C_{IN} = 0.1\mu\text{F}$  (unless otherwise noted)

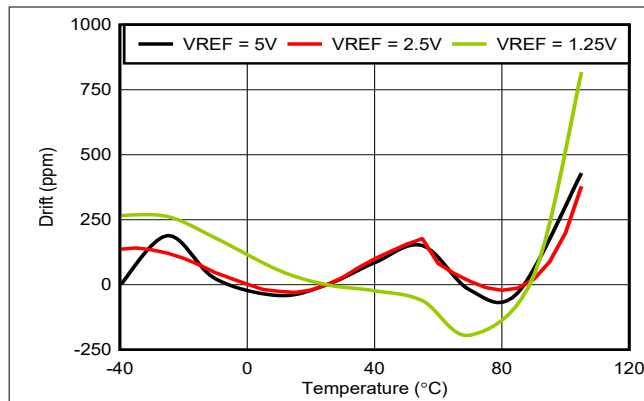

SOT23 Package

图 6-1. Output Voltage Drift vs Free-Air Temperature

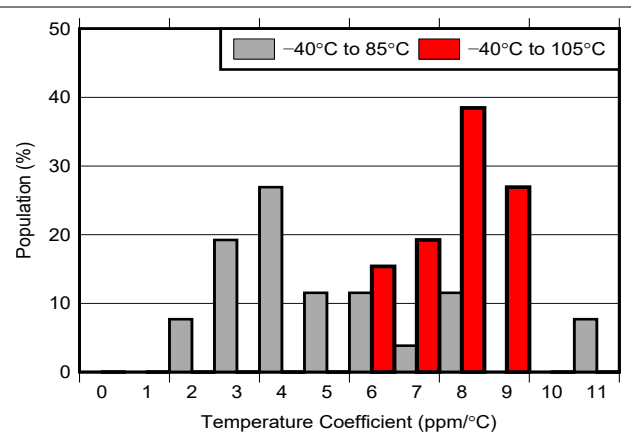

SOT23 Package

图 6-2. Temperature Coefficient Distribution ( $V_{REF} = 1.25\text{V}$ )

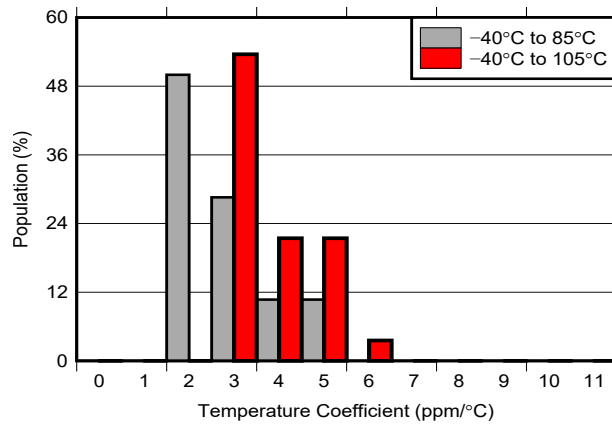

SOT23 Package

图 6-3. Temperature Coefficient Distribution ( $V_{REF} = 2.5\text{V}$ )

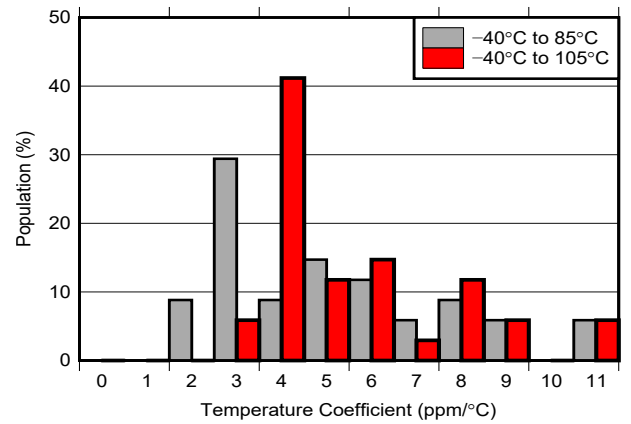

SOT23 Package

图 6-4. Temperature Coefficient Distribution ( $V_{REF} = 5.0\text{V}$ )

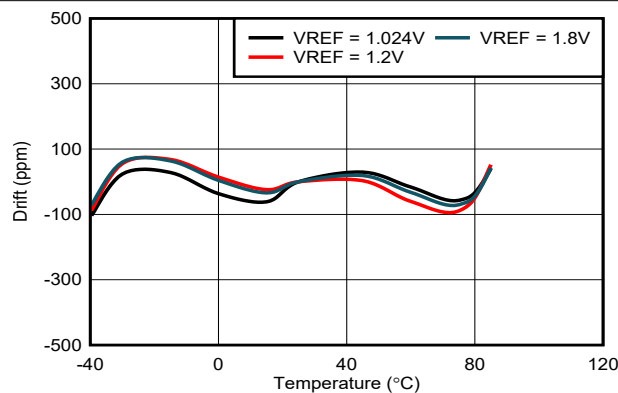

WSCP Package  $V_{REF} < 2.5\text{V}$  ( $-40^\circ\text{C}$  to  $85^\circ\text{C}$ )

图 6-5. Output Voltage Drift vs Free-Air Temperature

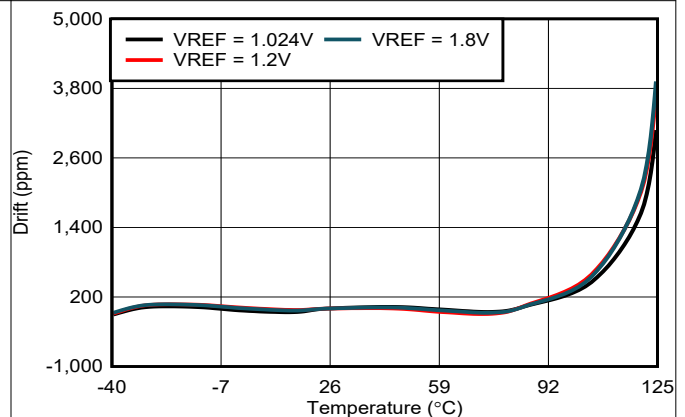

WSCP Package  $V_{REF} < 2.5\text{V}$  ( $-40^\circ\text{C}$  to  $125^\circ\text{C}$ )

图 6-6. Output Voltage Drift vs Free-Air Temperature



### 6.7 Typical Characteristics (continued)

at  $T_A = 25^\circ\text{C}$ ,  $V_{IN} = V_{EN} = V_{REF} + 0.3\text{V}$ ,  $I_L = 0\text{mA}$ ,  $C_L = 10\mu\text{F}$ ,  $C_{IN} = 0.1\mu\text{F}$  (unless otherwise noted)

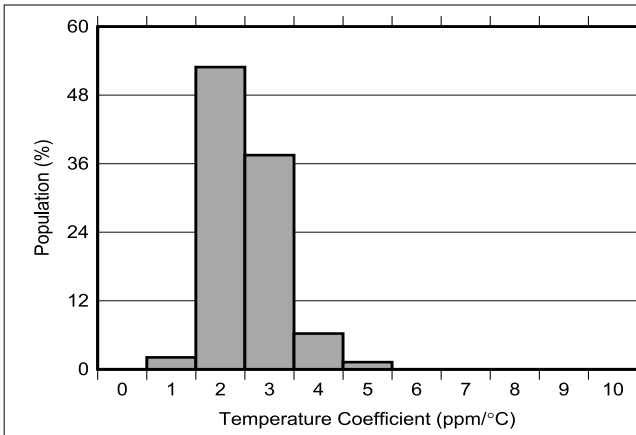

WCSP Package  $V_{REF} < 2.5\text{V}$  (-40°C to 85°C)

图 6-7. Temperature Coefficient Distribution

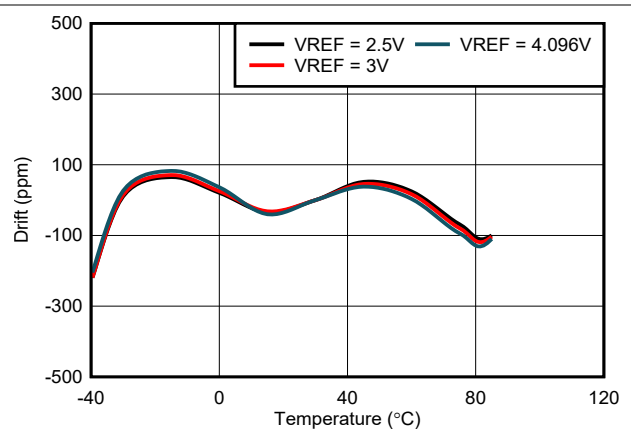

WCSP Package  $V_{REF} \geq 2.5\text{V}$  (-40°C to 85°C)

图 6-8. Output Voltage Drift vs Free-Air Temperature

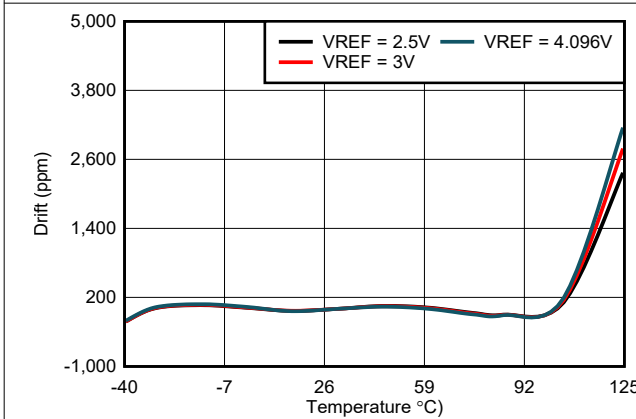

WCSP Package  $V_{REF} \geq 2.5\text{V}$  (-40°C to 125°C)

图 6-9. Output Voltage Drift vs Free-Air Temperature

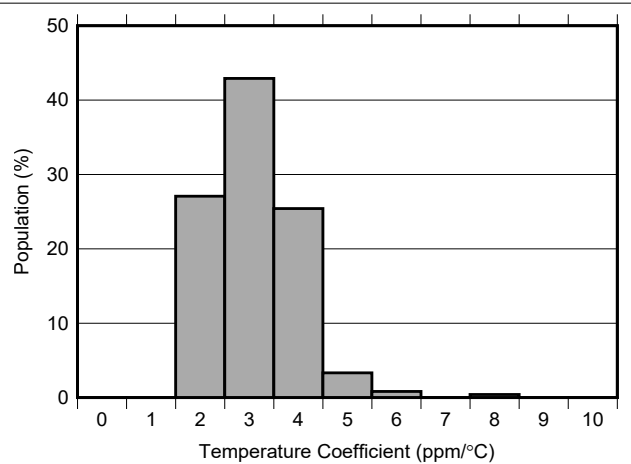

WCSP Package  $V_{REF} \geq 2.5\text{V}$  (-40°C to 85°C)

图 6-10. Temperature Coefficient Distribution



图 6-11. Initial Accuracy Distribution



图 6-12. 0.1Hz to 10Hz Noise Distribution ( $V_{REF} = 1.25\text{V}$ ,  $C_{NR} = \text{Open}$ ,  $I_L = 0\text{mA}$ )

### 6.7 Typical Characteristics (continued)

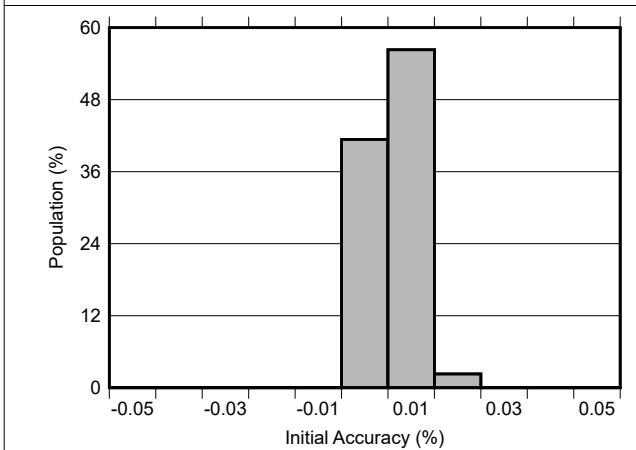
at  $T_A = 25^\circ\text{C}$ ,  $V_{IN} = V_{EN} = V_{REF} + 0.3\text{V}$ ,  $I_L = 0\text{mA}$ ,  $C_L = 10\mu\text{F}$ ,  $C_{IN} = 0.1\mu\text{F}$  (unless otherwise noted)

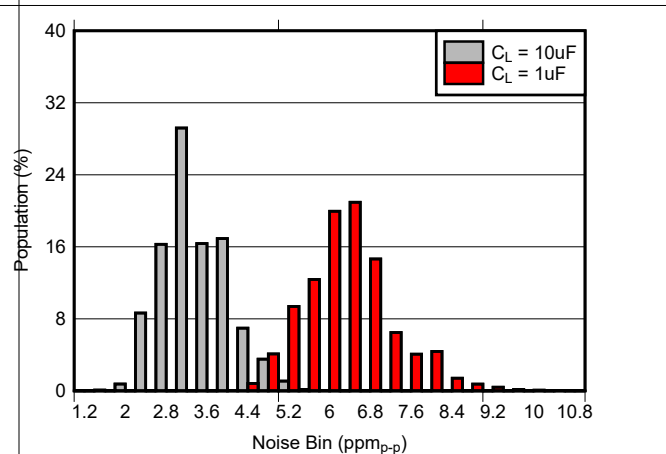

图 6-13. 0.1Hz to 10Hz Noise Distribution  
( $V_{REF} = 2.5\text{V}$ ,  $C_{NR} = \text{Open}$ ,  $I_L = 0\text{mA}$ )



图 6-14. 0.1Hz to 10Hz Noise Distribution  
( $V_{REF} = 5\text{V}$ ,  $C_{NR} = \text{Open}$ ,  $I_L = 0\text{mA}$ )

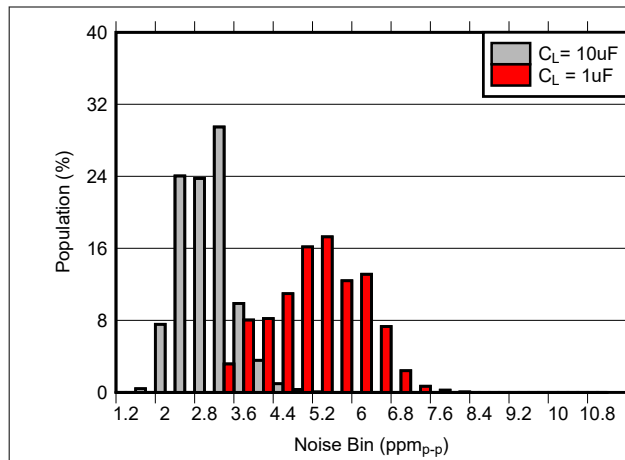

图 6-15. 0.1Hz to 10Hz Noise Distribution  
( $V_{REF} = 2.5\text{V}$ ,  $C_L = 1\mu\text{F}$ ,  $I_L = 0\text{mA}$ )

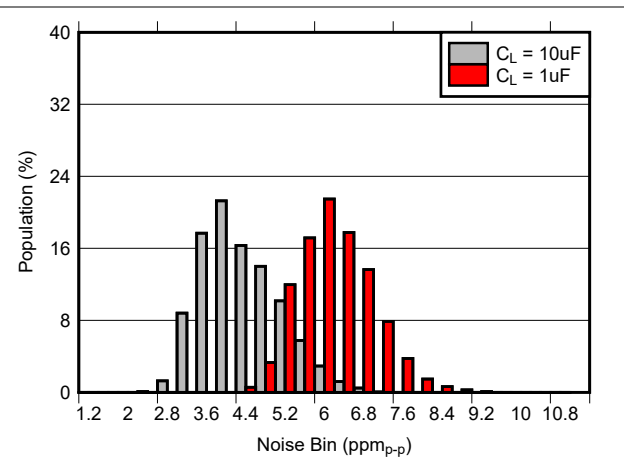

图 6-16. 0.1Hz to 10Hz Noise Distribution  
( $V_{REF} = 2.5\text{V}$ ,  $C_L = 1\mu\text{F}$ ,  $C_{NR} = \text{Open}$ )

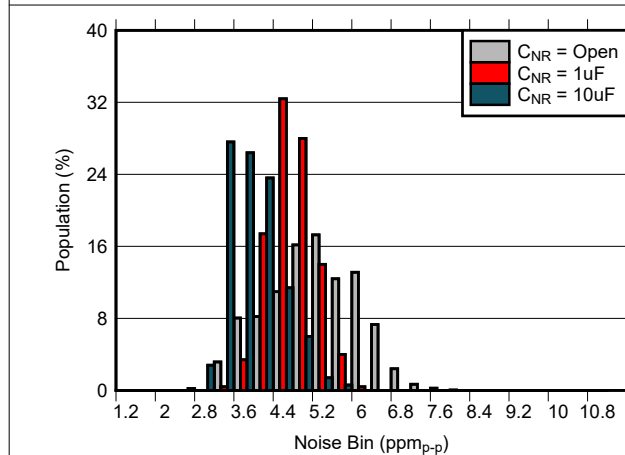

图 6-17. Noise Density vs Frequency  
( $V_{REF} = 1.25\text{V}$ ,  $I_L = 0\text{mA}$ )

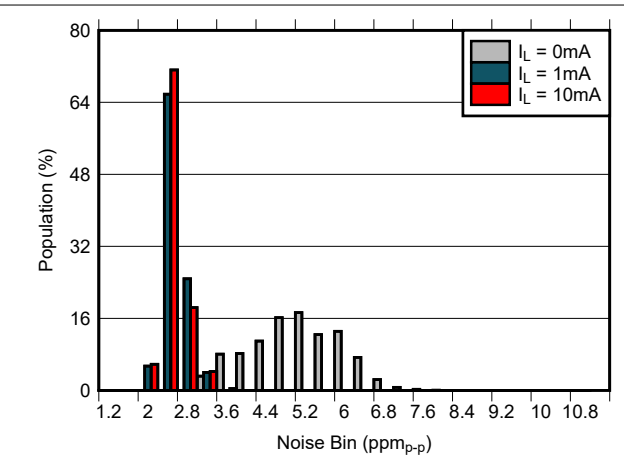

图 6-18. Noise Density vs Frequency  
( $V_{REF} = 2.5\text{V}$ ,  $I_L = 0\text{mA}$ )

## 6.7 Typical Characteristics (continued)

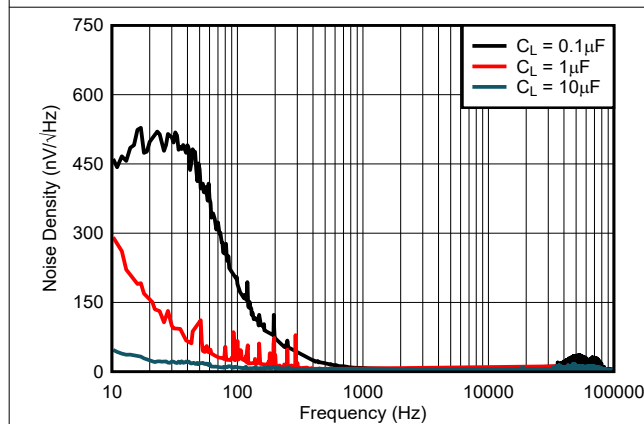
at  $T_A = 25^\circ\text{C}$ ,  $V_{IN} = V_{EN} = V_{REF} + 0.3\text{V}$ ,  $I_L = 0\text{mA}$ ,  $C_L = 10\mu\text{F}$ ,  $C_{IN} = 0.1\mu\text{F}$  (unless otherwise noted)

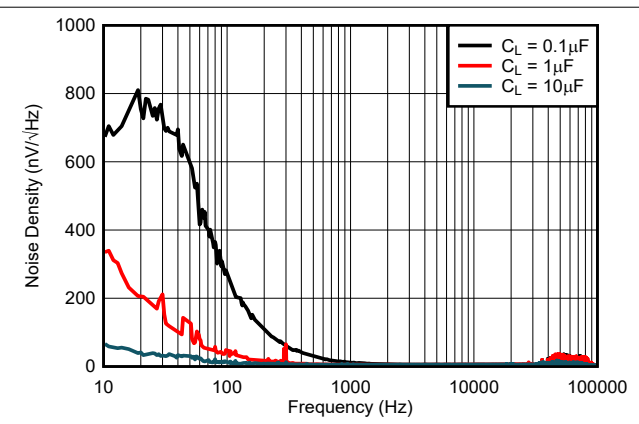

图 6-19. Noise Density vs Frequency  
( $V_{REF} = 5\text{V}$ ,  $I_L = 0\text{mA}$ )



图 6-20. Load Regulation (Sourcing 10mA) vs Free-Air Temperature

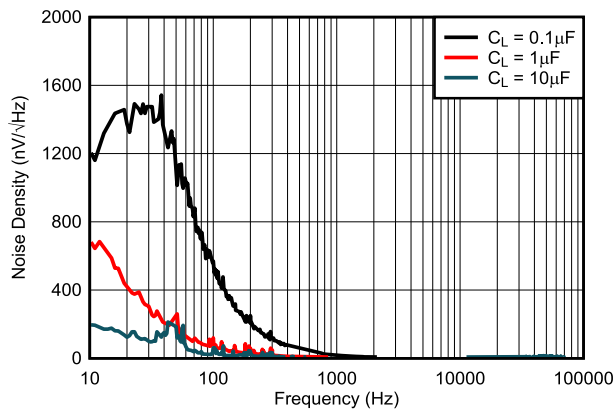

图 6-21. Load Regulation (Sinking 5mA) vs Free-Air Temperature

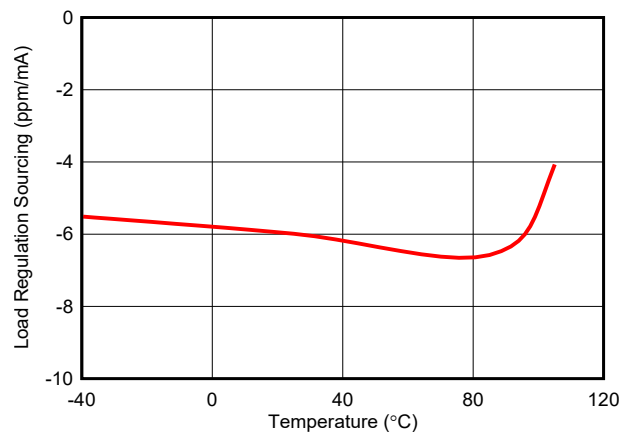

图 6-22. Load Transient Response  
( $V_{REF} = 2.5\text{V}$ ,  $C_L = 10\mu\text{F}$ )

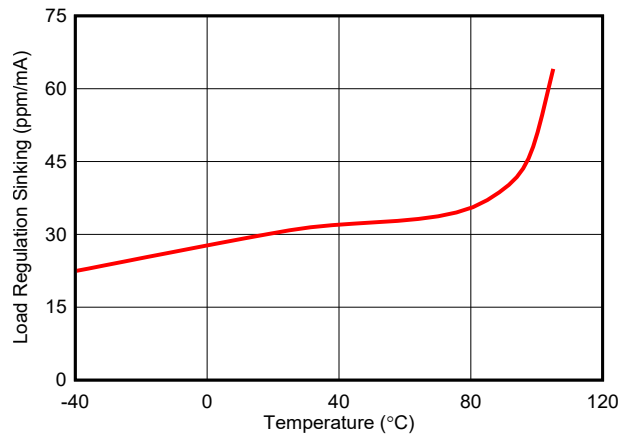

图 6-23. Load Transient Response  
( $V_{REF} = 2.5\text{V}$ ,  $C_L = 10\mu\text{F}$ )

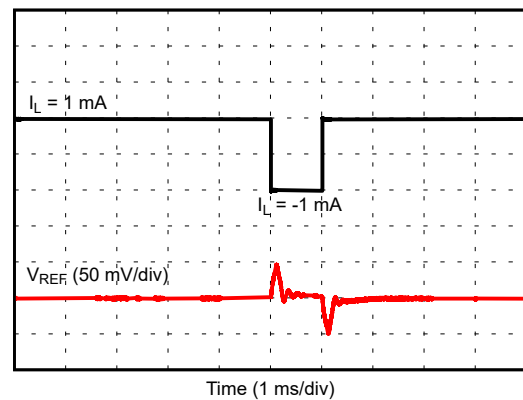

图 6-24. Load Transient Response  
( $V_{REF} = 2.5\text{V}$ ,  $C_L = 1\mu\text{F}$ )

## 6.7 Typical Characteristics (continued)

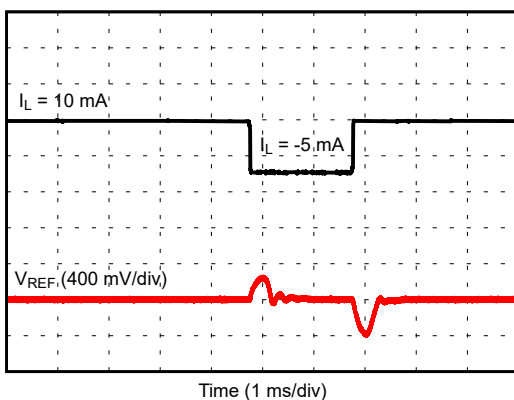
at  $T_A = 25^\circ\text{C}$ ,  $V_{IN} = V_{EN} = V_{REF} + 0.3\text{V}$ ,  $I_L = 0\text{mA}$ ,  $C_L = 10\mu\text{F}$ ,  $C_{IN} = 0.1\mu\text{F}$  (unless otherwise noted)

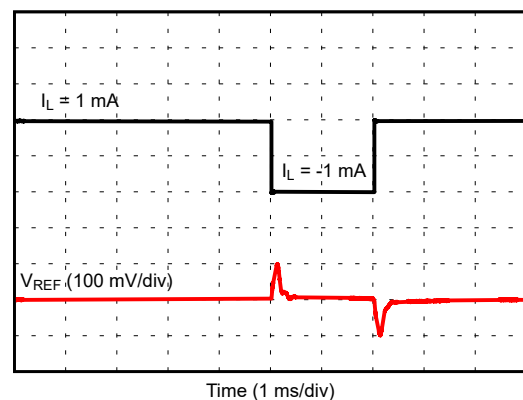

图 6-25. Load Transient Response  
( $V_{REF} = 2.5\text{V}$ ,  $C_L = 1\mu\text{F}$ )



图 6-26. Load Transient Response  
( $V_{REF} = 1.25\text{V}$ ,  $C_L = 1\mu\text{F}$ )

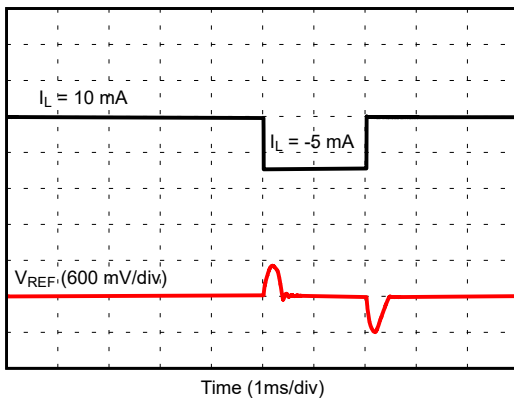

图 6-27. Load Transient Response  
( $V_{REF} = 1.25\text{V}$ ,  $C_L = 1\mu\text{F}$ )

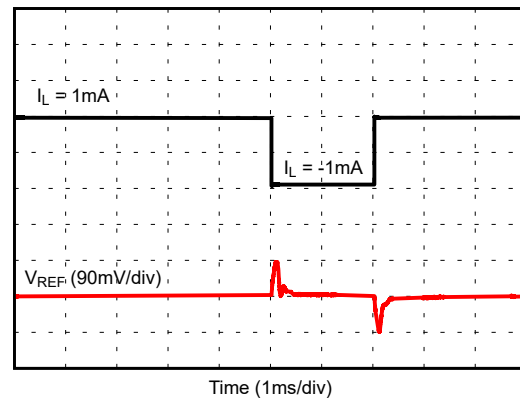

图 6-28. Line Regulation vs Free-Air Temperature

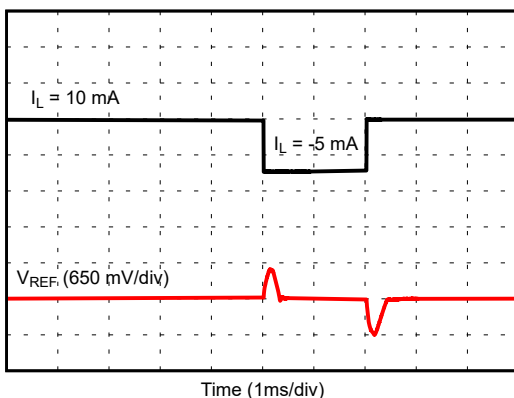

图 6-29. Line Transient Response  
( $V_{REF} = 1.25\text{V}$ ,  $C_L = 1\mu\text{F}$ )

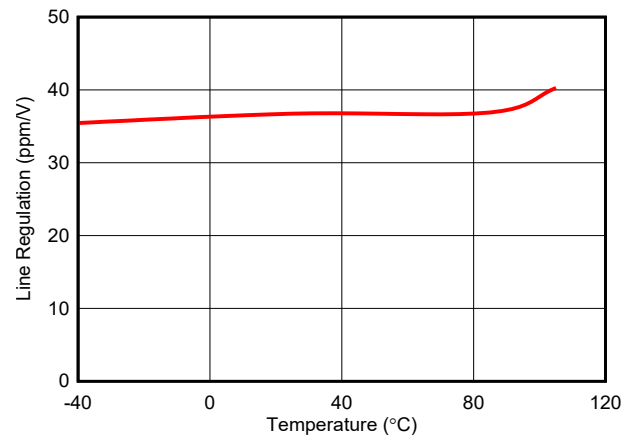

图 6-30. Line Transient Response  
( $V_{REF} = 2.5\text{V}$ ,  $C_L = 1\mu\text{F}$ )

### 6.7 Typical Characteristics (continued)

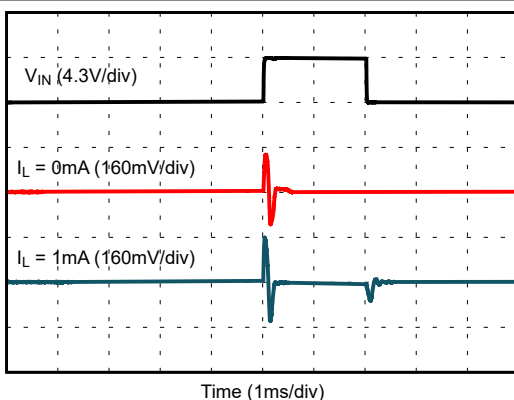
at  $T_A = 25^\circ\text{C}$ ,  $V_{IN} = V_{EN} = V_{REF} + 0.3\text{V}$ ,  $I_L = 0\text{mA}$ ,  $C_L = 10\mu\text{F}$ ,  $C_{IN} = 0.1\mu\text{F}$  (unless otherwise noted)

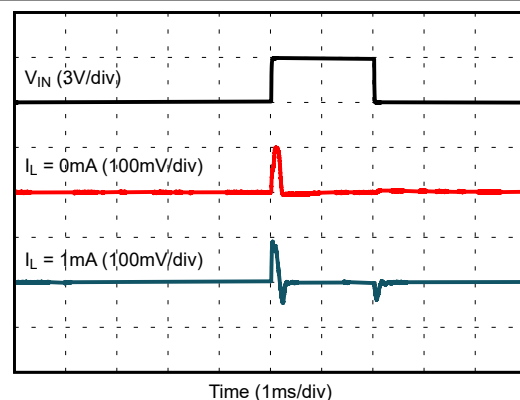

图 6-31. Power Supply Rejection Ratio ( $V_{REF} = 2.5\text{V}$ ,  $I_L = 0\text{mA}$ )



图 6-32. Output Impedance

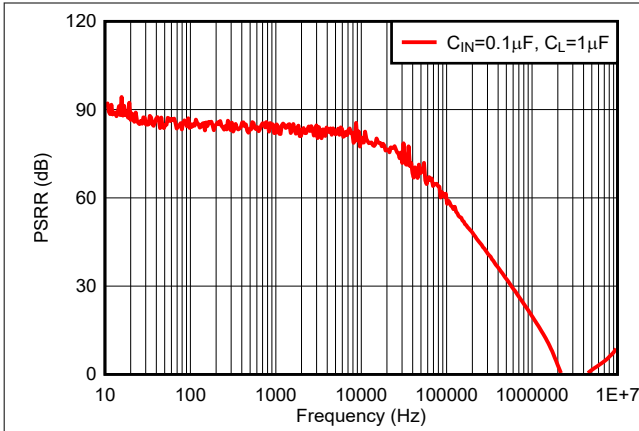

图 6-33. Quiescent Current vs Free-Air Temperature

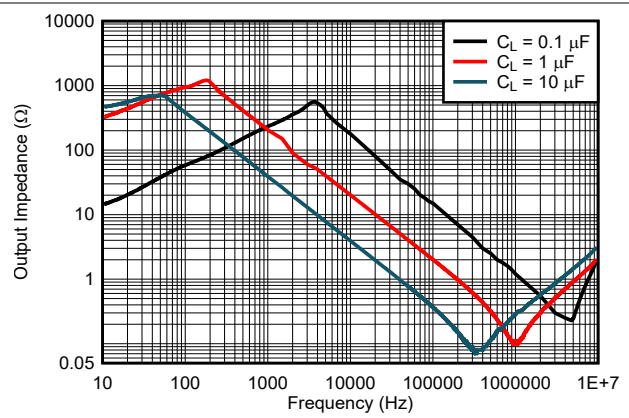

图 6-34. Dropout Voltage vs Free-Air Temperature

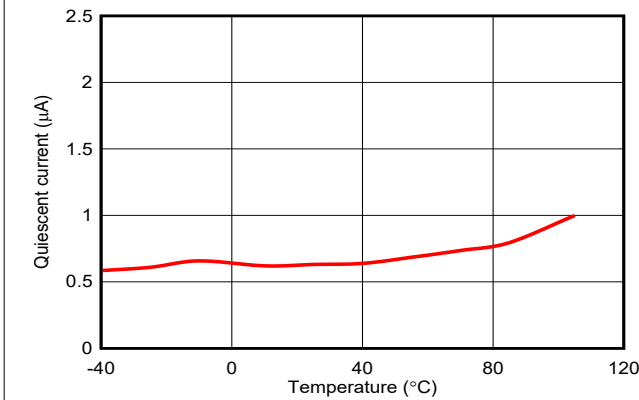

图 6-35. Solder Heat Shift Distribution

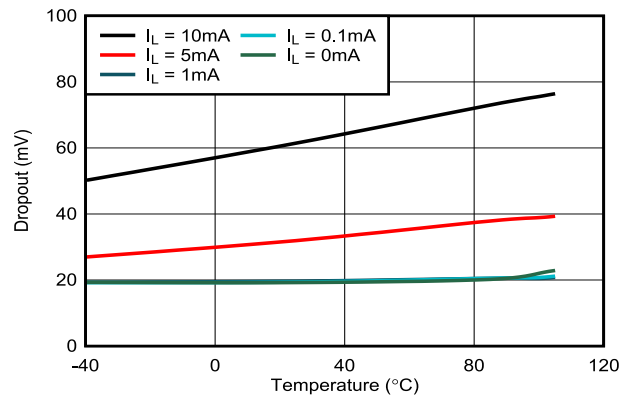

图 6-36. Long Term Stability SOT23 - 2000 hours ( $V_{REF}$ )

## 6.7 Typical Characteristics (continued)

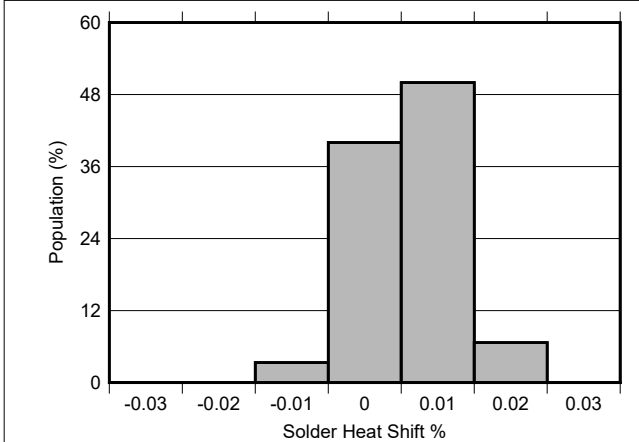
at  $T_A = 25^\circ\text{C}$ ,  $V_{IN} = V_{EN} = V_{REF} + 0.3\text{V}$ ,  $I_L = 0\text{mA}$ ,  $C_L = 10\mu\text{F}$ ,  $C_{IN} = 0.1\mu\text{F}$  (unless otherwise noted)

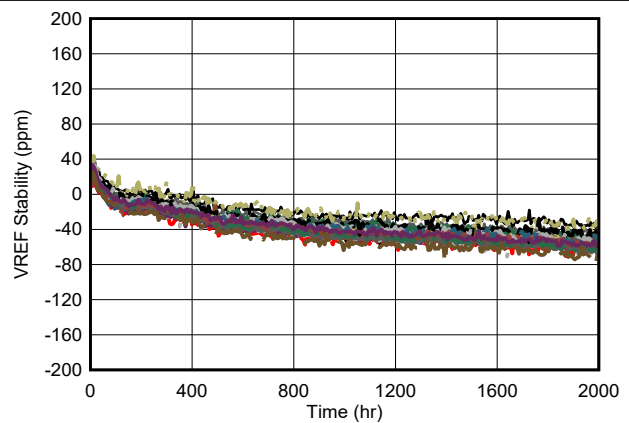

图 6-37. Long Term Stability WCSP - 2000 hours ( $V_{REF}$ )

## 7 Parameter Measurement Information

### 7.1 Solder Heat Shift

The materials used in the manufacture of the REF35 have differing coefficients of thermal expansion, resulting in stress on the device die when the part is heated. Mechanical and thermal stress on the device die can cause the output voltages to shift, degrading the initial accuracy specifications of the product. Reflow soldering is a common cause of this error.

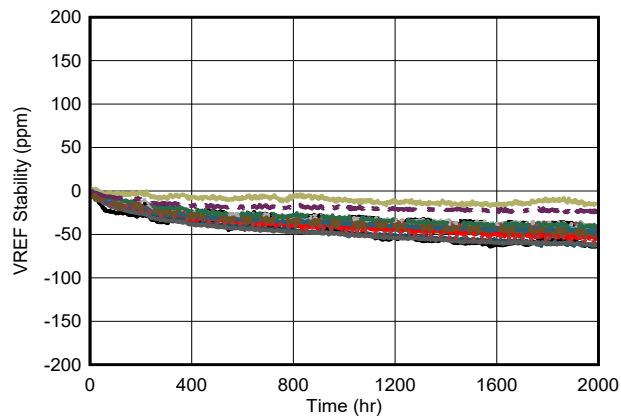
To illustrate this effect, a total of 32 devices were soldered on one printed circuit board using lead-free solder paste and the paste manufacturer suggested reflow profile. 图 7-1 shows the reflow profile. The printed circuit board is comprised of FR4 material. The board thickness is 1.66mm and the area is 174mm × 135mm.



图 7-1. Reflow Profile

The reference output voltage is measured before and after the reflow process; 图 7-2 shows the typical shift. Although all tested units exhibit very low shifts (< 0.03%), higher shifts are also possible depending on the size, thickness, and material of the printed circuit board (PCB). An important note is that the histograms display the typical shift for exposure to a single reflow profile. Exposure to multiple reflows, as is common on PCBs with surface-mount components on both sides, causes additional shifts in the output bias voltage. If the PCB is exposed to multiple reflows, the device must be soldered in the last pass to minimize its exposure to thermal stress.

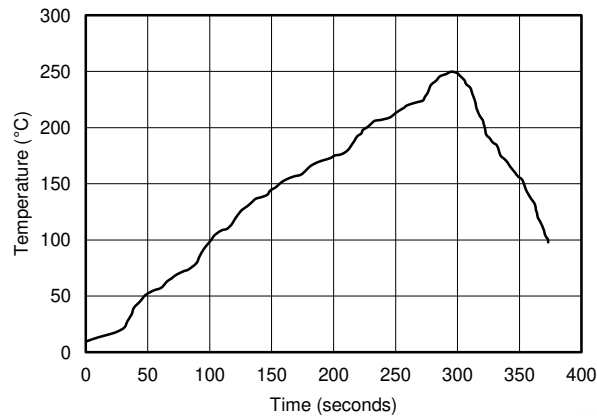

图 7-2. Solder Heat Shift Distribution,  $V_{REF}$  (%)

## 7.2 Temperature Coefficient

The REF35 is designed and tested for a low output voltage temperature coefficient. The temperature coefficient is defined as the change in output voltage over temperature. The temperature coefficient is calculated using the box method in which a box is formed by the minimum/maximum values for the nominal output voltage over the operating temperature range. REF35 has a low maximum temperature coefficient of 12ppm/°C from -40°C to +105°C. The box method specifies limits for the temperature error but does not specify the exact shape and slope of the device under test. Due to temperature curvature correction to achieve low-temperature drift, the temperature drift is expected to be non-linear. See TI's Analog Design Journal, [Precision voltage references](#), for more information on the box method. Use [方程式 1](#) for the box method.

$$\text{Drift} = \left( \frac{V_{\text{REF(MAX)}} - V_{\text{REF(MIN)}}}{V_{\text{REF(25}^\circ\text{C)}} \times \text{Temperature Range}} \right) \times 10^6 \quad (1)$$

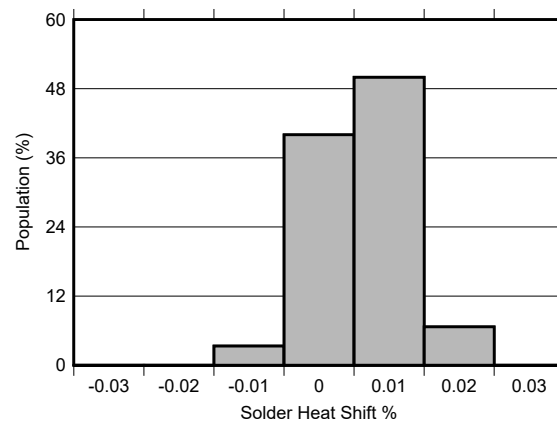
图 7-3 shows a typical voltage versus temperature curves for various reference voltages in SOT23 package. 图 7-4 shows the distribution of temperature coefficients for REF35250 devices in SOT23 package.

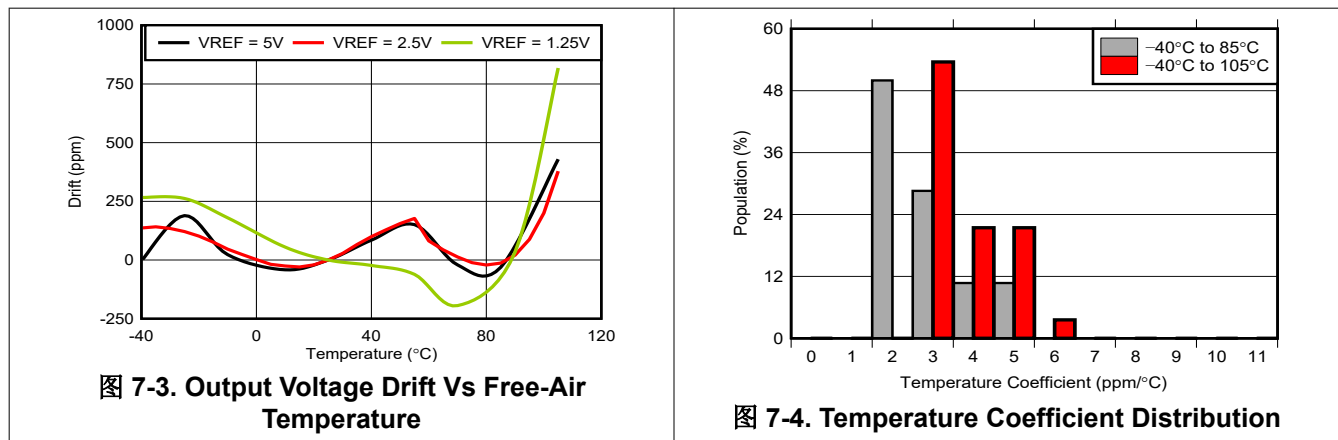

## 7.3 Long-Term Stability

One of the key performance parameters of the REF35 references is long-term stability also known as long-term drift. The long-term stability value is tested in a setup that reflects standard PCB board manufacturing practices. The boards are made of standard FR4 material and the board does not have special cuts or grooves around the devices to relieve the mechanical stress of the PCB. The devices and boards in this test do not undergo high temperature burn in post-soldering prior to testing. These conditions reflect a real world use case scenario and common manufacturing techniques.

During the long-term stability testing, precautions are taken to make sure that only the long-term stability drift is measured. The boards are maintained at 35°C in an oil bath. The oil bath makes sure that the temperature is constant across the device over time compared to an air oven. The measurements are captured every 30 minutes with a calibrated 8.5 digit multimeter.

The typical long-term stability characteristic is expressed as a deviation of the reference voltage output over time.

图 7-5 shows that the typical drift value for the REF35 6-pin SOT-23 package is 40ppm from 0 to 1000 hours and 55ppm from 0 to 2000 hours. It is important to understand that long-term stability is not ensured by design and that the value is typical. The REF35 will experience the highest drift in the initial 1000 hr. Subsequent deviation is typically lower than first 1000 hr.



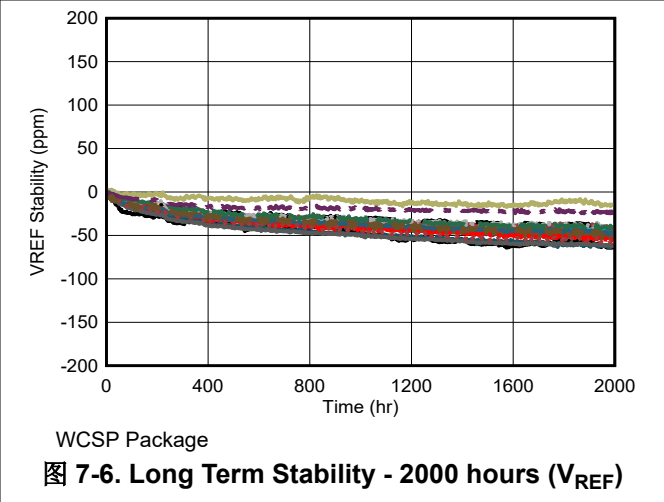
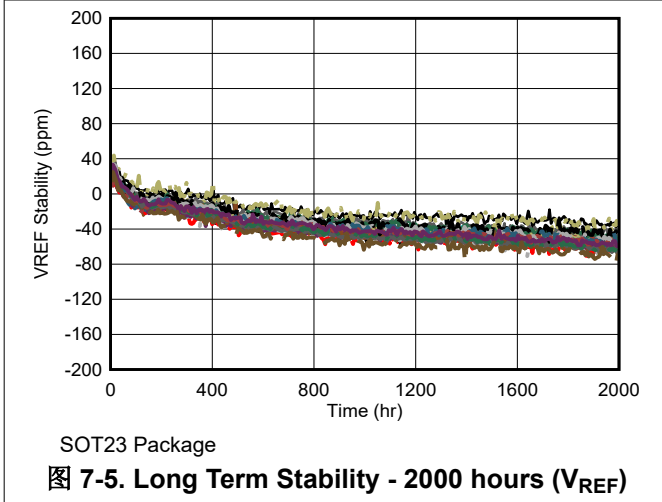

### 7.4 Thermal Hysteresis

Thermal hysteresis is measured with the REF35 soldered to a PCB, similar to a real-world application. Thermal hysteresis for the device is defined as the change in output voltage after operating the device at 25°C, cycling the device through the specified temperature range, and returning to 25°C. The PCB was baked at 150°C for 30 minutes before thermal hysteresis was measured. Use [方程式 2](#) to calculate the thermal hysteresis:

$$V_{HYST} = \left( \frac{|V_{PRE} - V_{POST}|}{V_{NOM}} \right) \times 10^6 \text{ (ppm)} \tag{2}$$

where

- V<sub>HYST</sub> = thermal hysteresis (in units of ppm)
- V<sub>NOM</sub> = the specified output voltage
- V<sub>PRE</sub> = output voltage measured at 25°C pre-temperature cycling
- V<sub>POST</sub> = output voltage measured after the device has cycled from 25°C through the specified temperature range of -40°C to +85°C or -40°C to +105°C and returns to 25°C.

The graphs below show the typical thermal hysteresis distribution across various temperature ranges in two cycles.

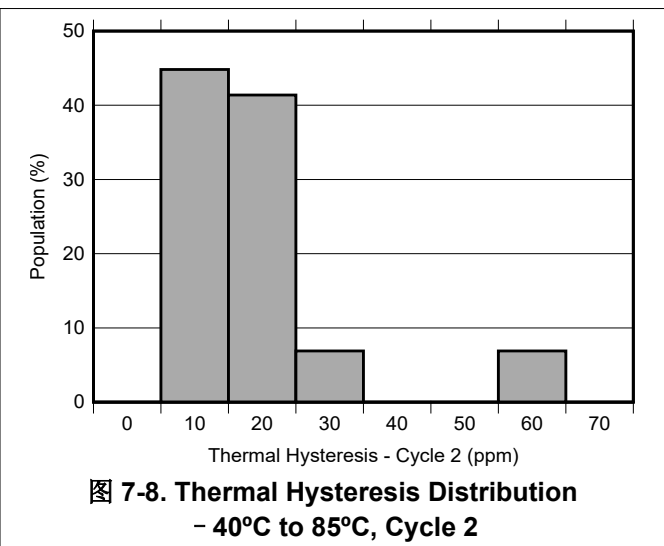
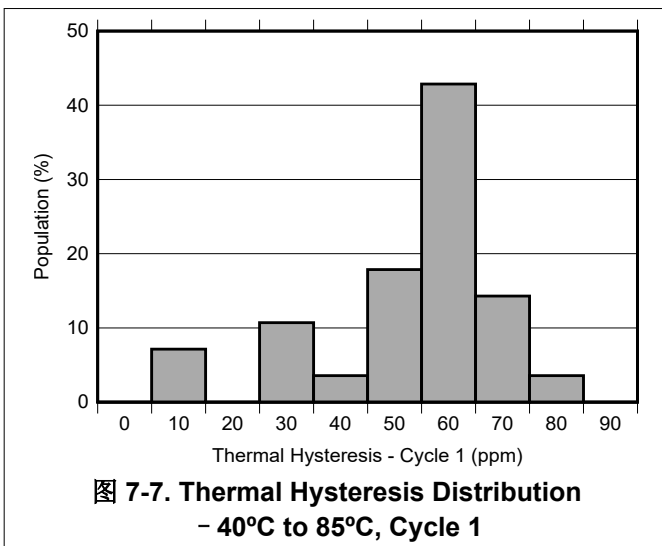



图 7-9. Thermal Hysteresis Distribution  
- 40°C to 105°C, Cycle 1



图 7-10. Thermal Hysteresis Distribution  
- 40°C to 105°C, Cycle 2

## 7.5 Noise Performance

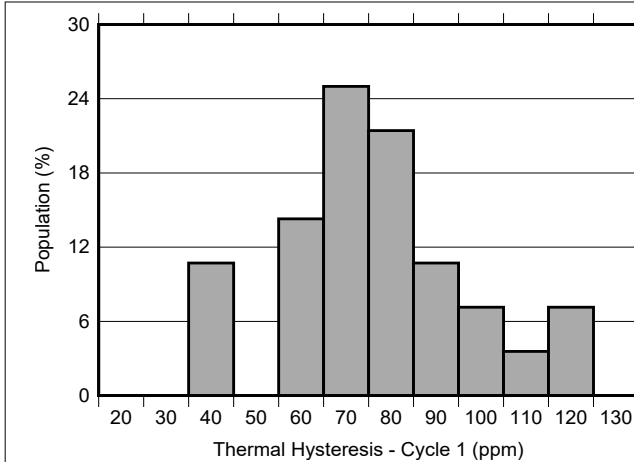
The reference pin output noise is categorized as low frequency and broadband noise. The following sections describe these categories in detail.

### 7.5.1 Low-Frequency (1/f) Noise

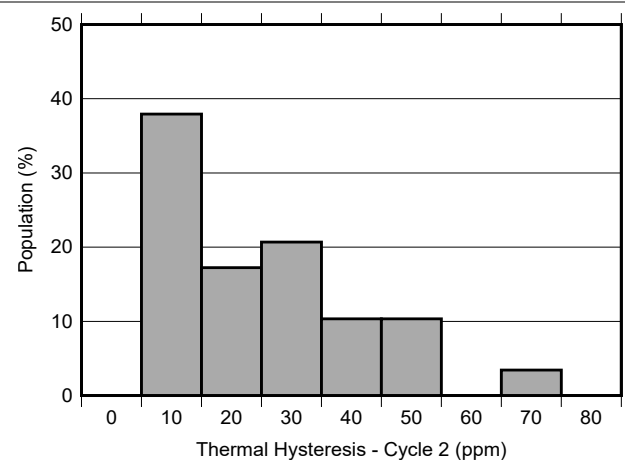
Flicker noise, also known as 1/f noise, is a low-frequency noise that affects the device output voltage which can affect precision measurements in ADCs. This noise increases proportionally with output voltage and operating temperature. Noise is measured by filtering the output from 0.1Hz to 10Hz. The 1/f noise is an extremely low value, therefore the frequency of interest must be amplified and band-pass filtered. This is done by using a high-pass filter to block the DC voltage. The resulting noise is then amplified by a gain of 1000. The bandpass filter is created by a series of high-pass and low-pass filter that adds additional gain to make it more visible on a oscilloscope as shown in 图 7-11. 图 7-12 shows the effect of flicker noise over 10 second for REF35250. Flicker noise must be tested in a Faraday cage enclosure to block environmental noise.



图 7-11. Low-Frequency (1/f) Noise Test Setup



图 7-12. 0.1Hz to 10Hz Voltage Noise

图 7-13 shows the typical 1/f noise (0.1Hz to 10Hz) distribution across various load conditions. REF35 device also offers noise reduction functionality by adding an optional capacitor between NR (pin 5) and ground pins.

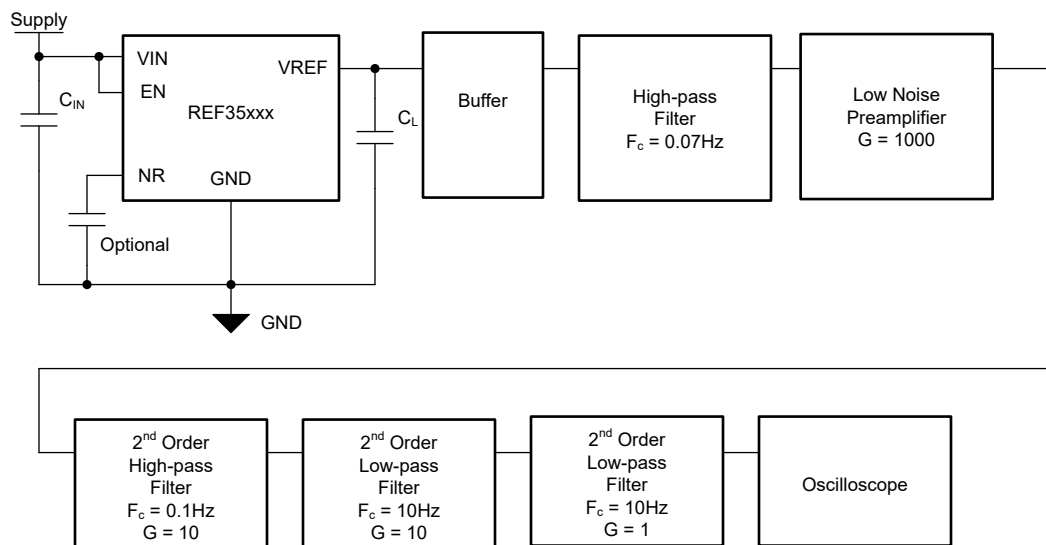
图 7-14 shows the typical 1/f noise (0.1Hz to 10Hz) distribution across REF35 devices with various capacitance between NR pin and GND.

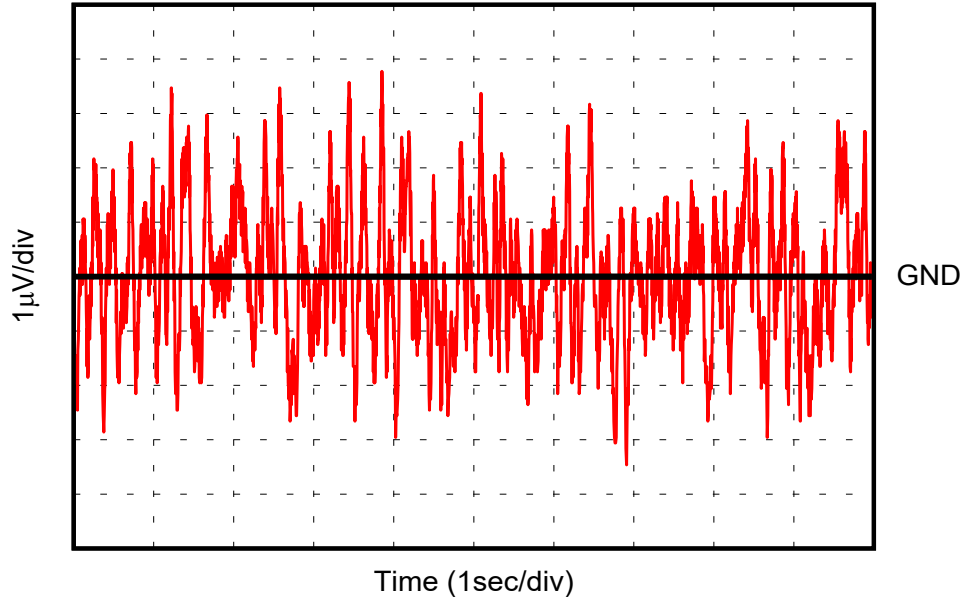

图 7-13. 0.1Hz to 10Hz Noise Distribution vs Load Conditions



图 7-14. 0.1Hz to 10Hz Noise Distribution vs NR Capacitance

### 7.5.2 Broadband Noise

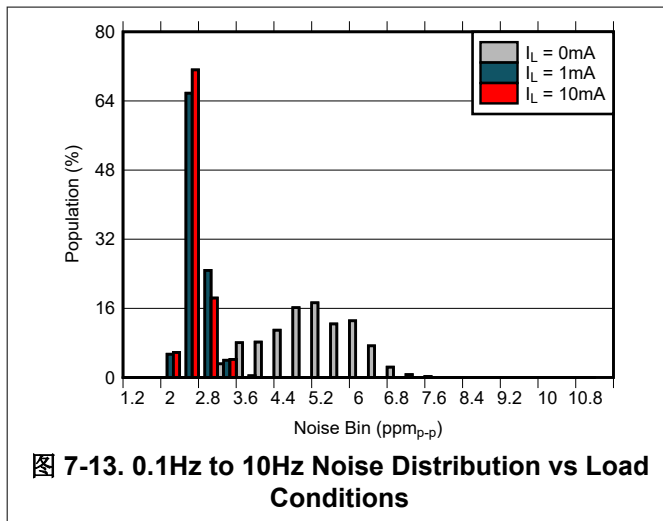
Broadband noise is a noise that appears at higher frequency compared to 1/f noise. The broadband noise is measured by high-pass filtering the output of the reference device, followed by a gain stage and measuring the result on a spectrum analyzer as shown in 图 7-15.

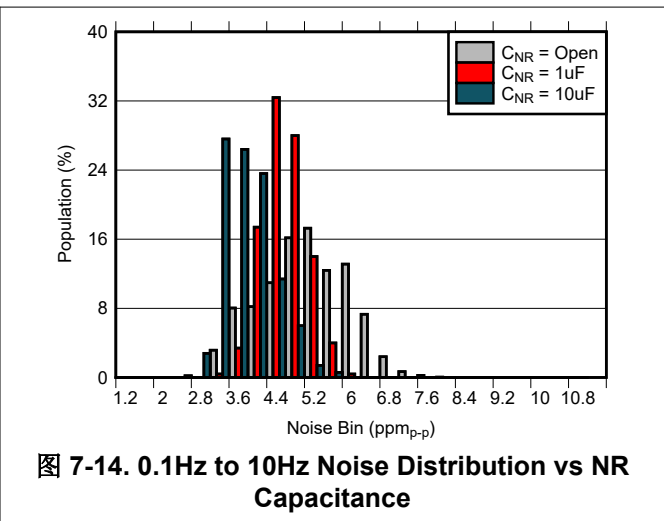

图 7-15. Broadband Noise Test Setup

For noise sensitive designs, a low-pass filter can be used to reduce broadband output noise. When designing a low-pass filter, take special care to make sure the output impedance of the filter does not degrade AC performance. This can occur in RC low-pass filters where a large series resistance can impact the load transients due to output current fluctuations. The REF35 device also offers noise reduction functionality by adding an optional capacitor between NR (pin 5) and ground pins. 图 7-16 和 图 7-17 show the noise spectrum for REF35250 and REF35500 devices respectively across various load capacitance.

图 7-16. Noise Spectrum 10Hz to 100kHz ( $V_{REF} = 2.5V$ )图 7-17. Noise Spectrum 10Hz to 100kHz ( $V_{REF} = 5V$ )

## 7.6 Power Dissipation

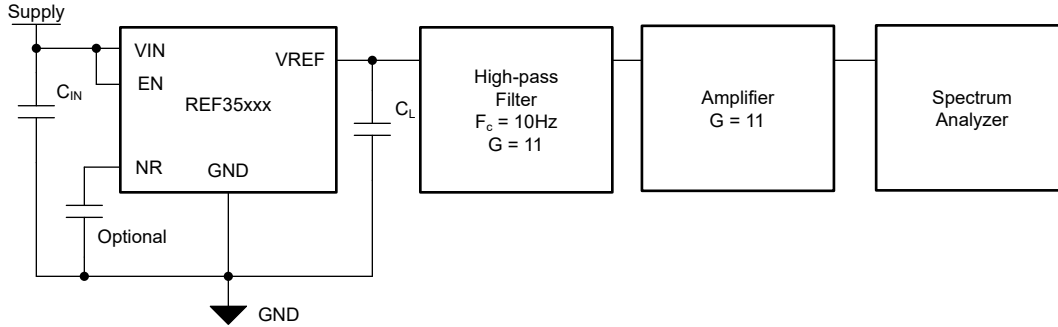
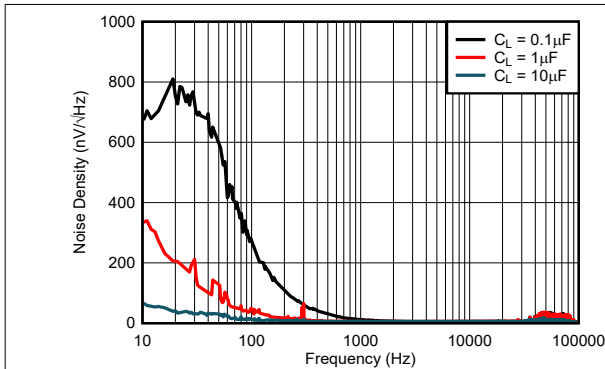
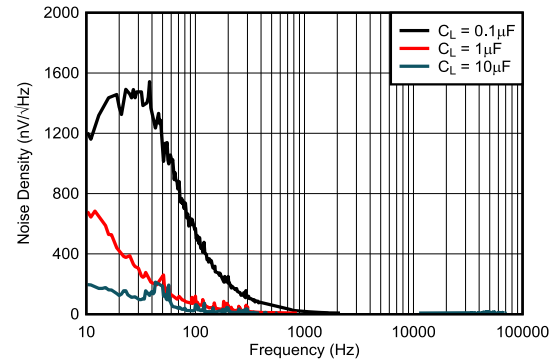
The REF35 voltage references are capable of source up to 10mA and sink up to 5mA of load current across the rated input voltage range. However, when used in applications subject to high ambient temperatures, the input voltage and load current must be carefully monitored to make sure that the device does not exceed its maximum power dissipation rating. The maximum power dissipation of the device can be calculated with 方程式 3:

$$T_J = T_A + P_D \times R_{\theta JA} \quad (3)$$

where

- $P_D$  is the device power dissipation
- $T_J$  is the device junction temperature
- $T_A$  is the ambient temperature
- $R_{\theta JA}$  is the package (junction-to-air) thermal resistance

Because of this relationship, acceptable load current in high temperature conditions can be less than the maximum current-sourcing capability of the device. In no case must the device be operated outside of its maximum power rating because doing so can result in premature failure or permanent damage to the device.

## 8 Detailed Description

### 8.1 Overview

The REF35 is family of ultra-low current, low-noise, precision band-gap voltage references that are specifically designed for excellent initial voltage accuracy and drift. The [Functional Block Diagram](#) is a simplified block diagram of the REF35 showing basic band-gap topology.

### 8.2 Functional Block Diagram

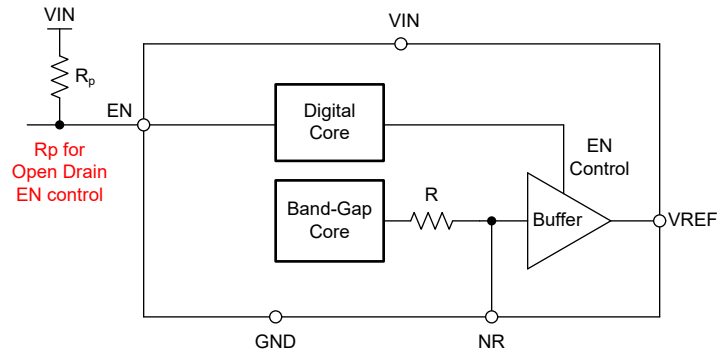

### 8.3 Feature Description

#### 8.3.1 Supply Voltage

The REF35 family of references features an extremely low dropout voltage. For 10mA loaded conditions, a maximum dropout voltage is 250mV. [Figure 6-34](#) shows a typical dropout voltage ( $V_{DO}$ ) versus load current. The device supports operation with input voltage range from  $V_{REF} + V_{DO}$  to 6V. The typical quiescent current is 650nA and maximum quiescent current over temperature is only 2.6  $\mu$ A. The low dropout voltage coupled with ultra-low current enable the operation across multiple battery powered applications.

#### 8.3.2 EN Pin

The REF35 family supports device enable and disable functionality through logic level control on EN pin. The EN pin of REF35 does not use an internal pull-up resistor. Instead, the pin uses new 'clean EN' technology. This allows the EN pin to be in a no connect condition at start-up, and no extra current is drawn from the supply when the EN pin is pulled low in shutdown mode. When EN pin is pulled high or left unconnected at start-up, the device is in active mode. When EN pin is driven by an open-drain output, a pull-up resistor to VIN is required. The device must be in active mode for normal operation. The EN pin must not be pulled higher than VIN supply voltage.

The device can be placed in shutdown mode by pulling the EN pin low. When in shutdown mode, the output of the device becomes high impedance and the quiescent current of the device drops to 100nA at room temperature. When changing the device state from shutdown to active state, make sure the EN pin is not left floating.

Also note that for applications where EN pin is no-connect, total parasitic capacitance on EN pin must be restricted within 30pF.

See the [Electrical Characteristics](#) table for logic high and logic low voltage levels.

#### 8.3.3 NR Pin

The REF35 pin allows access to the band-gap through the NR pin. Placing a capacitor from the NR pin to GND creates a low-pass filter in combination with the internal resistance of 60 k $\Omega$ . Leakage of the capacitance directly impacts the accuracy and temperature drift. If NR functionality is used, choose a low leakage capacitor. A capacitance of 1  $\mu$ F creates a low-pass filter with corner frequency around 2.7Hz. Such a filter decreases the overall noise on the VREF pin. Higher capacitance results in a lower filter cut off frequency, further reducing output noise. Please note, using the capacitor on NR pin also increases start-up time.

## 8.4 Device Functional Modes

### 8.4.1 Basic Connections

图 8-1 shows the typical connections for the REF35. TI recommends a supply bypass capacitor ( $C_{IN}$ ) ranging from  $0.1 \mu\text{F}$  to  $10 \mu\text{F}$ . A  $0.1 \mu\text{F}$  to  $10 \mu\text{F}$  output capacitor ( $C_L$ ) must be connected from REF to GND. The equivalent series resistance (ESR) value of  $C_L$  must be lower than  $400\text{m}\Omega$  to verify output stability.



图 8-1. Basic Connections

### 8.4.2 Start-Up

图 8-2 shows the start-up behavior of REF35250 device with  $1 \mu\text{F}$  load capacitance. REF35 device verifies the output voltage settles to the expected output voltage within specified accuracy without oscillations. The start-up time is dependent on the output voltage variant, output capacitance and NR pin capacitance. Higher capacitance leads to longer start-up time.

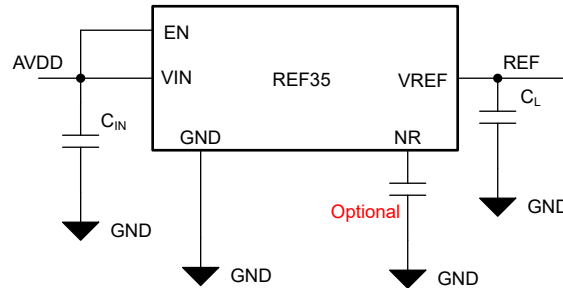

图 8-2. REF35250 Start-Up Behavior,  $C_L = 1 \mu\text{F}$

### 8.4.3 Output Transient Behavior

The REF35 output buffer is capable of sourcing  $10\text{mA}$  load current as well as sink  $5\text{mA}$  of load current. The output stage is designed using class AB architecture with ultra-low quiescent current. This architecture avoids the dead zone around the no load condition. The output buffer uses a fast start-up implementation to achieve  $2\text{ms}$  typical turn-on time at  $C_L = 1 \mu\text{F}$  and no-load current condition.

图 8-3 and 图 8-4 show the output settling behavior for light load transient and high load transient respectively.

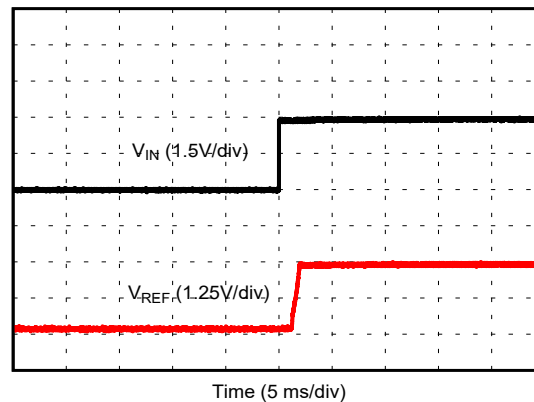

图 8-3. Load Transient Response  $0\mu\text{A}$  to  $100\mu\text{A}$ ,  $C_L = 1\mu\text{F}$



图 8-4. Load Transient Response  $1\text{mA}$  to  $10\text{mA}$ ,  $C_L = 1\mu\text{F}$

## 9 Application and Implementation

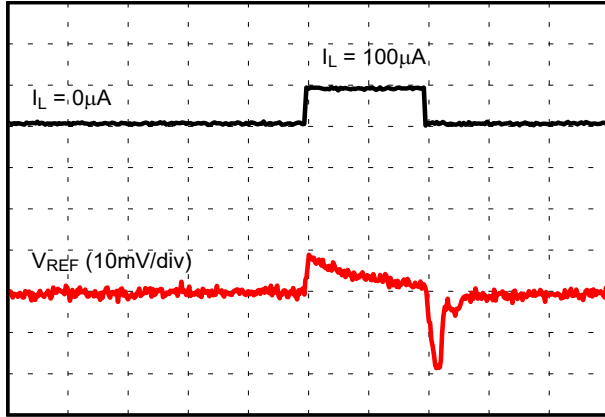
### 备注

Information in the following applications sections is not part of the TI component specification, and TI does not warrant its accuracy or completeness. TI's customers are responsible for determining suitability of components for their purposes. Customers should validate and test their design implementation to confirm system functionality.

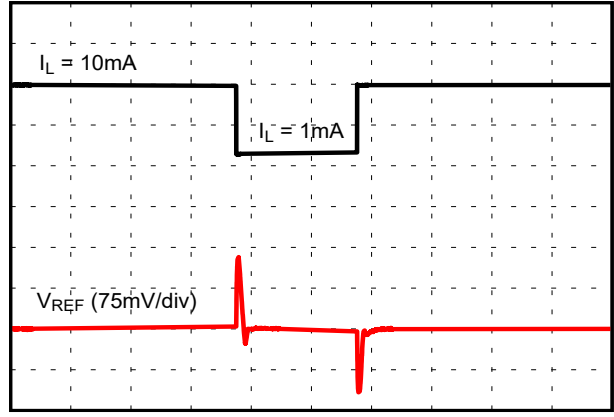
### 9.1 Application Information

REF35 with low current consumption and class leading performance specifications is suitable reference for multiple applications. The device can also be used as a precision low noise power supply to sensor or data converter instead of traditional LDO or DC/DC based power supply. Basic applications includes positive/negative voltage reference and data acquisition systems. The table below shows the typical application of REF35 and its companion ADC/DAC.

表 9-1. Typical Applications and Companion ADC/DAC

APPLICATIONS	ADC/DAC
PLC - DCS	ADS7028, DAC8881, ADS1287, ADS7953
Rack Server	ADS7028, ADS7128, ADS7138
Field Transmitters - Pressure, Flow	ADS124S08
Optical Module, Optical Line Card	ADS7066, ADS7138
Power quality analyzer	ADC3662
Thermal imaging	ADC3541

### 9.2 Typical Applications

#### 9.2.1 Negative Reference Voltage

For applications requiring a negative and positive reference voltage, the REF35 and OPA735 can be used to provide a dual-supply reference from a 5V supply. 图 9-1 shows the REF35250 used to provide a 2.5V supply reference voltage. The low drift performance of the REF35250 complements the low offset voltage and zero drift of the OPA735 to provide an accurate solution for split-supply applications. Take care to match the temperature coefficients of R1 and R2.



图 9-1. REF35 and OPA735 Create Positive and Negative Reference Voltages



## 9.2.2 Precision Power Supply and Reference

图 9-2 shows the basic configuration for the REF35 device as precision power supply to ADS7038 data converter which uses its power supply AVDD as reference. Connect bypass capacitors according to the guidelines in the [Input and Output Capacitors](#) section.

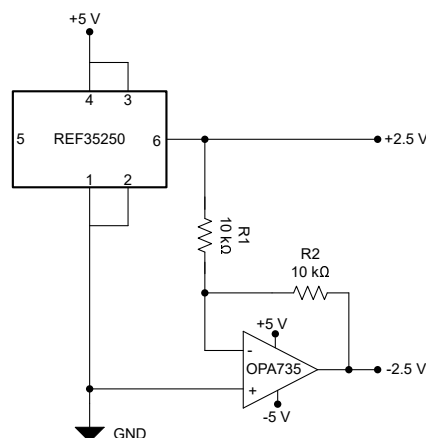

图 9-2. Basic Reference Connection

### 9.2.2.1 Design Requirements

A detailed design procedure is described based on a design example. For this design example, use the parameters listed in 表 9-2 as the input parameters.

表 9-2. Design Example Parameters

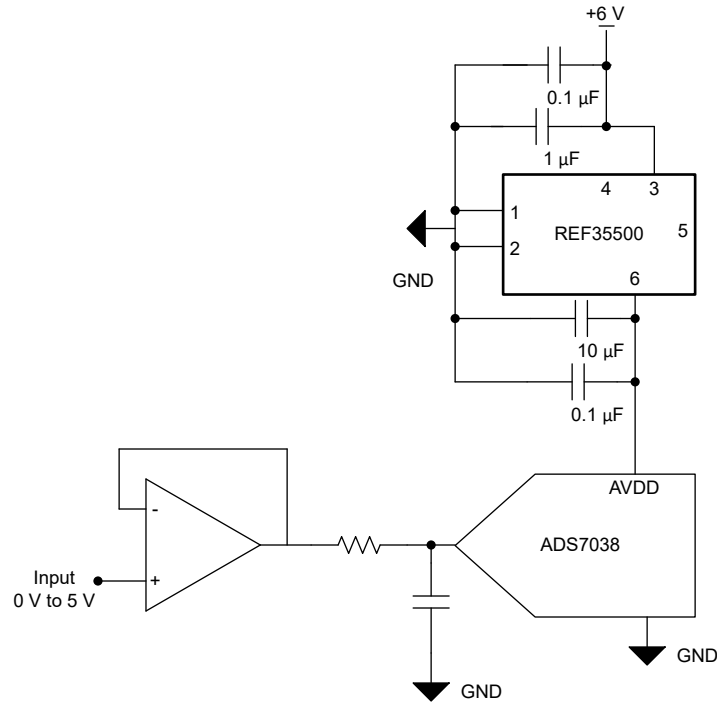
DESIGN PARAMETER	VALUE
Input voltage range $V_{IN}$	0V - 5V
Output resolution	12-bit
REF35 input capacitor	1µF
REF35 output capacitor	10µF

### 9.2.2.2 Detailed Design Procedure

#### 9.2.2.2.1 Selection of Reference

The REF35500 reference is selected for this design. The REF35500 device operates of very low quiescent current while offering  $\pm 0.05\%$  initial accuracy and very low noise. These parameters help improve system accuracy as compared to external LDO based power supply. The 5V reference voltage supports the 0V to 5V input range specification.

#### 9.2.2.2.2 Input and Output Capacitors

A 1 µF to 10 µF electrolytic or ceramic capacitor can be connected to the input to improve transient response in applications where the supply voltage may fluctuate.

A ceramic capacitor of at least a 0.1  $\mu$ F must be connected to the output to improve stability and help filter out high frequency noise. Add an additional 10  $\mu$ F capacitor in parallel to improve transient performance in response to sudden changes in load current; however, keep in mind that doing so increases the start-up time of the device.

Best performance and stability is attained with low-ESR, low-inductance ceramic chip-type output capacitors (X5R, X7R, or similar). If using an electrolytic capacitor on the output, place a 0.1  $\mu$ F ceramic capacitor in parallel to reduce overall ESR on the output. Place the input and output capacitors as close as possible to the device.

#### 9.2.2.2.3 Selection of ADC

**ADS7038** 12-bit 8 channel multiplexed ADC is chosen for this application. The ADC offers low current operation with averaging mode to increase the resolution to 16-bit with internal averaging modes while operating with slow sampling speed.

#### 9.2.2.3 Application Curves

表 9-3 和 图 9-3 show the captured measurement results for various DC inputs. The ADC output is captured and analyzed for output accuracy error and code spread with REF35500 as power supply versus LDO as power supply.

REF35 offers better accuracy and lower noise than the LDO device at lower quiescent current. This results in lower error in measurement as well as lower ADC output code variation across various OSR settings.

**表 9-3. DC Input Performance Test Results**

INPUT V	ADC OSR SETTING	REF35500		LDO	
		ERROR	CODE SPREAD	ERROR	CODE SPREAD
1.0V	0	0.01mV	32 LSB	8.9mV	48 LSB
	8	0.3mV	10 LSB	9.21mV	16 LSB
	128	0.38mV	6 LSB	9.26mV	6 LSB
2.5V	0	0.69mV	32 LSB	22.89mV	64 LSB
	8	1.44mV	10 LSB	23.63mV	18 LSB
	128	1.17mV	3 LSB	23.41mV	5 LSB
4V	0	2.27mV	32 LSB	37.84mV	48 LSB
	8	3.01mV	24 LSB	38.62mV	24 LSB
	128	2.46mV	3 LSB	38.09mV	17 LSB



图 9-3. Error vs Input Voltage

### 9.3 Power Supply Recommendations

The REF35 family of references feature an extremely low-dropout voltage. These references can be operated with a supply of only 50mV above the output voltage at no load. TI recommends a supply bypass capacitor ranging between 0.1 $\mu$ F to 10 $\mu$ F.

### 9.4 Layout

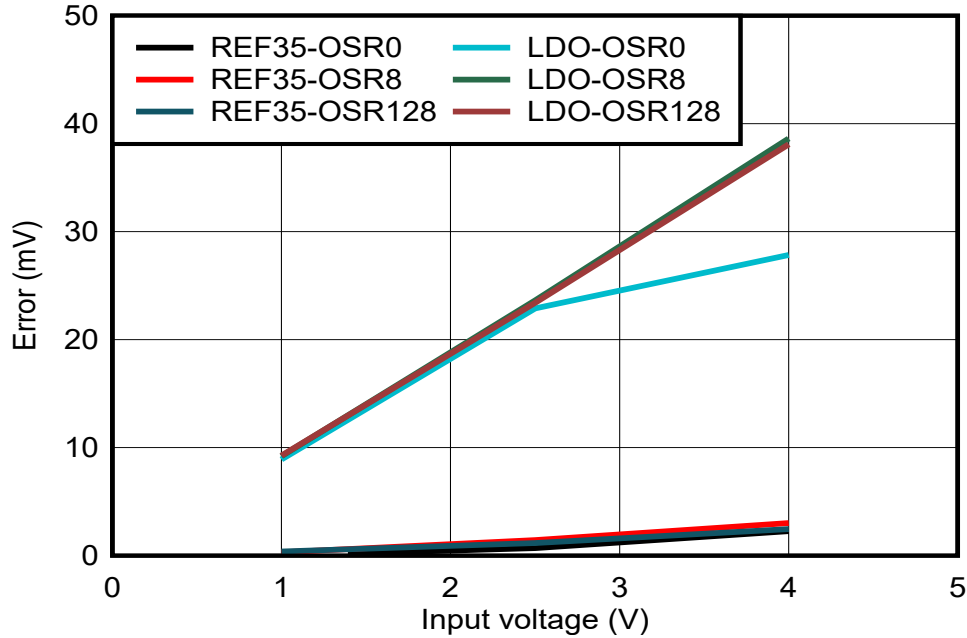
#### 9.4.1 Layout Guidelines

图 9-4 shows an example of a PCB layout for a data acquisition system using the REF35. Some key considerations are:

- Connect low-ESR, 0.1  $\mu$  F ceramic bypass capacitors at  $V_{IN}$ ,  $V_{REF}$  of the REF35.
- Decouple other active devices in the system per the device specifications.
- Using a solid ground plane helps distribute heat and reduces electromagnetic interference (EMI) noise pickup.
- Place the external components as close to the device as possible.
- Do not run sensitive analog traces in parallel with digital traces. Avoid crossing digital and analog traces if possible, and only make perpendicular crossings when absolutely necessary.

图 9-5 shows the pin compatibility with TI REF30xx, REF31xx and REF33xx series references in the 3-pin SOT-23 package when using the REF35xxx family footprint. You must rotate the REF30xx, REF31xx and REF33xx reference devices by 180° before assembly.

### 9.4.2 Layout Examples

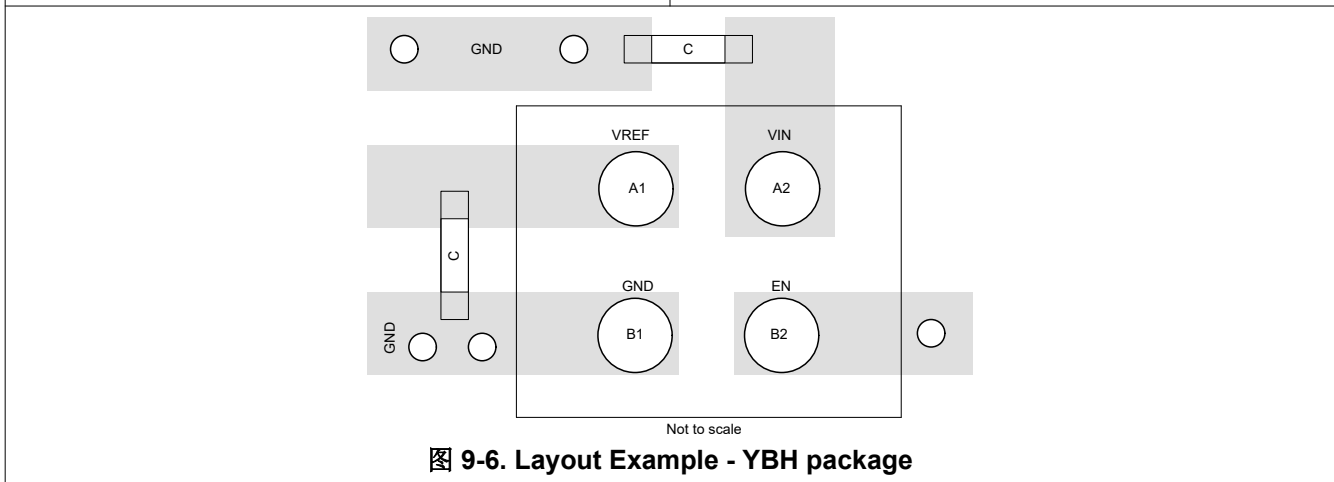
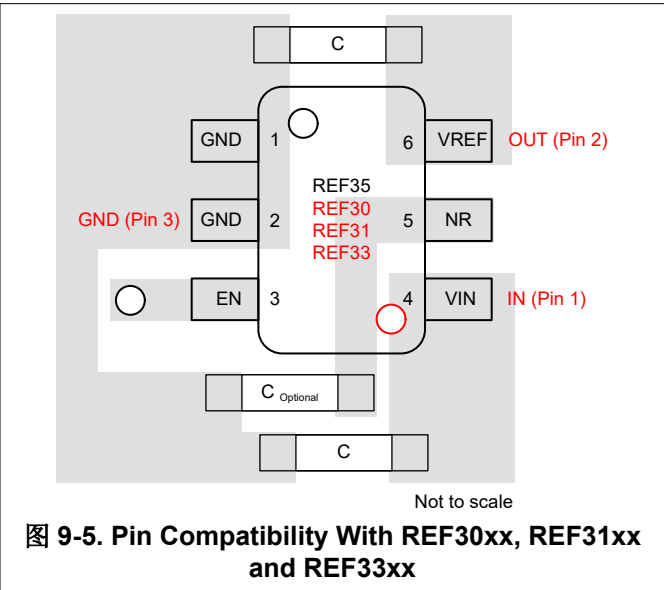
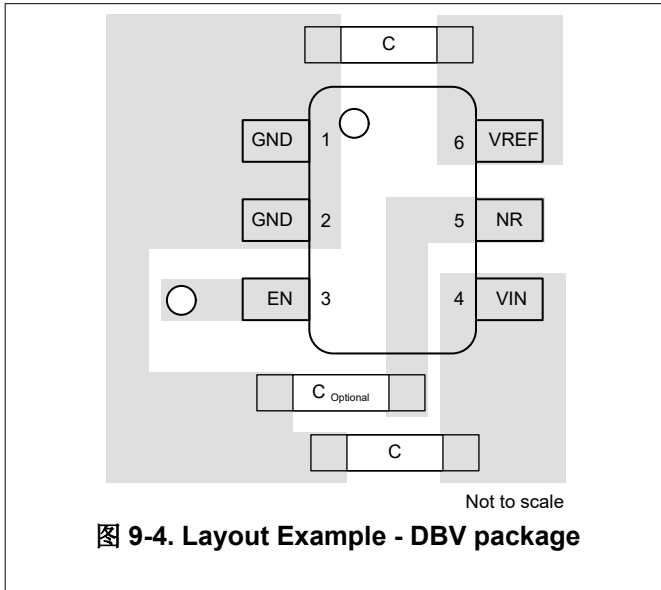

## 10 Device and Documentation Support

### 10.1 Documentation Support

#### 10.1.1 Related Documentation

For related documentation see the following:

- Texas Instruments, [INA21x Voltage Output, Low- or High-Side Measurement, Bidirectional, Zero-Drift Series, Current-Shunt Monitors data sheet](#)
- Texas Instruments, [Low-Drift Bidirectional Single-Supply Low-Side Current Sensing Reference Design](#)
- Texas Instruments, [Precision voltage references Analog Design Journal](#)

### 10.2 接收文档更新通知

要接收文档更新通知，请导航至 [ti.com](https://www.ti.com) 上的器件产品文件夹。点击 [通知](#) 进行注册，即可每周接收产品信息更改摘要。有关更改的详细信息，请查看任何已修订文档中包含的修订历史记录。

### 10.3 支持资源

[TI E2E™ 中文支持论坛](#) 是工程师的重要参考资料，可直接从专家处获得快速、经过验证的解答和设计帮助。搜索现有解答或提出自己的问题，获得所需的快速设计帮助。

链接的内容由各个贡献者“按原样”提供。这些内容并不构成 TI 技术规范，并且不一定反映 TI 的观点；请参阅 TI 的 [使用条款](#)。

### 10.4 Trademarks

TI E2E™ is a trademark of Texas Instruments.

所有商标均为其各自所有者的财产。

### 10.5 静电放电警告



静电放电 (ESD) 会损坏这个集成电路。德州仪器 (TI) 建议通过适当的预防措施处理所有集成电路。如果不遵守正确的处理和安装程序，可能会损坏集成电路。

ESD 的损坏小至导致微小的性能降级，大至整个器件故障。精密的集成电路可能更容易受到损坏，这是因为非常细微的参数更改都可能会导致器件与其发布的规格不相符。

### 10.6 术语表

[TI 术语表](#) 本术语表列出并解释了术语、首字母缩略词和定义。

## 11 Revision History

注：以前版本的页码可能与当前版本的页码不同

Changes from Revision A (August 2022) to Revision B (April 2024)	Page
• 添加了 WCSP 封装的特性说明.....	1
• 删除了 WCSP 封装的产品预发布状态.....	1
• Added REF35170QBVR & REF35360QDBVR devices as released variant. Updated the WCSP device release options.....	3
• Added more details to device pin external connections.....	3
• Added YBH package performance details.....	6
• Added typical characteristics for WCSP package.....	8

---

**Changes from Revision \* (December 2021) to Revision A (August 2022)**

**Page**

---

• 量产数据发布.....	1
---------------	---

---

## **12 Mechanical, Packaging, and Orderable Information**

The following pages include mechanical packaging and orderable information. This information is the most current data available for the designated devices. This data is subject to change without notice and revision of this document. For browser-based versions of this data sheet, refer to the left-hand navigation.

**PACKAGING INFORMATION**

Orderable Device	Status (1)	Package Type	Package Drawing	Pins	Package Qty	Eco Plan (2)	Lead finish/ Ball material (6)	MSL Peak Temp (3)	Op Temp (°C)	Device Marking (4/5)	Samples
PREF35125YBHR	ACTIVE	DSBGA	YBH	4	12000	RoHS & Green	SNAGCU	Level-1-260C-UNLIM	-40 to 125	P	<a href="#">Samples</a>
REF35102QDBVR	ACTIVE	SOT-23	DBV	6	3000	RoHS & Green	NIPDAUAG	Level-2-260C-1 YEAR	-40 to 125	2RTI	<a href="#">Samples</a>
REF35102YBHR	ACTIVE	DSBGA	YBH	4	12000	RoHS & Green	SNAGCU	Level-1-260C-UNLIM	-40 to 125	M	<a href="#">Samples</a>
REF35120QDBVR	ACTIVE	SOT-23	DBV	6	3000	RoHS & Green	NIPDAUAG	Level-2-260C-1 YEAR	-40 to 125	2RVI	<a href="#">Samples</a>
REF35120YBHR	ACTIVE	DSBGA	YBH	4	12000	RoHS & Green	SNAGCU	Level-1-260C-UNLIM	-40 to 125	A	<a href="#">Samples</a>
REF35125QDBVR	ACTIVE	SOT-23	DBV	6	3000	RoHS & Green	NIPDAUAG	Level-2-260C-1 YEAR	-40 to 125	2RUI	<a href="#">Samples</a>
REF35125YBHR	ACTIVE	DSBGA	YBH	4	12000	RoHS & Green	SNAGCU	Level-1-260C-UNLIM	-40 to 125	L	<a href="#">Samples</a>
REF35160QDBVR	ACTIVE	SOT-23	DBV	6	3000	RoHS & Green	NIPDAUAG	Level-2-260C-1 YEAR	-40 to 125	2UII	<a href="#">Samples</a>
REF35160YBHR	ACTIVE	DSBGA	YBH	4	12000	RoHS & Green	SNAGCU	Level-1-260C-UNLIM	-40 to 125	C	<a href="#">Samples</a>
REF35170QDBVR	ACTIVE	SOT-23	DBV	6	3000	RoHS & Green	NIPDAUAG	Level-2-260C-1 YEAR	-40 to 125	31QI	<a href="#">Samples</a>
REF35180QDBVR	ACTIVE	SOT-23	DBV	6	3000	RoHS & Green	NIPDAUAG	Level-2-260C-1 YEAR	-40 to 125	2J2I	<a href="#">Samples</a>
REF35180YBHR	ACTIVE	DSBGA	YBH	4	12000	RoHS & Green	SNAGCU	Level-1-260C-UNLIM	-40 to 125	9	<a href="#">Samples</a>
REF35205QDBVR	ACTIVE	SOT-23	DBV	6	3000	RoHS & Green	NIPDAUAG	Level-2-260C-1 YEAR	-40 to 125	2UKI	<a href="#">Samples</a>
REF35250QDBVR	ACTIVE	SOT-23	DBV	6	3000	RoHS & Green	NIPDAUAG	Level-2-260C-1 YEAR	-40 to 125	2RSI	<a href="#">Samples</a>
REF35250YBHR	ACTIVE	DSBGA	YBH	4	12000	RoHS & Green	SNAGCU	Level-1-260C-UNLIM	-40 to 125	B	<a href="#">Samples</a>
REF35300QDBVR	ACTIVE	SOT-23	DBV	6	3000	RoHS & Green	NIPDAUAG	Level-2-260C-1 YEAR	-40 to 125	2SLI	<a href="#">Samples</a>
REF35300YBHR	ACTIVE	DSBGA	YBH	4	12000	RoHS & Green	SNAGCU	Level-1-260C-UNLIM	-40 to 125	S	<a href="#">Samples</a>
REF35330QDBVR	ACTIVE	SOT-23	DBV	6	3000	RoHS & Green	NIPDAUAG	Level-2-260C-1 YEAR	-40 to 125	2ULI	<a href="#">Samples</a>
REF35360QDBVR	ACTIVE	SOT-23	DBV	6	3000	RoHS & Green	NIPDAUAG	Level-2-260C-1 YEAR	-40 to 125	31RI	<a href="#">Samples</a>
REF35409QDBVR	ACTIVE	SOT-23	DBV	6	3000	RoHS & Green	NIPDAUAG	Level-2-260C-1 YEAR	-40 to 125	2UMI	<a href="#">Samples</a>

Orderable Device	Status (1)	Package Type	Package Drawing	Pins	Package Qty	Eco Plan (2)	Lead finish/ Ball material (6)	MSL Peak Temp (3)	Op Temp (°C)	Device Marking (4/5)	Samples
REF35409YBHR	ACTIVE	DSBGA	YBH	4	12000	RoHS & Green	SNAGCU	Level-1-260C-UNLIM	-40 to 125	T	<a href="#">Samples</a>
REF35500QDBVR	ACTIVE	SOT-23	DBV	6	3000	RoHS & Green	NIPDAUAG	Level-2-260C-1 YEAR	-40 to 125	2RWI	<a href="#">Samples</a>

(1) The marketing status values are defined as follows:

**ACTIVE:** Product device recommended for new designs.

**LIFEBUY:** TI has announced that the device will be discontinued, and a lifetime-buy period is in effect.

**NRND:** Not recommended for new designs. Device is in production to support existing customers, but TI does not recommend using this part in a new design.

**PREVIEW:** Device has been announced but is not in production. Samples may or may not be available.

**OBSOLETE:** TI has discontinued the production of the device.

(2) **RoHS:** TI defines "RoHS" to mean semiconductor products that are compliant with the current EU RoHS requirements for all 10 RoHS substances, including the requirement that RoHS substance do not exceed 0.1% by weight in homogeneous materials. Where designed to be soldered at high temperatures, "RoHS" products are suitable for use in specified lead-free processes. TI may reference these types of products as "Pb-Free".

**RoHS Exempt:** TI defines "RoHS Exempt" to mean products that contain lead but are compliant with EU RoHS pursuant to a specific EU RoHS exemption.

**Green:** TI defines "Green" to mean the content of Chlorine (Cl) and Bromine (Br) based flame retardants meet JS709B low halogen requirements of <=1000ppm threshold. Antimony trioxide based flame retardants must also meet the <=1000ppm threshold requirement.

(3) MSL, Peak Temp. - The Moisture Sensitivity Level rating according to the JEDEC industry standard classifications, and peak solder temperature.

(4) There may be additional marking, which relates to the logo, the lot trace code information, or the environmental category on the device.

(5) Multiple Device Markings will be inside parentheses. Only one Device Marking contained in parentheses and separated by a "~" will appear on a device. If a line is indented then it is a continuation of the previous line and the two combined represent the entire Device Marking for that device.

(6) Lead finish/Ball material - Orderable Devices may have multiple material finish options. Finish options are separated by a vertical ruled line. Lead finish/Ball material values may wrap to two lines if the finish value exceeds the maximum column width.

**Important Information and Disclaimer:**The information provided on this page represents TI's knowledge and belief as of the date that it is provided. TI bases its knowledge and belief on information provided by third parties, and makes no representation or warranty as to the accuracy of such information. Efforts are underway to better integrate information from third parties. TI has taken and continues to take reasonable steps to provide representative and accurate information but may not have conducted destructive testing or chemical analysis on incoming materials and chemicals. TI and TI suppliers consider certain information to be proprietary, and thus CAS numbers and other limited information may not be available for release.

In no event shall TI's liability arising out of such information exceed the total purchase price of the TI part(s) at issue in this document sold by TI to Customer on an annual basis.

**OTHER QUALIFIED VERSIONS OF REF35 :**



- Automotive : [REF35-Q1](#)

NOTE: Qualified Version Definitions:

- Automotive - Q100 devices qualified for high-reliability automotive applications targeting zero defects

**TAPE AND REEL INFORMATION**

**QUADRANT ASSIGNMENTS FOR PIN 1 ORIENTATION IN TAPE**

\*All dimensions are nominal

Device	Package Type	Package Drawing	Pins	SPQ	Reel Diameter (mm)	Reel Width W1 (mm)	A0 (mm)	B0 (mm)	K0 (mm)	P1 (mm)	W (mm)	Pin1 Quadrant
REF35102QDBVR	SOT-23	DBV	6	3000	180.0	8.4	3.23	3.17	1.37	4.0	8.0	Q3
REF35102YBHR	DSBGA	YBH	4	12000	180.0	8.4	0.94	1.17	0.45	2.0	8.0	Q2
REF35120QDBVR	SOT-23	DBV	6	3000	180.0	8.4	3.23	3.17	1.37	4.0	8.0	Q3
REF35120YBHR	DSBGA	YBH	4	12000	180.0	8.4	0.94	1.17	0.45	2.0	8.0	Q2
REF35125QDBVR	SOT-23	DBV	6	3000	180.0	8.4	3.23	3.17	1.37	4.0	8.0	Q3
REF35125YBHR	DSBGA	YBH	4	12000	180.0	8.4	0.94	1.17	0.45	2.0	8.0	Q2
REF35160QDBVR	SOT-23	DBV	6	3000	180.0	8.4	3.23	3.17	1.37	4.0	8.0	Q3
REF35160YBHR	DSBGA	YBH	4	12000	180.0	8.4	0.94	1.17	0.45	2.0	8.0	Q2
REF35170QDBVR	SOT-23	DBV	6	3000	180.0	8.4	3.23	3.17	1.37	4.0	8.0	Q3
REF35180QDBVR	SOT-23	DBV	6	3000	180.0	8.4	3.23	3.17	1.37	4.0	8.0	Q3
REF35180YBHR	DSBGA	YBH	4	12000	180.0	8.4	0.94	1.17	0.45	2.0	8.0	Q2
REF35205QDBVR	SOT-23	DBV	6	3000	180.0	8.4	3.23	3.17	1.37	4.0	8.0	Q3
REF35250QDBVR	SOT-23	DBV	6	3000	180.0	8.4	3.23	3.17	1.37	4.0	8.0	Q3
REF35250YBHR	DSBGA	YBH	4	12000	180.0	8.4	0.94	1.17	0.45	2.0	8.0	Q2
REF35300QDBVR	SOT-23	DBV	6	3000	180.0	8.4	3.23	3.17	1.37	4.0	8.0	Q3
REF35300YBHR	DSBGA	YBH	4	12000	180.0	8.4	0.94	1.17	0.45	2.0	8.0	Q2

Device	Package Type	Package Drawing	Pins	SPQ	Reel Diameter (mm)	Reel Width W1 (mm)	A0 (mm)	B0 (mm)	K0 (mm)	P1 (mm)	W (mm)	Pin1 Quadrant
REF35330QDBVR	SOT-23	DBV	6	3000	180.0	8.4	3.23	3.17	1.37	4.0	8.0	Q3
REF35360QDBVR	SOT-23	DBV	6	3000	180.0	8.4	3.23	3.17	1.37	4.0	8.0	Q3
REF35409QDBVR	SOT-23	DBV	6	3000	180.0	8.4	3.23	3.17	1.37	4.0	8.0	Q3
REF35409YBHR	DSBGA	YBH	4	12000	180.0	8.4	0.94	1.17	0.45	2.0	8.0	Q2
REF35500QDBVR	SOT-23	DBV	6	3000	180.0	8.4	3.23	3.17	1.37	4.0	8.0	Q3

## TAPE AND REEL BOX DIMENSIONS



\*All dimensions are nominal

Device	Package Type	Package Drawing	Pins	SPQ	Length (mm)	Width (mm)	Height (mm)
REF35102QDBVR	SOT-23	DBV	6	3000	213.0	191.0	35.0
REF35102YBHR	DSBGA	YBH	4	12000	182.0	182.0	20.0
REF35120QDBVR	SOT-23	DBV	6	3000	213.0	191.0	35.0
REF35120YBHR	DSBGA	YBH	4	12000	182.0	182.0	20.0
REF35125QDBVR	SOT-23	DBV	6	3000	213.0	191.0	35.0
REF35125YBHR	DSBGA	YBH	4	12000	182.0	182.0	20.0
REF35160QDBVR	SOT-23	DBV	6	3000	213.0	191.0	35.0
REF35160YBHR	DSBGA	YBH	4	12000	182.0	182.0	20.0
REF35170QDBVR	SOT-23	DBV	6	3000	213.0	191.0	35.0
REF35180QDBVR	SOT-23	DBV	6	3000	213.0	191.0	35.0
REF35180YBHR	DSBGA	YBH	4	12000	182.0	182.0	20.0
REF35205QDBVR	SOT-23	DBV	6	3000	213.0	191.0	35.0
REF35250QDBVR	SOT-23	DBV	6	3000	213.0	191.0	35.0
REF35250YBHR	DSBGA	YBH	4	12000	182.0	182.0	20.0
REF35300QDBVR	SOT-23	DBV	6	3000	213.0	191.0	35.0
REF35300YBHR	DSBGA	YBH	4	12000	182.0	182.0	20.0
REF35330QDBVR	SOT-23	DBV	6	3000	213.0	191.0	35.0
REF35360QDBVR	SOT-23	DBV	6	3000	213.0	191.0	35.0

---

Device	Package Type	Package Drawing	Pins	SPQ	Length (mm)	Width (mm)	Height (mm)
REF35409QDBVR	SOT-23	DBV	6	3000	213.0	191.0	35.0
REF35409YBHR	DSBGA	YBH	4	12000	182.0	182.0	20.0
REF35500QDBVR	SOT-23	DBV	6	3000	213.0	191.0	35.0

# DBV0006A



# PACKAGE OUTLINE

SOT-23 - 1.45 mm max height

SMALL OUTLINE TRANSISTOR



4214840/G 08/2024

## NOTES:

1. All linear dimensions are in millimeters. Any dimensions in parenthesis are for reference only. Dimensioning and tolerancing per ASME Y14.5M.
2. This drawing is subject to change without notice.
3. Body dimensions do not include mold flash or protrusion. Mold flash and protrusion shall not exceed 0.25 per side.
4. Leads 1,2,3 may be wider than leads 4,5,6 for package orientation.
5. Reference JEDEC MO-178.

# EXAMPLE BOARD LAYOUT

DBV0006A

SOT-23 - 1.45 mm max height

SMALL OUTLINE TRANSISTOR



LAND PATTERN EXAMPLE  
EXPOSED METAL SHOWN  
SCALE:15X



SOLDER MASK DETAILS

4214840/G 08/2024

NOTES: (continued)

6. Publication IPC-7351 may have alternate designs.

7. Solder mask tolerances between and around signal pads can vary based on board fabrication site.

# EXAMPLE STENCIL DESIGN

DBV0006A

SOT-23 - 1.45 mm max height

SMALL OUTLINE TRANSISTOR



SOLDER PASTE EXAMPLE  
BASED ON 0.125 mm THICK STENCIL  
SCALE:15X

4214840/G 08/2024

NOTES: (continued)

8. Laser cutting apertures with trapezoidal walls and rounded corners may offer better paste release. IPC-7525 may have alternate design recommendations.
9. Board assembly site may have different recommendations for stencil design.



YBH0004



# PACKAGE OUTLINE

DSBGA - 0.4 mm max height

DIE SIZE BALL GRID ARRAY

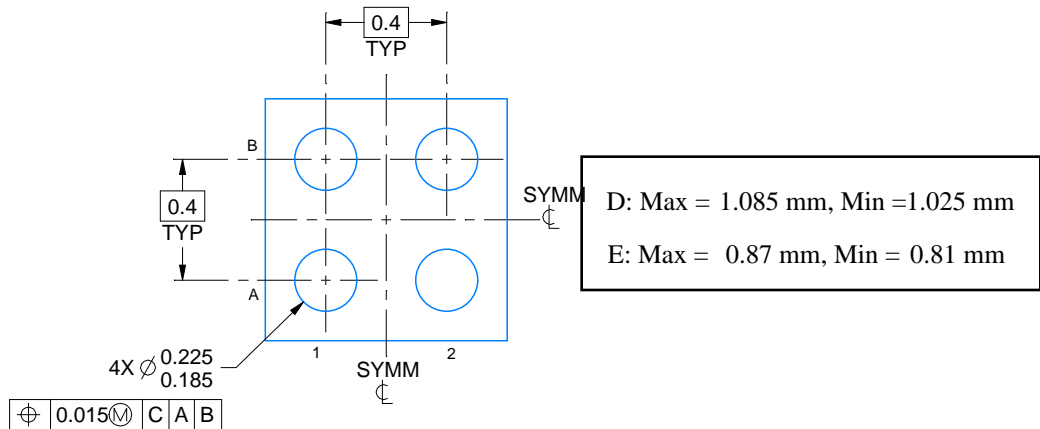
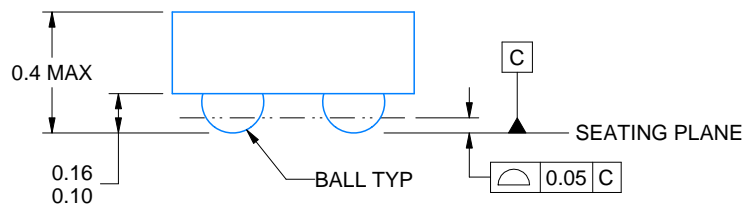
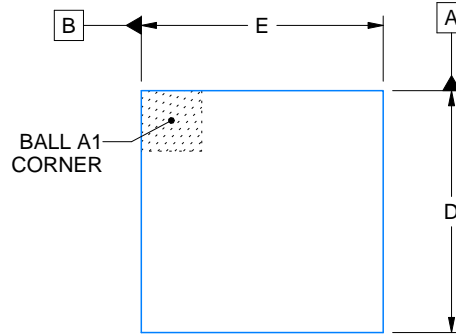

4224051/A 11/2017

NOTES:

- 1. All linear dimensions are in millimeters. Any dimensions in parenthesis are for reference only. Dimensioning and tolerancing per ASME Y14.5M.
- 2. This drawing is subject to change without notice.

# EXAMPLE BOARD LAYOUT

YBH0004

DSBGA - 0.4 mm max height

DIE SIZE BALL GRID ARRAY

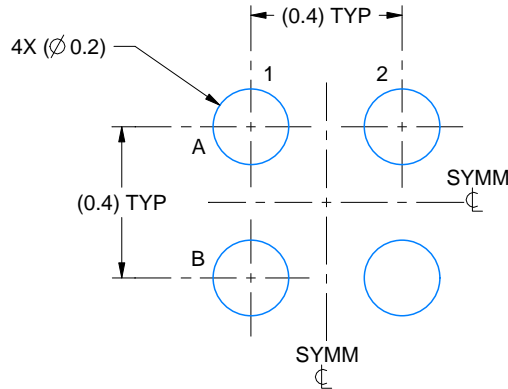

LAND PATTERN EXAMPLE  
EXPOSED METAL SHOWN  
SCALE: 50X

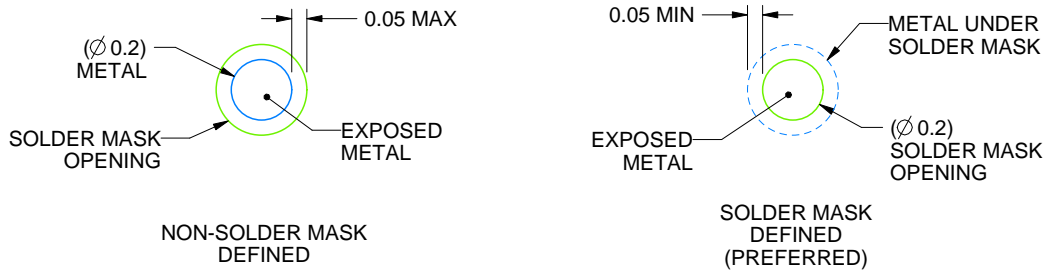

SOLDER MASK DETAILS  
NOT TO SCALE

4224051/A 11/2017

NOTES: (continued)

- Final dimensions may vary due to manufacturing tolerance considerations and also routing constraints. See Texas Instruments Literature No. SNVA009 ([www.ti.com/lit/snva009](http://www.ti.com/lit/snva009)).

# EXAMPLE STENCIL DESIGN

YBH0004

DSBGA - 0.4 mm max height

DIE SIZE BALL GRID ARRAY

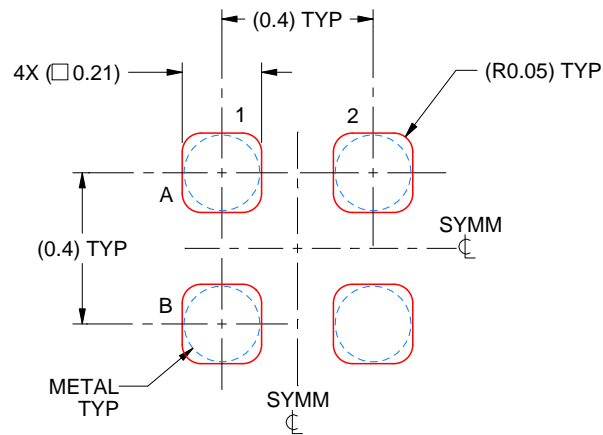

SOLDER PASTE EXAMPLE  
BASED ON 0.075 mm THICK STENCIL  
SCALE: 50X

4224051/A 11/2017

NOTES: (continued)

4. Laser cutting apertures with trapezoidal walls and rounded corners may offer better paste release.

## 重要声明和免责声明

TI“按原样”提供技术和可靠性数据（包括数据表）、设计资源（包括参考设计）、应用或其他设计建议、网络工具、安全信息和其他资源，不保证没有瑕疵且不做任何明示或暗示的担保，包括但不限于对适销性、某特定用途方面的适用性或不侵犯任何第三方知识产权的暗示担保。

这些资源可供使用 TI 产品进行设计的熟练开发人员使用。您将自行承担以下全部责任：(1) 针对您的应用选择合适的 TI 产品，(2) 设计、验证并测试您的应用，(3) 确保您的应用满足相应标准以及任何其他功能安全、信息安全、监管或其他要求。

这些资源如有变更，恕不另行通知。TI 授权您仅可将这些资源用于研发本资源所述的 TI 产品的应用。严禁对这些资源进行其他复制或展示。您无权使用任何其他 TI 知识产权或任何第三方知识产权。您应全额赔偿因在这些资源的使用中对 TI 及其代表造成的任何索赔、损害、成本、损失和债务，TI 对此概不负责。

TI 提供的产品受 [TI 的销售条款](#) 或 [ti.com](#) 上其他适用条款/TI 产品随附的其他适用条款的约束。TI 提供这些资源并不会扩展或以其他方式更改 TI 针对 TI 产品发布的适用的担保或担保免责声明。

TI 反对并拒绝您可能提出的任何其他或不同的条款。

邮寄地址：Texas Instruments, Post Office Box 655303, Dallas, Texas 75265

Copyright © 2024，德州仪器 (TI) 公司