

TL97x Output Rail-To-Rail Very-Low-Noise Operational Amplifiers

1 Features

- Rail-to-Rail Output Voltage Swing: ± 2.4 V at $V_{CC} = \pm 2.5$ V
- Very Low Noise Level: 4 nV/ $\sqrt{\text{Hz}}$
- Ultra-Low Distortion: 0.003%
- High Dynamic Features: 12 MHz, 5 V/ μs
- Operating Range: 2.7 V to 12 V
- Latch-Up Performance Exceeds 100 mA Per JESD 78, Class II
- ESD Performance Tested Per JESD 22
 - 2000-V Human-Body Model
 - 1500-V Charged-Device Model

2 Applications

- Portable Equipment
 - Music Players
 - Tablets
 - Cell Phones
- Instrumentation and Sensors
- Professional Audio Circuits

3 Description

The TL97x family of single, dual, and quad operational amplifiers operates at voltages as low as ± 1.35 V and features output rail-to-rail signal swing. The TL97x boast characteristics that make them particularly well suited for portable and battery-supplied equipment. Very low noise and low distortion characteristics make them ideal for audio preamplification.

The TL971 is housed in the space-saving 5-pin SOT-23 package, which simplifies board design because of the ability to be placed anywhere (outside dimensions are 2.8 mm \times 2.9 mm).

Device Information⁽¹⁾

PART NUMBER	PACKAGE (PIN)	BODY SIZE (NOM)
TL971	SOIC (8)	4.90 mm \times 3.90 mm
	SOT-23 (5)	2.80 mm \times 2.90 mm
TL972	MSOP (8)	3.00 mm \times 3.00 mm
	PDIP (8)	9.60 mm \times 6.40 mm
	SOIC (8)	4.90 mm \times 3.90 mm
	TSSOP (8)	3.00 mm \times 4.40 mm
TL974	PDIP (14)	19.30 mm \times 6.40 mm
	SOIC (14)	8.60 mm \times 3.90 mm
	TSSOP (14)	5.00 mm \times 4.40 mm

(1) For all available packages, see the orderable addendum at the end of the data sheet.

4 Simplified Schematic

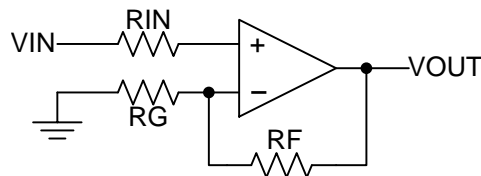

Table of Contents

1 Features	1	8.2 Functional Block Diagram	9
2 Applications	1	8.3 Feature Description	9
3 Description	1	8.4 Device Functional Modes	10
4 Simplified Schematic	1	9 Application and Implementation	11
5 Revision History	2	9.1 Typical Application	11
6 Pin Configuration and Functions	3	10 Power Supply Recommendations	13
7 Specifications	4	11 Layout	13
7.1 Absolute Maximum Ratings	4	11.1 Layout Guidelines	13
7.2 ESD Ratings	4	11.2 Layout Example	13
7.3 Recommended Operating Conditions	4	12 Device and Documentation Support	15
7.4 Thermal Information	4	12.1 Related Links	15
7.5 Electrical Characteristics	5	12.2 Trademarks	15
7.6 Typical Characteristics	5	12.3 Electrostatic Discharge Caution	15
8 Detailed Description	9	12.4 Glossary	15
8.1 Overview	9	13 Mechanical, Packaging, and Orderable Information	15

5 Revision History

Changes from Revision G (May 2012) to Revision H	Page
<ul style="list-style-type: none"> Added <i>Applications</i>, <i>Device Information</i> table, <i>Pin Functions</i> table, <i>ESD Ratings</i> table, <i>Thermal Information</i> table, <i>Typical Characteristics</i>, <i>Feature Description</i> section, <i>Device Functional Modes</i>, <i>Application and Implementation</i> section, <i>Power Supply Recommendations</i> section, <i>Layout</i> section, <i>Device and Documentation Support</i> section, and <i>Mechanical, Packaging, and Orderable Information</i> section. 	1
<ul style="list-style-type: none"> Deleted <i>Ordering Information</i> table. 	1

Changes from Revision F (December 2009) to Revision G	Page
<ul style="list-style-type: none"> Changed slew rate MIN value. 	5

6 Pin Configuration and Functions

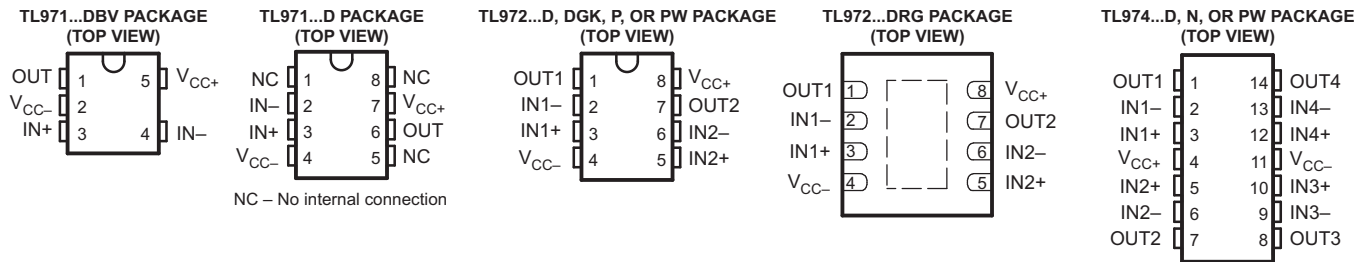

Pin Functions

NAME	PIN					TYPE	DESCRIPTION
	TL971	TL971	TL972		TL974		
	DBV	D	D, DGK, P, PW	DRG	D, N, PW		
IN+	3	3	—	—	—	I	Noninverting input
IN-	4	2	—	—	—	I	Inverting input
IN1+	—	—	3	3	3	I	Noninverting input
IN1-	—	—	2	2	2	I	Inverting input
IN2+	—	—	5	5	5	I	Noninverting input
IN2-	—	—	6	6	6	I	Inverting input
IN3+	—	—	—	—	10	I	Noninverting input
IN3-	—	—	—	—	9	I	Inverting input
IN4+	—	—	—	—	12	I	Noninverting input
IN4-	—	—	—	—	13	I	Inverting input
NC	—	1	—	—	—	—	No Connect
		5					
		8					
OUT	1	6	—	—	—	O	Output
OUT1	—	—	1	1	1	O	Output
OUT2	—	—	7	7	7	O	Output
OUT3	—	—	—	—	8	O	Output
OUT4	—	—	—	—	14	O	Output
V _{CC+}	5	7	8	8	4	-	Positive supply
V _{CC-}	2	4	4	4	11	-	Negative supply

7 Specifications

7.1 Absolute Maximum Ratings

over operating free-air temperature range (unless otherwise noted)⁽¹⁾

		MIN	MAX	UNIT
V _{CC}	Supply voltage range	2.7	15	V
V _{ID}	Differential input voltage ⁽²⁾	±1 V		V
V _{IN}	Input voltage range ⁽³⁾	V _{CC-} – 0.3	V _{CC+} + 0.3	V
T _J	Maximum junction temperature	150		°C
T _{stg}	Storage temperature range	–65	150	°C

- (1) Stresses beyond those listed under *Absolute Maximum Ratings* may cause permanent damage to the device. These are stress ratings only, and functional operation of the device at these or any other conditions beyond those indicated under *Recommended Operating Conditions* is not implied. Exposure to absolute-maximum-rated conditions for extended periods may affect device reliability.
- (2) Differential voltages for the noninverting input terminal are with respect to the inverting input terminal.
- (3) The input and output voltages must never exceed V_{CC} + 0.3 V.

7.2 ESD Ratings

		VALUE	UNIT
V _(ESD)	Electrostatic discharge	Human body model (HBM), per ANSI/ESDA/JEDEC JS-001, all pins ⁽¹⁾	2000
		Charged device model (CDM), per JEDEC specification JESD22-C101, all pins ⁽²⁾	1500

- (1) JEDEC document JEP155 states that 500-V HBM allows safe manufacturing with a standard ESD control process.
- (2) JEDEC document JEP157 states that 250-V CDM allows safe manufacturing with a standard ESD control process.

7.3 Recommended Operating Conditions

		MIN	MAX	UNIT
V _{CC}	Supply voltage	2.7	12	V
V _{ICM}	Common-mode input voltage	V _{CC-} + 1.15	V _{CC+} – 1.15	V
T _A	Operating free-air temperature	–40	125	°C

7.4 Thermal Information

THERMAL METRIC ⁽¹⁾	TL971		TL972					TL974			UNIT	
	D ⁽²⁾	DBV ⁽²⁾	D ⁽²⁾	DGK ⁽³⁾	DRG ⁽³⁾	P ⁽²⁾	PW ⁽²⁾	D ⁽²⁾	N ⁽²⁾	PW ⁽²⁾		
	8 PINS	5 PINS	8 PINS					14 PINS				
R _{θJA}	Package thermal impedance, junction to free air	97	206	97	172	44	85	149	86	80	113	°C/W

- (1) For more information about traditional and new thermal metrics, see the *IC Package Thermal Metrics* application report ([SPRA953](#)).
- (2) Package thermal impedance is calculated in accordance with JESD 51-7.
- (3) Package thermal impedance is calculated in accordance with JESD 51-5.

7.5 Electrical Characteristics

 $V_{CC+} = 2.5\text{ V}$, $V_{CC-} = -2.5\text{ V}$, full-range $T_A = -40^\circ\text{C}$ to 125°C (unless otherwise noted)

PARAMETER		TEST CONDITIONS	T_A	MIN	TYP	MAX	UNIT
V_{IO}	Input offset voltage		25°C		1	4	mV
			Full range			6	
αV_{IO}	Input offset voltage drift	$V_{ICM} = 0\text{ V}$, $V_O = 0\text{ V}$	25°C		5		$\mu\text{V}/^\circ\text{C}$
I_{IO}	Input offset current	$V_{ICM} = 0\text{ V}$, $V_O = 0\text{ V}$	25°C		10	150	nA
I_{IB}	Input bias current	$V_{ICM} = 0\text{ V}$, $V_O = 0\text{ V}$	25°C		200	750	nA
			Full range			1000	
V_{ICM}	Common-mode input voltage		25°C	-1.35		1.35	V
CMRR	Common-mode rejection ratio	$V_{ICM} = \pm 1.35\text{ V}$	25°C	60	85		dB
SVR	Supply-voltage rejection ratio	$V_{CC} = \pm 2\text{ V}$ to $\pm 3\text{ V}$	25°C	60	70		dB
A_{VD}	Large-signal voltage gain	$R_L = 2\text{ k}\Omega$	25°C	70	80		dB
V_{OH}	High-level output voltage	$R_L = 2\text{ k}\Omega$	25°C	2	2.4		V
V_{OL}	Low-level output voltage	$R_L = 2\text{ k}\Omega$	25°C		-2.4	-2	V
I_{source}	Output source current	$V_{OUT} = \pm 2.5\text{ V}$	25°C	1.2	1.4		mA
			Full range		1		
I_{sink}	Output sink current	$V_{OUT} = \pm 2.5\text{ V}$	25°C	50	80		mA
			Full range		25		
I_{CC}	Supply current (per amplifier)	Unity gain, No load	25°C		2	2.8	mA
			Full range			3.2	
GBWP	Gain bandwidth product	$f = 100\text{ kHz}$, $R_L = 2\text{ k}\Omega$, $C_L = 100\text{ pF}$	25°C	8.5	12		MHz
SR	Slew rate	$A_V = 1$, $V_{IN} = \pm 1\text{ V}$	25°C	2.8	5		V/ μs
			Full range		2.8		
Φ_m	Phase margin at unity gain	$R_L = 2\text{ k}\Omega$, $C_L = 100\text{ pF}$	25°C		60		$^\circ$
Gm	Gain margin	$R_L = 2\text{ k}\Omega$, $C_L = 100\text{ pF}$	25°C		10		dB
V_n	Equivalent input noise voltage	$f = 100\text{ kHz}$	25°C		4		$\text{nV}/\sqrt{\text{Hz}}$
THD	Total harmonic distortion	$f = 1\text{ kHz}$, $A_V = -1$, $R_L = 10\text{ k}\Omega$	25°C		0.003		%

7.6 Typical Characteristics

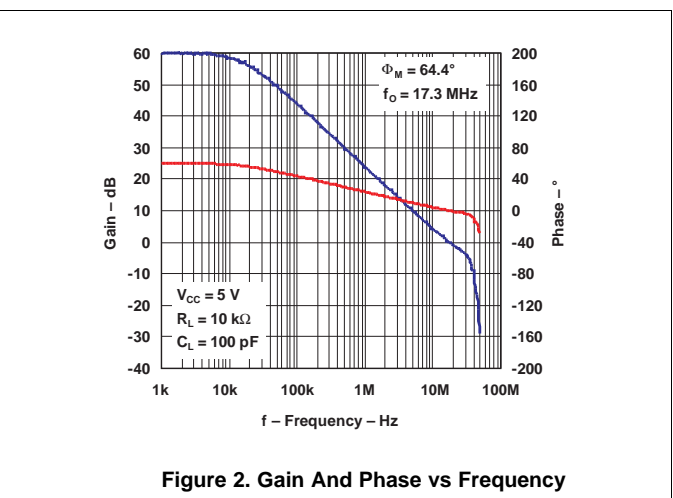
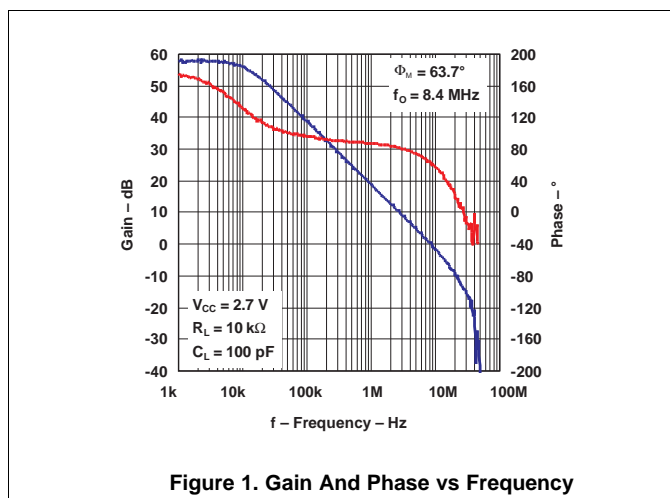

Typical Characteristics (continued)

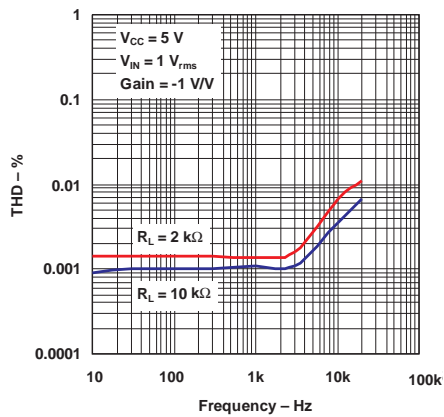

Figure 3. Total Harmonic Distortion vs Frequency

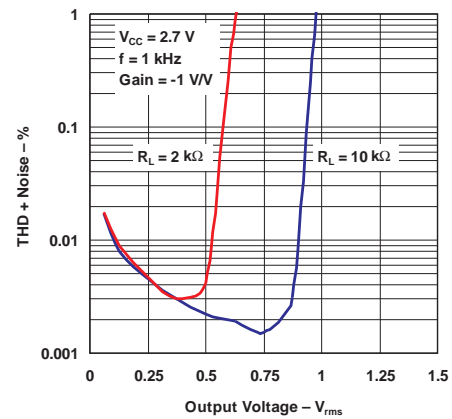

Figure 4. Total Harmonic Distortion + Noise vs Output Voltage

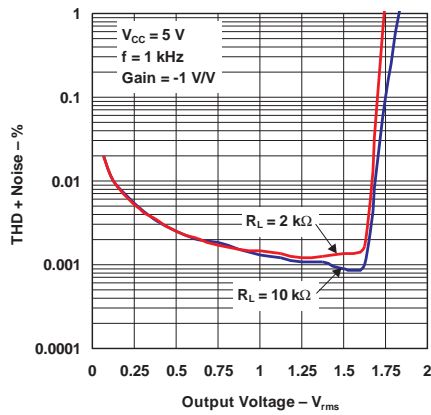

Figure 5. Total Harmonic Distortion + Noise vs Output Voltage

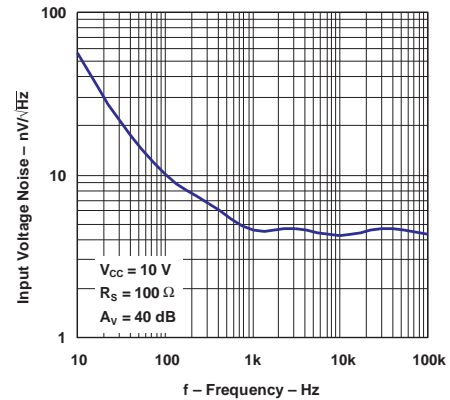

Figure 6. Input Voltage Noise vs Frequency

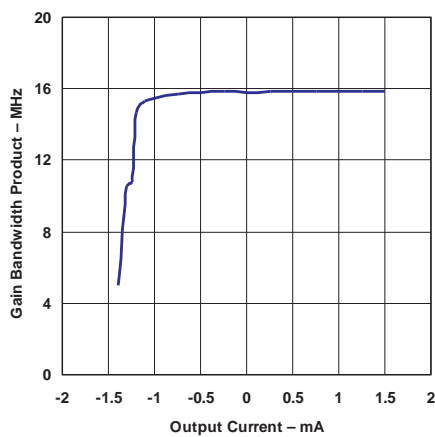

Figure 7. Gain Bandwidth Product vs Output Current

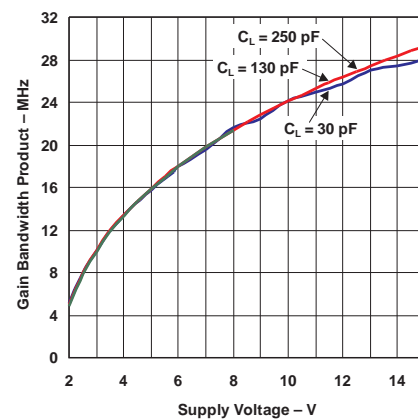

Figure 8. Gain Bandwidth Product vs Supply Voltage

Typical Characteristics (continued)

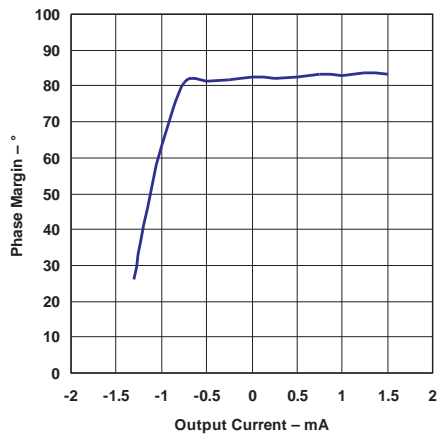

Figure 9. Phase Margin vs Output Current

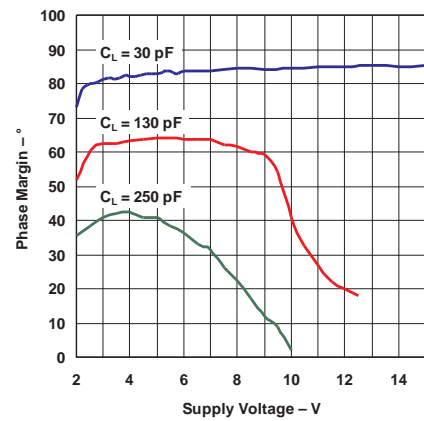

Figure 10. Phase Margin vs Supply Voltage

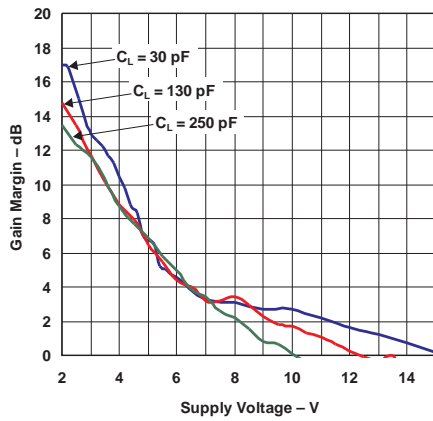

Figure 11. Gain Margin vs Supply Voltage

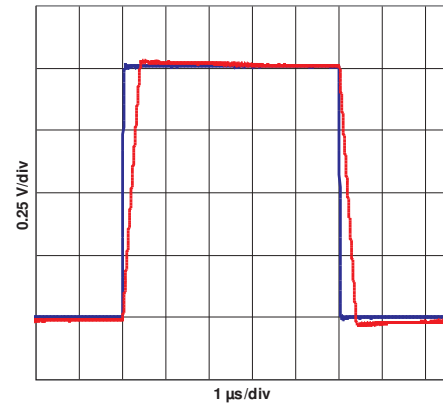

Figure 12. Input Response

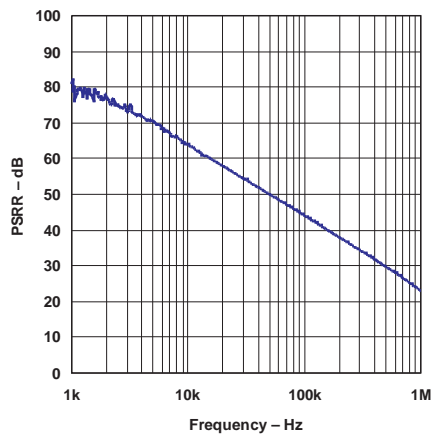

Figure 13. Power-Supply Ripple Rejection vs Frequency

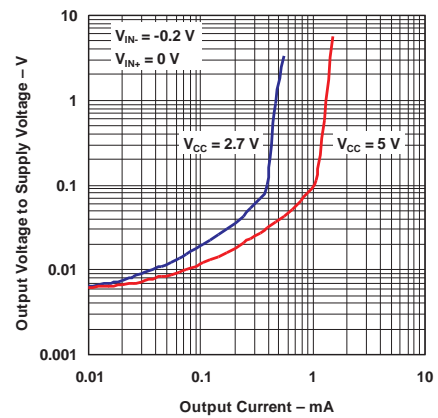

Figure 14. Output Voltage vs Output Current

Typical Characteristics (continued)

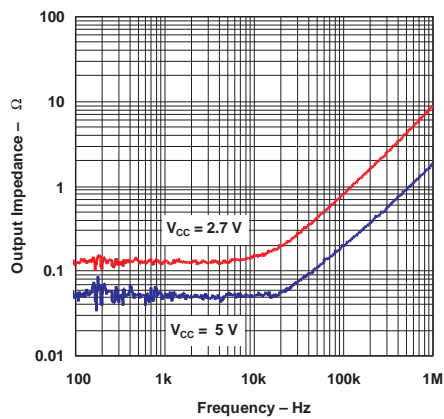

Figure 15. Output Impedance vs Frequency

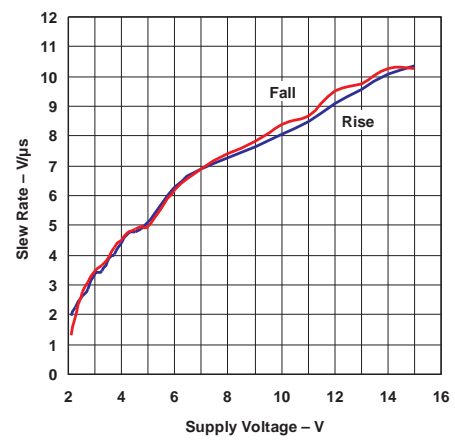

Figure 16. Slew Rate vs Supply Voltage

8 Detailed Description

8.1 Overview

The TL97x family of operational amplifiers operates at voltages as low as ± 1.35 V and features output rail-to-rail signal swing. The TL97x boast characteristics that make them particularly well suited for portable and battery-supplied equipment. Very low noise and low distortion characteristics make them ideal for audio preamplification. The TL97x family comes in single, dual, and quad operational amplifier packages of varying sizes.

The TL971 is housed in the space-saving 5-pin SOT-23 package, which simplifies board design because of the ability to be placed anywhere (outside dimensions are 2.8 mm \times 2.9 mm).

8.2 Functional Block Diagram

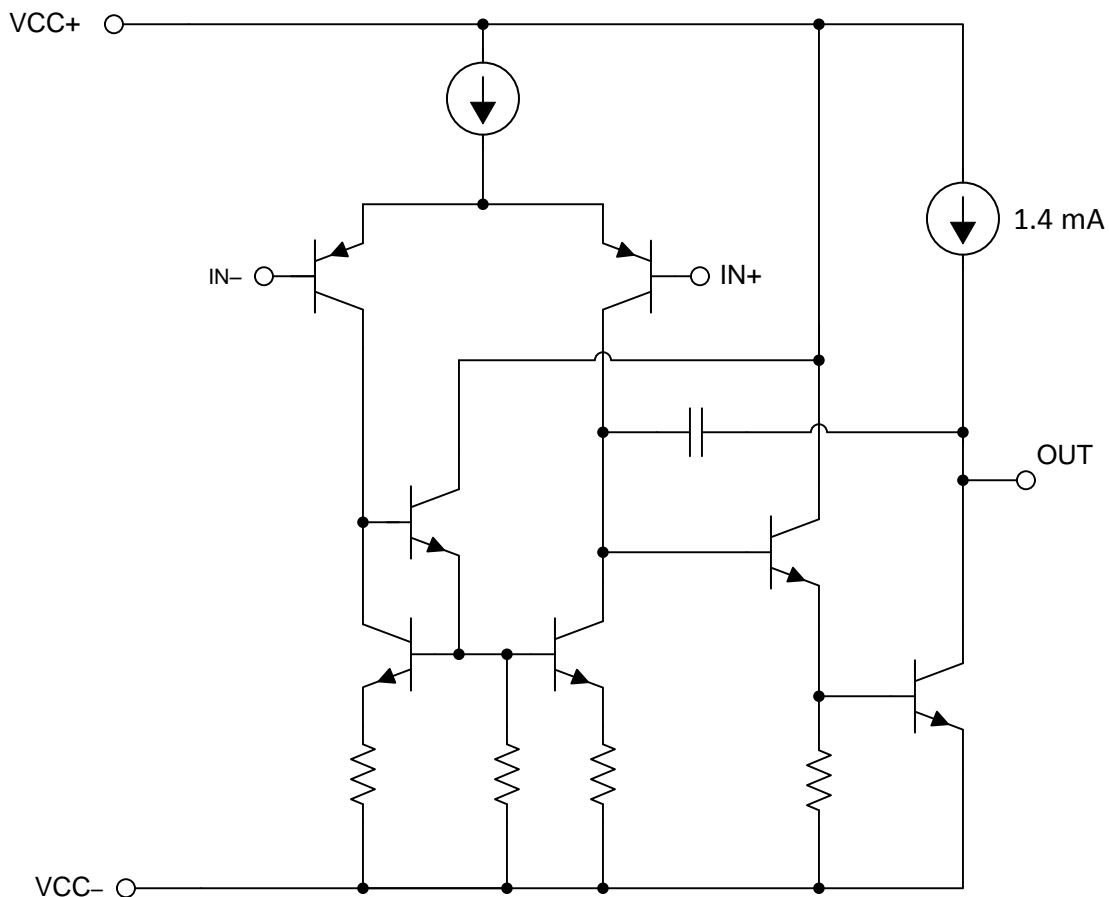

8.3 Feature Description

8.3.1 Slew Rate

The slew rate is the rate at which an operational amplifier can change its output when there is a change on the input. The TL97x devices have a 5 V/ μ s slew rate.

8.3.2 Unity-Gain Bandwidth

The unity-gain bandwidth is the frequency up to which an amplifier with a unity gain may be operated without greatly distorting the signal. The TL97x devices have a 12-MHz unity-gain bandwidth.

Feature Description (continued)

8.3.3 Low Total Harmonic Distortion

Harmonic distortions to an audio signal are created by electronic components in a circuit. Total harmonic distortion (THD) is a measure of harmonic distortions accumulated by a signal in an audio system. The TL97x devices have a very low THD of 0.003% meaning that they will add little harmonic distortion when used in audio signal applications.

8.3.4 Operating Voltage

The TL97x devices are fully specified and ensured for operation from 2.7 V to 12 V. In addition, many specifications apply from -40°C to 125°C .

8.4 Device Functional Modes

The TL97x devices are powered on when the supply is connected. Each of these devices can be operated as a single supply operational amplifier or dual supply amplifier depending on the application.

9 Application and Implementation

NOTE

Information in the following applications sections is not part of the TI component specification, and TI does not warrant its accuracy or completeness. TI's customers are responsible for determining suitability of components for their purposes. Customers should validate and test their design implementation to confirm system functionality.

9.1 Typical Application

The voltage follower configuration of the operational amplifier is used for applications where a weak signal is used to drive a relatively high current load. This circuit is also called a buffer amplifier or unity gain amplifier. The inputs of an operational amplifier have a very high resistance which puts a negligible current load on the voltage source. The output resistance of the operational amplifier is almost negligible, so it can provide as much current as necessary to the output load.

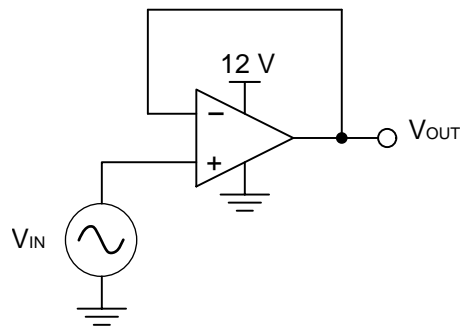

Figure 17. Voltage follower schematic

9.1.1 Design Requirements

- Input at positive Terminal
- Output range of 0 V to 12 V
- Input range of 0 V to 12 V
- Short-circuit feedback to negative input for unity gain

9.1.2 Detailed Design Procedure

9.1.2.1 Output Voltage Swing

The output voltage of an operational amplifier is limited by its internal circuitry to some level below the supply rails. For this amplifier, the output voltage must be within ± 12 V.

9.1.2.2 Supply and Input Voltage

For correct operation of the amplifier, neither input must be higher than the recommended positive supply rail voltage or lower than the recommended negative supply rail voltage. The chosen amplifier must be able to operate at the supply voltage that accommodates the inputs. Because the input for this application goes up to 12 V, the supply voltage must be 15 V. Using a negative voltage on the lower rail rather than ground, allows the amplifier to maintain linearity for the full range of inputs.

Typical Application (continued)

9.1.3 Application Curves for Output Characteristics

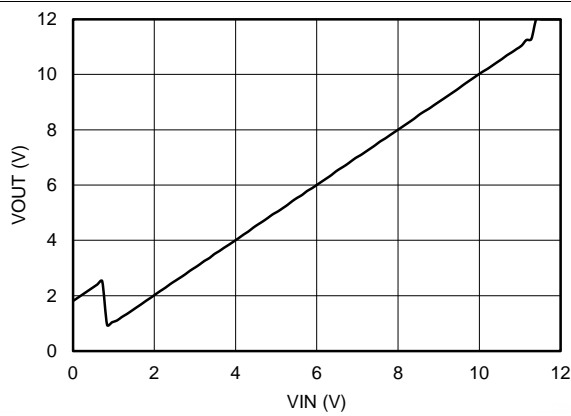

Figure 18. Output Voltage vs Input Voltage

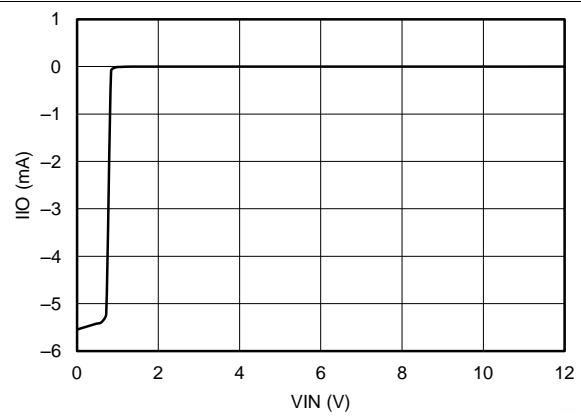

Figure 19. Current Drawn by Input of Voltage Follower (I_{IO}) vs Input Voltage

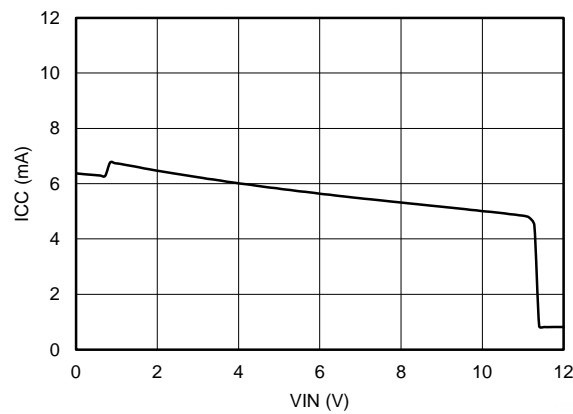

Figure 20. Current Drawn from Supply (I_{CC}) vs Input Voltage

10 Power Supply Recommendations

The TL97x devices are specified for operation from 2.7 to 12 V; many specifications apply from -40 °C to 125 °C.

CAUTION

Supply voltages larger than 15 V can permanently damage the device (see the [Absolute Maximum Ratings](#)).

Place 0.1- μ F bypass capacitors close to the power-supply pins to reduce errors coupling in from noisy or high impedance power supplies. For more detailed information on bypass capacitor placement, refer to the [Layout Guidelines](#).

11 Layout

11.1 Layout Guidelines

For best operational performance of the device, use good PCB layout practices, including:

- Noise can propagate into analog circuitry through the power pins of the circuit as a whole and the operational amplifier. Bypass capacitors are used to reduce the coupled noise by providing low impedance power sources local to the analog circuitry.
 - Connect low-ESR, 0.1- μ F ceramic bypass capacitors between each supply pin and ground, placed as close to the device as possible. A single bypass capacitor from V+ to ground is applicable for single supply applications.
- Separate grounding for analog and digital portions of circuitry is one of the simplest and most-effective methods of noise suppression. One or more layers on multilayer PCBs are usually devoted to ground planes. A ground plane helps distribute heat and reduces EMI noise pickup. Make sure to physically separate digital and analog grounds, paying attention to the flow of the ground current. For more detailed information, refer to Circuit Board Layout Techniques, [SLOA089](#).
- To reduce parasitic coupling, run the input traces as far away from the supply or output traces as possible. If it is not possible to keep them separate, it is much better to cross the sensitive trace perpendicular as opposed to in parallel with the noisy trace.
- Place the external components as close to the device as possible. Keeping RF and RG close to the inverting input minimizes parasitic capacitance, as shown in [Layout Example](#).
- Keep the length of input traces as short as possible. Always remember that the input traces are the most sensitive part of the circuit.
- Consider a driven, low-impedance guard ring around the critical traces. A guard ring can significantly reduce leakage currents from nearby traces that are at different potentials.

11.2 Layout Example

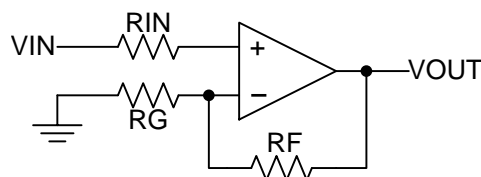

Figure 21. Operational Amplifier Schematic for Noninverting Configuration

Layout Example (continued)

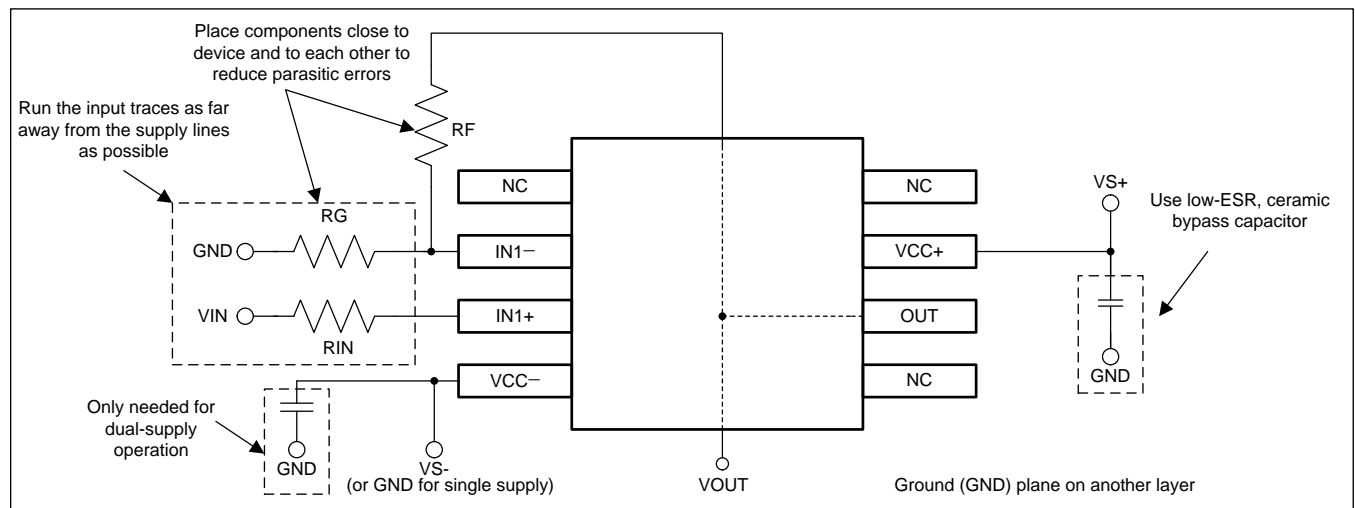

Figure 22. Operational Amplifier Board Layout for Noninverting Configuration

12 Device and Documentation Support

12.1 Related Links

The table below lists quick access links. Categories include technical documents, support and community resources, tools and software, and quick access to sample or buy.

Table 1. Related Links

PARTS	PRODUCT FOLDER	SAMPLE & BUY	TECHNICAL DOCUMENTS	TOOLS & SOFTWARE	SUPPORT & COMMUNITY
TL971	Click here	Click here	Click here	Click here	Click here
TL972	Click here	Click here	Click here	Click here	Click here
TL974	Click here	Click here	Click here	Click here	Click here

12.2 Trademarks

All trademarks are the property of their respective owners.

12.3 Electrostatic Discharge Caution



These devices have limited built-in ESD protection. The leads should be shorted together or the device placed in conductive foam during storage or handling to prevent electrostatic damage to the MOS gates.

12.4 Glossary

[SLYZ022](#) — *TI Glossary*.

This glossary lists and explains terms, acronyms, and definitions.

13 Mechanical, Packaging, and Orderable Information

The following pages include mechanical, packaging, and orderable information. This information is the most current data available for the designated devices. This data is subject to change without notice and revision of this document. For browser-based versions of this data sheet, refer to the left-hand navigation.

PACKAGING INFORMATION

Orderable Device	Status (1)	Package Type	Package Drawing	Pins	Package Qty	Eco Plan (2)	Lead finish/ Ball material (6)	MSL Peak Temp (3)	Op Temp (°C)	Device Marking (4/5)	Samples
TL971ID	OBSOLETE	SOIC	D	8		TBD	Call TI	Call TI	-40 to 125	Z971	
TL971IDR	ACTIVE	SOIC	D	8	2500	RoHS & Green	NIPDAU	Level-1-260C-UNLIM	-40 to 125	Z971	Samples
TL971IDRG4	ACTIVE	SOIC	D	8	2500	TBD	Call TI	Call TI	-40 to 125		Samples
TL972ID	OBSOLETE	SOIC	D	8		TBD	Call TI	Call TI	-40 to 125	Z972	
TL972IDGKR	ACTIVE	VSSOP	DGK	8	2500	RoHS & Green	SN	Level-1-260C-UNLIM	-40 to 125	TSA	Samples
TL972IDR	ACTIVE	SOIC	D	8	2500	RoHS & Green	NIPDAU	Level-1-260C-UNLIM	-40 to 125	Z972	Samples
TL972IP	ACTIVE	PDIP	P	8	50	RoHS & Green	NIPDAU	N / A for Pkg Type	-40 to 125	TL972IP	Samples
TL972IPE4	ACTIVE	PDIP	P	8	50	TBD	Call TI	Call TI	-40 to 125		Samples
TL972IPWR	ACTIVE	TSSOP	PW	8	2000	RoHS & Green	NIPDAU	Level-1-260C-UNLIM	-40 to 125	Z972	Samples
TL974ID	ACTIVE	SOIC	D	14	50	RoHS & Green	NIPDAU	Level-1-260C-UNLIM	-40 to 125	TL974I	Samples
TL974IDR	ACTIVE	SOIC	D	14	2500	RoHS & Green	NIPDAU	Level-1-260C-UNLIM	-40 to 125	TL974I	Samples
TL974IN	ACTIVE	PDIP	N	14	25	RoHS & Green	NIPDAU	N / A for Pkg Type	-40 to 125	TL974IN	Samples
TL974INE4	ACTIVE	PDIP	N	14	25	TBD	Call TI	Call TI	-40 to 125		Samples
TL974IPW	ACTIVE	TSSOP	PW	14	90	RoHS & Green	NIPDAU	Level-1-260C-UNLIM	-40 to 125	Z974	Samples
TL974IPWR	ACTIVE	TSSOP	PW	14	2000	RoHS & Green	NIPDAU	Level-1-260C-UNLIM	-40 to 125	Z974	Samples

(1) The marketing status values are defined as follows:

ACTIVE: Product device recommended for new designs.

LIFEBUY: TI has announced that the device will be discontinued, and a lifetime-buy period is in effect.

NRND: Not recommended for new designs. Device is in production to support existing customers, but TI does not recommend using this part in a new design.

PREVIEW: Device has been announced but is not in production. Samples may or may not be available.

OBSOLETE: TI has discontinued the production of the device.

(2) **RoHS:** TI defines "RoHS" to mean semiconductor products that are compliant with the current EU RoHS requirements for all 10 RoHS substances, including the requirement that RoHS substance do not exceed 0.1% by weight in homogeneous materials. Where designed to be soldered at high temperatures, "RoHS" products are suitable for use in specified lead-free processes. TI may reference these types of products as "Pb-Free".

RoHS Exempt: TI defines "RoHS Exempt" to mean products that contain lead but are compliant with EU RoHS pursuant to a specific EU RoHS exemption.

Green: TI defines "Green" to mean the content of Chlorine (Cl) and Bromine (Br) based flame retardants meet JS709B low halogen requirements of ≤ 1000 ppm threshold. Antimony trioxide based flame retardants must also meet the ≤ 1000 ppm threshold requirement.

(3) MSL, Peak Temp. - The Moisture Sensitivity Level rating according to the JEDEC industry standard classifications, and peak solder temperature.

(4) There may be additional marking, which relates to the logo, the lot trace code information, or the environmental category on the device.

(5) Multiple Device Markings will be inside parentheses. Only one Device Marking contained in parentheses and separated by a "~" will appear on a device. If a line is indented then it is a continuation of the previous line and the two combined represent the entire Device Marking for that device.

(6) Lead finish/Ball material - Orderable Devices may have multiple material finish options. Finish options are separated by a vertical ruled line. Lead finish/Ball material values may wrap to two lines if the finish value exceeds the maximum column width.

Important Information and Disclaimer: The information provided on this page represents TI's knowledge and belief as of the date that it is provided. TI bases its knowledge and belief on information provided by third parties, and makes no representation or warranty as to the accuracy of such information. Efforts are underway to better integrate information from third parties. TI has taken and continues to take reasonable steps to provide representative and accurate information but may not have conducted destructive testing or chemical analysis on incoming materials and chemicals. TI and TI suppliers consider certain information to be proprietary, and thus CAS numbers and other limited information may not be available for release.

In no event shall TI's liability arising out of such information exceed the total purchase price of the TI part(s) at issue in this document sold by TI to Customer on an annual basis.

OTHER QUALIFIED VERSIONS OF TL971, TL972, TL974 :

- Automotive : [TL971-Q1](#), [TL972-Q1](#), [TL974-Q1](#)

NOTE: Qualified Version Definitions:

- Automotive - Q100 devices qualified for high-reliability automotive applications targeting zero defects

TAPE AND REEL INFORMATION



QUADRANT ASSIGNMENTS FOR PIN 1 ORIENTATION IN TAPE



*All dimensions are nominal

Device	Package Type	Package Drawing	Pins	SPQ	Reel Diameter (mm)	Reel Width W1 (mm)	A0 (mm)	B0 (mm)	K0 (mm)	P1 (mm)	W (mm)	Pin1 Quadrant
TL971IDR	SOIC	D	8	2500	330.0	12.4	6.4	5.2	2.1	8.0	12.0	Q1
TL972IDGKR	VSSOP	DGK	8	2500	330.0	12.4	5.3	3.4	1.4	8.0	12.0	Q1
TL972IDR	SOIC	D	8	2500	330.0	12.4	6.4	5.2	2.1	8.0	12.0	Q1
TL972IDR	SOIC	D	8	2500	330.0	12.4	6.4	5.2	2.1	8.0	12.0	Q1
TL972IPWR	TSSOP	PW	8	2000	330.0	12.4	7.0	3.6	1.6	8.0	12.0	Q1
TL972IPWR	TSSOP	PW	8	2000	330.0	12.4	7.0	3.6	1.6	8.0	12.0	Q1
TL974IDR	SOIC	D	14	2500	330.0	16.4	6.5	9.0	2.1	8.0	16.0	Q1
TL974IPWR	TSSOP	PW	14	2000	330.0	12.4	6.9	5.6	1.6	8.0	12.0	Q1
TL974IPWR	TSSOP	PW	14	2000	330.0	12.4	6.9	5.6	1.6	8.0	12.0	Q1

TAPE AND REEL BOX DIMENSIONS

*All dimensions are nominal

Device	Package Type	Package Drawing	Pins	SPQ	Length (mm)	Width (mm)	Height (mm)
TL971IDR	SOIC	D	8	2500	340.5	338.1	20.6
TL972IDGKR	VSSOP	DGK	8	2500	358.0	335.0	35.0
TL972IDR	SOIC	D	8	2500	340.5	338.1	20.6
TL972IDR	SOIC	D	8	2500	353.0	353.0	32.0
TL972IPWR	TSSOP	PW	8	2000	353.0	353.0	32.0
TL972IPWR	TSSOP	PW	8	2000	356.0	356.0	35.0
TL974IDR	SOIC	D	14	2500	333.2	345.9	28.6
TL974IPWR	TSSOP	PW	14	2000	353.0	353.0	32.0
TL974IPWR	TSSOP	PW	14	2000	356.0	356.0	35.0

TUBE

*All dimensions are nominal

Device	Package Name	Package Type	Pins	SPQ	L (mm)	W (mm)	T (μm)	B (mm)
TL972IP	P	PDIP	8	50	506	13.97	11230	4.32
TL972IP	P	PDIP	8	50	506	13.97	11230	4.32
TL974ID	D	SOIC	14	50	507	8	3940	4.32
TL974IN	N	PDIP	14	25	506	13.97	11230	4.32
TL974IPW	PW	TSSOP	14	90	530	10.2	3600	3.5

D (R-PDSO-G14)

PLASTIC SMALL OUTLINE



- NOTES:
- A. All linear dimensions are in inches (millimeters).
 - B. This drawing is subject to change without notice.
 -  Body length does not include mold flash, protrusions, or gate burrs. Mold flash, protrusions, or gate burrs shall not exceed 0.006 (0,15) each side.
 -  Body width does not include interlead flash. Interlead flash shall not exceed 0.017 (0,43) each side.
 - E. Reference JEDEC MS-012 variation AB.

D (R-PDSO-G14)

PLASTIC SMALL OUTLINE



4211283-3/E 08/12

- NOTES:
- All linear dimensions are in millimeters.
 - This drawing is subject to change without notice.
 - Publication IPC-7351 is recommended for alternate designs.
 - Laser cutting apertures with trapezoidal walls and also rounding corners will offer better paste release. Customers should contact their board assembly site for stencil design recommendations. Refer to IPC-7525 for other stencil recommendations.
 - Customers should contact their board fabrication site for solder mask tolerances between and around signal pads.

PW (R-PDSO-G14)

PLASTIC SMALL OUTLINE



- NOTES:
- A. All linear dimensions are in millimeters. Dimensioning and tolerancing per ASME Y14.5M-1994.
 - B. This drawing is subject to change without notice.
 - C. Body length does not include mold flash, protrusions, or gate burrs. Mold flash, protrusions, or gate burrs shall not exceed 0,15 each side.
 - D. Body width does not include interlead flash. Interlead flash shall not exceed 0,25 each side.
 - E. Falls within JEDEC MO-153



D0008A

PACKAGE OUTLINE

SOIC - 1.75 mm max height

SMALL OUTLINE INTEGRATED CIRCUIT



4214825/C 02/2019

NOTES:

1. Linear dimensions are in inches [millimeters]. Dimensions in parenthesis are for reference only. Controlling dimensions are in inches. Dimensioning and tolerancing per ASME Y14.5M.
2. This drawing is subject to change without notice.
3. This dimension does not include mold flash, protrusions, or gate burrs. Mold flash, protrusions, or gate burrs shall not exceed $.006$ [0.15] per side.
4. This dimension does not include interlead flash.
5. Reference JEDEC registration MS-012, variation AA.

EXAMPLE BOARD LAYOUT

D0008A

SOIC - 1.75 mm max height

SMALL OUTLINE INTEGRATED CIRCUIT



LAND PATTERN EXAMPLE
EXPOSED METAL SHOWN
SCALE:8X



SOLDER MASK DETAILS

4214825/C 02/2019

NOTES: (continued)

6. Publication IPC-7351 may have alternate designs.

7. Solder mask tolerances between and around signal pads can vary based on board fabrication site.

EXAMPLE STENCIL DESIGN

D0008A

SOIC - 1.75 mm max height

SMALL OUTLINE INTEGRATED CIRCUIT



SOLDER PASTE EXAMPLE
BASED ON .005 INCH [0.125 MM] THICK STENCIL
SCALE:8X

4214825/C 02/2019

NOTES: (continued)

8. Laser cutting apertures with trapezoidal walls and rounded corners may offer better paste release. IPC-7525 may have alternate design recommendations.
9. Board assembly site may have different recommendations for stencil design.

P (R-PDIP-T8)

PLASTIC DUAL-IN-LINE PACKAGE



- NOTES:
- A. All linear dimensions are in inches (millimeters).
 - B. This drawing is subject to change without notice.
 - C. Falls within JEDEC MS-001 variation BA.

N (R-PDIP-T**)

PLASTIC DUAL-IN-LINE PACKAGE

16 PINS SHOWN



4040049/E 12/2002

- NOTES:
- A. All linear dimensions are in inches (millimeters).
 - B. This drawing is subject to change without notice.
 - (C) Falls within JEDEC MS-001, except 18 and 20 pin minimum body length (Dim A).
 - (D) The 20 pin end lead shoulder width is a vendor option, either half or full width.

PW0008A



PACKAGE OUTLINE
TSSOP - 1.2 mm max height

SMALL OUTLINE PACKAGE



4221848/A 02/2015

NOTES:

1. All linear dimensions are in millimeters. Any dimensions in parenthesis are for reference only. Dimensioning and tolerancing per ASME Y14.5M.
2. This drawing is subject to change without notice.
3. This dimension does not include mold flash, protrusions, or gate burrs. Mold flash, protrusions, or gate burrs shall not exceed 0.15 mm per side.
4. This dimension does not include interlead flash. Interlead flash shall not exceed 0.25 mm per side.
5. Reference JEDEC registration MO-153, variation AA.

EXAMPLE BOARD LAYOUT

PW0008A

TSSOP - 1.2 mm max height

SMALL OUTLINE PACKAGE



LAND PATTERN EXAMPLE
SCALE:10X



SOLDER MASK DETAILS
NOT TO SCALE

4221848/A 02/2015

NOTES: (continued)

- 6. Publication IPC-7351 may have alternate designs.
- 7. Solder mask tolerances between and around signal pads can vary based on board fabrication site.

EXAMPLE STENCIL DESIGN

PW0008A

TSSOP - 1.2 mm max height

SMALL OUTLINE PACKAGE



SOLDER PASTE EXAMPLE
BASED ON 0.125 mm THICK STENCIL
SCALE:10X

4221848/A 02/2015

NOTES: (continued)

8. Laser cutting apertures with trapezoidal walls and rounded corners may offer better paste release. IPC-7525 may have alternate design recommendations.
9. Board assembly site may have different recommendations for stencil design.

DGK0008A



PACKAGE OUTLINE

VSSOP - 1.1 mm max height

SMALL OUTLINE PACKAGE



4214862/A 04/2023

NOTES:

PowerPAD is a trademark of Texas Instruments.

1. All linear dimensions are in millimeters. Any dimensions in parenthesis are for reference only. Dimensioning and tolerancing per ASME Y14.5M.
2. This drawing is subject to change without notice.
3. This dimension does not include mold flash, protrusions, or gate burrs. Mold flash, protrusions, or gate burrs shall not exceed 0.15 mm per side.
4. This dimension does not include interlead flash. Interlead flash shall not exceed 0.25 mm per side.
5. Reference JEDEC registration MO-187.

EXAMPLE BOARD LAYOUT

DGK0008A

™ VSSOP - 1.1 mm max height

SMALL OUTLINE PACKAGE



LAND PATTERN EXAMPLE
EXPOSED METAL SHOWN
SCALE: 15X



SOLDER MASK DETAILS

4214862/A 04/2023

NOTES: (continued)

6. Publication IPC-7351 may have alternate designs.
7. Solder mask tolerances between and around signal pads can vary based on board fabrication site.
8. Vias are optional depending on application, refer to device data sheet. If any vias are implemented, refer to their locations shown on this view. It is recommended that vias under paste be filled, plugged or tented.
9. Size of metal pad may vary due to creepage requirement.

EXAMPLE STENCIL DESIGN

DGK0008A

TM VSSOP - 1.1 mm max height

SMALL OUTLINE PACKAGE



SOLDER PASTE EXAMPLE
SCALE: 15X

4214862/A 04/2023

NOTES: (continued)

11. Laser cutting apertures with trapezoidal walls and rounded corners may offer better paste release. IPC-7525 may have alternate design recommendations.
12. Board assembly site may have different recommendations for stencil design.

IMPORTANT NOTICE AND DISCLAIMER

TI PROVIDES TECHNICAL AND RELIABILITY DATA (INCLUDING DATA SHEETS), DESIGN RESOURCES (INCLUDING REFERENCE DESIGNS), APPLICATION OR OTHER DESIGN ADVICE, WEB TOOLS, SAFETY INFORMATION, AND OTHER RESOURCES "AS IS" AND WITH ALL FAULTS, AND DISCLAIMS ALL WARRANTIES, EXPRESS AND IMPLIED, INCLUDING WITHOUT LIMITATION ANY IMPLIED WARRANTIES OF MERCHANTABILITY, FITNESS FOR A PARTICULAR PURPOSE OR NON-INFRINGEMENT OF THIRD PARTY INTELLECTUAL PROPERTY RIGHTS.

These resources are intended for skilled developers designing with TI products. You are solely responsible for (1) selecting the appropriate TI products for your application, (2) designing, validating and testing your application, and (3) ensuring your application meets applicable standards, and any other safety, security, regulatory or other requirements.

These resources are subject to change without notice. TI grants you permission to use these resources only for development of an application that uses the TI products described in the resource. Other reproduction and display of these resources is prohibited. No license is granted to any other TI intellectual property right or to any third party intellectual property right. TI disclaims responsibility for, and you will fully indemnify TI and its representatives against, any claims, damages, costs, losses, and liabilities arising out of your use of these resources.

TI's products are provided subject to [TI's Terms of Sale](#) or other applicable terms available either on [ti.com](https://www.ti.com) or provided in conjunction with such TI products. TI's provision of these resources does not expand or otherwise alter TI's applicable warranties or warranty disclaimers for TI products.

TI objects to and rejects any additional or different terms you may have proposed.

Mailing Address: Texas Instruments, Post Office Box 655303, Dallas, Texas 75265
Copyright © 2024, Texas Instruments Incorporated