

ULQ™ 运行的 TPS51397A 4.5V 至 24V、10A 同步降压转换器

1 特性

- 输入电压范围：4.5V 至 24V
- 输出电压范围：0.6V 至 5.5V
- 支持 10A 的连续输出电流
- D-CAP3™ 架构控制，可实现快速瞬态响应
- 0.6V ± 1% 反馈电压精度 (25°C)
- 集成 17mΩ 和 5.9mΩ FET
- ULQ™ 运行 (110 μA)，能够在系统待机期间延长电池寿命
- 可通过 MODE 引脚选择 Eco-mode™ 和无声™
- 500kHz 和 800kHz 可选开关频率
- 可调内部软启动时间，默认为 1.2ms
- 大占空比运行
- 集成式电源正常状态指示器
- 内置输出放电功能
- 逐周期过流保护
- 锁存输出 OV 和 UV 保护
- 非锁存 UVLO 和 OT 保护
- -40°C 至 125°C 的工作结温范围
- 20 引脚 3.0mm × 3.0mm HotRod™ VQFN 封装
- 与 12A TPS56C230 引脚对引脚兼容
- 利用 TPS51397A 并借助 WEBENCH® Power Designer 创建定制设计方案

2 应用

- 笔记本电脑和台式机
- 超极本、手持平板电脑
- 工业 PC、单板计算机
- 非军用无人机
- 分布式电源系统

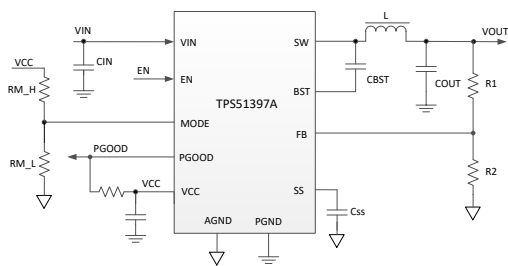

简化版原理图

3 说明

该器件是单片 10A 同步降压转换器，集成了 MOSFET，简单易用且高效，只需极少的外部组件，适合空间受限的电源系统。

TPS51397A 采用了 D-CAP3™ 控制，此控制方式只需内部补偿即可实现快速瞬态响应以及出色的线路和负载调整。ULQ™ (超低静态电流) 特性则非常有益于在低功耗运行时延长电池寿命。输入电压较低时，大负荷运行可显著改善负载瞬态性能。

可使用 MODE 引脚来设置 Eco-mode™ 或无声™ (OOA) 模式，以实现轻负载运行以及 500kHz 或 800kHz 的开关频率。Eco-mode™ 可在轻负载运行期间维持高效率。OOA 模式可将开关频率保持在可闻频率以上，同时将对效率的影响降至最低。

此器件同时支持内部和外部软启动选项。它具有 1.2ms 的内部固定软启动时间。如果应用需要更长的软启动时间，可将外部 SS 引脚连接至外部电容器。

TPS51397A 集成了电源正常状态指示器并具备输出放电功能。它提供包括 OVP、UVP、OCP、OTP 和 UVLO 在内的全面保护。该器件可采用 20 引脚 3.0mm × 3.0mm HotRod™ 封装，额定结温范围为 -40°C 至 125°C。

器件信息

器件型号	封装 ⁽¹⁾	封装尺寸 (标称值)
TPS51397A	VQFN (20)	3.00mm × 3.00mm

(1) 如需了解所有可用封装，请参阅数据表末尾的可订购产品附录。

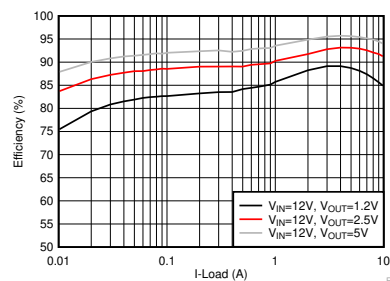

效率与输出电流，500kHz，Eco-mode



Table of Contents

1 特性	1	7.4 Device Functional Modes.....	14
2 应用	1	8 Application and Implementation	16
3 说明	1	8.1 Application Information.....	16
4 Revision History	2	8.2 Typical Application.....	16
5 Pin Configuration and Functions	3	9 Power Supply Recommendations	22
6 Specifications	4	10 Layout	23
6.1 Absolute Maximum Ratings.....	4	10.1 Layout Guidelines.....	23
6.2 ESD Ratings.....	4	10.2 Layout Example.....	23
6.3 Recommended Operating Conditions.....	4	11 Device and Documentation Support	24
6.4 Thermal Information.....	4	11.1 Receiving Notification of Documentation Updates..	24
6.5 Electrical Characteristics.....	5	11.2 支持资源.....	24
6.6 Typical Characteristics.....	7	11.3 Trademarks.....	24
7 Detailed Description	11	11.4 静电放电警告.....	24
7.1 Overview.....	11	11.5 术语表.....	24
7.2 Functional Block Diagram.....	11	12 Mechanical, Packaging, and Orderable Information	25
7.3 Feature Description.....	12		

4 Revision History

注：以前版本的页码可能与当前版本的页码不同

Changes from Revision * (September 2020) to Revision A (September 2020)	Page
• 将器件状态从“预告信息”更改为“量产数据”。.....	1

5 Pin Configuration and Functions



图 5-1. 20-Pin VQFN RJE Package (Top View)

表 5-1. Pin Functions

PIN		I/O	DESCRIPTION
NAME	NO.		
BST	1	O	Supply input for the gate drive voltage of the high-side MOSFET. Connect the bootstrap capacitor between BST and SW. 0.1 μ F is recommended.
VIN	2,3,4,5	P	Input voltage supply pin for the control circuitry. Connect the input decoupling capacitors between VIN and PGND.
SW	6,19,20	O	Switching node connection to the inductor and bootstrap capacitor for buck. This pin voltage swings from a diode voltage below the ground up to input voltage of buck.
PGND	7,8,18, Thermal Pad	G	Power GND terminal for the controller circuit and the internal circuitry
PGOOD	9	O	Open-drain power-good indicator. It is asserted low if output voltage is out of PG threshold, over voltage, or if the device is under thermal shutdown, EN shutdown, or during soft start.
SS	11	O	Soft-Start time selection pin. Connecting an external capacitor sets the soft-start time and if no external capacitor is connected, the soft-start time is about 1.2 ms.
NC	10,16		Not connect. Can be connected to GND plane for better thermal achieved.
EN	12	I	Enable input of buck converter
AGND	13	G	Ground of internal analog circuitry. Connect AGND to GND plane with a short trace.
FB	14	I	Feedback sensing pin for Buck output voltage. Connect this pin to the resistor divider between output voltage and AGND.
MODE	15	I	Switching frequency and light load operation mode selection pin. Connect this pin to a resistor divider from VCC and AGND for different MODE options shown in 表 7-1.
VCC	17	O	The driver and control circuits are powered from this voltage. Decouple with a minimum 1- μ F ceramic capacitor as close to VCC as possible.

6 Specifications

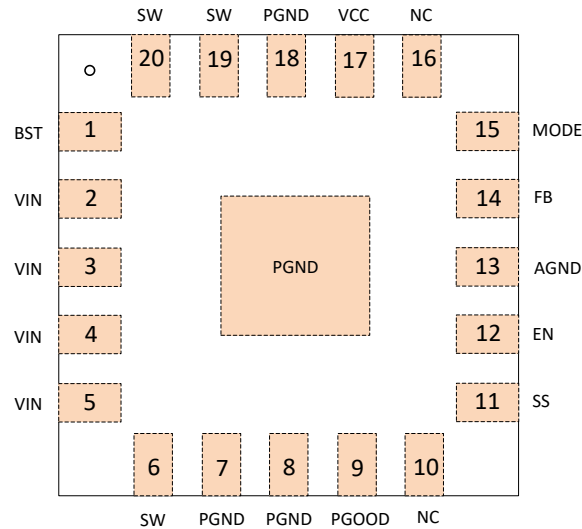
6.1 Absolute Maximum Ratings

over operating free-air temperature range (unless otherwise noted) ⁽¹⁾

		MIN	MAX	UNIT
Input voltage	VIN	- 0.3	26	V
	VBST	- 0.3	31	V
	VBST-SW	- 0.3	6	V
	EN, MODE, FB, SS, VCC	- 0.3	6	V
	PGND, AGND	- 0.3	0.3	V
Output voltage	SW	- 1	26	V
	SW (10-ns transient)	- 3	29	V
	PGOOD	- 0.3	6	V
T _J	Operating junction temperature	- 40	150	°C
T _{stg}	Storage temperature	- 55	150	°C

- (1) Stresses beyond those listed under *Absolute Maximum Ratings* may cause permanent damage to the device. These are stress ratings only, which do not imply functional operation of the device at these or any other conditions beyond those indicated under *Recommended Operating Conditions*. Exposure to absolute-maximum-rated conditions for extended periods may affect device reliability.

6.2 ESD Ratings

		VALUE	UNIT	
V _(ESD)	Electrostatic discharge	Human-body model (HBM), per ANSI/ESDA/JEDEC JS-001 ⁽¹⁾	±2000	V
		Charged-device model (CDM), per JEDEC specification JESD22- V C101 ⁽²⁾	±500	V

- (1) JEDEC document JEP155 states that 500-V HBM allows safe manufacturing with a standard ESD control process.

- (2) JEDEC document JEP157 states that 250-V CDM allows safe manufacturing with a standard ESD control process.

6.3 Recommended Operating Conditions

over operating free-air temperature range (unless otherwise noted)

		MIN	MAX	UNIT
Input voltage	VIN	4.5	24	V
	VBST	- 0.3	29.5	V
	VBST-SW	- 0.3	5.5	V
	EN, MODE, FB, SS, VCC	- 0.3	5.5	V
	PGND, AGND	- 0.3	0.3	V
Output voltage	SW	- 1	24	V
	PGOOD	- 0.3	5.5	V
I _{OUT}	Output current		10	A
T _J	Operating junction temperature	- 40	125	°C

6.4 Thermal Information

THERMAL METRIC ⁽¹⁾		TPS51397A	UNIT
		RJE (VQFN)	
		20 PINS	
R _{θJA}	Junction-to-ambient thermal resistance	49.7	°C/W
R _{θJA_effective}	Junction-to-ambient thermal resistance (4-layer custom board) ⁽²⁾	39.6	°C/W
R _{θJC(top)}	Junction-to-case (top) thermal resistance	26.2	°C/W
R _{θJB}	Junction-to-board thermal resistance	14.4	°C/W

THERMAL METRIC ⁽¹⁾		TPS51397A	UNIT
		RJE (VQFN)	
		20 PINS	
ψ_{JT}	Junction-to-top characterization parameter	0.9	°C/W
ψ_{JB}	Junction-to-board characterization parameter	14.3	°C/W
$R_{\theta JC(bot)}$	Junction-to-case (bottom) thermal resistance	13.0	°C/W

- (1) For more information about traditional and new thermal metrics, see the [IC Package Thermal Metrics](#) application report.
(2) 70 mm x 70 mm, 4 layers, thickness: 1.5 mm. 2 oz. copper traces located on the top and bottom of the PCB. 4 thermal vias in the PowerPAD area under the device package.

6.5 Electrical Characteristics

$T_J = -40^{\circ}\text{C}$ to 125°C , $V_{IN} = 12\text{ V}$, unless otherwise noted.

PARAMETER	TEST CONDITION	MIN	TYP	MAX	UNIT	
SUPPLY CURRENT						
V_{IN}	Input voltage range	4.5		24	V	
I_{VIN}	Non-switching supply current	No load, $V_{EN} = 5\text{V}$		150	μA	
I_{VINSN}	Shutdown supply current	No load, $V_{EN} = 0\text{V}$		4	μA	
VCC OUTPUT						
V_{CC}	VCC output voltage	$V_{IN} > 5.0\text{V}$	4.85	5	5.15	V
		$V_{IN} = 4.5\text{V}$		4.5		
I_{CC}	VCC current limit	20			mA	
FEEDBACK VOLTAGE						
V_{FB}	FB voltage	$T_J = 25^{\circ}\text{C}$	594	600	606	mV
		$T_J = -40^{\circ}\text{C}$ to 125°C	591	600	609	mV
DUTY CYCLE and FREQUENCY CONTROL						
F_{SW}	Switching frequency	$V_{OUT} = 2.5\text{V}$		550	kHz	
$t_{ON(MIN)}$	SW minimum on time		60	100	ns	
$t_{OFF(MIN)}$	SW minimum off time	$V_{FB} = 0.5\text{V}$		180	ns	
OOA Function						
T_{OOA}	Mode Operation Period		30	42	us	
MOSFET and DRIVERS						
$R_{DS(ON)H}$	High side switch resistance	$T_J = 25^{\circ}\text{C}$		17	$\text{m}\Omega$	
$R_{DS(ON)L}$	Low side switch resistance	$T_J = 25^{\circ}\text{C}$		5.9	$\text{m}\Omega$	
OUTPUT DISCHARGE and SOFT START						
R_{DIS}	Discharge resistance	$V_{EN} = 0\text{V}$		400	Ω	
t_{SS}	Soft start time	Internal soft-start time, SS pin floating		2.5	ms	
I_{SS}	Soft start charge current		5		μA	
POWER GOOD						
t_{PGDLY}	PG start-up delay	PG from low to high		1	ms	
V_{PGTH}	PG threshold	VFB falling (fault)		85	%	
		VFB rising (good)		90	%	
		VFB rising (fault)		115	%	
		VFB falling (good)		110	%	
V_{PG_L}	PG sink current capability	$I_{OL} = 4\text{mA}$		0.4	V	
I_{PGLK}	PG leak current	$V_{PGOOD} = 5.5\text{V}$		1	μA	
CURRENT LIMIT						

$T_J = -40^{\circ}\text{C}$ to 125°C , $V_{IN} = 12\text{ V}$, unless otherwise noted.

PARAMETER		TEST CONDITION	MIN	TYP	MAX	UNIT
I_{OCL}	Over current threshold (valley)	$T_J = 25^{\circ}\text{C}$	11	12	13	A
		$T_J = -40^{\circ}\text{C}$ to 125°C	10.5	12	14	A
I_{NOCL}	Negative over current threshold			3.2		A
LOGIC THRESHOLD						
V_{ENH}	EN high-level input voltage		1.2	1.3	1.4	V
V_{ENL}	EN low-level input voltage		0.9	1.1	1.2	V
I_{EN}	Enable internal pull down current	$V_{EN} = 0.8\text{V}$		2		μA
OUTPUT UNDERVOLTAGE AND OVERVOLTAGE PROTECTION						
V_{OVP}	OVP trip threshold			125		%
t_{OVDPDY}	OVP prop deglitch			120		us
V_{UVP}	UVP trip threshold			60		%
t_{UVDPDY}	UVP prop deglitch			256		us
UVLO						
V_{UVLO}	VIN UVLO threshold	Wake up	4.1	4.2	4.4	V
		Shutdown	3.6	3.7	3.9	V
		Hysteresis		0.5		V
OVER TEMPERATURE PROTECTION						
T_{OTP}	OTP trip threshold ⁽¹⁾	Shutdown temperature		150		$^{\circ}\text{C}$
T_{OTPHSY}	OTP hysteresis ⁽¹⁾	Hysteresis		20		$^{\circ}\text{C}$

(1) Not production tested.

6.6 Typical Characteristics

$T_J = -40^{\circ}\text{C}$ to 125°C , $V_{IN} = 12\text{ V}$, unless otherwise noted.



图 6-1. Supply Current vs Junction Temperature



图 6-2. Shutdown Current vs Junction Temperature

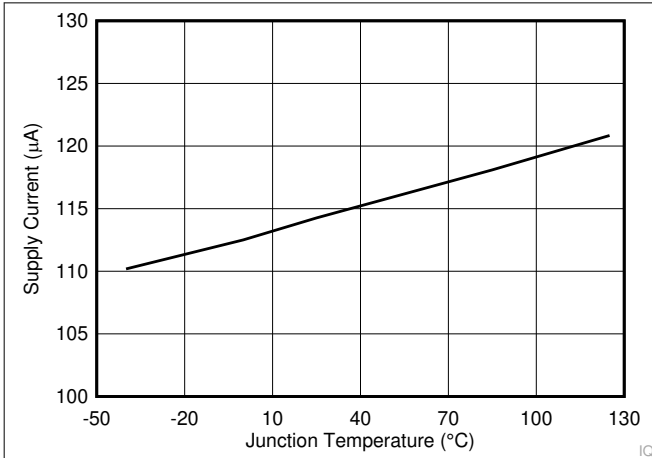

图 6-3. Feedback Voltage vs Junction Temperature

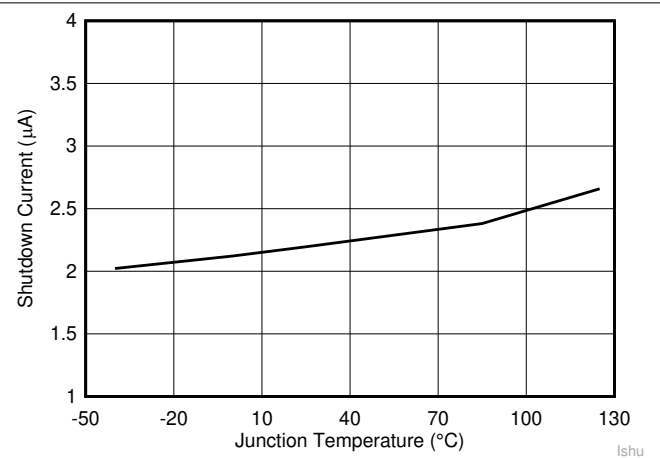

图 6-4. Enable On Voltage vs Junction Temperature

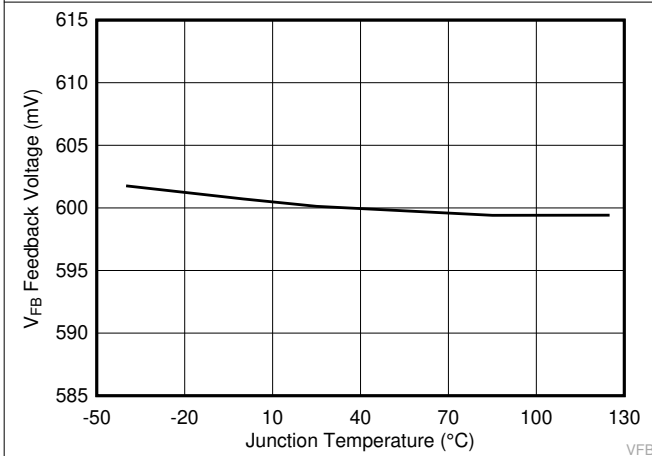

图 6-5. Enable Off Voltage vs Junction Temperature

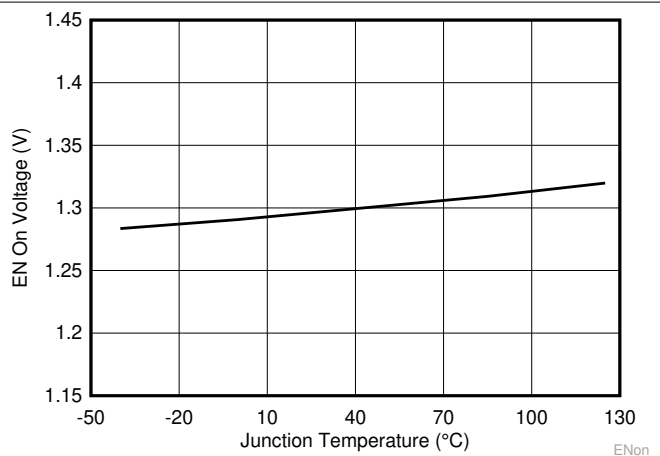

图 6-6. High-Side R_{DS(on)} vs Junction Temperature

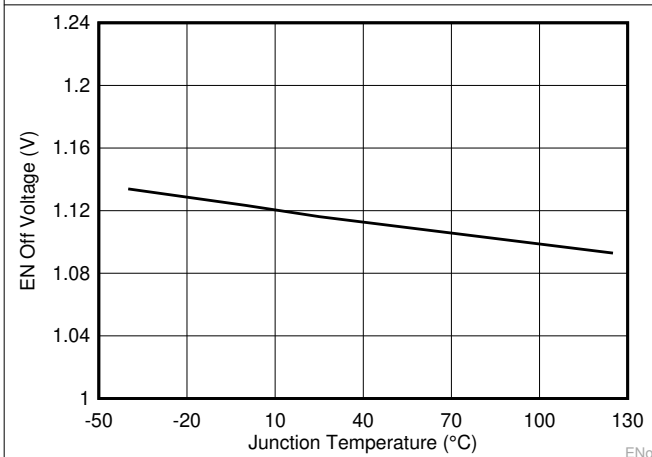

图 6-7. Low-Side $R_{DS(on)}$ vs Junction Temperature RdSl

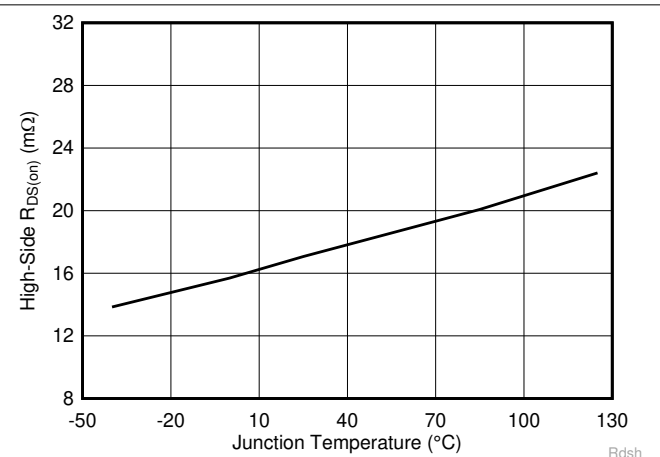

图 6-8. OVP Threshold vs Junction Temperature OVPT

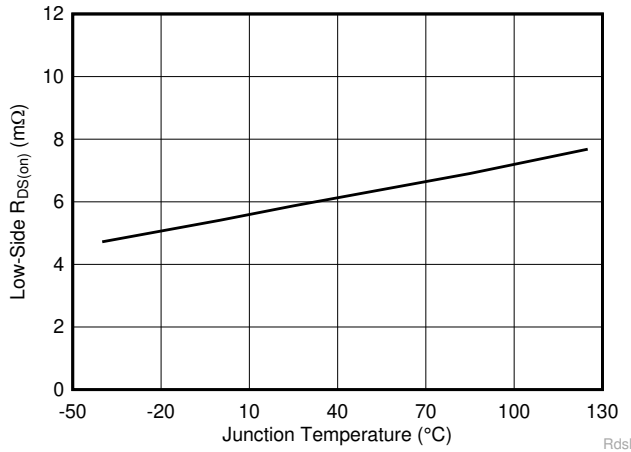

图 6-9. UVP Threshold vs Junction Temperature UVPT

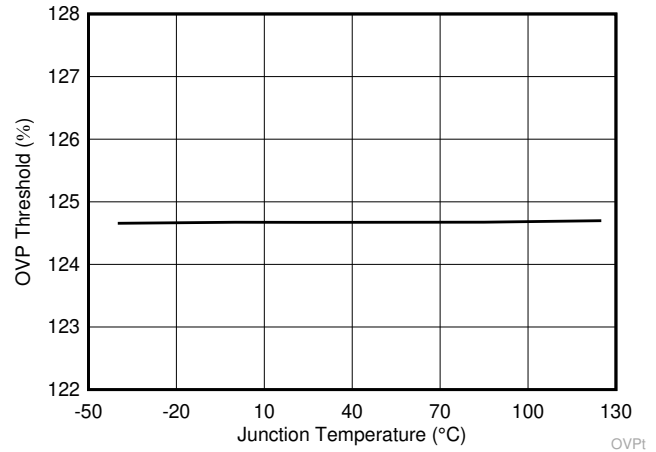

图 6-10. Discharge Resistor vs Junction Temperature Rdis

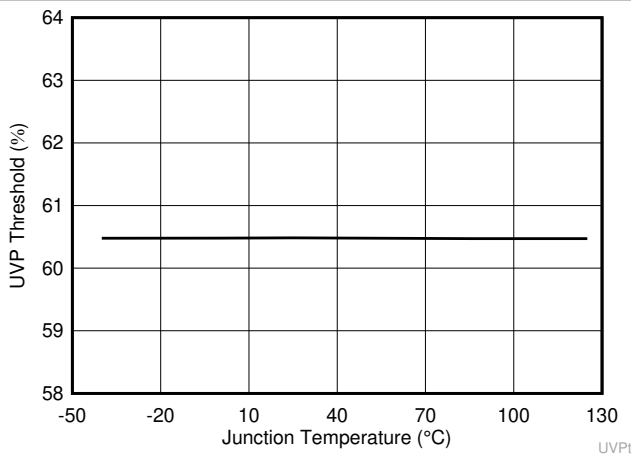

图 6-11. Valley Current Limit vs Junction Temperature OCi

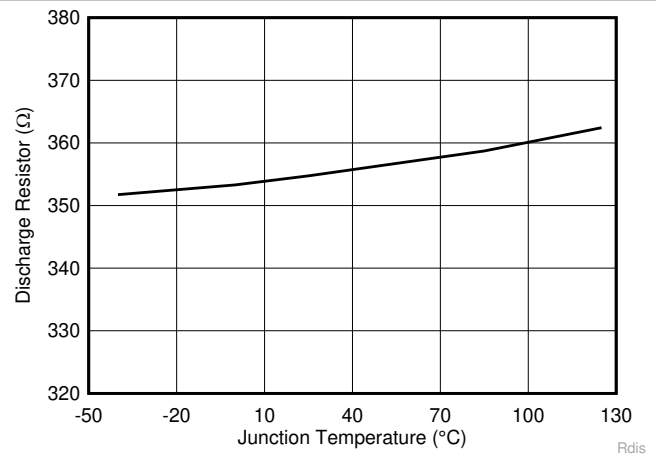

图 6-12. Negative Current Limit vs Junction Temperature NOC

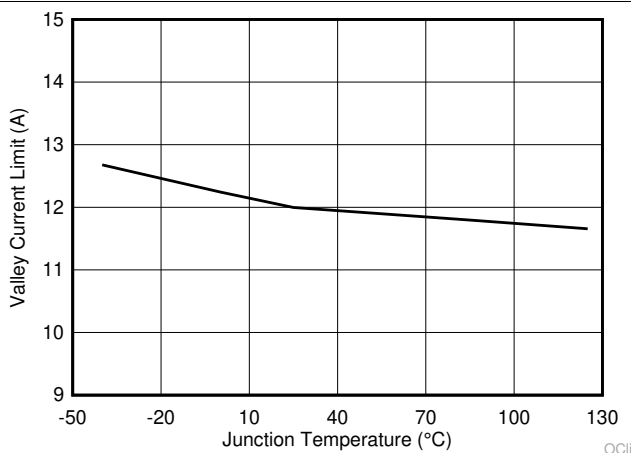

图 6-13. Soft-Start Time vs Junction Temperature

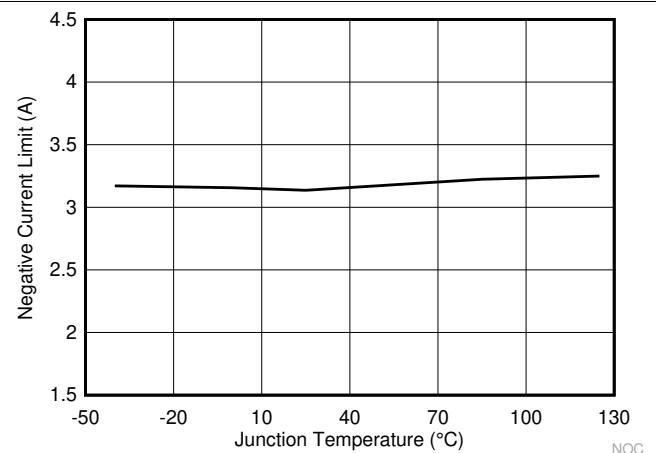

图 6-14. OOA Period vs Junction Temperature

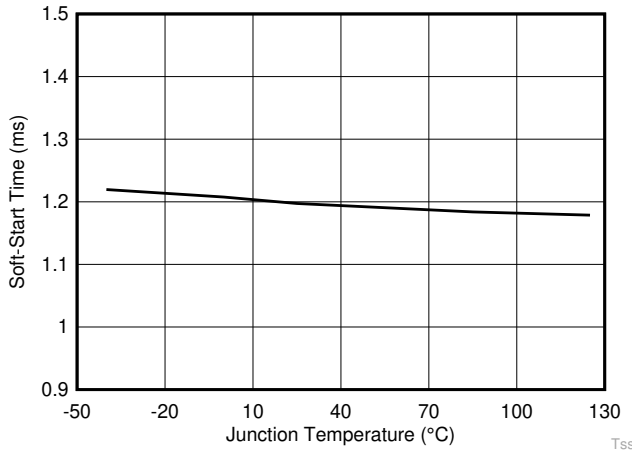

图 6-15. Efficiency vs Load Current, $F_{sw} = 500 \text{ kHz}$, Eco-mode

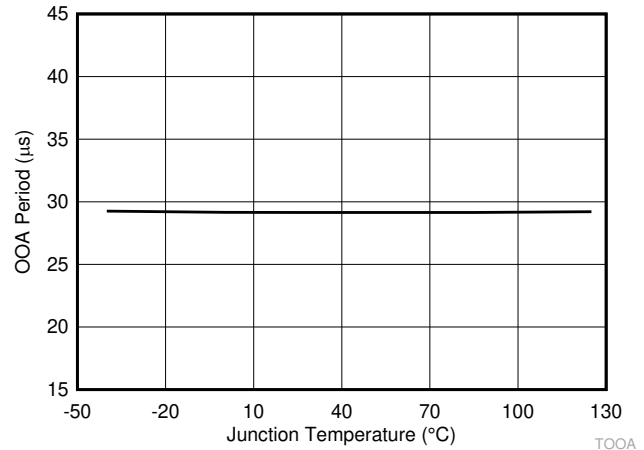

图 6-16. Efficiency vs Load Current, $F_{sw} = 800 \text{ kHz}$, Eco-mode

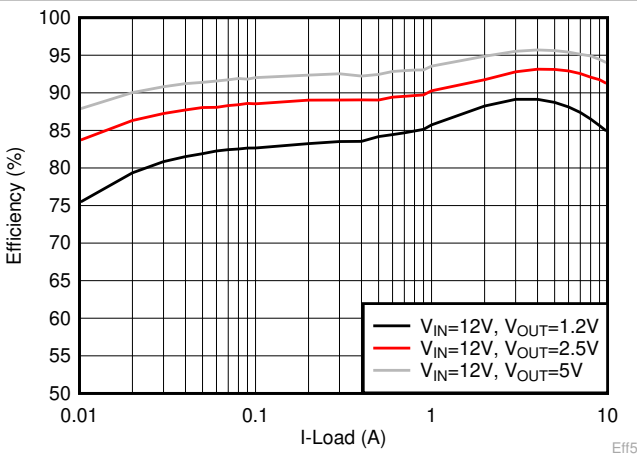

图 6-17. Efficiency vs Load Current, $F_{sw} = 500 \text{ kHz}$, OOA

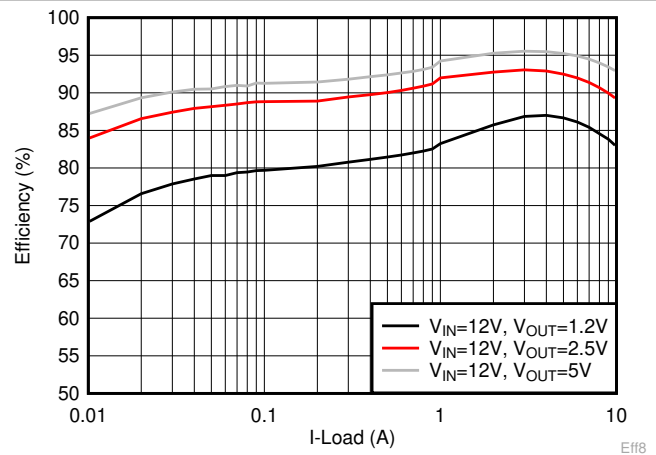

图 6-18. Efficiency vs Load Current, $F_{sw} = 800 \text{ kHz}$, OOA

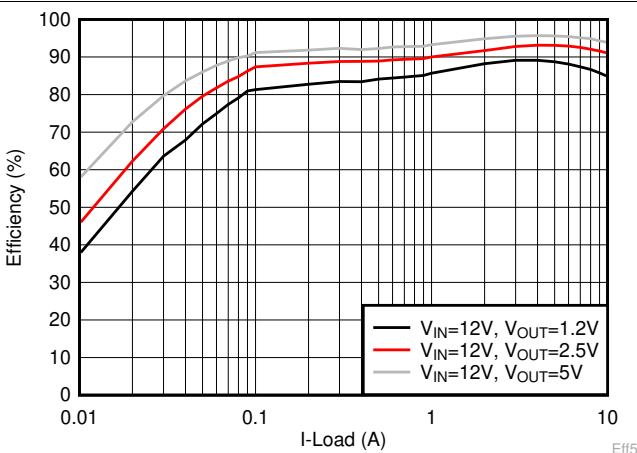

图 6-19. Switching Frequency vs Load Current, $F_{sw} = 500 \text{ kHz}$, Eco-mode

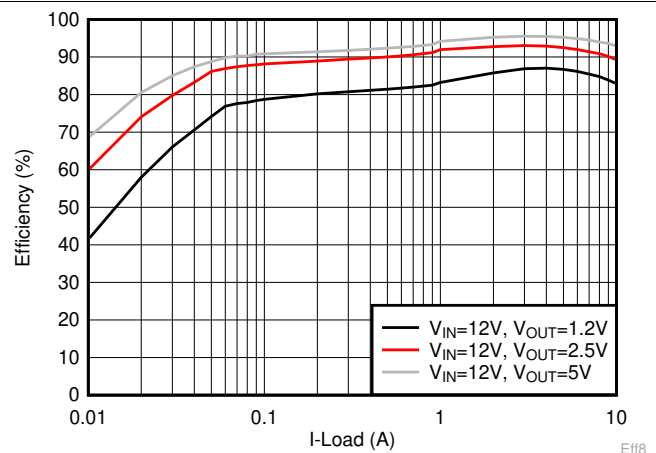

图 6-20. Switching Frequency vs Load Current, $F_{sw} = 800 \text{ kHz}$, Eco-mode

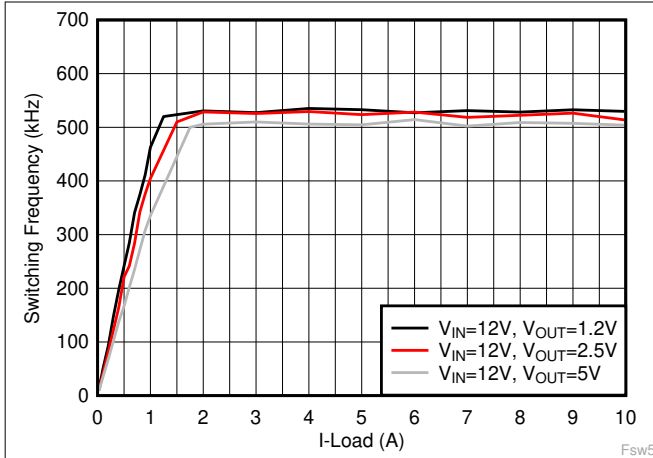

图 6-21. Switching Frequency vs Load Current, $F_{sw} = 500 \text{ kHz}$, OOA

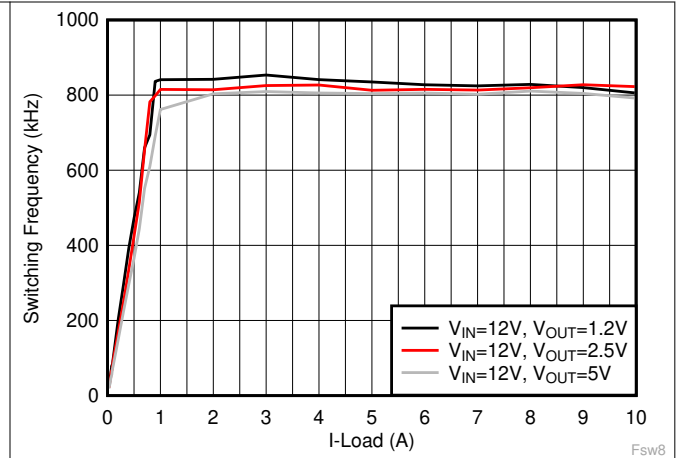

图 6-22. Switching Frequency vs Load Current, $F_{sw} = 800 \text{ kHz}$, OOA

7 Detailed Description

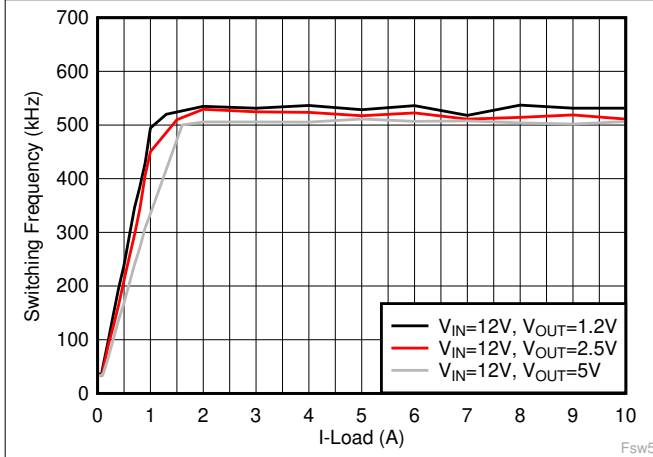
7.1 Overview

The TPS51397A is a high density synchronous buck converter that operates from 4.5-V to 24-V input voltage, and 0.6-V to 5.5-V output voltage range. It has 17-m Ω and 5.9-m Ω integrated MOSFETs that enable high efficiency up to 10 A. The ULQ™ (Ultra Low Quiescent) feature is extremely beneficial for long battery life in low power operation. The large duty operation greatly improves the load transient performance when input voltage is low. The device employs DCAP3™ mode control that enables low external component count, ease of design, optimization of the power design for cost, size, and efficiency, and provides fast transient response with no external compensation components and an accurate feedback voltage. The control topology supports seamless transition between CCM mode at heavy load conditions and DCM operation at light load conditions. Eco-mode™ allows the TPS51397A to maintain high efficiency at light load and OOA mode makes switching frequency above audible frequency (20 kHz), even there is no loading at output side. The TPS51397A is able to adapt to both low equivalent series resistance (ESR) output capacitors such as POSCAP or SP-CAP, and ultra-low ESR ceramic capacitors.

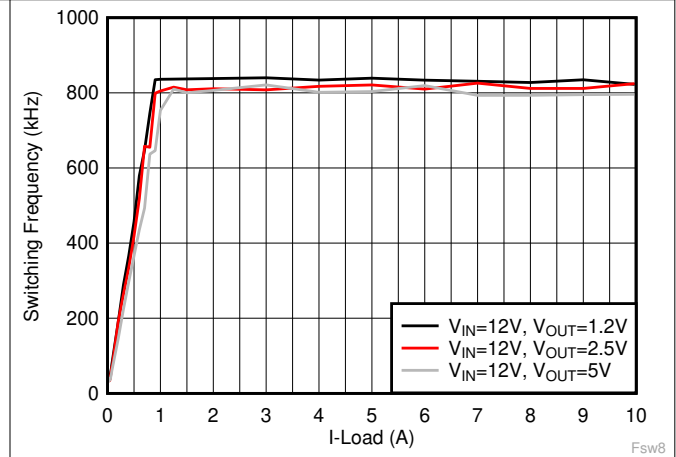
7.2 Functional Block Diagram

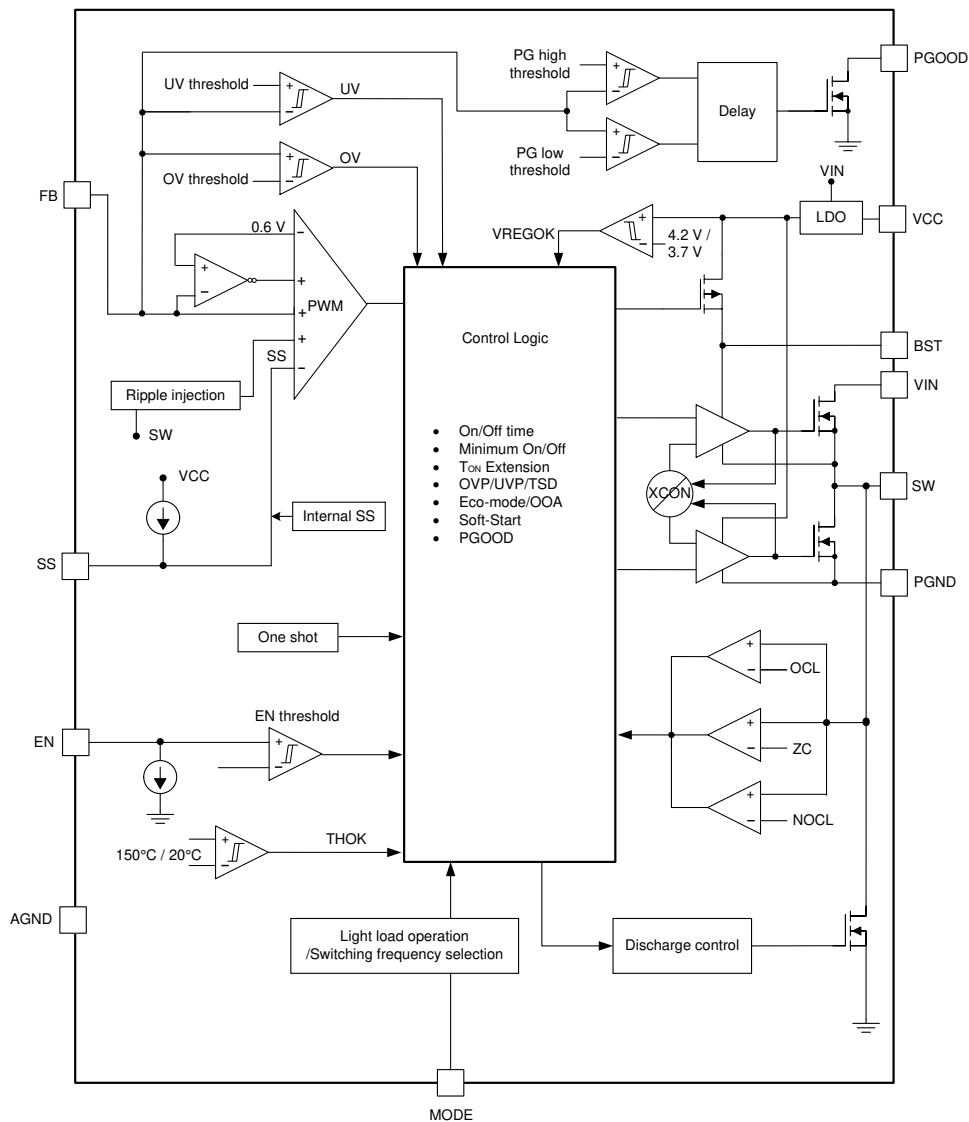

7.3 Feature Description

7.3.1 PWM Operation and DCAP3™ Control

The main control loop of the buck is an adaptive on-time pulse width modulation (PWM) controller that supports a proprietary DCAP3™ mode control. The DCAP3™ mode control combines adaptive on-time control with an internal compensation circuit for pseudo-fixed frequency and low external component count configuration with both low-ESR and ceramic output capacitors. It is stable even with virtually no ripple at the output. The TPS51397A also includes an error amplifier that makes the output voltage high accurate.

At the beginning of each cycle, the high-side MOSFET is turned on. This MOSFET is turned off after an internal one-shot timer expires. This one-shot duration is set proportional to the converter input voltage, V_{IN} , and is inversely proportional to the output voltage, V_{OUT} , to maintain a pseudo-fixed frequency over the input voltage range, hence it is called adaptive on-time control. The one-shot timer is reset and the high-side MOSFET is turned on again when the feedback voltage falls below the reference voltage. An internal ripple generation circuit is added to the reference voltage to emulate the output ripple. This enables the use of very low-ESR output capacitors such as multi-layered ceramic caps (MLCC). No external current sense network or loop compensation is required for DCAP3™ control topology.

For any control topology that is compensated internally, there is a range of the output filter it can support. The output filter used with the TPS51397A is a low-pass L-C circuit. This L-C filter has a double-pole frequency described in [方程式 1](#).

$$f_P = \frac{1}{2 \times \pi \times \sqrt{L_{OUT} \times C_{OUT}}} \quad (1)$$

At low frequencies, the overall loop gain is set by the external output set-point resistor divider network and the internal gain of the TPS51397A. The low-frequency L-C double pole has a 180 degree lag in-phase. At the output filter frequency, the gain rolls off at a -40 dB per decade rate and the phase drops rapidly. The internal ripple generation network introduces a mid-frequency zero that reduces the gain roll off from -40 dB to -20 dB per decade and increases the phase to 90 degree one decade above the zero frequency. The inductor and capacitor selected for the output filter must be such that the double pole is placed close enough to the mid-frequency zero so that the phase boost provided by this mid-frequency zero provides adequate phase margin for the stability requirement. The crossover frequency of the overall system should usually be targeted to be less than one-third of the switching frequency (F_{SW}).

7.3.2 Soft Start

The TPS51397A has an internal 1.2-ms soft start. An external SS pin is provided for setting higher soft-start time if needed. When the EN pin becomes high, the soft-start function begins ramping up the reference voltage to the PWM comparator.

If the application needs a higher soft-start time, it can be set by connecting a capacitor on SS pin. When the EN pin becomes high, the soft-start charge current (I_{SS}) begins charging the external capacitor (C_{SS}) connected between SS and AGND. The device tracks the lower of the internal soft-start voltage or the external soft-start voltage as the reference. The equation for the soft-start time (T_{SS}) is shown in [方程式 2](#):

$$T_{SS}(ms) = \frac{C_{SS}(nF) \times V_{REF}(V)}{I_{SS}(uA)} \quad (2)$$

where

- V_{REF} is 0.6 V and I_{SS} is 5 μ A

7.3.3 Large Duty Operation

The TPS51397A can support large duty operation by its internal T_{ON} extension function. When $V_{IN}/V_{OUT} < 1.6$ and the V_{FB} keeps lower than internal V_{REF} , T_{ON} is extended to implement the large duty operation which greatly improves the load transient performance.

7.3.4 Power Good

The Power Good (PGOOD) pin is an open-drain output. A pullup resistor of 100 k Ω is recommended to pull the voltage up to VCC. Once V_{FB} is between 90% and 110% of the target output voltage, the PGOOD is pulled high after a 1-ms de-glitch time. The PGOOD pin is pulled low when:

- FB pin voltage is lower than 85% or greater than 115% of the target output voltage,
- In OVP, UVP, or thermal shutdown event, or
- During the soft-start period.

7.3.5 Overcurrent Protection and Undervoltage Protection

The TPS51397A has overcurrent protection and undervoltage protection. The output overcurrent limit (OCL) is implemented using a cycle-by-cycle valley detect control circuit. The switch current is monitored during the OFF state by measuring the low-side FET drain-to-source voltage. This voltage is proportional to the switch current. To improve accuracy, the voltage sensing is temperature compensated.

During the on-time of the high-side FET switch, the switch current increases at a linear rate determined by V_{in} , V_{out} , the on-time, and the output inductor value. During the on-time of the low-side FET switch, this current decreases linearly. The average value of the switch current is the load current I_{OUT} . If the monitored current is above the OCL level, the converter maintains low-side FET on and delays the creation of a new pulse, even the voltage feedback loop requires one, until the current level becomes OCL level or lower. In subsequent switching cycles, the on-time is set to a fixed value and the current is monitored in the same manner.

There are some important considerations for this type of overcurrent protection. When the load current is higher than the overcurrent threshold by one half of the peak-to-peak inductor ripple current, the OCL is triggered and the output current is being limited, the output voltage tends to drop because the load demand is higher than what the converter can support. When the output voltage falls below 60% of the target voltage, the UVP comparator detects it, and the device is shut off after a wait time of 256 μ s. This protection is a latched function. The fault latching can be reset by EN going low or VCC power cycling.

The TPS51397A also implements negative overcurrent protection, which can prevent inductor current runaway when IC works in OOA mode. When the inductor valley current hits the negative overcurrent threshold (NOCL = – 3.2 A typical), the low-side FET turns off, then high-side FET turns on.

7.3.6 Overvoltage Protection

The TPS51397A has an overvoltage protection feature, which has the same implementation. When the output voltage becomes higher than 125% of the target voltage, the OVP comparator output goes high, and the output will be discharged and latched after a wait time of 120 μ s. This function is a latching operation, so it needs to reset by EN going low or VCC power cycling.

7.3.7 UVLO Protection

The VIN undervoltage lockout (UVLO) protection monitors the VCC pin voltage to protect the internal circuitry from low input voltage. When the VCC voltage is lower than the UVLO threshold voltage, the device shuts off and outputs are discharged to prevent mis-operation of the device. The converter begins operation again when the input voltage exceeds the threshold by a hysteresis of 500 mV (typical). This is a non-latch protection.

7.3.8 Output Voltage Discharge

The TPS51397A has a discharge function by using internal MOSFET about 350 Ω , which is connected to the output terminal SW. The discharge is slow due to the lower current capability of the MOSFET.

7.3.9 Thermal Shutdown

The TPS51397A monitors the internal die temperature. If the temperature exceeds the threshold value (typically 150°C), the device is shut off and the output is discharged. This is a non-latch protection. The device restarts operation when the temperature goes below the thermal shutdown threshold.

7.4 Device Functional Modes

7.4.1 Light Load Operation

The TPS51397A has a MODE pin that can control two different states of operation at light load. The light load operation includes advanced Eco-mode and OOA mode.

7.4.2 Advanced Eco-mode Control

The advanced Eco-mode control schemes to maintain high light load efficiency. As the output current decreases from heavy load conditions, the inductor current is also reduced and eventually comes to a point where the rippled valley touches zero level, which is the boundary between continuous conduction and discontinuous conduction modes. The rectifying MOSFET is turned off when the zero inductor current is detected. As the load current further decreases, the converter runs into discontinuous conduction mode. The on-time is kept almost the same as it was in continuous conduction mode so that it takes longer to discharge the output capacitor with smaller load current to the level of the reference voltage. This makes the switching frequency lower, proportional to the load current, and keeps the light load efficiency high. The light load current where the transition to Eco-mode operation happens ($I_{OUT(LL)}$) can be calculated from [方程式 3](#).

$$I_{OUT(LL)} = \frac{1}{2 \times L_{OUT} \times F_{SW}} \times \frac{(V_{IN} - V_{OUT}) \times V_{OUT}}{V_{IN}} \quad (3)$$

After identifying the application requirements, design the output inductance (L_{OUT}) so that the inductor peak-to-peak ripple current is approximately between 20% and 40% of $I_{OUT(max)}$ (peak current in the application). It is also important to size the inductor properly so that the valley current does not hit the negative low-side current limit.

7.4.3 Out-of-Audio

Out-of-Audio (OOA) light-load mode is a unique control feature that keeps the switching frequency above audible frequency with minimum reduction in efficiency. It prevents audio noise generation from the output capacitors and inductor. During Out-of-Audio operation, the OOA control circuit monitors the states of both high-side and low-side MOSFETs and forces them to switch. When both high-side and low-side MOSFETs are off for more than 30 μ s during a light-load condition, the low-side FET will discharge until output voltage drops to trigger the high-side FET on or inductor current hits negative OC limit.

If the MODE pin is selected to operate in OOA mode, when the device works at light load, the minimum switching frequency is above 20 kHz which avoids the audible noise in the system. When the device works in OOA mode, TI recommends setting the peak value of inductor current above -1 A by choosing appropriate inductor.

7.4.4 Mode Selection

The device detects the voltage on the MODE pin during start-up and latches onto one of the MODE options listed in [表 7-1](#). The voltage on the MODE pin is recommended to be set by connecting this pin to the center tap of a resistor divider connected between VCC and AGND. A guideline for the top resistor (R_{M_H}) and the bottom resistor (R_{M_L}) as 1% resistors is shown in [表 7-1](#). It is recommended to choose the resistor to set the voltage at around the middle value of each range. It is important that the voltage for the MODE pin is derived from the VCC rail only since internally this voltage is referenced to detect the MODE option, and not to leave the mode pin floating. The MODE pin setting can be reset only by a VIN power cycling or EN toggle.

表 7-1. MODE Pin Resistor Settings

VOLTAGE ON MODE	R_{M_H} (k Ω)	R_{M_L} (k Ω)	LIGHT LOAD OPERATION	FREQUENCY (kHz)
(0~10%)*VCC	330	15	Eco-mode	500
(10%~20%)*VCC	180	33	OOA	500
(20%~30%)*VCC	160	51	Eco-mode	800
(30%~50%)*VCC	75	51	OOA	800

图 7-1 shows the typical start-up sequence of the device once the enable signal crosses the EN turnon threshold. After the voltage on VCC crosses the rising UVLO threshold, it takes about 500 μ s to finish the working mode and frequency selection. The output voltage starts ramping after about $0.2 \cdot T_{SS}$ delay time.



图 7-1. Power-Up Sequence

7.4.5 Standby Operation

The TPS51397A can be placed in standby mode by pulling the EN pin low. The device operates with a shutdown current of 2 μ A when in standby condition. EN pin is pulled low internally. When floating, the part is disabled by default.

8 Application and Implementation

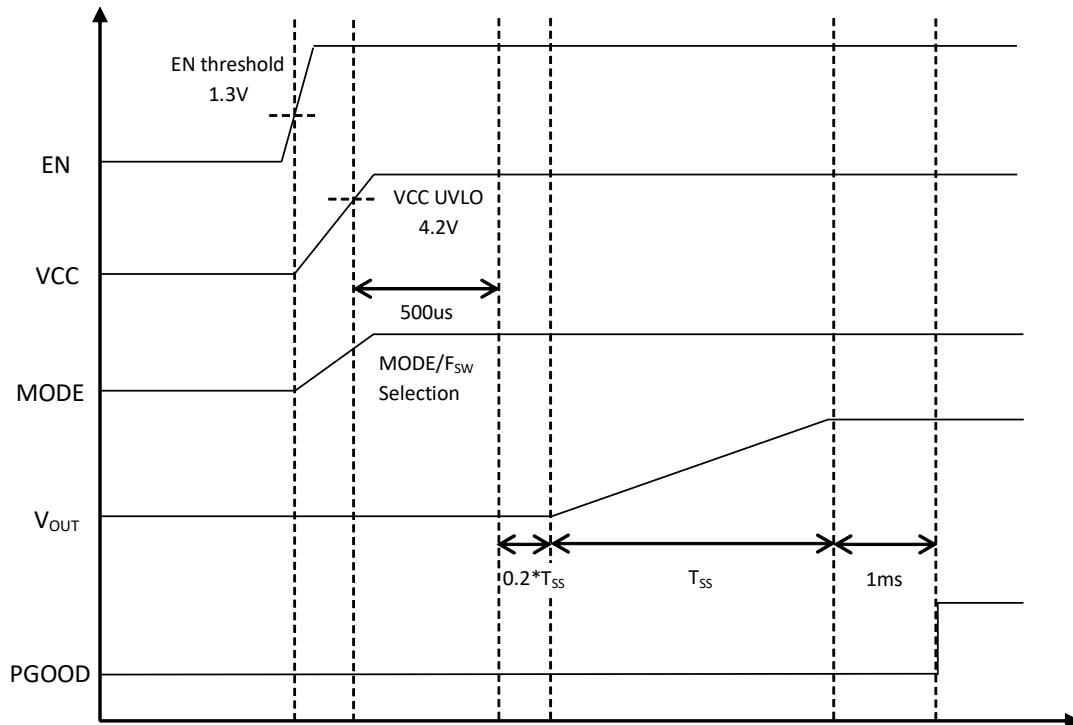
Note

以下应用部分的信息不属于 TI 组件规范，TI 不担保其准确性和完整性。客户应负责确定 TI 组件是否适用于其应用。客户应验证并测试其设计，以确保系统功能。

8.1 Application Information

The schematic in 图 8-1 shows a typical application for TPS51397A with 5-V output. This design converts an input voltage range of 5.5 V to 24 V down to 5 V with a maximum output current of 10 A.

8.2 Typical Application



图 8-1. 5-V, 10-A Reference Design

8.2.1 Design Requirements

表 8-1 lists the design parameters for this example.

表 8-1. Design Parameters

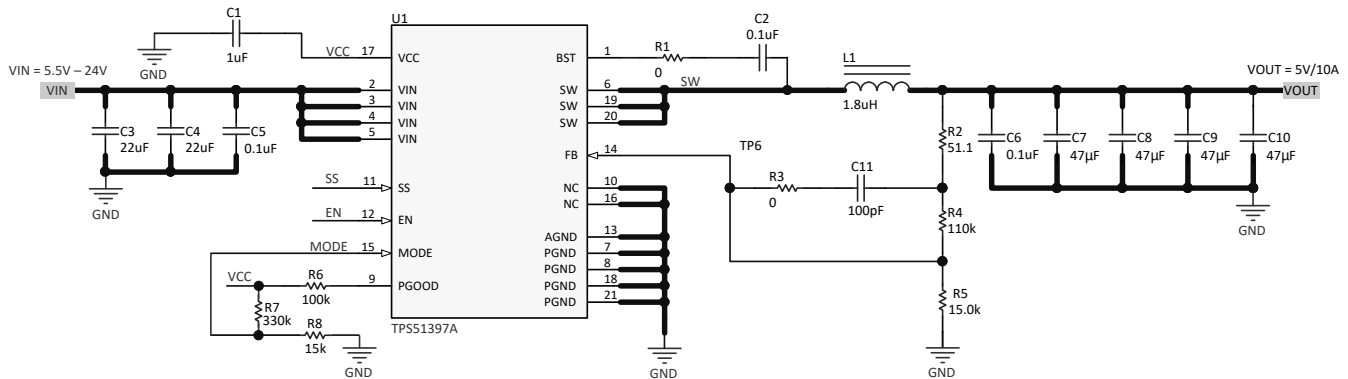
PARAMETER	CONDITIONS	MIN	TYP	MAX	UNIT
OUTPUT					
V_{OUT}	Output voltage		5		V
I_{OUT}	Output current		10		A
ΔV_{OUT}	Transient response	1-A — 9-A load step, 2.5 A/μs	$\pm 5\% \times V_{OUT}$		
V_{IN}	Input voltage	5.5	12	24	V
$V_{OUT(ripple)}$	Output voltage ripple	0-A — 10-A loading	$2\% \times V_{OUT}$		
F_{SW}	Switching frequency		500		kHz
	Light load operating mode		Eco-mode		
T_A	Ambient temperature		25		°C

8.2.2 Detailed Design Procedure

8.2.2.1 External Component Selection

8.2.2.1.1 Output Voltage Set Point

To change the output voltage of the application, it is necessary to change the value of the upper feedback resistor. By changing this resistor, you can change the output voltage above 0.6 V. See 方程式 4.

$$V_{OUT} = 0.6 \times \left(1 + \frac{R_{UPPER}}{R_{LOWER}}\right) \quad (4)$$

8.2.2.1.2 MODE Selection

The light load operation mode (Eco-mode or OOA) and switching frequency are set by a voltage divider from VCC to GND connected to the MODE pin. See 表 7-1 for possible MODE pin configurations. For this design example, the switching frequency is about 500 KHz, the light load operation mode is Eco-mode, and the output current is 10 A.

8.2.2.1.3 Inductor Selection

The inductor ripple current is filtered by the output capacitor. A higher inductor ripple current means the output capacitor should have a ripple current rating higher than the inductor ripple current. See 表 8-2 for recommended inductor values.

The RMS and peak currents through the inductor can be calculated using 方程式 5 and 方程式 6. It is important that the inductor is rated to handle these currents.

$$I_{L(rms)} = \sqrt{I_{OUT}^2 + \frac{1}{12} \times \left(\frac{V_{OUT} \times (V_{IN(max)} - V_{OUT})}{V_{IN(max)} \times L_{OUT} \times F_{SW}} \right)^2} \quad (5)$$

$$I_{L(peak)} = I_{OUT} + \frac{I_{OUT(ripple)}}{2} \quad (6)$$

Under transient and short-circuit conditions, the inductor current can increase up to the current limit of the device, so it is safe to choose an inductor with a saturation current higher than the peak current under current limit condition.

8.2.2.1.4 Output Capacitor Selection

After selecting the inductor, the output capacitor needs to be optimized. In D-CAP3, the regulator reacts within one cycle to the change in the duty cycle, so good transient performance can be achieved without needing large amounts of output capacitance. The recommended output capacitance range is given in 表 8-2. Ceramic capacitors have very low ESR, otherwise the maximum ESR of the capacitor should be less than $V_{OUT(ripple)} / I_{OUT(ripple)}$.

表 8-2. Recommended Component Values

V _{OUT} (V)	R _{LOWER} (kΩ)	R _{UPPER} (kΩ)	F _{sw} (kHz)	L _{OUT} (μH)	C _{OUT(min)} (μF)	C _{OUT(max)} (μF)	C _{FF} (pF)
0.6	10	0	500	0.33	66	330	-
			800	0.22	66	330	-
1.2	10	10	500	0.68	66	330	-
			800	0.47	66	330	-
2.5	15	47.5	500	1.2	66	330	-
			800	1.0	66	330	-
3.3	20	90	500	1.5	66	330	22-110
			800	1.2	66	330	22-110
5.0	15	110	500	1.8	66	330	22-110
			800	1.5	66	330	22-110

8.2.2.1.5 Input Capacitor Selection

The TPS51397A requires input decoupling capacitors on power supply input pin VIN, and the bulk capacitors are needed depending on the application. The minimum input capacitance required is given in 方程式 7.

$$C_{IN(min)} = \frac{I_{OUT} \times V_{OUT}}{V_{IN(ripple)} \times V_{IN} \times F_{SW}} \quad (7)$$

TI recommends using a high-quality X5R or X7R input decoupling capacitors of nominal 44 $\mu\text{F}/35\text{ V}$ on the input voltage pin VIN. The voltage rating on the input capacitor must be greater than the maximum input voltage. The capacitor must also have a ripple current rating greater than the maximum input current ripple of the application. The input ripple current is calculated by [方程式 8](#):

$$I_{\text{CIN(rms)}} = I_{\text{OUT}} \times \sqrt{\frac{V_{\text{OUT}}}{V_{\text{IN(min)}}} \times \frac{(V_{\text{IN(min)}} - V_{\text{OUT}})}{V_{\text{IN(min)}}}} \quad (8)$$

8.2.3 Application Curves

图 8-2 through 图 8-17 apply to the circuit of 图 8-1. $V_{IN} = 12\text{ V}$, $T_A = 25^\circ\text{C}$, unless otherwise specified.



图 8-2. Efficiency Curve



图 8-3. Load Regulation

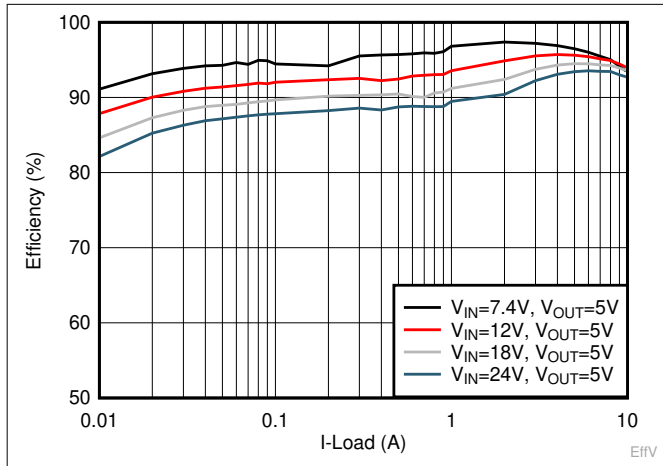

图 8-4. Switching Frequency vs Input Voltage, $I_{OUT} = 5\text{ A}$

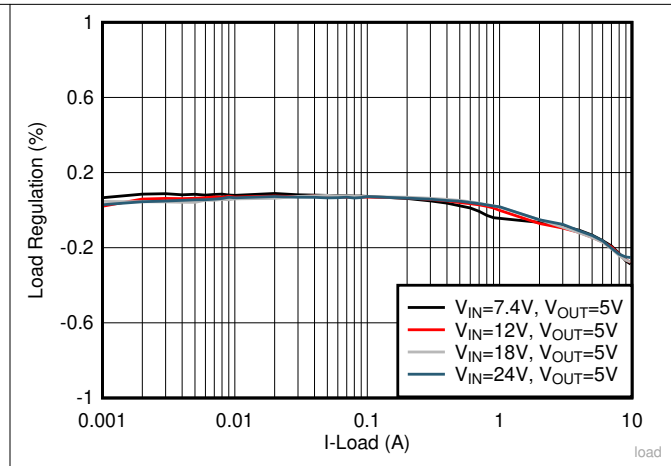

图 8-5. Switching Frequency vs Output Load

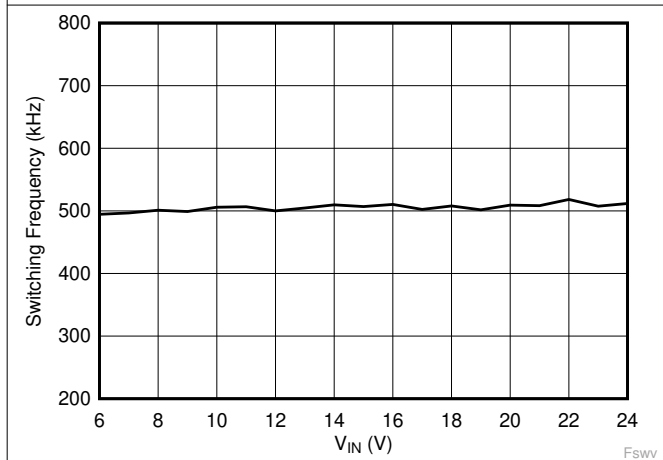

图 8-6. Line Regulation, $I_{OUT} = 0.1\text{ A}$

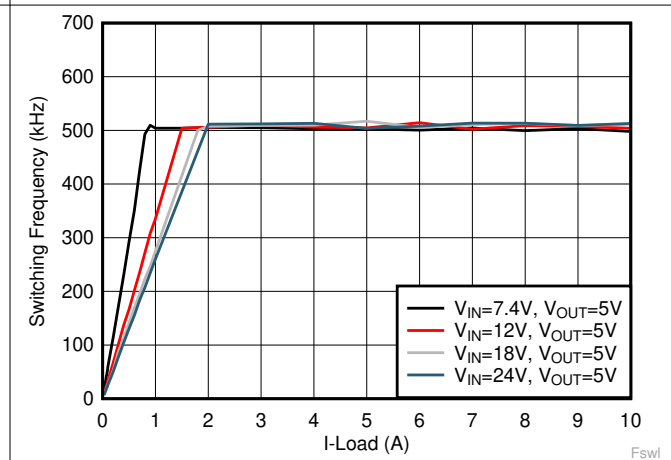

图 8-7. Line Regulation, $I_{OUT} = 5\text{ A}$

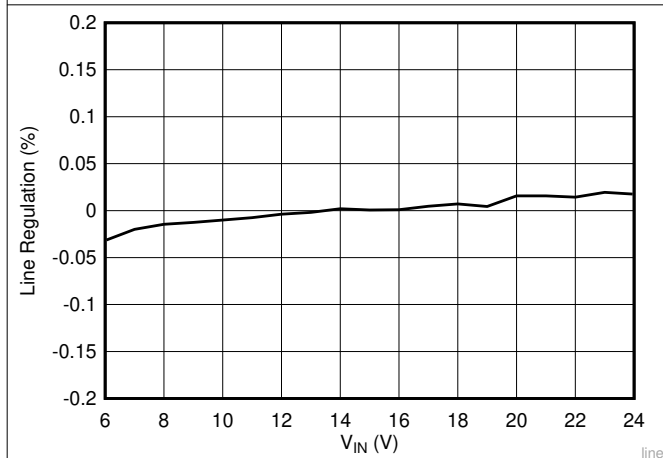

图 8-8. Start-Up Through EN, $I_{OUT} = 5\text{ A}$

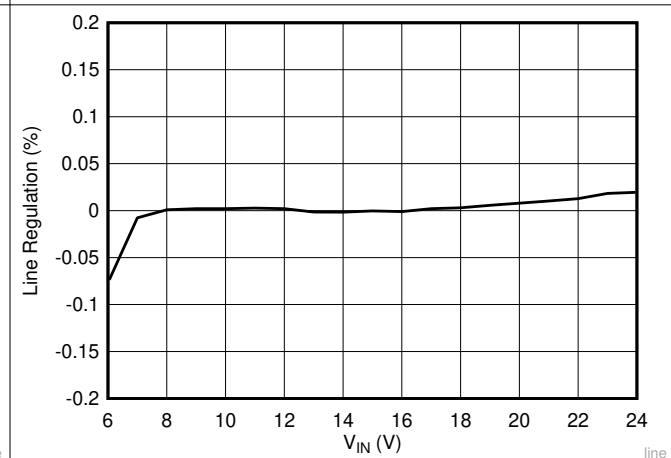

图 8-9. Shut-down Through EN, $I_{OUT} = 5\text{ A}$

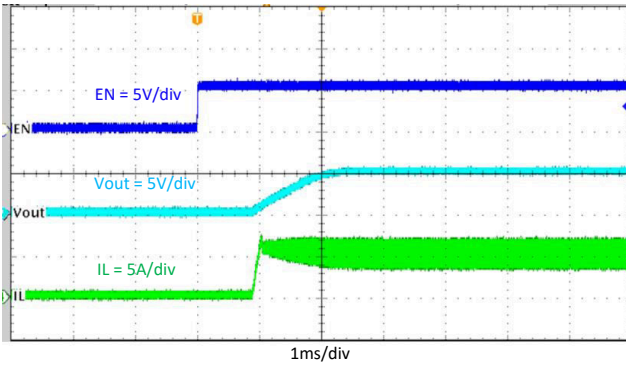

图 8-10. Start-up Relative to VIN Rising, $I_{OUT} = 5\text{ A}$

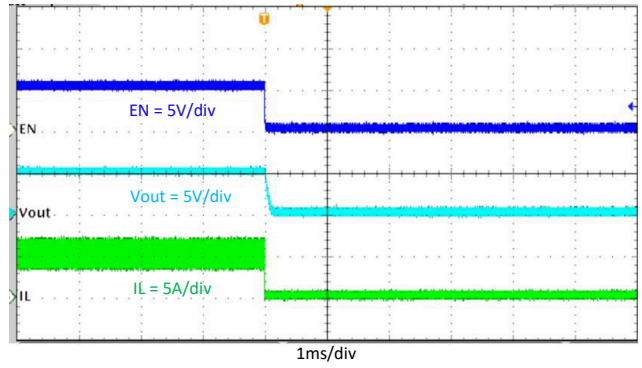

图 8-11. Shut Down Relative to VIN Falling, $I_{OUT} = 5\text{ A}$

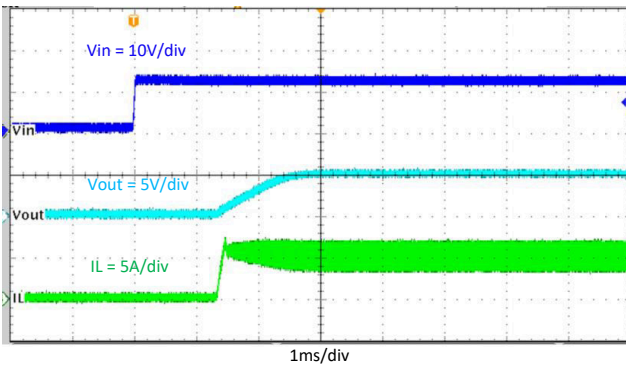

图 8-12. Output Voltage Ripple, $I_{OUT} = 0.1\text{ A}$

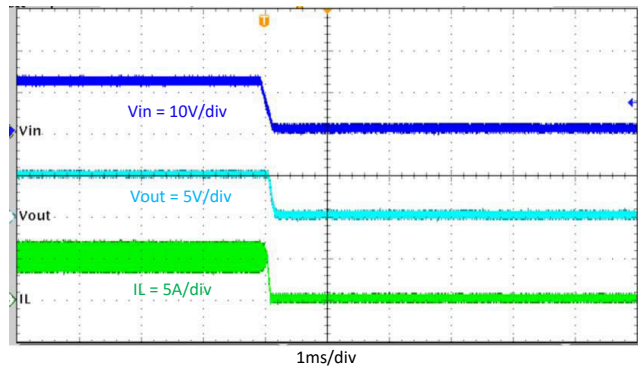

图 8-13. Output Voltage Ripple, $I_{OUT} = 5\text{ A}$

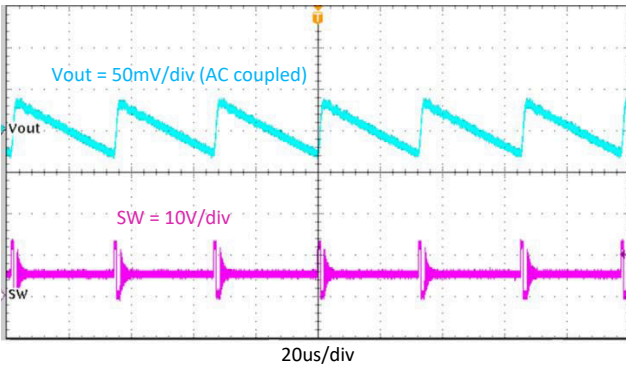

图 8-14. Output Voltage Ripple, $I_{OUT} = 10\text{ A}$

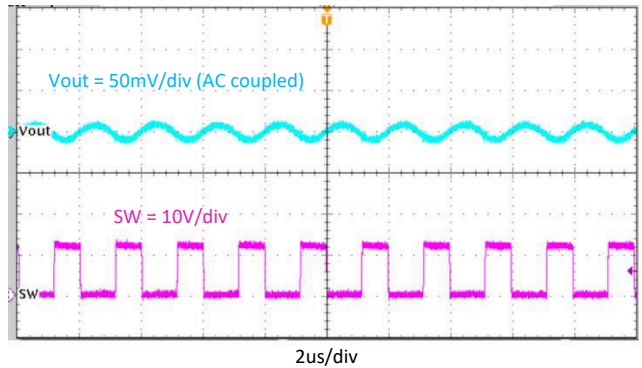

图 8-15. Transient Response, 1 A to 9 A, Slew Rate = $2.5\text{ A}/\mu\text{s}$

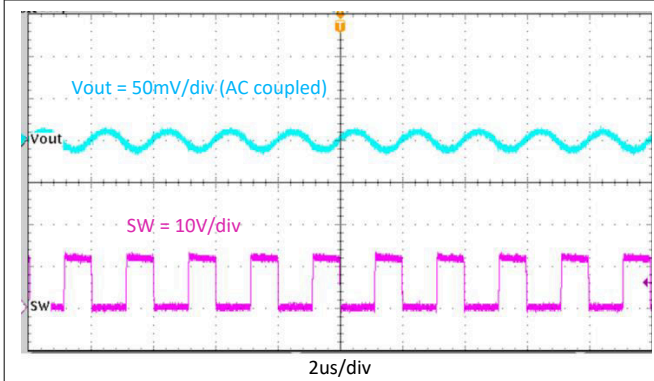

图 8-16. Transient Response, 0 A to 10 A, Slew Rate = $2.5\text{ A}/\mu\text{s}$

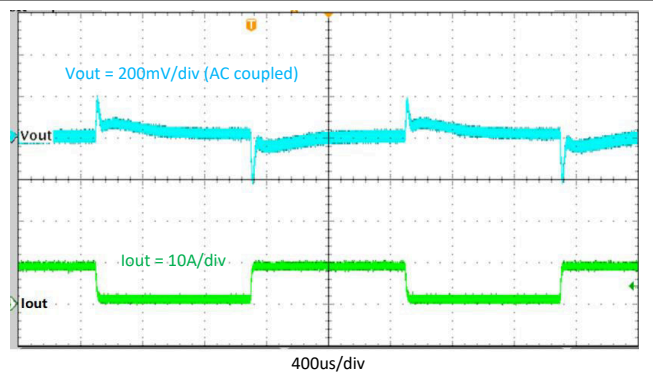

图 8-17. Normal Operation to Output Hard Short

9 Power Supply Recommendations

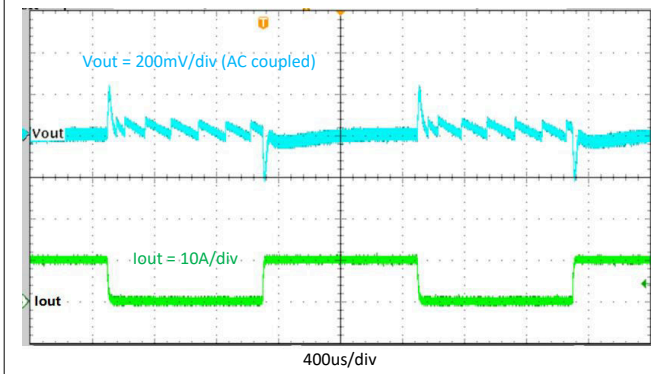
The TPS51397A is intended to be powered by a well-regulated DC voltage. The input voltage range is 4.5 V to 24 V. The TPS51397A is a buck converter. The input supply voltage must be greater than the desired output voltage for proper operation. Input supply current must be appropriate for the desired output current. If the input voltage supply is located far away from the TPS51397A circuit, some additional input bulk capacitance is recommended. Typical values are 100 μ F to 470 μ F.

10 Layout

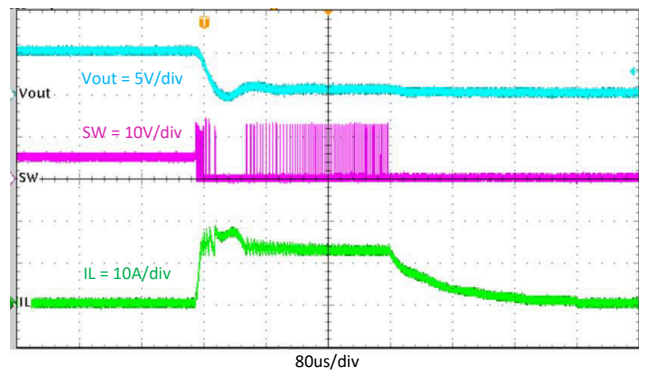
10.1 Layout Guidelines

- A four-layer PCB is recommended for good thermal performance and with maximum ground plane. 3-inch × 2.75-inch, top and bottom layer PCB with 2-oz copper is used as example.
- Place the decoupling capacitors right across VIN and VCC as close as possible.
- Place output inductors and capacitors with IC at the same layer. SW routing should be as short as possible to minimize EMI, and should be a width plane to carry big current, enough vias should be added to the PGND connection of output capacitors and also as close to the output pin as possible.
- Place BST resistor and capacitor with IC at the same layer, close to BST and SW plane. >10-mil width trace is recommended to reduce line parasitic inductance.
- Feedback can be 10 mil and must be routed away from the switching node, BST node, or other high speed digital signal.
- VIN trace must be wide to reduce the trace impedance and provide enough current capability.
- Place multiple vias under the device near VIN and PGND and near input capacitors to reduce parasitic inductance and improve thermal performance.

10.2 Layout Example

图 10-1 shows the recommended top-side layout. Component reference designators are the same as the circuit shown in 图 8-1.



图 10-1. Top-Side Layout

11 Device and Documentation Support

11.1 Receiving Notification of Documentation Updates

To receive notification of documentation updates, navigate to the device product folder on ti.com. In the upper right corner, click on *Alert me* to register and receive a weekly digest of any product information that has changed. For change details, review the revision history included in any revised document.

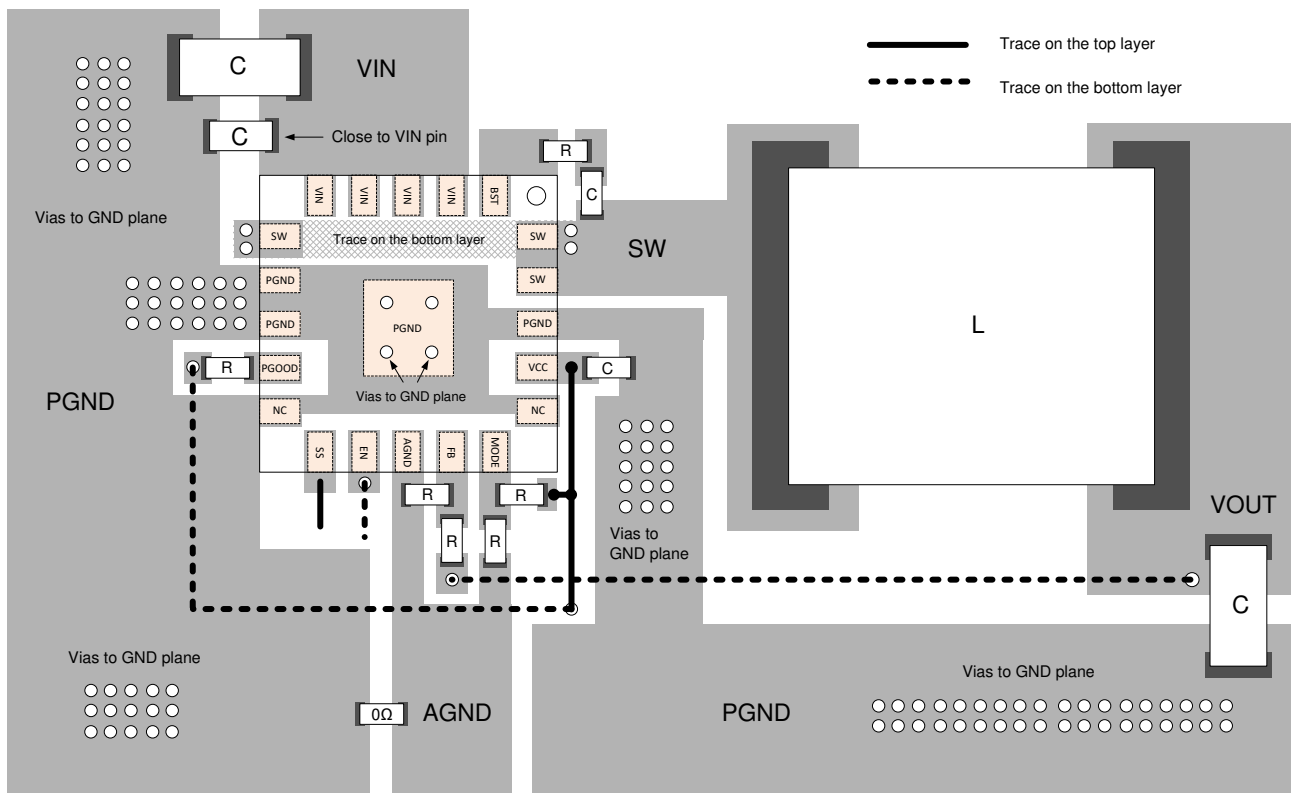
11.2 支持资源

TI E2E™ 支持论坛是工程师的重要参考资料，可直接从专家获得快速、经过验证的解答和设计帮助。搜索现有解答或提出自己的问题可获得所需的快速设计帮助。

链接的内容由各个贡献者“按原样”提供。这些内容并不构成 TI 技术规范，并且不一定反映 TI 的观点；请参阅 TI 的《使用条款》。

11.3 Trademarks

ULQ™, DCAP3™, D-CAP3™, Eco-mode™, 无声™, HotRod™, TI E2E™ are trademarks of Texas Instruments.

所有商标均为其各自所有者的财产。

11.4 静电放电警告



静电放电 (ESD) 会损坏这个集成电路。德州仪器 (TI) 建议通过适当的预防措施处理所有集成电路。如果不遵守正确的处理和安装程序，可能会损坏集成电路。

ESD 的损坏小至导致微小的性能降级，大至整个器件故障。精密的集成电路可能更容易受到损坏，这是因为非常细微的参数更改都可能会导致器件与其发布的规格不相符。

11.5 术语表

TI 术语表

本术语表列出并解释了术语、首字母缩略词和定义。

12 Mechanical, Packaging, and Orderable Information

The following pages include mechanical, packaging, and orderable information. This information is the most current data available for the designated devices. This data is subject to change without notice and revision of this document. For browser-based versions of this data sheet, refer to the left-hand navigation.

PACKAGING INFORMATION

Orderable Device	Status (1)	Package Type	Package Drawing	Pins	Package Qty	Eco Plan (2)	Lead finish/ Ball material (6)	MSL Peak Temp (3)	Op Temp (°C)	Device Marking (4/5)	Samples
TPS51397ARJER	ACTIVE	VQFN-HR	RJE	20	3000	RoHS & Green	Call TI SN NIPDAU	Level-2-260C-1 YEAR	-40 to 125	51397A	Samples

(1) The marketing status values are defined as follows:

ACTIVE: Product device recommended for new designs.

LIFEBUY: TI has announced that the device will be discontinued, and a lifetime-buy period is in effect.

NRND: Not recommended for new designs. Device is in production to support existing customers, but TI does not recommend using this part in a new design.

PREVIEW: Device has been announced but is not in production. Samples may or may not be available.

OBSELETE: TI has discontinued the production of the device.

(2) **RoHS:** TI defines "RoHS" to mean semiconductor products that are compliant with the current EU RoHS requirements for all 10 RoHS substances, including the requirement that RoHS substance do not exceed 0.1% by weight in homogeneous materials. Where designed to be soldered at high temperatures, "RoHS" products are suitable for use in specified lead-free processes. TI may reference these types of products as "Pb-Free".

RoHS Exempt: TI defines "RoHS Exempt" to mean products that contain lead but are compliant with EU RoHS pursuant to a specific EU RoHS exemption.

Green: TI defines "Green" to mean the content of Chlorine (Cl) and Bromine (Br) based flame retardants meet JS709B low halogen requirements of <=1000ppm threshold. Antimony trioxide based flame retardants must also meet the <=1000ppm threshold requirement.

(3) MSL, Peak Temp. - The Moisture Sensitivity Level rating according to the JEDEC industry standard classifications, and peak solder temperature.

(4) There may be additional marking, which relates to the logo, the lot trace code information, or the environmental category on the device.

(5) Multiple Device Markings will be inside parentheses. Only one Device Marking contained in parentheses and separated by a "~" will appear on a device. If a line is indented then it is a continuation of the previous line and the two combined represent the entire Device Marking for that device.

(6) Lead finish/Ball material - Orderable Devices may have multiple material finish options. Finish options are separated by a vertical ruled line. Lead finish/Ball material values may wrap to two lines if the finish value exceeds the maximum column width.

Important Information and Disclaimer:The information provided on this page represents TI's knowledge and belief as of the date that it is provided. TI bases its knowledge and belief on information provided by third parties, and makes no representation or warranty as to the accuracy of such information. Efforts are underway to better integrate information from third parties. TI has taken and continues to take reasonable steps to provide representative and accurate information but may not have conducted destructive testing or chemical analysis on incoming materials and chemicals. TI and TI suppliers consider certain information to be proprietary, and thus CAS numbers and other limited information may not be available for release.

In no event shall TI's liability arising out of such information exceed the total purchase price of the TI part(s) at issue in this document sold by TI to Customer on an annual basis.

GENERIC PACKAGE VIEW

RJE 20

VQFN-HR - 1 mm max height

3 x 3, 0.45 mm pitch

QUAD FLATPACK- NO LEAD

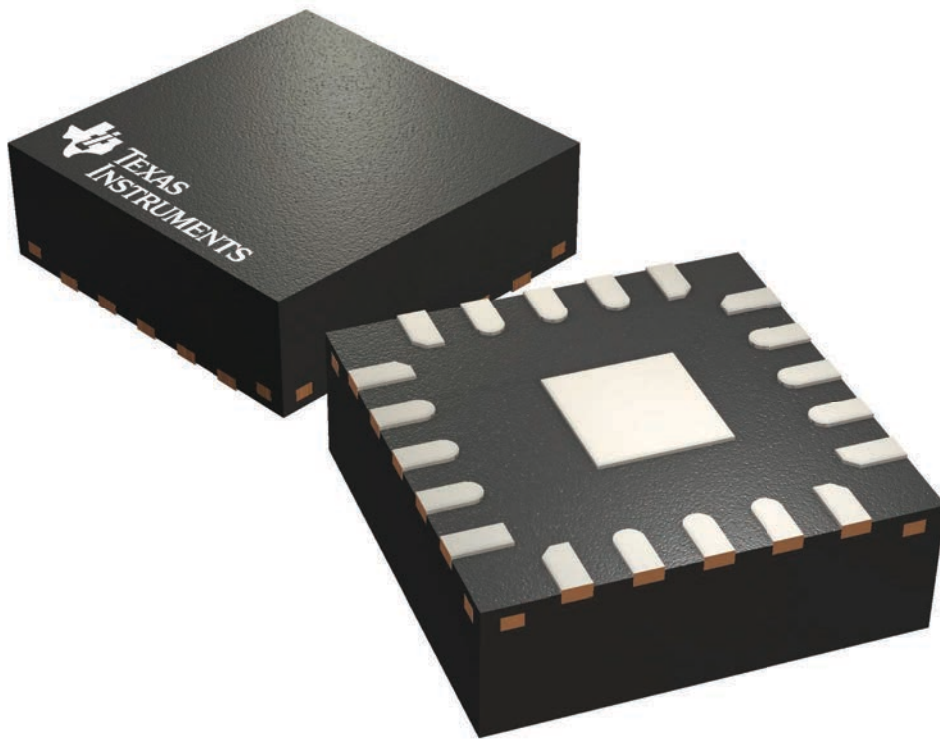

Images above are just a representation of the package family, actual package may vary.
Refer to the product data sheet for package details.

4224683/A

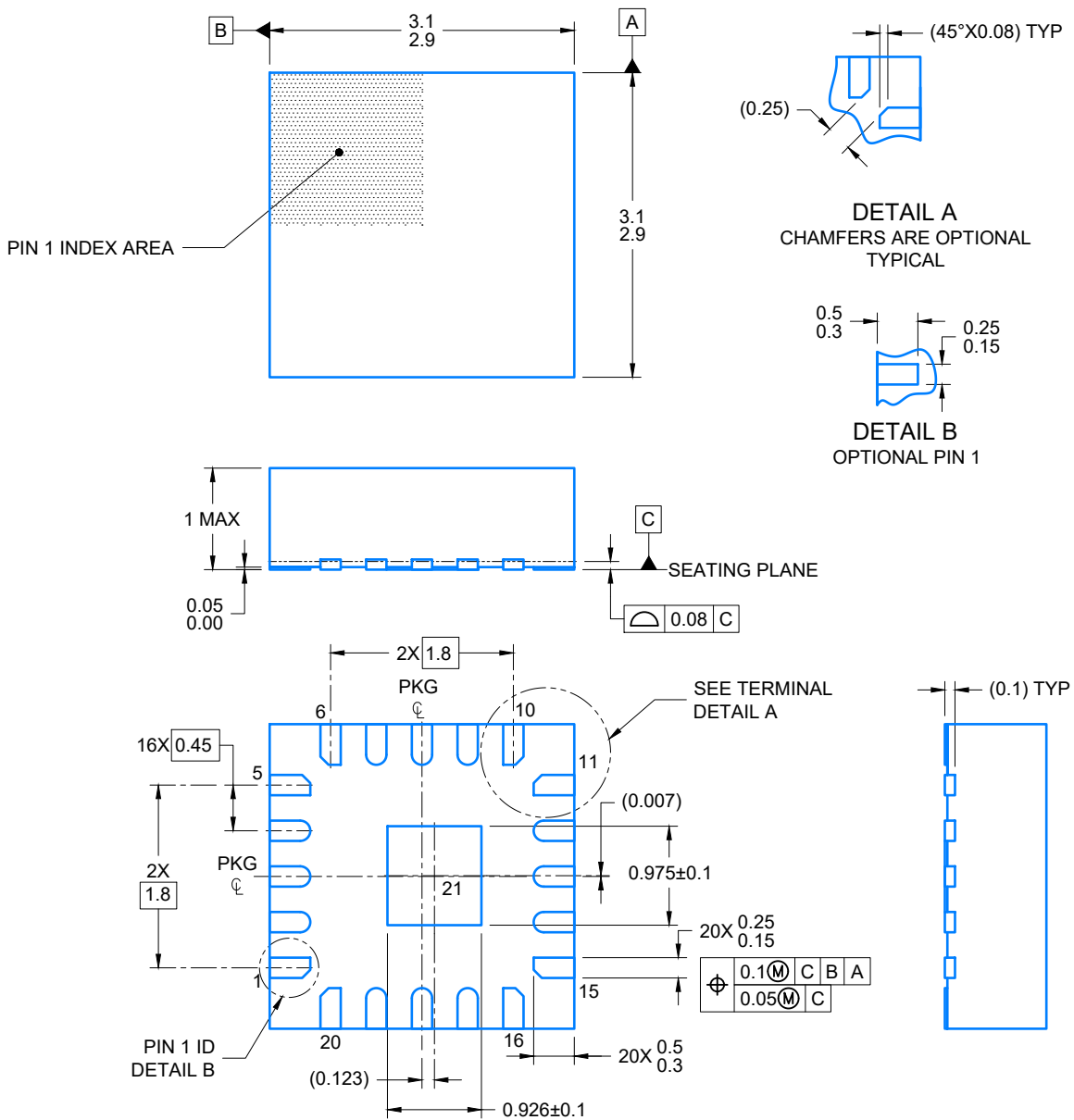

4224338 / B 10/2018

NOTES:

1. All linear dimensions are in millimeters. Any dimensions in parenthesis are for reference only. Dimensioning and tolerancing per ASME Y14.5M.
2. This drawing is subject to change without notice.
3. The package thermal pad must be soldered to the printed circuit board for optimal thermal and mechanical performance.

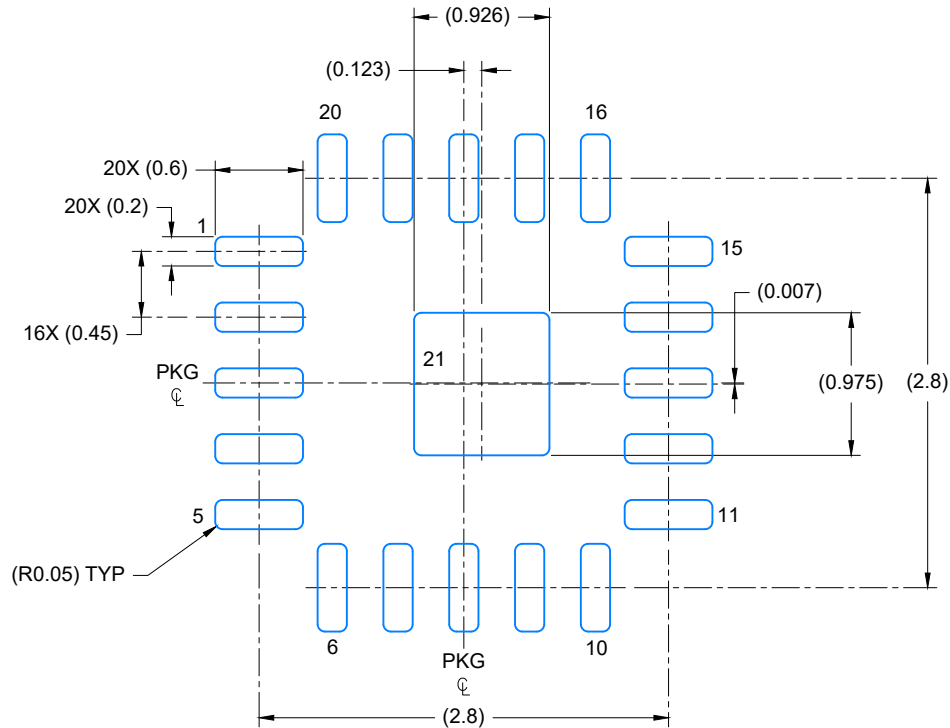

LAND PATTERN EXAMPLE
EXPOSED METAL SHOWN
SCALE: 20X

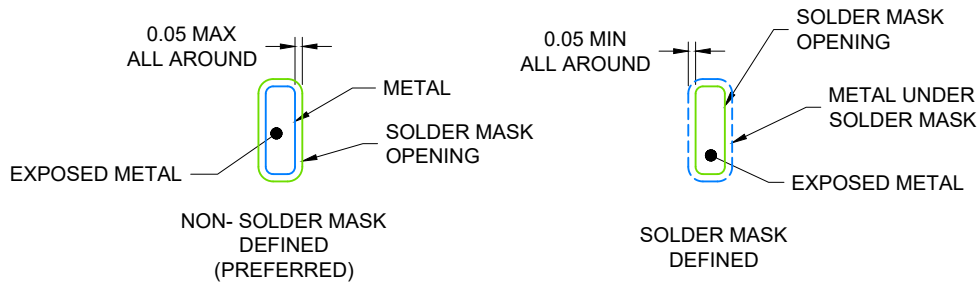

SOLDER MASK DETAILS

4224338 / B 07/2018

NOTES: (continued)

4. This package is designed to be soldered to a thermal pad on the board. For more information, see Texas Instruments literature number SLUA271 (www.ti.com/lit/sluea271).
5. Solder mask tolerances between and around signal pads can vary based on board fabrication site.

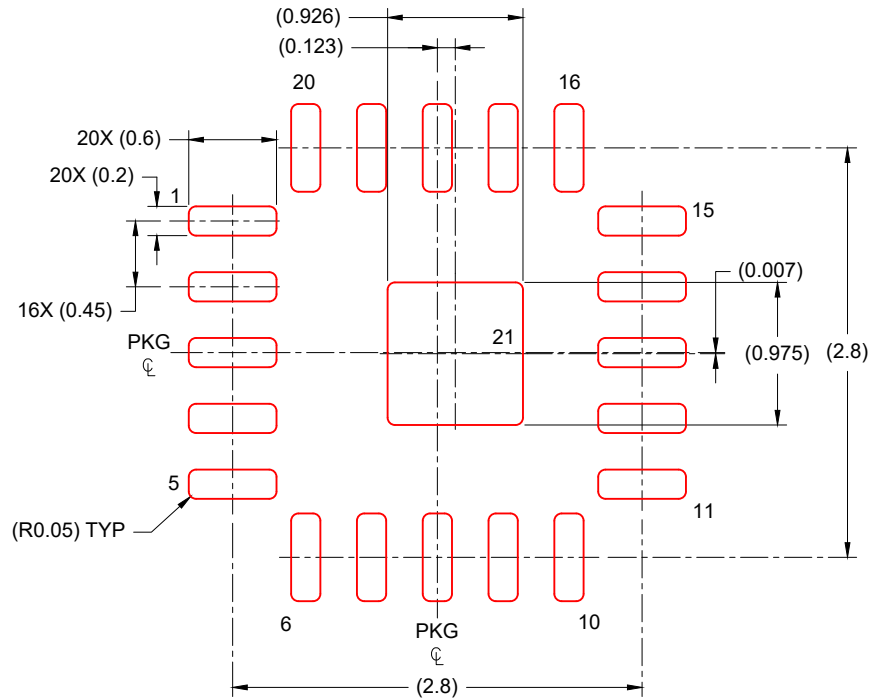

SOLDER PASTE EXAMPLE
 BASED ON 0.1 mm THICK STENCIL

PRINTED SOLDER COVERAGE BY AREA UNDER PACKAGE
 SCALE: 20X

4224338 / B 07/2018

NOTES: (continued)

- 6. Laser cutting apertures with trapezoidal walls and rounded corners may offer better paste release. IPC-7525 may have alternate design recommendations..

重要声明和免责声明

TI“按原样”提供技术和可靠性数据（包括数据表）、设计资源（包括参考设计）、应用或其他设计建议、网络工具、安全信息和其他资源，不保证没有瑕疵且不做任何明示或暗示的担保，包括但不限于对适销性、某特定用途方面的适用性或不侵犯任何第三方知识产权的暗示担保。

这些资源可供使用 TI 产品进行设计的熟练开发人员使用。您将自行承担以下全部责任：(1) 针对您的应用选择合适的 TI 产品，(2) 设计、验证并测试您的应用，(3) 确保您的应用满足相应标准以及任何其他功能安全、信息安全、监管或其他要求。

这些资源如有变更，恕不另行通知。TI 授权您仅可将这些资源用于研发本资源所述的 TI 产品的应用。严禁对这些资源进行其他复制或展示。您无权使用任何其他 TI 知识产权或任何第三方知识产权。您应全额赔偿因在这些资源的使用中对 TI 及其代表造成的任何索赔、损害、成本、损失和债务，TI 对此概不负责。

TI 提供的产品受 [TI 的销售条款](#) 或 [ti.com](#) 上其他适用条款/TI 产品随附的其他适用条款的约束。TI 提供这些资源并不会扩展或以其他方式更改 TI 针对 TI 产品发布的适用的担保或担保免责声明。

TI 反对并拒绝您可能提出的任何其他或不同的条款。

邮寄地址：Texas Instruments, Post Office Box 655303, Dallas, Texas 75265

Copyright © 2024，德州仪器 (TI) 公司