

TPS56637 4.5V 至 28V 输入、6A 同步降压转换器

1 特性

- 4.5V 至 28V 输入电压范围
- 0.6V 至 13V 输出电压范围
- 6A 最大连续输出电流
- 集成式 26mΩ 和 12mΩ MOSFET
- 0.6V ±1% 基准电压
- D-CAP3™控制模式，用于快速瞬态响应
- Eco-mode™和 FCCM（强制持续导通模式）可选，适用于通过 MODE 引脚的轻负载运行
- 内部 2ms 软启动
- 内置输出放电功能
- 500kHz 开关频率
- 电源正常状态指示器，可监控输出电压
- 逐周期过流限制
- 非闭锁 UV、OV、OT 和 UVLO 保护
- -40°C 至 +150°C 的工作结温范围
- 小型 10 引脚 3.0mm × 3.0mm HotRod™四方扁平无引线 (QFN) 封装
- 可使用 WEBENCH® 电源设计器创建定制设计方案

2 应用

- 企业系统：多功能打印机、存储
- 个人电子产品：电视、扬声器、机顶盒、便携式电子产品
- 工业应用：电子销售终端、工厂自动化和控制、电机驱动
- 通用 12V、19V、24V 总线电源

3 说明

TPS56637 是一款配备了集成式 MOSFET 且具有高效率、高电压输入、易于使用的同步降压转换器。

由于具有 4.5V 至 28V 的宽工作输入电压范围，TPS56637 非常适用于由 12V、19V 和 24V 总线电源轨供电的系统。其输出电压为 0.6V 至 13V，支持高达 6A 的持续输出电流。

TPS56637 利用 DCAP3™控制模式提供快速瞬态响应、良好的线路和负载调节，无需外部补偿，并支持低等效串联电阻 (ESR) 输出电容器，如 POSCAP 和 MLCC。

TPS56637 兼具 FCCM 和 Eco-mode™两种运行模式，可在轻负载条件下通过 MODE 引脚配置进行选择。要在轻负载条件下实现高效率，可以选择 Eco-mode™。FCCM 符合严格的输出电压纹波要求。

TPS56637 具有完整的非闭锁 OV（过压）、UV（欠压）、OC（过流）、OT（过热）以及 UVLO（欠压锁定）保护以及电源正常状态指示器和输出放电功能特性。

TPS56637 采用 10 引脚 3.0mm × 3.0mm HotRod™QFN 封装，额定结温范围为 -40°C 至 150°C。

器件信息(1)

器件型号	封装	封装尺寸 (标称值)
TPS56637	VQFN-HR (10)	3.00mm × 3.00mm

(1) 如需了解所有可用封装，请参阅数据表末尾的可订购产品附录。

简化原理图

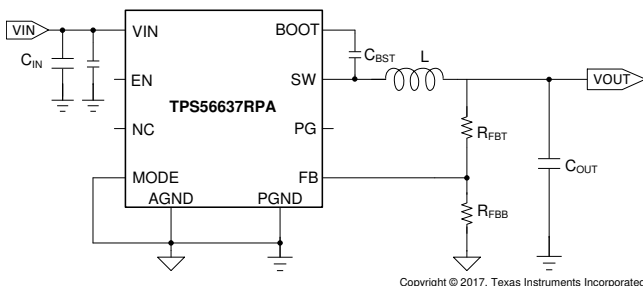

效率与输出电流间的关系
 $V_{OUT} = 5V$

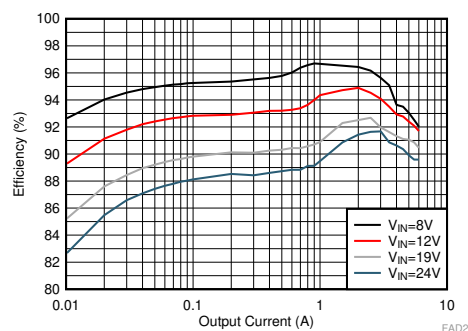

目录

1	特性	1	7.4	Device Functional Modes.....	17
2	应用	1	8	Application and Implementation	18
3	说明	1	8.1	Application Information.....	18
4	修订历史记录	2	8.2	Typical Application	18
5	Pin Configuration and Functions	3	9	Power Supply Recommendations	24
6	Specifications	4	10	Layout	24
6.1	Absolute Maximum Ratings	4	10.1	Layout Guidelines	24
6.2	Handling Ratings.....	4	10.2	Layout Example	25
6.3	Recommended Operating Conditions.....	4	11	器件和文档支持	26
6.4	Thermal Information	4	11.1	文档支持	26
6.5	Electrical Characteristics.....	5	11.2	接收文档更新通知	26
6.6	Timing Requirements	6	11.3	社区资源.....	26
6.7	Typical Characteristics	7	11.4	商标.....	26
7	Detailed Description	10	11.5	静电放电警告.....	26
7.1	Overview	10	11.6	Glossary	26
7.2	Functional Block Diagram	11	12	机械、封装和可订购信息	26
7.3	Feature Description.....	12	12.1	Package Option Addendum	27

4 修订历史记录

Changes from Original (July 2018) to Revision A

Page

• 已更改 将销售状态从“预告信息”更改为“生产数据”	1
-----------------------------------	----------

5 Pin Configuration and Functions

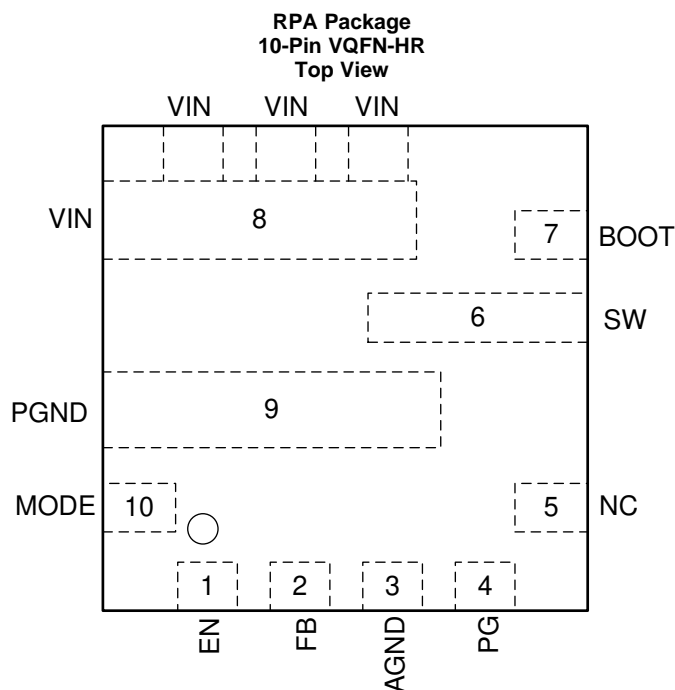

Pin Functions

PIN		TYPE	DESCRIPTION
NAME	NO.		
AGND	3	G	Ground of internal analog circuitry. Connect AGND to PGND plane at a single point.
BOOT	7	I	Supply input for the gate drive voltage of the high-side MOSFET. Connect a 0.1- μ F bootstrap capacitor between BOOT and SW.
EN	1	I	Enable input control. Driving EN high or leaving this pin floating enables the converter. A resistor divider can be used to imply an UVLO function.
FB	2	I	Output feedback. Connect FB to the tap of an external resistor divider from the output to GND to set the output voltage.
MODE	10	I	Operation mode selection pin. Leaving this pin floating (≥ 500 k Ω) forces the TPS56637 into FCCM. Connecting this pin to GND (≤ 10 k Ω) forces the TPS56637 into Eco-mode™ under light load.
NC	5	N	Not Connected, keep this pin floating.
PG	4	O	Open Drain Power Good Indicator, it is asserted low if output voltage is out of PG threshold due to over-voltage, under-voltage, thermal shutdown, EN shutdown or during soft-start.
PGND	9	G	Power GND terminal. Source terminal of low side MOSFET.
SW	6	O	Switching node terminal. Connect the output inductor to this pin with wide and short tracks
VIN	8	P	Input voltage supply pin. Drain terminal of high-side MOSFET. Connect the input decoupling capacitors between VIN and GND.

6 Specifications

6.1 Absolute Maximum Ratings

Over the recommended operating junction temperature range of -40°C to $+150^{\circ}\text{C}$ (unless otherwise noted)⁽¹⁾

		MIN	MAX	UNIT
Input voltage	V _{IN}	-0.3	32	V
	BOOT	-0.3	SW+6	V
	BOOT-SW	-0.3	6.0	V
	EN, FB, MODE	-0.3	6.0	V
	PGND, AGND	-0.3	0.3	V
Output voltage	SW	-0.3	32	V
	SW (<10 ns transient)	-4	32.5	V
	PG	-0.3	6	V
Operating junction temperature, T _J		-40	150	°C
Storage temperature, T _{stg}		-65	150	°C

(1) Stresses beyond those listed under [Absolute Maximum Ratings](#) may cause permanent damage to the device. These are stress ratings only, which do not imply functional operation of the device at these or any other conditions beyond those indicated under Recommended Operating Conditions. Exposure to absolute-maximum-rated conditions for extended periods may affect device reliability.

6.2 Handling Ratings

			VALUE	UNIT
V _{ESD}	Electrostatic discharge	Human body model (HBM), per ANSI/ESDA/JEDEC JS-001, all pins ⁽¹⁾	±2000	V
		Charged device model (CDM), per JEDEC specification JESD22-C101, all pins ⁽²⁾	±500	

(1) JEDEC document JEP155 states that 500-V HBM allows safe manufacturing with a standard ESD control process.

(2) JEDEC document JEP157 states that 250-V CDM allows safe manufacturing with a standard ESD control process.

6.3 Recommended Operating Conditions

Over the recommended operating junction temperature range of -40°C to 150°C (unless otherwise noted).⁽¹⁾

		MIN	NOM	MAX	UNIT
Input Voltage	V _{IN}	4.5		28	V
	BOOT	4.5		33.5	V
	BOOT-SW	-0.1		5.5	V
	EN, FB, MODE	-0.1		5.5	V
	PGND, AGND	-0.1		0.1	V
Output Voltage	SW	-0.1		28	V
	PG	-0.1		5.5	V
Operating junction temperature, T _J		-40		150	°C

(1) Recommended Operating Conditions indicate conditions for which the device is intended to be functional, but do not guarantee specific performance limits. For guaranteed specifications, see Electrical Characteristics

6.4 Thermal Information

THERMAL METRIC ⁽¹⁾		TPS56637	UNIT
		QFN HOTROD	
		10 PINS	
R _{θJA}	Junction-to-ambient thermal resistance	49.1	°C/W
R _{θJC(top)}	Junction-to-case (top) thermal resistance	28.8	°C/W
R _{θJB}	Junction-to-board thermal resistance	16.1	°C/W
Ψ _{JT}	Junction-to-top characterization parameter	0.8	°C/W
Ψ _{JB}	Junction-to-board characterization parameter	16.2	°C/W

(1) For more information about traditional and new thermal metrics, see the [Semiconductor and IC Package Thermal Metrics](#) application report.

6.5 Electrical Characteristics

The electrical ratings specified in this section apply to all specifications in this document unless otherwise noted. These specifications are interpreted as conditions that will not degrade the parametric or functional specifications of the device for the life of the product containing it. Typical values correspond to $T_J = 25^\circ\text{C}$, $V_{IN} = 12\text{ V}$. Minimum and maximum limits are based on $T_J = -40^\circ\text{C}$ to $+150^\circ\text{C}$, $V_{IN} = 4.5\text{ V}$ to 28 V (unless otherwise noted).

PARAMETER		TEST CONDITIONS	MIN	TYP	MAX	UNIT
SUPPLY CURRENT						
I_Q	Quiescent current, Operating at ULQ mode ⁽¹⁾			140		μA
I_{SD}	Shutdown supply current	$T_J = 25^\circ\text{C}$, $V_{EN} = 0\text{ V}$		2		μA
UVLO						
UVLO	V_{IN} Under-Voltage Lockout	Wake up V_{IN} voltage	4.0	4.2	4.4	V
		Shut down V_{IN} voltage	3.6	3.7	3.8	V
		Hysteresis V_{IN} voltage		500		mV
ENABLE(EN PIN)						
I_{EN_INPUT}	Input current	$V_{EN} = 1.1\text{ V}$		1		μA
I_{EN_HYS}	Hysteresis current	$V_{EN} = 1.3\text{ V}$		4		μA
$V_{EN(ON)}$	Enable threshold	EN rising		1.18	1.26	V
$V_{EN(OFF)}$		EN falling	1.04	1.12		V
FEEDBACK VOLTAGE						
V_{FB}	Feedback voltage	$V_{OUT} = 5\text{ V}$, continuous mode operation, $T_J = 25^\circ\text{C}$	0.594	0.6	0.606	V
		$V_{OUT} = 5\text{ V}$, continuous mode operation, $T_J = -40^\circ\text{C}$ to 150°C	0.591	0.6	0.609	V
MOSFET						
$R_{DS(on)h}$	High side switch resistance	$T_J = 25^\circ\text{C}$, $V_{BST} - V_{SW} = 5\text{ V}$		26		$\text{m}\Omega$
$R_{DS(on)l}$	Low side switch resistance	$T_J = 25^\circ\text{C}$		12		$\text{m}\Omega$
CURRENT LIMIT						
I_{OCL}	Valley current limit		6.3	7.5	8.6	A
I_{OC_REV}	Reverse current limit for FCCM Mode		2.3	3	3.7	A
POWER GOOD						
V_{PGTH}	PG lower threshold - falling	% of V_{FB}		85%		
	PG lower threshold - rising	% of V_{FB}		90%		
	PG upper threshold - falling	% of V_{FB}		110%		
	PG upper threshold - rising	% of V_{FB}		115%		
I_{PGSINK}	PG sink current	$V_{FB} = 0.5\text{ V}$, $V_{PG} = 0.5\text{ V}$		1.5		mA
I_{PGLK}	PG leakage current	$V_{PG} = 5.5\text{ V}$	-1		1	μA
FREQUENCY						
F_{SW}	Switching frequency	$V_{OUT} = 5\text{ V}$, continuous mode operation		500		kHz
OUTPUT UNDERVOLTAGE AND OVERVOLTAGE PROTECTION						
V_{OVP}	Output OVP threshold	OVP detect(L>H)		125%		
		Hysteresis		5%		
V_{UVP}	Output UVP threshold	Hiccup detect(H>L)		65%		
		Hysteresis		5%		
THERMAL SHUTDOWN						
T_{SDN}	Thermal shutdown threshold ⁽²⁾	Temperature Rising		165		$^\circ\text{C}$
		Hysteresis		30		$^\circ\text{C}$
SW DISCHARGE RESISTANCE						
R_{DISCHG}	V_{OUT} discharge resistance	$V_{EN} = 0$, $V_{SW} = 0.5\text{ V}$, $T_J = 25^\circ\text{C}$		200		Ω

(1) Not representative of the total input current of the system when in regulation. Ensured by design and characterization test.

(2) Not production tested. Ensured by design and engineering sample correlation.

6.6 Timing Requirements

The electrical ratings specified in this section apply to all specifications in this document unless otherwise noted. These specifications are interpreted as conditions that will not degrade the parametric or functional specifications of the device for the life of the product containing it. Typical values correspond to $T_J = 25^\circ\text{C}$, $V_{IN} = 12\text{ V}$. Minimum and maximum limits are based on $T_J = -40^\circ\text{C}$ to $+150^\circ\text{C}$, $V_{IN} = 4.5\text{ V}$ to 28 V (unless otherwise noted).

PARAMETER		TEST CONDITIONS	MIN	TYP	MAX	UNIT
ON-TIME TIMER CONTROL						
$t_{ON(MIN)}$	Minimum on time ⁽¹⁾			50		ns
$t_{OFF(MIN)}$	Minimum off time	$V_{FB} = 0.5\text{ V}$, measure SW at 50% V_{IN} , Eco-mode		200	300	ns
SOFT START						
T_{SS}	Soft start time	Internal soft-start time		2		ms
OUTPUT UNDERVOLTAGE PROTECTION						
T_{UVP_WAIT}	UV protection hiccup wait time	UV triggered (V_{FB} lower than 65% V_{FB_nom})		0.25		ms
T_{UVP_HICCUP}	UV protection hiccup time before recovery			25		ms

(1) Not production tested. Ensured by design and engineering sample correlation.

6.7 Typical Characteristics

$V_{IN} = 12\text{ V}$ (unless otherwise noted)



图 1. Quiescent Current vs Temperature



图 2. Shutdown Current vs Temperature

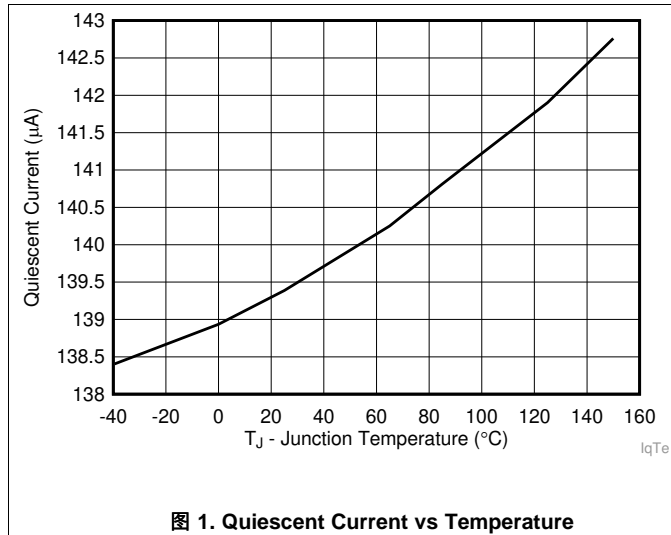

图 3. High-Side R_{DS(on)} vs Temperature

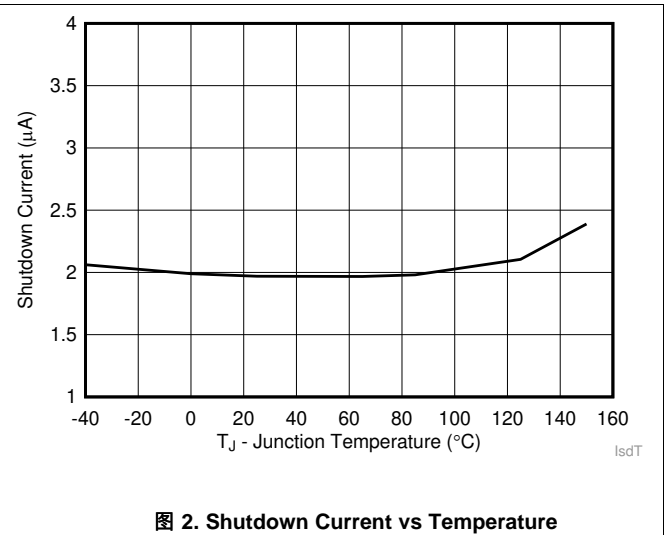

图 4. Low-side R_{DS(on)} vs Temperature

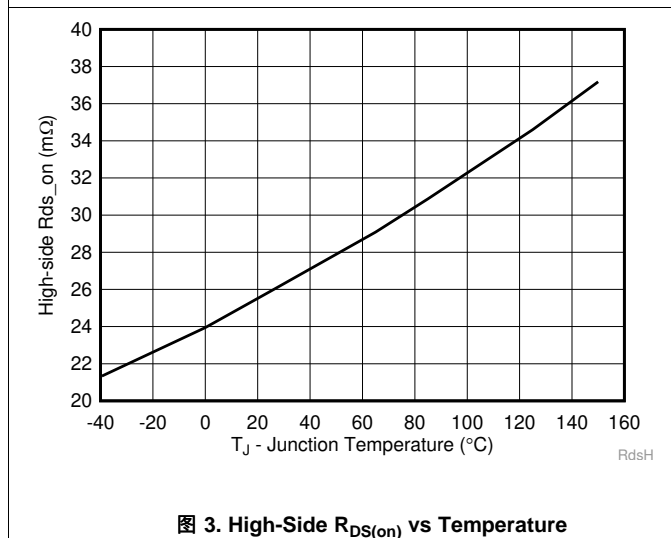

图 5. Feedback Voltage vs Temperature

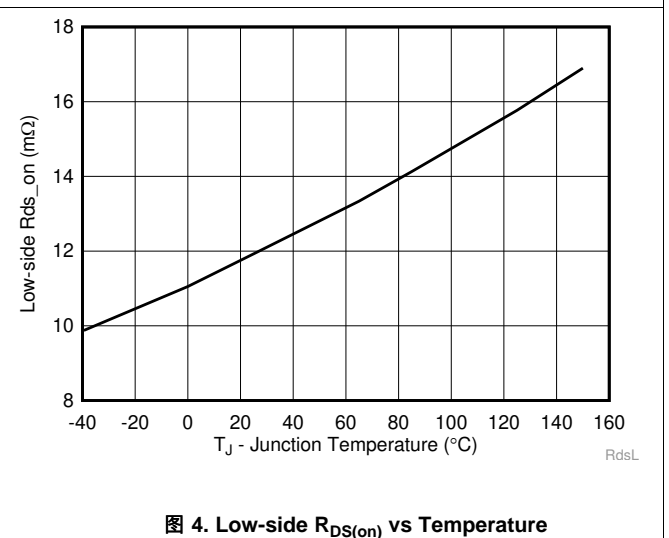

图 6. VIN UVLO Threshold vs Temperature

Typical Characteristics (接下页)

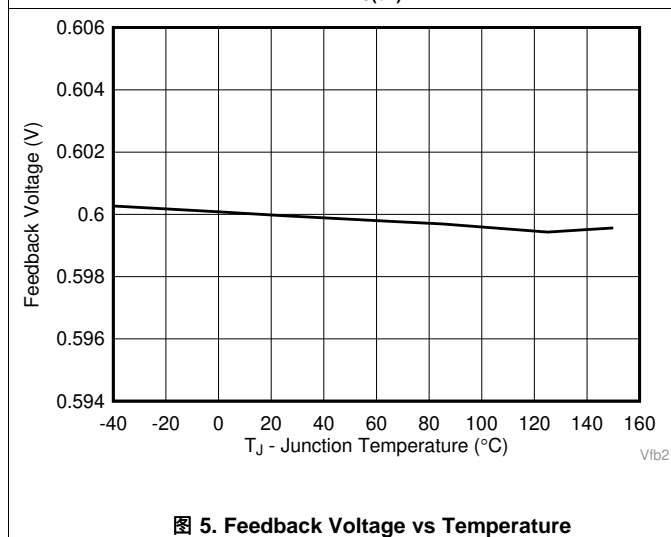
$V_{IN} = 12\text{ V}$ (unless otherwise noted)

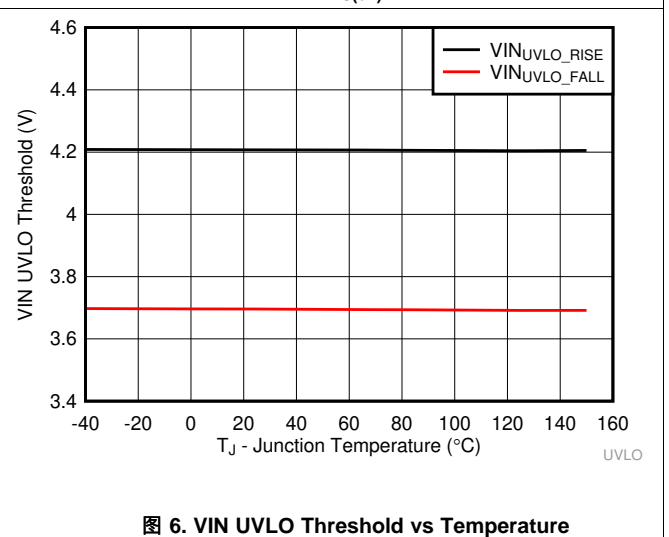

图 7. EN Threshold vs Temperature



图 8. Valley Current Limit vs Temperature

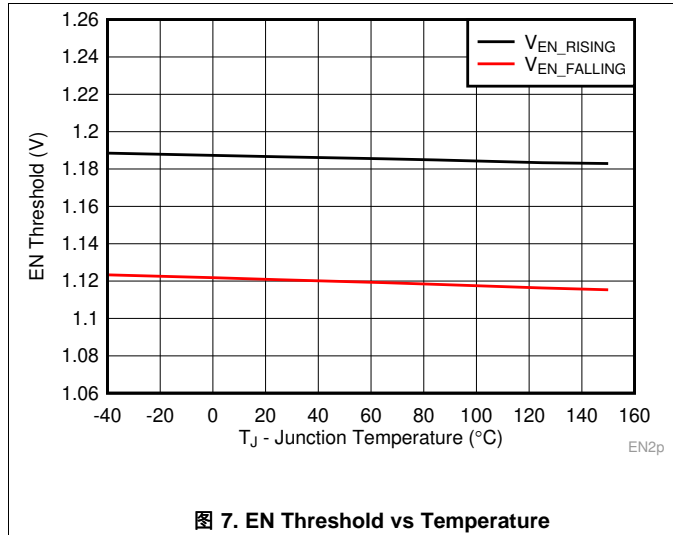

图 9. Switching Frequency vs Input voltage

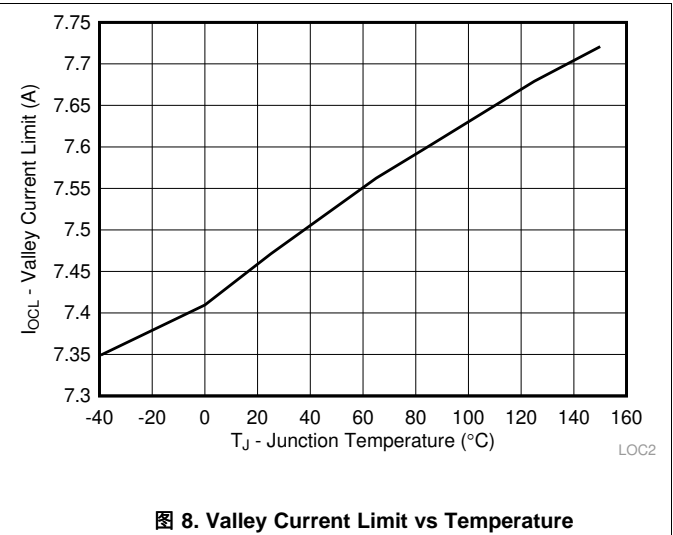

图 10. Switching Frequency vs Output Current

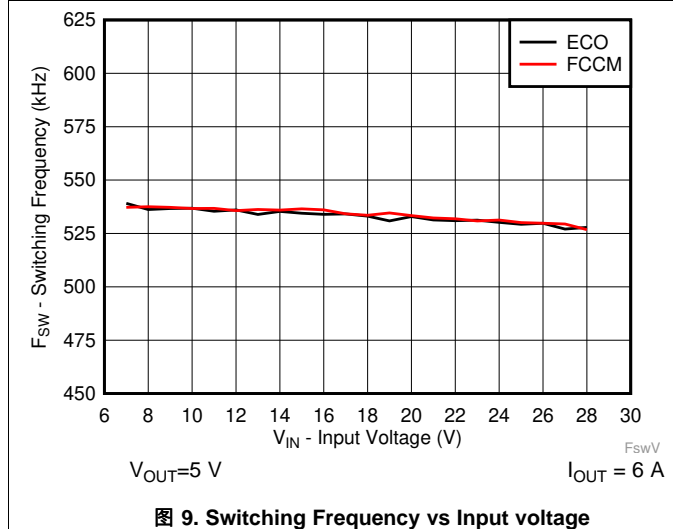

图 11. $V_{OUT} = 1.05\text{ V}$ Efficiency, $L = 1\ \mu\text{H}$

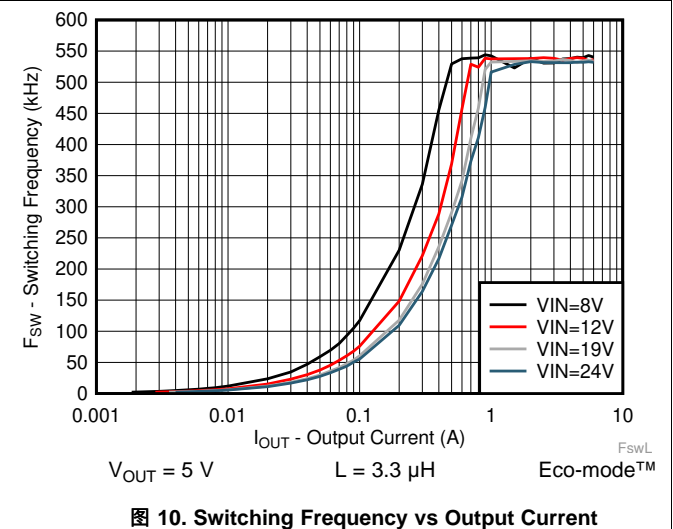

图 12. $V_{OUT} = 3.3\text{ V}$ Efficiency, $L = 2.2\ \mu\text{H}$

Typical Characteristics (接下页)

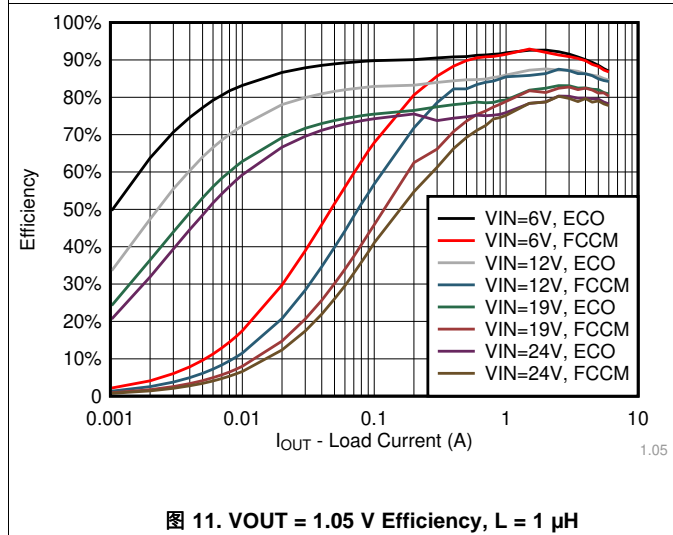
$V_{IN} = 12\text{ V}$ (unless otherwise noted)

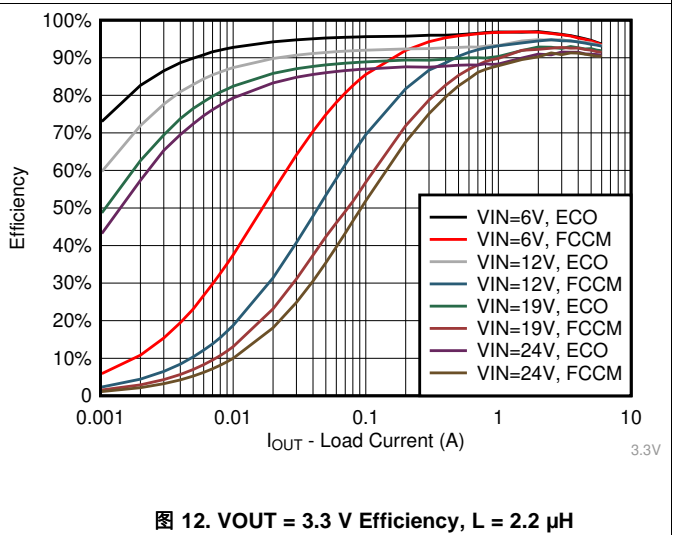
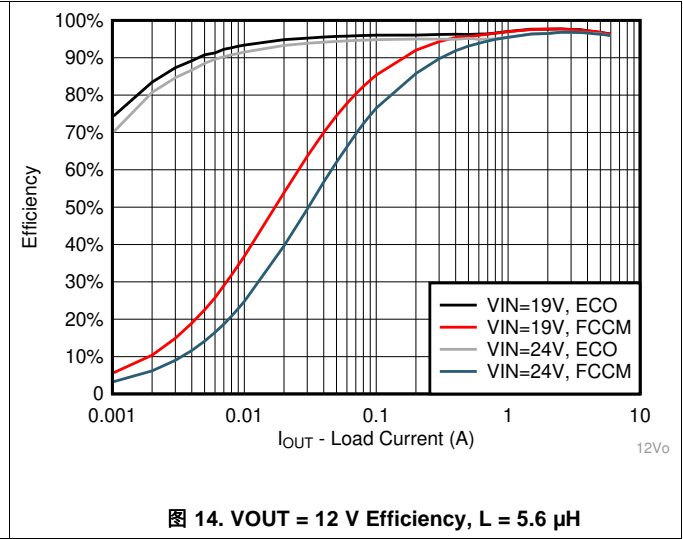
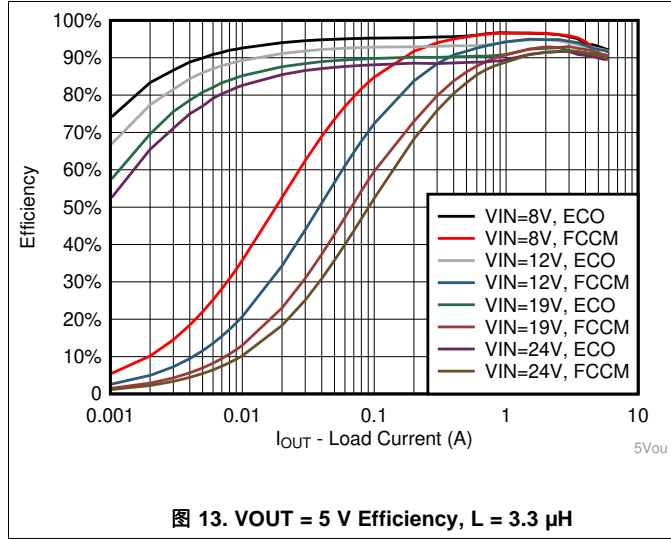

7 Detailed Description

7.1 Overview

The TPS56637 is a 6-A synchronous buck converter operating from 4.5V to 28V input voltage (V_{IN}), and its output voltage ranges from 0.6V to 13V. The proprietary D-CAP3™ mode enables low external component count, ease of design, optimization of the power design for power, size and efficiency. The device employs D-CAP3™ mode control that provides fast transient response with no external compensation components and an accurate feedback voltage. The control topology provides seamless transition between CCM operating mode at higher load condition and DCM operation at lighter load condition. Eco-mode™ allows the TPS56637 to maintain high efficiency at light load. FCCM mode has the quasi-fixed switching frequency at both light and heavy load. The TPS56637 is able to adapt both low equivalent series resistance (ESR) output capacitors such as POSCAP or SP-CAP, and ultra-low ESR ceramic capacitors.

7.2 Functional Block Diagram

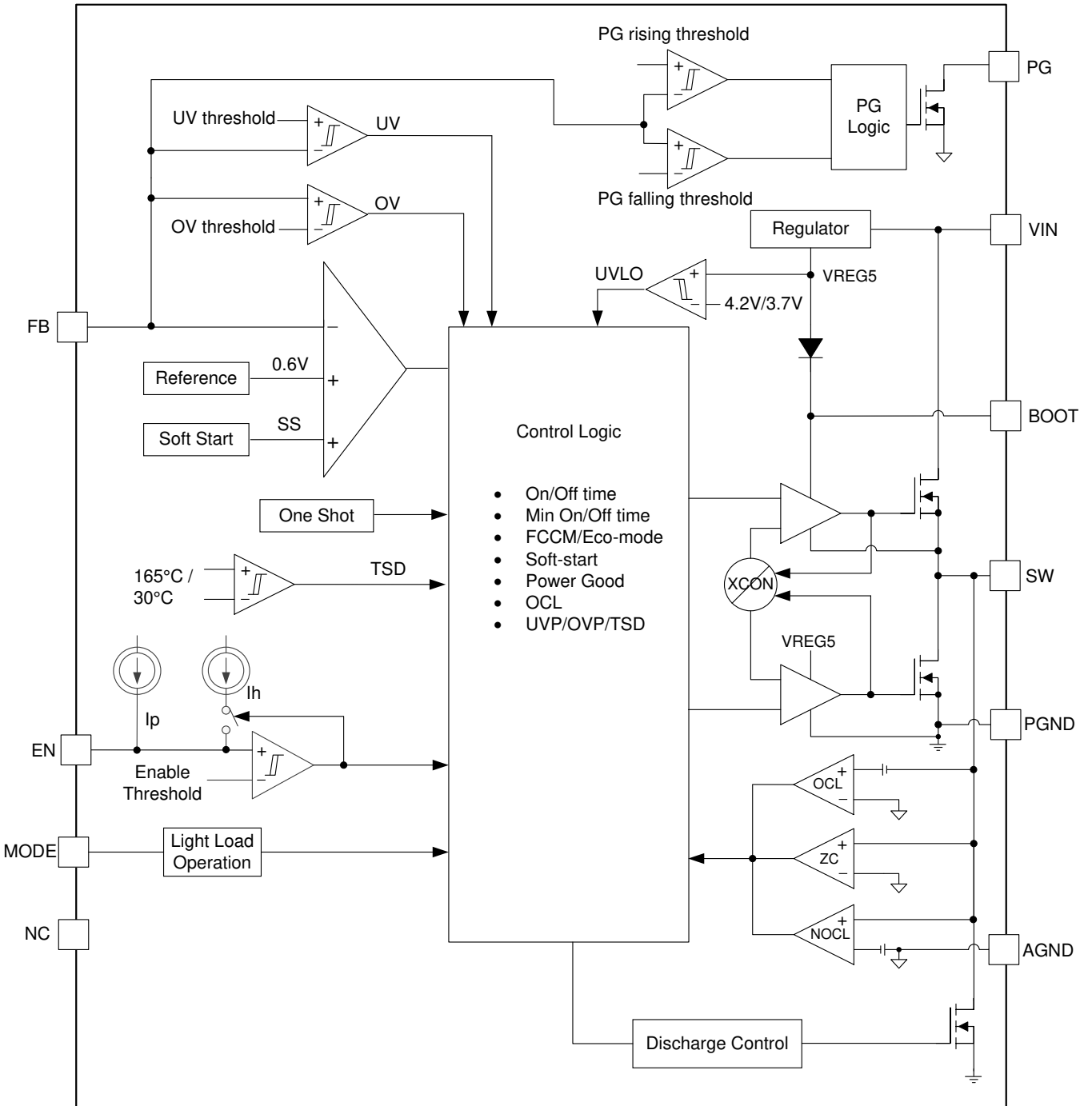

Copyright © 2017, Texas Instruments Incorporated

7.3 Feature Description

7.3.1 The Adaptive On-Time Control and PWM Operation

The main control loop of the TPS56637 is adaptive on-time pulse width modulation (PWM) controller that supports a proprietary DCAP3™ mode control. The DCAP3™ mode control combines adaptive on-time control with an internal compensation circuit for quasi-fixed frequency and low external component count configuration with both low-ESR and ceramic output capacitors. It is stable even with virtually no ripple at the output. The TPS56637 also includes an error amplifier that makes the output voltage very accurate. No external current sense network or loop compensation is required for DCAP3™ control topology.

At the beginning of each cycle, the high-side MOSFET is turned on. This MOSFET is turned off after internal one-shot timer expires. This one-shot duration is set proportional to the output voltage, V_{OUT} , and is inversely proportional to the converter input voltage, V_{IN} , to maintain a pseudo-fixed frequency over the input voltage range, hence it is called adaptive on-time control. When the feedback voltage falls below the reference voltage, the one-shot timer is reset and the high-side MOSFET is turned on again. An internal ripple generation circuit is added to reference voltage for emulating the output ripple, and this enables the use of very low-ESR output capacitors such as multi-layered ceramic caps (MLCC).

7.3.2 Mode Selection

TPS56637 has a MODE pin that can offer 2 different states of operations under light load condition. If MODE pin is short to GND($\leq 10k\Omega$), TPS56637 works under Eco-mode™ control scheme. If MODE pin is floating($\geq 500k\Omega$), TPS56637 works under FCCM mode.

图 15 below shows the typical start-up sequence of the device once the enable signal triggers the EN turn-on threshold. After the voltage of internal VCC crosses the UVLO rising threshold, it takes about 64 μ s to finish the reading and setting of MODE. After this process, the MODE is latched and will not change until V_{IN} or EN toggles to restart-up this device. Then after a delay of around 650 μ s the internal soft-start function begins to ramp up the reference voltage to the PWM comparator.

表 1. MODE Pin Settings

MODE Pin	Light Load Operation Mode
Short to GND ($\leq 10k\Omega$)	Eco-mode™
Floating ($\geq 500k\Omega$)	FCCM



图 15. Power-Up Sequence

7.3.2.1 Eco-mode™ Control Scheme

When MODE pin is short to GND ($\leq 10k\Omega$), the TPS56637 is set to Eco-mode™ control scheme to maintain high light load efficiency. As the output current decreases from heavy load condition, the inductor current is also reduced and eventually comes to a point that its rippled valley touches zero level, which is the boundary between continuous conduction and discontinuous conduction modes. The rectifying MOSFET is turned off when the zero inductor current is detected. As the load current further decreases the converter runs into discontinuous conduction mode. The on-time is kept almost the same as it was in the continuous conduction mode so that longer time is needed to discharge the output capacitor with smaller load current to the level of the reference voltage. This process makes the switching frequency lower, proportional to the load current, and keeps the light load efficiency high. The transition point to the light load operation $I_{OUT(LL)}$ current can be calculated by [公式 1](#).

$$I_{OUT(LL)} = \frac{1}{2 \cdot L \cdot f_{SW}} \cdot \frac{(V_{IN} - V_{OUT}) \cdot V_{OUT}}{V_{IN}} \quad (1)$$

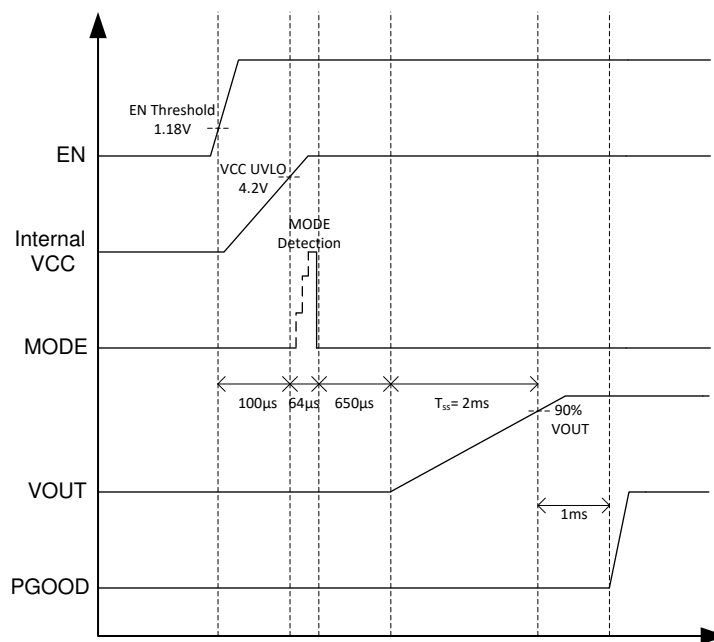
7.3.2.2 FCCM Control

When MODE pin is floating ($\geq 500k\Omega$), the TPS56637 is set to operate in forced continuous conduction mode (FCCM) in light load conditions and allows the inductor current to become negative. In FCCM, the switching frequency is maintained at a quasi-fixed level over the entire load range which is suitable for applications requiring tight control of the switching frequency and output voltage ripple at the cost of lower efficiency under light load compared with which under Eco-mode™. This mode also can help to avoid switching frequency dropping into audible range that may introduces some audible "noise".

7.3.3 Soft Start and Pre-Biased Soft Start

The TPS56637 features an internal 2-ms soft-start function. The internal soft start circuitry controls the output voltage slope during startup. This avoids excessive inrush current and ensures a controlled output voltage rise time. It also prevents unwanted voltage drops from high impedance power sources or batteries. When EN pin is set to start device operation, the internal soft-start circuitry will begin ramping up the reference voltage to the PWM comparator with a controlled slope. If the output capacitor is pre-biased at startup, the device initiates switching and start ramping up only after the internal reference voltage becomes greater than the feedback voltage V_{FB} . This scheme ensures that the converters ramp up smoothly into regulation point.

7.3.4 Enable and Adjusting Undervoltage Lockout

The EN pin provides electrical on and off control of the device. When the EN pin voltage exceeds the threshold voltage, the device begins operating. If the EN pin voltage is pulled below the threshold voltage, the regulator stops switching and enters the [standby operation](#).

The EN pin has an internal pull-up current source which allows the user to float the EN pin to enable the device. If an application requires control of the EN pin, open-drain or open-collector output logic can be used to interface with the pin.

The TPS56637 implements internal undervoltage-lockout (UVLO) circuitry on the V_{IN} pin. The device is disabled when the V_{IN} pin voltage falls below the internal V_{IN} UVLO threshold. The internal V_{IN} UVLO threshold has a hysteresis of 500 mV.

If an application requires a higher UVLO threshold on the V_{IN} pin, then the EN pin can be configured as shown in [Figure 16](#). When using the external UVLO function, setting the hysteresis at a value greater than 500 mV is recommended.

The EN pin has a small pull-up current, I_p , which sets the default state of the pin to enable when no external components are connected. The pull-up current is also used to control the voltage hysteresis for the UVLO function because it increases by I_h when the EN pin crosses the enable threshold. Use [Equation 2](#), and [Equation 3](#) to calculate the values of R_1 and R_2 for a specified UVLO threshold. Once R_1 , R_2 were settled down, the V_{EN} voltage can be calculated by [Equation 4](#), which should be lower than 5.5V with max V_{IN} .



图 16. Adjustable VIN Undervoltage Lockout

$$R_1 = \frac{V_{START} \frac{V_{ENfalling}}{V_{ENrising}} - V_{STOP}}{I_p \left(1 - \frac{V_{ENfalling}}{V_{ENrising}} \right) + I_h} \quad (2)$$

$$R_2 = \frac{R_1 \times V_{ENfalling}}{V_{STOP} - V_{ENfalling} + R_1 (I_p + I_h)} \quad (3)$$

$$V_{EN} = \frac{R_2 \times V_{IN} + R_1 R_2 (I_p + I_h)}{R_1 + R_2} \quad (4)$$

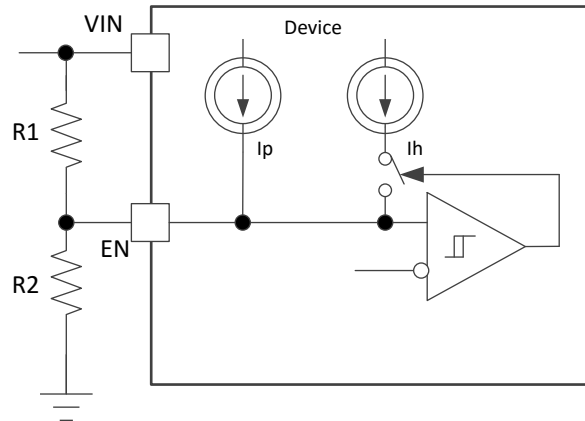
Where

- $I_p = 1 \mu A$
- $I_h = 4 \mu A$
- $V_{ENfalling} = 1.12 V$
- $V_{ENrising} = 1.18 V$

7.3.5 Output Overcurrent Limit and Undervoltage Protection

The output overcurrent limit (OCL) is implemented using a cycle by cycle valley detect control circuit. The switching current is monitored during off state by measuring the low-side FET drain to source voltage. This voltage is proportional to the switching current. To improve accuracy, the voltage sensing is temperature compensated.

During the on-time of the high-side FET switch, the switching current increases at a linear rate determined by V_{IN} , V_{OUT} , the on-time and the output inductor value. During the on-time of the low-side FET switch, this current decreases linearly. The average value of the switch current is the load current I_{OUT} . If the monitored current is above the OCL level, the converter maintains low-side FET on and delays the creation of a new set pulse, even the voltage feedback loop requires one, until the current level becomes OCL level or lower. In subsequent switching cycles, the on-time is set to a fixed value and the current is monitored in the same manner.

There are some important considerations for this type of over current limit. When the load current is higher than the over current threshold by one half of the peak-to-peak inductor ripple current, the OCL is triggered and the current is being limited, output voltage tends to drop because the load demand is higher than what the converter can support. When the output voltage falls below 65% of the target voltage, the UVP comparator detects it and shuts down the device after a deglitch wait time of 0.25ms and then re-start after the hiccup time of 25ms. When the over current condition is removed, the output will be recovered.

7.3.6 Overvoltage Protection

When the output voltage becomes higher than 125% of the target voltage, the OVP comparator output goes high after a deglitch time of 256 μ s and then the output will be discharged. When the over voltage condition is removed, the discharge path will still be on for a hiccup time of 25ms before a re-soft-start process to recover the output voltage.

7.3.7 UVLO Protection

Undervoltage Lockout protection(UVLO) monitors the internal regulator voltage. When the voltage is lower than UVLO threshold voltage, the device is shut down. This protection is non-latched.

7.3.8 Thermal Shutdown

The junction temperature (T_j) of the device is monitored by an internal temperature sensor. If T_j exceeds 165°C (typical), the device goes into thermal shut down. Both the high-side and low-side power FETs are turned off and the discharge path is turned on. When T_j decreases below the hysteresis amount, the converter resumes normal operation, beginning with Soft Start. To avoid unstable conditions, a hysteresis of typically 30°C is implemented on the thermal shut down temperature.

7.3.9 Output Voltage Discharge

The TPS56637 has a built in discharge function by using an integrated MOSFET with 200-Ω $R_{DS(on)}$, which is connected to the output terminal SW. The discharge is slow due to the lower current capability of the MOSFET. The discharge path will be turned on when the device is turned off due to UV, OV, OT and EN shut down conditions.

7.3.10 Power Good

The TPS56637 has a built in power good (PG) function to indicate whether the output voltage has reached its appropriate level or not. The PG signal can be used for startup sequencing of multiple rails. The PG pin is an open-drain output that requires a pull-up resistor (to any voltage below 5.5 V). A pull-up resistor of 100kΩ is recommended to pull it up to 5V voltage. It can sink 1.5mA of current and maintain its specified logic low level. Once the FB pin voltage is between 90% and 110% of the internal reference voltage (V_{REF}) and after a deglitch time of 64μs, the PG turns to high impedance status. The PG pin is pulled low after a deglitch time of 32μs when FB pin voltage is lower than 85% of the internal reference voltage or greater than 115% of the internal reference voltage, or in events of thermal shutdown, EN shutdown, UVLO conditions. V_{IN} must remain present for the PG pin to stay Low.

表 2. Power Good Pin Logic Table (TPS56637)

Device State		PG Logic Status	
		High Impedance	Low
Enable (EN=High)	V_{FB} doesn't trigger V_{PGTH}	√	
	V_{FB} triggers V_{PGTH}		√
Shutdown (EN=Low)			√
UVLO	$2 V < V_{IN} < V_{UVLO}$		√
Thermal Shutdown	$T_J > T_{SD}$		√
Power Supply Removal	$V_{IN} < 2 V$	√	

7.4 Device Functional Modes

7.4.1 Standby Operation

The TPS56637 can be placed in standby mode by pulling the EN pin low. The device operates with a shutdown current of 2 μ A (typical) when in standby condition.

7.4.2 Normal Operation

When the input voltage is above the UVLO threshold voltage and EN pin is high, TPS56637 can operate in its normal switching modes. Normal continuous conduction mode (CCM) occurs when the minimum switch current is above 0 A. In CCM, the TPS56637 operates at a quasi-fixed frequency of 500kHz (typical).

7.4.3 Light Load Operation

When the MODE pin is selected to operate in FCCM mode, the converter operates in continuous conduction mode (FCCM) during light-load conditions. During FCCM, the switching frequency is maintained at an almost constant level over the entire load range which is suitable for applications requiring tight control of the switching frequency and output voltage ripple at the cost of lower efficiency under light load. If the MODE pin is selected to operate in Eco-mode™ control scheme, the device enters pulse skip mode after the valley of the inductor ripple current crosses zero. The Eco-mode™ control scheme maintains higher efficiency at light load with a lower switching frequency. If the TPS56637 works at Eco-mode™ and the load current is light enough to a specific value, the TPS56637 will enter ULQ mode that the TPS56637 will disable some internal circuits to further increase the light load efficiency.

8 Application and Implementation

注

Information in the following applications sections is not part of the TI component specification, and TI does not warrant its accuracy or completeness. TI's customers are responsible for determining suitability of components for their purposes. Customers should validate and test their design implementation to confirm system functionality.

8.1 Application Information

The schematic of [图 17](#) shows a typical application for TPS56637. This design converts an input voltage range of 8V to 28V down to 5V with a maximum output current of 6 A.

8.2 Typical Application

The application schematic in [图 17](#) shows the TPS56637 8-V to 28-V Input, 5-V output converter design meeting the requirements for 6-A output. This circuit is available as the evaluation module (EVM). The sections provide the design procedure.

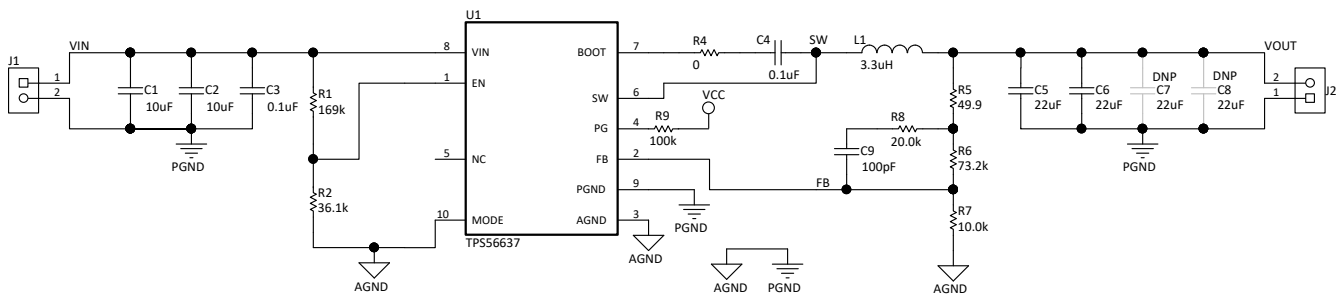

Copyright © 2017, Texas Instruments Incorporated

图 17. TPS56637 5-V, 6-A Reference Design

8.2.1 Design Requirements

表 3 shows the design parameters for this application.

表 3. Design Parameters

PARAMETER	EXAMPLE VALUE
Input voltage range	24V nominal, 8V to 28V
Output voltage	5V
Transient response, 6-A load step	$\Delta V_{OUT} = \pm 5\%$
Output ripple voltage	<30 mV @ CCM
Output current rating	6A
Operating frequency	500 kHz

8.2.2 Detailed Design Procedure

8.2.2.1 Output Voltage Resistors Selection

The output voltage is set with a resistor divider from the output node to the V_{FB} pin. TI recommends to use 1% tolerance or better divider resistors. Start by using [公式 5](#) to calculate V_{OUT} . R_5 is optional and can be used to measure the control loop's frequency response.

To improve efficiency at very light loads consider using larger value resistors. If the resistance is too high the device will be more susceptible to noise and voltage errors from the V_{FB} input current will be more noticeable. Please note that dynamically adjusting output voltage is not recommended.

$$V_{OUT} = 0.6 \times \left(1 + \frac{R6}{R7} \right) \quad (5)$$

8.2.2.2 Output Filter Selection

The LC filter used as the output filter has double pole at:

$$f_p = \frac{1}{2\pi\sqrt{L_{OUT} \times C_{OUT}}} \quad (6)$$

At low frequencies, the overall loop gain is set by the output set-point resistor divider network and the internal gain of the device. The low frequency phase is 180 degrees. At the output filter pole frequency, the gain rolls off at a -40 dB per decade rate and the phase drops rapidly. D-CAP3 introduces a high frequency zero that reduces the gain roll off to -20 dB per decade and increases the phase to 90 degrees one decade above the zero frequency. The inductor and capacitor for the output filter must be selected so that the double pole of [公式 6](#) is located below the high frequency zero but close enough that the phase boost provided by the high frequency zero provides adequate phase margin for a stable circuit. To meet this requirement use the values recommended in [表 4](#).

表 4. Recommended Component Values

OUTPUT VOLTAGE ⁽¹⁾ (V)	R6 ⁽²⁾ (kΩ)	R7 (kΩ)	L1 (μH)	C _{OUT} ⁽³⁾ (μF)			C9 (pF) ⁽⁴⁾	R8 (kΩ) ⁽⁴⁾
				MIN	TYP	MAX		
1.05	7.5	10.0	1	30	35	100		
1.2	10	10.0	1	30	35	100		
1.8	20	10.0	1.2	30	35	100		
3.3	45.3	10.0	2.2	20	35	100	100 to 220	20
5	73.2	10.0	3.3	20	30	100	100 to 220	20
12	191	10.0	5.6	25	30	100	100 to 220	20

- (1) Please use the recommended L1 and C_{OUT} combination of the higher and closest output rail for unlisted output rails.
- (2) R6=0Ω for $V_{OUT}=0.6V$
- (3) C_{OUT} is the sum of effective output capacitance. In this datasheet the effective capacitance is defined as the actual capacitance under DC bias and temperature, not the rated or nameplate values. All high value ceramic capacitors have a large voltage coefficient in addition to normal tolerances and temperature effects. A careful study of bias and temperature variation of any capacitor bank should be made in order to ensure that the minimum value of effective capacitance is provided. Refer to the information of DC bias and temperature characteristics from manufacturers of ceramic capacitors.
- (4) R8 and C9 can be used to improve the load transient response or improve the loop-phase margin. The application report [Optimizing Transient Response of Internally Compensated DCDC Converters with Feed-forward Capacitor](#) is helpful when experimenting with a feed-forward capacitor.

The inductor peak-to-peak ripple current, peak current and RMS current are calculated using 公式 7, 公式 8, and 公式 9. The inductor saturation current rating must be greater than the calculated peak current and the RMS or heating current rating must be greater than the calculated RMS current.

Use 500 kHz for f_{SW} . Make sure the chosen inductor is rated for the peak current of 公式 8 and the RMS current of 公式 9.

$$I_{P-P} = \frac{V_{OUT}}{V_{IN(MAX)}} \cdot \frac{V_{IN(MAX)} - V_{OUT}}{L_O \cdot f_{SW}} \quad (7)$$

$$I_{PEAK} = I_O + \frac{I_{P-P}}{2} \quad (8)$$

$$I_{LO(RMS)} = \sqrt{I_O^2 + \frac{1}{12} I_{P-P}^2} \quad (9)$$

For this design example, the calculated peak current is 7.28A and the calculated RMS current is 6.05 A. The inductor used is IHLP3232DZER3R3M11 with a peak current rating of 10.5A and an RMS current rating of 9.7A.

The capacitor value and ESR determines the amount of output voltage ripple. The TPS56637 is intended for use with ceramic or other low ESR capacitors. Recommended values range from 20 μ F to 100 μ F. Use 公式 10 to determine the required RMS current rating for the output capacitor.

$$I_{CO(RMS)} = \frac{V_{OUT} \cdot (V_{IN} - V_{OUT})}{\sqrt{12} \cdot V_{IN} \cdot L_O \cdot f_{SW}} \quad (10)$$

For this design two MuRata GRM32ER71E226KE15L 22- μ F output capacitors are used so that the effective capacitance is 31.08 μ F at DC biased voltage of 5V. The calculated RMS current is 0.738A and each output capacitor is rated for 4 A.

8.2.2.3 Input Capacitor Selection

The TPS56637 requires an input decoupling capacitor and a bulk capacitor is needed depending on the application. TI recommends a ceramic capacitor over 10 μ F for the decoupling capacitor. An additional 0.1- μ F capacitor (C3) from VIN to PGND pin is recommended to provide additional high frequency filtering. The capacitor voltage rating needs to be greater than the maximum input voltage. The input voltage ripple can be calculated using 公式 11.

$$\Delta V_{in} = \frac{I_{outmax} \cdot 0.25}{C_{in} \cdot f_{SW}} \quad (11)$$

The capacitor must also have a ripple current rating greater than the maximum input current ripple of the application. The input ripple current is calculated by 公式 12:

$$I_{CIN(rms)} = I_{OUT} \times \sqrt{\frac{V_{OUT}}{V_{IN(min)}} \times \frac{(V_{IN(min)} - V_{OUT})}{V_{IN(min)}}} \quad (12)$$

8.2.2.4 Bootstrap Capacitor Selection

A 0.1- μ F ceramic capacitor(C4) must be connected between the BOOT to SW pin for proper operation. TI recommends to use a ceramic capacitor with X5R or better grade dielectric. The capacitor must have a 10-V or higher voltage rating.

8.2.3 Application Curves



图 18. Efficiency



图 19. Load Regulation

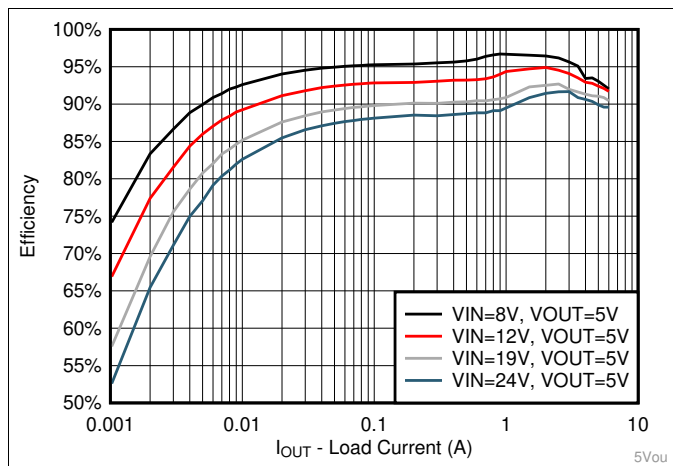

图 20. Line Regulation

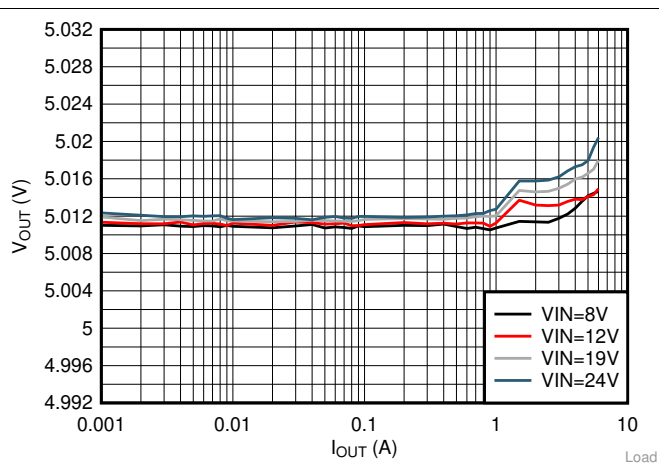

图 21. Bode Plot

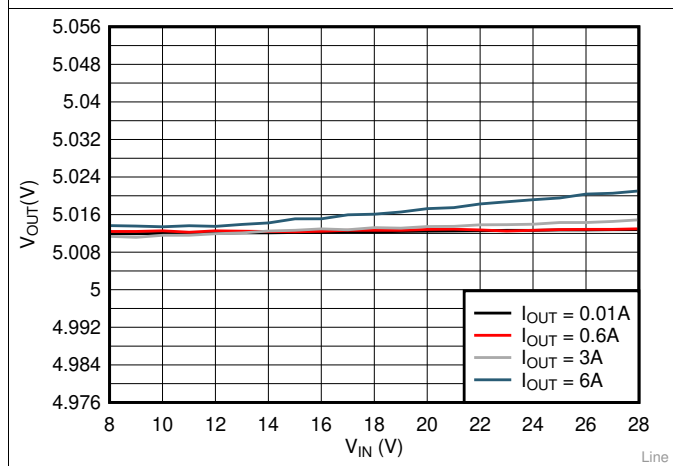

图 22. Steady State Waveforms, $I_{OUT} = 0.01 A$

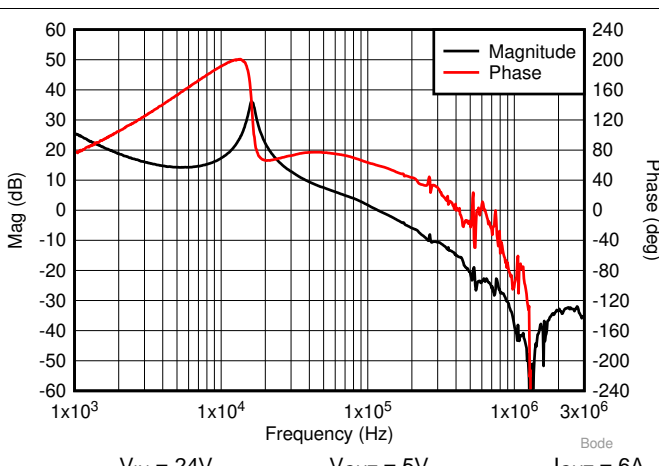

图 23. Steady State Waveforms, $I_{OUT} = 0.6 A$

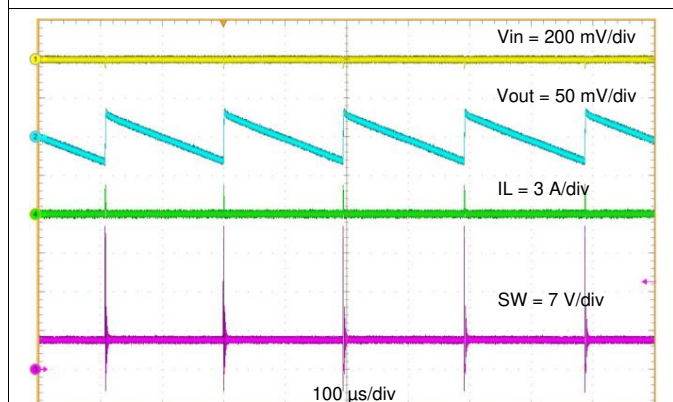

图 24. Steady State Waveforms, $I_{OUT} = 3 \text{ A}$

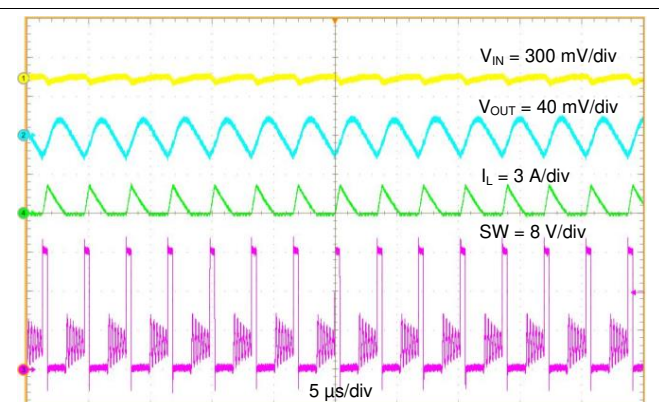

图 25. Steady State Waveforms, $I_{OUT} = 6 \text{ A}$

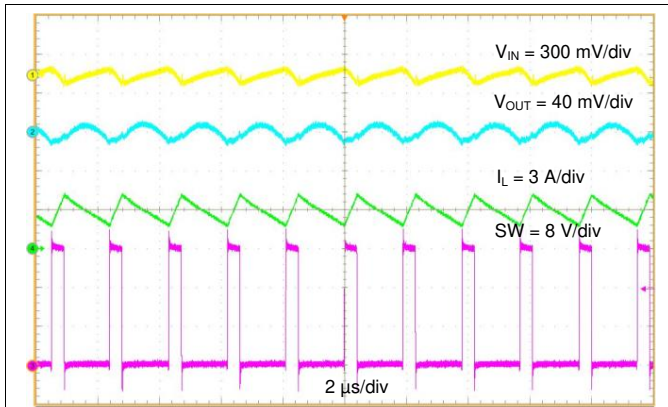

图 26. Transient Response 0 to 3 A

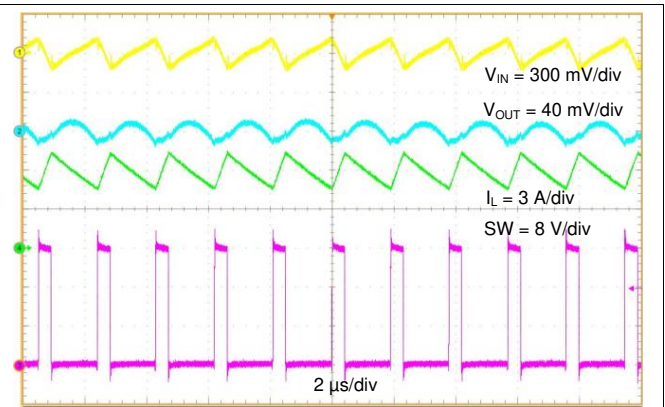

图 27. Transient Response 0 to 6 A

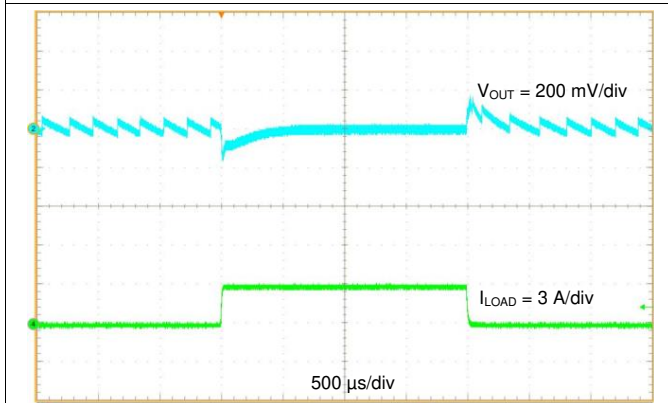

图 28. Transient Response 0.6 to 5.4 A

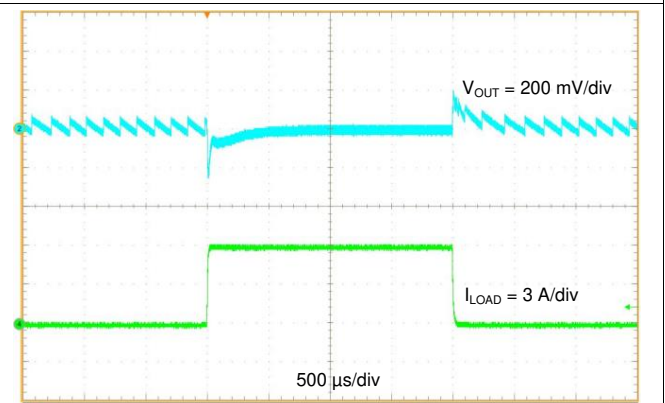

图 29. Transient Response 3 to 6 A

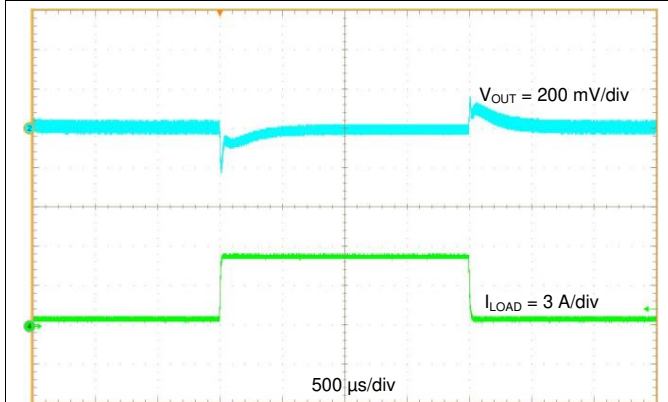

图 30. Startup Relative to V_{IN}

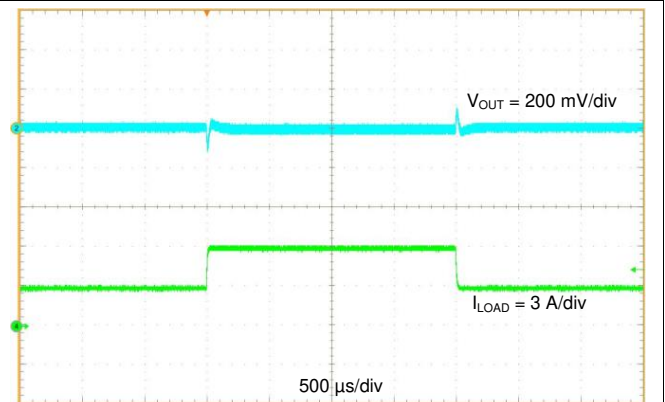

图 31. Shutdown Relative to V_{IN}

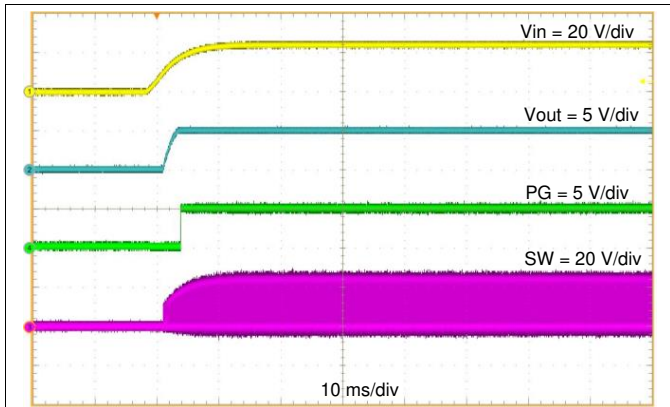

图 32. Enable Relative to EN

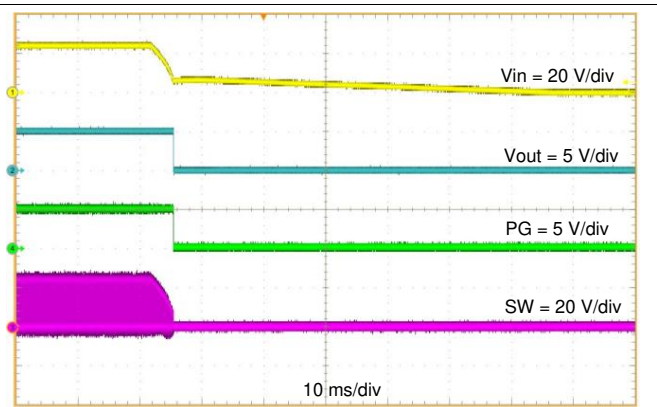

图 33. Disable Relative to EN

9 Power Supply Recommendations

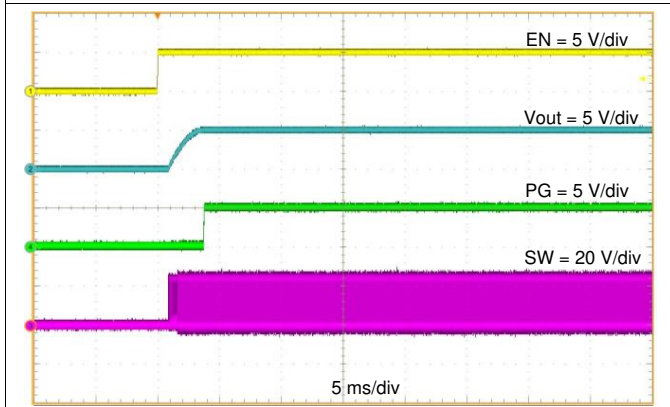
The TPS56637 is designed to operate from input supply voltage in the range of 4.5 V to 28 V. Buck converters require the input voltage to be higher than the output voltage for proper operation. Input supply current must be appropriate for the desired output current. If the input voltage supply is located far from the TPS56637 circuit, some additional input bulk capacitance is recommended.

10 Layout

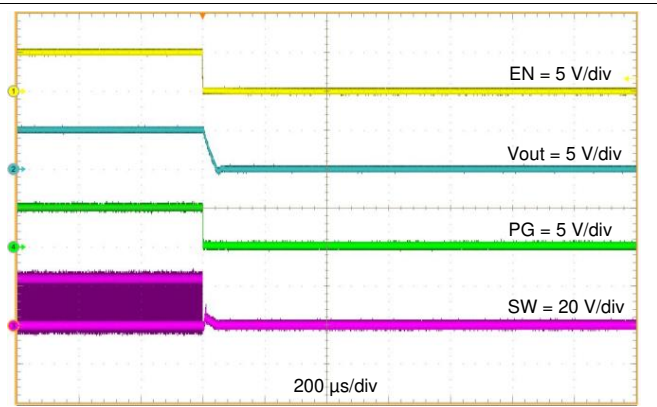
10.1 Layout Guidelines

1. Recommend a four-layer PCB for good thermal performance and with maximum ground plane.
2. VIN and GND traces should be as wide as possible to reduce trace impedance. The wide areas are also of advantage from the view point of heat dissipation.
3. Putting at least two vias for VIN and GND traces, and as close as possible to the pins.
4. The input capacitor and output capacitor should be placed as close to the device as possible to minimize trace impedance.
5. Provide sufficient vias for the input capacitor and output capacitor.
6. Keep the SW trace as physically short and wide as practical to minimize radiated emissions.
7. Do not allow switching current to flow under the device.
8. A separate VOUT path should be connected to the upper feedback resistor.
9. Make a Kelvin connection to the GND pin for the feedback path.
10. Voltage feedback loop should be placed away from the high-voltage switching trace, and preferably has ground shield.
11. The trace of the VFB node should be as small as possible to avoid noise coupling.
12. The GND trace between the output capacitor and the GND pin should be as wide as possible to minimize its trace impedance.

10.2 Layout Example



图 34. TPS56637 Layout

11 器件和文档支持

11.1 文档支持

11.1.1 相关文档

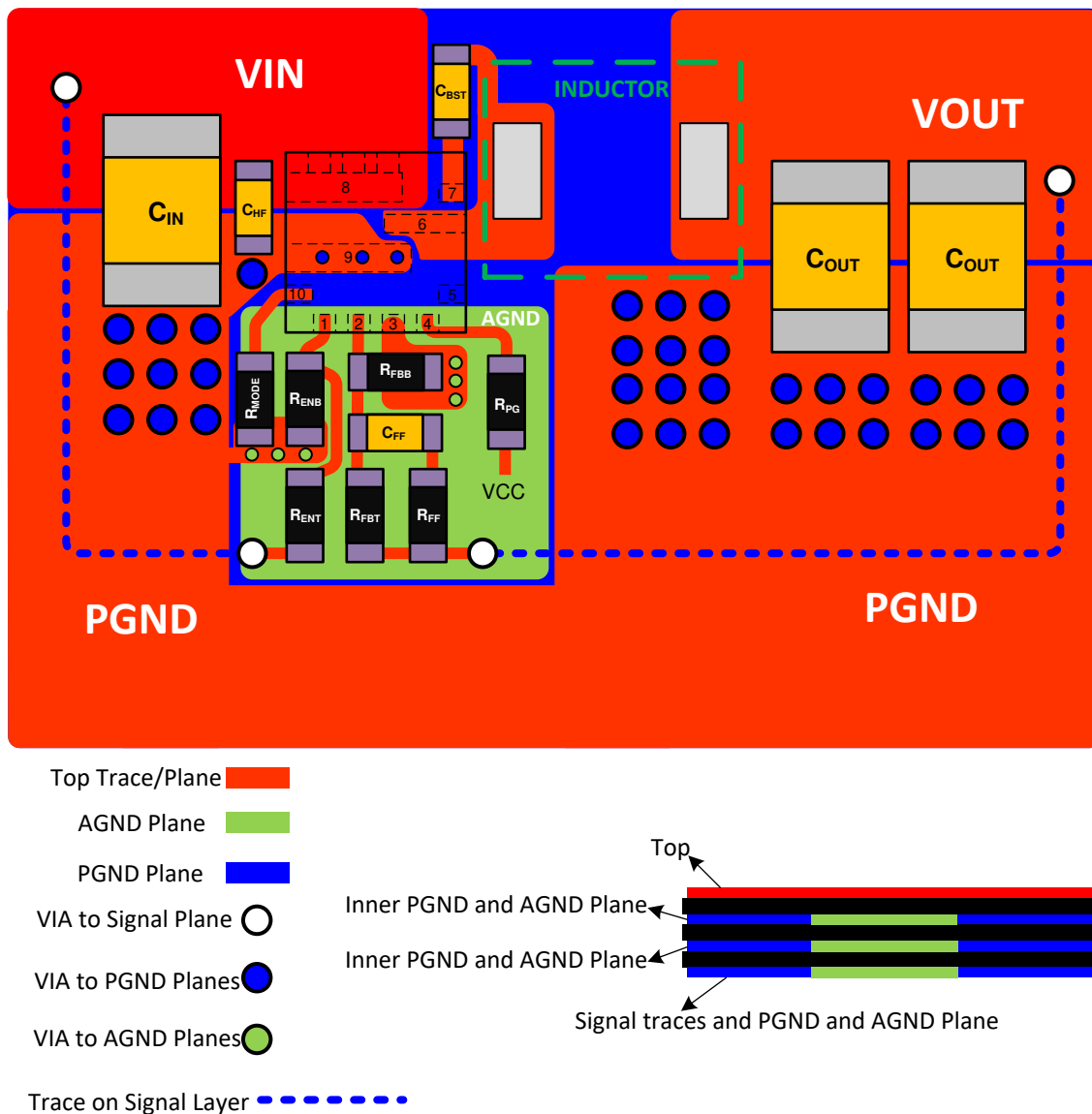
请参阅如下相关文档：德州仪器 (TI)，《TPS56637EVM-029 6A 稳压器评估模块》用户指南

- 德州仪器 (TI)，《TPS56637EVM-029 6A 稳压器评估模块》用户指南

11.2 接收文档更新通知

要接收文档更新通知，请导航至 ti.com 上的器件产品文件夹。单击右上角的通知我进行注册，即可每周接收产品信息更改摘要。有关更改的详细信息，请查看任何已修订文档中包含的修订历史记录。

11.3 社区资源

TI E2E™ support forums are an engineer's go-to source for fast, verified answers and design help — straight from the experts. Search existing answers or ask your own question to get the quick design help you need.

Linked content is provided "AS IS" by the respective contributors. They do not constitute TI specifications and do not necessarily reflect TI's views; see TI's [Terms of Use](#).

11.4 商标

D-CAP3, Eco-mode, HotRod, DCAP3, E2E are trademarks of Texas Instruments.

WEBENCH is a registered trademark of Texas Instruments.

11.5 静电放电警告



ESD 可能会损坏该集成电路。德州仪器 (TI) 建议通过适当的预防措施处理所有集成电路。如果不遵守正确的处理措施和安装程序，可能会损坏集成电路。

ESD 的损坏小至导致微小的性能降级，大至整个器件故障。精密的集成电路可能更容易受到损坏，这是因为非常细微的参数更改都可能会导致器件与其发布的规格不相符。

11.6 Glossary

[SLYZ022](#) — *TI Glossary*.

This glossary lists and explains terms, acronyms, and definitions.

12 机械、封装和可订购信息

以下页面包含机械、封装和可订购信息。这些信息是指定器件的最新可用数据。数据如有变更，恕不另行通知，且不会对此文档进行修订。如需获取此数据表的浏览器版本，请查阅左侧的导航栏。

12.1 Package Option Addendum

12.1.1 Packaging Information

Orderable Device	Status ⁽¹⁾	Package Type	Package Drawing	Pins	Package Qty	Eco Plan ⁽²⁾	Lead/Ball Finish ⁽³⁾	MSL Peak Temp ⁽⁴⁾	Op Temp (°C)	Device Marking ⁽⁵⁾⁽⁶⁾
TPS56637RPAR	ACTIVE	VQFN-HR	RPA	10	3000	Green (RoHS & no Sb/Br)	CU NIPDAU	Level-2-260C-1 YEAR	-40 to 150	P56637

- (1) The marketing status values are defined as follows:
ACTIVE: Product device recommended for new designs.
LIFEBUY: TI has announced that the device will be discontinued, and a lifetime-buy period is in effect.
NRND: Not recommended for new designs. Device is in production to support existing customers, but TI does not recommend using this part in a new design.
PRE_PROD Unannounced device, not in production, not available for mass market, nor on the web, samples not available.
PREVIEW: Device has been announced but is not in production. Samples may or may not be available.
OBSOLETE: TI has discontinued the production of the device.
- (2) Eco Plan - The planned eco-friendly classification: Pb-Free (RoHS), Pb-Free (RoHS Exempt), or Green (RoHS & no Sb/Br) - please check <http://www.ti.com/productcontent> for the latest availability information and additional product content details.
TBD: The Pb-Free/Green conversion plan has not been defined.
Pb-Free (RoHS): TI's terms "Lead-Free" or "Pb-Free" mean semiconductor products that are compatible with the current RoHS requirements for all 6 substances, including the requirement that lead not exceed 0.1% by weight in homogeneous materials. Where designed to be soldered at high temperatures, TI Pb-Free products are suitable for use in specified lead-free processes.
Pb-Free (RoHS Exempt): This component has a RoHS exemption for either 1) lead-based flip-chip solder bumps used between the die and package, or 2) lead-based die adhesive used between the die and leadframe. The component is otherwise considered Pb-Free (RoHS compatible) as defined above.
Green (RoHS & no Sb/Br): TI defines "Green" to mean Pb-Free (RoHS compatible), and free of Bromine (Br) and Antimony (Sb) based flame retardants (Br or Sb do not exceed 0.1% by weight in homogeneous material)
- (3) Lead/Ball Finish - Orderable Devices may have multiple material finish options. Finish options are separated by a vertical ruled line. Lead/Ball Finish values may wrap to two lines if the finish value exceeds the maximum column width.
- (4) MSL, Peak Temp. -- The Moisture Sensitivity Level rating according to the JEDEC industry standard classifications, and peak solder temperature.
- (5) There may be additional marking, which relates to the logo, the lot trace code information, or the environmental category on the device
- (6) Multiple Device markings will be inside parentheses. Only one Device Marking contained in parentheses and separated by a "~" will appear on a device. If a line is indented then it is a continuation of the previous line and the two combined represent the entire Device Marking for that device.

Important Information and Disclaimer: The information provided on this page represents TI's knowledge and belief as of the date that it is provided. TI bases its knowledge and belief on information provided by third parties, and makes no representation or warranty as to the accuracy of such information. Efforts are underway to better integrate information from third parties. TI has taken and continues to take reasonable steps to provide representative and accurate information but may not have conducted destructive testing or chemical analysis on incoming materials and chemicals. TI and TI suppliers consider certain information to be proprietary, and thus CAS numbers and other limited information may not be available for release.

In no event shall TI's liability arising out of such information exceed the total purchase price of the TI part(s) at issue in this document sold by TI to Customer on an annual basis.

TPS56637

ZHCSIH1A –JULY 2018–REVISED SEPTEMBER 2019

www.ti.com.cn

12.1.2 Tape and Reel Information

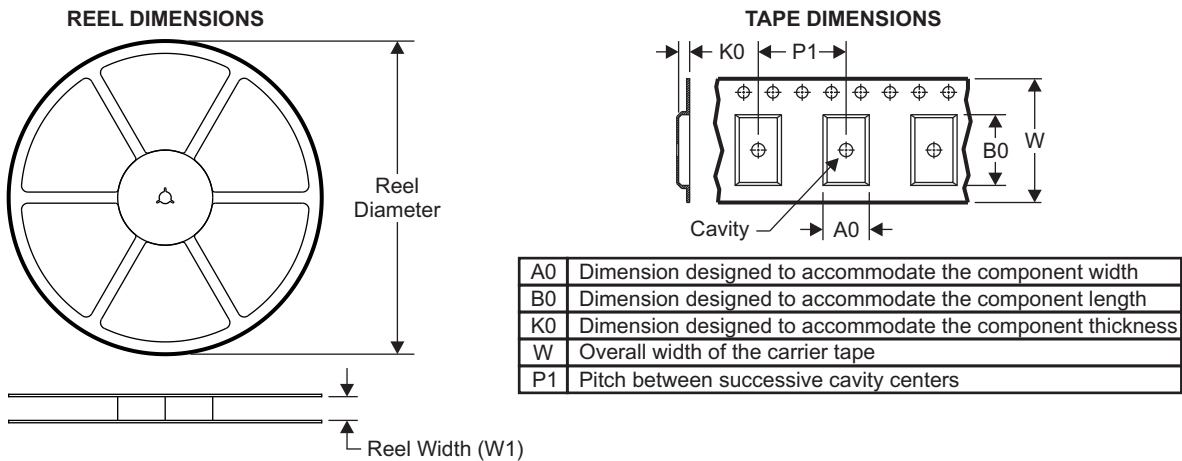

QUADRANT ASSIGNMENTS FOR PIN 1 ORIENTATION IN TAPE

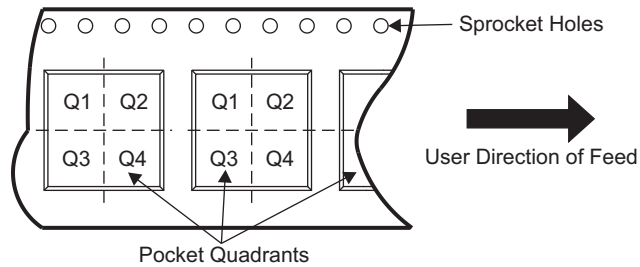

Device	Package Type	Package Drawing	Pins	SPQ	Reel Diameter (mm)	Reel Width W1 (mm)	A0 (mm)	B0 (mm)	K0 (mm)	P1 (mm)	W (mm)	Pin1 Quadrant
TPS56637RPAR	VQFN-HR	RPA	10	3000	330	12	3.3	3.3	1.1	8	9.1	2

TAPE AND REEL BOX DIMENSIONS

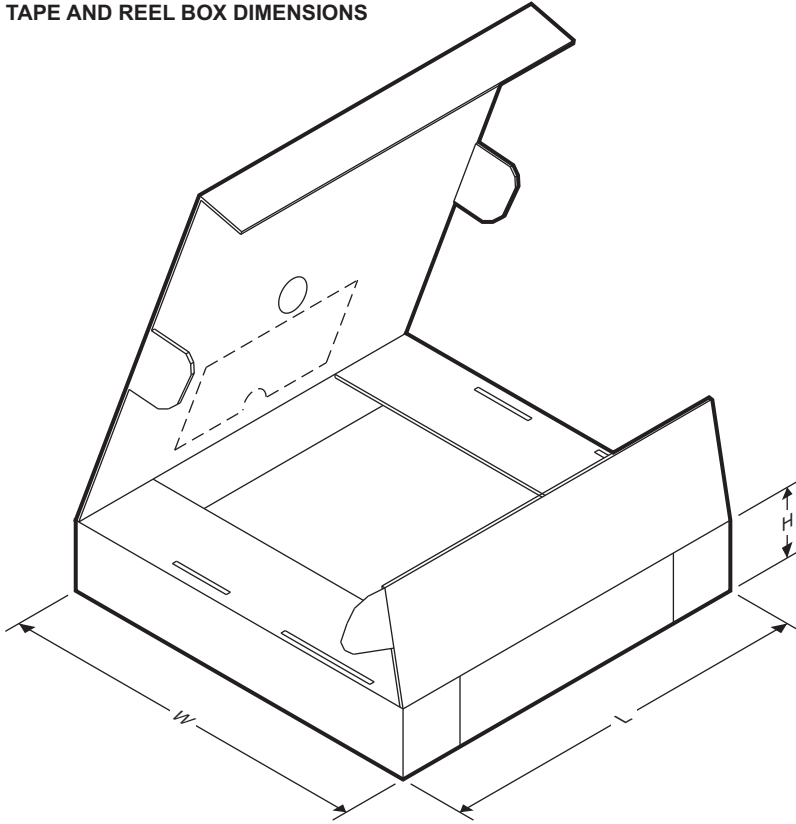

Device	Package Type	Package Drawing	Pins	SPQ	Length (mm)	Width (mm)	Height (mm)
TPS56637RPAR	VQFN-HR	RPA	10	3000	367	367	35

PACKAGING INFORMATION

Orderable Device	Status (1)	Package Type	Package Drawing	Pins	Package Qty	Eco Plan (2)	Lead finish/ Ball material (6)	MSL Peak Temp (3)	Op Temp (°C)	Device Marking (4/5)	Samples
TPS56637RPAR	ACTIVE	VQFN-HR	RPA	10	3000	RoHS & Green	Call TI NIPDAU	Level-2-260C-1 YEAR	-40 to 150	T56637	Samples

(1) The marketing status values are defined as follows:

ACTIVE: Product device recommended for new designs.

LIFEBUY: TI has announced that the device will be discontinued, and a lifetime-buy period is in effect.

NRND: Not recommended for new designs. Device is in production to support existing customers, but TI does not recommend using this part in a new design.

PREVIEW: Device has been announced but is not in production. Samples may or may not be available.

OBSELETE: TI has discontinued the production of the device.

(2) **RoHS:** TI defines "RoHS" to mean semiconductor products that are compliant with the current EU RoHS requirements for all 10 RoHS substances, including the requirement that RoHS substance do not exceed 0.1% by weight in homogeneous materials. Where designed to be soldered at high temperatures, "RoHS" products are suitable for use in specified lead-free processes. TI may reference these types of products as "Pb-Free".

RoHS Exempt: TI defines "RoHS Exempt" to mean products that contain lead but are compliant with EU RoHS pursuant to a specific EU RoHS exemption.

Green: TI defines "Green" to mean the content of Chlorine (Cl) and Bromine (Br) based flame retardants meet JS709B low halogen requirements of <=1000ppm threshold. Antimony trioxide based flame retardants must also meet the <=1000ppm threshold requirement.

(3) MSL, Peak Temp. - The Moisture Sensitivity Level rating according to the JEDEC industry standard classifications, and peak solder temperature.

(4) There may be additional marking, which relates to the logo, the lot trace code information, or the environmental category on the device.

(5) Multiple Device Markings will be inside parentheses. Only one Device Marking contained in parentheses and separated by a "-" will appear on a device. If a line is indented then it is a continuation of the previous line and the two combined represent the entire Device Marking for that device.

(6) Lead finish/Ball material - Orderable Devices may have multiple material finish options. Finish options are separated by a vertical ruled line. Lead finish/Ball material values may wrap to two lines if the finish value exceeds the maximum column width.

Important Information and Disclaimer:The information provided on this page represents TI's knowledge and belief as of the date that it is provided. TI bases its knowledge and belief on information provided by third parties, and makes no representation or warranty as to the accuracy of such information. Efforts are underway to better integrate information from third parties. TI has taken and continues to take reasonable steps to provide representative and accurate information but may not have conducted destructive testing or chemical analysis on incoming materials and chemicals. TI and TI suppliers consider certain information to be proprietary, and thus CAS numbers and other limited information may not be available for release.

In no event shall TI's liability arising out of such information exceed the total purchase price of the TI part(s) at issue in this document sold by TI to Customer on an annual basis.

TAPE AND REEL INFORMATION

QUADRANT ASSIGNMENTS FOR PIN 1 ORIENTATION IN TAPE



*All dimensions are nominal

Device	Package Type	Package Drawing	Pins	SPQ	Reel Diameter (mm)	Reel Width W1 (mm)	A0 (mm)	B0 (mm)	K0 (mm)	P1 (mm)	W (mm)	Pin1 Quadrant
TPS56637RPAR	VQFN-HR	RPA	10	3000	330.0	12.4	3.3	3.3	1.1	8.0	12.0	Q2

TAPE AND REEL BOX DIMENSIONS

*All dimensions are nominal

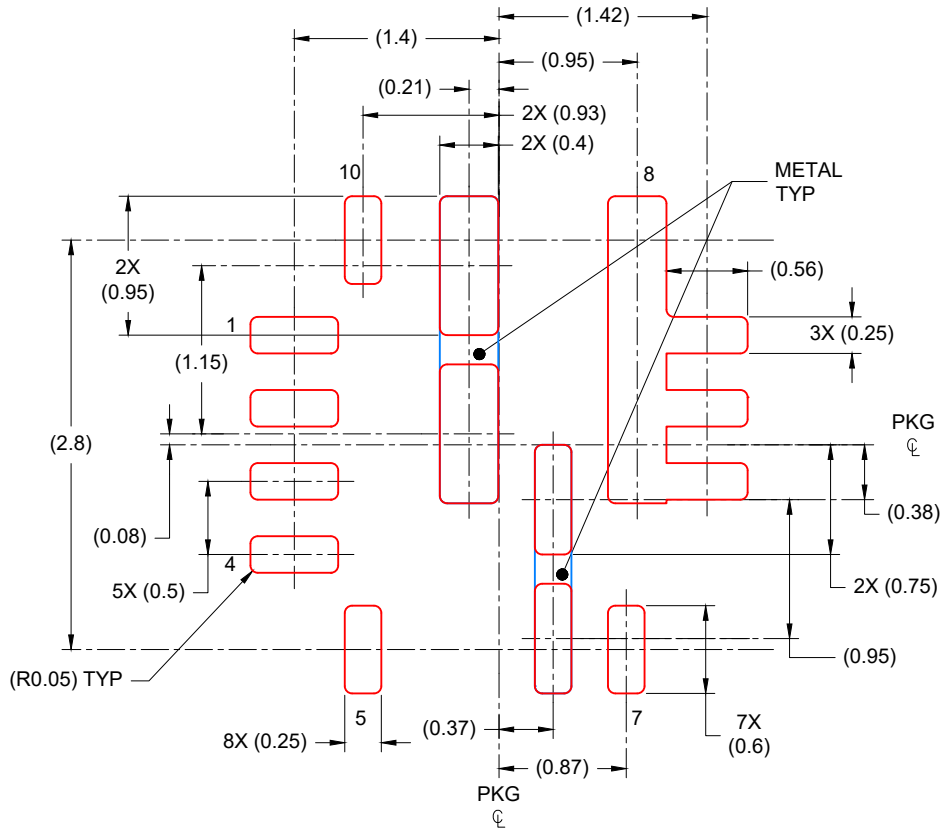
Device	Package Type	Package Drawing	Pins	SPQ	Length (mm)	Width (mm)	Height (mm)
TPS56637RPAR	VQFN-HR	RPA	10	3000	346.0	346.0	33.0



SOLDER PASTE EXAMPLE
 BASED ON 0.1 mm THICK STENCIL
 EXPOSED PAD
 PADS 6 and 9: 89% PRINTED COVERAGE BY
 AREA
 SCALE: 20X

4224047/A 01/2018

NOTES: (continued)

5. Laser cutting apertures with trapezoidal walls and rounded corners may offer better paste release. IPC-7525 may have alternate design recommendations.

重要声明和免责声明

TI“按原样”提供技术和可靠性数据（包括数据表）、设计资源（包括参考设计）、应用或其他设计建议、网络工具、安全信息和其他资源，不保证没有瑕疵且不做任何明示或暗示的担保，包括但不限于对适销性、某特定用途方面的适用性或不侵犯任何第三方知识产权的暗示担保。

这些资源可供使用 TI 产品进行设计的熟练开发人员使用。您将自行承担以下全部责任：(1) 针对您的应用选择合适的 TI 产品，(2) 设计、验证并测试您的应用，(3) 确保您的应用满足相应标准以及任何其他功能安全、信息安全、监管或其他要求。

这些资源如有变更，恕不另行通知。TI 授权您仅可将这些资源用于研发本资源所述的 TI 产品的应用。严禁对这些资源进行其他复制或展示。您无权使用任何其他 TI 知识产权或任何第三方知识产权。您应全额赔偿因在这些资源的使用中对 TI 及其代表造成的任何索赔、损害、成本、损失和债务，TI 对此概不负责。

TI 提供的产品受 [TI 的销售条款](#) 或 [ti.com](#) 上其他适用条款/TI 产品随附的其他适用条款的约束。TI 提供这些资源并不会扩展或以其他方式更改 TI 针对 TI 产品发布的适用的担保或担保免责声明。

TI 反对并拒绝您可能提出的任何其他或不同的条款。

邮寄地址：Texas Instruments, Post Office Box 655303, Dallas, Texas 75265

Copyright © 2023，德州仪器 (TI) 公司