

TPS61098x 具有集成 LDO/负载开关的超低静态电流同步升压转换器

1 特性

- 低功耗模式下具有 300nA 超低 I_Q
- 启动至负载 (输入电压为 0.7V)
- 工作输入电压范围为 0.7V 至 4.5V
- 可选输出电压高达 4.3V
- 最小 350mA 开关峰值电流限制
- 集成 LDO/负载开关
- 由 MODE 引脚控制的两种模式
 - 工作模式：两路输出均处于设定值
 - 低功耗模式：LDO/负载开关关闭；升压转换器继续运行
- 自动直通
- 在 10 μ A 负载条件下进行 2V 至 3.3V 转换时的效率高达 88% (低功耗模式)
- 在 5mA 至 100mA 负载条件下进行 2V 至 3.3V 转换时的效率高达 93%
- 1.5mm × 1.5mm WSON 封装

2 应用

- 智能远程控制
- BLE 标签
- 可穿戴应用
- 低功耗无线应用
- 便携式消费类或医疗类产品
- 单节纽扣电池、单节或两节碱性电池供电的应用

3 说明

TPS61098x 可以为由单节或双节碱性电池、镍镉电池或镍氢电池、单节纽扣电池、单节锂离子电池或锂聚合

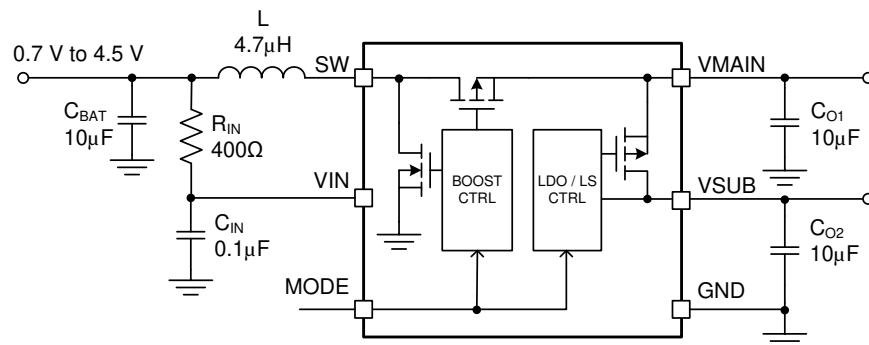

Copyright © 2016, Texas Instruments Incorporated

简化版原理图

物电池供电的产品提供超低功耗解决方案。该器件集成了低压降线性稳压器 (LDO) 或者带有升压转换器的负载开关，并且提供有双输出电源轨。升压转换器输出 $V_{(MAIN)}$ 用作主系统的电源并且始终开启，LDO 或负载开关输出 $V_{(SUB)}$ 则为外设供电。

TPS61098x 具备由 MODE 引脚控制的两个模式：工作模式和低功耗模式。在工作模式下，两输出均启用并具有增强的响应性能。在低功耗模式下，LDO 或负载开关被禁用，断开与外设的连接。在低功耗模式下，TPS61098x 仅消耗 300nA 静态电流，而且在 10 μ A 负载条件下能够实现高达 88% 的效率。

TPS61098x 支持自动直通功能。当输入电压高于直通阈值时，升压转换器停止开关并将输入电压传送至 VMAIN 轨；当输入电压低于该阈值时，升压转换器在升压模式下工作并将输出调节至目标值。TPS61098x 针对不同的输出设定值提供了多种版本。

在 0.7V 输入到 3.3V 输出的转换过程中，TPS61098x 可提供高达 50mA 的总输出电流。该升压转换器基于滞后控制器拓扑结构，可利用同步整流器以超低的静态电流实现超高效率。

TPS61098x 可采用 1.5mm × 1.5mm WSON 封装，从而实现小型电路布局。

器件信息

器件型号	封装 ⁽¹⁾	封装尺寸 (标称值)
TPS61098x	6 引脚 WSON	1.50mm × 1.50mm

- (1) 如需了解所有可用封装，请参阅本文档末尾的可订购产品附录。



Table of Contents

1 特性	1	9 Applications and Implementation	21
2 应用	1	9.1 Application Information.....	21
3 说明	1	9.2 Typical Applications.....	21
4 Revision History	2	10 Power Supply Recommendations	33
5 Device Comparison Table	3	11 Layout	34
6 Pin Configuration and Functions	3	11.1 Layout Guidelines.....	34
7 Specifications	4	11.2 Layout Example.....	34
7.1 Absolute Maximum Ratings.....	4	12 Device and Documentation Support	35
7.2 ESD Ratings.....	4	12.1 Device Support.....	35
7.3 Recommended Operating Conditions.....	4	12.2 Documentation Support.....	35
7.4 Thermal Information.....	4	12.3 接收文档更新通知.....	35
7.5 Electrical Characteristics.....	5	12.4 支持资源.....	35
7.6 Typical Characteristics.....	7	12.5 Trademarks.....	35
8 Detailed Description	16	12.6 静电放电警告.....	35
8.1 Overview.....	16	12.7 术语表.....	35
8.2 Functional Block Diagrams.....	16	13 Mechanical, Packaging, and Orderable	
8.3 Feature Description.....	17	Information	35
8.4 Device Functional Modes.....	19		

4 Revision History

注：以前版本的页码可能与当前版本的页码不同

Changes from Revision E (December 2016) to Revision F (September 2021)	Page
• 更新了整个文档中的表格、图和交叉参考的编号格式.....	1
Changes from Revision D (April 2016) to Revision E (November 2016)	Page
• Changed the HBM value From: ± 1000 To: ± 2000 in 节 7.2	4
• Changed the CDM value From: ± 250 To: ± 750 in 节 7.2	4

5 Device Comparison Table

PART NUMBER	INTEGRATED LDO OR LOAD SWITCH	VMAIN (ACTIVE MODE)	VMAIN (LOW POWER MODE)	VSUB (ACTIVE MODE)	VSUB (LOW POWER MODE)	VSUB ACTIVE DISCHARGE IN LOW POWER MODE
TPS61098DSE ⁽¹⁾	LDO	4.3 V	2.2 V	3.1 V	OFF	No
TPS610981DSE	LDO	3.3 V	3.3 V	3.0 V	OFF	Yes
TPS610982DSE	LDO	3.3 V	3.3 V	2.8 V	2.8 V	No
TPS610985DSE	Load Switch	3.0 V	3.0 V	ON	OFF	Yes
TPS610986DSE	Load Switch	3.3 V	3.3 V	ON	OFF	Yes
TPS610987DSE	LDO	4.3 V	2.2 V	3.1 V	OFF	Yes

(1) The DSE package is available taped and reeled. Add R suffix to device type (for example, TPS61098DSER) to order quantities of 3000 devices per reel. Add T suffix to device type (for example, TPS61098DSET) to order quantities of 250 devices per reel. For detailed ordering information, please check the [package option addendum](#) at the end of this data sheet.

6 Pin Configuration and Functions



图 6-1. DSE Package 6-Pin WSON Top View

表 6-1. Pin Functions

PIN		I/O	DESCRIPTION
NAME	NO.		
VMAIN	1	PWR	Boost converter output
SW	2	PWR	Connection for inductor
VIN	3	I	IC power supply input
MODE	4	I	Mode selection pin. 1: Active mode; 0: Low Power mode. Must be actively tied high or low. Do not leave floating.
VSUB	5	PWR	LDO or load switch output
GND	6	PWR	IC ground

7 Specifications

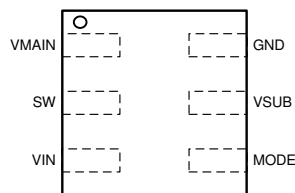
7.1 Absolute Maximum Ratings

over operating free-air temperature range (unless otherwise noted)⁽¹⁾

		MIN	MAX	UNIT
Input voltage	VIN, SW, VMAIN, VSUB	- 0.3	4.7	V
	MODE	- 0.3	5.0	V
Operating junction temperature, T _J		- 40	150	°C
Storage temperature range, T _{stg}		- 65	150	°C

- (1) Stresses beyond those listed under *Absolute Maximum Ratings* may cause permanent damage to the device. These are stress ratings only, and functional operation of the device at these or any other conditions beyond those indicated under *Recommended Operating Conditions* is not implied. Exposure to absolute-maximum-rated conditions for extended periods may affect device reliability.

7.2 ESD Ratings

		VALUE	UNIT
V _(ESD)	Electrostatic discharge		
	Human Body Model (HBM), per ANSI/ESDA/JEDEC JS-001, all pins ⁽¹⁾	±2000	V
	Charged Device Model (CDM), per JEDEC specification JESD22-C101, all pins ⁽²⁾	±750	

- (1) JEDEC document JEP155 states that 500V HBM rating allows safe manufacturing with a standard ESD control process.
 (2) JEDEC document JEP157 states that 250V CDM rating allows safe manufacturing with a standard ESD control process.

7.3 Recommended Operating Conditions

		MIN	NOM	MAX	UNIT
V _{IN}	Input voltage range	0.7		4.5	V
V _(MAIN)	Boost converter output voltage range	2.2		4.3	V
V _(SUB)	Load switch / LDO output voltage range	1.8		3.7	V
L	Effective inductance range	1.54	4.7	6.11	μH
C _{BAT}	Effective input capacitance range at input ⁽¹⁾	5			μF
C _{O1}	Effective output capacitance range at VMAIN pin for boost converter output ⁽¹⁾	5	10	22	μF
C _{O2}	Effective output capacitance range at VSUB pin for LDO output ⁽¹⁾	1 ⁽²⁾	5	10	μF
	Effective output capacitance range at VSUB pin for load switch output ^{(1) (3)}		1	2.2	μF
T _J	Operating virtual junction temperature	- 40		125	°C

- (1) Effective value. Ceramic capacitor's derating effect under bias should be considered. Choose the right nominal capacitance by checking capacitor DC bias characteristics.
 (2) If LDO output current is lower than 20 mA, the minimum effective output capacitance value can be lower to 0.5 μF.
 (3) With load switch version, the output capacitor at VSUB pin is only required if smaller voltage ripple is needed.

7.4 Thermal Information

THERMAL METRIC ⁽¹⁾		TPS61098x	UNIT
		DSE 6 PINS	
R _{θJA}	Junction-to-ambient thermal resistance	207.3	°C/W
R _{θJctop}	Junction-to-case (top) thermal resistance	118.9	°C/W
R _{θJB}	Junction-to-board thermal resistance	136.4	°C/W
ψ _{JT}	Junction-to-top characterization parameter	8.3	°C/W
ψ _{JB}	Junction-to-board characterization parameter	136.4	°C/W
R _{θJCbot}	Junction-to-case (bottom) thermal resistance	N/A	°C/W

- (1) For more information about traditional and new thermal metrics, see the [Semiconductor and IC Package Thermal Metrics](#) application report.

7.5 Electrical Characteristics

$T_J = -40^{\circ}\text{C}$ to 125°C and $V_{IN} = 0.7\text{ V}$ to 4.5 V . Typical values are at $V_{IN} = 1.5\text{ V}$, $T_J = 25^{\circ}\text{C}$, unless otherwise noted.

PARAMETER		VERSION	TEST CONDITIONS	MIN	TYP	MAX	UNIT
Power Supply							
V_{IN}	Input voltage range	TPS61098x		0.7		4.5	V
$V_{IN(start)}$	Minimum input voltage at start-up	TPS61098x	$R_{Load} \geq 3\text{ k}\Omega$ (1)			0.7	V
$I_{Q(VIN)}$	Quiescent current into the VIN pin in Active mode	TPS61098x	MODE = High, Boost or Pass-through no load, no switching $T_J = -40^{\circ}\text{C}$ to 85°C		2	4	μA
	Quiescent current into the VIN pin in Low Power mode	TPS61098x	MODE = Low, Boost or Pass-through no load, no switching		5	90	nA
$I_{Q(VMAIN)}$	Quiescent current into the VMAIN pin in Active mode	TPS61098/1/5/6/7	MODE = High, Boost or Pass-through no load, no switching $T_J = -40^{\circ}\text{C}$ to 85°C		15	23	μA
		TPS610982	MODE = High, Boost or Pass-through no load, no switching $T_J = -40^{\circ}\text{C}$ to 85°C		18	23	μA
	Quiescent current into the VMAIN pin in Low Power mode	TPS61098/1/7	MODE = Low, Boost or Pass-through no load, no switching $T_J = 25^{\circ}\text{C}$		300	400	nA
		TPS61098/1/5/6/7	MODE = Low, Boost or Pass-through no load, no switching $T_J = -40^{\circ}\text{C}$ to 85°C		300	800	nA
		TPS610982	MODE = Low, Boost or Pass-through no load, no switching $T_J = -40^{\circ}\text{C}$ to 85°C		4	10	μA
$I_{LKG(SW)}$	Leakage current of the SW pin (from the SW pin to GND pin)	TPS61098x	$V_{(MAIN)} = V_{(SW)} = 4.7\text{ V}$, no load $T_J = -40^{\circ}\text{C}$ to 85°C		5	100	nA
$I_{LKG(MAIN)}$	Leakage current of the VMAIN pin (from the VMAIN pin to SW pin)	TPS61098x	$V_{(MAIN)} = 4.7\text{ V}$, $V_{(SW)} = 0\text{ V}$, no load $T_J = -40^{\circ}\text{C}$ to 85°C		10	200	nA
$I_{LKG(SUB)}$	Leakage current of the VSUB pin (from the VMAIN pin to VSUB pin)	TPS61098/1/5/6/7	MODE = Low, $V_{(MAIN)} = 4.7\text{ V}$, $V_{(SUB)} = 0\text{ V}$ $T_J = -40^{\circ}\text{C}$ to 85°C		10	150	nA
$I_{LKG(MODE)}$	Leakage current into the MODE pin	TPS61098x	$V_{(MODE)} = 5\text{ V}$ $T_J = -40^{\circ}\text{C}$ to 85°C		5	30	nA
Power Switch							
$R_{DS(on)_LS}$	Low-side switch on resistance	TPS61098/7	MODE = Low		600	1000	$\text{m}\Omega$
			MODE = High		300	600	$\text{m}\Omega$
		TPS610981/2/6	MODE = Low / High		350	650	$\text{m}\Omega$
		TPS610985	MODE = Low / High		400	700	$\text{m}\Omega$
$R_{DS(on)_HS}$	Rectifier on resistance	TPS61098/7	MODE = Low		700	1000	$\text{m}\Omega$
			MODE = High		450	700	$\text{m}\Omega$
		TPS610981/2/6	MODE = Low / High		500	700	$\text{m}\Omega$
		TPS610985	MODE = Low / High		550	750	$\text{m}\Omega$
$R_{(LS)}$	Load switch on resistance	TPS610985/6			1.2	2	Ω
$V_{(Dropout)}$	LDO dropout voltage	TPS61098/1/2/7	$I_{SUB} = 50\text{ mA}$		60	100	mV
I_{LH}	Inductor current ripple	TPS61098x			100		mA
$I_{LIM(BST)}$	Boost switch current limit	TPS61098x	$0.7\text{ V} < V_{IN} < V_{(MAIN)}$	350	500	650	mA
$I_{LIM(SUB)}$	VSUB output current limit	TPS61098x	$T_J = -20^{\circ}\text{C}$ to 125°C	200			mA
$I_{(DISCH)}$	Discharge current from the VSUB pin to GND pin	TPS610981/5/6/7	MODE = Low, $V_{(SUB)} = 3\text{ V}$	5	8		mA

$T_J = -40^{\circ}\text{C}$ to 125°C and $V_{IN} = 0.7\text{ V}$ to 4.5 V . Typical values are at $V_{IN} = 1.5\text{ V}$, $T_J = 25^{\circ}\text{C}$, unless otherwise noted.

PARAMETER		VERSION	TEST CONDITIONS	MIN	TYP	MAX	UNIT
Output							
$V_{(MAIN)}$	Boost converter output voltage	TPS61098/7	MODE = High, $V_{IN} < V_{(PSTH)}$, Burst mode, open loop		4.45		V
			MODE = High, $V_{IN} < V_{(PSTH)}$, PWM mode, open loop	4.142	4.27	4.398	V
			MODE = Low, $V_{IN} < V_{(PSTH)}$, Burst mode, open loop		2.3		V
			MODE = Low, $V_{IN} < V_{(PSTH)}$, PWM mode, open loop	2.163	2.23	2.297	V
		TPS610981	MODE = High / Low, $V_{IN} < V_{(PSTH)}$, Burst mode, open loop		3.4		V
			MODE = High / Low, $V_{IN} < V_{(PSTH)}$, PWM mode, open loop	3.201	3.3	3.399	V
		TPS610982	MODE = High / Low, $V_{IN} < V_{(PSTH)}$, Burst mode, open loop		3.4		V
			MODE = High / Low, $V_{IN} < V_{(PSTH)}$, PWM mode, open loop	3.201	3.3	3.399	V
		TPS610985	MODE = High / Low, $V_{IN} < V_{(PSTH)}$, Burst mode, open loop		3.1		V
			MODE = High / Low, $V_{IN} < V_{(PSTH)}$, PWM mode, open loop	2.91	3.0	3.09	V
		TPS610986	MODE = High / Low, $V_{IN} < V_{(PSTH)}$, Burst mode, open loop		3.4		V
			MODE = High / Low, $V_{IN} < V_{(PSTH)}$, PWM mode, open loop	3.201	3.3	3.399	V
$V_{(SUB)}$	LDO output voltage (LDO version)	TPS61098/7	MODE = High	3.038	3.1	3.162	V
		TPS610981	MODE = High	2.94	3.0	3.06	V
		TPS610982	MODE = High / Low	2.744	2.8	2.856	V
$V_{(PSTH)}$	Pass-through mode threshold	TPS61098/7	MODE = High, V_{IN} rising		4.4		V
			MODE = High, Hysteresis		0.1		V
			MODE = Low, V_{IN} rising		2.25		V
			MODE = Low, Hysteresis		0.1		V
		TPS610981	MODE = High / Low, V_{IN} rising		3.35		V
			MODE = High / Low, Hysteresis		0.1		V
		TPS610982	MODE = High / Low, V_{IN} rising		3.35		V
			MODE = High / Low, Hysteresis		0.1		V
		TPS610985	MODE = High / Low, V_{IN} rising		3.05		V
			MODE = High / Low, Hysteresis		0.1		V
		TPS610986	MODE = High / Low, V_{IN} rising		3.35		V
			MODE = High / Low, Hysteresis		0.1		V
PSRR	Power-supply rejection ratio from LDO input to output	TPS61098/1/2/7	$f = 1\text{ kHz}$, $C_{O2} = 10\ \mu\text{F}$, $I_{SUB} = 10\ \text{mA}$ MODE = High		40		dB
		TPS610982	$f = 1\text{ kHz}$, $C_{O2} = 10\ \mu\text{F}$, $I_{SUB} = 10\ \text{mA}$ MODE = Low		28		dB
$t_{\text{stup_LDO}}$	VSUB start-up time (LDO version and load switch version)	TPS61098x	No load time from MODE high to 90% of $V_{(SUB)}$		1		ms
Control Logic							
V_{IL}	MODE input low voltage	TPS61098x				0.4	V
V_{IH}	MODE input high voltage	TPS61098x		1.2			V
	Overtemperature protection	TPS61098x			150		$^{\circ}\text{C}$
	Overtemperature hysteresis	TPS61098x			25		$^{\circ}\text{C}$

(1) TPS61098x is able to drive $R_{Load} > 150\ \Omega$ after V_{MAIN} is established over 1.8 V.

7.6 Typical Characteristics

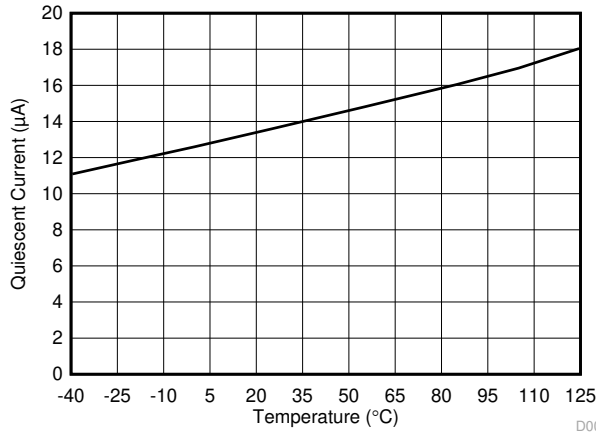

TPS61098, '1, '5, '6 MODE = High

图 7-1. I_Q into VMAIN Pin at Active Mode vs Temperature

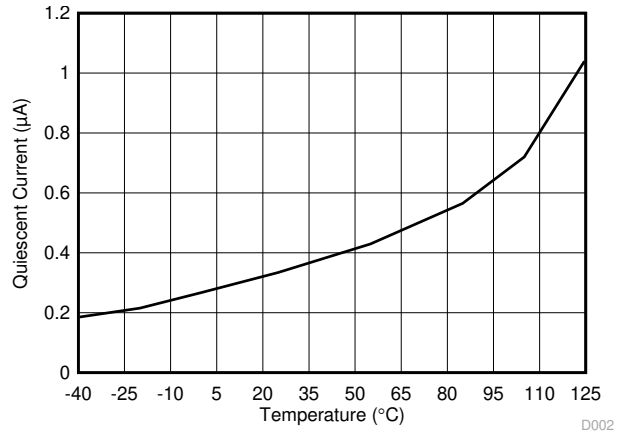

TPS61098, '1, '5, '6 MODE = Low

图 7-2. I_Q into VMAIN Pin at Low Power Mode vs Temperature

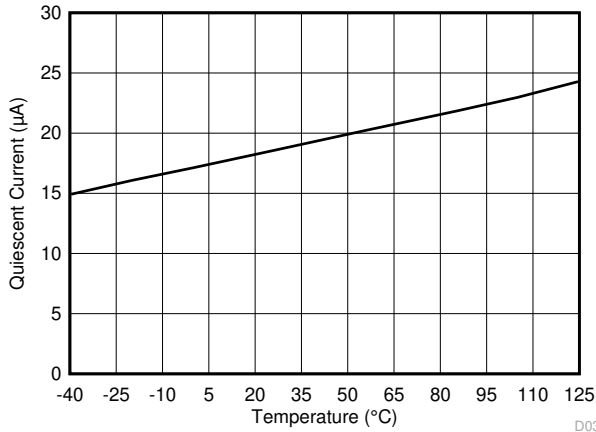

TPS610982 MODE = High

图 7-3. I_Q into VMAIN Pin at Active Mode vs Temperature

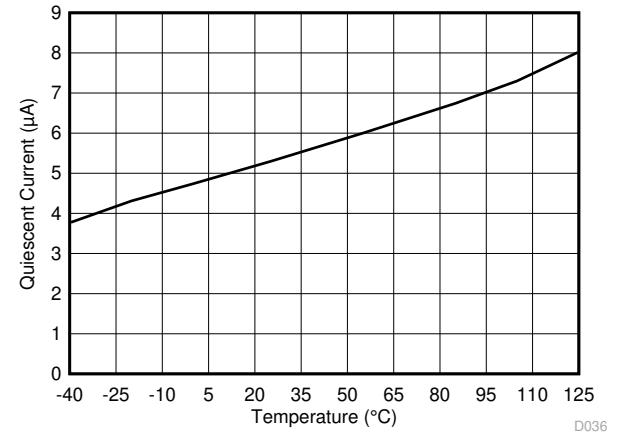

TPS610982 MODE = Low

图 7-4. I_Q into VMAIN Pin at Low Power Mode vs Temperature

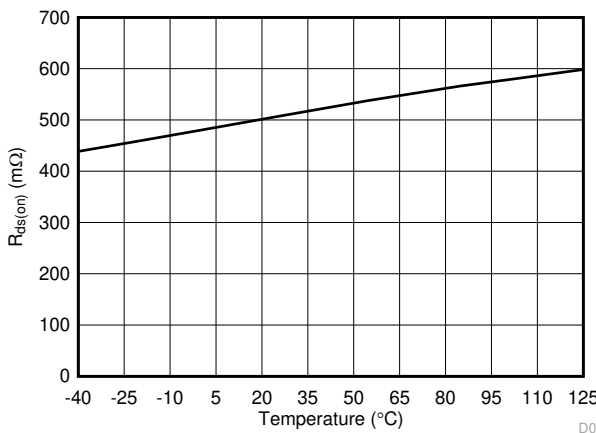

TPS61098, '7 MODE = High

图 7-5. Rectifier On Resistance vs Temperature

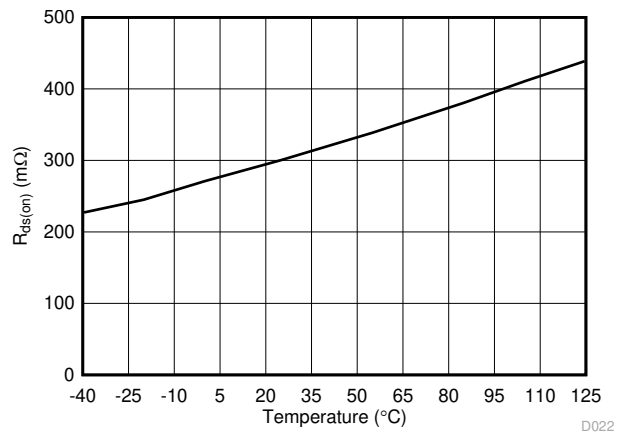

TPS61098, '7 MODE = High

图 7-6. Low Side Switch On Resistance vs Temperature



图 7-7. Rectifier On Resistance vs Temperature



图 7-8. Low Side Switch On Resistance vs Temperature

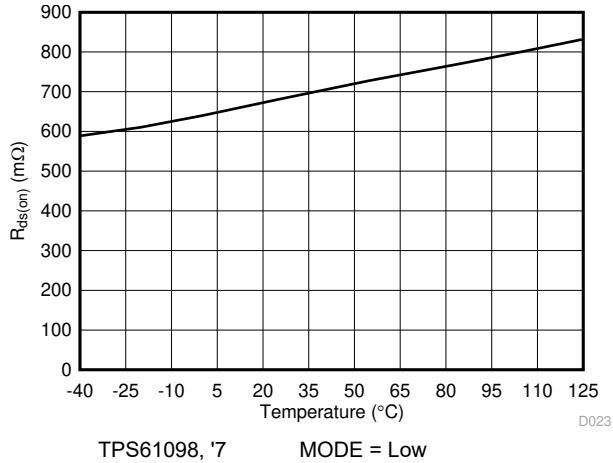

图 7-9. Rectifier On Resistance vs Temperature

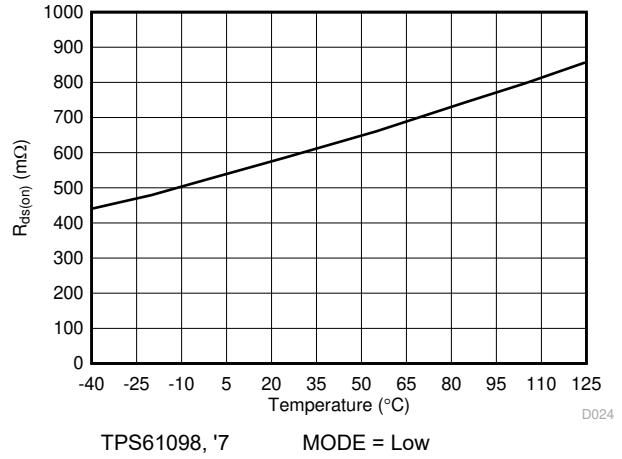

图 7-10. Low Side Switch On Resistance vs Temperature

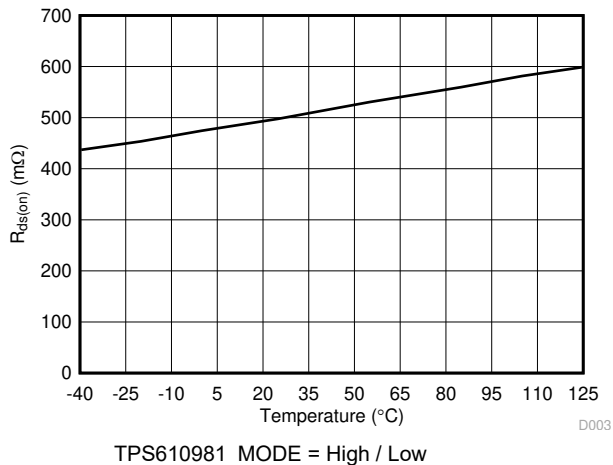

图 7-11. Rectifier On Resistance vs Temperature

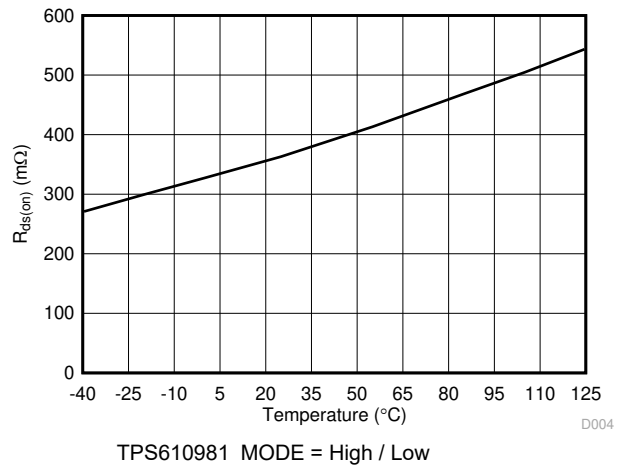

图 7-12. Low Side Switch On Resistance vs Temperature

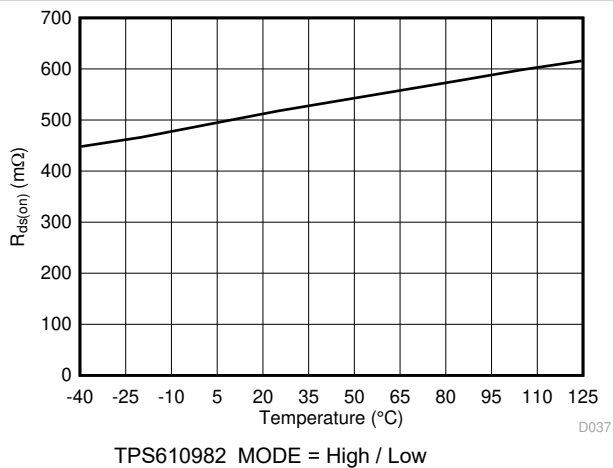

图 7-13. Rectifier on Resistance vs Temperature

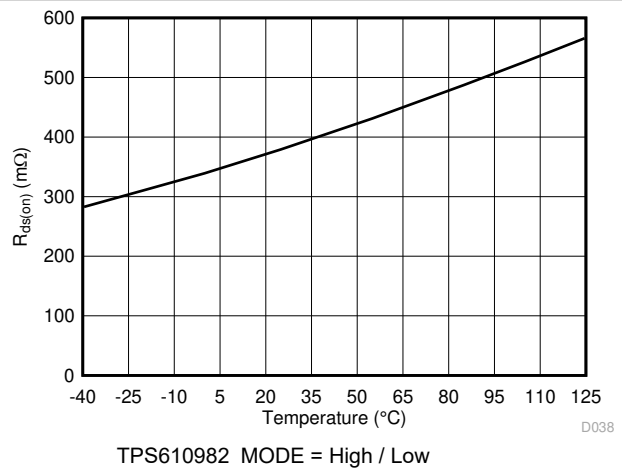

图 7-14. Low Side Switch On Resistance vs Temperature

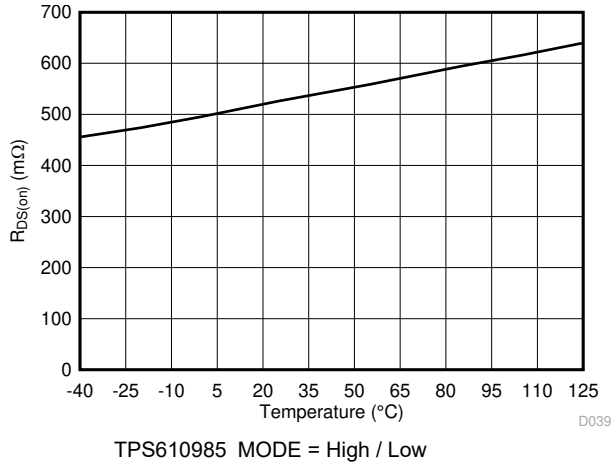

图 7-15. Rectifier on Resistance vs Temperature

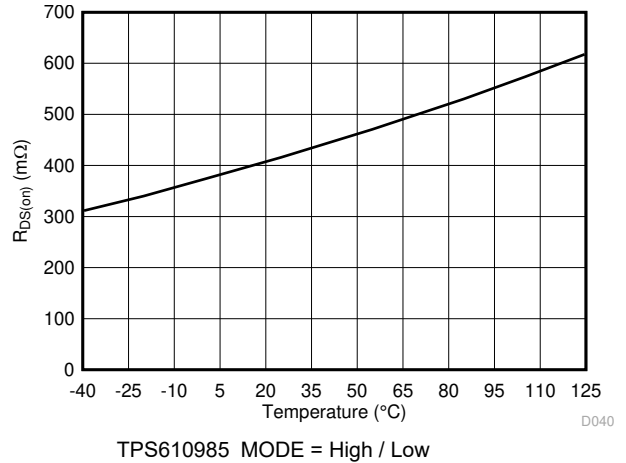

图 7-16. Low Side Switch on Resistance vs Temperature

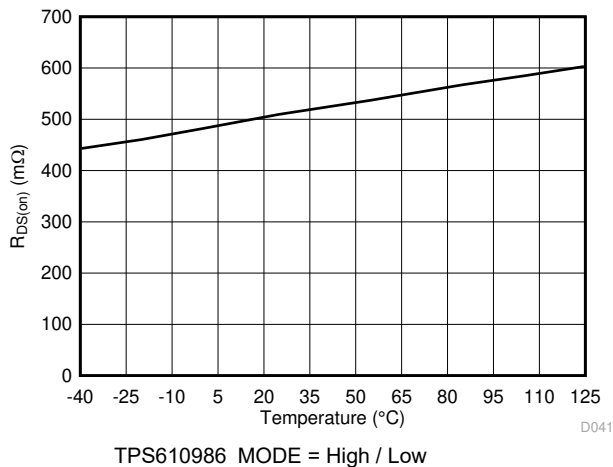

图 7-17. Current Limit vs Temperature

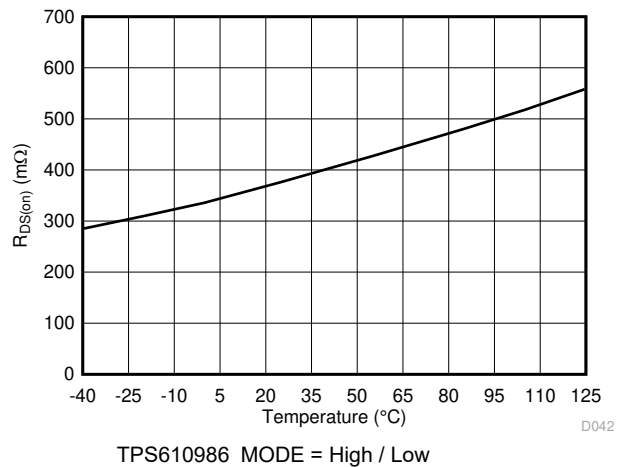

图 7-18. Boost Efficiency vs Output Current (Low Power Mode)

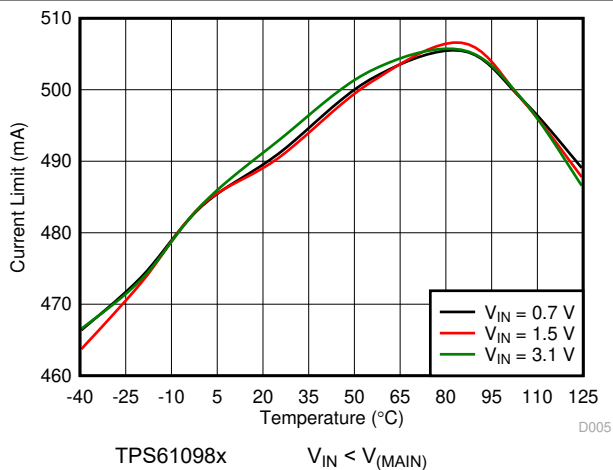

图 7-19. Boost Efficiency vs Output Current (Active Mode)

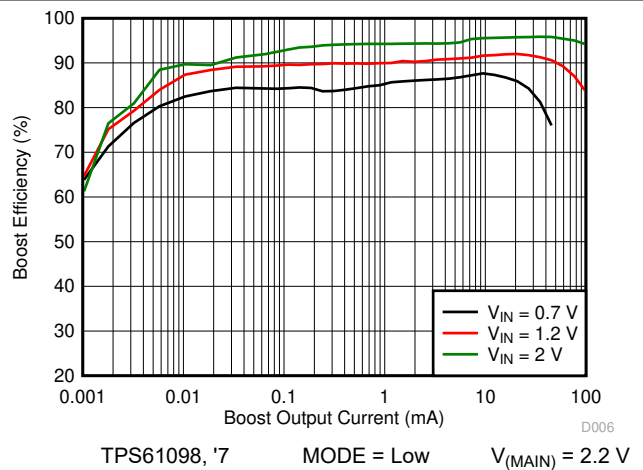

图 7-20. Boost Efficiency vs Output Current (Low Power Mode)

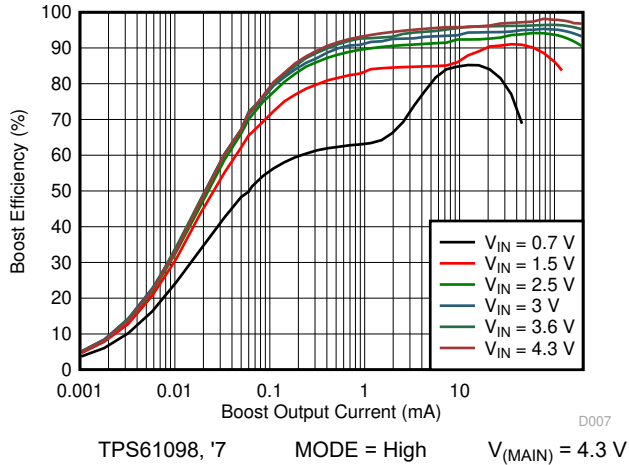

图 7-21. Boost Efficiency vs Output Current (Active Mode)

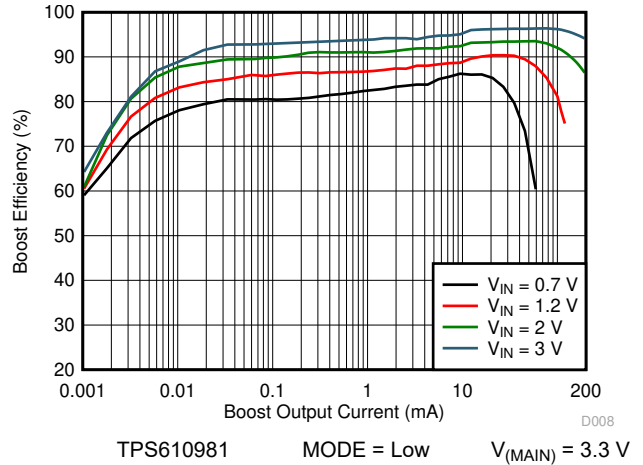

图 7-22. Boost Efficiency vs Output Current (Low Power Mode)

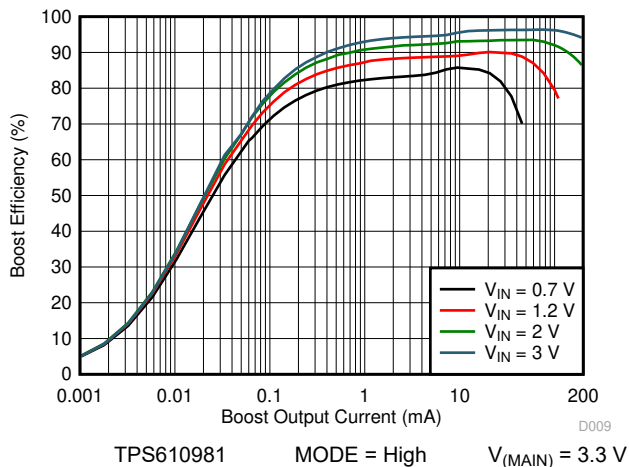

图 7-23. Boost Efficiency vs Output Current (Active Mode)

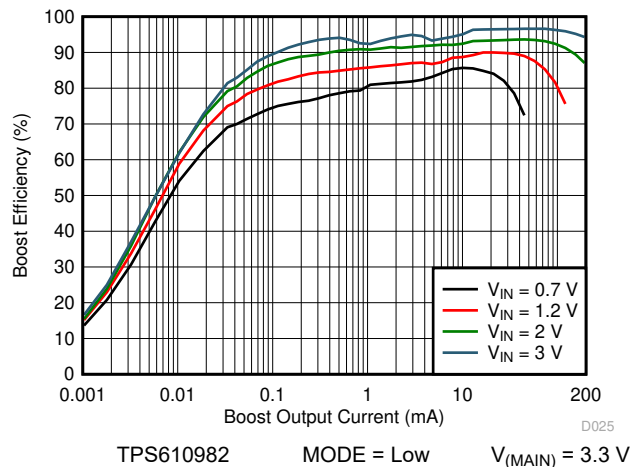

图 7-24. Boost Efficiency vs Output Current (Low Power Mode)

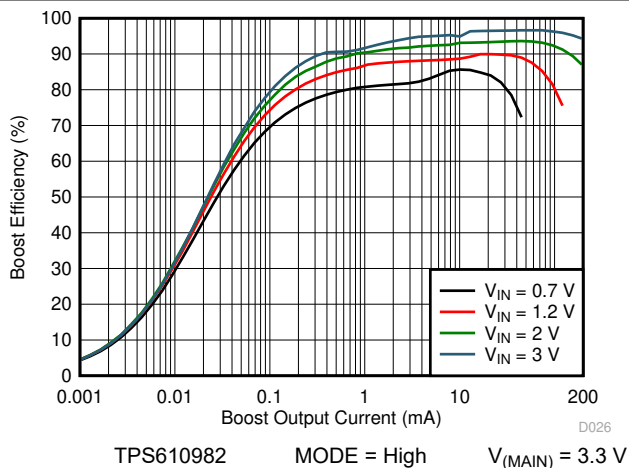

图 7-25. Boost Efficiency vs Output Current (Active Mode)

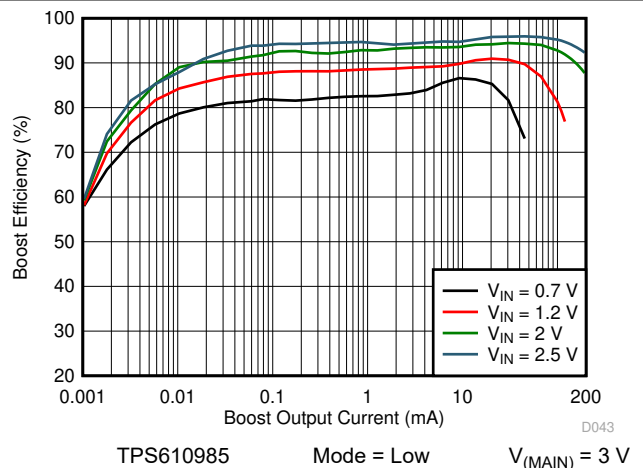

图 7-26. Boost Efficiency vs Output Current (Low Power Mode)

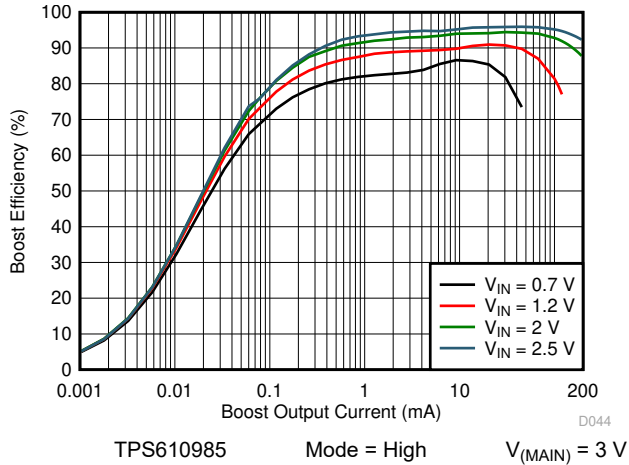

图 7-27. Boost Efficiency vs Output Current (Active Mode)

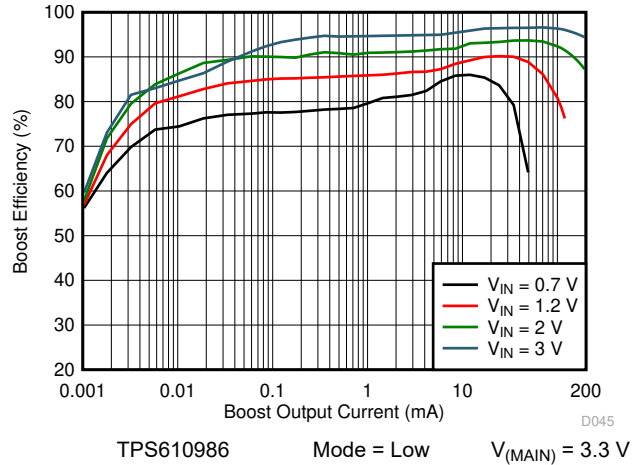

图 7-28. Boost Load Regulation (Low Power Mode)

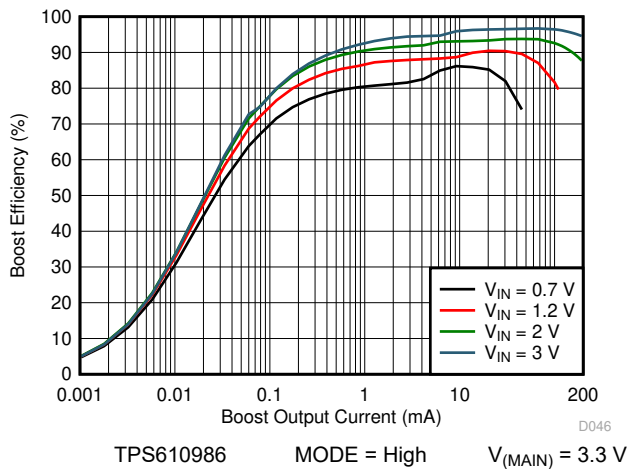

图 7-29. Boost Load Regulation (Active Mode)

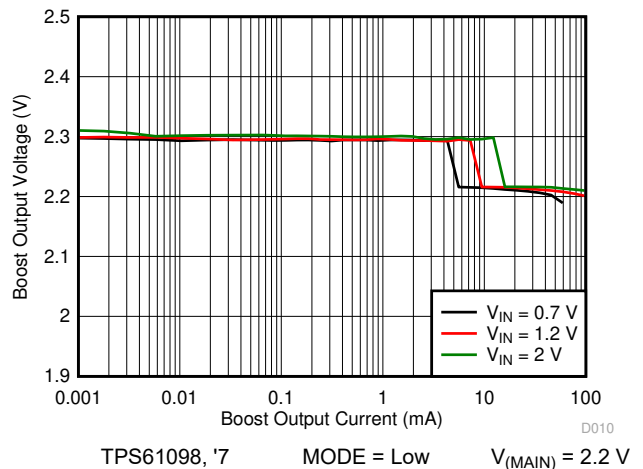

图 7-30. Boost Load Regulation (Low Power Mode)

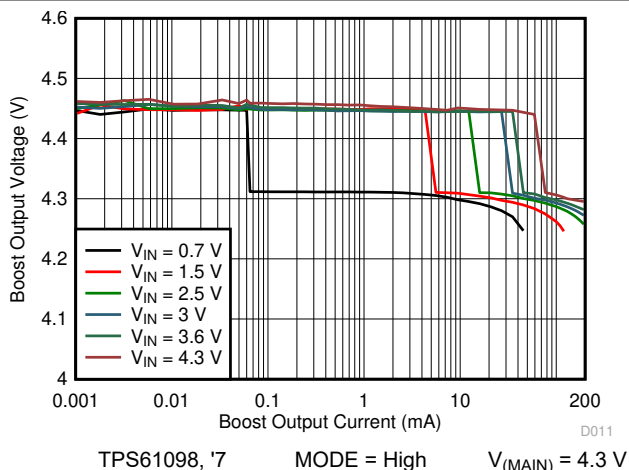

图 7-31. Boost Load Regulation (Active Mode)

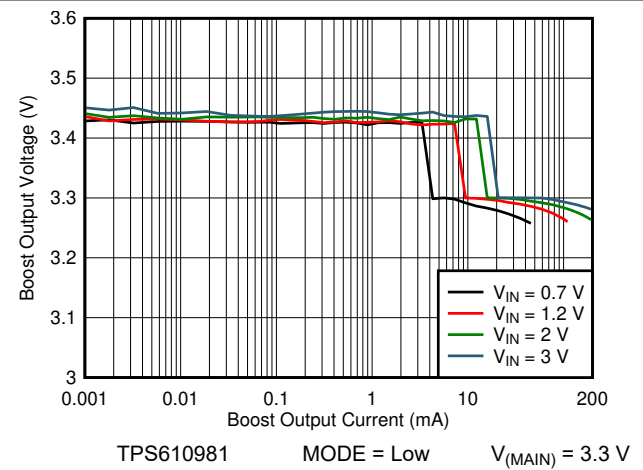

图 7-32. Boost Load Regulation (Low Power Mode)

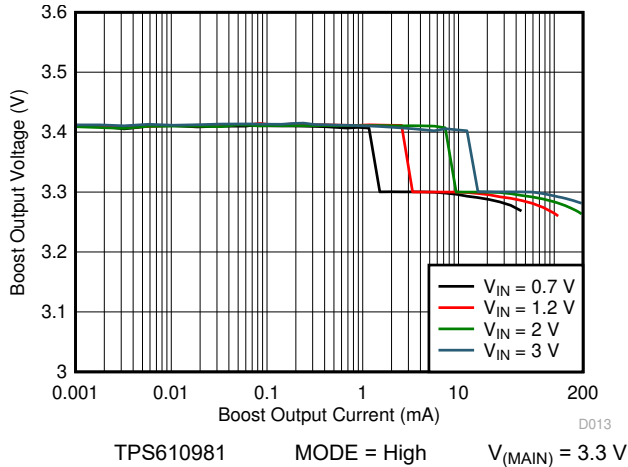

图 7-33. Boost Load Regulation (Active Mode)

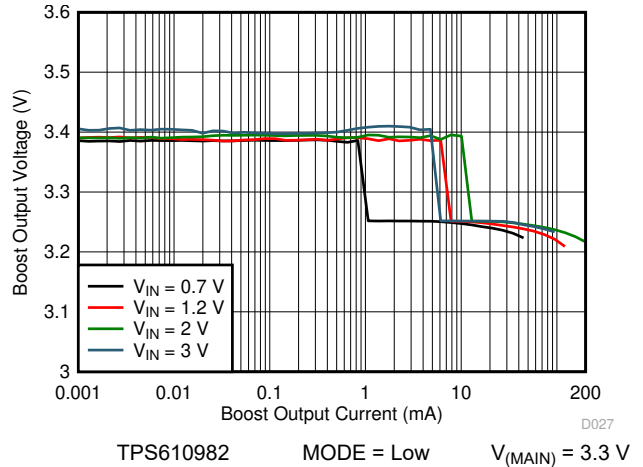

图 7-34. Boost Load Regulation (Low Power Mode)

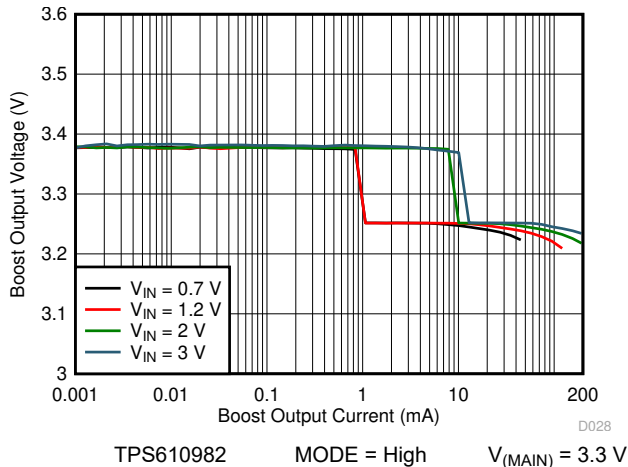

图 7-35. Boost Load Regulation (Active Mode)

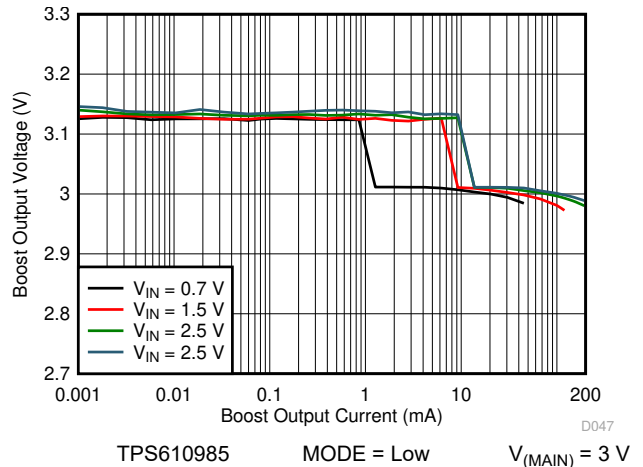

图 7-36. Boost Load Regulation (Low Power Mode)

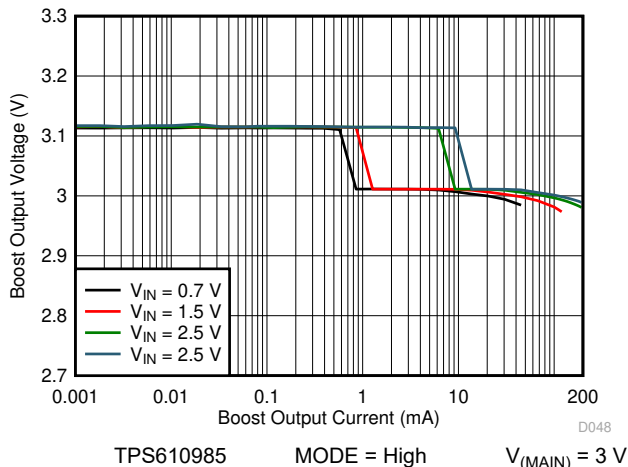

图 7-37. Boost Load Regulation (Active Mode)

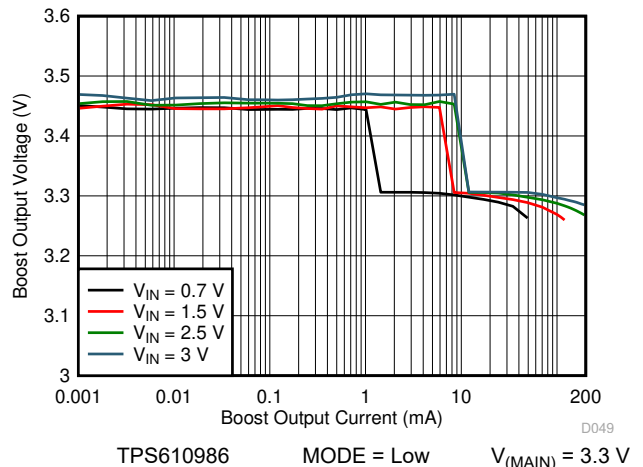

图 7-38. LDO Load Regulation

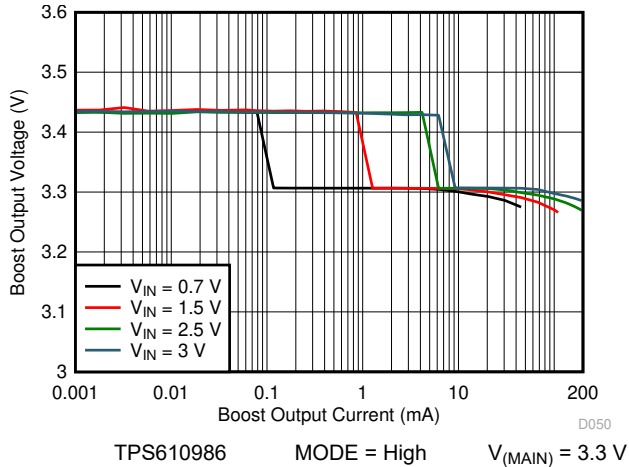

图 7-39. LDO Load Regulation

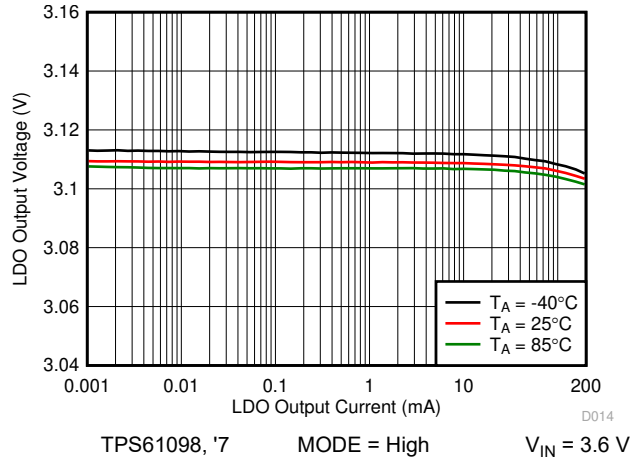

图 7-40. LDO Load Regulation (Low Power Mode)

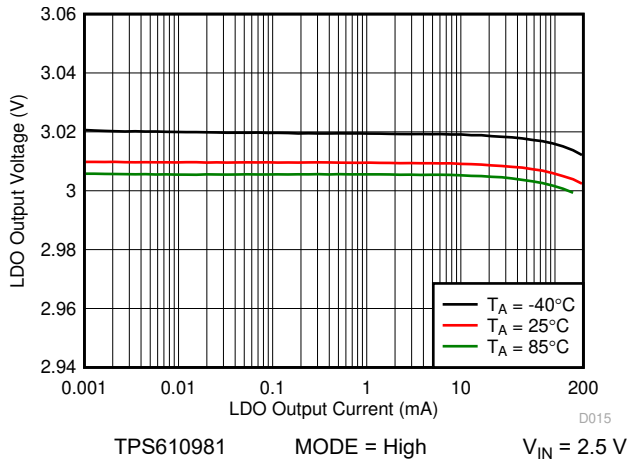

图 7-41. LDO Load Regulation (Active Mode)

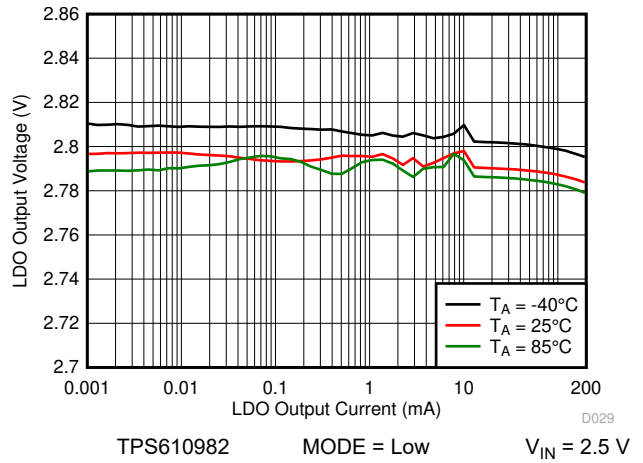

图 7-42. Input Current vs Input Voltage (Low Power Mode)

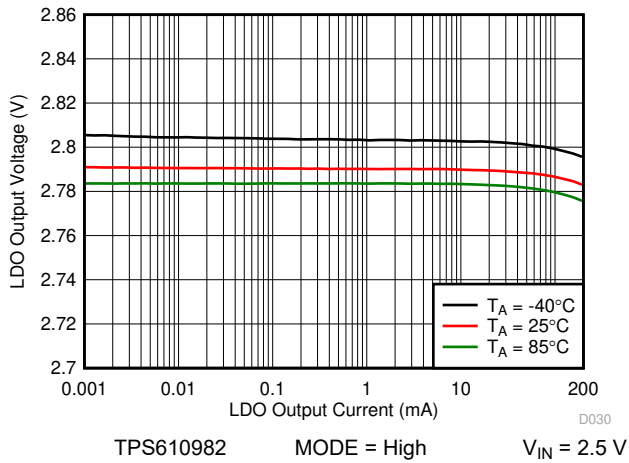

TPS610981 MODE = Low No Load

图 7-43. Input Current vs Input Voltage (Low Power Mode)

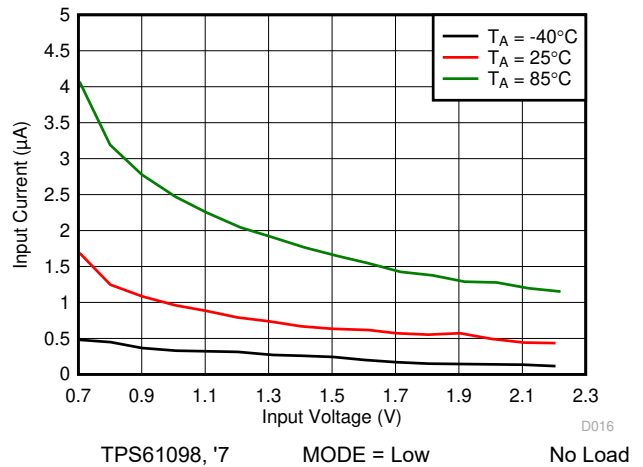
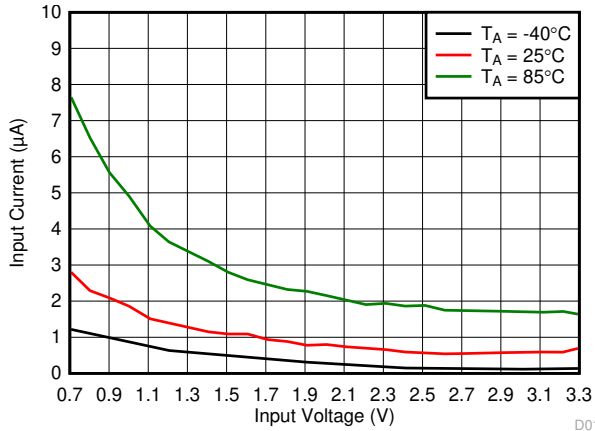
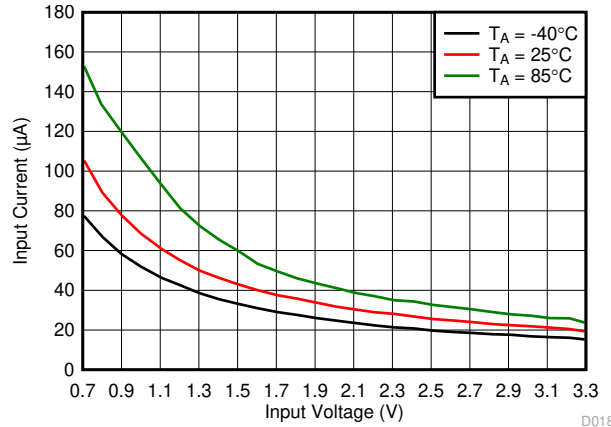

TPS610981 MODE = High No Load

图 7-44. Input Current vs Input Voltage (Active Mode)

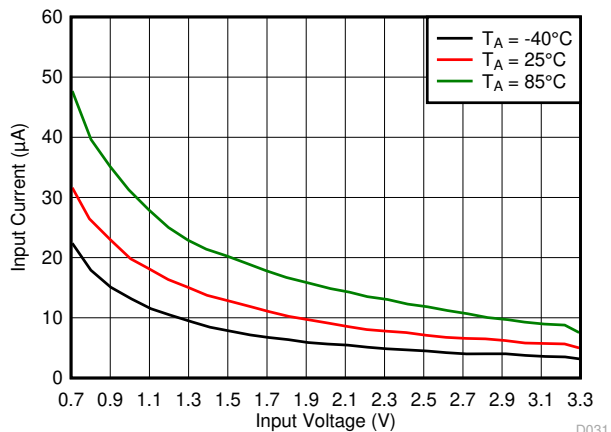

TPS610982 MODE = Low No Load

图 7-45. No Load Input Current vs Input Voltage (Low Power Mode)

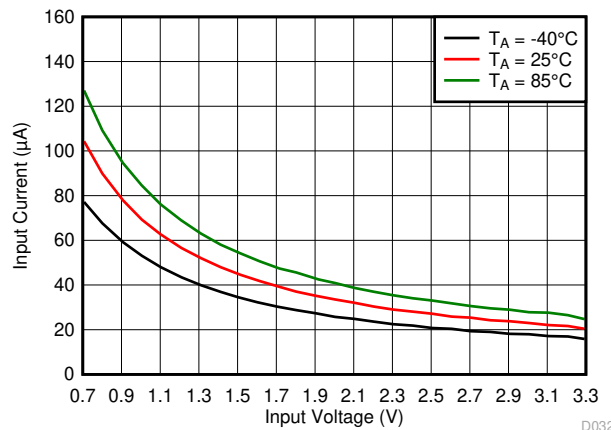

TPS610982 MODE = High No Load

图 7-46. No Load Input Current vs Input Voltage (Active Mode)

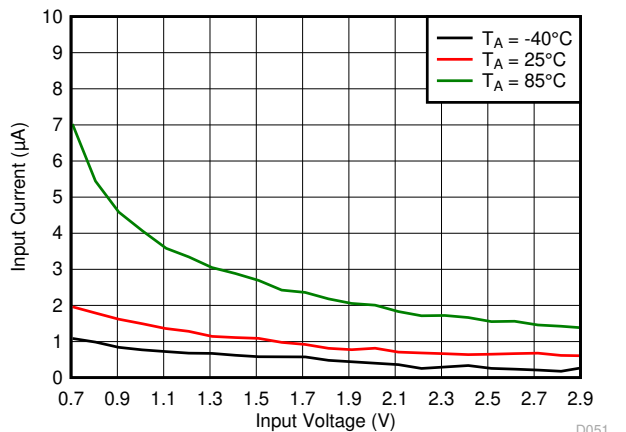

TPS610985 MODE = Low V_(MAIN) = 3 V

图 7-47. Input Current vs Input Voltage (Low Power Mode)

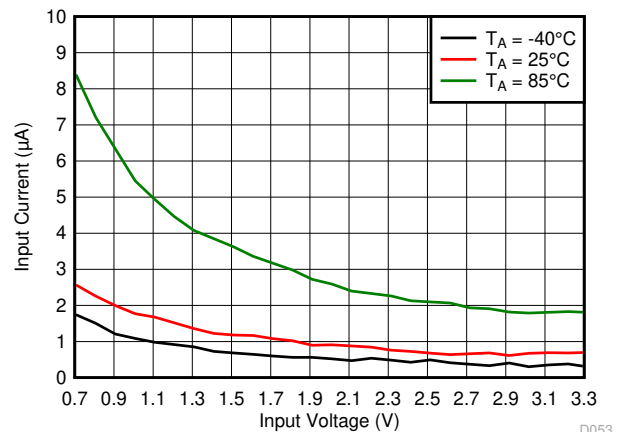

TPS610986 MODE = Low V_(MAIN) = 3.3 V

图 7-48. Input Current vs Input Voltage (Low Power Mode)

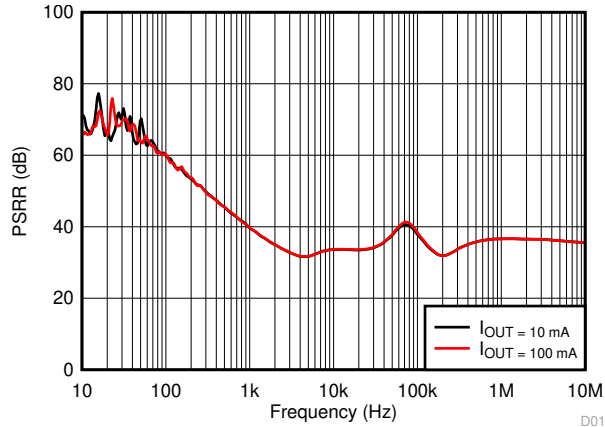

TPS61098. '7 MODE = High $C_{O2} = 10 \mu\text{F}$
 $V_{IN} - V_{OUT} = 4.3 \text{ V} - 3.1 \text{ V} = 1.2 \text{ V}$

图 7-49. LDO PSRR vs Frequency

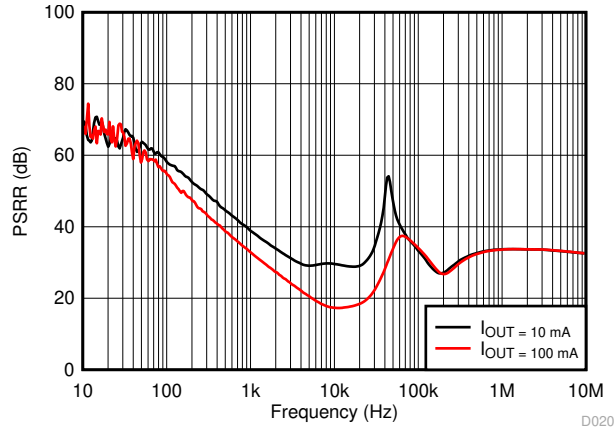

TPS610981 MODE = High $C_{O2} = 10 \mu\text{F}$
 $V_{IN} - V_{OUT} = 3.3 \text{ V} - 3 \text{ V} = 0.3 \text{ V}$

图 7-50. LDO PSRR vs Frequency

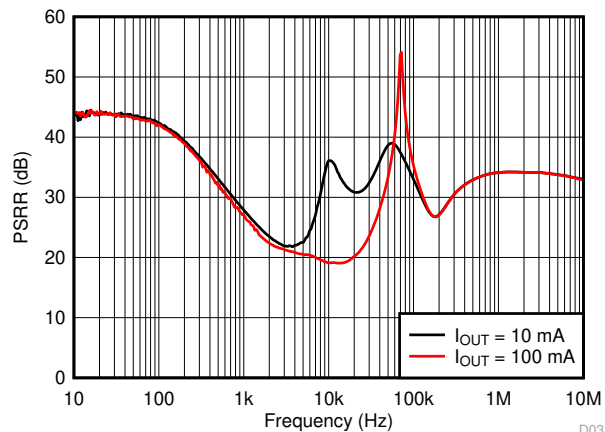

TPS610982 MODE = Low $C_{O2} = 10 \mu\text{F}$
 $V_{IN} - V_{OUT} = 3.3 \text{ V} - 2.8 \text{ V} = 0.5 \text{ V}$

图 7-51. LDO PSRR vs Frequency (Low Power Mode)

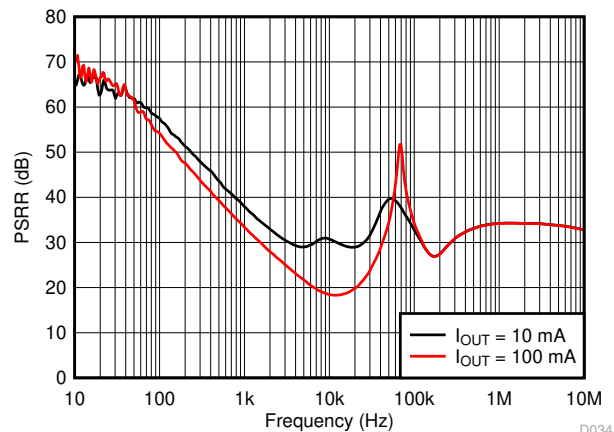

TPS610982 MODE = High $C_{O2} = 10 \mu\text{F}$
 $V_{IN} - V_{OUT} = 3.3 \text{ V} - 2.8 \text{ V} = 0.5 \text{ V}$

图 7-52. LDO PSRR vs Frequency (Active Mode)

8 Detailed Description

8.1 Overview

The TPS61098x is an ultra-low power solution optimized for products powered by either a one-cell or two-cell alkaline, NiCd or NiMH, one-cell coin cell battery or one-cell Li-Ion or Li-polymer battery. To simplify system design and save PCB space, the TPS61098x integrates an LDO or load switch with a boost converter (different configurations for different versions) to provide two output rails in a compact package. The boost output $V_{(MAIN)}$ is designed as an always-on supply to power a main system, and the LDO or load switch output $V_{(SUB)}$ is designed to power peripheral devices and can be turned off.

The TPS61098x features two modes controlled by MODE pin: Active mode and Low Power mode. In Active mode, both outputs are enabled, and the transient response performance of the boost converter and LDO/load switch are enhanced, so it is able to respond load transient quickly. In Low Power mode, the LDO/load switch is disabled, so the peripherals can be disconnected to minimize the battery drain. Besides that, the boost consumes only 300 nA quiescent current in Low Power mode, so up to 88% efficiency at 10 μ A load can be achieved to extend the battery run time. The TPS610982 is an exception. Its LDO is always on in both Active mode and Low Power mode. The main differences between the two modes of the TPS610982 are the quiescent current and performance. Refer to [节 8.4.1](#) for details.

The TPS61098x supports automatic pass-through function in both Active mode and Low Power mode. When V_{IN} is detected higher than a pass-through threshold, which is around the target $V_{(MAIN)}$ voltage, the boost converter stops switching and passes the input voltage through inductor and internal rectifier switch to $V_{(MAIN)}$, so $V_{(MAIN)}$ follows V_{IN} ; when V_{IN} is lower than the threshold, the boost works in boost mode and regulates $V_{(MAIN)}$ at the target value. The TPS61098x can support different $V_{(MAIN)}$ target values in Active mode and Low Power mode to meet various requirements. For example, for TPS61098, the set value of $V_{(MAIN)}$ is 4.3 V in Active mode but 2.2 V in Low Power mode.

8.2 Functional Block Diagrams

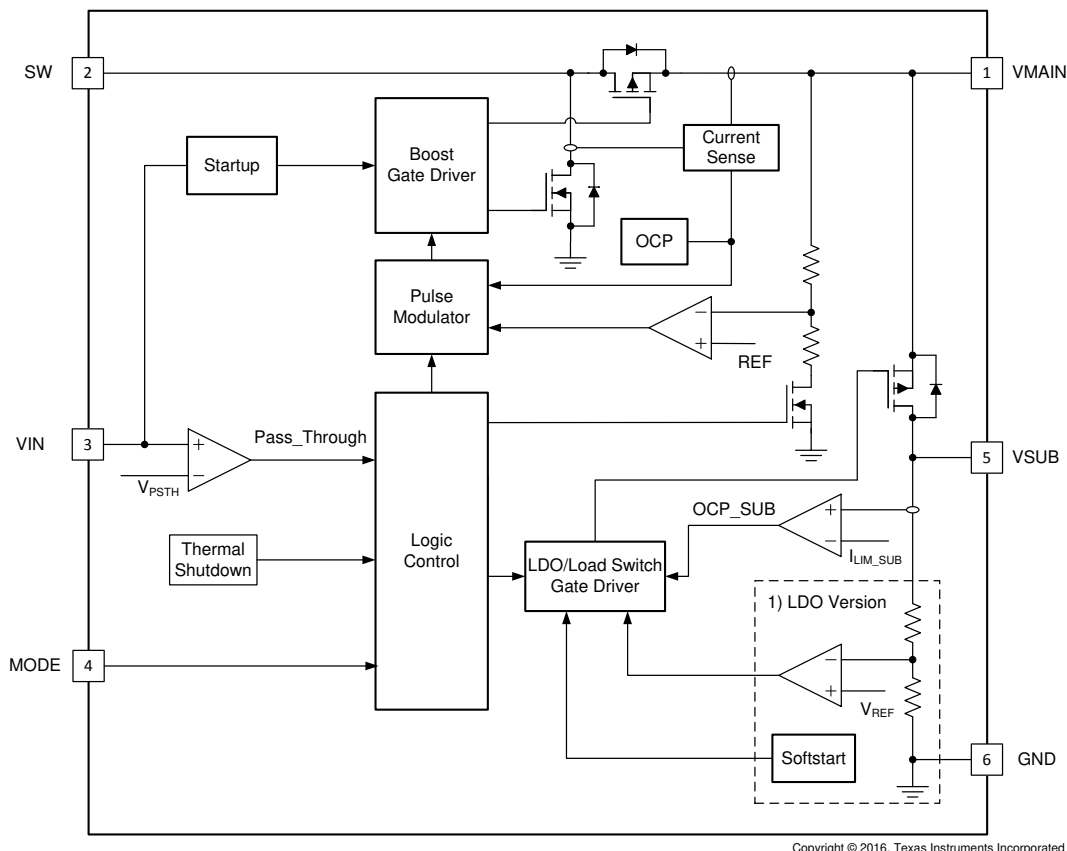

Copyright © 2016, Texas Instruments Incorporated

A. Implemented in versions with LDO configuration.

8.3 Feature Description

8.3.1 Boost Controller Operation

The TPS61098x boost converter is controlled by a hysteretic current mode controller. This controller regulates the output voltage by keeping the inductor ripple current constant in the range of 100 mA and adjusting the offset of this inductor current depending on the output load. Since the input voltage, output voltage and inductor value all affect the rising and falling slopes of inductor ripple current, the switching frequency is not fixed and is decided by the operation condition. If the required average input current is lower than the average inductor current defined by this constant ripple, the inductor current goes discontinuous to keep the efficiency high under light load conditions. 图 8-1 illustrates the hysteretic current operation. If the load is reduced further, the boost converter enters into Burst mode. In Burst mode, the boost converter ramps up the output voltage with several pulses and it stops operating once the output voltage exceeds a set threshold, and then it goes into a sleep status and consumes less quiescent current. It resumes switching when the output voltage is below the set threshold. It exits the Burst mode when the output current can no longer be supported in this mode. Refer to 图 8-2 for Burst mode operation details.

To achieve high efficiency, the power stage is realized as a synchronous boost topology. The output voltage $V_{(MAIN)}$ is monitored via an internal feedback network which is connected to the voltage error amplifier. To regulate the output voltage, the voltage error amplifier compares this feedback voltage to the internal voltage reference and adjusts the required offset of the inductor current accordingly.



图 8-1. Hysteretic Current Operation



图 8-2. Burst Mode Operation

8.3.2 Pass-Through Operation

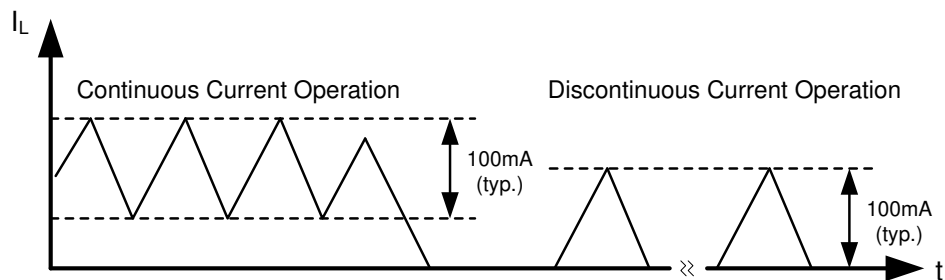
The TPS61098x supports automatic pass-through function for the boost converter. When the input voltage is detected higher than the pass-through threshold $V_{(PSTH)}$, which is around $V_{(MAIN)}$ set value, the boost converter enters into pass-through operation mode. In this mode, the boost converter stops switching, the rectifier is constantly turned on and the low side switch is turned off. The input voltage passes through external inductor and the internal rectifier to the output. The output voltage in this mode depends on the resistance between the input and the output, calculated as 方程式 1:

$$V_{\text{MAIN}} = V_{\text{IN}} - (I_{\text{MAIN}} + I_{\text{SUB}}) \times (R_{\text{L}} + R_{\text{DS(on)_HS}}) \quad (1)$$

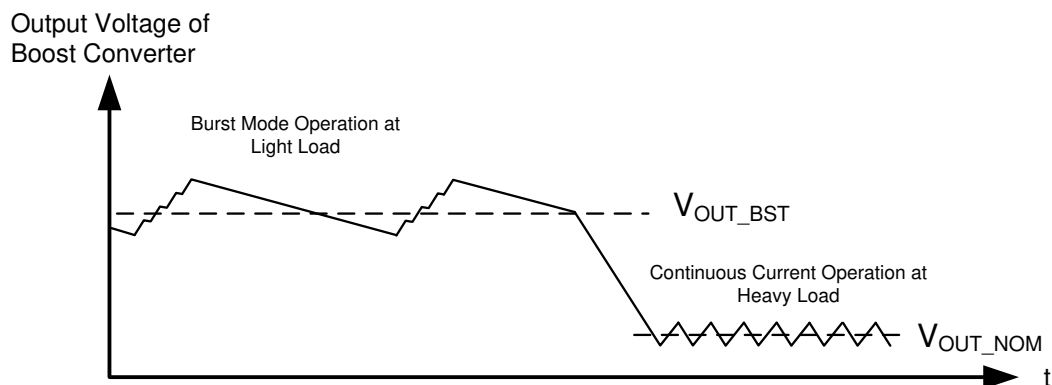
where

- R_{L} is the DCR of external inductor
- $R_{\text{DS(on)_HS}}$ is the resistance of internal rectifier

When the input voltage is lower than $V_{(\text{PSTH})}$, the boost converter resumes switching to regulate the output at target value.

The TPS61098x can support automatic pass-through function in both Active mode and Low Power mode.

8.3.3 LDO / Load Switch Operation

The TPS61098x uses a PMOS as a pass element of its integrated LDO / load switch. The input of the PMOS is connected to the output of the boost converter. When the MODE pin is pulled logic high, the PMOS is enabled to output a voltage on VSUB pin.

For load switch version, the PMOS pass element is fully turned on when enabled, no matter the boost converter works in boost operation mode or pass-through operation mode. So the output voltage at VSUB pin is decided by the output voltage at VMAIN pin and the current passing through the PMOS as [方程式 2](#):

$$V_{\text{SUB}} = V_{\text{MAIN}} - I_{\text{SUB}} \times R_{\text{LS}} \quad (2)$$

where

- $I_{(\text{SUB})}$ is the load of VSUB rail
- R_{LS} is the resistance of the PMOS when it is fully turned on

For LDO version, the output voltage $V_{(\text{SUB})}$ is regulated at the set value when the voltage difference between its input and output is higher than the dropout voltage $V_{(\text{Dropout})}$, no matter the boost converter works in boost operation mode or pass-through operation mode. The $V_{(\text{SUB})}$ is monitored via an internal feedback network which is connected to the voltage error amplifier. To regulate $V_{(\text{SUB})}$, the voltage error amplifier compares the feedback voltage to the internal voltage reference and adjusts the gate voltage of the PMOS accordingly. When the voltage drop across the PMOS is lower than the dropout voltage, the PMOS will be fully turned on and the output voltage at $V_{(\text{SUB})}$ is decided by [方程式 2](#).

When the MODE pin is pulled low, the LDO or load switch is turned off to disconnect the load at VSUB pin. For some versions, active discharge function at VSUB pin is offered, which can discharge the $V_{(\text{SUB})}$ to ground after MODE pin is pulled low, to avoid any bias condition to downstream devices. For versions without the active discharge function, the VSUB pin is floating after MODE pin is pulled low, and its voltage normally drops down slowly due to leakage. Refer to the [节 5](#) for version differences.

When MODE pin is toggled from low to high, soft-start is implemented for the LDO versions to avoid inrush current during LDO startup. The start up time of LDO is typically 1 ms. For load switch versions, the load switch is turned on faster, so the output capacitor at VSUB pin is suggested 10X smaller than the output capacitor at VMAIN pin to avoid obvious voltage drop of $V_{(\text{MAIN})}$ during load switch turning on process.

8.3.4 Start Up and Power Down

The boost converter of the TPS61098x is designed always-on, so there is no enable or disable control of it. The boost converter starts operation once input voltage is applied. If the input voltage is not high enough, a low voltage startup oscillator operates the switches first. During this phase, the switching frequency is controlled by the oscillator, and the maximum switch current is limited. Once the converter has built up the output voltage $V_{(\text{MAIN})}$ to approximately 1.8 V, the device switches to the normal hysteretic current mode operation and the VMAIN rail starts to supply the internal control circuit. If the input voltage is too low or the load during startup is too heavy, which makes the converter unable to build up 1.8 V at $V_{(\text{MAIN})}$ rail, the boost converter can't start up successfully. It will keep in this status until the input voltage is increased or removed.

The TPS61098x is able to startup with 0.7 V input voltage with ≥ 3 k Ω load. The startup time depends on input voltage and load conditions. After the $V_{(MAIN)}$ reaches 1.8 V to start the normal hysteretic current mode operation, an internal ramp-up reference controls soft-start time of the boost converter until $V_{(MAIN)}$ reaches its set value.

The TPS61098x does not support undervoltage lockout function. When the input voltage drops to a low voltage and can't provide the required energy to the boost converter, the $V_{(MAIN)}$ drops. When and to what extent $V_{(MAIN)}$ drops are dependent on the input and load conditions. When the boost converter is unable to maintain 1.8 V at VMAIN rail to supply the internal circuit, the TPS61098x powers down and enters into startup process again.

8.3.5 Over Load Protection

The boost converter of the TPS61098x supports a cycle-by-cycle current limit function in boost mode operation. If the peak inductor current reaches the internal switch current limit threshold, the main switch is turned off to stop a further increase of the input current. In this case the output voltage will decrease since the device cannot provide sufficient power to maintain the set output voltage. If the output voltage drops below the input voltage, the backgate diode of the rectifying switch gets forward biased and current starts to flow through it. Because this diode cannot be turned off, the load current is only limited by the remaining DC resistance. After the overload condition is removed, the converter automatically resumes normal operation.

The overload protection is not active in pass-through mode operation, in which the load current is only limited by the DC resistance.

The integrated LDO / load switch also supports over load protection. When the load current of VSUB rail reaches the I_{LIM_SUB} , the $V_{(SUB)}$ output current will be regulated at this limit value and will not increase further. In this case the $V_{(SUB)}$ voltage will decrease since the device cannot provide sufficient power to the load.

8.3.6 Thermal Shutdown

The TPS61098x has a built-in temperature sensor which monitors the internal junction temperature in boost mode operation. If the junction temperature exceeds the threshold (150°C typical), the device stops operating. As soon as the junction temperature has decreased below the programmed threshold with a hysteresis, it starts operating again. There is a built-in hysteresis (25°C typical) to avoid unstable operation at the overtemperature threshold. The over temperature protection is not active in pass-through mode operation.

8.4 Device Functional Modes

8.4.1 Operation Modes by MODE Pin

The TPS61098x features two operation modes controlled by MODE pin: the Active mode and Low Power mode. It can provide quick transient response in Active mode and ultra-low quiescent current in Low Power mode. So a low power system can easily use the TPS61098x to get high performance in its active mode and meantime minimize its power consumption to extend the battery run time in its sleep mode.

The MODE pin is usually controlled by an I/O pin of a controller, and should not be left floating.

8.4.1.1 Active Mode

The TPS61098x works in Active mode when MODE pin is logic high. In Active mode, both of the boost converter and the integrated LDO/load switch are enabled, and the TPS61098x can provide dual outputs simultaneously. The transient response performance of the boost converter is enhanced in Active mode, and the device consumes around 15 μ A quiescent current. It is able to respond load transient quickly.

When MODE pin is toggled from low to high, soft-start is implemented for the LDO versions to avoid inrush current during startup. For load switch versions, the load switch is turned on faster, so the output capacitor at VSUB pin is suggested 10X smaller than the output capacitor at VMAIN pin to avoid obvious voltage drop of $V_{(MAIN)}$ during turning on process.

8.4.1.2 Low Power Mode

The TPS61098x works in Low Power mode when MODE pin is logic low. In Low Power mode, the LDO/load switch is turned off, so the peripherals can be disconnected to minimize the battery drain. The VSUB pin either outputs high impedance or is pulled to ground by internal active discharge circuit, depending on different

versions. The boost converter consumes only 300 nA quiescent current typically, and can achieve up to 88% efficiency at 10 μ A load.

The Low Power mode is designed to keep the load device powered with minimum power consumption. For example, it can be used to keep powering the main system, like an MCU, in a system's sleep mode even under < 0.7 V input voltage condition.

图 8-3 和 图 8-4 illustrate the outputs of the TPS61098 and TPS610981 under different input voltages in Active mode and Low Power mode.



图 8-3. TPS61098 Output under Different Input Voltages



图 8-4. TPS610981 Output under Different Input Voltages

The TPS610982 is an exception. Its LDO is always on in both Active mode and Low Power mode with higher quiescent current consumption than other versions. The TPS610982 can be used to replace discrete boost and LDO solutions where the LDO output is always on, and its two modes provide users two options of different quiescent current consumption and performance. Refer to 节 8.4.1, 节 7 和 节 7.6 for details.

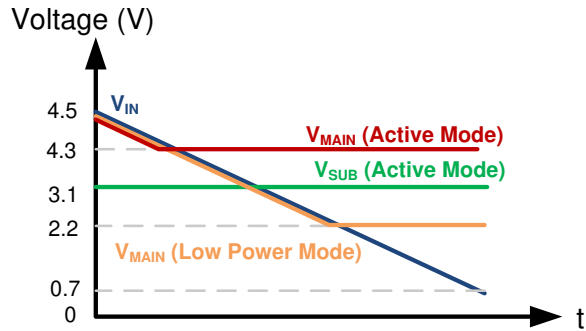
8.4.2 Burst Mode Operation under Light Load Condition

The boost converter of TPS61098x enters into Burst Mode operation under light load condition. Refer to 节 8.3.1 for details.

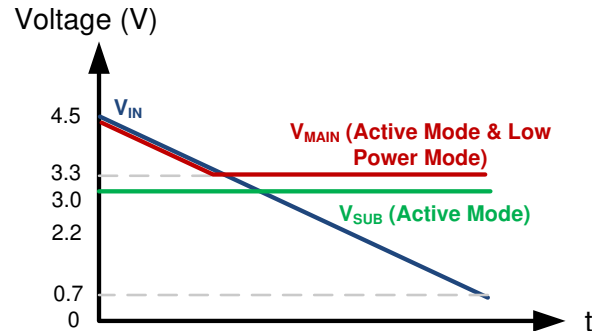
8.4.3 Pass-Through Mode Operation

The boost converter of TPS61098x automatically enters into pass-through mode operation when input voltage is higher than the target output voltage. Refer to 节 8.3.2 for details.

9 Applications and Implementation

Note

以下应用部分的信息不属于 TI 组件规范，TI 不担保其准确性和完整性。客户应负责确定 TI 组件是否适用于其应用。客户应验证并测试其设计，以确保系统功能。

9.1 Application Information

The TPS61098x is an ultra low power solution for products powered by either a one-cell or two-cell alkaline, NiCd or NiMH, one-cell coin cell or one-cell Li-Ion or Li-polymer battery. It integrates either a Low-dropout Linear Regulator (LDO) or a load switch with a boost converter and provides dual output rails. The $V_{(MAIN)}$ rail is the output of the boost converter. It is an always-on output and can only be turned off by removing input voltage. The $V_{(SUB)}$ rail is the output of the integrated LDO or load switch, and it can be turned off by pulling the MODE pin low.

9.2 Typical Applications

9.2.1 VMAIN to Power MCU and VSUB to Power Subsystem

The TPS61098x suits for low power systems very well, especially for the system which spends the most of time in sleep mode and wakes up periodically to sense or transmit signals. For this kind of application, the boost output $V_{(MAIN)}$ can be used as an always-on supply for the main system, such as an MCU controller, and the LDO or load switch output $V_{(SUB)}$ is used to power peripheral devices or subsystem.

As shown in 图 9-1, the MCU can control both of the subsystem and the TPS61098x. When the system goes into sleep mode, the MCU can disable the subsystem first, and then force the TPS61098x enter into Low Power mode, where the $V_{(SUB)}$ rail is disconnected but the $V_{(MAIN)}$ rail still powers the MCU with only 300 nA quiescent current. When the system wakes up, the MCU pulls the MODE pin of TPS61098x high first to turn on the $V_{(SUB)}$ rail, and then enables the subsystem. In this way, the system can benefit both of the enhanced transient response performance in active mode and the ultra-low quiescent current in sleep mode.

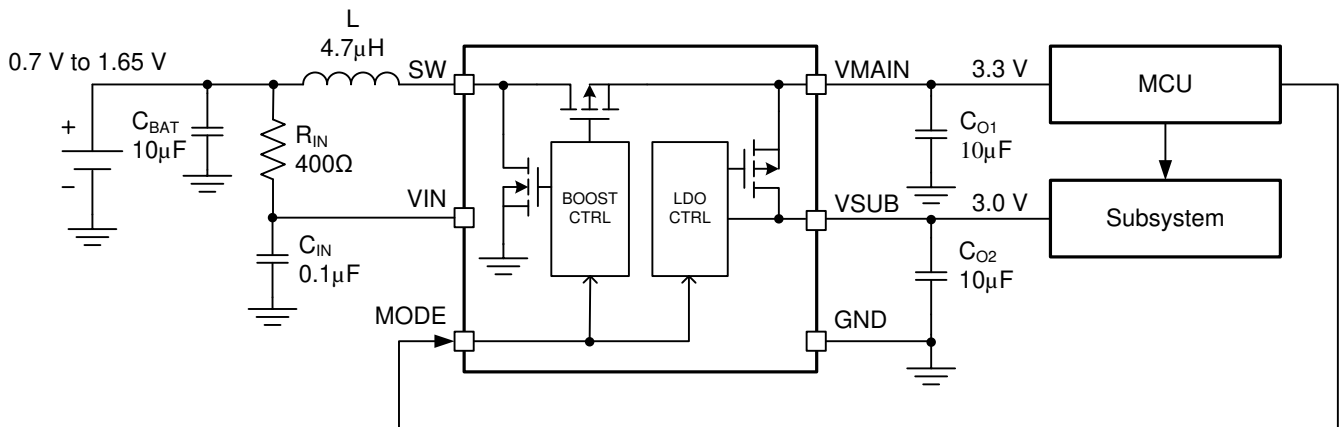

Copyright © 2016, Texas Instruments Incorporated

图 9-1. Typical Application of TPS610981 to Power Low Power System

9.2.1.1 Design Requirements

- 3.3 V $V_{(MAIN)}$ rail to power MCU with 15 mA load current, 3 V $V_{(SUB)}$ rail to power subsystem with 10 mA load current
- Power source, single-cell alkaline battery (0.7 V to 1.65 V range)
- Greater than 90% conversion efficiency

9.2.1.2 Detailed Design Procedure

9.2.1.2.1 Device Choice

In the TPS61098x family, different versions are provided. Refer to 节 5 for version details and select the right version for target applications. It is OK to use only one output rail, either $V_{(MAIN)}$ or $V_{(BUS)}$, as long as it suits the application.

In this example, dual rails of 3.3 V and 3 V are required to power both MCU and subsystem, so the TPS610981 is selected.

9.2.1.2.2 Maximum Output Current

For the boost converter, it provides output current for both $V_{(MAIN)}$ and $V_{(SUB)}$ rails. Its maximum output capability is determined by the input to output ratio and the current limit of the boost converter and can be estimated by 方程式 3.

$$I_{OUT(max)} = \frac{V_{IN} \times (I_{LIM_BST} - 50mA) \times \eta}{V_{MAIN}} \quad (3)$$

where

- η is the boost converter power efficiency estimation
- 50 mA is half of the inductor current ripple value

Minimum input voltage, maximum boost output voltage and minimum current limit I_{LIM_BST} should be used as the worst case condition for the estimation.

Internal current limit is also implemented for the integrated LDO/load switch. So the maximum output current of VSUB rail should be lower than I_{LIM_SUB} , which has 200 mA minimum value. For LDO version, the maximum output current is also limited by its input to output headroom, that is $V_{(MAIN)} - V_{(SUB)}$. Make sure the headroom voltage is enough to support the load current. Please refer to 节 7.5 for the dropout voltage information.

In this example, assume the power efficiency is 80% (lower than typical value for the worst case estimation), so the calculated maximum output current of the boost converter is 50.9 mA, which satisfies the application requirements (15 mA + 10 mA). The load of VSUB rail is 10 mA, which is well below the $V_{(SUB)}$ rail current limit and the dropout voltage is also within the headroom.

9.2.1.2.3 Inductor Selection

Because the selection of the inductor affects steady state operation, transient behavior, and loop stability, the inductor is the most important component in power regulator design. There are three important inductor specifications, inductor value, saturation current, and dc resistance (DCR).

The TPS61098x is designed to work with inductor values between 2.2 μ H and 4.7 μ H. The inductance values affects the switching frequency f in continuous current operation, which is proportional to 1/L as shown in 方程式 4.

$$f = \frac{1}{L \times 100mA} \times \frac{V_{IN} \times (V_{MAIN} - V_{IN} \times \eta)}{V_{MAIN}} \quad (4)$$

The inductor current ripple is fixed to 100mA typical value by internal design, but it can be affected by the inductor value indirectly. Normally when a smaller inductor value is applied, the inductor current ramps up and down more quickly, so the current ripple becomes bigger because the internal current comparator has some delay to respond. So if smaller inductor peak current is required in applications, a higher inductor value can be tried. However, the TPS61098x is optimized to work within a range of L and C combinations. The LC output filter inductance and capacitance must be considered together. The output capacitor sets the corner frequency of the converter while the inductor creates a Right-Half-Plane-Zero degrading the stability of the converter. Consequently with a larger inductor, a bigger capacitor normally should be used to ensure the same L/C ratio thus a stable loop.

Having selected an inductance value, the peak current for the inductor in steady-state operation varies as a function of the load, the input and output voltages and can be estimated using [方程式 5](#).

$$I_{L,MAX} = \frac{V_{MAIN} \times (I_{MAIN} + I_{SUB})}{V_{IN} \times \eta} + 50\text{mA}; \text{ continuous current operation}$$

$$I_{L,MAX} = 100\text{mA}; \text{ discontinuous current operation} \quad (5)$$

where, 80% can be used for the boost converter power efficiency estimation, 100 mA is the typical inductor current ripple value and 50mA is half of the ripple value, which may be affected a little bit by inductor value. [方程式 5](#) provides a suitable inductor current rating by using minimum input voltage, maximum boost output voltage and maximum load current for the calculation. Load transients and error conditions may cause higher inductor currents.

[方程式 6](#) provides an easy way to estimate whether the device will work in continuous or discontinuous operation depending on the operating points. As long as the [方程式 6](#) is true, continuous operation is typically established. If [方程式 6](#) becomes false, discontinuous operation is typically established.

$$\frac{V_{MAIN} \times (I_{MAIN} + I_{SUB})}{V_{IN} \times \eta} > 50\text{mA} \quad (6)$$

Selecting an inductor with insufficient saturation performance can lead to excessive peak current in the converter. This could eventually harm the device and reduce its reliability.

In this example, the maximum load for the boost converter is 25 mA, and the minimum input voltage is 0.7 V, and the efficiency under this condition can be estimated at 80%, so the boost converter works in continuous operation by the calculation. The inductor peak current is calculated as 197 mA. To leave some margin, a 4.7 μH inductor with at least 250 mA saturation current is recommended for this application.

[表 9-1](#) also lists the recommended inductor for the TPS61098x device.

表 9-1. List of Inductors

INDUCTANCE [μH]	ISAT [A]	IRMS [A]	DC RESISTANCE [mΩ]	PART NUMBER	MANUFACTURER
4.7	0.86	1.08	168	VLF302510MT-4R7M	TDK
4.7	0.57	0.95	300	VLF252010MT-4R7M	TDK
2.2	1.23	1.5	84	VLF302510MT-2R2M	TDK
2.2	0.83	0.92	120	VLF252010MT-2R2M	TDK

9.2.1.2.4 Capacitor Selection

For best output and input voltage filtering, low ESR X5R or X7R ceramic capacitors are recommended.

The input capacitor minimizes input voltage ripple, suppresses input voltage spikes and provides a stable system rail for the device. An input capacitor value of at least 10 μF is recommended to improve transient behavior of the regulator and EMI behavior of the total power supply circuit. A ceramic capacitor placed as close as possible to the VIN and GND pins of the IC is recommended. For applications where line transient is expected, an input filter composed of 400-Ω resistor and 0.1-μF capacitor as shown in [图 9-1](#) is mandatory to avoid interference to internal pass-through threshold comparison circuitry.

For the output capacitor of VMAIN pin, small ceramic capacitors are recommended, placed as close as possible to the VMAIN and GND pins of the IC. If, for any reason, the application requires the use of large capacitors which cannot be placed close to the IC, the use of a small ceramic capacitor with a capacitance value of around 2.2 μF in parallel to the large one is recommended. This small capacitor should be placed as close as possible to the VMAIN and GND pins of the IC. The recommended typical output capacitor values are 10 μF and 22 μF (nominal values).

For LDO version, like all low dropout regulators, VSUB rail requires an output capacitor connected between VSUB and GND pins to stabilize the internal control loop. Ceramic capacitor of 10 μF (nominal value) is recommended for most applications. If the $V_{(SUB)}$ drop during load transient is much cared, higher capacitance value up to 22 μF is recommended to provide better load transient performance. Capacitor below 10 μF is only recommended for light load operation. For load switch version, capacitor of 10x smaller value than capacitor at VMAIN pin is recommended to minimize the voltage drop caused by charge sharing when the load switch is turned on.

When selecting capacitors, ceramic capacitor's derating effect under bias should be considered. Choose the right nominal capacitance by checking capacitor's DC bias characteristics. In this example, GRM188R60J106ME84D, which is a 10 μF ceramic capacitor with high effective capacitance value at DC biased condition, is selected for both VMAIN and VSUB rails. The load transient response performance is shown in [节 9.2.1.3](#).

For load switch version, VSUB rails requires an output capacitor connected between VSUB and GND pins. Ceramic capacitor of 1 μF (nominal value) is recommended for most applications.

9.2.1.2.5 Control Sequence

In this example, the MCU is powered by the boost output $V_{(MAIN)}$ and the subsystem is powered by the LDO $V_{(SUB)}$. MCU controls both of the TPS610981 and subsystem. The control sequence as shown in [图 9-2](#) is recommended.



图 9-2. System Control Sequence

When the system is waking up, the MCU wakes up itself first, and it then pulls the MODE pin of TPS610981 to high to turn on the $V_{(SUB)}$ rail. TPS610981 enters into Active mode and gets ready to provide power to the subsystem. Then the MCU enables the subsystem.

When the system is entering into sleep mode, the MCU disables the subsystem first and then pulls the MODE pin to low to turn off the $V_{(SUB)}$, so the subsystem is disconnected from the supply to minimize the current drain. TPS610981 enters into Low Power mode and the VMAIN rail still powers the MCU with only 300 nA quiescent current. The MCU enters into sleep mode itself finally.

9.2.1.3 Application Curves

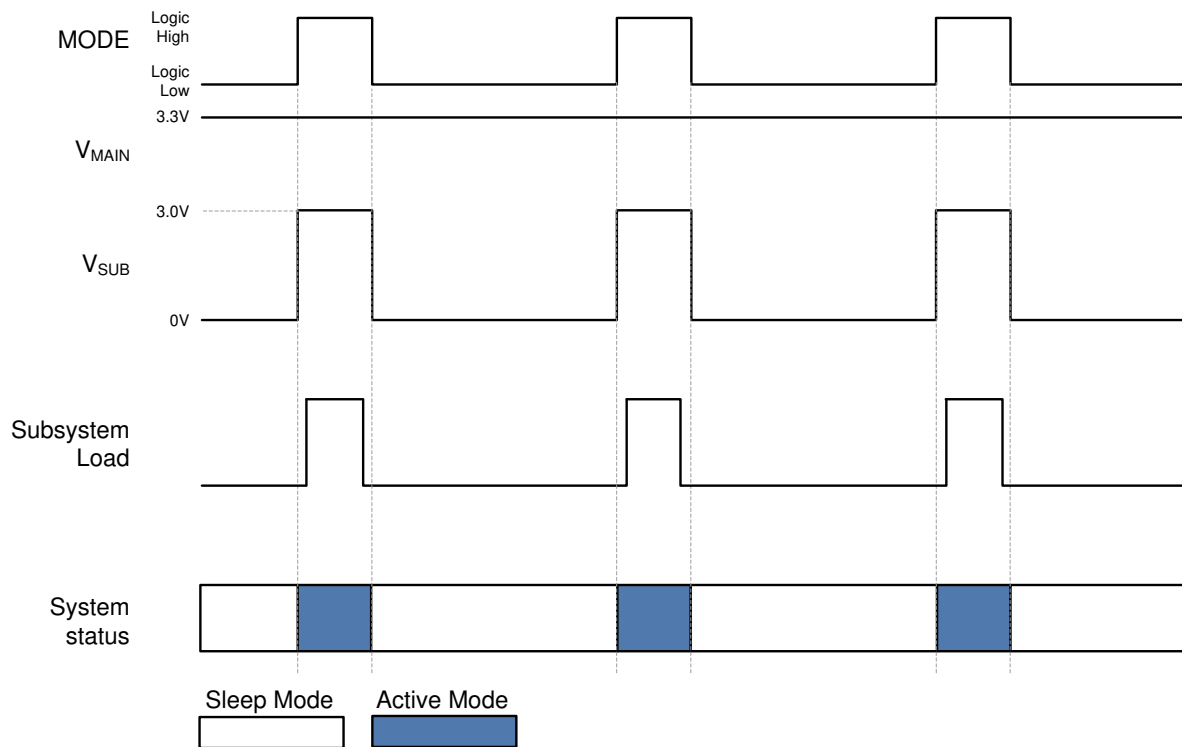
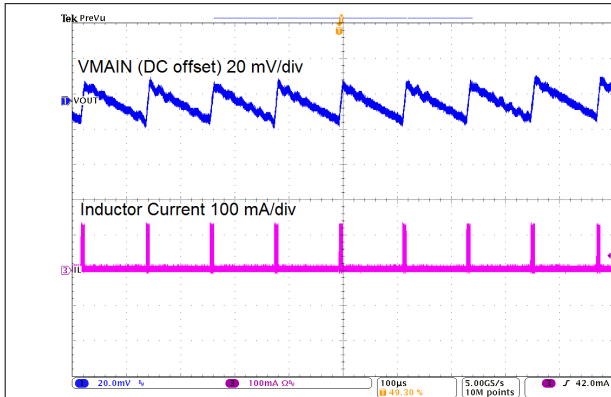

TPS610981 $I_{(MAIN)} = 1 \text{ mA}$ $I_{(SUB)} = 0 \text{ mA}$
 MODE = L $V_{IN} = 1.5 \text{ V}$

图 9-3. Switching Waveforms

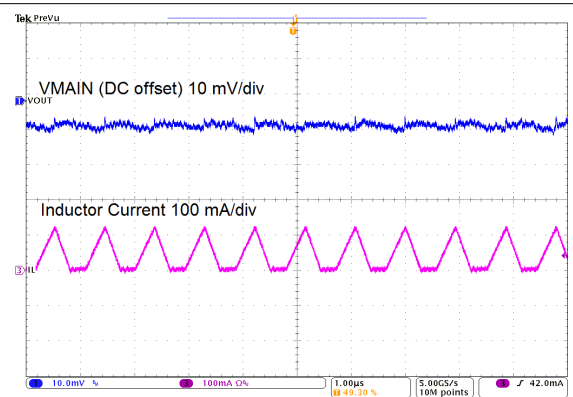

TPS610981 $I_{(MAIN)} = 10 \text{ mA}$ $I_{(SUB)} = 0 \text{ mA}$
 MODE = L $V_{IN} = 1.5 \text{ V}$

图 9-4. Switching Waveforms

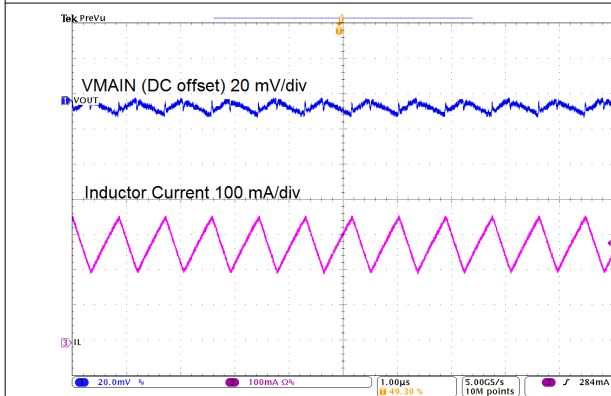

TPS610981 $I_{(MAIN)} = 100 \text{ mA}$ $I_{(SUB)} = 0 \text{ mA}$
 MODE = L $V_{IN} = 1.5 \text{ V}$

图 9-5. Switching Waveforms

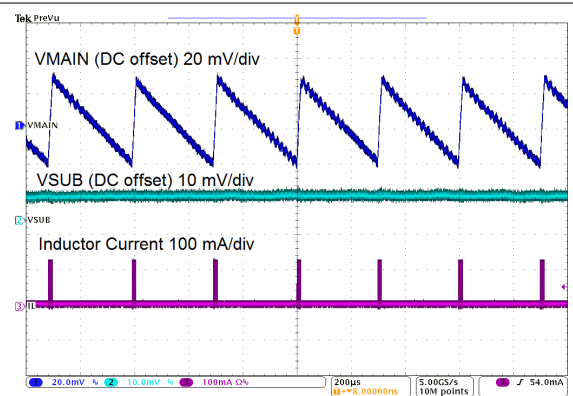

TPS610981 $I_{(MAIN)} = 0 \text{ mA}$ $I_{(SUB)} = 1 \text{ mA}$
 MODE = H $V_{IN} = 1.5 \text{ V}$

图 9-6. Switching Waveforms

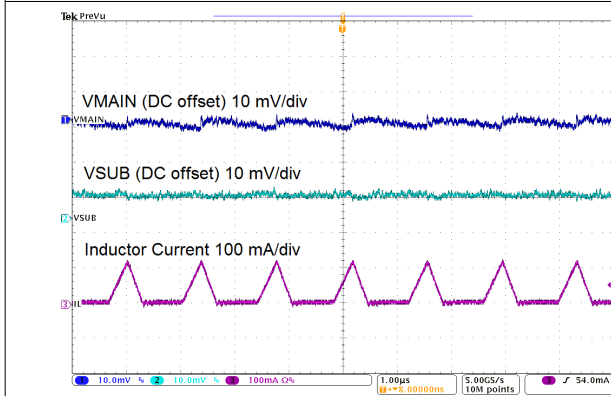

TPS610981 $I_{(MAIN)} = 0 \text{ mA}$ $I_{(SUB)} = 10 \text{ mA}$
 MODE = H $V_{IN} = 1.5 \text{ V}$

图 9-7. Switching Waveforms

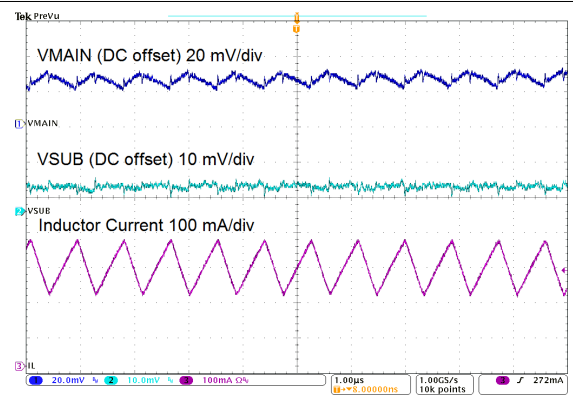

TPS610981 $I_{(MAIN)} = 0 \text{ mA}$ $I_{(SUB)} = 100 \text{ mA}$
 MODE = H $V_{IN} = 1.5 \text{ V}$

图 9-8. Switching Waveforms

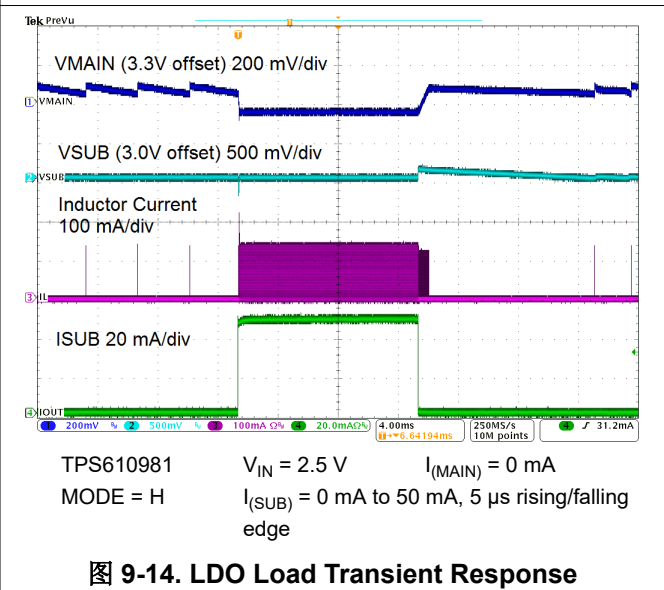
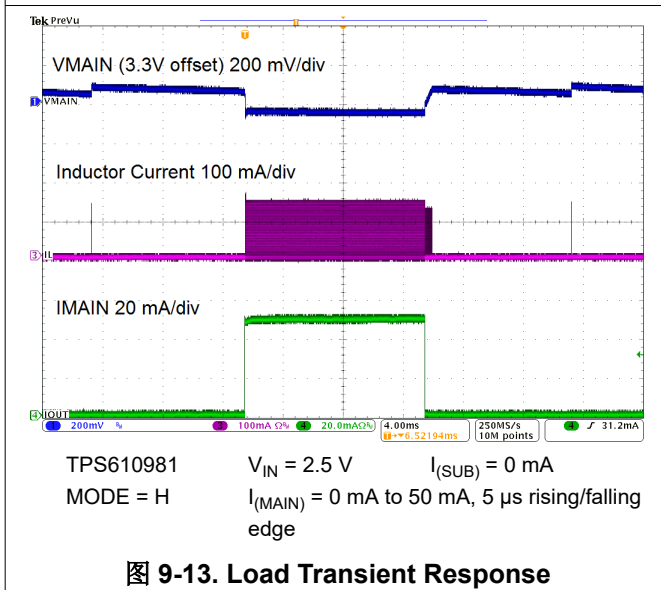
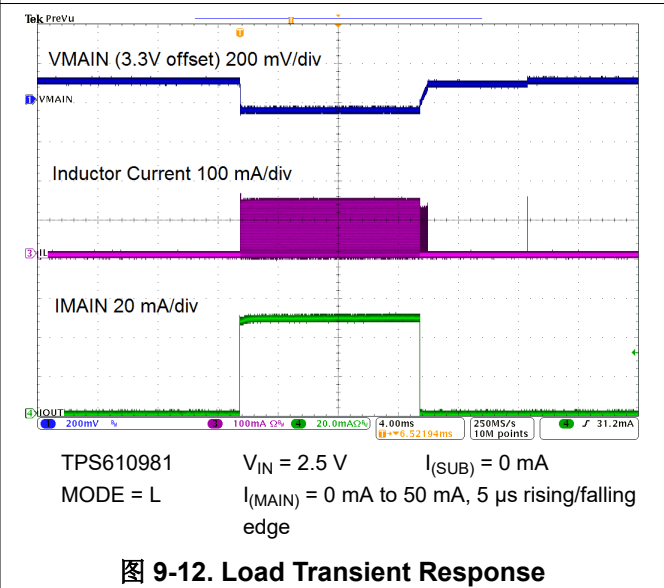
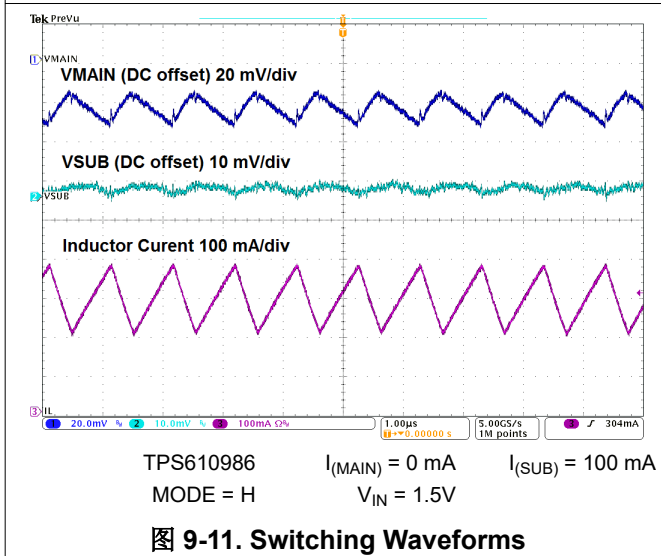
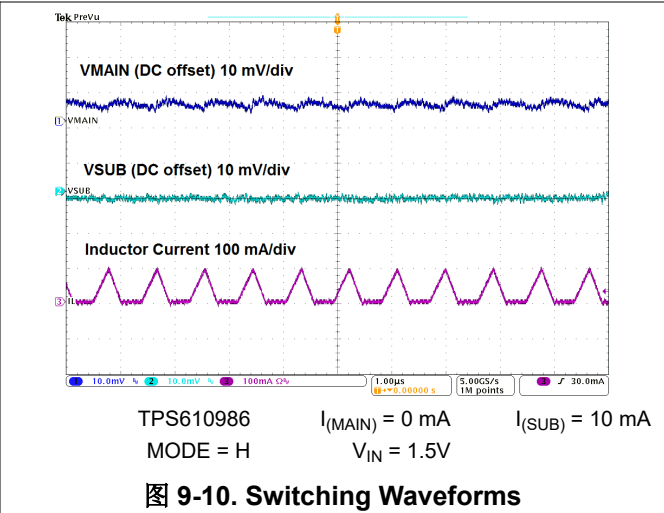
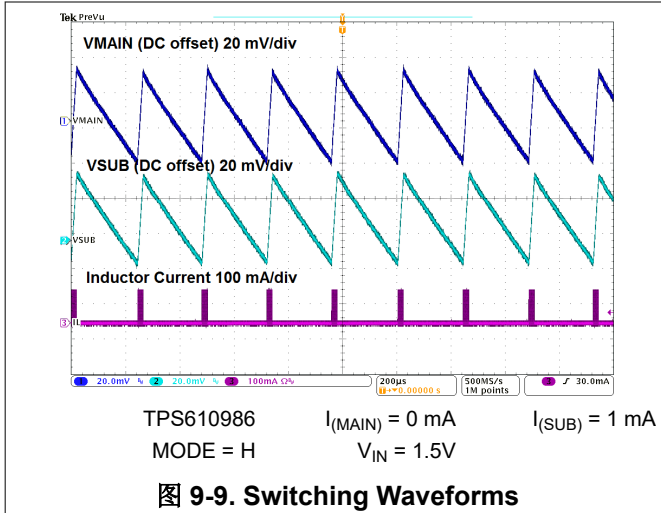



图 9-15. Line Transient Response



图 9-16. Line Transient Response

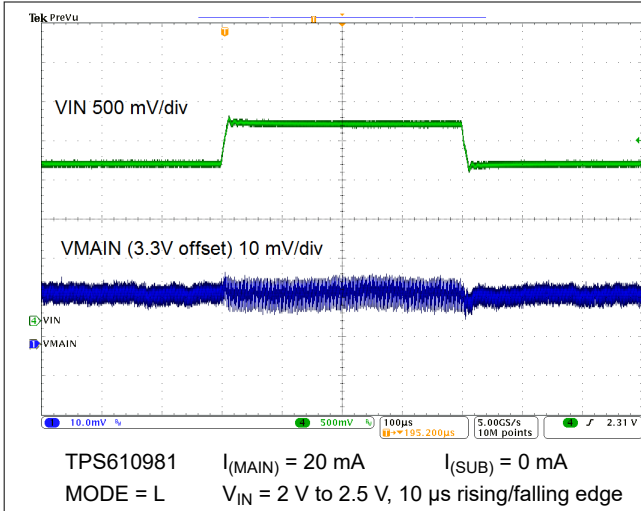

图 9-17. Line Transient Response

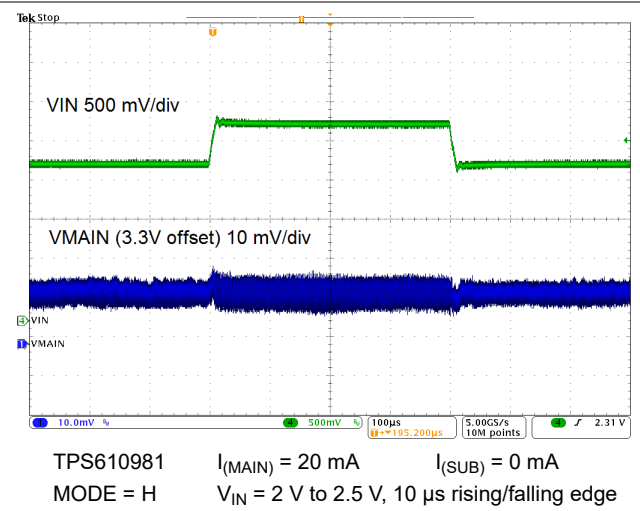

图 9-18. Load Regulation

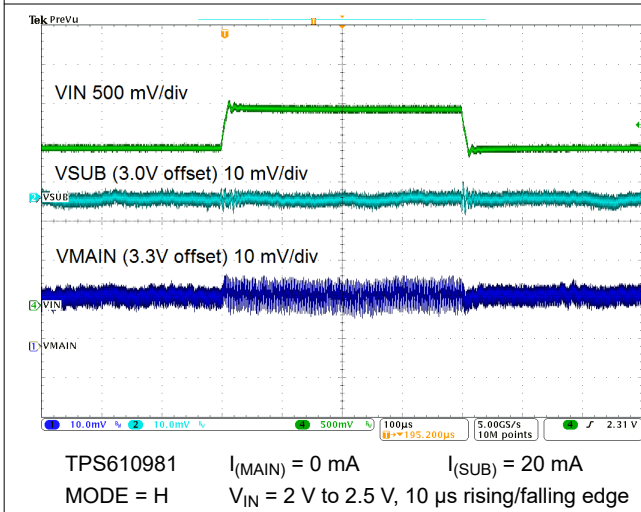

图 9-19. Load Regulation

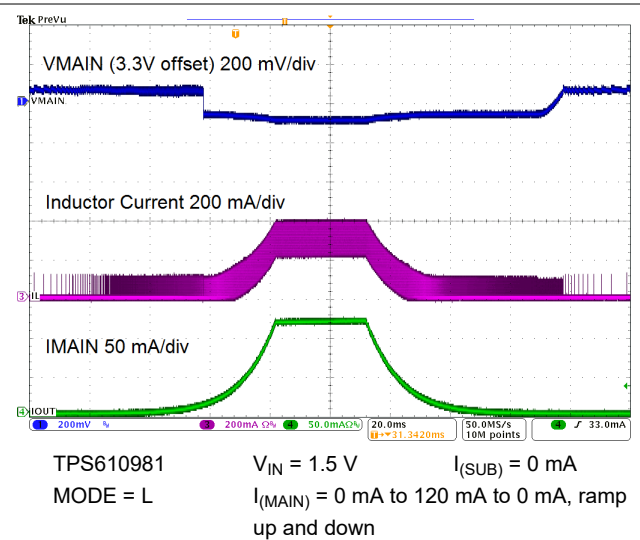

图 9-20. Line Regulation

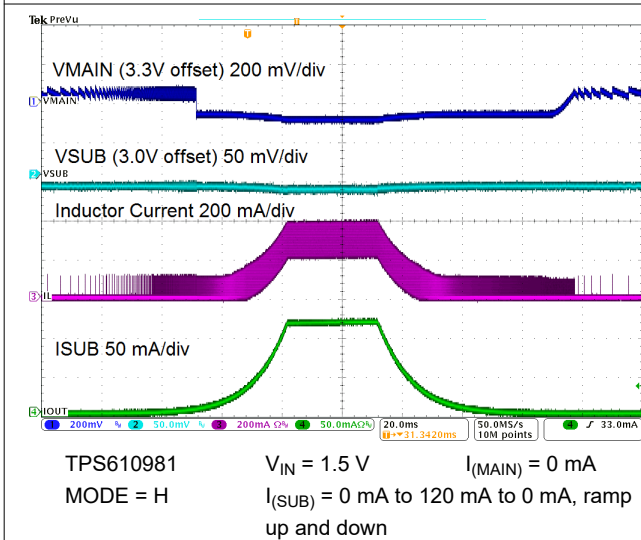

图 9-21. Mode Toggling

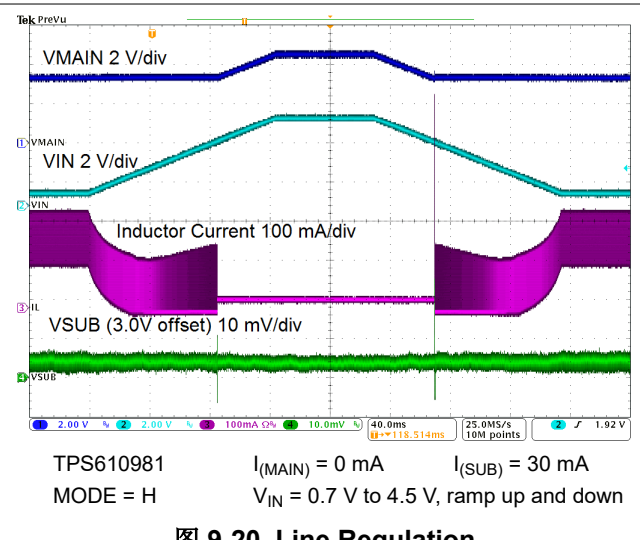

图 9-22. Startup

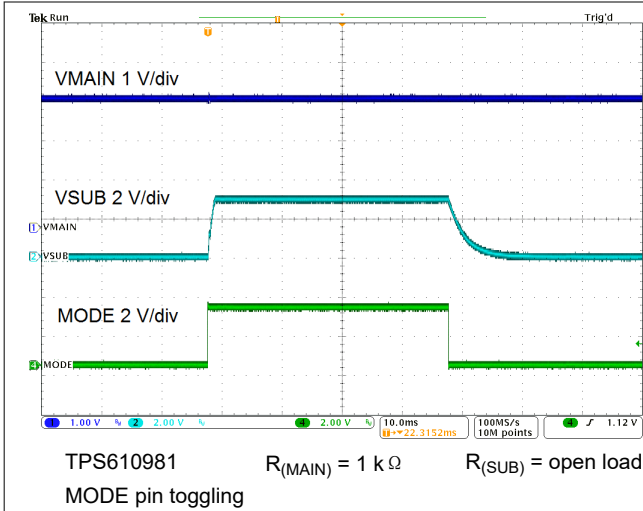

图 9-23. Startup

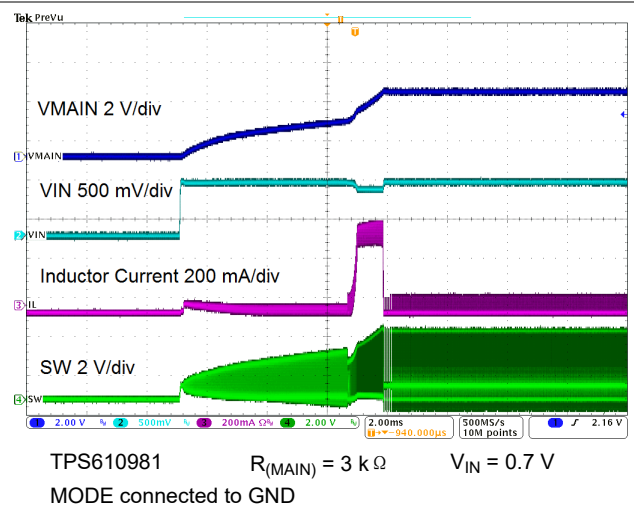

图 9-24. Startup

9.2.2 VMAIN to Power the System in Low Power Mode

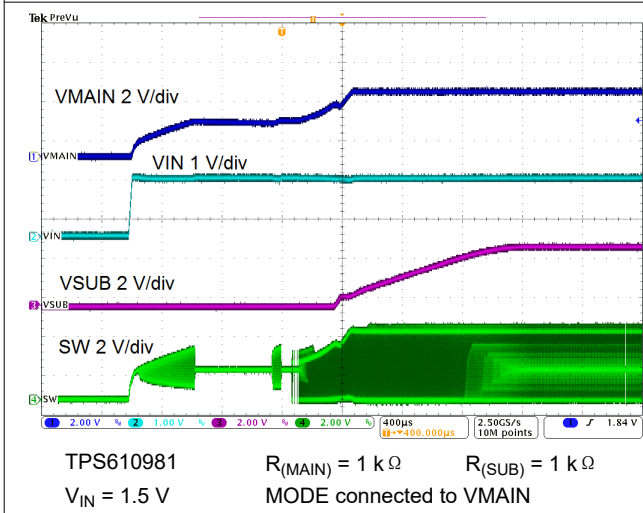
If only one power supply is needed for the whole system, users can easily leave the VSUB pin float and only use the VMAIN rail as the power supply. In this case, the TPS61098x functions as a standard boost converter. If enhanced load transient performance is needed when the system works in Active mode, the controller can control the MODE pin to switch the TPS61098x between the Active mode and Low Power mode. If the ultra-low I_q is critical for the application, users can connect the MODE pin to GND so the TPS61098x keeps working in Low Power mode with only 300 nA quiescent current. Below shows a typical application where the TPS61098 is used in Low Power mode to generate 2.2 V with only 300 nA I_q to power the whole system.

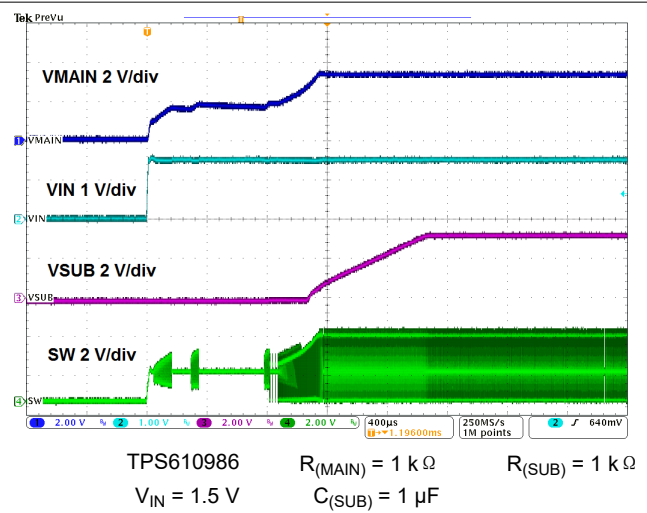
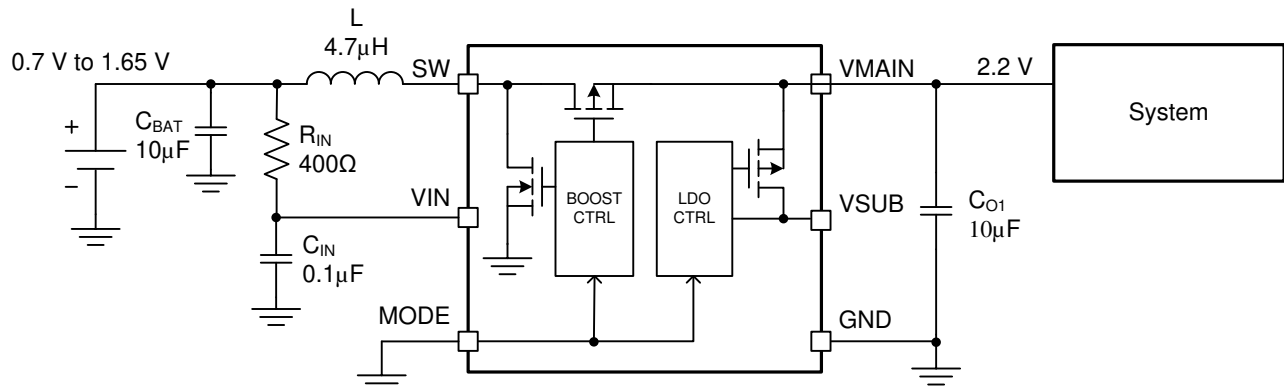

Copyright © 2016, Texas Instruments Incorporated

图 9-25. Typical Application of TPS61098 VMAIN to Power the System in Low Power Mode

9.2.2.1 Design Requirements

- 2.2 V $V_{(MAIN)}$ to power the whole system
- Power source, single-cell alkaline battery (0.7 V to 1.65 V range)
- $\geq 80\%$ conversion efficiency at 10 μ A load

9.2.2.2 Detailed Design Procedure

Refer to [节 9.2.1.2](#) for the detailed design steps.

9.2.2.3 Application Curves



图 9-26. Load Transient Response



图 9-27. Line Transient Response

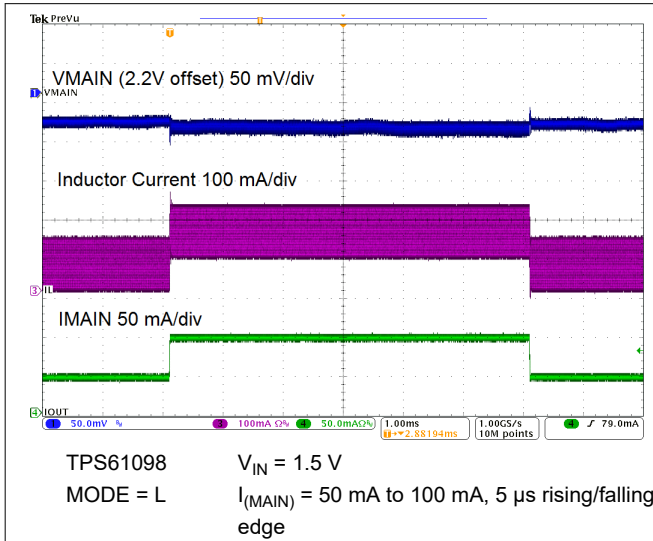

图 9-28. Startup

9.2.3 VSUB to Power the System in Active Mode

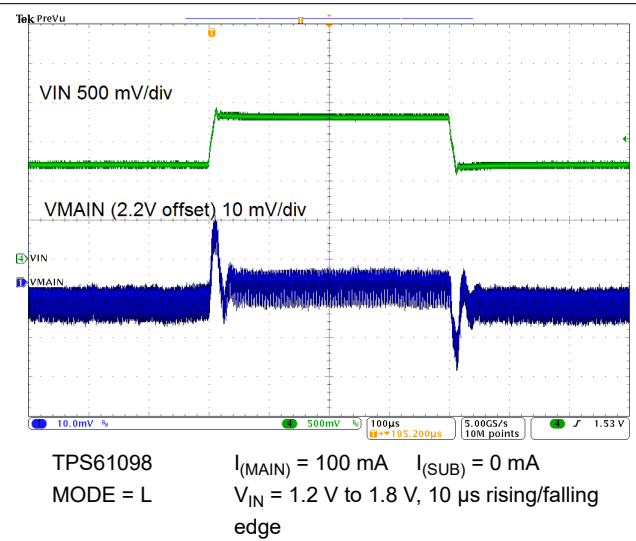
In some applications, the system controller can be powered by the battery directly, but a buck-boost or a boost converter with an LDO is needed to provide a quiet power supply for a subsystem like a sensor. In this type of application, the TPS61098x can be used to replace the discrete boost converter and the LDO, providing a compact solution to simplify the system design and save the PCB space. The LDO can be turned on and off by the MODE pin. When the MODE pin is pulled low, the LDO is turned off to disconnect the load, and the TPS61098x also enters into Low Power mode to save power consumption. 图 9-29 shows an application where the VSUB of the TPS61098 is used to supply the 3.1 V for a sensor in a system. The boost converter of the TPS61098 outputs 4.3 V and provides enough headroom for the LDO operation.

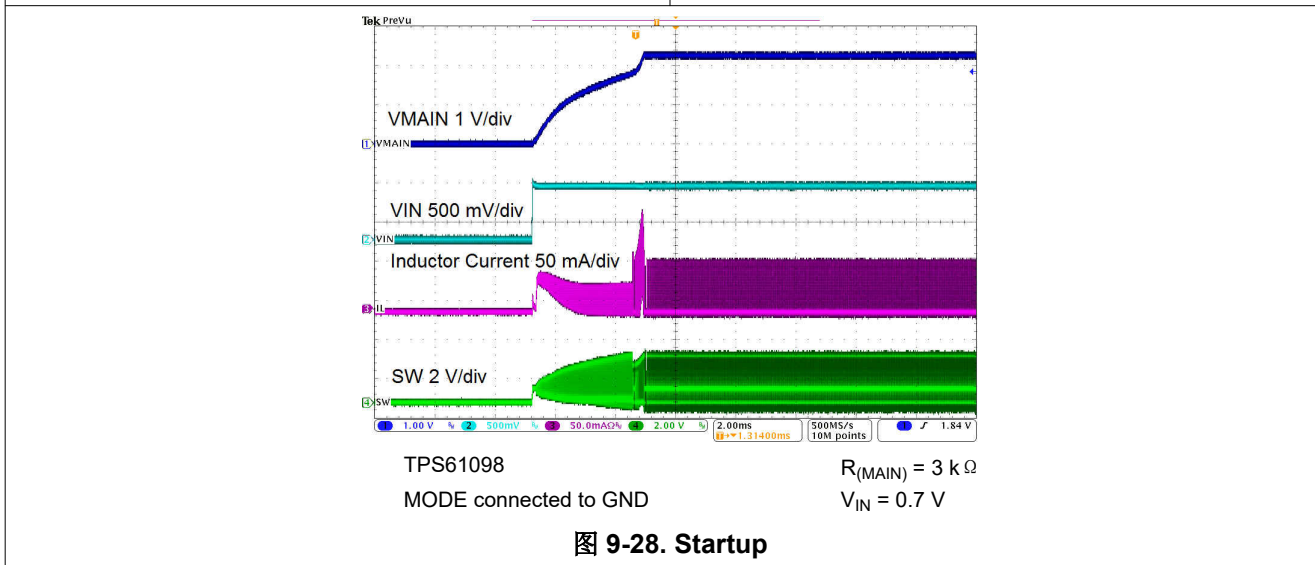
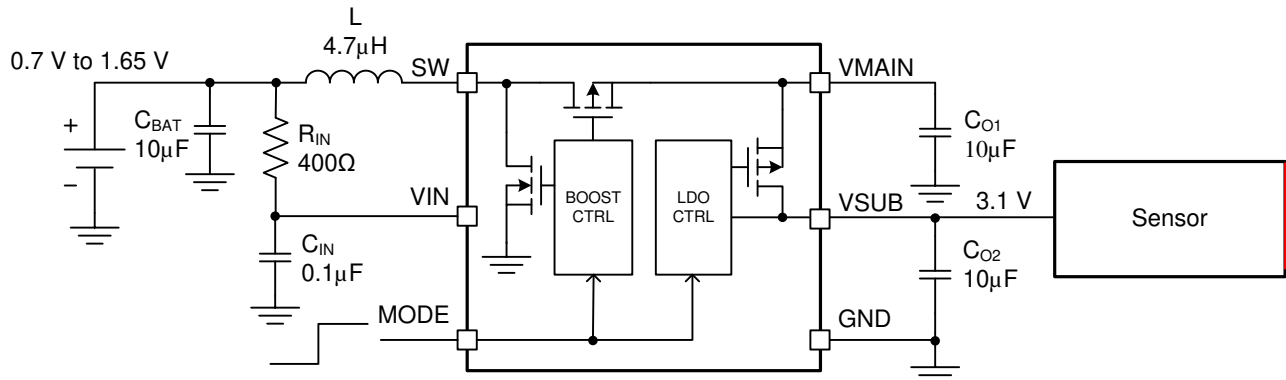

Copyright © 2016, Texas Instruments Incorporated

图 9-29. Typical Application of TPS61098 VSUB to Power the System in Active Mode

9.2.3.1 Design Requirements

- 3.1 V rail to power a sensor
- Power source, single-cell li-ion battery (2.7 V to 4.3 V range)

9.2.3.2 Detailed Design Procedure

Refer to 节 9.2.1.2 for the detailed design steps.

9.2.3.3 Application Curves



图 9-30. LDO Load Transient Response



图 9-31. Line Transient Response

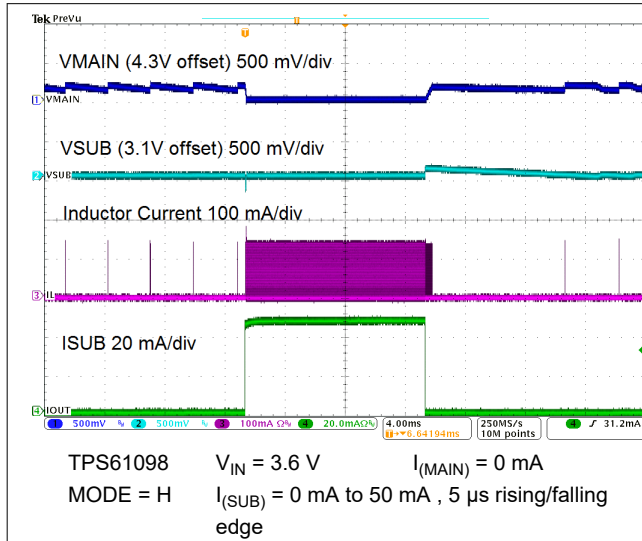

图 9-32. Line Transient Response

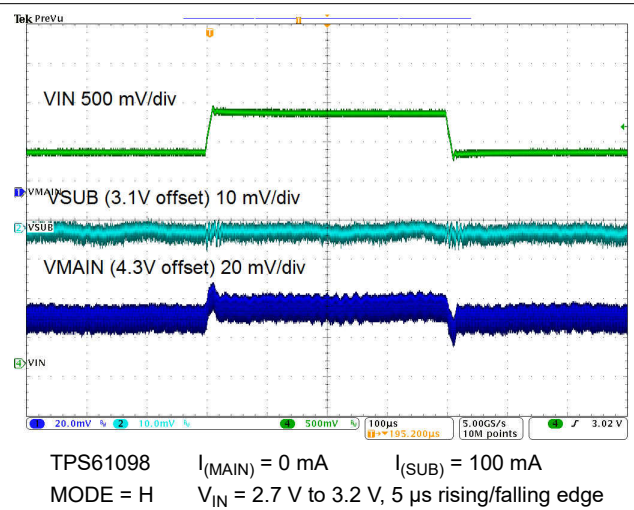

图 9-33. Line Transient Response

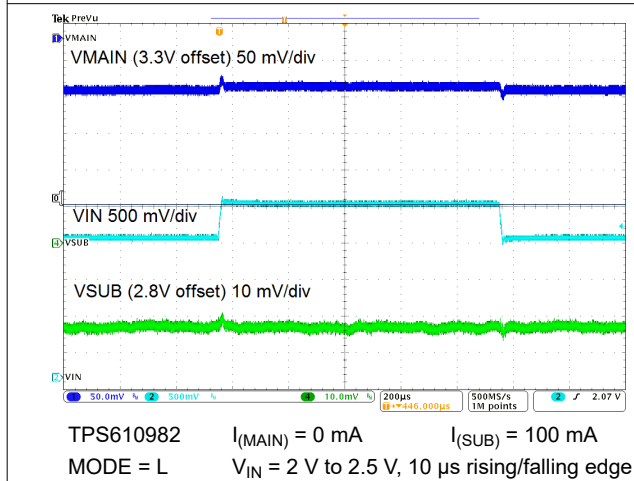

图 9-34. LDO Load Transient Response

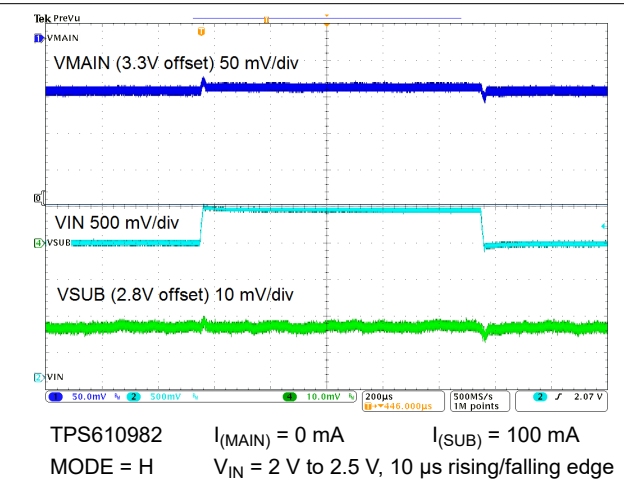

图 9-35. LDO Load Transient Response

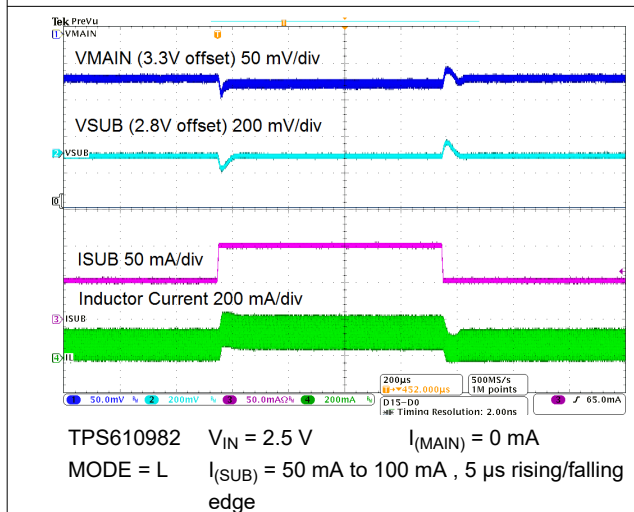

图 9-36. MODE Toggling

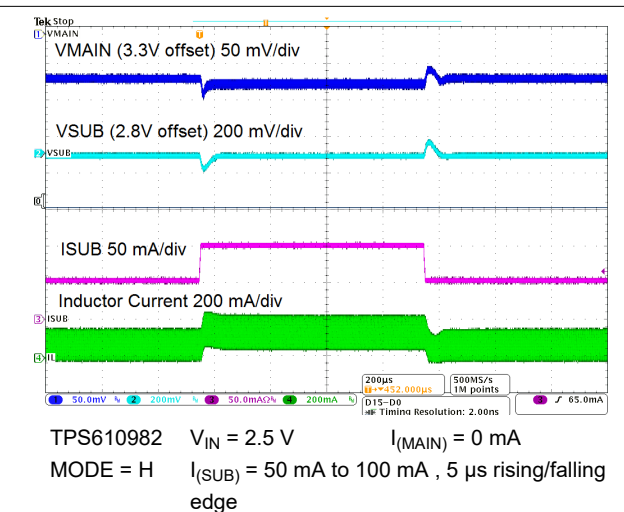

图 9-37. Startup

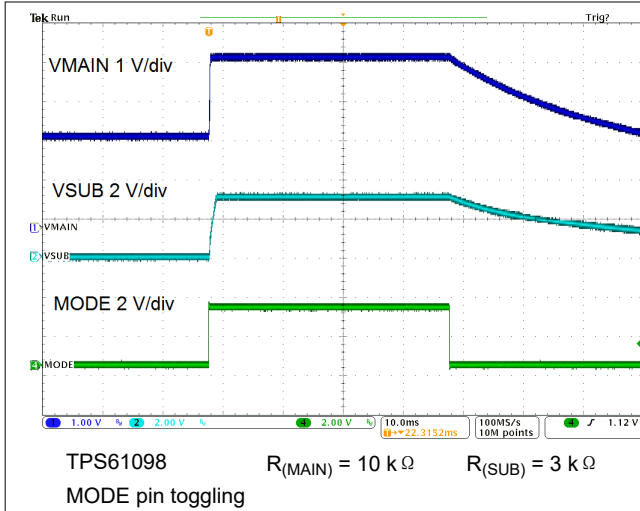

图 9-38. Startup

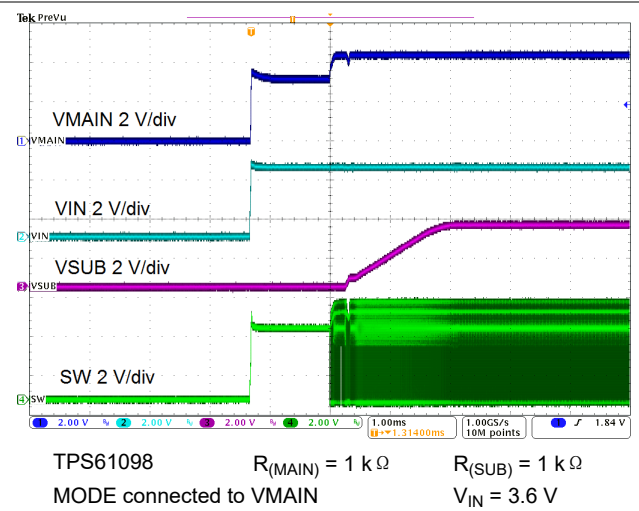

图 9-39. Startup

10 Power Supply Recommendations

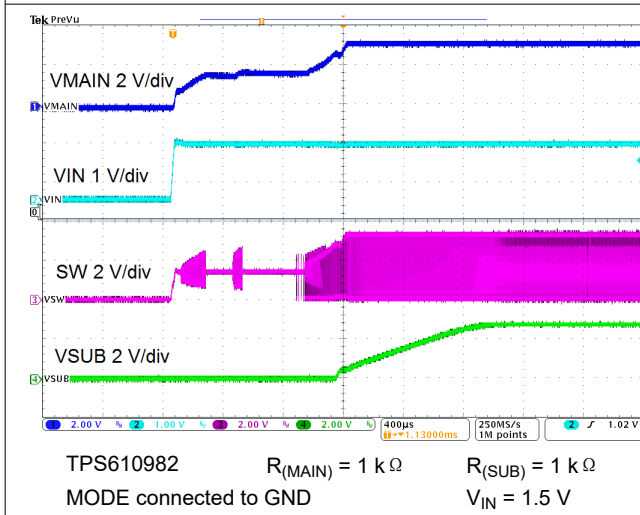
The TPS61098x family is designed to operate from an input voltage supply range between 0.7 V to 4.5 V. The power supply can be either a one-cell or two-cell alkaline, NiCd or NiMH, one-cell coin cell or one-cell Li-Ion or Li-polymer battery. The input supply should be well regulated with the rating of TPS61098x.

11 Layout

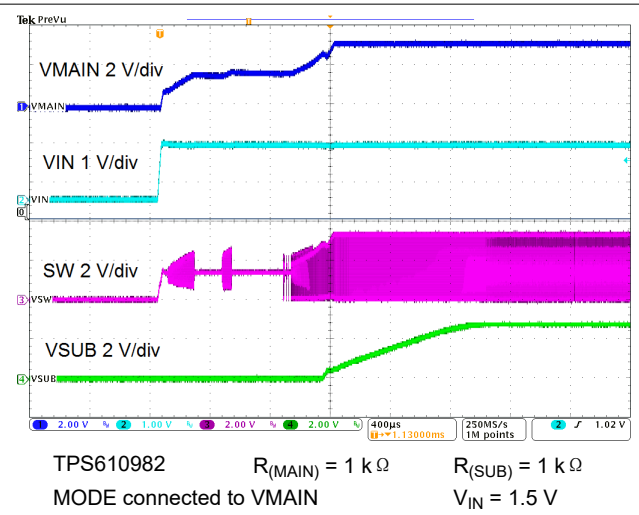
11.1 Layout Guidelines

As for all switching power supplies, the layout is an important step in the design, especially at high peak currents and high switching frequencies. If the layout is not carefully done, the regulator could show stability problems as well as EMI problems. Therefore, use wide and short traces for the main current path and for the power ground paths. The input and output capacitor, as well as the inductor should be placed as close as possible to the IC.

11.2 Layout Example

The bottom layer is a large GND plane connected by vias.



图 11-1. Layout

12 Device and Documentation Support

12.1 Device Support

12.1.1 第三方产品免责声明

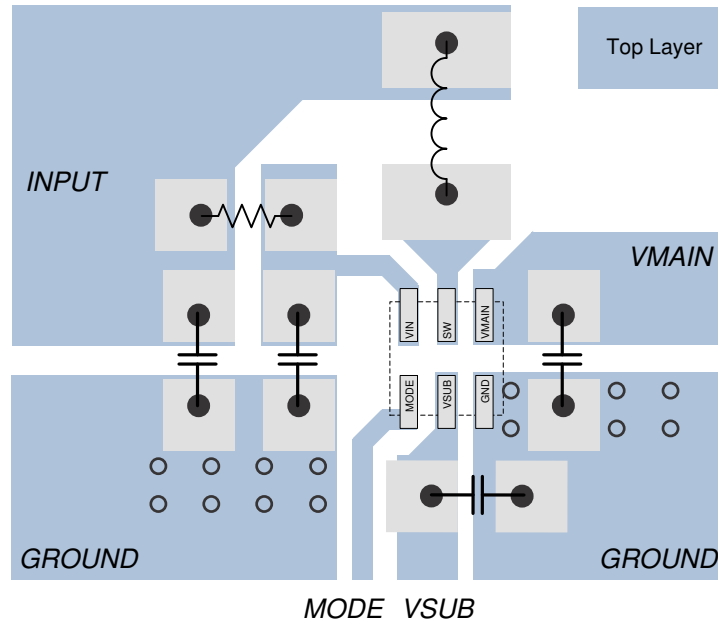
TI 发布的与第三方产品或服务有关的信息，不能构成与此类产品或服务或保修的适用性有关的认可，不能构成此类产品或服务单独或与任何 TI 产品或服务一起的表示或认可。

12.2 Documentation Support

12.2.1 Related Documentation

- Texas Instruments, [Performing Accurate PFM Mode Efficiency Measurements Application Report](#)
- Texas Instruments, [Accurately Measuring Efficiency Of Ultra Low-IQ Devices Technical Brief](#)
- Texas Instruments, [IQ: What It Is, What It Isn't, And How To Use It Technical Brief](#)

12.3 接收文档更新通知

要接收文档更新通知，请导航至 ti.com 上的器件产品文件夹。点击 [订阅更新](#) 进行注册，即可每周接收产品信息更改摘要。有关更改的详细信息，请查看任何已修订文档中包含的修订历史记录。

12.4 支持资源

TI E2E™ [支持论坛](#) 是工程师的重要参考资料，可直接从专家获得快速、经过验证的解答和设计帮助。搜索现有解答或提出自己的问题可获得所需的快速设计帮助。

链接的内容由各个贡献者“按原样”提供。这些内容并不构成 TI 技术规范，并且不一定反映 TI 的观点；请参阅 TI 的 [《使用条款》](#)。

12.5 Trademarks

TI E2E™ is a trademark of Texas Instruments.

所有商标均为其各自所有者的财产。

12.6 静电放电警告



静电放电 (ESD) 会损坏这个集成电路。德州仪器 (TI) 建议通过适当的预防措施处理所有集成电路。如果不遵守正确的处理和安装程序，可能会损坏集成电路。

ESD 的损坏小至导致微小的性能降级，大至整个器件故障。精密的集成电路可能更容易受到损坏，这是因为非常细微的参数更改都可能会导致器件与其发布的规格不相符。

12.7 术语表

[TI 术语表](#) 本术语表列出并解释了术语、首字母缩略词和定义。

13 Mechanical, Packaging, and Orderable Information

The following pages include mechanical packaging and orderable information. This information is the most current data available for the designated devices. This data is subject to change without notice and revision of this document. For browser-based versions of this data sheet, refer to the left-hand navigation.

PACKAGING INFORMATION

Orderable Device	Status (1)	Package Type	Package Drawing	Pins	Package Qty	Eco Plan (2)	Lead finish/ Ball material (6)	MSL Peak Temp (3)	Op Temp (°C)	Device Marking (4/5)	Samples
TPS610981DSER	ACTIVE	WSON	DSE	6	3000	RoHS & Green	NIPDAU	Level-1-260C-UNLIM	-40 to 125	GM	Samples
TPS610981DSET	ACTIVE	WSON	DSE	6	250	RoHS & Green	NIPDAU	Level-1-260C-UNLIM	-40 to 125	GM	Samples
TPS610982DSER	ACTIVE	WSON	DSE	6	3000	RoHS & Green	NIPDAU	Level-1-260C-UNLIM	-40 to 125	G8	Samples
TPS610982DSET	ACTIVE	WSON	DSE	6	250	RoHS & Green	NIPDAU	Level-1-260C-UNLIM	-40 to 125	G8	Samples
TPS610985DSER	ACTIVE	WSON	DSE	6	3000	RoHS & Green	NIPDAU	Level-1-260C-UNLIM	-40 to 125	1G	Samples
TPS610985DSET	ACTIVE	WSON	DSE	6	250	RoHS & Green	NIPDAU	Level-1-260C-UNLIM	-40 to 125	1G	Samples
TPS610986DSER	ACTIVE	WSON	DSE	6	3000	RoHS & Green	NIPDAU	Level-1-260C-UNLIM	-40 to 125	1H	Samples
TPS610986DSET	ACTIVE	WSON	DSE	6	250	RoHS & Green	NIPDAU	Level-1-260C-UNLIM	-40 to 125	1H	Samples
TPS610987DSER	ACTIVE	WSON	DSE	6	3000	RoHS & Green	NIPDAU	Level-1-260C-UNLIM	-40 to 125	3X	Samples
TPS610987DSET	ACTIVE	WSON	DSE	6	250	RoHS & Green	NIPDAU	Level-1-260C-UNLIM	-40 to 125	3X	Samples
TPS61098DSER	ACTIVE	WSON	DSE	6	3000	RoHS & Green	NIPDAU	Level-1-260C-UNLIM	-40 to 125	GL	Samples
TPS61098DSET	ACTIVE	WSON	DSE	6	250	RoHS & Green	NIPDAU	Level-1-260C-UNLIM	-40 to 125	GL	Samples

(1) The marketing status values are defined as follows:

ACTIVE: Product device recommended for new designs.

LIFEBUY: TI has announced that the device will be discontinued, and a lifetime-buy period is in effect.

NRND: Not recommended for new designs. Device is in production to support existing customers, but TI does not recommend using this part in a new design.

PREVIEW: Device has been announced but is not in production. Samples may or may not be available.

OBSELETE: TI has discontinued the production of the device.

(2) **RoHS:** TI defines "RoHS" to mean semiconductor products that are compliant with the current EU RoHS requirements for all 10 RoHS substances, including the requirement that RoHS substance do not exceed 0.1% by weight in homogeneous materials. Where designed to be soldered at high temperatures, "RoHS" products are suitable for use in specified lead-free processes. TI may reference these types of products as "Pb-Free".

RoHS Exempt: TI defines "RoHS Exempt" to mean products that contain lead but are compliant with EU RoHS pursuant to a specific EU RoHS exemption.

Green: TI defines "Green" to mean the content of Chlorine (Cl) and Bromine (Br) based flame retardants meet JS709B low halogen requirements of <=1000ppm threshold. Antimony trioxide based flame retardants must also meet the <=1000ppm threshold requirement.

- (3) MSL, Peak Temp. - The Moisture Sensitivity Level rating according to the JEDEC industry standard classifications, and peak solder temperature.
- (4) There may be additional marking, which relates to the logo, the lot trace code information, or the environmental category on the device.
- (5) Multiple Device Markings will be inside parentheses. Only one Device Marking contained in parentheses and separated by a "~" will appear on a device. If a line is indented then it is a continuation of the previous line and the two combined represent the entire Device Marking for that device.
- (6) Lead finish/Ball material - Orderable Devices may have multiple material finish options. Finish options are separated by a vertical ruled line. Lead finish/Ball material values may wrap to two lines if the finish value exceeds the maximum column width.

Important Information and Disclaimer:The information provided on this page represents TI's knowledge and belief as of the date that it is provided. TI bases its knowledge and belief on information provided by third parties, and makes no representation or warranty as to the accuracy of such information. Efforts are underway to better integrate information from third parties. TI has taken and continues to take reasonable steps to provide representative and accurate information but may not have conducted destructive testing or chemical analysis on incoming materials and chemicals. TI and TI suppliers consider certain information to be proprietary, and thus CAS numbers and other limited information may not be available for release.

In no event shall TI's liability arising out of such information exceed the total purchase price of the TI part(s) at issue in this document sold by TI to Customer on an annual basis.

TAPE AND REEL INFORMATION

QUADRANT ASSIGNMENTS FOR PIN 1 ORIENTATION IN TAPE



*All dimensions are nominal

Device	Package Type	Package Drawing	Pins	SPQ	Reel Diameter (mm)	Reel Width W1 (mm)	A0 (mm)	B0 (mm)	K0 (mm)	P1 (mm)	W (mm)	Pin1 Quadrant
TPS610981DSER	WSON	DSE	6	3000	178.0	8.4	1.7	1.7	0.95	4.0	8.0	Q2
TPS610981DSET	WSON	DSE	6	250	178.0	8.4	1.7	1.7	0.95	4.0	8.0	Q2
TPS610982DSER	WSON	DSE	6	3000	178.0	8.4	1.7	1.7	0.95	4.0	8.0	Q2
TPS610982DSET	WSON	DSE	6	250	178.0	8.4	1.7	1.7	0.95	4.0	8.0	Q2
TPS610985DSER	WSON	DSE	6	3000	178.0	8.4	1.7	1.7	0.95	4.0	8.0	Q2
TPS610985DSET	WSON	DSE	6	250	178.0	8.4	1.7	1.7	0.95	4.0	8.0	Q2
TPS610986DSER	WSON	DSE	6	3000	178.0	8.4	1.7	1.7	0.95	4.0	8.0	Q2
TPS610986DSET	WSON	DSE	6	250	178.0	8.4	1.7	1.7	0.95	4.0	8.0	Q2
TPS610987DSER	WSON	DSE	6	3000	178.0	8.4	1.7	1.7	0.95	4.0	8.0	Q2
TPS610987DSET	WSON	DSE	6	250	178.0	8.4	1.7	1.7	0.95	4.0	8.0	Q2
TPS61098DSER	WSON	DSE	6	3000	178.0	8.4	1.7	1.7	0.95	4.0	8.0	Q2
TPS61098DSET	WSON	DSE	6	250	178.0	8.4	1.7	1.7	0.95	4.0	8.0	Q2

TAPE AND REEL BOX DIMENSIONS

*All dimensions are nominal

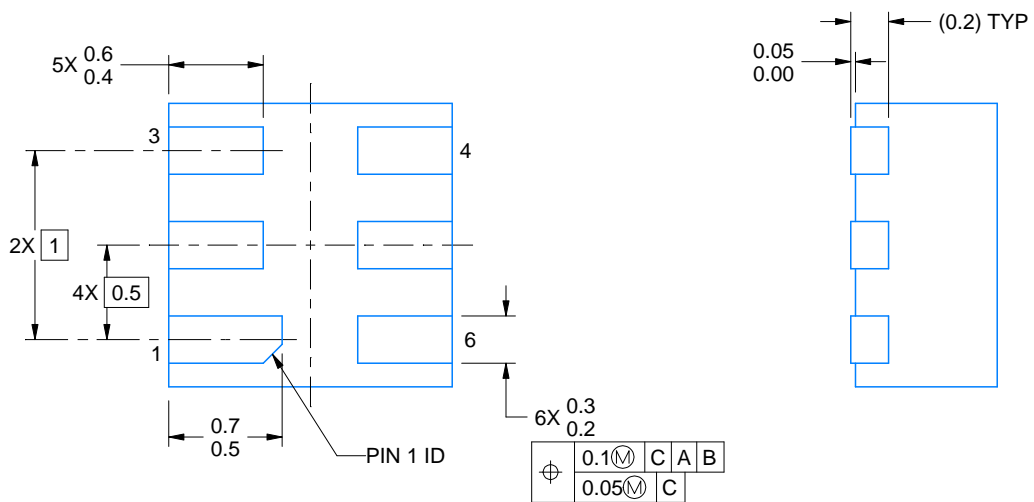
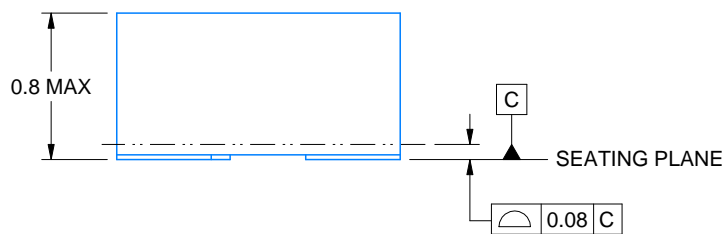
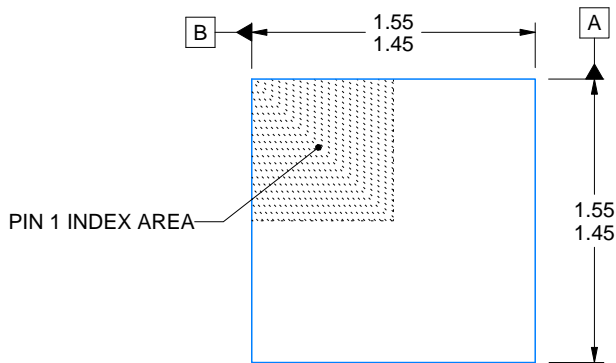
Device	Package Type	Package Drawing	Pins	SPQ	Length (mm)	Width (mm)	Height (mm)
TPS610981DSER	WSON	DSE	6	3000	205.0	200.0	33.0
TPS610981DSET	WSON	DSE	6	250	205.0	200.0	33.0
TPS610982DSER	WSON	DSE	6	3000	205.0	200.0	33.0
TPS610982DSET	WSON	DSE	6	250	205.0	200.0	33.0
TPS610985DSER	WSON	DSE	6	3000	205.0	200.0	33.0
TPS610985DSET	WSON	DSE	6	250	205.0	200.0	33.0
TPS610986DSER	WSON	DSE	6	3000	205.0	200.0	33.0
TPS610986DSET	WSON	DSE	6	250	205.0	200.0	33.0
TPS610987DSER	WSON	DSE	6	3000	205.0	200.0	33.0
TPS610987DSET	WSON	DSE	6	250	205.0	200.0	33.0
TPS61098DSER	WSON	DSE	6	3000	205.0	200.0	33.0
TPS61098DSET	WSON	DSE	6	250	205.0	200.0	33.0



4220552/B 01/2024

NOTES:

1. All linear dimensions are in millimeters. Any dimensions in parenthesis are for reference only. Dimensioning and tolerancing per ASME Y14.5M.
2. This drawing is subject to change without notice.

EXAMPLE BOARD LAYOUT

DSE0006A

WSON - 0.8 mm max height

PLASTIC SMALL OUTLINE - NO LEAD

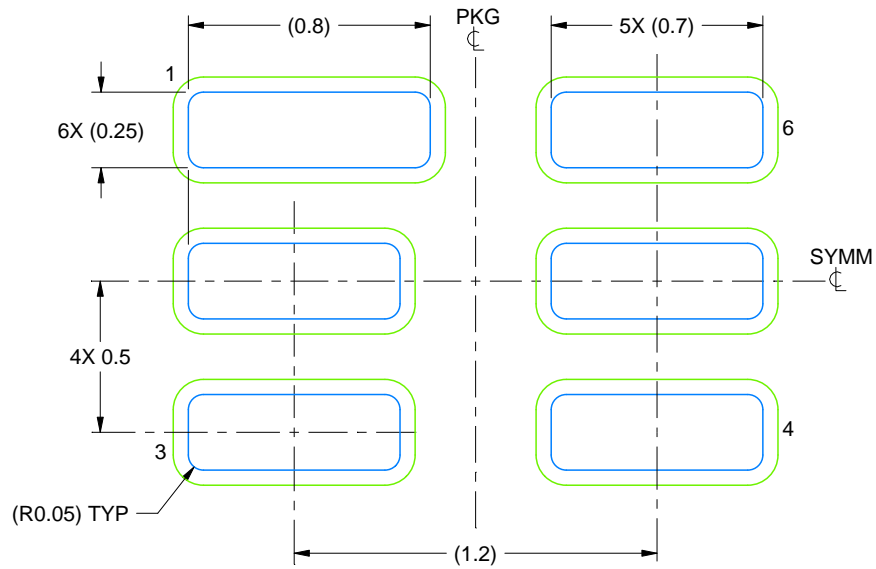

LAND PATTERN EXAMPLE
SCALE:40X

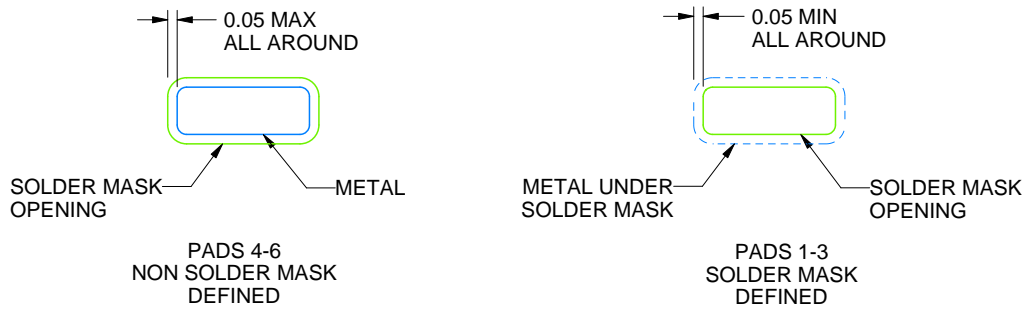

SOLDER MASK DETAILS

4220552/B 01/2024

NOTES: (continued)

3. For more information, see Texas Instruments literature number SLUA271 (www.ti.com/lit/slua271).

EXAMPLE STENCIL DESIGN

DSE0006A

WSON - 0.8 mm max height

PLASTIC SMALL OUTLINE - NO LEAD

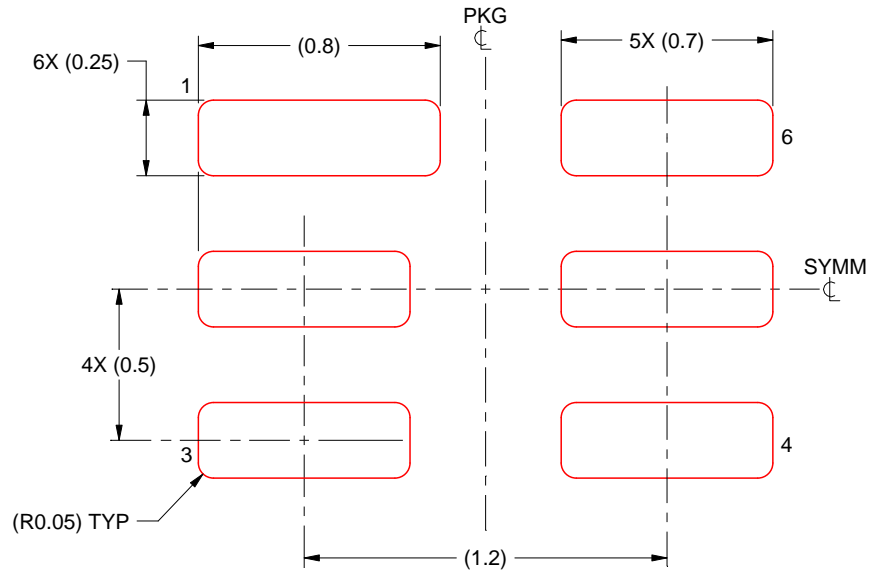

SOLDER PASTE EXAMPLE
BASED ON 0.125 mm THICK STENCIL
SCALE:40X

NOTES: (continued)

4. Laser cutting apertures with trapezoidal walls and rounded corners may offer better paste release. IPC-7525 may have alternate design recommendations.

重要声明和免责声明

TI“按原样”提供技术和可靠性数据（包括数据表）、设计资源（包括参考设计）、应用或其他设计建议、网络工具、安全信息和其他资源，不保证没有瑕疵且不做任何明示或暗示的担保，包括但不限于对适销性、某特定用途方面的适用性或不侵犯任何第三方知识产权的暗示担保。

这些资源可供使用 TI 产品进行设计的熟练开发人员使用。您将自行承担以下全部责任：(1) 针对您的应用选择合适的 TI 产品，(2) 设计、验证并测试您的应用，(3) 确保您的应用满足相应标准以及任何其他功能安全、信息安全、监管或其他要求。

这些资源如有变更，恕不另行通知。TI 授权您仅可将这些资源用于研发本资源所述的 TI 产品的应用。严禁对这些资源进行其他复制或展示。您无权使用任何其他 TI 知识产权或任何第三方知识产权。您应全额赔偿因在这些资源的使用中对 TI 及其代表造成的任何索赔、损害、成本、损失和债务，TI 对此概不负责。

TI 提供的产品受 [TI 的销售条款](#) 或 [ti.com](#) 上其他适用条款/TI 产品随附的其他适用条款的约束。TI 提供这些资源并不会扩展或以其他方式更改 TI 针对 TI 产品发布的适用的担保或担保免责声明。

TI 反对并拒绝您可能提出的任何其他或不同的条款。

邮寄地址：Texas Instruments, Post Office Box 655303, Dallas, Texas 75265

Copyright © 2024，德州仪器 (TI) 公司