

## TPS7B84-Q1 150mA、40V 可调节低压降稳压器

### 1 特性

- 符合面向汽车应用的 AEC-Q100 标准：
  - 温度等级 1：-40°C 至 +125°C， $T_A$
  - 结温：-40°C 至 +150°C， $T_J$
- 输入电压范围：3V 至 40V (最大 42V)
- 输出电压范围：
  - 可调输出：1.2V 至 18V
  - 固定输出：3.3V 和 5V
- 输出电流：高达 150mA
- 输出电压精度： $\pm 0.75\%$  (最大值)
- 低压降：
  - 150mA 时为 225mV (最大值) ( $V_{OUT} \geq 3.3V$ )
- 低静态电流：
  - 18 $\mu$ A (典型值)
  - 禁用时最大值为 4 $\mu$ A
- 出色的线路瞬态响应：
  - 冷启动时出现  $\pm 2\%$   $V_{OUT}$  偏差
  - $\pm 2\%$   $V_{OUT}$  偏差 ( $V_{IN}$  压摆率 1V/ $\mu$ s)
- 与 2.2 $\mu$ F 或更高的电容器搭配使用时可保持稳定
- 提供功能安全
  - 可帮助进行功能安全系统设计的文档
- 封装选项：
  - DRB (8 引脚 VSON)， $R_{\theta JA}$ ：50.8°C/W
  - DCY (4 引脚 SOT-223)， $R_{\theta JA}$ ：85.5°C/W

### 2 应用

- 可重新配置仪表组
- 车身控制模块 (BCM)
- 常开型电池连接应用：
  - 汽车网关
  - 远程免钥匙进入 (RKE)

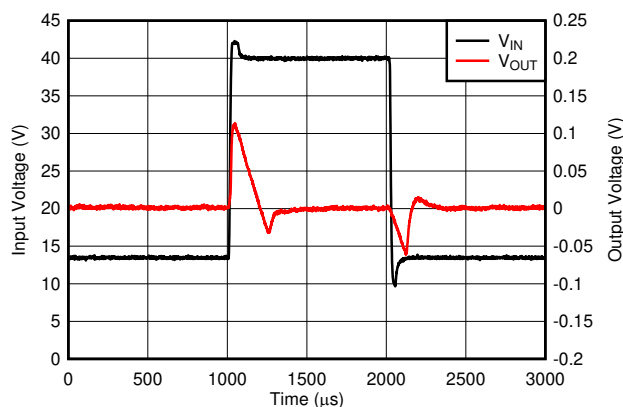

线路瞬态响应 ( $V_{IN}$  压摆率 3V/ $\mu$ s)

### 3 说明

TPS7B84-Q1 是一款低压降线性稳压器，专用于连接汽车应用中的电池。该器件的输入电压范围高达 40V，因此可承受汽车系统可能发生的瞬变（如负载突降）。此器件的静态电流仅为 18 $\mu$ A，是为备用系统中微控制器 (MCU) 和控制器局域网 (CAN) 收发器等常开型器件供电的出色解决方案。

TPS7B84-Q1 具有固定和可调输出类型。该器件具有宽输入电压范围，因此能够为碳化硅 (SiC) 栅极驱动器和麦克风产生偏置电压，以及为 MCU 和处理器供电。

该器件具有先进的瞬态响应，因此输出端可对负载或线路变化（例如，在冷启动条件下）作出迅速响应。此外，该器件架构新颖，可在从电压跌落恢复过程中最大限度降低输出过冲幅度。正常运行时，该器件可在整个线路、负载和温度范围内维持  $\pm 0.75\%$  的直流精度。

该器件采用 SOT223 封装和具有可湿性侧面的小型 VSON 封装，可实现紧凑的印刷电路板 (PCB) 设计。即使整个器件散热较多，低热阻也有助于持久运行。

#### 器件信息<sup>(1)</sup>

器件型号	封装	封装尺寸 (标称值)
TPS7B84-Q1	VSON (8)	3.00mm × 3.00mm
	SOT-223 (4)	6.50mm × 3.50mm

(1) 如需了解所有可用封装，请参阅数据表末尾的可订购产品附录。

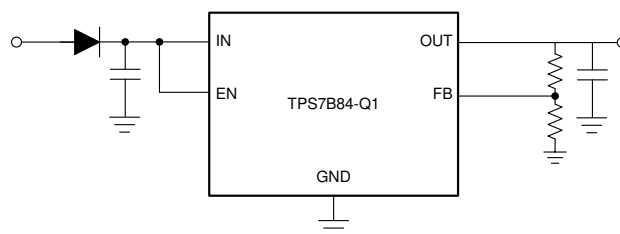

典型应用原理图



## Table of Contents

<b>1 特性</b> .....	1	7.4 Device Functional Modes.....	16
<b>2 应用</b> .....	1	<b>8 Application and Implementation</b> .....	17
<b>3 说明</b> .....	1	8.1 Application Information.....	17
<b>4 Revision History</b> .....	2	8.2 Typical Application.....	22
<b>5 Pin Configuration and Functions</b> .....	3	<b>9 Power Supply Recommendations</b> .....	23
<b>6 Specifications</b> .....	4	<b>10 Layout</b> .....	24
6.1 Absolute Maximum Ratings .....	4	10.1 Layout Guidelines.....	24
6.2 ESD Ratings .....	4	10.2 Layout Examples .....	25
6.3 Recommended Operating Conditions .....	4	<b>11 Device and Documentation Support</b> .....	26
6.4 Thermal Information .....	5	11.1 Device Support.....	26
6.5 Electrical Characteristics .....	5	11.2 接收文档更新通知.....	26
6.6 Typical Characteristics.....	7	11.3 支持资源.....	26
<b>7 Detailed Description</b> .....	13	11.4 Trademarks.....	26
7.1 Overview.....	13	11.5 静电放电警告.....	26
7.2 Functional Block Diagrams .....	13	11.6 术语表.....	26
7.3 Feature Description.....	14		

## 4 Revision History

注：以前版本的页码可能与当前版本的页码不同

### Changes from Revision \* (April 2020) to Revision A (November 2020)

	Page
• 将文档状态从预告信息更改为量产数据.....	1

## 5 Pin Configuration and Functions



图 5-1. DCY Package, 4-Pin SOT-223, Top View



图 5-2. DRB Package, 8-Pin VSON, Top View

表 5-1. Pin Functions

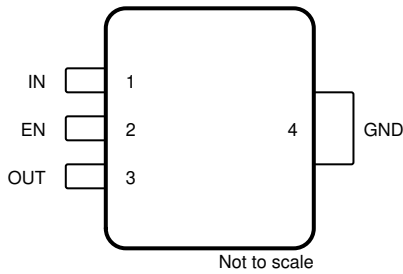
NAME	PIN		TYPE <sup>(1)</sup>	DESCRIPTION
	DCY	DRB		
EN	2	7	I	Enable pin. The device is disabled when the enable pin becomes lower than the enable logic input low level ( $V_{IL}$ ). To ensure the device is enabled, the EN pin must be driven above the logic high level ( $V_{IH}$ ). This pin should not be left floating as this pin is high impedance if it is left floating the part may enable or disable.
GND	4	5	G	Ground pin. Connect this pin to the thermal pad with a low-impedance connection.
FB/NC	—	2	I	Feedback pin when using an external resistor divider or an NC pin when using the device with a fixed output voltage. When using the adjustable device this pin must be connected through a resistor divider to the output for the device to function.
NC	—	3, 4, 6	—	No internal connection. Connect these pins to GND for the best thermal performance.
IN	1	8	I	Input power-supply voltage pin. For best transient response and to minimize input impedance, use the recommended value or larger ceramic capacitor from IN to ground as listed in the <i>Recommended Operating Conditions</i> table and the <a href="#">Input Capacitor</a> section. Place the input capacitor as close to the input of the device as possible.
OUT	3	1	O	Regulated output voltage pin. A capacitor is required from OUT to ground for stability. For best transient response, use the nominal recommended value or larger ceramic capacitor from OUT to ground; see the <i>Recommended Operating Conditions</i> table and the <a href="#">Output Capacitor</a> section. Place the output capacitor as close to output of the device as possible. If using a high ESR capacitor, decouple the output with a 100-nF ceramic capacitor.
Thermal pad	—	Pad	—	Thermal pad. Connect the pad to GND for the best possible thermal performance. See the <a href="#">Layout</a> section for more information.

(1) I = input; O = output; G = ground.

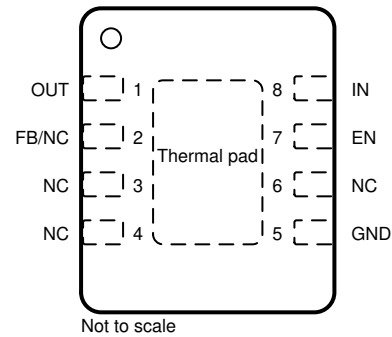
## 6 Specifications

### 6.1 Absolute Maximum Ratings

over operating free-air temperature range (unless otherwise noted)<sup>(1)</sup>

		MIN	MAX	UNIT
IN	Unregulated input	- 0.3	42	V
EN	Enable input	- 0.3	42	V
OUT	Regulated output	- 0.3	$V_{IN} + 0.3$ <sup>(2)</sup>	V
FB	Feedback	- 0.3	20	V
T <sub>A</sub>	Operating ambient temperature	- 40	125	°C
T <sub>J</sub>	Operating junction temperature	- 40	150	°C
T <sub>stg</sub>	Storage temperature	- 65	150	°C

- (1) Stresses beyond those listed under *absolute maximum ratings* may cause permanent damage to the device. These are stress ratings only and functional operation of the device at these or any other conditions beyond those indicated under *recommended operating conditions* is not implied. Exposure to absolute-maximum-rated conditions for extended periods may affect device reliability.
- (2) The absolute maximum rating is  $V_{IN} + 0.3$  V or 20 V, whichever is smaller.

### 6.2 ESD Ratings

			VALUE	UNIT	
V <sub>(ESD)</sub>	Electrostatic discharge	Human-body model (HBM), per AEC Q100-002 <sup>(1)</sup>	±2000	V	
		Charged-device model (CDM), per AEC Q100-011	All pins		±500
			Corner pins		±750

- (1) AEC Q100-002 indicates that HBM stressing shall be in accordance with the ANSI/ESDA/JEDEC JS-001 specification.

### 6.3 Recommended Operating Conditions

over operating free-air temperature range (unless otherwise noted)

		MIN	TYP	MAX	UNIT
V <sub>IN</sub>	Input voltage	3		40	V
V <sub>OUT</sub>	Output voltage	1.2		18	V
I <sub>OUT</sub>	Output current	0		150	mA
F <sub>EN</sub>	Enable pin frequency <sup>(1)</sup>			5	kHz
V <sub>EN</sub>	High voltage (I/O)	0		40	V
C <sub>OUT</sub>	Output capacitor <sup>(3)</sup>	2.2		220	μF
ESR	Output capacitor ESR requirements <sup>(4)</sup>	0.001		2	Ω
C <sub>IN</sub>	Input capacitor <sup>(2)</sup>	0.1	1		μF
T <sub>J</sub>	Operating junction temperature	- 40		150	°C

- (1) Minimum pulse time on the EN pin is 100 μs.
- (2) For robust EMI performance the minimum input capacitance is 500 nF.
- (3) Effective output capacitance of 1 μF minimum required for stability.
- (4) If using a large ESR capacitor it is recommended to decouple this with a 100-nF ceramic capacitor to improve transient performance.

## 6.4 Thermal Information

THERMAL METRIC <sup>(1) (2)</sup>		TPS7B84-Q1		Unit
		DRB (VSON)	DCY	
		8 PINS	4 PINS	
$R_{\theta JA}$	Junction-to-ambient thermal resistance <sup>(3)</sup>	50.8	85.5	°C/W
$R_{\theta JC(top)}$	Junction-to-case (top) thermal resistance	55.6	46.6	°C/W
$R_{\theta JB}$	Junction-to-board thermal resistance	22.9	11.3	°C/W
$\psi_{JT}$	Junction-to-top characterization parameter	1.2	4.9	°C/W
$\psi_{JB}$	Junction-to-board characterization parameter	22.9	11	°C/W
$R_{\theta JC(bot)}$	Junction-to-case (bottom) thermal resistance	7.5	11	°C/W

- (1) The thermal data is based on the JEDEC standard high K profile, JESD 51-7. Two-signal, two-plane, four-layer board with 2-oz. copper. The copper pad is soldered to the thermal land pattern. Also, correct attachment procedure must be incorporated.
- (2) For more information about traditional and new thermal metrics, see the [Semiconductor and IC Package Thermal Metrics](#) application report.
- (3) The 1s0p  $R_{\theta JA}$  is 212.7°C/W for the DRB package and 168.8°C/W for the DCY package.

## 6.5 Electrical Characteristics

specified at  $T_J = -40^\circ\text{C}$  to  $+150^\circ\text{C}$ ,  $V_{IN} = 13.5\text{ V}$ ,  $I_{OUT} = 0\text{ mA}$ ,  $C_{OUT} = 2.2\ \mu\text{F}$ ,  $1\text{ m}\Omega < C_{OUT}\text{ ESR} < 2\ \Omega$ ,  $C_{IN} = 1\ \mu\text{F}$ , and  $V_{EN} = 2\text{ V}$  (unless otherwise noted); typical values are at  $T_J = 25^\circ\text{C}$

PARAMETER		TEST CONDITIONS		MIN	TYP	MAX	UNIT
$V_{OUT}$	Regulated output accuracy	$V_{IN} = V_{OUT} + 500\text{ mV}$ to $40\text{ V}$ , $I_{OUT} = 100\ \mu\text{A}$ to $150\text{ mA}$ <sup>(2)</sup> (1)	$T_J = 25^\circ\text{C}$	-0.5		0.5	%
			$T_J = -40^\circ\text{C}$ to $+150^\circ\text{C}$	-		0.75	
$V_{OUT}$	Regulated output accuracy DCY	$V_{IN} = V_{OUT} + 500\text{ mV}$ to $40\text{ V}$ , $I_{OUT} = 100\ \mu\text{A}$ to $150\text{ mA}$ <sup>(2)</sup> (1)	$T_J = 25^\circ\text{C}$	-		0.75	%
			$T_J = -40^\circ\text{C}$ to $+150^\circ\text{C}$	-1		1	
$\Delta V_{OUT(\Delta V_{IN})}$	Line regulation	Change in percent of output voltage	$V_{IN} = V_{OUT} + 500\text{ mV}$ to $40\text{ V}$ , $I_{OUT} = 100\ \mu\text{A}$			0.2	%
$\Delta V_{OUT(\Delta I_{OUT})}$	Load regulation		$V_{IN} = V_{OUT} + 500\text{ mV}$ , $I_{OUT} = 100\ \mu\text{A}$ to $150\text{ mA}$ , $V_{OUT} \geq 3.3\text{ V}$			0.2	
$\Delta V_{OUT(\Delta I_{OUT})}$	Load regulation (Adjustable output only)	Change in percent of output voltage	$V_{IN} = V_{OUT} + 500\text{ mV}$ , $I_{OUT} = 100\ \mu\text{A}$ to $150\text{ mA}$ , $V_{OUT} < 3.3\text{ V}$			0.3	%
$\Delta V_{OUT}$	Load transient response settling time <sup>(4) (5)</sup>	$C_{OUT} = 10\ \mu\text{F}$	$C_{OUT} = 10\ \mu\text{F}$			100	$\mu\text{s}$
	Load transient response overshoot, undershoot <sup>(5)</sup>		$I_{OUT} = 45\text{ mA}$ to $105\text{ mA}$	-2%		10%	% $V_{OUT}$
			$I_{OUT} = 0\text{ mA}$ to $150\text{ mA}$	-		10%	
$I_Q$	Quiescent current	$V_{IN} = V_{OUT} + 500\text{ mV}$ to $40\text{ V}$ , $I_{OUT} = 0\text{ mA}$ <sup>(2)</sup>	$T_J = 25^\circ\text{C}$		18	21	$\mu\text{A}$
			$T_J = -40^\circ\text{C}$ to $+150^\circ\text{C}$			26	
			$T_J = -40^\circ\text{C}$ to $+150^\circ\text{C}$			35	
$I_{SHUTDOWN}$	Shutdown supply current ( $I_{GND}$ )	$V_{EN} = 0\text{ V}$	$T_J = 25^\circ\text{C}$			2.5	$\mu\text{A}$
			$T_J = -40^\circ\text{C}$ to $+150^\circ\text{C}$			4	

## 6.5 Electrical Characteristics (continued)

specified at  $T_J = -40^\circ\text{C}$  to  $+150^\circ\text{C}$ ,  $V_{IN} = 13.5\text{ V}$ ,  $I_{OUT} = 0\text{ mA}$ ,  $C_{OUT} = 2.2\ \mu\text{F}$ ,  $1\text{ m}\Omega < C_{OUT}\text{ ESR} < 2\ \Omega$ ,  $C_{IN} = 1\ \mu\text{F}$ , and  $V_{EN} = 2\text{ V}$  (unless otherwise noted); typical values are at  $T_J = 25^\circ\text{C}$

PARAMETER		TEST CONDITIONS	MIN	TYP	MAX	UNIT
$V_{DO}$	Dropout voltage (DCY package)	$I_{OUT} \leq 1\text{ mA}$ , $V_{OUT} \geq 3.3\text{ V}$ , $V_{IN} = V_{OUT(NOM)} \times 0.95$			47	mV
		$I_{OUT} = 105\text{ mA}$ , $V_{OUT} \geq 3.3\text{ V}$ , $V_{IN} = V_{OUT(NOM)}$		130	180	
		$I_{OUT} = 150\text{ mA}$ , $V_{OUT} \geq 3.3\text{ V}$ , $V_{IN} = V_{OUT(NOM)}$		160	230	
$V_{DO}$	Dropout voltage (fixed output DRB package)	$I_{OUT} \leq 1\text{ mA}$ , $V_{OUT} \geq 3.3\text{ V}$ , $V_{IN} = V_{OUT(NOM)} \times 0.95$			43	mV
		$I_{OUT} = 105\text{ mA}$ , $V_{OUT} \geq 3.3\text{ V}$ , $V_{IN} = V_{OUT(NOM)}$		125	175	
		$I_{OUT} = 150\text{ mA}$ , $V_{OUT} \geq 3.3\text{ V}$ , $V_{IN} = V_{OUT(NOM)}$		155	225	
$V_{DO}$	Dropout voltage adjustable output DRB package	$I_{OUT} \leq 1\text{ mA}$ , $V_{IN} = 3\text{ V}$ , $V_{FB} = 0.61\text{ V}^{(3)}$			43	mV
	Dropout voltage adjustable output	$I_{OUT} = 105\text{ mA}$ , $V_{IN} = 3\text{ V}$ , $V_{FB} = 0.61\text{ V}^{(3)}$		140	195	
		$I_{OUT} = 150\text{ mA}$ , $V_{IN} = 3\text{ V}$ , $V_{FB} = 0.61\text{ V}^{(3)}$		175	245	
$V_{FB}$	Feedback voltage	Reference voltage for FB	0.645	0.65	0.655	V
$I_{FB}$	Feedback current		-10		10	nA
$V_{UVLO(RISING)}$	Rising input supply UVLO	$V_{IN}$ rising	2.6	2.7	2.82	V
$V_{UVLO(FALLING)}$	Falling input supply UVLO	$V_{IN}$ falling	2.38	2.5	2.6	V
$V_{UVLO(HYST)}$	$V_{UVLO}$ hysteresis			230		mV
$V_{IL}$	Enable logic input low level				0.7	V
$V_{IH}$	Enable logic input high level		2			V
$I_{EN}$	EN pin current	$V_{EN} = V_{IN} = 13.5\text{ V}$			50	nA
$I_{CL}$	Output current limit	$V_{IN} = V_{OUT(nom)} + 1\text{ V}$ , $V_{OUT}$ short to $90\% \times V_{OUT(NOM)}$	180	220	260	mA
PSRR	Power-supply ripple rejection	$V_{IN} - V_{OUT} = 500\text{ mV}$ , frequency = 1 kHz, $I_{OUT} = 150\text{ mA}$		55		dB
$V_n$	Output noise voltage	$V_{OUT} = 3.3\text{ V}$ , BW = 10 Hz to 100 kHz		280		$\mu\text{V}_{RMS}$
$T_{SD(SHUTDOWN)}$	Junction shutdown temperature			175		$^\circ\text{C}$
$T_{SD(HYST)}$	Hysteresis of thermal shutdown			20		$^\circ\text{C}$

- (1) Power dissipation is limited to 2W for IC production testing purposes. The power dissipation can be higher during normal operation. Please see the thermal dissipation section for more information on how much power the device can dissipate while maintaining a junction temperature below  $150^\circ\text{C}$ .
- (2) For adjustable devices this parameter is tested in unity gain, so resistor divider tolerances and current is not included.
- (3) Dropout is not measured for  $V_{IN} \leq 3\text{ V}$ .
- (4) The settling time is measured from when  $I_{OUT}$  is stepped from 45mA to 105 mA to when the output voltage recovers to  $V_{OUT} = V_{OUT(nom)} - 5\text{ mV}$ .
- (5) This specification is specified by design.

## 6.6 Typical Characteristics

specified at  $T_J = -40^\circ\text{C}$  to  $+150^\circ\text{C}$ ,  $V_{IN} = 13.5\text{ V}$ ,  $I_{OUT} = 100\ \mu\text{A}$ ,  $C_{OUT} = 2.2\ \mu\text{F}$ ,  $1\ \text{m}\Omega < C_{OUT}\ \text{ESR} < 2\ \Omega$ ,  $C_{IN} = 1\ \mu\text{F}$ , and  $V_{EN} = 2\ \text{V}$  (unless otherwise noted)



图 6-1. Accuracy vs Temperature



$V_{OUT} = 5\ \text{V}$ ,  $I_{OUT} = 150\ \text{mA}$

图 6-2. Line Regulation vs  $V_{IN}$

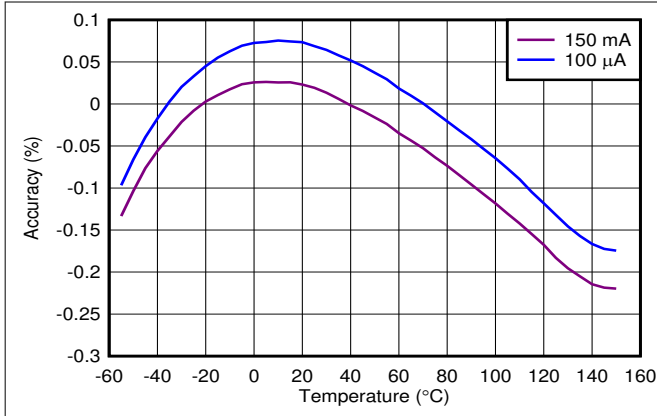
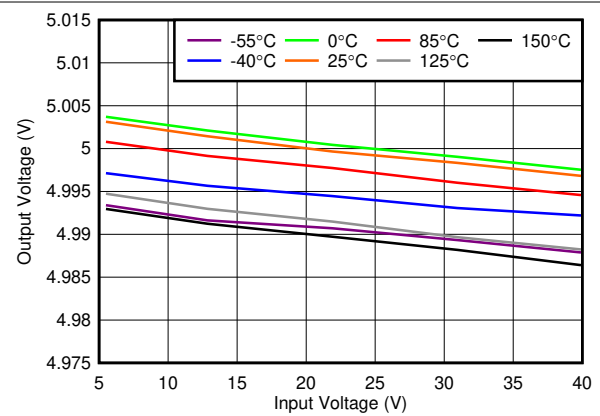
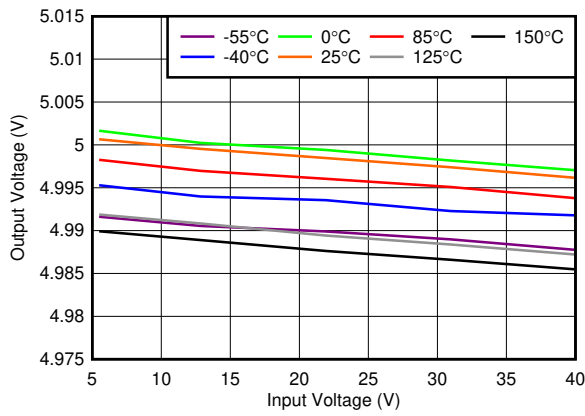

$V_{OUT} = 5\ \text{V}$ ,  $I_{OUT} = 5\ \text{mA}$

图 6-3. Line Regulation vs  $V_{IN}$

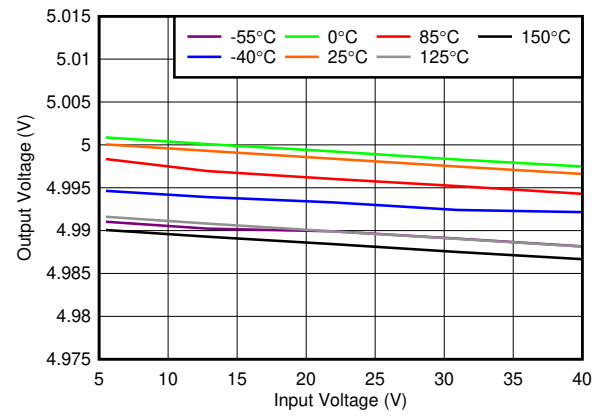

$V_{OUT} = 5\ \text{V}$ ,  $I_{OUT} = 1\ \text{mA}$

图 6-4. Line Regulation vs  $V_{IN}$

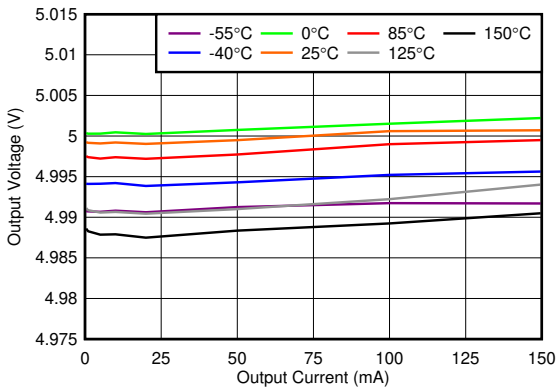

$V_{OUT} = 5\ \text{V}$

图 6-5. Load Regulation vs  $I_{OUT}$

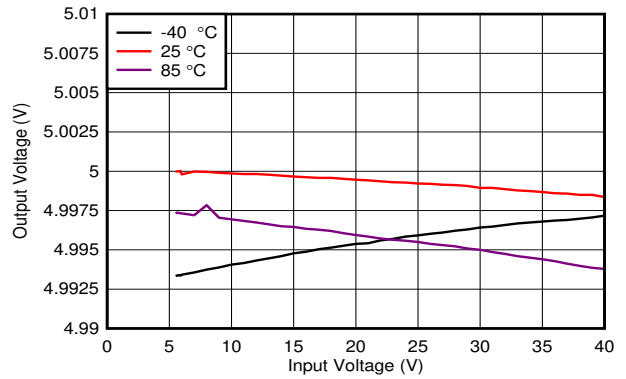

$C_{OUT} = 10\ \mu\text{F}$

图 6-6. Line Regulation at 50 mA

### 6.6 Typical Characteristics (continued)

specified at  $T_J = -40^{\circ}\text{C}$  to  $+150^{\circ}\text{C}$ ,  $V_{IN} = 13.5\text{ V}$ ,  $I_{OUT} = 100\ \mu\text{A}$ ,  $C_{OUT} = 2.2\ \mu\text{F}$ ,  $1\ \text{m}\Omega < C_{OUT}\ \text{ESR} < 2\ \Omega$ ,  $C_{IN} = 1\ \mu\text{F}$ , and  $V_{EN} = 2\ \text{V}$  (unless otherwise noted)



图 6-7. Line Regulation at 100 mA



图 6-8. Dropout Voltage ( $V_{DO}$ ) vs  $I_{OUT}$

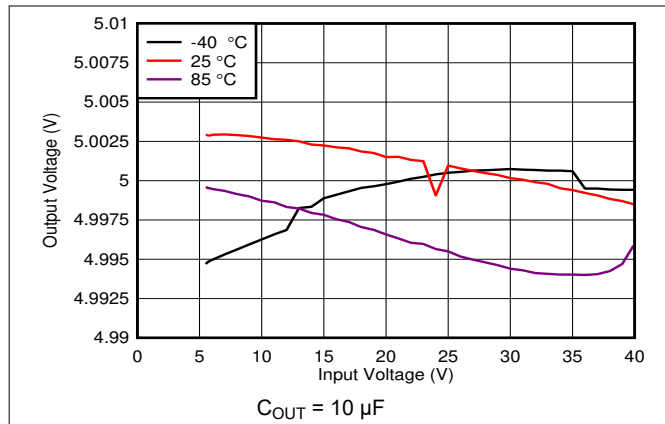

图 6-9. PSRR vs Frequency and  $I_{OUT}$

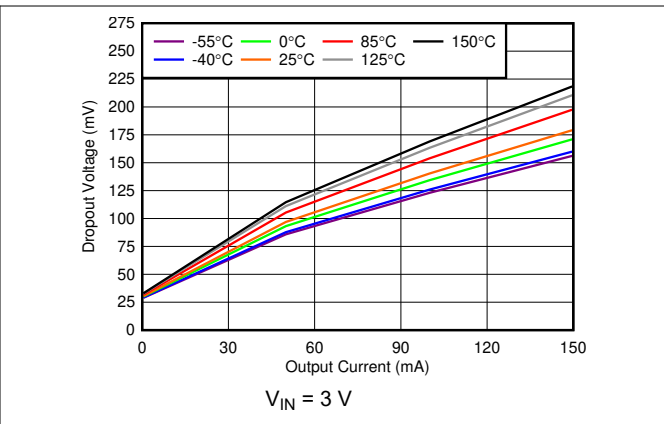

图 6-10. PSRR vs Frequency and  $V_{IN}$

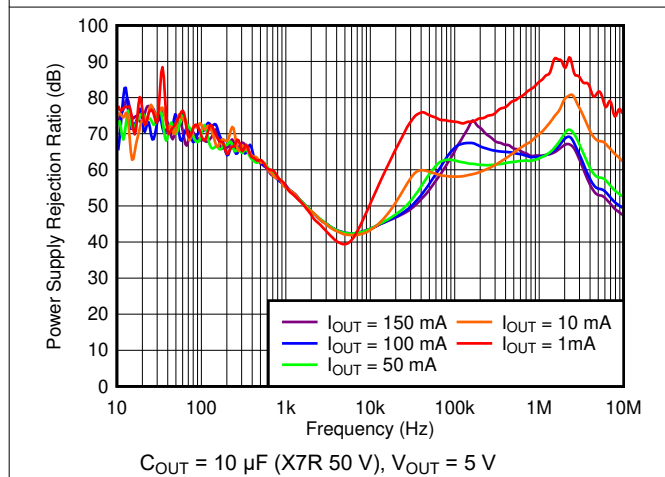

图 6-11. Noise vs Frequency at 3.3 V

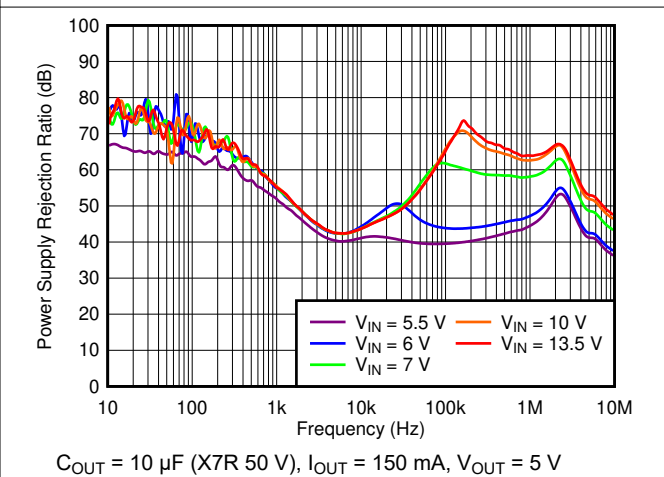

图 6-12. Noise vs Frequency at 5.0 V

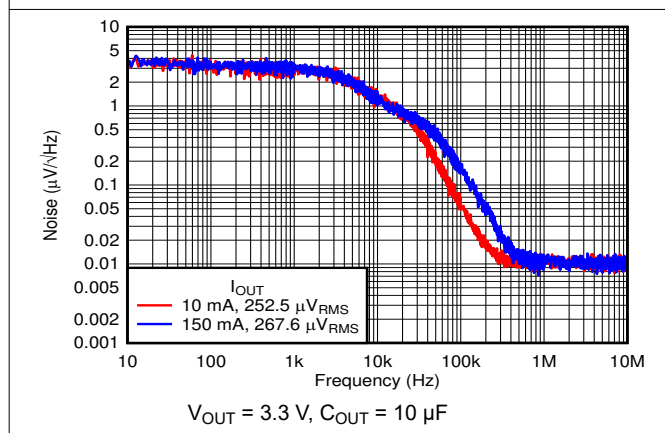

## 6.6 Typical Characteristics (continued)

specified at  $T_J = -40^\circ\text{C}$  to  $+150^\circ\text{C}$ ,  $V_{IN} = 13.5\text{ V}$ ,  $I_{OUT} = 100\ \mu\text{A}$ ,  $C_{OUT} = 2.2\ \mu\text{F}$ ,  $1\ \text{m}\Omega < C_{OUT}\ \text{ESR} < 2\ \Omega$ ,  $C_{IN} = 1\ \mu\text{F}$ , and  $V_{EN} = 2\ \text{V}$  (unless otherwise noted)

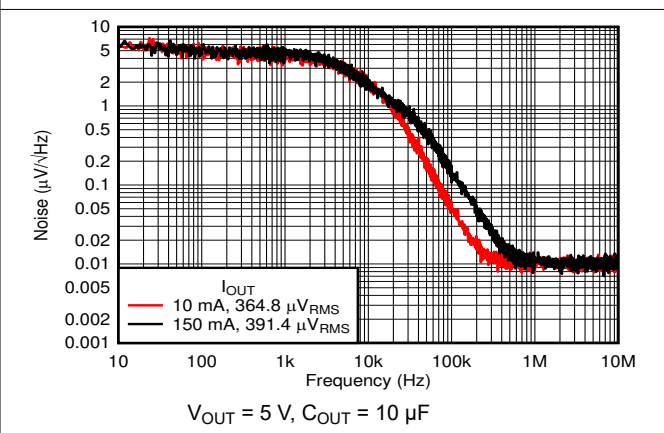
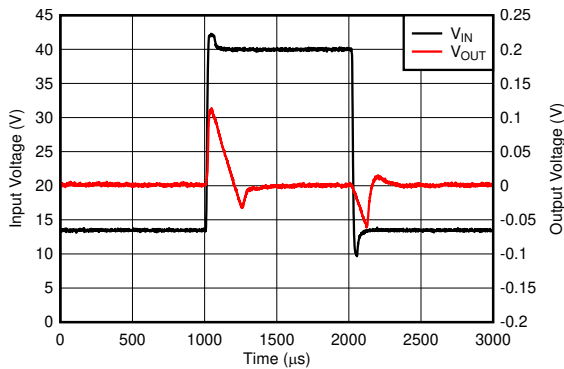

$V_{OUT} = 5\ \text{V}$ ,  $I_{OUT} = 1\ \text{mA}$ ,  $V_{IN} = 13.5\ \text{V}$  to  $40\ \text{V}$ ,  
slew rate =  $2.7\ \text{V}/\mu\text{s}$ ,  $V_{EN} = 3.3\ \text{V}$ ,  $C_{OUT} = 10\ \mu\text{F}$

图 6-13. Line Transients at 13.5 V to 40 V

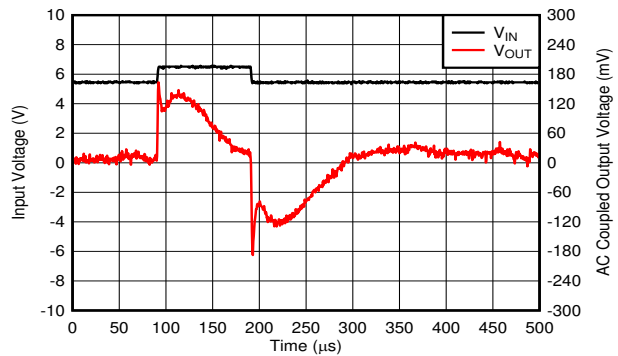

$V_{OUT} = 5\ \text{V}$ ,  $V_{IN} = 5.5\ \text{V}$  to  $6.5\ \text{V}$ ,  $t_{\text{rise}} = 1\ \mu\text{s}$ ,  $C_{OUT} = 10\ \mu\text{F}$

图 6-14. Line Transients at 5.5 V to 6.5 V

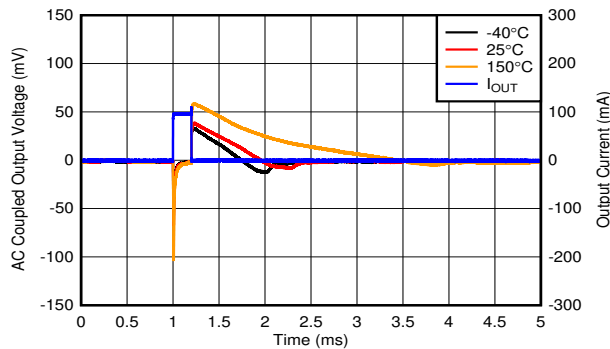

$V_{OUT} = 5\ \text{V}$ ,  $I_{OUT} = 0\ \text{mA}$  to  $100\ \text{mA}$ , slew rate =  $1\ \text{A}/\mu\text{s}$ ,  
 $V_{EN} = 3.3\ \text{V}$ ,  $C_{OUT} = 10\ \mu\text{F}$

图 6-15. Load Transient, No Load to 100 mA

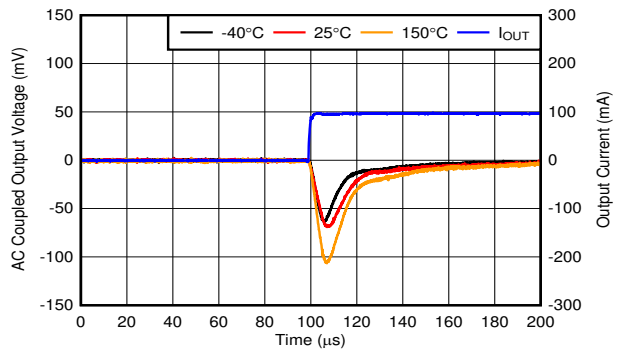

$V_{OUT} = 5\ \text{V}$ ,  $I_{OUT} = 0\ \text{mA}$  to  $100\ \text{mA}$ , slew rate =  $1\ \text{A}/\mu\text{s}$ ,  
 $V_{EN} = 3.3\ \text{V}$ ,  $C_{OUT} = 10\ \mu\text{F}$

图 6-16. Load Transient, No Load to 100-mA Rising Edge

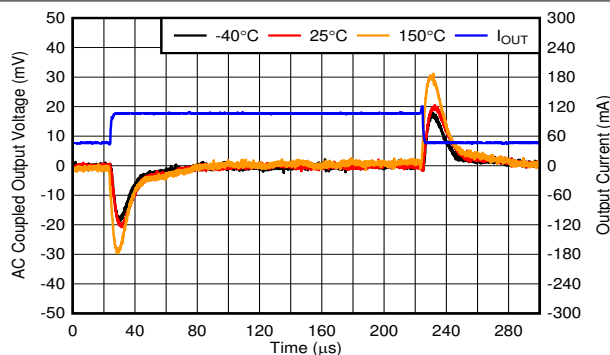

$V_{OUT} = 5\ \text{V}$ ,  $I_{OUT} = 45\ \text{mA}$  to  $105\ \text{mA}$ , slew rate =  $0.1\ \text{A}/\mu\text{s}$ ,  
 $V_{EN} = 3.3\ \text{V}$ ,  $C_{OUT} = 10\ \mu\text{F}$

图 6-17. Load Transient, 45 mA to 105 mA

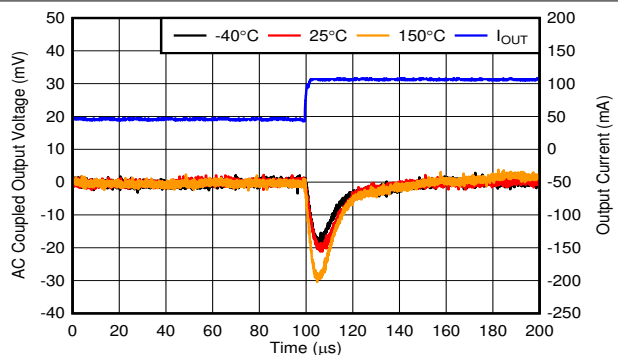

$V_{OUT} = 5\ \text{V}$ ,  $I_{OUT} = 45\ \text{mA}$  to  $105\ \text{mA}$ , slew rate =  $0.1\ \text{A}/\mu\text{s}$ ,  
 $V_{EN} = 3.3\ \text{V}$ ,  $C_{OUT} = 10\ \mu\text{F}$

图 6-18. Load Transient, 45-mA to 105-mA Rising Edge

### 6.6 Typical Characteristics (continued)

specified at  $T_J = -40^\circ\text{C}$  to  $+150^\circ\text{C}$ ,  $V_{IN} = 13.5\text{ V}$ ,  $I_{OUT} = 100\ \mu\text{A}$ ,  $C_{OUT} = 2.2\ \mu\text{F}$ ,  $1\ \text{m}\Omega < C_{OUT}\ \text{ESR} < 2\ \Omega$ ,  $C_{IN} = 1\ \mu\text{F}$ , and  $V_{EN} = 2\ \text{V}$  (unless otherwise noted)

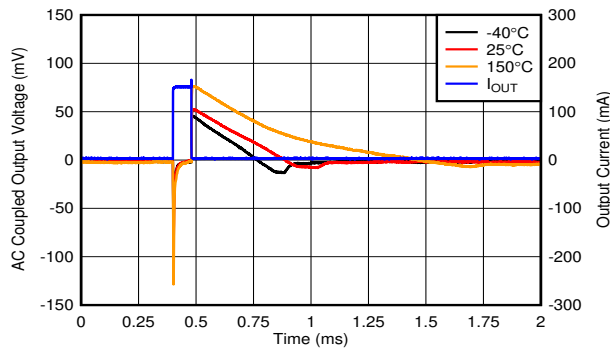

$V_{OUT} = 5\ \text{V}$ ,  $I_{OUT} = 0\ \text{mA}$  to  $150\ \text{mA}$ , slew rate =  $1\ \text{A}/\mu\text{s}$ ,  $V_{EN} = 3.3\ \text{V}$ ,  $C_{OUT} = 10\ \mu\text{F}$

图 6-19. Load Transient, No Load to 150 mA

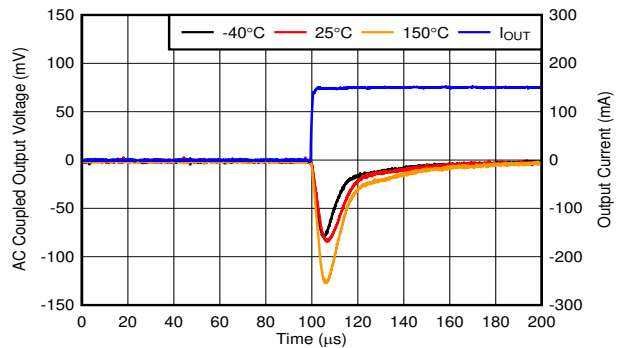

$V_{OUT} = 5\ \text{V}$ ,  $I_{OUT} = 0\ \text{mA}$  to  $150\ \text{mA}$ , slew rate =  $1\ \text{A}/\mu\text{s}$ ,  $V_{EN} = 3.3\ \text{V}$ ,  $C_{OUT} = 10\ \mu\text{F}$

图 6-20. Load Transient, No Load to 150-mA Rising Edge

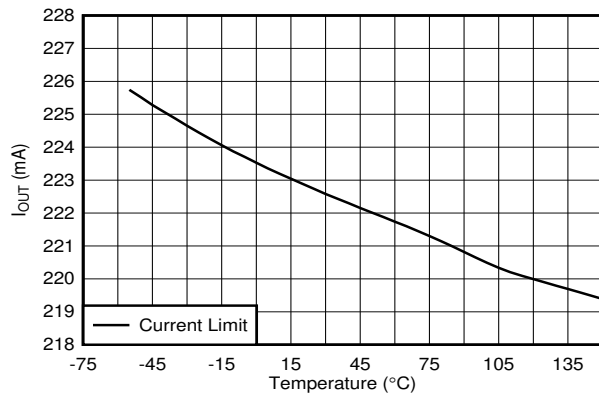

$V_{IN} = V_{OUT} + 1\ \text{V}$ ,  $V_{OUT} = 90\% \times V_{OUT(NOM)}$

图 6-21. Output Current Limit vs Temperature

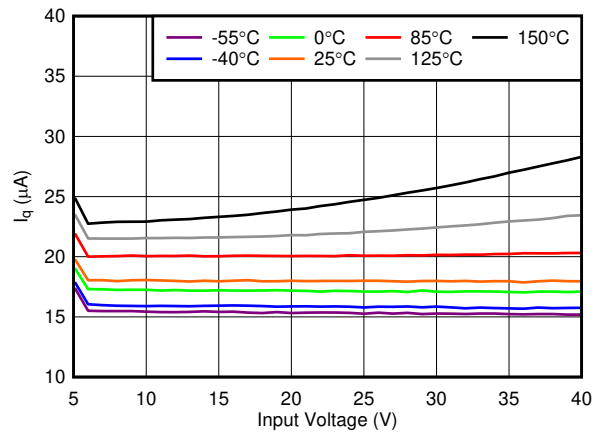

$V_{OUT} = 5\ \text{V}$

图 6-22. Quiescent Current ( $I_Q$ ) vs  $V_{IN}$

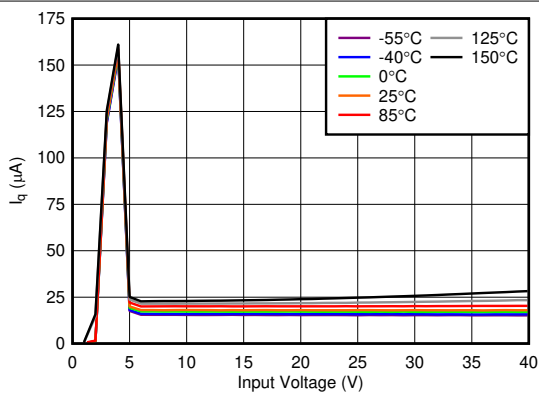

$V_{OUT} = 5\ \text{V}$

图 6-23. Quiescent Current ( $I_Q$ ) vs  $V_{IN}$



图 6-24. Ground Current ( $I_{GND}$ ) vs  $I_{OUT}$

### 6.6 Typical Characteristics (continued)

specified at  $T_J = -40^{\circ}\text{C}$  to  $+150^{\circ}\text{C}$ ,  $V_{IN} = 13.5\text{ V}$ ,  $I_{OUT} = 100\ \mu\text{A}$ ,  $C_{OUT} = 2.2\ \mu\text{F}$ ,  $1\ \text{m}\Omega < C_{OUT}\ \text{ESR} < 2\ \Omega$ ,  $C_{IN} = 1\ \mu\text{F}$ , and  $V_{EN} = 2\ \text{V}$  (unless otherwise noted)

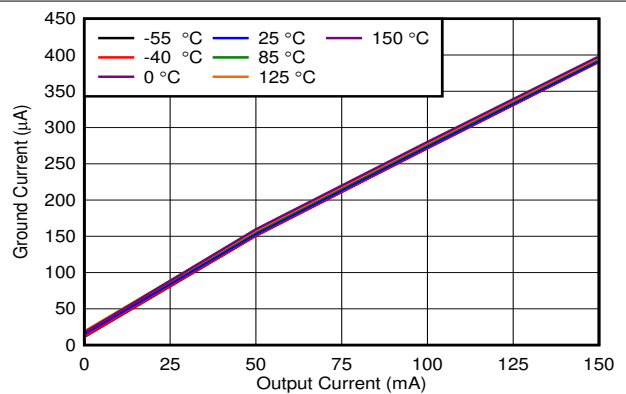
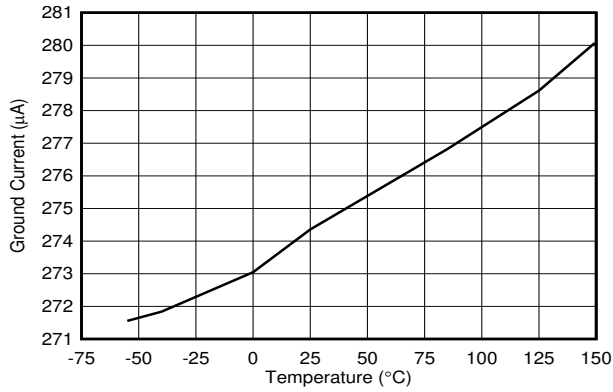

$I_{OUT} = 100\ \text{mA}$   
**图 6-25. Ground Current**

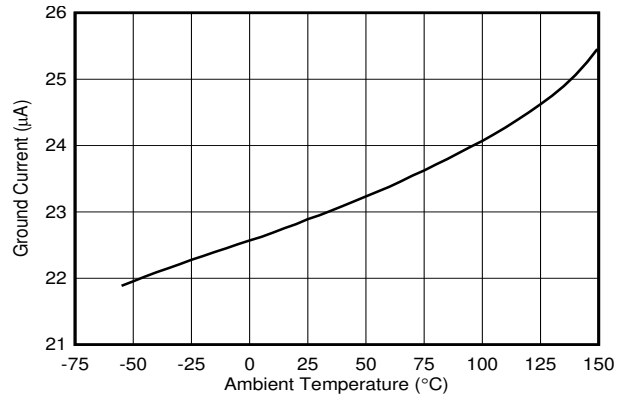

$I_{OUT} = 500\ \mu\text{A}$   
**图 6-26. Ground Current**

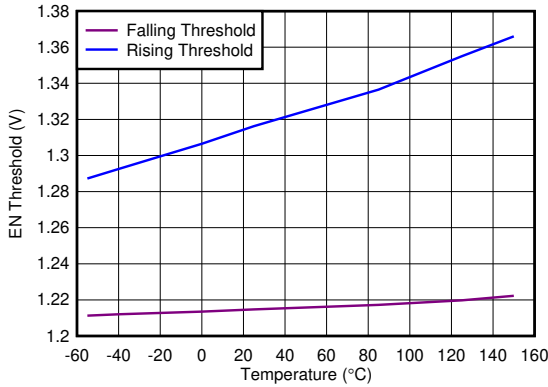

**图 6-27. EN Threshold vs Temperature**

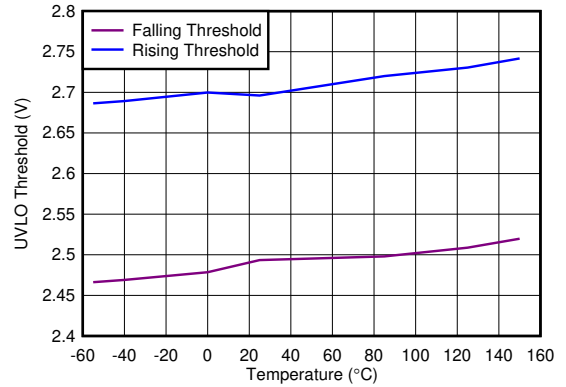

**图 6-28. Undervoltage Lockout (UVLO) Threshold vs Temperature**

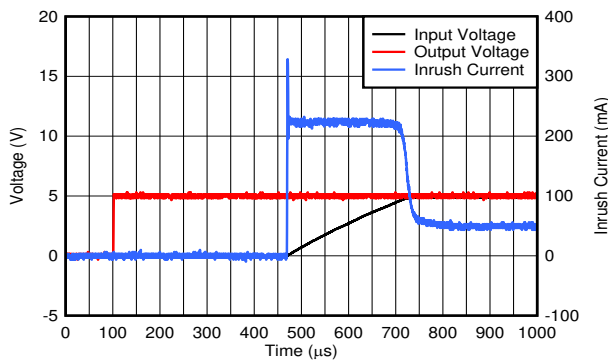

$V_{IN} = 13.5\ \text{V}$ ,  $C_{OUT} = 10\ \mu\text{F}$   
**图 6-29. Startup Plot With EN**

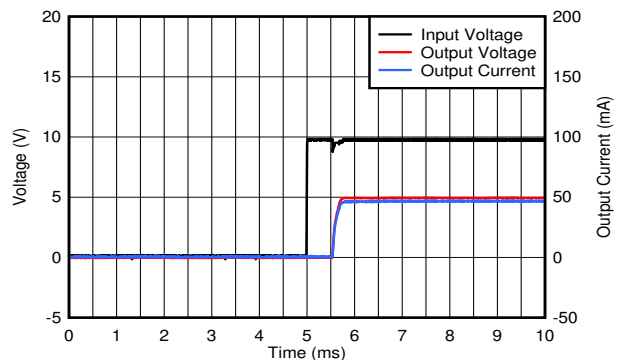

$C_{OUT} = 10\ \mu\text{F}$   
**图 6-30. Startup Plot**

### 6.6 Typical Characteristics (continued)

specified at  $T_J = -40^{\circ}\text{C}$  to  $+150^{\circ}\text{C}$ ,  $V_{IN} = 13.5\text{ V}$ ,  $I_{OUT} = 100\ \mu\text{A}$ ,  $C_{OUT} = 2.2\ \mu\text{F}$ ,  $1\ \text{m}\Omega < C_{OUT}\ \text{ESR} < 2\ \Omega$ ,  $C_{IN} = 1\ \mu\text{F}$ , and  $V_{EN} = 2\ \text{V}$  (unless otherwise noted)



图 6-31. Output Voltage vs Injected Current



图 6-32. Thermal Shutdown

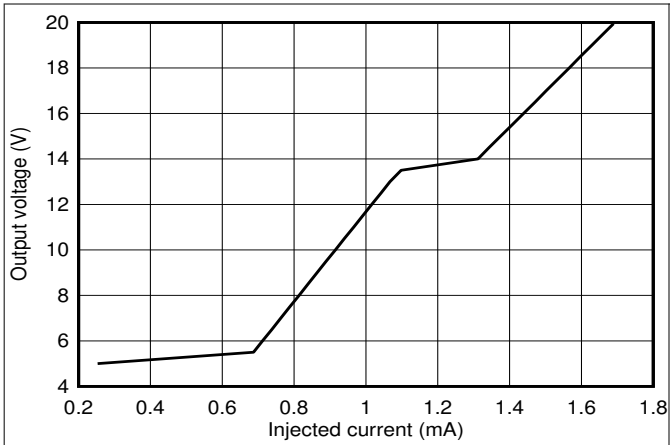

图 6-33. Stability ESR vs  $C_{OUT}$

## 7 Detailed Description

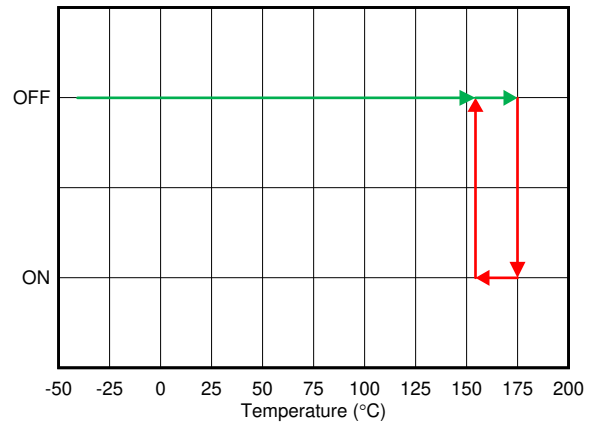
### 7.1 Overview

The TPS7B84-Q1 is a low-dropout linear regulator (LDO) designed to connect to the battery in automotive applications. The device has an input voltage range extending to 40 V, which allows the device to withstand transients (such as load dumps) that are anticipated in automotive systems. With only a 18- $\mu$ A quiescent current at light loads, the device is an optimal solution for powering always-on components.

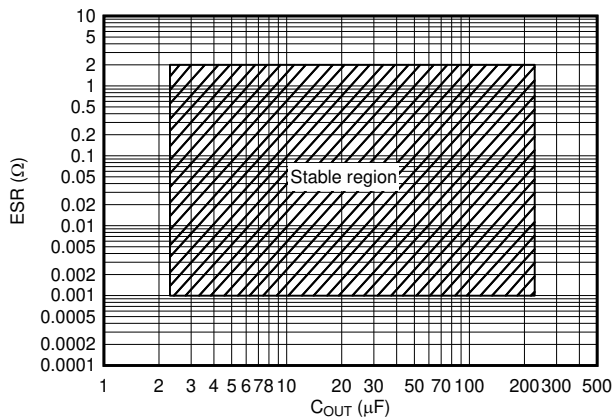
The device has a state-of-the-art transient response that allows the output to quickly react to changes in the load or line (for example, during cold-crank conditions). Additionally, the device has a novel architecture that minimizes output overshoot when recovering from dropout. During normal operation, the device has a tight DC accuracy of  $\pm 0.75\%$  over line, load, and temperature.

### 7.2 Functional Block Diagrams



图 7-1. Adjustable Output Block Diagram



图 7-2. Fixed Output Block Diagram

## 7.3 Feature Description

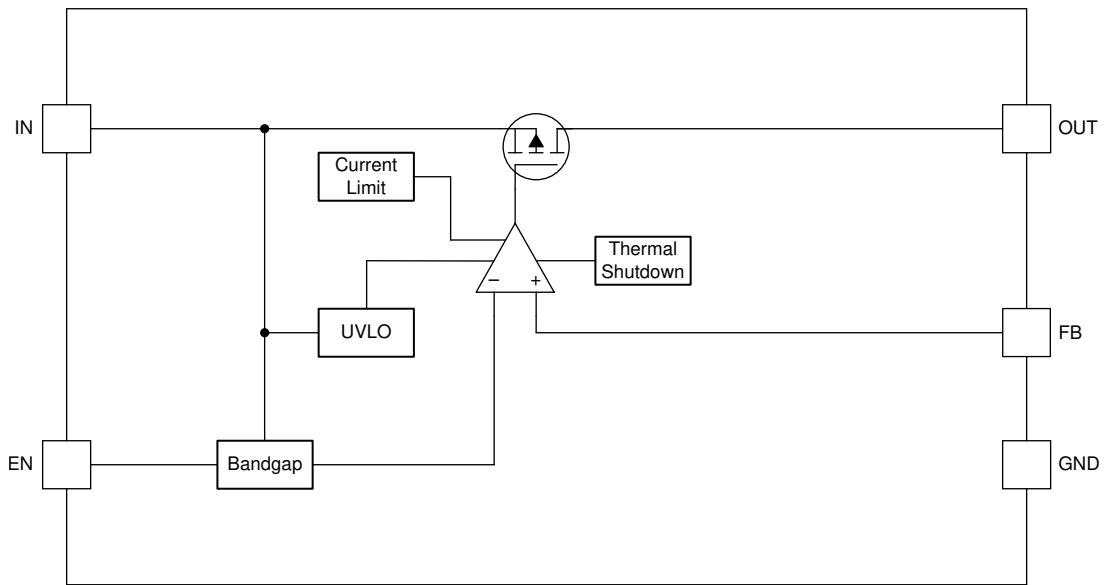
### 7.3.1 Enable (EN)

The enable pin for the device is an active-high pin. The output voltage is enabled when the voltage of the enable pin is greater than the high-level input voltage of the EN pin and disabled with the enable pin voltage is less than the low-level input voltage of the EN pin. If independent control of the output voltage is not needed, connect the enable pin to the input of the device.

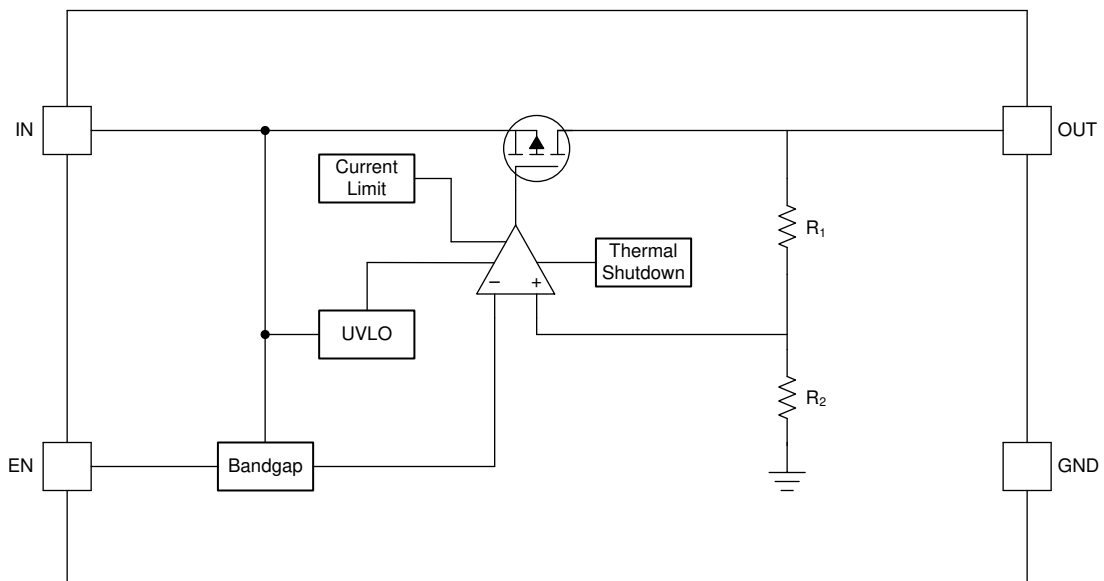
### 7.3.2 Undervoltage Lockout

The device has an independent undervoltage lockout (UVLO) circuit that monitors the input voltage, allowing a controlled and consistent turn on and off of the output voltage. To prevent the device from turning off if the input drops during turn on, the UVLO has hysteresis as specified in the *Electrical Characteristics* table.

### 7.3.3 Thermal Shutdown

The device contains a thermal shutdown protection circuit to disable the device when the junction temperature ( $T_J$ ) of the pass transistor rises to  $T_{SD(\text{shutdown})}$  (typical). Thermal shutdown hysteresis assures that the device resets (turns on) when the temperature falls to  $T_{SD(\text{reset})}$  (typical).

The thermal time-constant of the semiconductor die is fairly short, thus the device may cycle on and off when thermal shutdown is reached until power dissipation is reduced. Power dissipation during startup can be high from large  $V_{IN} - V_{OUT}$  voltage drops across the device or from high inrush currents charging large output capacitors. Under some conditions, the thermal shutdown protection disables the device before startup completes.

For reliable operation, limit the junction temperature to the maximum listed in the *Recommended Operating Conditions* table. Operation above this maximum temperature causes the device to exceed its operational specifications. Although the internal protection circuitry of the device is designed to protect against thermal overall conditions, this circuitry is not intended to replace proper heat sinking. Continuously running the device into thermal shutdown or above the maximum recommended junction temperature reduces long-term reliability.

### 7.3.4 Current Limit

The device has an internal current limit circuit that protects the regulator during transient high-load current faults or shorting events. The current limit is a brickwall scheme. In a high-load current fault, the brickwall scheme limits the output current to the current limit ( $I_{CL}$ ).  $I_{CL}$  is listed in the *Electrical Characteristics* table.

The output voltage is not regulated when the device is in current limit. When a current limit event occurs, the device begins to heat up because of the increase in power dissipation. When the device is in brickwall current limit, the pass transistor dissipates power  $[(V_{IN} - V_{OUT}) \times I_{CL}]$ . If thermal shutdown is triggered, the device turns off. After the device cools down, the internal thermal shutdown circuit turns the device back on. If the output current fault condition continues, the device cycles between current limit and thermal shutdown. For more information on current limits, see the [Know Your Limits application report](#).

图 7-3 shows a diagram of the current limit.



图 7-3. Current Limit

## 7.4 Device Functional Modes

### 7.4.1 Device Functional Mode Comparison

The *Device Functional Mode Comparison* table shows the conditions that lead to the different modes of operation. See the *Electrical Characteristics* table for parameter values.

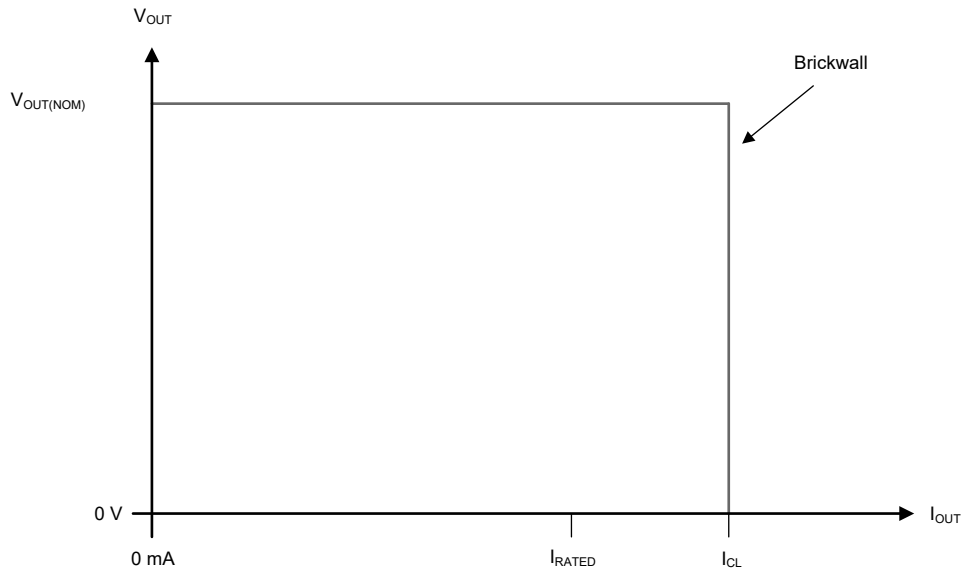
表 7-1. Device Functional Mode Comparison

OPERATING MODE	PARAMETER			
	$V_{IN}$	$V_{EN}$	$I_{OUT}$	$T_J$
Normal operation	$V_{IN} > V_{OUT(nom)} + V_{DO}$ and $V_{IN} > V_{IN(min)}$	$V_{EN} > V_{EN(HI)}$	$I_{OUT} < I_{OUT(max)}$	$T_J < T_{SD(shutdown)}$
Dropout operation	$V_{IN(min)} < V_{IN} < V_{OUT(nom)} + V_{DO}$	$V_{EN} > V_{EN(HI)}$	$I_{OUT} < I_{OUT(max)}$	$T_J < T_{SD(shutdown)}$
Disabled (any true condition disables the device)	$V_{IN} < V_{UVLO}$	$V_{EN} < V_{EN(LOW)}$	Not applicable	$T_J > T_{SD(shutdown)}$

### 7.4.2 Normal Operation

The device regulates to the nominal output voltage when the following conditions are met:

- The input voltage is greater than the nominal output voltage plus the dropout voltage ( $V_{OUT(nom)} + V_{DO}$ )
- The output current is less than the current limit ( $I_{OUT} < I_{CL}$ )
- The device junction temperature is less than the thermal shutdown temperature ( $T_J < T_{SD}$ )
- The enable voltage has previously exceeded the enable rising threshold voltage and has not yet decreased to less than the enable falling threshold

### 7.4.3 Dropout Operation

If the input voltage is lower than the nominal output voltage plus the specified dropout voltage, but all other conditions are met for normal operation, the device operates in dropout mode. In this mode, the output voltage tracks the input voltage. During this mode, the transient performance of the device becomes significantly degraded because the pass transistor is in the ohmic or triode region, and acts as a switch. Line or load transients in dropout can result in large output-voltage deviations.

When the device is in a steady dropout state (defined as when the device is in dropout,  $V_{IN} < V_{OUT(NOM)} + V_{DO}$ , directly after being in a normal regulation state, but *not* during startup), the pass transistor is driven into the ohmic or triode region. When the input voltage returns to a value greater than or equal to the nominal output voltage plus the dropout voltage ( $V_{OUT(NOM)} + V_{DO}$ ), the output voltage can overshoot for a short period of time while the device pulls the pass transistor back into the linear region.

### 7.4.4 Disabled

The output of the device can be shutdown by forcing the voltage of the enable pin to less than the maximum EN pin low-level input voltage (see the *Electrical Characteristics* table). When disabled, the pass transistor is turned off, internal circuits are shutdown, and the output voltage is actively discharged to ground by an internal discharge circuit from the output to ground.



## 8 Application and Implementation

### Note

以下应用部分的信息不属于 TI 组件规范，TI 不担保其准确性和完整性。客户应负责确定 TI 组件是否适用于其应用。客户应验证并测试其设计，以确保系统功能。

### 8.1 Application Information

#### 8.1.1 Input and Output Capacitor Selection

The TPS7B84-Q1 requires an output capacitor of 2.2  $\mu\text{F}$  or larger (1  $\mu\text{F}$  or larger capacitance) for stability and an equivalent series resistance (ESR) between 0.001  $\Omega$  and 2  $\Omega$ . For the best transient performance, use X5R- and X7R-type ceramic capacitors because these capacitors have minimal variation in value and ESR over temperature. When choosing a capacitor for a specific application, be mindful of the DC bias characteristics for the capacitor. Higher output voltages cause a significant derating of the capacitor. For best performance, the maximum recommended output capacitance is 220  $\mu\text{F}$ .

Although an input capacitor is not required for stability, good analog design practice is to connect a capacitor from IN to GND. Some input supplies have a high impedance, thus placing the input capacitor on the input supply helps reduce the input impedance. This capacitor counteracts reactive input sources and improves transient response, input ripple, and PSRR. If the input supply has a high impedance over a large range of frequencies, several input capacitors can be used in parallel to lower the impedance over frequency. Use a higher-value capacitor if large, fast, rise-time load transients are anticipated, or if the device is located several inches from the input power source.

#### 8.1.2 Adjustable Device Feedback Resistor Selection

The adjustable-version device requires external feedback divider resistors to set the output voltage.  $V_{\text{OUT}}$  is set using the feedback divider resistors,  $R_1$  and  $R_2$ , according to the following equation:

$$V_{\text{OUT}} = V_{\text{FB}} \times (1 + R_1 / R_2) \quad (1)$$

To ignore the FB pin current error term in the  $V_{\text{OUT}}$  equation, set the feedback divider current to 100x the FB pin current listed in the *Electrical Characteristics* table. This setting provides the maximum feedback divider series resistance, as shown in the following equation:

$$R_1 + R_2 \leq V_{\text{OUT}} / (I_{\text{FB}} \times 100) \quad (2)$$

#### 8.1.3 Feed-Forward Capacitor ( $C_{\text{FF}}$ )

For the adjustable-voltage version device, a feed-forward capacitor ( $C_{\text{FF}}$ ) can be connected from the OUT pin to the FB pin.  $C_{\text{FF}}$  improves transient, noise, and PSRR performance, but is not required for regulator stability. Recommended  $C_{\text{FF}}$  values are listed in the *Recommended Operating Conditions* table. A higher capacitance  $C_{\text{FF}}$  can be used; however, the startup time increases. For a detailed description of  $C_{\text{FF}}$  tradeoffs, see the [Pros and Cons of Using a Feedforward Capacitor with a Low-Dropout Regulator application report](#).

$C_{\text{FF}}$  and  $R_1$  form a zero in the loop gain at frequency  $f_z$ , while  $C_{\text{FF}}$ ,  $R_1$ , and  $R_2$  form a pole in the loop gain at frequency  $f_p$ .  $C_{\text{FF}}$  zero and pole frequencies can be calculated from the following equations:

$$f_z = 1 / (2 \times \pi \times C_{\text{FF}} \times R_1) \quad (3)$$

$$f_p = 1 / (2 \times \pi \times C_{\text{FF}} \times (R_1 \parallel R_2)) \quad (4)$$

### 8.1.4 Dropout Voltage

Dropout voltage ( $V_{DO}$ ) is defined as the input voltage minus the output voltage ( $V_{IN} - V_{OUT}$ ) at the rated output current ( $I_{RATED}$ ), where the pass transistor is fully on.  $I_{RATED}$  is the maximum  $I_{OUT}$  listed in the *Recommended Operating Conditions* table. The pass transistor is in the ohmic or triode region of operation, and acts as a switch. The dropout voltage indirectly specifies a minimum input voltage greater than the nominal programmed output voltage at which the output voltage is expected to stay in regulation. If the input voltage falls to less than the nominal output regulation, then the output voltage falls as well.

For a CMOS regulator, the dropout voltage is determined by the drain-source on-state resistance ( $R_{DS(ON)}$ ) of the pass transistor. Therefore, if the linear regulator operates at less than the rated current, the dropout voltage for that current scales accordingly. The following equation calculates the  $R_{DS(ON)}$  of the device.

$$R_{DS(ON)} = \frac{V_{DO}}{I_{RATED}} \quad (5)$$

### 8.1.5 Reverse Current

Excessive reverse current can damage this device. Reverse current flows through the intrinsic body diode of the pass transistor instead of the normal conducting channel. At high magnitudes, this current flow degrades the long-term reliability of the device.

Conditions where reverse current can occur are outlined in this section, all of which can exceed the absolute maximum rating of  $V_{OUT} \leq V_{IN} + 0.3 \text{ V}$ .

- If the device has a large  $C_{OUT}$  and the input supply collapses with little or no load current
- The output is biased when the input supply is not established
- The output is biased above the input supply

If reverse current flow is expected in the application, external protection is recommended to protect the device. Reverse current is not limited in the device, so external limiting is required if extended reverse voltage operation is anticipated.

### 8.1.6 Power Dissipation ( $P_D$ )

Circuit reliability requires consideration of the device power dissipation, location of the circuit on the printed circuit board (PCB), and correct sizing of the thermal plane. The PCB area around the regulator must have few or no other heat-generating devices that cause added thermal stress.

To first-order approximation, power dissipation in the regulator depends on the input-to-output voltage difference and load conditions. The following equation calculates power dissipation ( $P_D$ ).

$$P_D = (V_{IN} - V_{OUT}) \times I_{OUT} \quad (6)$$

---

#### Note

Power dissipation can be minimized, and therefore greater efficiency can be achieved, by correct selection of the system voltage rails. For the lowest power dissipation use the minimum input voltage required for correct output regulation.

---

For devices with a thermal pad, the primary heat conduction path for the device package is through the thermal pad to the PCB. Solder the thermal pad to a copper pad area under the device. This pad area must contain an array of plated vias that conduct heat to additional copper planes for increased heat dissipation.

The maximum power dissipation determines the maximum allowable ambient temperature ( $T_A$ ) for the device. According to the following equation, power dissipation and junction temperature are most often related by the junction-to-ambient thermal resistance ( $R_{\theta JA}$ ) of the combined PCB and device package and the temperature of the ambient air ( $T_A$ ).

$$T_J = T_A + (R_{\theta JA} \times P_D) \quad (7)$$

Thermal resistance ( $R_{\theta JA}$ ) is highly dependent on the heat-spreading capability built into the particular PCB design, and therefore varies according to the total copper area, copper weight, and location of the planes. The junction-to-ambient thermal resistance listed in the *Thermal Information* table is determined by the JEDEC standard PCB and copper-spreading area, and is used as a relative measure of package thermal performance.

### 8.1.6.1 Thermal Performance Versus Copper Area

The most used thermal resistance parameter,  $R_{\theta JA}$ , is highly dependent on the heat-spreading capability built into the particular PCB design, and therefore varies according to the total copper area, copper weight, and location of the planes. The  $R_{\theta JA}$  recorded in the *Thermal Information* table in the *Specifications* section is determined by the JEDEC standard (see [Figure 8-1](#)), PCB, and copper-spreading area, and is only used as a relative measure of package thermal performance. For a well-designed thermal layout,  $R_{\theta JA}$  is actually the sum of the package junction-to-case (bottom) thermal resistance ( $R_{\theta JCbott}$ ) plus the thermal resistance contribution by the PCB copper.



图 8-1. JEDEC Standard 2s2p PCB

图 8-2 through 图 8-4 depict the functions of  $R_{\theta JA}$  and  $\psi_{JB}$  versus copper area and thickness. These plots are generated with a 101.6-mm x 101.6-mm x 1.6-mm PCB of two and four layers. For the four-layer board, the inner planes use a 1-oz copper thickness. Outer layers are simulated with both a 1-oz and 2-oz copper thickness. A 4 x 4 array of thermal vias of 300-μm drill diameter and 25-μm Cu plating is located beneath the thermal pad of the device. The thermal vias connect the top layer, the bottom layer and, in the case of the 4-layer board, the first inner GND plane. Each of the layers has a copper plane of equal area.



8-2.  $R_{\theta JA}$  vs Copper Area 2s2p DRB Package

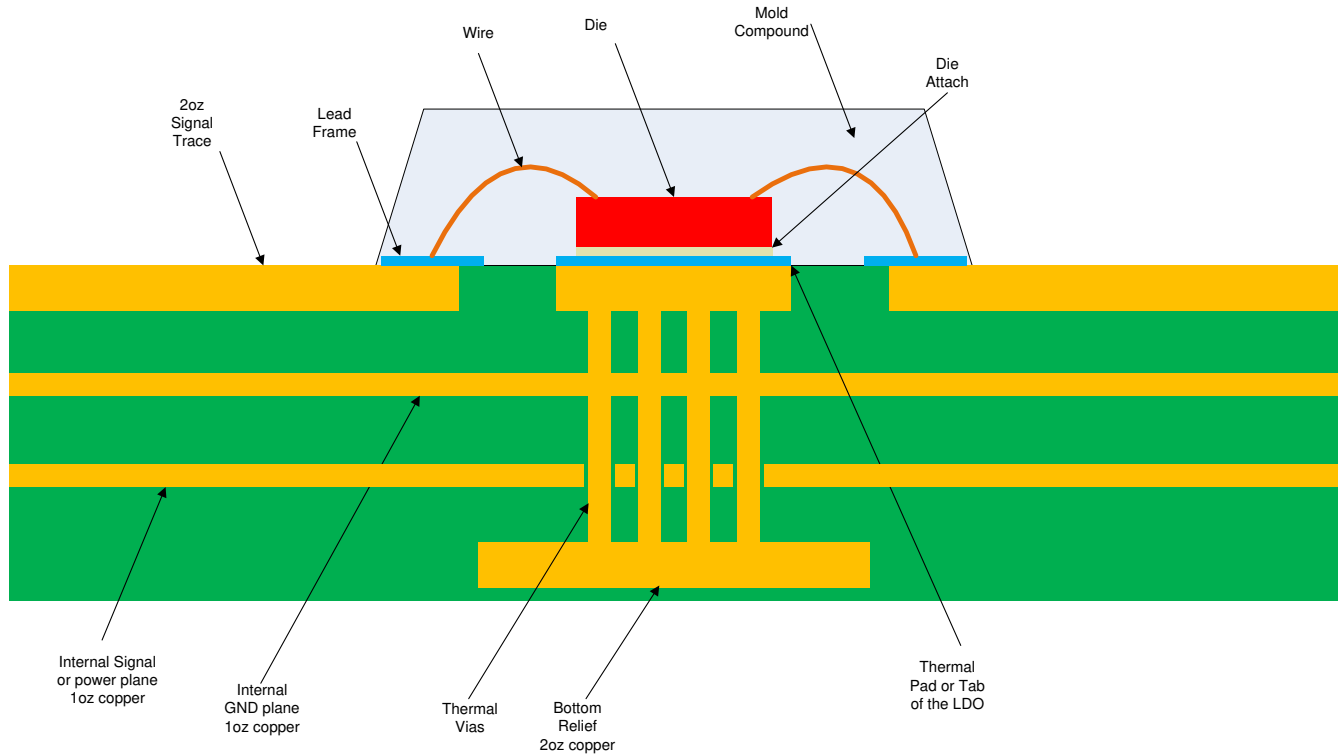
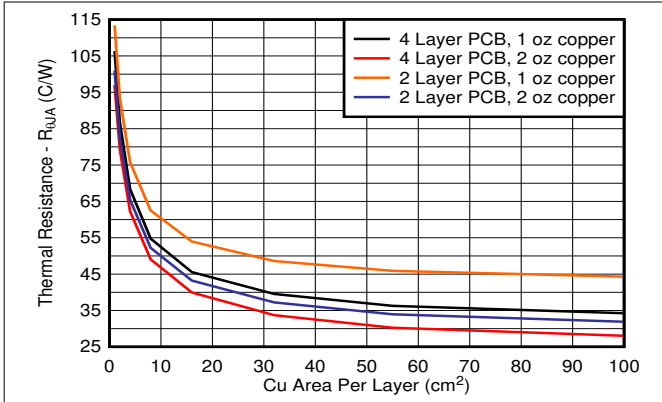
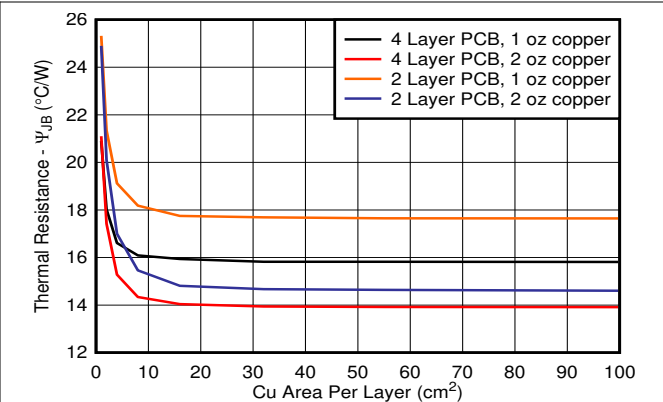

8-3.  $\Psi_{JB}$  vs Copper Area 2s2p DRB Package

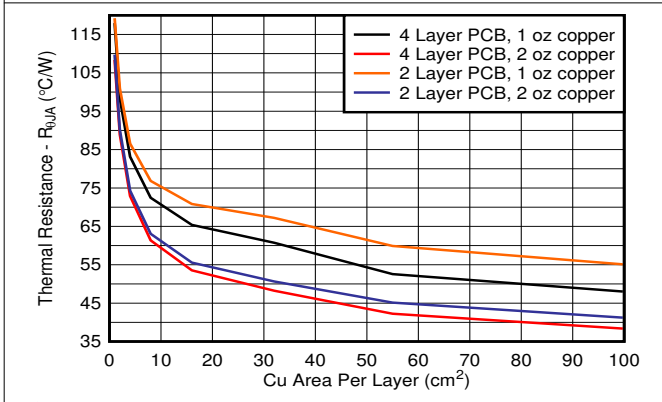

8-4.  $R_{\theta JA}$  vs Copper Area 2s2p DCY Package

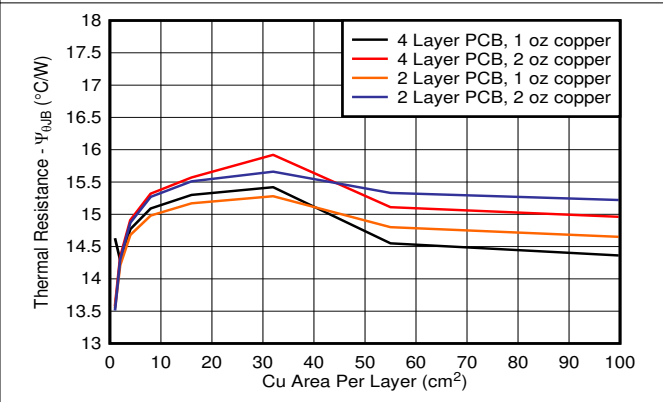

8-5.  $\Psi_{JB}$  vs Copper Area 2s2p DCY Package

8.1.6.2 Power Dissipation vs Ambient Temperature

8-6 is based off of a JESD51-7 4 layer high-K board. The allowable power dissipation was estimated using the following equation. As discussed in the *An empirical analysis of the impact of board layout on LDO thermal performance application report*, thermal dissipation can be improved in the JEDEC high-K layout by adding top layer copper and increasing the number of thermal vias. If a good thermal layout is used, the allowable thermal dissipation can be improved by up to 50%.

$$T_A + R_{\theta JA} \times P_D \leq 150 \text{ }^\circ\text{C} \tag{8}$$

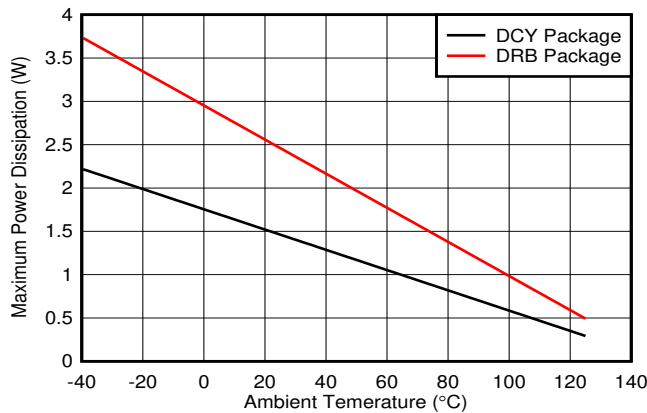

8-6. TPS7B84-Q1 Allowable Power Dissipation

### 8.1.7 Estimating Junction Temperature

The JEDEC standard now recommends the use of psi ( $\Psi$ ) thermal metrics to estimate the junction temperatures of the linear regulator when in-circuit on a typical PCB board application. These metrics are not thermal resistance parameters and instead offer a practical and relative way to estimate junction temperature. These psi metrics are determined to be significantly independent of the copper area available for heat-spreading. The *Thermal Information* table lists the primary thermal metrics, which are the junction-to-top characterization parameter ( $\psi_{JT}$ ) and junction-to-board characterization parameter ( $\psi_{JB}$ ). These parameters provide two methods for calculating the junction temperature ( $T_J$ ), as described in the following equations. Use the junction-to-top characterization parameter ( $\psi_{JT}$ ) with the temperature at the center-top of device package ( $T_T$ ) to calculate the junction temperature. Use the junction-to-board characterization parameter ( $\psi_{JB}$ ) with the PCB surface temperature 1 mm from the device package ( $T_B$ ) to calculate the junction temperature.

$$T_J = T_T + \psi_{JT} \times P_D \quad (9)$$

where:

- $P_D$  is the dissipated power
- $T_T$  is the temperature at the center-top of the device package

$$T_J = T_B + \psi_{JB} \times P_D \quad (10)$$

where

- $T_B$  is the PCB surface temperature measured 1 mm from the device package and centered on the package edge

For detailed information on the thermal metrics and how to use them, see the [Semiconductor and IC Package Thermal Metrics application report](#).

## 8.2 Typical Application

图 8-7 shows a typical application circuit for the TPS7B84-Q1. Use different values of external components, depending on the end application. An application may require a larger output capacitor during fast load steps in order to prevent a reset from occurring. TI recommends a low-ESR ceramic capacitor with a dielectric of type X5R or X7R.



图 8-7. Typical Application Schematic for the TPS7B84-Q1

### 8.2.1 Design Requirements

For this design example, use the parameters listed in 表 8-1 as the input parameters.

表 8-1. Design Parameters

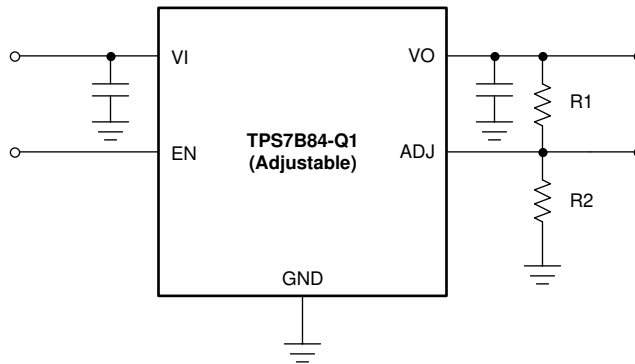
DESIGN PARAMETER	EXAMPLE VALUE
Input voltage range	6 V to 40 V
Output voltage	5 V
Output current	100 mA
Output capacitor	10 $\mu$ F

### 8.2.2 Detailed Design Procedure

#### 8.2.2.1 Input Capacitor

The device requires an input decoupling capacitor, the value of which depends on the application. The typical recommended value for the decoupling capacitor is 1  $\mu$ F. The voltage rating must be greater than the maximum input voltage.

#### 8.2.2.2 Output Capacitor

The device requires an output capacitor to stabilize the output voltage. The capacitor value must be between 2.2  $\mu$ F and 200  $\mu$ F and the ESR range must be between 1 m $\Omega$  and 2  $\Omega$ . For this design a low ESR, 10- $\mu$ F ceramic capacitor was used to improve transient performance.

### 8.2.3 Application Curves

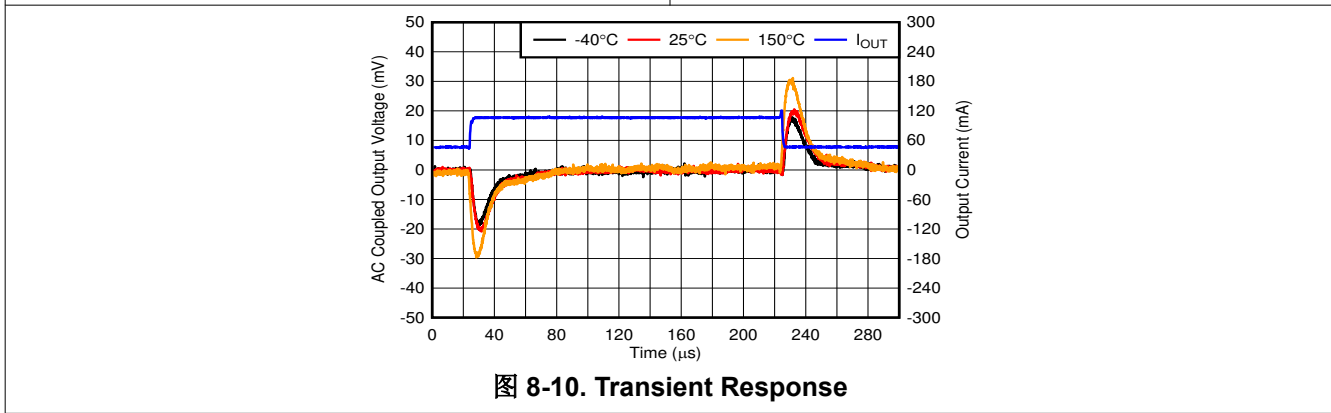
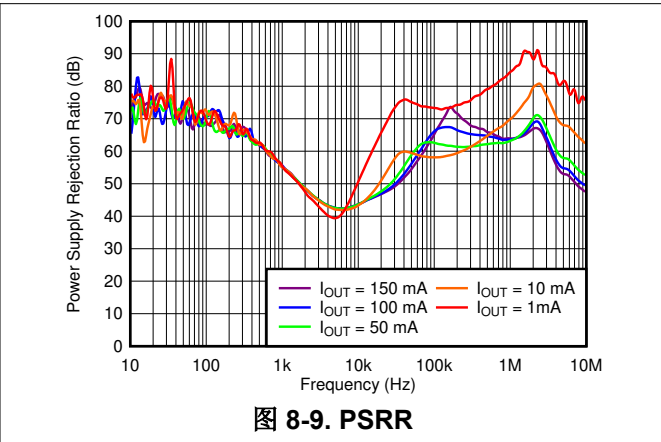
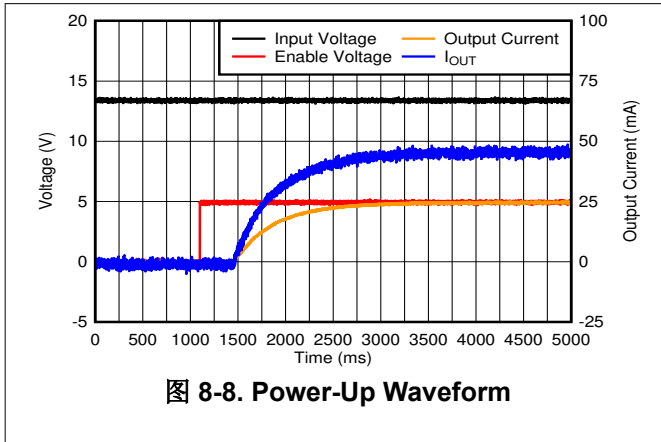

## 9 Power Supply Recommendations

This device is designed for operation from an input voltage supply with a range between 3 V and 40 V. This input supply must be well regulated. If the input supply is located more than a few inches from the TPS7B84-Q1, add an electrolytic capacitor and a ceramic bypass capacitor at the input.

## 10 Layout

### 10.1 Layout Guidelines

For best overall performance, place all circuit components on the same side of the circuit board and as near as practical to the respective LDO pin connections. Place ground return connections to the input and output capacitor, and to the LDO ground pin as close as possible to each other, connected by a wide, component-side, copper surface. The use of vias and long traces to the input and output capacitors is strongly discouraged and negatively affects system performance. TI also recommends a ground reference plane either embedded in the PCB itself or located on the bottom side of the PCB opposite the components. This reference plane serves to assure accuracy of the output voltage, shield noise, and behaves similarly to a thermal plane to spread (or sink) heat from the LDO device when connected to the thermal pad. In most applications, this ground plane is necessary to meet thermal requirements.

#### 10.1.1 Package Mounting

Solder pad footprint recommendations for the TPS7B84-Q1 are available at the end of this document and at [www.ti.com](http://www.ti.com).

#### 10.1.2 Board Layout Recommendations to Improve PSRR and Noise Performance

As depicted in [Figure 10-1](#) and [Figure 10-2](#), place the input and output capacitors close to the device for the layout of the TPS7B84-Q1. In order to enhance the thermal performance, place as many vias as possible around the device. These vias improve the heat transfer between the different GND planes in the PCB.

To improve ac performance such as PSRR, output noise, and transient response, TI recommends a board design with separate ground planes for IN and OUT, with each ground plane connected only at the GND pin of the device. In addition, the ground connection for the output capacitor must connect directly to the GND pin of the device.

Minimize equivalent series inductance (ESL) and ESR in order to maximize performance and ensure stability. Place each capacitor as close as possible to the device and on the same side of the PCB as the regulator itself.

Do not place any of the capacitors on the opposite side of the PCB from where the regulator is installed. TI strongly discourages the use of vias and long traces to connect the capacitors because these can negatively impact system performance and may even cause instability.

If possible, and to ensure the maximum performance specified in this document, use the same layout pattern used for the TPS7B84-Q1 evaluation board, available at [www.ti.com](http://www.ti.com).



## 10.2 Layout Examples

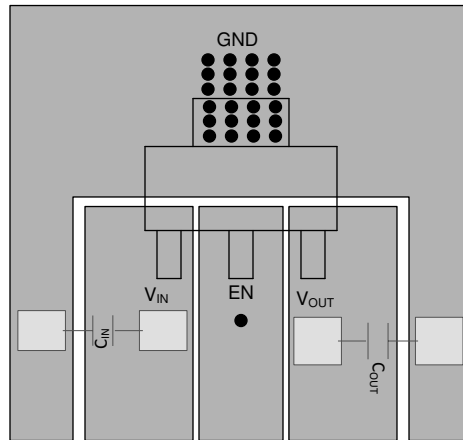

● Denotes a via

图 10-1. SOT-223 (DCY) Layout

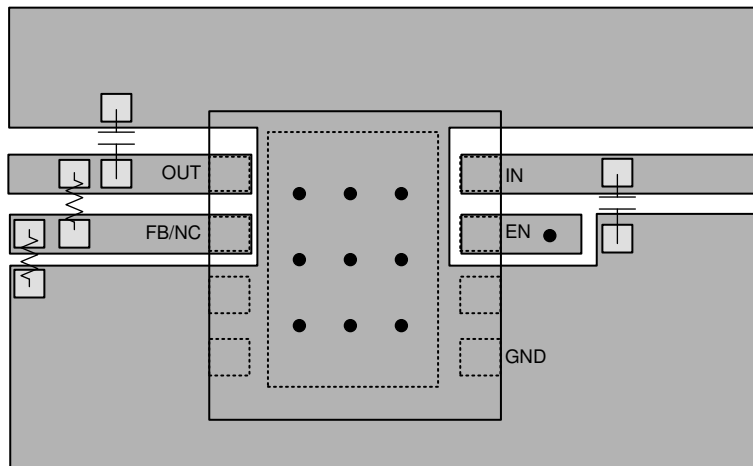

● Denotes a via

图 10-2. VSON (DRB) Layout

## 11 Device and Documentation Support

### 11.1 Device Support

#### 11.1.1 Device Nomenclature

表 11-1. Device Nomenclature<sup>(1)</sup>

PRODUCT	V <sub>OUT</sub>
TPS7B84xxQ(W)yyyRQ1	<p><b>xx</b> is the nominal output voltage (for example, 33 = 3.3 V; 50 = 5.0 V).</p> <p><b>Q</b> indicates that this device is a grade-1 device in accordance with the AEC-Q100 standard.</p> <p><b>W</b> indicates the package has wettable flanks.</p> <p><b>yyy</b> is the package designator.</p> <p><b>R</b> is the package quantity. R is for reel (3000 pieces).</p> <p><b>Q1</b> indicates that this device is an automotive grade (AEC-Q100) device.</p>

(1) For the most current package and ordering information see the Package Option Addendum at the end of this document, or visit the device product folder on [www.ti.com](http://www.ti.com).

#### 11.2 接收文档更新通知

要接收文档更新通知，请导航至 [ti.com](http://ti.com) 上的器件产品文件夹。点击 [订阅更新](#) 进行注册，即可每周接收产品信息更改摘要。有关更改的详细信息，请查看任何已修订文档中包含的修订历史记录。

#### 11.3 支持资源

**TI E2E™ 支持论坛**是工程师的重要参考资料，可直接从专家获得快速、经过验证的解答和设计帮助。搜索现有解答或提出自己的问题可获得所需的快速设计帮助。

链接的内容由各个贡献者“按原样”提供。这些内容并不构成 TI 技术规范，并且不一定反映 TI 的观点；请参阅 TI 的《[使用条款](#)》。

#### 11.4 Trademarks

TI E2E™ is a trademark of Texas Instruments.

所有商标均为其各自所有者的财产。

#### 11.5 静电放电警告



静电放电 (ESD) 会损坏这个集成电路。德州仪器 (TI) 建议通过适当的预防措施处理所有集成电路。如果不遵守正确的处理和安装程序，可能会损坏集成电路。

ESD 的损坏小至导致微小的性能降级，大至整个器件故障。精密的集成电路可能更容易受到损坏，这是因为非常细微的参数更改都可能会导致器件与其发布的规格不相符。

#### 11.6 术语表

**TI 术语表** 本术语表列出并解释了术语、首字母缩略词和定义。

### Mechanical, Packaging, and Orderable Information

The following pages include mechanical, packaging, and orderable information. This information is the most current data available for the designated devices. This data is subject to change without notice and revision of this document. For browser-based versions of this data sheet, refer to the left-hand navigation.

**PACKAGING INFORMATION**

Orderable Device	Status (1)	Package Type	Package Drawing	Pins	Package Qty	Eco Plan (2)	Lead finish/ Ball material (6)	MSL Peak Temp (3)	Op Temp (°C)	Device Marking (4/5)	Samples
TPS7B8401QWDRBRQ1	ACTIVE	SON	DRB	8	3000	RoHS & Green	NIPDAU	Level-2-260C-1 YEAR	-40 to 125	7B8401	<a href="#">Samples</a>
TPS7B8433QDCYRQ1	ACTIVE	SOT-223	DCY	4	2500	RoHS & Green	NIPDAU   SN	Level-2-260C-1 YEAR	-40 to 125	7B8433	<a href="#">Samples</a>
TPS7B8433QDCYRQ1M3	ACTIVE	SOT-223	DCY	4	2500	RoHS & Green	SN	Level-2-260C-1 YEAR	-40 to 125	7B8433	<a href="#">Samples</a>
TPS7B8433QDCYRQ1W	ACTIVE	SOT-223	DCY	4	2500	RoHS & Green	SN	Level-2-260C-1 YEAR	-40 to 125	7B8433	<a href="#">Samples</a>
TPS7B8433QWDRBRQ1	ACTIVE	SON	DRB	8	3000	RoHS & Green	NIPDAU	Level-2-260C-1 YEAR	-40 to 125	7B8433	<a href="#">Samples</a>
TPS7B8450QDCYRQ1	ACTIVE	SOT-223	DCY	4	2500	RoHS & Green	NIPDAU   SN	Level-2-260C-1 YEAR	-40 to 125	7B8450	<a href="#">Samples</a>
TPS7B8450QDCYRQ1M3	ACTIVE	SOT-223	DCY	4	2500	RoHS & Green	SN	Level-2-260C-1 YEAR	-40 to 125	7B8450	<a href="#">Samples</a>
TPS7B8450QDCYRQ1W	ACTIVE	SOT-223	DCY	4	2500	RoHS & Green	SN	Level-2-260C-1 YEAR	-40 to 125	7B8450	<a href="#">Samples</a>
TPS7B8450QWDRBRQ1	ACTIVE	SON	DRB	8	3000	RoHS & Green	NIPDAU	Level-2-260C-1 YEAR	-40 to 125	7B8450	<a href="#">Samples</a>
TPS7B8480QWDRBRQ1	ACTIVE	SON	DRB	8	3000	RoHS & Green	NIPDAU	Level-2-260C-1 YEAR	-40 to 125	7B8480	<a href="#">Samples</a>

(1) The marketing status values are defined as follows:

**ACTIVE:** Product device recommended for new designs.

**LIFEBUY:** TI has announced that the device will be discontinued, and a lifetime-buy period is in effect.

**NRND:** Not recommended for new designs. Device is in production to support existing customers, but TI does not recommend using this part in a new design.

**PREVIEW:** Device has been announced but is not in production. Samples may or may not be available.

**OBSOLETE:** TI has discontinued the production of the device.

(2) **RoHS:** TI defines "RoHS" to mean semiconductor products that are compliant with the current EU RoHS requirements for all 10 RoHS substances, including the requirement that RoHS substance do not exceed 0.1% by weight in homogeneous materials. Where designed to be soldered at high temperatures, "RoHS" products are suitable for use in specified lead-free processes. TI may reference these types of products as "Pb-Free".

**RoHS Exempt:** TI defines "RoHS Exempt" to mean products that contain lead but are compliant with EU RoHS pursuant to a specific EU RoHS exemption.

**Green:** TI defines "Green" to mean the content of Chlorine (Cl) and Bromine (Br) based flame retardants meet JS709B low halogen requirements of <=1000ppm threshold. Antimony trioxide based flame retardants must also meet the <=1000ppm threshold requirement.

(3) MSL, Peak Temp. - The Moisture Sensitivity Level rating according to the JEDEC industry standard classifications, and peak solder temperature.

(4) There may be additional marking, which relates to the logo, the lot trace code information, or the environmental category on the device.

<sup>(5)</sup> Multiple Device Markings will be inside parentheses. Only one Device Marking contained in parentheses and separated by a "~" will appear on a device. If a line is indented then it is a continuation of the previous line and the two combined represent the entire Device Marking for that device.

<sup>(6)</sup> Lead finish/Ball material - Orderable Devices may have multiple material finish options. Finish options are separated by a vertical ruled line. Lead finish/Ball material values may wrap to two lines if the finish value exceeds the maximum column width.

**Important Information and Disclaimer:**The information provided on this page represents TI's knowledge and belief as of the date that it is provided. TI bases its knowledge and belief on information provided by third parties, and makes no representation or warranty as to the accuracy of such information. Efforts are underway to better integrate information from third parties. TI has taken and continues to take reasonable steps to provide representative and accurate information but may not have conducted destructive testing or chemical analysis on incoming materials and chemicals. TI and TI suppliers consider certain information to be proprietary, and thus CAS numbers and other limited information may not be available for release.

In no event shall TI's liability arising out of such information exceed the total purchase price of the TI part(s) at issue in this document sold by TI to Customer on an annual basis.

**TAPE AND REEL INFORMATION**

**QUADRANT ASSIGNMENTS FOR PIN 1 ORIENTATION IN TAPE**

\*All dimensions are nominal

Device	Package Type	Package Drawing	Pins	SPQ	Reel Diameter (mm)	Reel Width W1 (mm)	A0 (mm)	B0 (mm)	K0 (mm)	P1 (mm)	W (mm)	Pin1 Quadrant
TPS7B8401QWDRBRQ1	SON	DRB	8	3000	330.0	12.4	3.3	3.3	1.1	8.0	12.0	Q2
TPS7B8433QDCYRQ1	SOT-223	DCY	4	2500	330.0	12.4	7.05	7.4	1.9	8.0	12.0	Q3
TPS7B8433QDCYRQ1M3	SOT-223	DCY	4	2500	330.0	12.4	7.05	7.4	1.9	8.0	12.0	Q3
TPS7B8433QDCYRQ1W	SOT-223	DCY	4	2500	330.0	16.4	7.05	7.4	1.9	8.0	16.0	Q3
TPS7B8433QWDRBRQ1	SON	DRB	8	3000	330.0	12.4	3.3	3.3	1.1	8.0	12.0	Q2
TPS7B8450QDCYRQ1	SOT-223	DCY	4	2500	330.0	12.4	7.05	7.4	1.9	8.0	12.0	Q3
TPS7B8450QDCYRQ1M3	SOT-223	DCY	4	2500	330.0	12.4	7.05	7.4	1.9	8.0	12.0	Q3
TPS7B8450QDCYRQ1W	SOT-223	DCY	4	2500	330.0	16.4	7.05	7.4	1.9	8.0	16.0	Q3
TPS7B8450QWDRBRQ1	SON	DRB	8	3000	330.0	12.4	3.3	3.3	1.1	8.0	12.0	Q2
TPS7B8480QWDRBRQ1	SON	DRB	8	3000	330.0	12.4	3.3	3.3	1.1	8.0	12.0	Q2

**TAPE AND REEL BOX DIMENSIONS**

\*All dimensions are nominal

Device	Package Type	Package Drawing	Pins	SPQ	Length (mm)	Width (mm)	Height (mm)
TPS7B8401QWDRBRQ1	SON	DRB	8	3000	367.0	367.0	35.0
TPS7B8433QDCYRQ1	SOT-223	DCY	4	2500	366.0	364.0	50.0
TPS7B8433QDCYRQ1M3	SOT-223	DCY	4	2500	366.0	364.0	50.0
TPS7B8433QDCYRQ1W	SOT-223	DCY	4	2500	366.0	364.0	50.0
TPS7B8433QWDRBRQ1	SON	DRB	8	3000	367.0	367.0	35.0
TPS7B8450QDCYRQ1	SOT-223	DCY	4	2500	340.0	340.0	38.0
TPS7B8450QDCYRQ1M3	SOT-223	DCY	4	2500	340.0	340.0	38.0
TPS7B8450QDCYRQ1W	SOT-223	DCY	4	2500	340.0	340.0	38.0
TPS7B8450QWDRBRQ1	SON	DRB	8	3000	367.0	367.0	35.0
TPS7B8480QWDRBRQ1	SON	DRB	8	3000	367.0	367.0	35.0

## 重要声明和免责声明

TI“按原样”提供技术和可靠性数据（包括数据表）、设计资源（包括参考设计）、应用或其他设计建议、网络工具、安全信息和其他资源，不保证没有瑕疵且不做任何明示或暗示的担保，包括但不限于对适销性、某特定用途方面的适用性或不侵犯任何第三方知识产权的暗示担保。

这些资源可供使用 TI 产品进行设计的熟练开发人员使用。您将自行承担以下全部责任：(1) 针对您的应用选择合适的 TI 产品，(2) 设计、验证并测试您的应用，(3) 确保您的应用满足相应标准以及任何其他功能安全、信息安全、监管或其他要求。

这些资源如有变更，恕不另行通知。TI 授权您仅可将这些资源用于研发本资源所述的 TI 产品的应用。严禁对这些资源进行其他复制或展示。您无权使用任何其他 TI 知识产权或任何第三方知识产权。您应全额赔偿因在这些资源的使用中对 TI 及其代表造成的任何索赔、损害、成本、损失和债务，TI 对此概不负责。

TI 提供的产品受 [TI 的销售条款](#) 或 [ti.com](#) 上其他适用条款/TI 产品随附的其他适用条款的约束。TI 提供这些资源并不会扩展或以其他方式更改 TI 针对 TI 产品发布的适用的担保或担保免责声明。

TI 反对并拒绝您可能提出的任何其他或不同的条款。

邮寄地址：Texas Instruments, Post Office Box 655303, Dallas, Texas 75265

Copyright © 2024，德州仪器 (TI) 公司