

## ADS54J66 具有集成 DDC 的四通道、14 位、500MSPS ADC

### 1 特性

- 四通道
- 14 位分辨率
- 最大时钟频率：500MSPS
- 输入带宽 (3dB)：900MHz
- 片上抖动
- 具有高阻抗输入的模拟输入缓冲器
- 输出选项：
  - Rx：通过低通滤波器实现 2 倍抽取率和 4 倍抽取率选项
  - 200MHz 复杂带宽或 100MHz 实际带宽支持
  - DPD FB：500MSPS
- 1.9V<sub>PP</sub> 差分满量程输入
- JESD204B 接口：
  - 子类 1 支持
  - 每个 ADC 一条信道，速率高达 10Gsp/s
  - 专用于通道对的 SYNC 引脚
- 支持多芯片同步
- 72 引脚 VQFN 封装 (10mm × 10mm)
- 主要规格：
  - 功耗：675mW/ch
  - 频谱性能 (未抽取)
    - $f_{IN} = 190\text{MHz}$  中频 (IF) ( - 1dBFS 时 )：
      - SNR：69.5dBFS
      - NSD：-153.5dBFS/Hz
      - SFDR：86dBc ( HD2, HD3 ) , 93dBFS ( 非 HD2, HD3 )
    - $f_{IN} = 370\text{MHz}$  IF ( - 3dBFS 时 )：
      - SNR：68.5dBFS
      - NSD：-152.5dBFS/Hz
      - SFDR：81dBc ( HD2, HD3 ) , 86dBFS ( 非 HD2, HD3 )

### 2 应用

- 雷达和天线阵列
- 宽带无线和数字转换器
- 电缆 CMTS、DOCSIS 3.1 接收器
- 通信测试设备
- 微波接收器
- 软件定义无线电 (SDR)

### 3 说明

ADS54J66 是一款低功耗、高带宽、14 位、500MSPS、四通道电信接收器。ADS54J66 支持 JESD204B 串行接口，每个通道上具有 1 条信道，数据传输速率高达 10Gbps。经缓冲的模拟输入可在较宽频率范围内提供统一输入阻抗，并最大程度地降低采样和保持毛刺脉冲能量。ADS54J66 以超低功耗在宽输入频率范围内提供出色的无杂散动态范围 (SFDR)。数字信号处理模块包含复混频器，后接低通滤波器。低通滤波器具有 2 倍抽取率和 4 倍抽取率两个选项，支持高达 200MHz 的接收器带宽。

JESD204B 接口减少了接口线路数，从而实现高系统集成度。内部锁相环 (PLL) 会将传入的模数转换器 (ADC) 采样时钟加倍，以获得串行化各通道的 14 位数据时所使用的位时钟。

#### 封装信息

器件型号	封装 <sup>(1)</sup>	封装尺寸 (标称值)
ADS54J66	VQFN (72)	10.00mm x 10.00mm

(1) 要了解所有可用封装，请见数据表末尾的可订购产品附录。

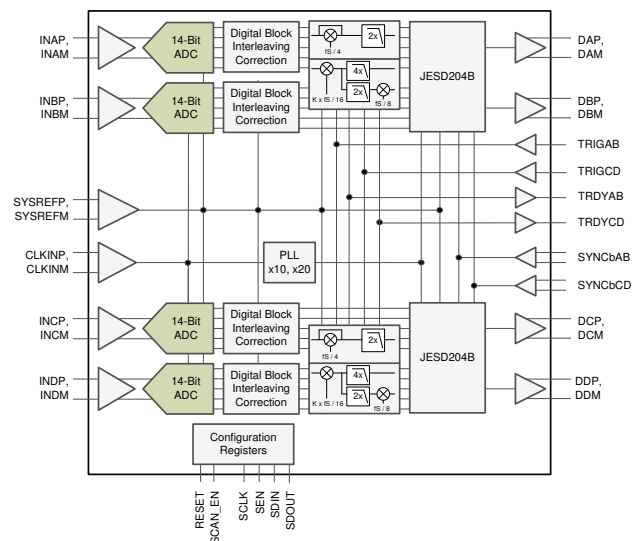

简化版方框图



## Table of Contents

<b>1 特性</b> .....	<b>1</b>	7.2 Functional Block Diagram.....	<b>23</b>
<b>2 应用</b> .....	<b>1</b>	7.3 Feature Description.....	<b>24</b>
<b>3 说明</b> .....	<b>1</b>	7.4 Device Functional Modes.....	<b>25</b>
<b>4 Revision History</b> .....	<b>3</b>	7.5 Programming.....	<b>34</b>
<b>5 Pin Configuration and Functions</b> .....	<b>4</b>	7.6 Register Maps.....	<b>44</b>
<b>6 Specifications</b> .....	<b>6</b>	<b>8 Application Information Disclaimer</b> .....	<b>71</b>
6.1 Absolute Maximum Ratings.....	<b>6</b>	8.1 Application Information.....	<b>71</b>
6.2 ESD Ratings.....	<b>6</b>	8.2 Typical Application.....	<b>77</b>
6.3 Recommended Operating Conditions.....	<b>7</b>	8.3 Power Supply Recommendations.....	<b>79</b>
6.4 Thermal Information.....	<b>7</b>	8.4 Layout.....	<b>80</b>
6.5 Electrical Characteristics.....	<b>8</b>	<b>9 Device and Documentation Support</b> .....	<b>81</b>
6.6 AC Performance.....	<b>9</b>	9.1 接收文档更新通知.....	<b>81</b>
6.7 Digital Characteristics.....	<b>11</b>	9.2 支持资源.....	<b>81</b>
6.8 Timing Requirements.....	<b>12</b>	9.3 商标.....	<b>81</b>
6.9 Typical Characteristics: General (DDC Mode-8).....	<b>14</b>	9.4 Electrostatic Discharge Caution.....	<b>81</b>
6.10 Typical Characteristics: Mode 2.....	<b>21</b>	9.5 术语表.....	<b>81</b>
6.11 Typical Characteristics: Mode 0.....	<b>22</b>	<b>10 Mechanical, Packaging, and Orderable Information</b> .....	<b>81</b>
<b>7 Detailed Description</b> .....	<b>23</b>		
7.1 Overview.....	<b>23</b>		

## 4 Revision History

注：以前版本的页码可能与当前版本的页码不同

<b>Changes from Revision A (December 2015) to Revision B (January 2023)</b>	<b>Page</b>
• Changed <i>rising</i> to <i>falling</i> in the $t_{SU\_SYSREF}$ and $t_{H\_SYSREF}$ parameter descriptions.....	12
• Deleted the $t_{SU\_SYSREF}$ maximum value.....	12
• Added second table note to <i>Timing Characteristics</i> table.....	12
• Added <i>SYSREF Timing Diagram</i> figure.....	12
• Deleted <i>One threshold is set per channel pair A, B, and C, D.</i> from <i>Overrange Indication</i> section.....	32
• Added note to <i>Overrange Indication</i> section.....	32
• Changed FFh to 0Fh in <a href="#">表 7-8</a> .....	32
• Deleted 5th row (LMFS = 2881) from <a href="#">表 7-13</a> .....	41
• Deleted LMFS = 2881 section from <a href="#">表 7-14</a> .....	41
• Changed bit 0, register 53, master page (80h) from 0 to <i>SET SYSREF</i> .....	45
• Added register 54 to master page registers.....	45
• Removed registers 19h to 20h from JESD Digital Page (6900h).....	45
• Added register 17h to JESD Analog Page (6A00h).....	45
• Changed 00h26 to 0026h in ADDRESS column and 80h to C0h in DATA column of <i>Example Register Writes</i> table.....	47
• Added <a href="#">表 7-16</a> , deleted legends from <i>Register Descriptions</i> section.....	47
• Changed register description of Register 53h (address = 53h) [reset = 0h], Master Page (80h).....	52
• Added Register 54h (address = 54h) [reset = 0h], Master Page (80h).....	53
• Deleted the tables and description for registers 0x19-0x20.....	64
• Changed <i>Register 16h Field Descriptions</i> table in Register 16h (address = 16h) [reset = 0h], JESD Analog Page (6A00h).....	69
• Added Register 17h (address = 17h) [reset = 0h], JESD Analog Page (6A00h).....	69
• Changed <i>6Ah</i> to <i>6A00h</i> in register title and changed description of bits 7-5 in Register 1Bh (address = 1Bh) [reset = 0h], JESD Analog Page (6A00h).....	69
• Changed description for Step 1 in <i>Start-Up Sequence</i> section .....	71
• Changed <i>Hardware Reset Timing Diagram</i> figure.....	72
• Added <i>SYSREF Signal</i> section.....	72
• Added <i>Idle Channel Histogram</i> section.....	73
• Changed <i>Power Supply Recommendations</i> section .....	79

<b>Changes from Revision * (November 2015) to Revision A (December 2015)</b>	<b>Page</b>
• <a href="#">表 7-8</a> : changed several comments, added rows .....	32
• Changed <a href="#">表 7-13</a> : added footnotes, changed JESD Mode and JESD Mode PLL column headers .....	41
• Changed <i>Serial Interface Registers</i> figure: changed last value of JESD bank page address .....	44
• Changed <i>Register Map</i> table: changed ADC page registers 5Fh to 6Dh.....	45
• Changed description of decimation mode 0 to mode 4 in <i>Example Register Writes</i> section: deleted ( <i>default</i> ) ... <a href="#">47</a>	47
• Changed Register 5Fh, Register 60h, and Register 61h .....	55
• Changed Register 6Ch and Register 6Dh .....	56
• Changed <i>Start-Up Sequence</i> section .....	71

### 5 Pin Configuration and Functions

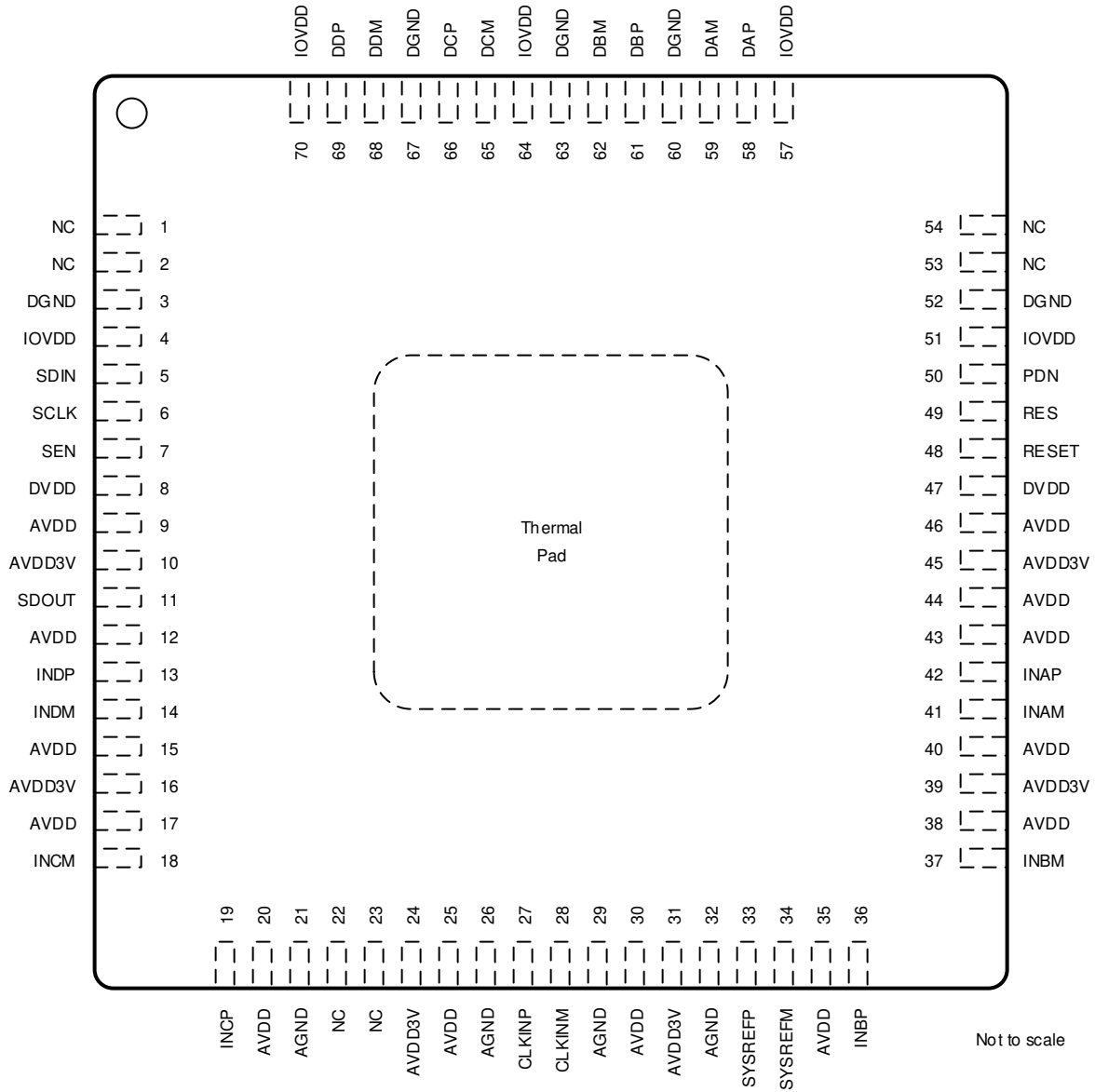

**图 5-1. RMP Package, 72-Pin VQFN (Top View)**

**表 5-1. Pin Functions**

PIN		I/O	DESCRIPTION
NAME	NUMBER		
<b>Input, Reference</b>			
INAM	41	I	Differential analog input pins for channel A. Connect INAP to AVDD and INAM to GND if unused.
INAP	42		
INBM	37	I	Differential analog input pins for channel B. Connect INBP to AVDD and INBM to GND if unused.
INBP	36		
INCM	18	I	Differential analog input pins for channel C. Connect INCP to AVDD and INCM to GND if unused.
INCP	19		
INDM	14	I	Differential analog input pins for channel D. Connect INDP to AVDD and INDM to GND if unused.
INDP	13		
<b>Clock, SYNC</b>			
CLKINM	28	I	Differential clock input pins for the ADC
CLKINP	27		
SYSREFM	34	I	External sync input pins
SYSREFP	33		
<b>Control, Serial</b>			
DAM	59	O	JESD204B Serial data output pins for channel A. Connect a 100 Ohm resistor across DAM and DAP if unused.
DAP	58		
DBM	62	O	JESD204B Serial data output pins for channel B. Connect a 100 Ohm resistor across DBM and DBP if unused.
DBP	61		
DCM	65	O	JESD204B Serial data output pins for channel C. Connect a 100 Ohm resistor across DCM and DCP if unused.
DCP	66		
DDM	68	O	JESD204B Serial data output pins for channel D. Connect a 100 Ohm resistor across DDM and DDP if unused.
DDP	69		
NC	1, 2, 22, 23, 53, 54	-	Do not connect
PDN	50	I/O	Power down. Can be configured via SPI register setting.
RES	49	-	Reserve pin. Connect to GND
RESET	48	I	Hardware reset. Active high. This pin has an internal 150-k $\Omega$ pulldown resistor.
SCLK	6	I	Serial interface clock input
SDIN	5	I	Serial interface data input.
SDOUT	11	O	Serial interface data output.
SEN	7	I	Serial interface enable
SYNCbABM	56	I	Synchronization input pins for JESD204B port channel A, B. Can be configured via SPI to SYNCb signal for all four channels. Needs external termination.
SYNCbABP	55		
SYNCbCDM	71	I	Synchronization input pins for JESD204B port channel C, D. Can be configured via SPI to SYNCb signal for all four channels. Needs external termination.
SYNCbCDP	72		
<b>Power Supply</b>			
AGND	21, 26, 29, 32	I	Analog ground
AVDD	9, 12, 15, 17, 20, 25, 30, 35, 38, 40, 43, 44, 46	I	Analog 1.9-V power supply
AVDD3V	10, 16, 24, 31, 39, 45	I	Analog 3 V for analog buffer
DGND	3, 52, 60, 63, 67	I	Digital ground
DVDD	8, 47	I	Digital 1.9-V power supply
IOVDD	4, 51, 57, 64, 70	I	Digital 1.15-V power supply for the JESD204B transmitter

## 6 Specifications

### 6.1 Absolute Maximum Ratings

over operating free-air temperature range (unless otherwise noted)<sup>(1)</sup>

		MIN	MAX	UNIT
Supply voltage range	AVDD3V	- 0.3	3.6	V
	AVDD	- 0.3	2.1	
	DVDD	- 0.3	2.1	
	IOVDD	- 0.2	1.4	
Voltage between AGND and DGND		- 0.3	0.3	V
Voltage applied to input pins	INAP, INBP, INAM, INBM, INCP, INDP, INCM, INDM	- 0.3	3	V
	CLKINP, CLKINM	- 0.3	AVDD + 0.3	
	SYSREFP, SYSREFM	- 0.3	AVDD + 0.3	
	SCLK, SEN, SDIN, RESET, SPI_MODE, SYNCbABP, SYNCbABM, SYNCbCDP, SYNCbCDM, PDN	- 0.2	2	
Storage temperature, T <sub>stg</sub>		- 65	150	°C

- (1) Operation outside the *Absolute Maximum Ratings* may cause permanent device damage. *Absolute Maximum Ratings* do not imply functional operation of the device at these or any other conditions beyond those listed under *Recommended Operating Conditions*. If used outside the *Recommended Operating Conditions* but within the *Absolute Maximum Ratings*, the device may not be fully functional, and this may affect device reliability, functionality, performance, and shorten the device lifetime.

### 6.2 ESD Ratings

			VALUE	UNIT
V <sub>(ESD)</sub>	Electrostatic discharge	Human-body model (HBM), per ANSI/ESDA/JEDEC JS-001 <sup>(1)</sup>	±1000	V

- (1) JEDEC document JEP155 states that 500-V HBM allows safe manufacturing with a standard ESD control process.

### 6.3 Recommended Operating Conditions

over operating free-air temperature range (unless otherwise noted)<sup>(2)</sup>

		MIN	NOM	MAX	UNIT
Supply voltage range	AVDD3V	2.85	3	3.6	V
	AVDD	1.8	1.9	2	
	DVDD	1.8	1.9	2	
	IOVDD	1.1	1.15	1.2	
Analog inputs	Differential input voltage range	1.9			V <sub>PP</sub>
	Input common-mode voltage	2.0 ± 0.025			V
Clock inputs	Input clock frequency, device clock frequency		250	500	MHz
	Input clock amplitude differential (V <sub>CLKP</sub> - V <sub>CLKM</sub> )	Sine wave, ac-coupled	1.5		V <sub>PP</sub>
		LVPECL, ac-coupled	1.6		
		LVDS, ac-coupled	0.7		
Input device clock duty cycle, default after reset		45%	50%	55%	
Temperature	Operating free-air, T <sub>A</sub>	-40		85	°C
	Operating junction, T <sub>J</sub>		105 <sup>(1)</sup>	125	

- (1) Prolonged use above this junction temperature can increase the device failure-in-time (FIT) rate.  
 (2) SYSREF must be applied for the device initialization.

### 6.4 Thermal Information

THERMAL METRIC <sup>(1)</sup>		ADS54J66	UNIT
		RMP (VQFNP)	
		72 PINS	
R <sub>θJA</sub>	Junction-to-ambient thermal resistance	22.3	°C/W
R <sub>θJC(top)</sub>	Junction-to-case (top) thermal resistance	5.1	°C/W
R <sub>θJB</sub>	Junction-to-board thermal resistance	2.4	°C/W
ψ <sub>JT</sub>	Junction-to-top characterization parameter	0.1	°C/W
ψ <sub>JB</sub>	Junction-to-board characterization parameter	2.3	°C/W
R <sub>θJC(bot)</sub>	Junction-to-case (bottom) thermal resistance	0.4	°C/W

- (1) For more information about traditional and new thermal metrics, see the [Semiconductor and IC Package Thermal Metrics](#) application report.

## 6.5 Electrical Characteristics

typical values are at  $T_A = 25^\circ\text{C}$ , full temperature range is from  $T_{\text{MIN}} = -40^\circ\text{C}$  to  $T_{\text{MAX}} = 85^\circ\text{C}$ , ADC sampling frequency = 500 MSPS, 50% clock duty cycle,  $\text{AVDD3V} = 3\text{ V}$ ,  $\text{AVDD} = \text{DVDD} = 1.9\text{ V}$ ,  $\text{IOVDD} = 1.15\text{ V}$ , -1-dBFS differential input for  $\text{IF} \leq 250\text{ MHz}$ , and -3-dBFS differential input for  $\text{IF} > 250\text{ MHz}$  (unless otherwise noted)

PARAMETER		TEST CONDITIONS	MIN	TYP	MAX	UNIT
<b>General</b>						
ADC sampling rate					500	MSPS
Resolution			14			Bits
<b>Power Supply</b>						
AVDD3V	3-V analog supply		2.85	3	3.6	V
AVDD	1.9-V analog supply		1.8	1.9	2	V
DVDD	1.9-V digital supply		1.8	1.9	2	V
IOVDD	1.15-V SERDES supply		1.1	1.15	1.2	V
$I_{\text{AVDD3V}}$	3-V analog supply current	370-MHz, full-scale input on all four channels		340		mA
$I_{\text{AVDD}}$	1.9-V analog supply current	370-MHz, full-scale input on all four channels		365		mA
$I_{\text{DVDD}}$	1.9-V digital supply current	2x decimation (4 channels), 370 MHz, full-scale input on all four channels		190		mA
		DDC mode-8 (no decimation), 370 MHz, full-scale input on all four channels		184		
$I_{\text{IOVDD}}$	1.15-V SERDES supply current	DDC mode-8 (no decimation), 370 MHz, full-scale input on all four channels		533		mA
$P_{\text{dis}}$	Total power dissipation	2x decimation (4 channels), 370 MHz, full-scale input on all four channels		2.68		W
		DDC mode-8 (no decimation), 370 MHz, full-scale input on all four channels		2.67		
Global power-down power dissipation		Full-scale input on all four channels		250		mW
<b>Analog Inputs</b>						
Differential input full-scale voltage				1.9		$V_{\text{PP}}$
Input common-mode voltage				2.0		V
Differential input resistance		At $f_{\text{IN}} = 370\text{ MHz}$		0.5		$\text{k}\Omega$
Differential input capacitance		At $f_{\text{IN}} = 370\text{ MHz}$		2.5		pF
Analog input bandwidth (3 dB)				900		MHz
<b>Isolation</b>						
Crosstalk <sup>(1)</sup> isolation between near channels (channels A and B are near to each other, channels C and D are near to each other)	$f_{\text{IN}} = 10\text{ MHz}$			105		dBFS
	$f_{\text{IN}} = 100\text{ MHz}$			104		
	$f_{\text{IN}} = 170\text{ MHz}$			96		
	$f_{\text{IN}} = 270\text{ MHz}$			97		
	$f_{\text{IN}} = 370\text{ MHz}$			93		
	$f_{\text{IN}} = 470\text{ MHz}$			85		
Crosstalk <sup>(1)</sup> isolation between far channels (channels A and B, and channels C and D are far channels)	$f_{\text{IN}} = 10\text{ MHz}$			110		dBFS
	$f_{\text{IN}} = 100\text{ MHz}$			107		
	$f_{\text{IN}} = 170\text{ MHz}$			96		
	$f_{\text{IN}} = 270\text{ MHz}$			97		
	$f_{\text{IN}} = 370\text{ MHz}$			95		
	$f_{\text{IN}} = 470\text{ MHz}$			94		
<b>Clock Input</b>						
Internal clock biasing		CLKINP and CLKINM pins are connected to internal biasing voltage through $400\ \Omega$		1.15		V

(1) Crosstalk is measured with a -1-dBFS input signal on aggressor channel and no input on the victim channel.



## 6.6 AC Performance

over operating free-air temperature range (unless otherwise noted)

PARAMETER	TEST CONDITIONS	NO DECIMATION, 500-MSPS OUTPUT (DDC Mode 8)			DECIMATE-BY-2, 250-MSPS OUTPUT (DDC Mode 2)			UNIT
		MIN	TYP	MAX	MIN	TYP	MAX	
SNR	Signal-to-noise ratio	$f_{IN} = 10 \text{ MHz}$		70.8		74.1	dBFS	
		$f_{IN} = 70 \text{ MHz}$		70.5		74		
		$f_{IN} = 190 \text{ MHz}, A_{IN} = -1 \text{ dBFS}$		69.5		73.2		
		$f_{IN} = 190 \text{ MHz}, A_{IN} = -3 \text{ dBFS}$	65.6	70.3		73.6		
		$f_{IN} = 300 \text{ MHz}$		69		72.6		
		$f_{IN} = 350 \text{ MHz}$		68.7		72		
		$f_{IN} = 370 \text{ MHz}$	64.6	68.4		71.5		
	$f_{IN} = 470 \text{ MHz}$		67.5		70.7			
NSD	Noise spectral density	$f_{IN} = 10 \text{ MHz}$		154.8		155.1	dBFS/Hz	
		$f_{IN} = 70 \text{ MHz}$		154.5		155		
		$f_{IN} = 190 \text{ MHz}, A_{IN} = -1 \text{ dBFS}$		153.5		154.2		
		$f_{IN} = 190 \text{ MHz}, A_{IN} = -3 \text{ dBFS}$	149.6	154.3		154.6		
		$f_{IN} = 300 \text{ MHz}$		153		153.6		
		$f_{IN} = 350 \text{ MHz}$		152.7		153		
		$f_{IN} = 370 \text{ MHz}$	148.6	152.4		152.5		
	$f_{IN} = 470 \text{ MHz}$		151.5		151.7			
SINAD	Signal-to-noise and distortion ratio	$f_{IN} = 10 \text{ MHz}$		70.7		73.9	dBFS	
		$f_{IN} = 70 \text{ MHz}$		70.4		73.9		
		$f_{IN} = 190 \text{ MHz}, A_{IN} = -1 \text{ dBFS}$		69.4		73.1		
		$f_{IN} = 190 \text{ MHz}, A_{IN} = -3 \text{ dBFS}$		70.2		73.5		
		$f_{IN} = 300 \text{ MHz}$		68.9		72.5		
		$f_{IN} = 350 \text{ MHz}$		68.6		71.7		
		$f_{IN} = 370 \text{ MHz}$		68.2				
	$f_{IN} = 470 \text{ MHz}$		66.9		69.7			
SFDR	Spurious-free dynamic range	$f_{IN} = 10 \text{ MHz}$		89		88	dBc	
		$f_{IN} = 70 \text{ MHz}$		87		95		
		$f_{IN} = 190 \text{ MHz}, A_{IN} = -1 \text{ dBFS}$		86		97		
		$f_{IN} = 190 \text{ MHz}, A_{IN} = -3 \text{ dBFS}$	78	88		96		
		$f_{IN} = 300 \text{ MHz}$		82		94		
		$f_{IN} = 350 \text{ MHz}$		82		82		
		$f_{IN} = 370 \text{ MHz}$	75	81				
	$f_{IN} = 470 \text{ MHz}$		73		74			
HD2	Second-order harmonic distortion	$f_{IN} = 10 \text{ MHz}$		89		91	dBc	
		$f_{IN} = 70 \text{ MHz}$		94		103		
		$f_{IN} = 190 \text{ MHz}, A_{IN} = -1 \text{ dBFS}$		86		101		
		$f_{IN} = 190 \text{ MHz}, A_{IN} = -3 \text{ dBFS}$	78	88		101		
		$f_{IN} = 300 \text{ MHz}$		82		97		
		$f_{IN} = 350 \text{ MHz}$		82		82		
		$f_{IN} = 370 \text{ MHz}$	75	81				
	$f_{IN} = 470 \text{ MHz}$		73		74			

### 6.6 AC Performance (continued)

over operating free-air temperature range (unless otherwise noted)

PARAMETER	TEST CONDITIONS	NO DECIMATION, 500-MSPS OUTPUT (DDC Mode 8)			DECIMATE-BY-2, 250-MSPS OUTPUT (DDC Mode 2)			UNIT
		MIN	TYP	MAX	MIN	TYP	MAX	
HD3 Third-order harmonic distortion	$f_{IN} = 10 \text{ MHz}$		93			88		dBc
	$f_{IN} = 70 \text{ MHz}$		87			99		
	$f_{IN} = 190 \text{ MHz}, A_{IN} = -1 \text{ dBFS}$		98			100		
	$f_{IN} = 190 \text{ MHz}, A_{IN} = -3 \text{ dBFS}$	78	97			98		
	$f_{IN} = 300 \text{ MHz}$		95			100		
	$f_{IN} = 350 \text{ MHz}$		90			96		
	$f_{IN} = 370 \text{ MHz}$	75	85					
	$f_{IN} = 470 \text{ MHz}$		83			83		
Non HD2, HD3 Spurious-free dynamic range (excluding HD2, HD3)	$f_{IN} = 10 \text{ MHz}$		94			98		dBc
	$f_{IN} = 70 \text{ MHz}$		94			95		
	$f_{IN} = 190 \text{ MHz}, A_{IN} = -1 \text{ dBFS}$		93			97		
	$f_{IN} = 190 \text{ MHz}, A_{IN} = -3 \text{ dBFS}$	87	93			96		
	$f_{IN} = 300 \text{ MHz}$		92			94		
	$f_{IN} = 350 \text{ MHz}$		91			94		
	$f_{IN} = 370 \text{ MHz}$	80	90					
	$f_{IN} = 470 \text{ MHz}$		87			93		
THD Total harmonic distortion	$f_{IN} = 10 \text{ MHz}$		88			86		dBc
	$f_{IN} = 70 \text{ MHz}$		85			92		
	$f_{IN} = 190 \text{ MHz}, A_{IN} = -1 \text{ dBFS}$		85			92		
	$f_{IN} = 190 \text{ MHz}, A_{IN} = -3 \text{ dBFS}$		86			91		
	$f_{IN} = 300 \text{ MHz}$		81			89		
	$f_{IN} = 350 \text{ MHz}$		79			82		
	$f_{IN} = 370 \text{ MHz}$		78					
	$f_{IN} = 470 \text{ MHz}$		72			73		
IMD3 Two-tone, third-order intermodulation distortion	$f_{IN} = 185 \text{ MHz}, f_{IN} = 190 \text{ MHz}, A_{IN} = -7 \text{ dBFS}$		89					dBFS
	$f_{IN} = 365 \text{ MHz}, f_{IN} = 370 \text{ MHz}, A_{IN} = -7 \text{ dBFS}$		82					
	$f_{IN} = 465 \text{ MHz}, f_{IN} = 470 \text{ MHz}, A_{IN} = -7 \text{ dBFS}$		77					

## 6.7 Digital Characteristics

typical values are at  $T_A = 25^\circ\text{C}$ , full temperature range is from  $T_{\text{MIN}} = -40^\circ\text{C}$  to  $T_{\text{MAX}} = 85^\circ\text{C}$ , ADC sampling rate = 500 MSPS, 50% clock duty cycle,  $\text{AVDD3V} = 3\text{ V}$ ,  $\text{AVDD} = \text{DVDD} = 1.9\text{ V}$ ,  $\text{IOVDD} = 1.15\text{ V}$ , and -1-dBFS differential input (unless otherwise noted)

PARAMETER		TEST CONDITIONS	MIN	TYP	MAX	UNIT
<b>Digital Inputs (RESET, SCLK, SEN, SDIN, PDN)<sup>(1)</sup></b>						
$V_{\text{IH}}$	High-level input voltage	All digital inputs support 1.2-V and 1.8-V logic levels	0.8			V
$V_{\text{IL}}$	Low-level input voltage	All digital inputs support 1.2-V and 1.8-V logic levels			0.4	V
$I_{\text{IH}}$	High-level input current	SEN		0		$\mu\text{A}$
		RESET, SCLK, SDIN, PDN		100		
$I_{\text{IL}}$	Low-level input current	SEN		50		$\mu\text{A}$
		RESET, SCLK, SDIN, PDN		0		
<b>Digital Inputs (SYSREFP, SYSREFM, SYNCbABM, SYNCbABP, SYNCbCDM, SYNCbCDP)</b>						
$V_{\text{D}}$	Differential input voltage		0.35	0.45	1.4	V
$V_{(\text{CM\_DIG})}$	Common-mode voltage for SYSREF			1.3		V
<b>Digital Outputs (SDOUT, PDN)</b>						
$V_{\text{OH}}$	High-level output voltage		$\text{DVDD} - 0.1$	DVDD		V
$V_{\text{OL}}$	Low-level output voltage				0.1	V
<b>Digital Outputs (JESD204B Interface: DxP, DxM)<sup>(2)</sup></b>						
$V_{\text{OD}}$	Output differential voltage	With default swing setting		700		$\text{mV}_{\text{PP}}$
$V_{\text{OC}}$	Output common-mode voltage			450		mV
	Transmitter short-circuit current	Transmitter pins shorted to any voltage between -0.25 V and 1.45 V	-100		100	mA
$Z_{\text{os}}$	Single-ended output impedance			50		$\Omega$
	Output capacitance	Output capacitance inside the device, from either output to ground		2		pF

- (1) The RESET, SCLK, SDATA, and PDN pins have a 20-k $\Omega$  (typical) internal pulldown resistor to ground, and the SEN pin has a 20-k $\Omega$  (typical) pull up resistor to IOVDD.
- (2) 50- $\Omega$ , single-ended external termination to IOVDD.

## 6.8 Timing Requirements

typical values are at  $T_A = 25^\circ\text{C}$ , full temperature range is from  $T_{\text{MIN}} = -40^\circ\text{C}$  to  $T_{\text{MAX}} = 85^\circ\text{C}$ , ADC sampling rate = 500 MSPS, 50% clock duty cycle, AVDD3V = 3 V, AVDD = DVDD = 1.9 V, IOVDD = 1.15 V, and -1-dBFS differential input (unless otherwise noted)

	MIN	TYP	MAX	UNIT
<b>Sample Timing Characteristics</b> (TBD are any of these Switching Characteristics?)				
Aperture delay	0.75		1.6	ns
Aperture delay matching between two channels on the same device		$\pm 70$		ps
Aperture delay matching between two devices at the same temperature and supply voltage		$\pm 270$		ps
Aperture jitter		135		$f_s$ rms
Wake-up time to valid data after coming out of global power-down		150		$\mu\text{s}$
Data latency <sup>(1)</sup> : ADC sample to digital output		77		Input clock cycles
OVR latency: ADC sample to OVR bit		44		Input clock cycles
$t_{\text{PDI}}$ Clock propagation delay: input clock rising edge cross-over to output clock rising edge cross-over		4		ns
$t_{\text{SU\_SYSREF}}$ <sup>(2)</sup> Setup time for SYSREF, referenced to input clock falling edge	300			ps
$t_{\text{H\_SYSREF}}$ <sup>(2)</sup> Hold time for SYSREF, referenced to input clock falling edge	100			ps
<b>JESD Output Interface Timing Characteristics</b>				
Unit interval	100		400	ps
Serial output data rate	2.5		10	Gbps
Total jitter for BER of 1E-15 and lane rate = 10 Gbps		26		ps
Random jitter for BER of 1E-15 and lane rate = 10 Gbps		0.75		ps rms
Deterministic jitter for BER of 1E-15 and lane rate = 10 Gbps		12		ps, pk-pk
$t_{\text{R}}, t_{\text{F}}$ Data rise time, data fall time: rise and fall times measured from 20% to 80%, differential output waveform, 2.5 Gbps $\leq$ bit rate $\leq$ 10 Gbps		35		ps

(1) Overall ADC latency = data latency +  $t_{\text{PDI}}$ .

(2) SYSREF should arrive 'setup time' before the active edge of sampling clock and remain stable until 'hold time' after active edge of sampling clock. See [Figure 6-2](#).

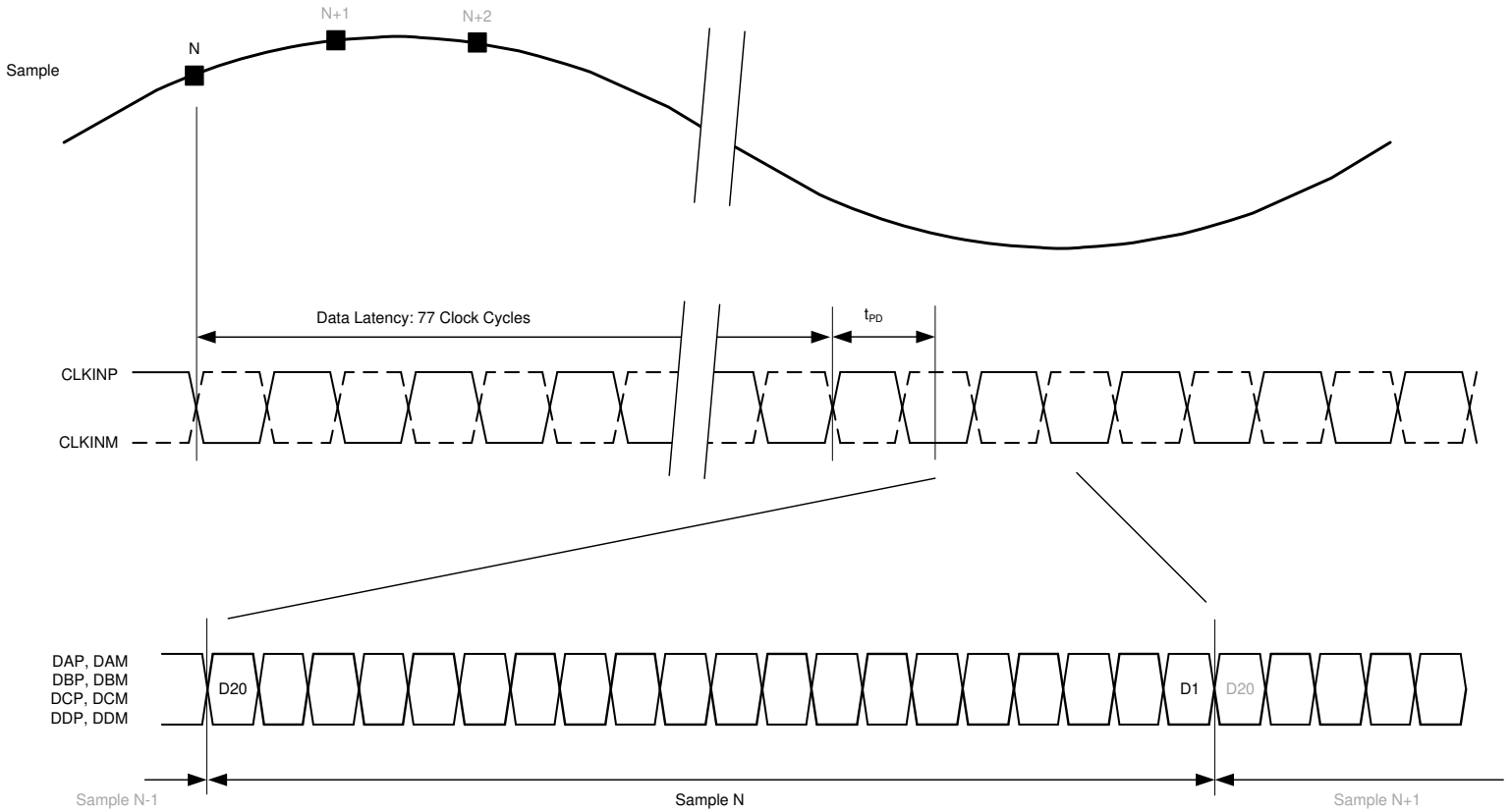

**图 6-1. Latency Timing Diagram**

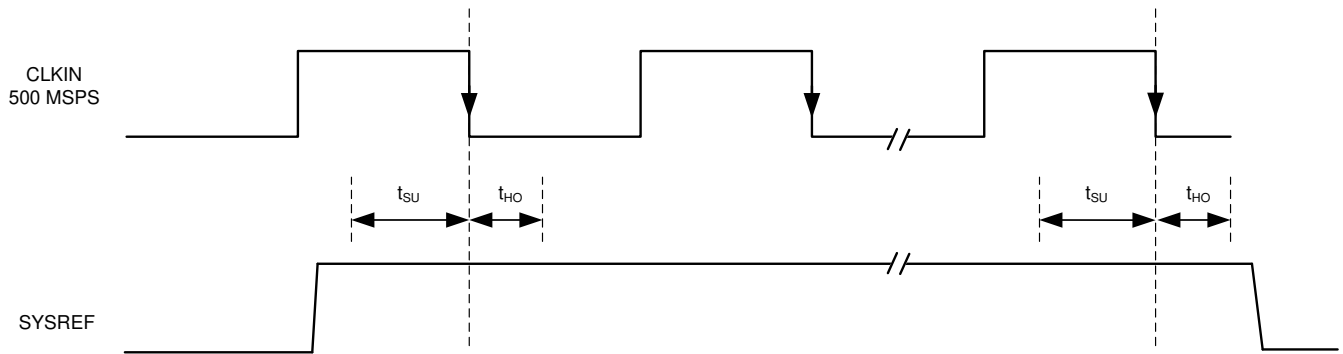

**图 6-2. SYSREF Timing Diagram**

### 6.9 Typical Characteristics: General (DDC Mode-8)

typical values are at  $T_A = 25^\circ\text{C}$ , full temperature range is from  $T_{\text{MIN}} = -40^\circ\text{C}$  to  $T_{\text{MAX}} = 85^\circ\text{C}$ , ADC sampling frequency = 500 MSPS, 14-bit resolution, no decimation filter, 50% clock duty cycle,  $\text{AVDD3V} = 3\text{ V}$ ,  $\text{AVDD} = \text{DVDD} = 1.9\text{ V}$ ,  $\text{IOVDD} = 1.15\text{ V}$ , -1-dBFS differential input for  $\text{IF} \leq 250\text{ MHz}$ , and -3-dBFS differential input for  $\text{IF} > 250\text{ MHz}$  (unless otherwise noted)

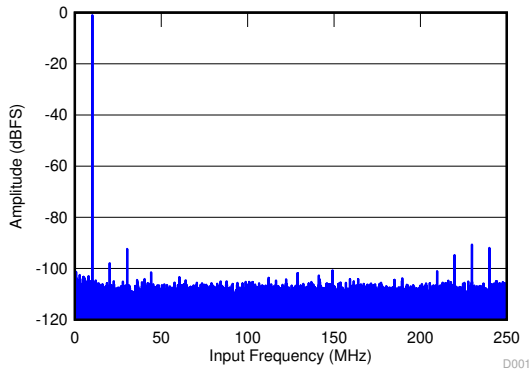

$f_{\text{IN}} = 10\text{ MHz}$ ,  $A_{\text{IN}} = -1\text{ dBFS}$ ,  $\text{SNR} = 71\text{ dBFS}$ ,  $\text{SFDR} = 89\text{ dBc}$ ,  $\text{SFDR} = 89\text{ dBc}$  (non 23)

图 6-3. FFT for 10-MHz Input Signal

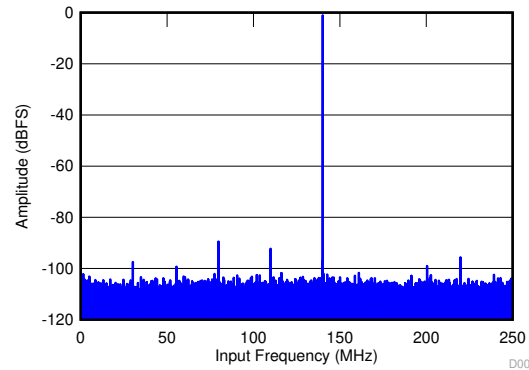

$f_{\text{IN}} = 140\text{ MHz}$ ,  $A_{\text{IN}} = -1\text{ dBFS}$ ,  $\text{SNR} = 70\text{ dBFS}$ ,  $\text{SFDR} = 88\text{ dBc}$ ,  $\text{SFDR} = 91\text{ dBc}$  (non 23)

图 6-4. FFT for 140-MHz Input Signal

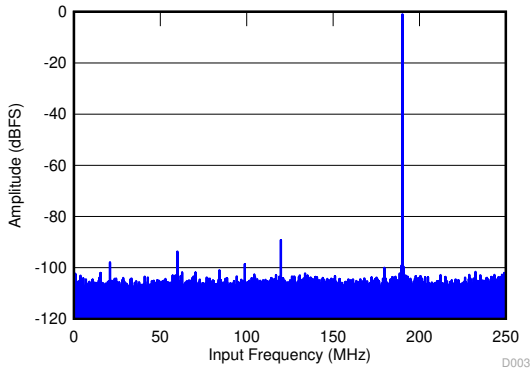

$f_{\text{IN}} = 190\text{ MHz}$ ,  $A_{\text{IN}} = -1\text{ dBFS}$ ,  $\text{SNR} = 69.4\text{ dBFS}$ ,  $\text{SFDR} = 88\text{ dBc}$ ,  $\text{SFDR} = 96\text{ dBc}$  (non 23)

图 6-5. FFT for 190-MHz Input Signal

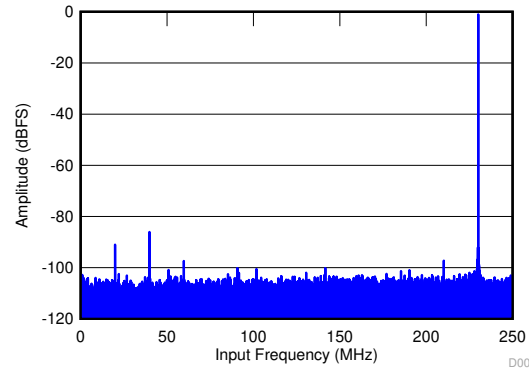

$f_{\text{IN}} = 230\text{ MHz}$ ,  $A_{\text{IN}} = -1\text{ dBFS}$ ,  $\text{SNR} = 69.4\text{ dBFS}$ ,  $\text{SFDR} = 85\text{ dBc}$ ,  $\text{SFDR} = 96\text{ dBc}$  (non 23)

图 6-6. FFT for 230-MHz Input Signal

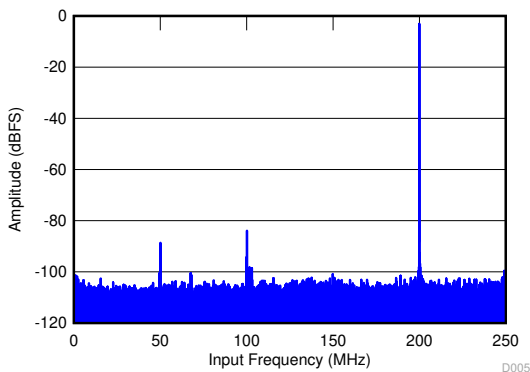

$f_{\text{IN}} = 300\text{ MHz}$ ,  $A_{\text{IN}} = -3\text{ dBFS}$ ,  $\text{SNR} = 69.4\text{ dBFS}$ ,  $\text{SFDR} = 80\text{ dBc}$ ,  $\text{SFDR} = 95\text{ dBc}$  (non 23)

图 6-7. FFT for 300-MHz Input Signal

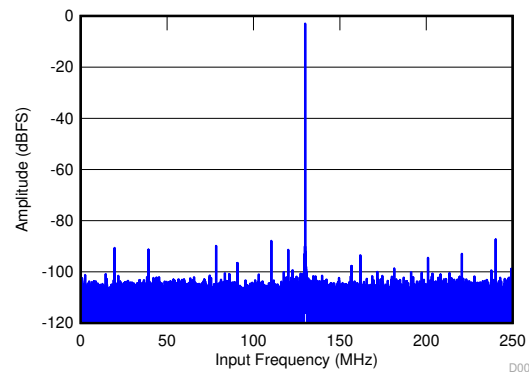

$f_{\text{IN}} = 370\text{ MHz}$ ,  $A_{\text{IN}} = -3\text{ dBFS}$ ,  $\text{SNR} = 68.4\text{ dBFS}$ ,  $\text{SFDR} = 84\text{ dBc}$ ,  $\text{SFDR} = 86\text{ dBc}$  (non 23)

图 6-8. FFT for 370-MHz Input Signal

### 6.9 Typical Characteristics: General (DDC Mode-8) (continued)

typical values are at  $T_A = 25^\circ\text{C}$ , full temperature range is from  $T_{\text{MIN}} = -40^\circ\text{C}$  to  $T_{\text{MAX}} = 85^\circ\text{C}$ , ADC sampling frequency = 500 MSPS, 14-bit resolution, no decimation filter, 50% clock duty cycle,  $\text{AVDD3V} = 3\text{ V}$ ,  $\text{AVDD} = \text{DVDD} = 1.9\text{ V}$ ,  $\text{IOVDD} = 1.15\text{ V}$ ,  $-1\text{-dBFS}$  differential input for  $\text{IF} \leq 250\text{ MHz}$ , and  $-3\text{-dBFS}$  differential input for  $\text{IF} > 250\text{ MHz}$  (unless otherwise noted)

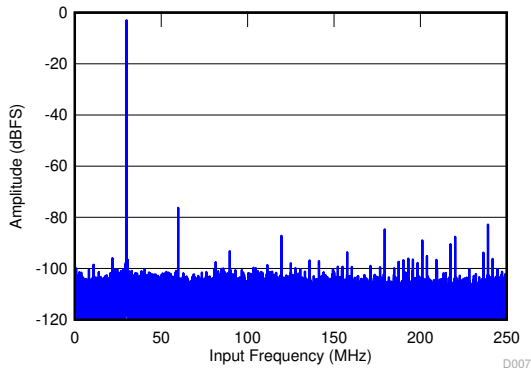

$f_{\text{IN}} = 470\text{ MHz}$ ,  $A_{\text{IN}} = -3\text{ dBFS}$ ,  $\text{SNR} = 67.4\text{ dBFS}$ ,  $\text{SFDR} = 73\text{ dBc}$ ,  $\text{SFDR} = 80\text{ dBc}$  (non 23)

图 6-9. FFT for 470-MHz Input Signal

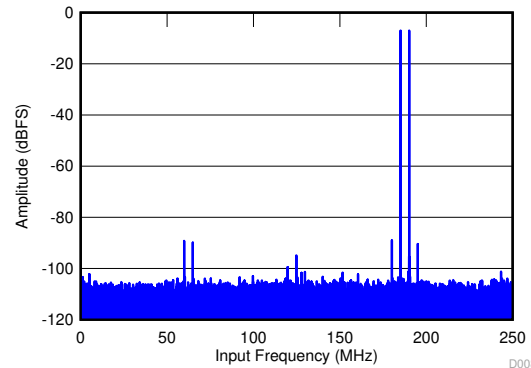

$f_{\text{IN1}} = 185\text{ MHz}$ ,  $f_{\text{IN2}} = 190\text{ MHz}$ ,  $\text{IMD} = 89\text{ dBFS}$ , each tone at  $-7\text{ dBFS}$

图 6-10. FFT for Two-Tone Input Signal

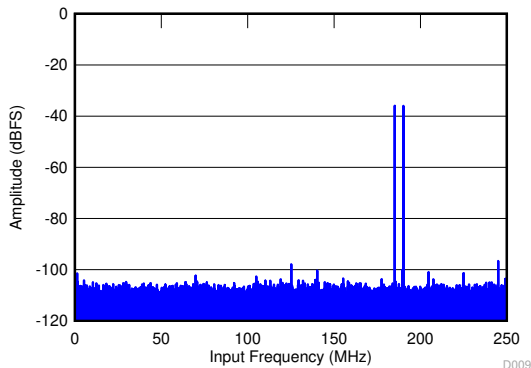

$f_{\text{IN1}} = 185\text{ MHz}$ ,  $f_{\text{IN2}} = 190\text{ MHz}$ ,  $\text{IMD} = 103\text{ dBFS}$ , each tone at  $-36\text{ dBFS}$

图 6-11. FFT for Two-Tone Input Signal

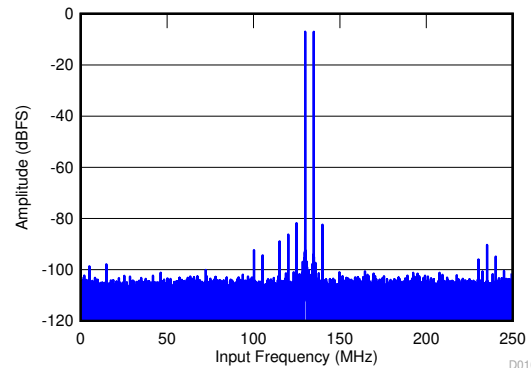

$f_{\text{IN1}} = 370\text{ MHz}$ ,  $f_{\text{IN2}} = 365\text{ MHz}$ ,  $\text{IMD} = 81.7\text{ dBFS}$ , each tone at  $-7\text{ dBFS}$

图 6-12. FFT for Two-Tone Input Signal

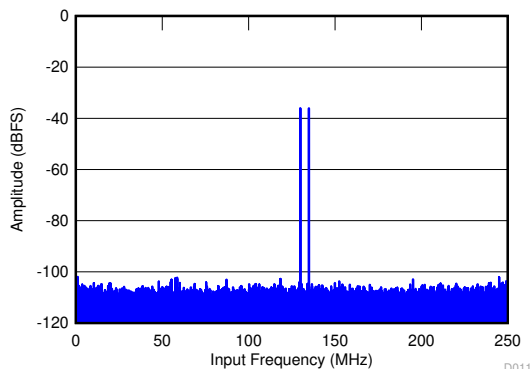

$f_{\text{IN1}} = 370\text{ MHz}$ ,  $f_{\text{IN2}} = 365\text{ MHz}$ ,  $\text{IMD} = 102\text{ dBFS}$ , each tone at  $-36\text{ dBFS}$

图 6-13. FFT for Two-Tone Input Signal

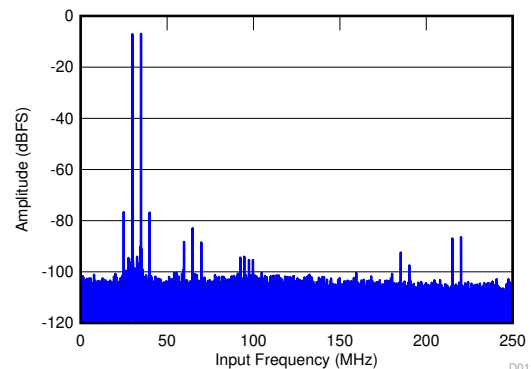

$f_{\text{IN1}} = 470\text{ MHz}$ ,  $f_{\text{IN2}} = 465\text{ MHz}$ ,  $\text{IMD} = 76.7\text{ dBFS}$ , each tone at  $-7\text{ dBFS}$

图 6-14. FFT for Two-Tone Input Signal

### 6.9 Typical Characteristics: General (DDC Mode-8) (continued)

typical values are at  $T_A = 25^\circ\text{C}$ , full temperature range is from  $T_{\text{MIN}} = -40^\circ\text{C}$  to  $T_{\text{MAX}} = 85^\circ\text{C}$ , ADC sampling frequency = 500 MSPS, 14-bit resolution, no decimation filter, 50% clock duty cycle, AVDD3V = 3 V, AVDD = DVDD = 1.9 V, IOVDD = 1.15 V, -1-dBFS differential input for  $IF \leq 250$  MHz, and -3-dBFS differential input for  $IF > 250$  MHz (unless otherwise noted)



图 6-15. FFT for Two-Tone Input Signal



图 6-16. Intermodulation Distortion vs Input Amplitude

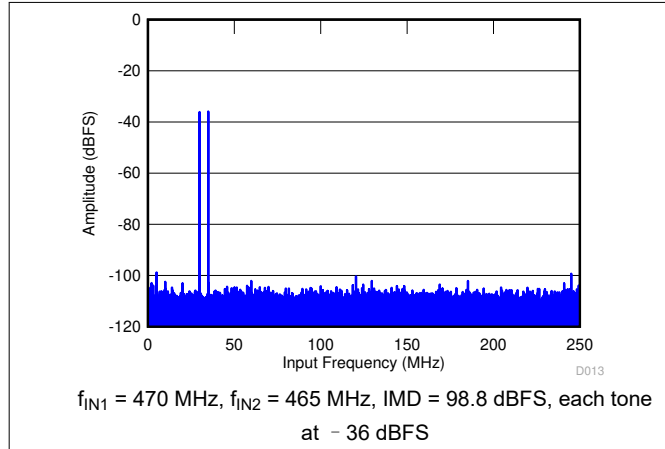

图 6-17. Intermodulation Distortion vs Input Amplitude

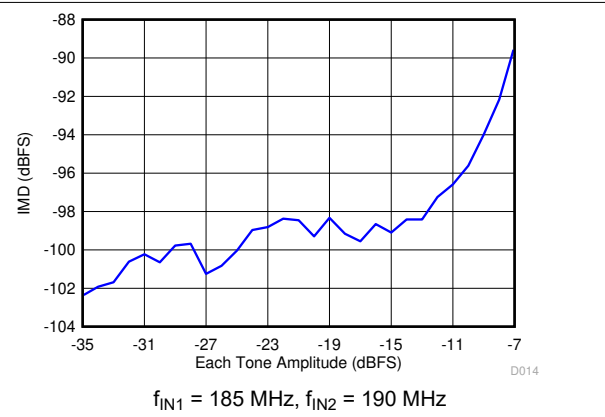

图 6-18. Intermodulation Distortion vs Input Amplitude

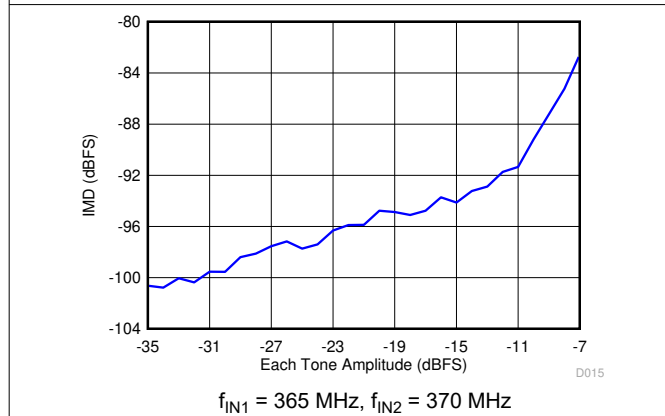

图 6-19. Spurious-Free Dynamic Range vs Input Frequency

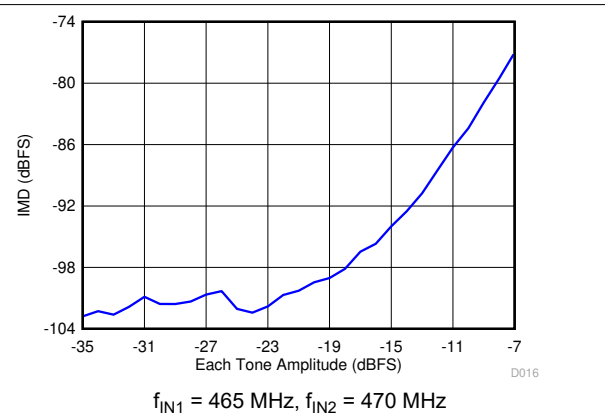

图 6-20. IL Spur vs Input Frequency

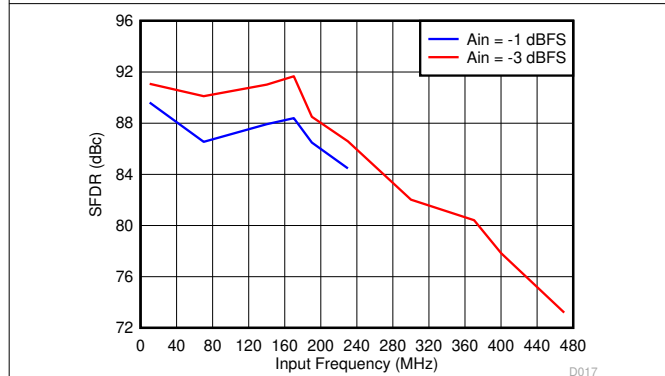

### 6.9 Typical Characteristics: General (DDC Mode-8) (continued)

typical values are at  $T_A = 25^\circ\text{C}$ , full temperature range is from  $T_{\text{MIN}} = -40^\circ\text{C}$  to  $T_{\text{MAX}} = 85^\circ\text{C}$ , ADC sampling frequency = 500 MSPS, 14-bit resolution, no decimation filter, 50% clock duty cycle,  $\text{AVDD3V} = 3\text{ V}$ ,  $\text{AVDD} = \text{DVDD} = 1.9\text{ V}$ ,  $\text{IOVDD} = 1.15\text{ V}$ , -1-dBFS differential input for  $f_{\text{IN}} \leq 250\text{ MHz}$ , and -3-dBFS differential input for  $f_{\text{IN}} > 250\text{ MHz}$  (unless otherwise noted)

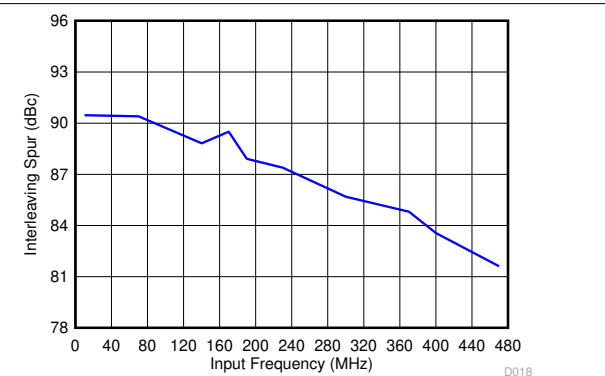

图 6-21. Signal-to-Noise Ratio vs Input Frequency



$f_{\text{IN}} = 190\text{ MHz}$ ,  $A_{\text{IN}} = -1\text{ dBFS}$

图 6-22. Signal-to-Noise Ratio vs AVDD Supply and Temperature

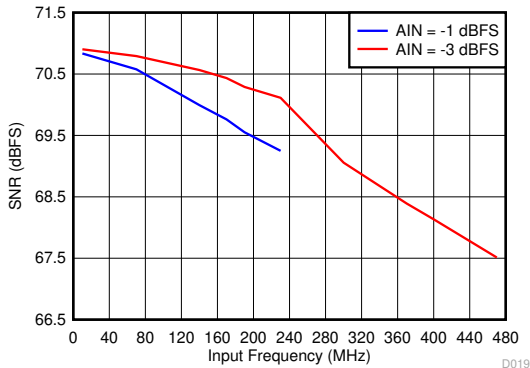
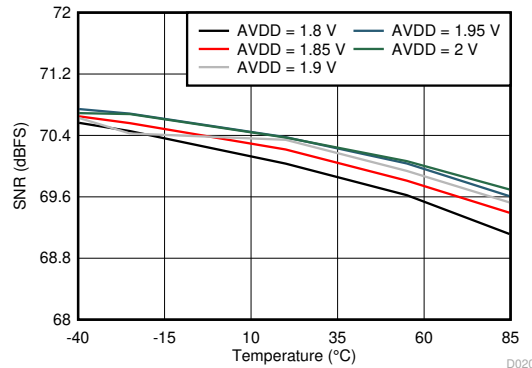
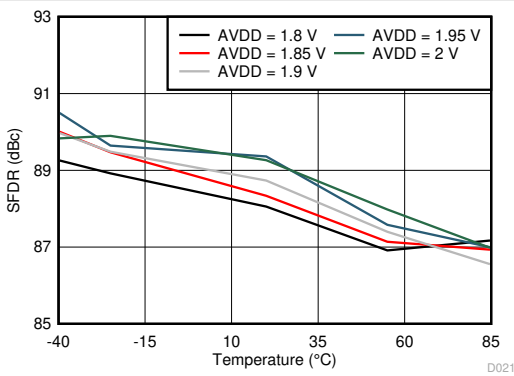

$f_{\text{IN}} = 190\text{ MHz}$ ,  $A_{\text{IN}} = -1\text{ dBFS}$

图 6-23. Spurious-Free Dynamic Range vs AVDD Supply and Temperature

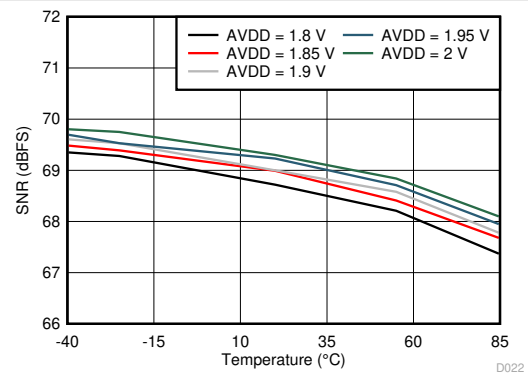

$f_{\text{IN}} = 370\text{ MHz}$ ,  $A_{\text{IN}} = -3\text{ dBFS}$

图 6-24. Signal-to-Noise Ratio vs AVDD Supply and Temperature

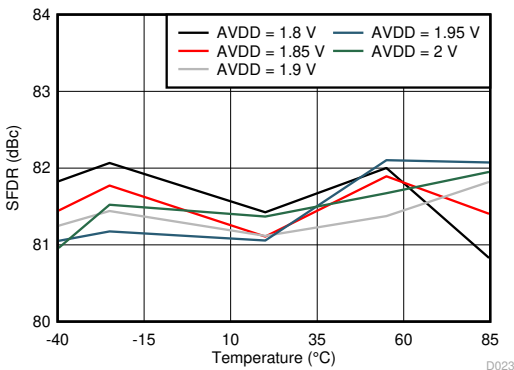

$f_{\text{IN}} = 370\text{ MHz}$ ,  $A_{\text{IN}} = -3\text{ dBFS}$

图 6-25. Spurious-Free Dynamic Range vs AVDD Supply and Temperature

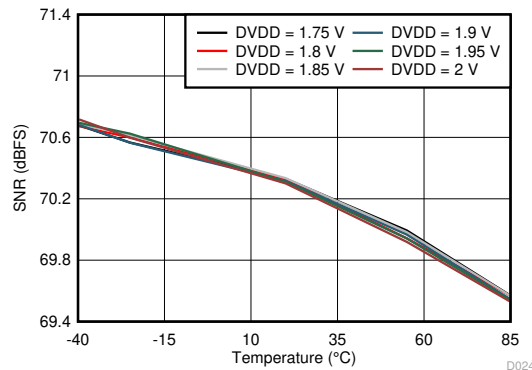

$f_{\text{IN}} = 190\text{ MHz}$ ,  $A_{\text{IN}} = -1\text{ dBFS}$

图 6-26. Signal-to-Noise Ratio vs DVDD Supply and Temperature

### 6.9 Typical Characteristics: General (DDC Mode-8) (continued)

typical values are at  $T_A = 25^\circ\text{C}$ , full temperature range is from  $T_{\text{MIN}} = -40^\circ\text{C}$  to  $T_{\text{MAX}} = 85^\circ\text{C}$ , ADC sampling frequency = 500 MSPS, 14-bit resolution, no decimation filter, 50% clock duty cycle, AVDD3V = 3 V, AVDD = DVDD = 1.9 V, IOVDD = 1.15 V, -1-dBFS differential input for  $f_{\text{IN}} \leq 250$  MHz, and -3-dBFS differential input for  $f_{\text{IN}} > 250$  MHz (unless otherwise noted)



图 6-27. Spurious-Free Dynamic Range vs DVDD Supply and Temperature



图 6-28. Signal-to-Noise Ratio vs DVDD Supply and Temperature

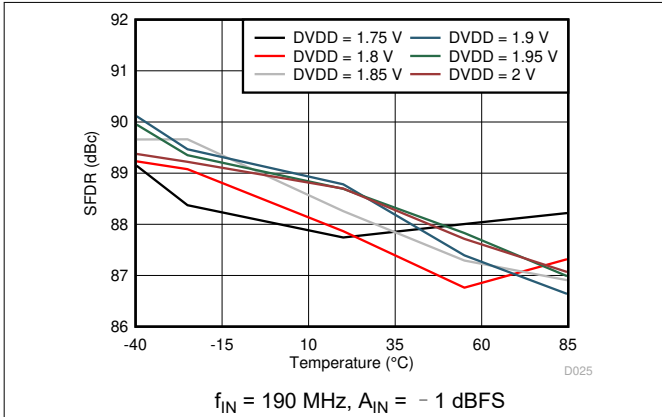

图 6-29. Spurious-Free Dynamic Range vs DVDD Supply and Temperature

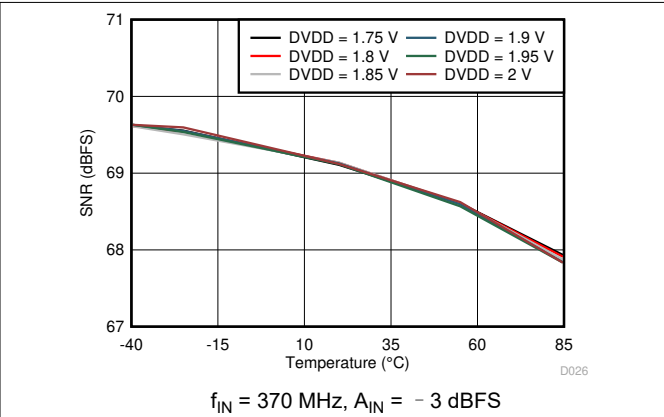

图 6-30. Signal-to-Noise Ratio vs AVDD3V Supply and Temperature

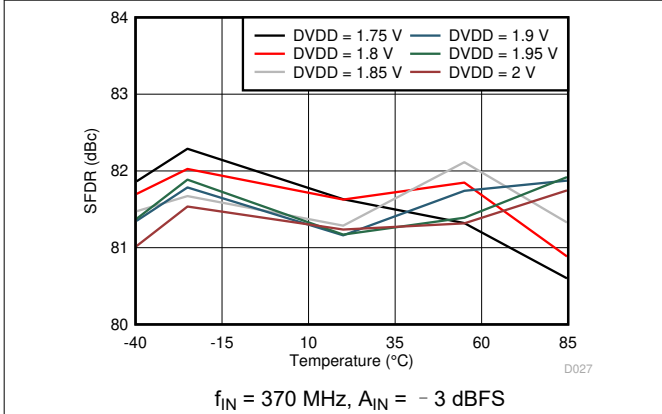

图 6-31. Spurious-Free Dynamic Range vs AVDD3V Supply and Temperature

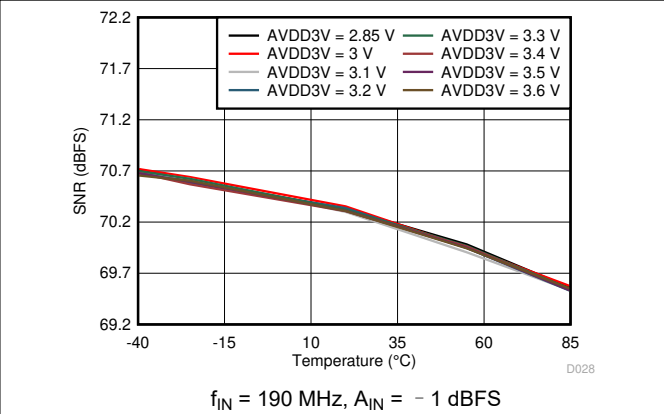

图 6-32. Signal-to-Noise Ratio vs AVDD3V Supply and Temperature

### 6.9 Typical Characteristics: General (DDC Mode-8) (continued)

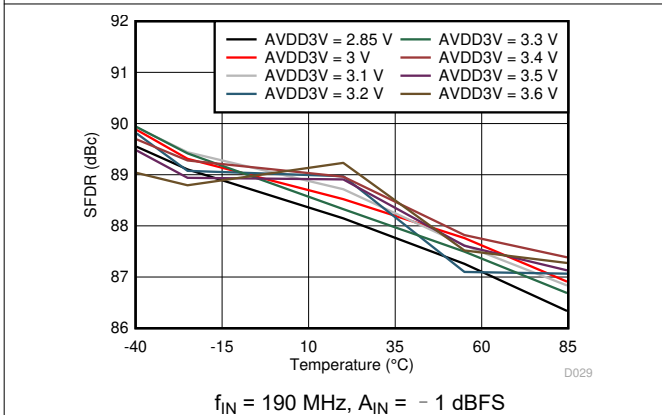
typical values are at  $T_A = 25^\circ\text{C}$ , full temperature range is from  $T_{\text{MIN}} = -40^\circ\text{C}$  to  $T_{\text{MAX}} = 85^\circ\text{C}$ , ADC sampling frequency = 500 MSPS, 14-bit resolution, no decimation filter, 50% clock duty cycle, AVDD3V = 3 V, AVDD = DVDD = 1.9 V, IOVDD = 1.15 V, -1-dBFS differential input for  $f_{\text{IN}} \leq 250$  MHz, and -3-dBFS differential input for  $f_{\text{IN}} > 250$  MHz (unless otherwise noted)

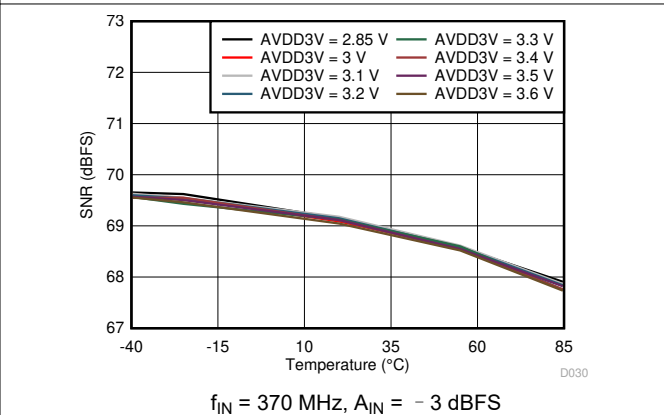

图 6-33. Spurious-Free Dynamic Range vs AVDD3V Supply and Temperature



图 6-34. Performance vs Amplitude

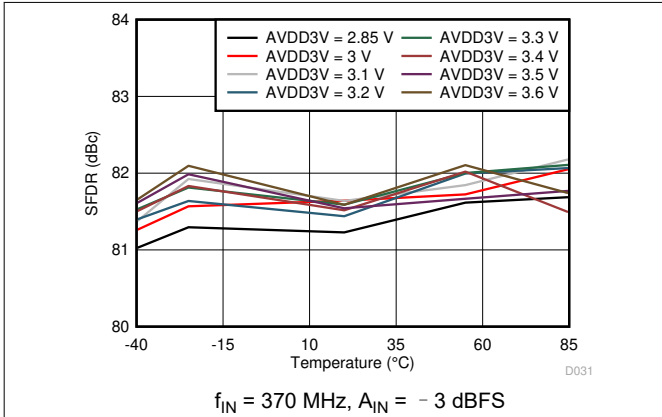

图 6-35. Performance vs Amplitude

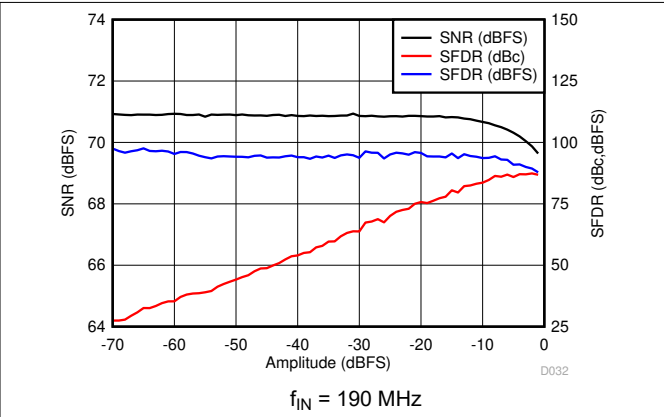

图 6-36. Performance vs Clock Amplitude

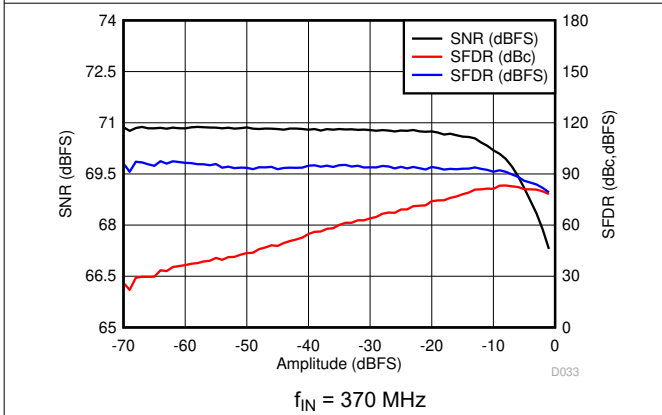

图 6-37. Performance vs Clock Amplitude

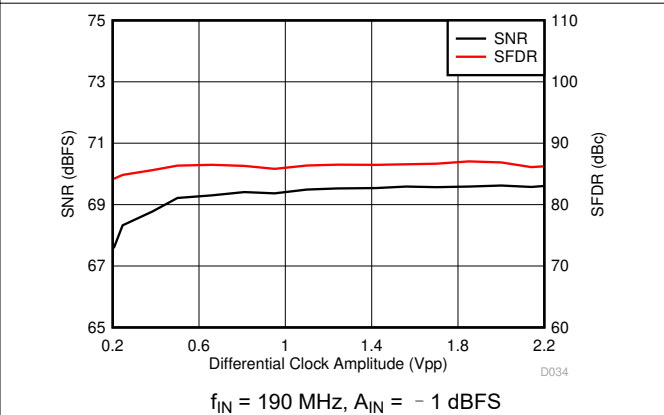

图 6-38. Performance vs Clock Duty Cycle

### 6.9 Typical Characteristics: General (DDC Mode-8) (continued)

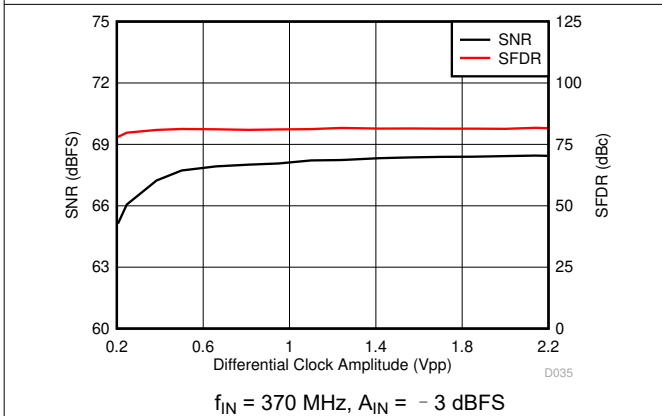
typical values are at  $T_A = 25^\circ\text{C}$ , full temperature range is from  $T_{\text{MIN}} = -40^\circ\text{C}$  to  $T_{\text{MAX}} = 85^\circ\text{C}$ , ADC sampling frequency = 500 MSPS, 14-bit resolution, no decimation filter, 50% clock duty cycle, AVDD3V = 3 V, AVDD = DVDD = 1.9 V, IOVDD = 1.15 V, -1-dBFS differential input for  $f_{\text{IN}} \leq 250$  MHz, and -3-dBFS differential input for  $f_{\text{IN}} > 250$  MHz (unless otherwise noted)

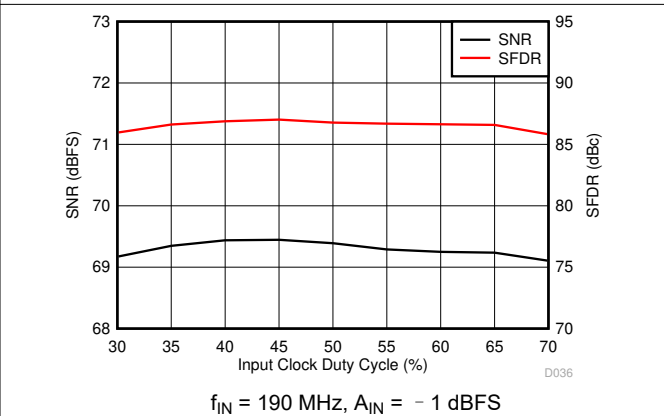
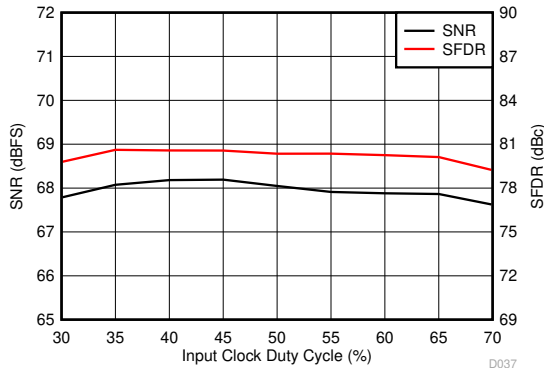

$f_{\text{IN}} = 370$  MHz,  $A_{\text{IN}} = -3$  dBFS

图 6-39. Performance vs Clock Duty Cycle

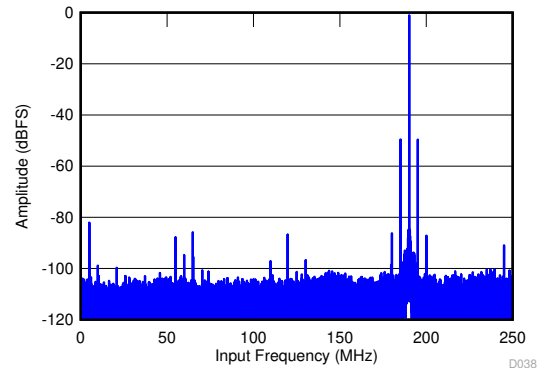

$f_{\text{IN}} = 190$  MHz,  $A_{\text{IN}} = -1$  dBFS SFDR = 49 dBc,  $f_{\text{PSRR}} = 5$  MHz,  $A_{\text{PSRR}} = 50$  mV<sub>PP</sub>

图 6-40. Power-Supply Rejection Ratio FFT for Test Signal on AVDD Supply

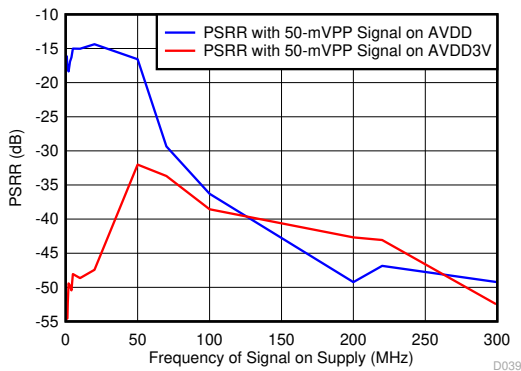

$f_{\text{IN}} = 190$  MHz,  $A_{\text{IN}} = -1$  dBFS

图 6-41. Power-Supply Rejection Ratio vs Supplies

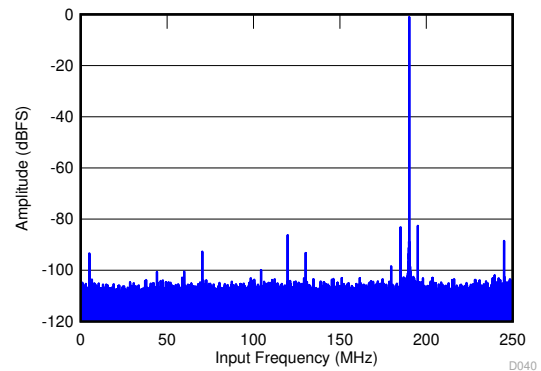

$f_{\text{IN}} = 190$  MHz,  $A_{\text{IN}} = -1$  dBFS SFDR = 81,  $f_{\text{CMRR}} = 5$  MHz,  $A_{\text{CMRR}} = 50$  mV<sub>PP</sub>

图 6-42. Common-Mode Rejection Ratio FFT

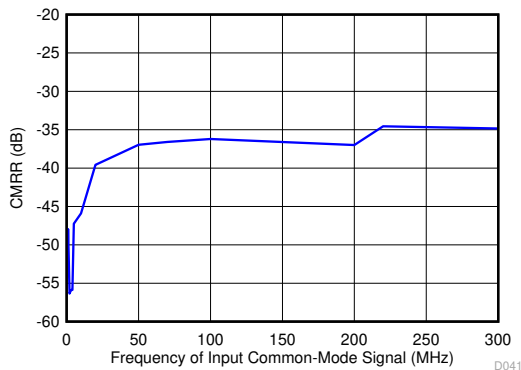

$f_{\text{IN}} = 190$  MHz,  $A_{\text{IN}} = -1$  dBFS 50-mV<sub>PP</sub> test signal on input common-mode

图 6-43. Common-Mode Rejection Ratio



图 6-44. Power vs Chip Clock

## 6.10 Typical Characteristics: Mode 2

low-pass or high-pass decimation-by-2 filter selected as per input frequency; typical values are at  $T_A = 25^\circ\text{C}$ , full temperature range is from  $T_{\text{MIN}} = -40^\circ\text{C}$  to  $T_{\text{MAX}} = 85^\circ\text{C}$ , ADC sampling frequency = 500 MSPS, 14-bit resolution, no decimation filter, 50% clock duty cycle,  $AVDD3V = 3\text{ V}$ ,  $AVDD = DVDD = 1.9\text{ V}$ ,  $IOVDD = 1.15\text{ V}$ , -1-dBFS differential input for  $IF \leq 250\text{ MHz}$ , and -3-dBFS differential input for  $IF > 250\text{ MHz}$  (unless otherwise noted)

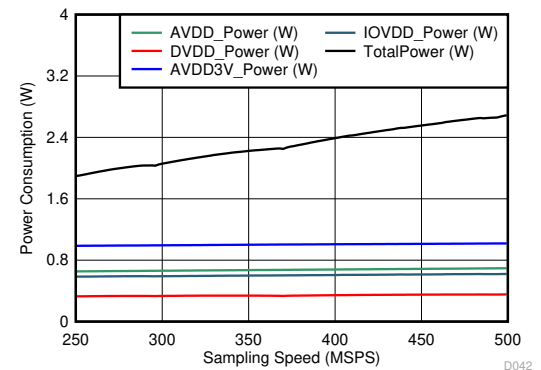
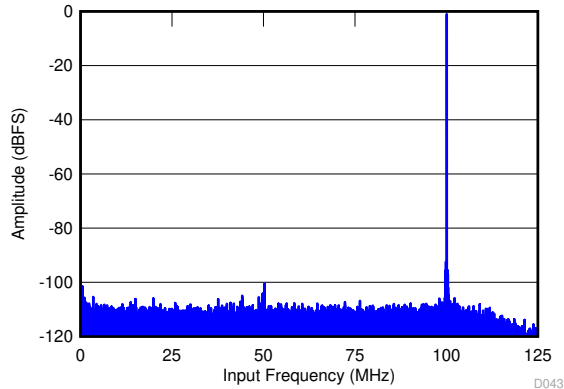

$f_{\text{IN}} = 100\text{ MHz}$ ,  $A_{\text{IN}} = -1\text{ dBFS}$ ,  $\text{SNR} = 74.1\text{ dBFS}$ ,  $\text{SFDR} = 98\text{ dBc}$ ,  $\text{SFDR} = 100\text{ dBc}$  (non 23)

图 6-45. FFT for 100-MHz Input Signal

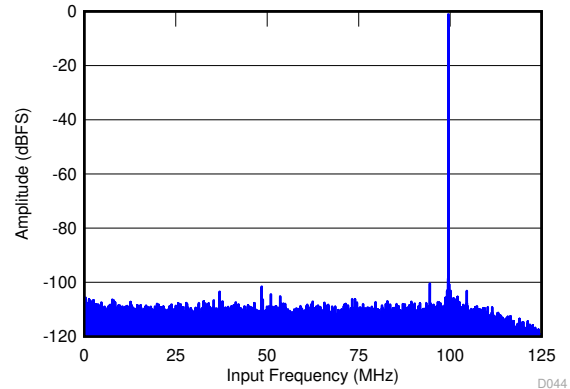

$f_{\text{IN}} = 150\text{ MHz}$ ,  $A_{\text{IN}} = -1\text{ dBFS}$ ,  $\text{SNR} = 73.8\text{ dBFS}$ ,  $\text{SFDR} = 99\text{ dBc}$ ,  $\text{SFDR} = 99\text{ dBc}$  (non 23)

图 6-46. FFT for 150-MHz Input Signal

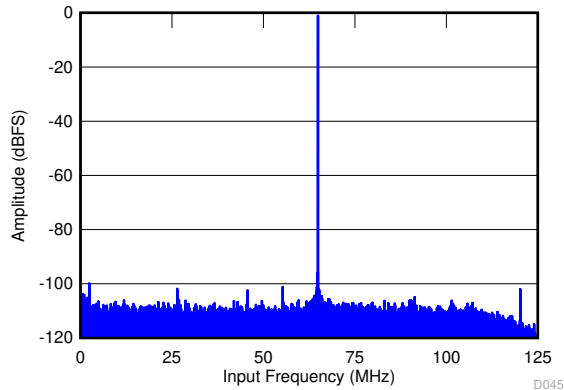

$f_{\text{IN}} = 185\text{ MHz}$ ,  $A_{\text{IN}} = -1\text{ dBFS}$ ,  $\text{SNR} = 73.2\text{ dBFS}$ ,  $\text{SFDR} = 98\text{ dBc}$ ,  $\text{SFDR} = 98\text{ dBc}$  (non 23)

图 6-47. FFT for 185-MHz Input Signal

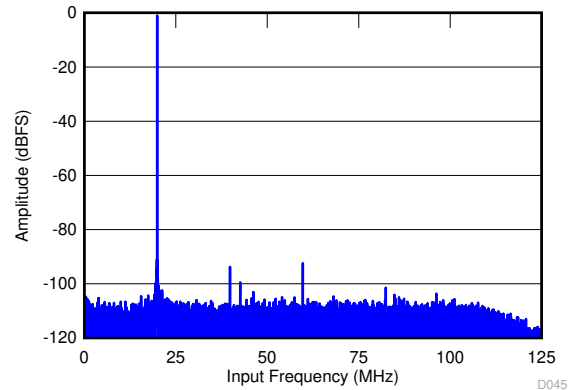

$f_{\text{IN}} = 230\text{ MHz}$ ,  $A_{\text{IN}} = -1\text{ dBFS}$ ,  $\text{SNR} = 72.4\text{ dBFS}$ ,  $\text{SFDR} = 91\text{ dBc}$ ,  $\text{SFDR} = 98\text{ dBc}$  (non 23)

图 6-48. FFT for 230-MHz Input Signal

### 6.11 Typical Characteristics: Mode 0

low-pass decimation-by-2 filter selected, complex FFT plotted, mixer frequency 125 MHz; typical values are at  $T_A = 25^\circ\text{C}$ , full temperature range is from  $T_{\text{MIN}} = -40^\circ\text{C}$  to  $T_{\text{MAX}} = 85^\circ\text{C}$ , ADC sampling frequency = 500 MSPS, 14-bit resolution, no decimation filter, 50% clock duty cycle, AVDD3V = 3 V, AVDD = DVDD = 1.9 V, IOVDD = 1.15 V, -1-dBFS differential input for  $IF \leq 250$  MHz, and -3-dBFS differential input for  $IF > 250$  MHz (unless otherwise noted)

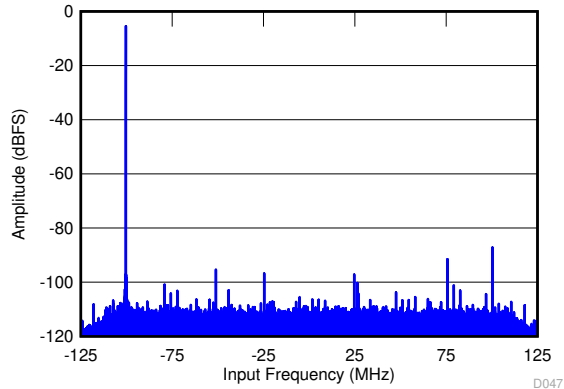

$f_{\text{IN}} = 270$  MHz,  $A_{\text{IN}} = -3$  dBFS, SNR = 69.5 dBFS, SFDR = 83 dBc, SFDR = 87 dBc (non 23)

图 6-49. FFT for 270-MHz Input Signal

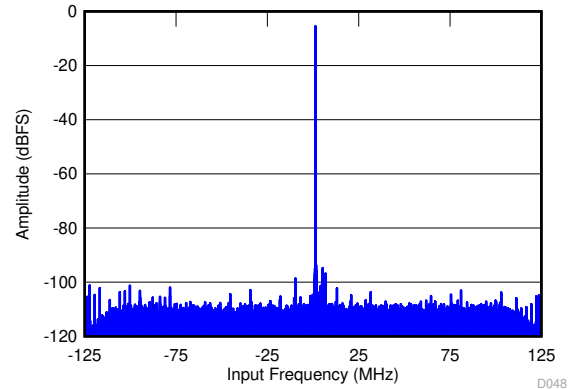

$f_{\text{IN}} = 370$  MHz,  $A_{\text{IN}} = -3$  dBFS, SNR = 68.1 dBFS, SFDR = 82 dBc, SFDR = 82 dBc (non 23)

图 6-50. FFT for 370-MHz Input Signal

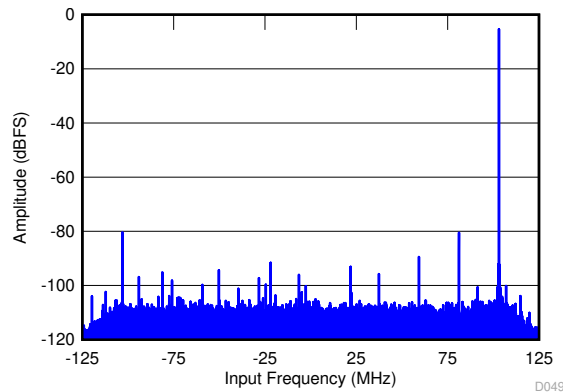

$f_{\text{IN}} = 470$  MHz,  $A_{\text{IN}} = -3$  dBFS, SNR = 66.3 dBFS, SFDR = 75 dBc, SFDR = 75 dBc (non 23)

图 6-51. FFT for 470-MHz Input Signal

## 7 Detailed Description

### 7.1 Overview

The ADS54J66 is a low-power, wide-bandwidth, 14-bit, 500-MSPS, quad-channel, telecom receiver device. The ADS54J66 supports the JESD204B serial interface with data rates up to 10 Gbps supporting one lane per channel. The buffered analog input provides uniform input impedance across a wide frequency range and minimizes sample-and-hold glitch energy. The ADS54J66 provides excellent spurious-free dynamic range (SFDR) over a large input frequency range with very low power consumption. The device digital block includes a 2x and 4x decimation low-pass filter with  $f_S / 4$  and  $k \times f_S / 16$  mixers to support a receive bandwidth up to 200 MHz for use as a Digital Pre-Distortion (DPD) observation receiver.

The JESD204B interface reduces the number of interface lines allowing high system integration density. An internal phase locked loop (PLL) multiplies the incoming ADC sampling clock to derive the bit clock which is used to serialize the 14-bit data from each channel.

### 7.2 Functional Block Diagram

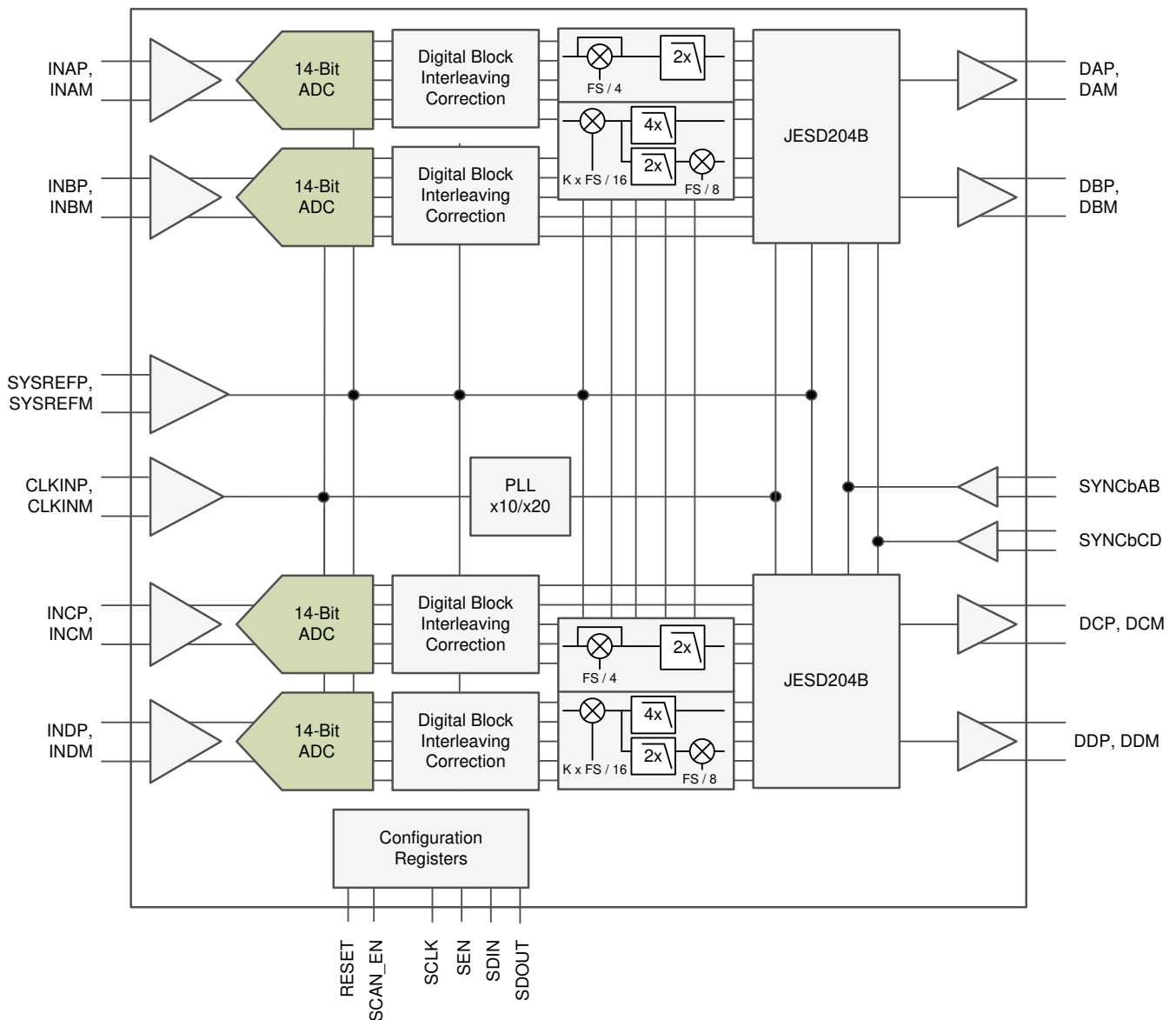

## 7.3 Feature Description

### 7.3.1 Analog Inputs

The ADS54J66 analog signal inputs are designed to be driven differentially. The analog input pins have internal analog buffers that drive the sampling circuit. As a result of the analog buffer, the input pins present a high impedance input across a very wide frequency range to the external driving source which enables great flexibility in the external analog filter design as well as excellent 50- $\Omega$  matching for RF applications. The buffer also helps isolate the external driving circuit from the internal switching currents of the sampling circuit, thus resulting in a more constant SFDR performance across input frequencies.

The common-mode voltage of the signal inputs is internally biased to 1.9 V using 600- $\Omega$  resistors which allows for ac coupling of the input drive network. Each input pin (INP, INM) must swing symmetrically between ( $V_{CM} + 0.475$  V) and ( $V_{CM} - 0.475$  V), resulting in a 1.9-V<sub>PP</sub> (default) differential input swing. The input sampling circuit has a 3-dB bandwidth that extends up to 900 MHz.

### 7.3.2 Recommended Input Circuitry

In order to achieve optimum ac performance the circuitry shown in [图 7-1](#) is recommended at the analog inputs.



图 7-1. Analog Input Driving Circuit



## 7.4 Device Functional Modes

### 7.4.1 Digital Features

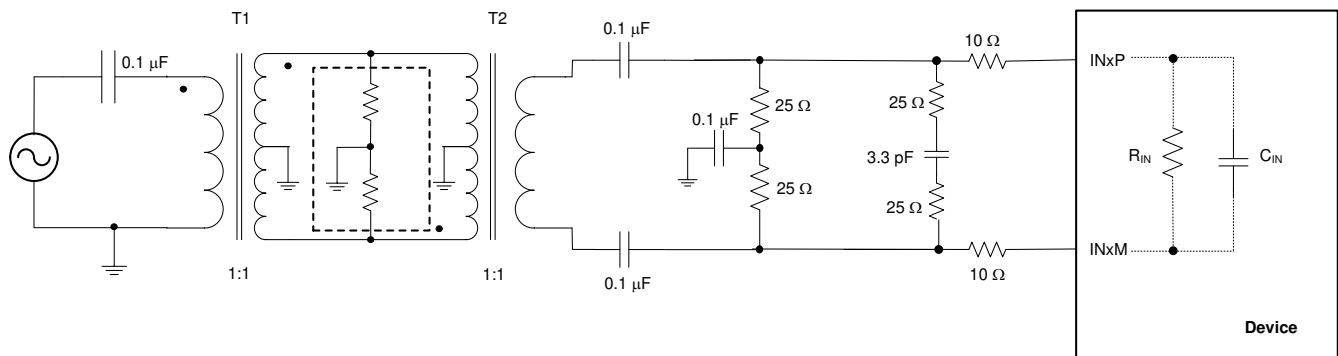
The ADS54J66 supports decimation-by-2 and -4 and un-decimated output. The four channels can be configured as pairs (A, B and C, D; however, the same decimation factor must be chosen for all four channels).

图 7-2 shows signal processing done in the digital down-conversion (DDC) block of the ADS54J66. 表 7-1 shows available modes of operation for this block.



图 7-2. Digital Down-Conversion Block Diagram

表 7-1. Overview of Operating Modes

OPERATING MODE	DESCRIPTION	DIGITAL MIXER	DECIMATION	BANDWIDTH		OUTPUT FORMAT	MAX OUTPUT RATE
				491 MSPS	368 MSPS		
0	Decimation	$\pm f_s / 4$	2	200 MHz	150 MHz	Complex	250 MSPS
2		-	2	100 MHz	75 MHz	Real	250 MSPS
4		$N \times f_s / 16$	2	100 MHz	75 MHz	Real	250 MSPS
5		$N \times f_s / 16$	2	200 MHz	150 MHz	Complex	250 MSPS
6		$N \times f_s / 16$	4	100 MHz	75 MHz	Complex	125 MSPS
7		$N \times f_s / 16$	2	100 MHz	75 MHz	Real	500 MSPS
8	No decimation	-	-	245.76 MHz	184.32 MHz	Real	500 MSPS

表 7-2 shows characteristics of different blocks of DDC signal processing blocks active in different modes.

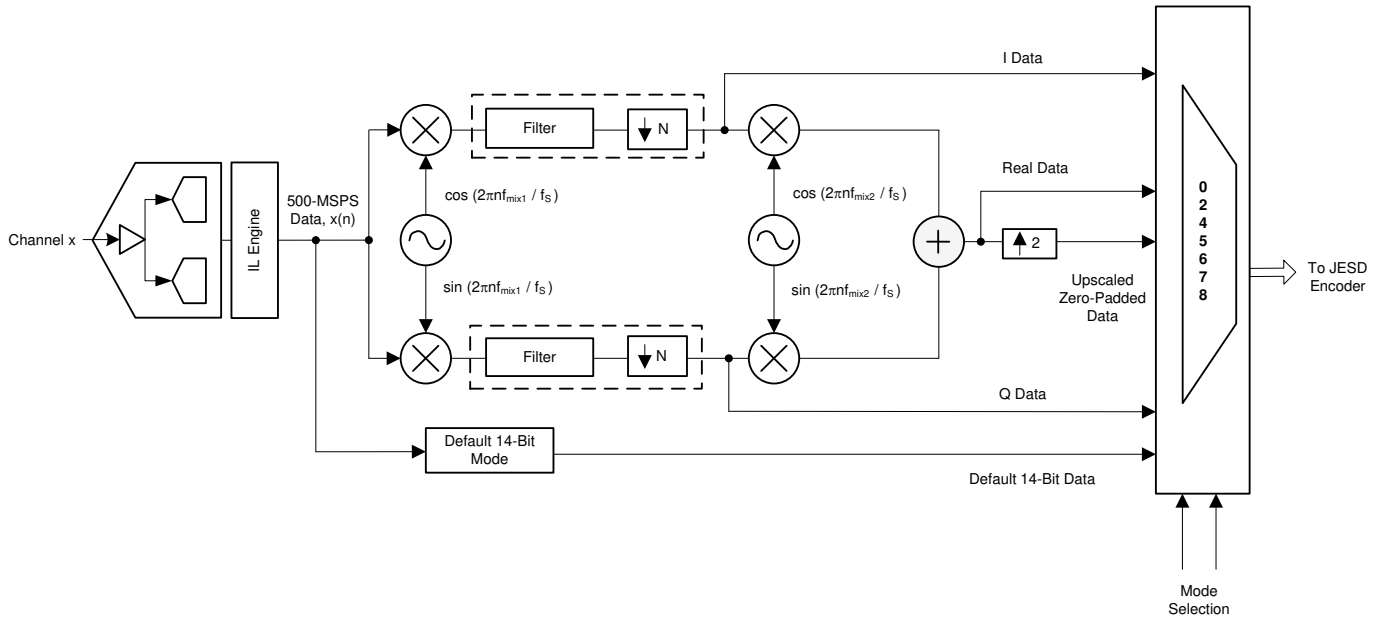
表 7-2. Features of DDC Block in Different Modes

MODE	$f_{mix1}$	FILTER AND DECIMATION	$f_{mix2}$	OUTPUT
0	$f_s / 4$	LPF cutoff at $f_s / 4$ , decimation-by-2	Not used	I, Q data at 250 MSPS each are given out
2	Not used	LPF or HPF cutoff at $f_s / 4$ , decimation-by-2	Not used	Straight 250 MSPS data are given out
4	$k f_s / 16$	LPF cutoff at $f_s / 8$ , decimation-by-2	$f_s / 8$	Real data at 250 MSPS are given out
5	$k f_s / 16$	LPF cutoff at $f_s / 8$ , decimation-by-2	Not used	I, Q data at 250 MSPS each are given out
6	$k f_s / 16$	LPF cutoff at $f_s / 8$ , decimation-by-4	Not used	I, Q data at 125 MSPS each are given out
7	$k f_s / 16$	LPF cutoff at $f_s / 8$ , decimation-by-2	$f_s / 8$	Real data are up-scaled, zero-padded and given out at 500 MSPS
Default	Not used	Not used	Not used	Straight 500-MSPS, 14-bit data are given out

### 7.4.2 Mode 0, Decimation-by-2 with IQ Outputs for up to 220 MHz of IQ Bandwidth

In this configuration, the DDC block includes a fixed frequency  $\pm f_s / 4$  complex digital mixer preceding the digital filter, so the IQ passband is approximately  $\pm 110$  MHz (3 dB) centered at  $f_s / 4$ . Mixing with  $+f_s / 4$  inverts the spectrum. The stop-band attenuation is approximately 90 dB and the pass-band flatness is  $\pm 0.1$  dB. 图 7-3 shows mixing operation in DDC mode 0. 表 7-3 shows corner frequencies of decimation filter in DDC mode 0. 图 7-4 and 图 7-5 show frequency response of the filter.



图 7-3. Mixing in Mode 0

表 7-3. Filter Specification Details, Mode 0

CORNERS	LOW PASS
- 0.1 dB	$0.204 \times f_s$
- 0.5 dB	$0.211 \times f_s$
- 1 dB	$0.216 \times f_s$
- 3 dB	$0.226 \times f_s$

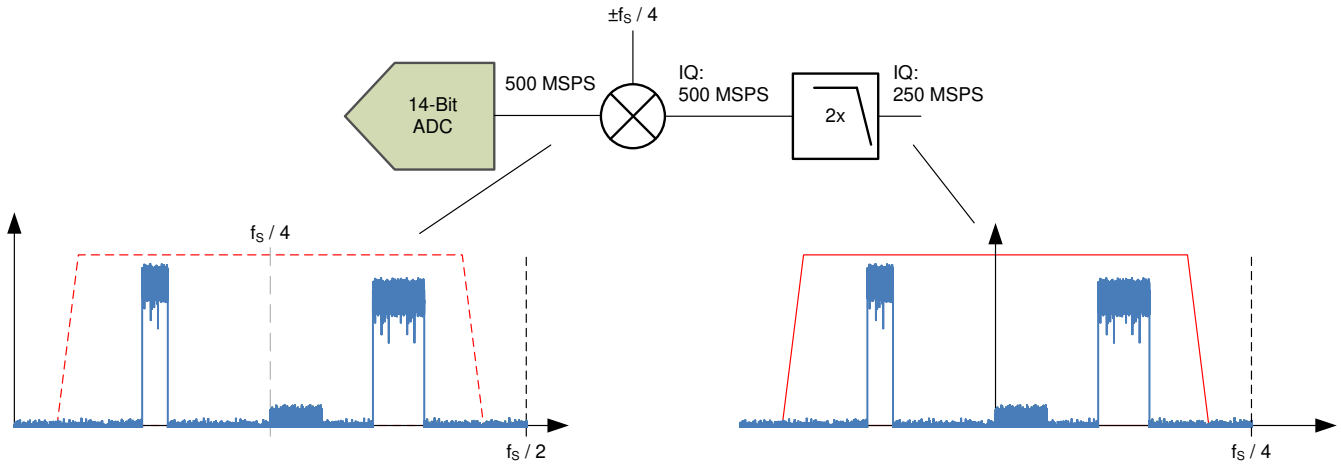
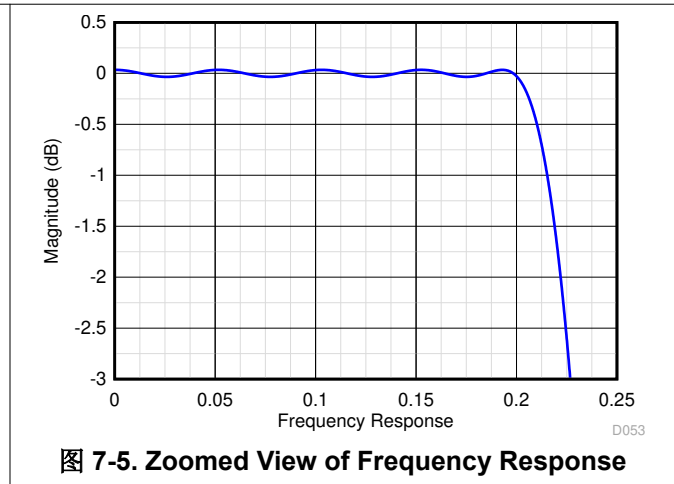
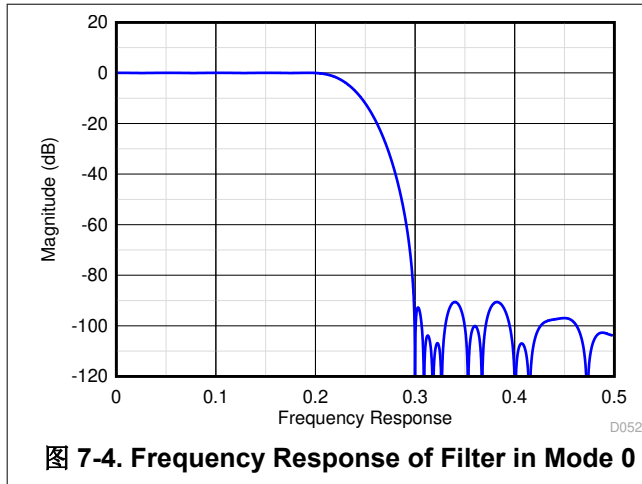

### 7.4.3 Mode 2, Decimation-by-2 for up to 110 MHz of Real Bandwidth

In this configuration, the DDC block only includes a 2x decimation filter (high pass or low pass) with real outputs. The pass band is approximately 110 MHz (3 dB). 图 7-6 shows the filtering operation in DDC mode 2. 表 7-4 shows corner frequencies of decimation filter in DDC mode 2. 图 7-7 and 图 7-8 show frequency response of the filter.



图 7-6. Filtering in Mode 2

表 7-4. Filter Specification Details, Mode 2

CORNERS	LOW PASS	HIGH PASS
- 0.1 dB	$0.204 \times f_s$	$0.296 \times f_s$
- 0.5 dB	$0.211 \times f_s$	$0.290 \times f_s$
- 1 dB	$0.216 \times f_s$	$0.284 \times f_s$
- 3 dB	$0.226 \times f_s$	$0.274 \times f_s$

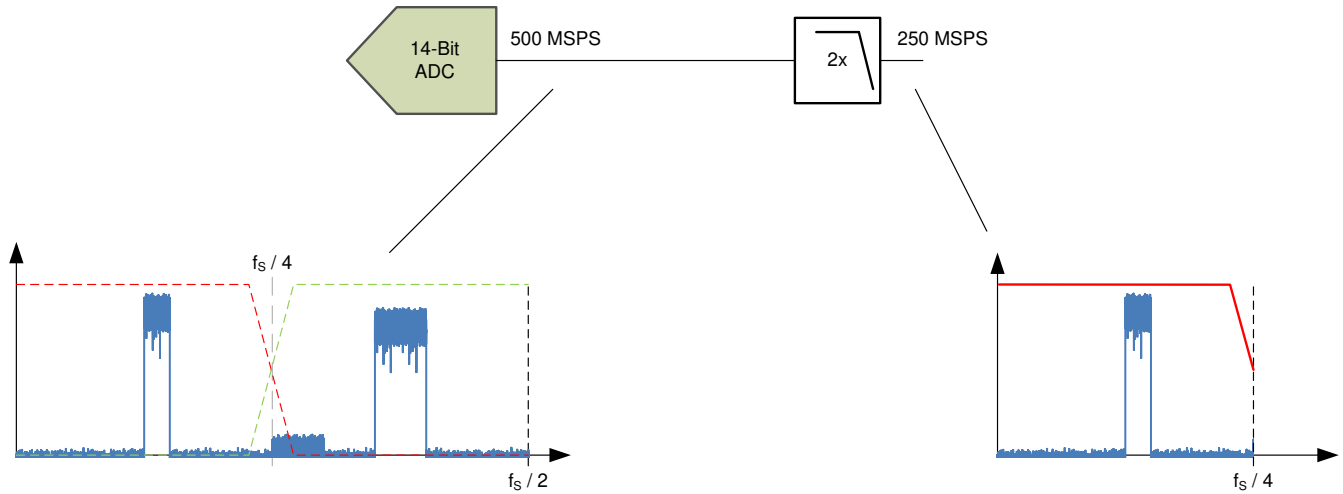
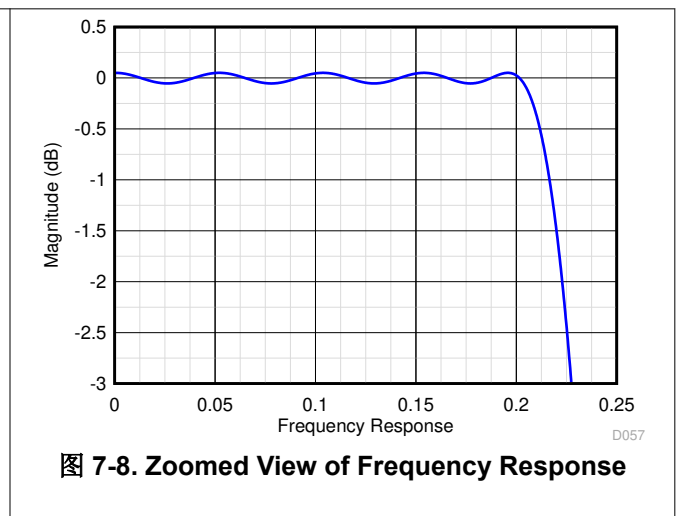
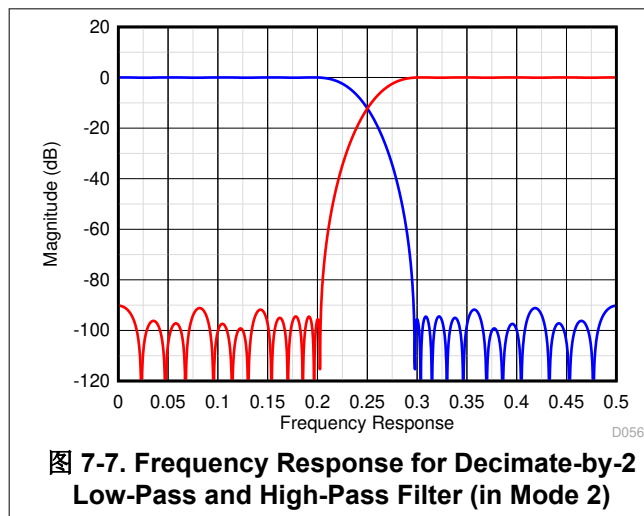

### 7.4.4 Modes 4 and 7, Decimation-by-2 with Real Outputs for up to 110 MHz of Bandwidth

In this configuration, the DDC block includes a selectable  $N \times f_s / 16$  complex digital mixer (N from -8 to +7) preceding the decimation-by-2 digital filter also with an IQ passband of approximately  $\pm 55$  MHz (3 dB) centered at  $N \times f_s / 16$ . A positive value for N inverts the spectrum. In addition, a  $f_s / 8$  complex digital mixer is added after the decimation filter transforming the output back to real format and centers the output spectrum within the Nyquist zone.

In addition, the ADS54J66 supports a 0-pad feature where a sample with value = 0 is added after each sample. In this way the output data rate is interpolated to 500 MSPS (real) with a second image inverted at  $f_s / 2 - f_{IN}$ .

The stop-band attenuation is approximately 90 dB for in-band aliases from negative frequencies and approximately 55 dB for out-of-band aliases. The passband flatness is  $\pm 0.1$  dB. 图 7-9 shows the filtering operation in DDC mode 4 and 7. 表 7-5 shows corner frequencies of decimation filter in DDC mode 4 and 7. 图 7-10 and 图 7-11 show frequency response of the filter.



图 7-9. Mixing and Filtering in Modes 4 and 7

表 7-5. Filter Specification Details, Modes 4 and 7

CORNERS	LOW PASS
- 0.1 dB	$0.102 \times f_s$
- 0.5 dB	$0.105 \times f_s$
- 1 dB	$0.108 \times f_s$
- 3 dB	$0.113 \times f_s$

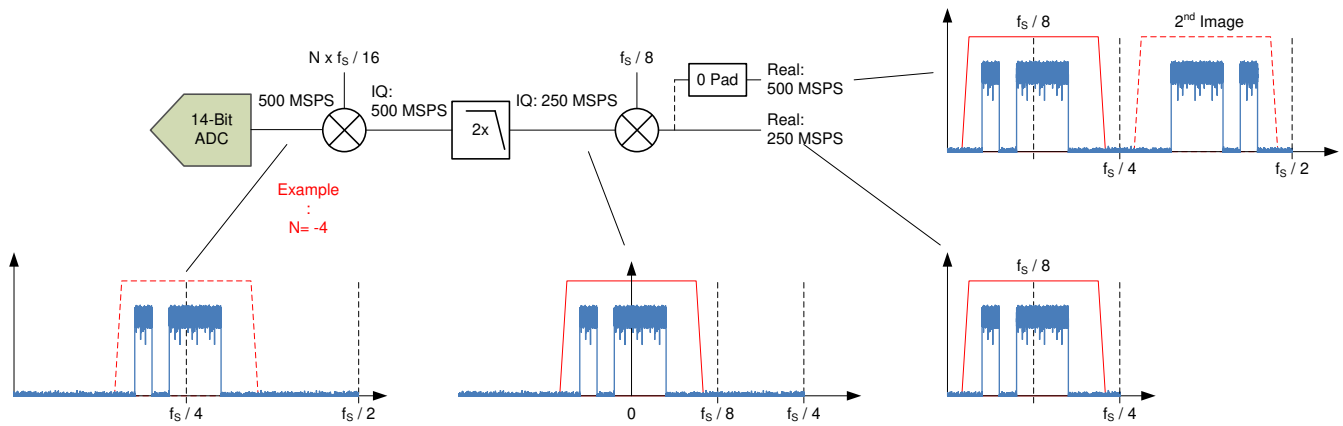

图 7-10. Frequency Response for Decimate-by-2, Low-Pass Filter (in Modes 4 and 7)



图 7-11. Zoomed View of Frequency Response

### 7.4.5 Mode 5, Decimation-by-2 with IQ Outputs for up to 110 MHz of IQ Bandwidth

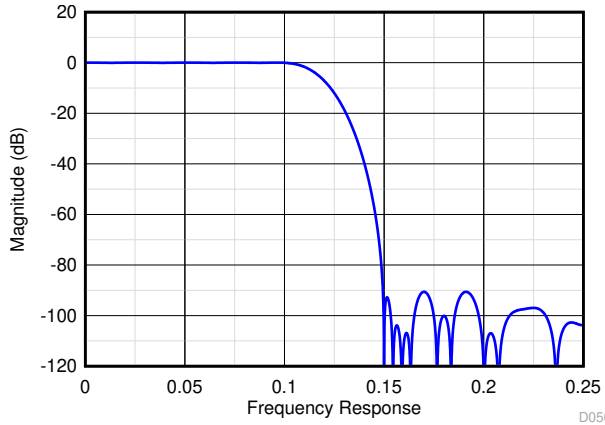
In this configuration, the DDC block includes a selectable  $N \times f_s / 16$  complex digital mixer ( $N$  from  $-8$  to  $+7$ ) preceding the decimation-by-2 digital filter, so the IQ passband is approximately  $\pm 55$  MHz (3 dB) centered at  $N \times f_s / 16$ . A positive value for  $N$  inverts the spectrum.

The stop-band attenuation is approximately 90 dB for in-band aliases from negative frequencies. The pass-band flatness is  $\pm 0.1$  dB. Figure 62 shows the filtering operation in DDC mode 5. Table 6 shows corner frequencies of decimation filter in DDC mode 5. Figure 63 and Figure 64 show frequency response of the filter. 图 7-12 shows the filtering operation in DDC mode 5. 表 7-6 shows corner frequencies of decimation filter in DDC mode 5. 图 7-13 and 图 7-14 show frequency response of the filter.

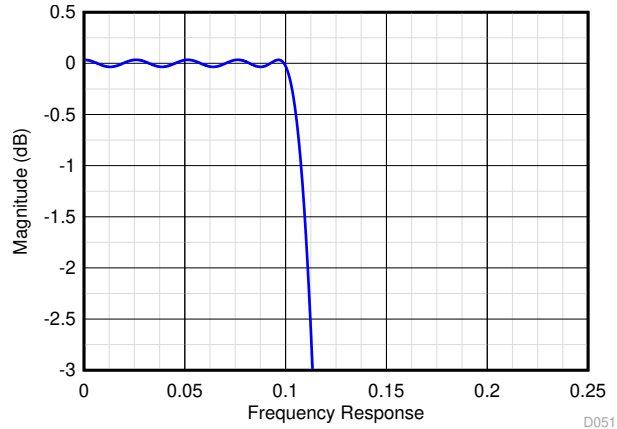

图 7-12. Mixing and Filtering in Mode 5

表 7-6. Filter Specification Details, Mode 5

CORNERS	LOW PASS
- 0.1 dB	$0.102 \times f_s$
- 0.5 dB	$0.105 \times f_s$
- 1 dB	$0.108 \times f_s$
- 3 dB	$0.113 \times f_s$

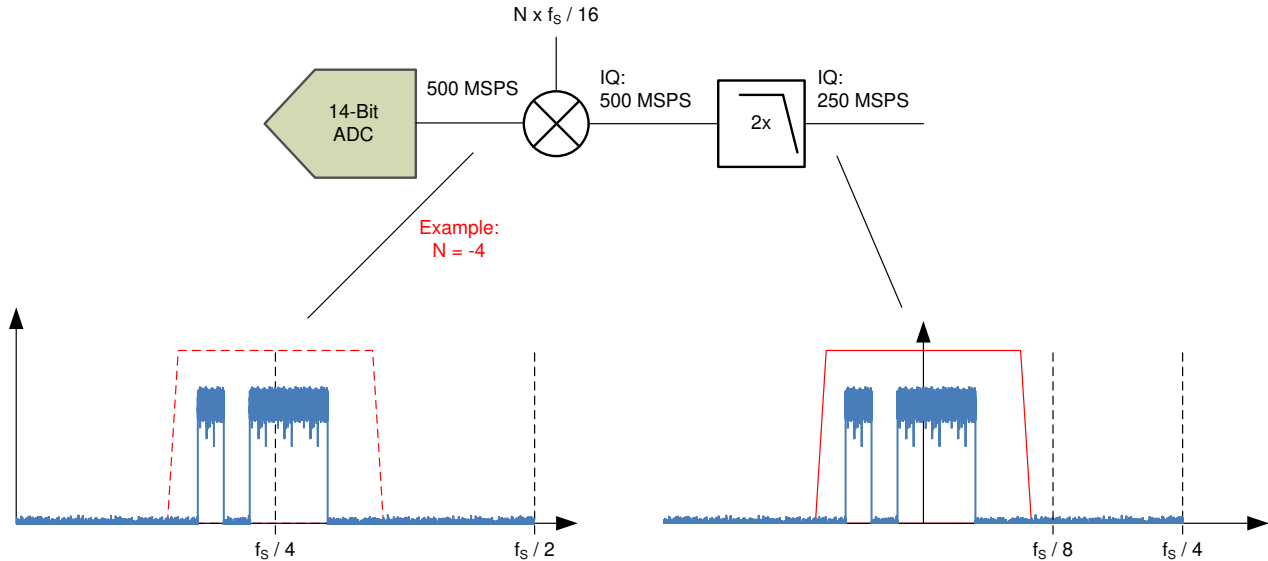

图 7-13. Frequency Response for Decimate-by-2, Low-Pass Filter (In Mode 5)



图 7-14. Zoomed View of Frequency Response

### 7.4.6 Mode 6, Decimation-by-4 with IQ Outputs for up to 110 MHz of IQ Bandwidth

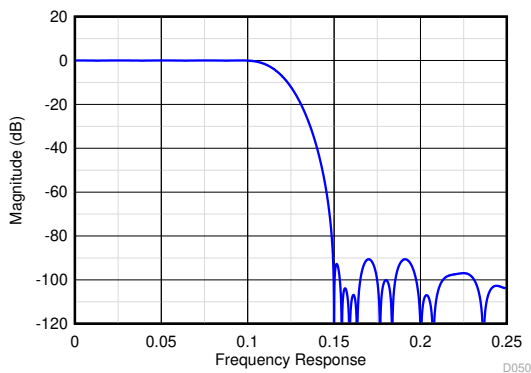
In this configuration, the DDC block includes a selectable  $N \times f_s / 16$  complex digital mixer (n from -8 to +7) preceding the decimation-by-4 digital filter, so the IQ passband is approximately  $\pm 55$  MHz (3 dB) centered at  $N \times f_s / 16$ . A positive value for N inverts the spectrum. 图 7-15 shows the filtering operation in DDC mode 6. 表 7-7 shows corner frequencies of decimation filter in DDC mode 6. The decimation-by-4 filter is a cascade of two decimation-by-2 filters with frequency response shown in 图 7-16 and 图 7-17.

The stop-band attenuation is approximately 90 dB for in-band aliases from negative frequencies and approximately 55 dB for out-of-band aliases. The pass-band flatness is  $\pm 0.1$  dB.

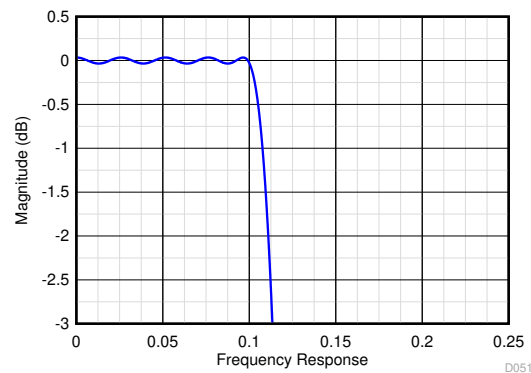

图 7-15. Mixing and Filtering in Mode 6

表 7-7. Filter Specification Details, Mode 6

CORNERS	LOW PASS
- 0.1 dB	$0.102 \times f_s$
- 0.5 dB	$0.105 \times f_s$
- 1 dB	$0.108 \times f_s$
- 3 dB	$0.113 \times f_s$

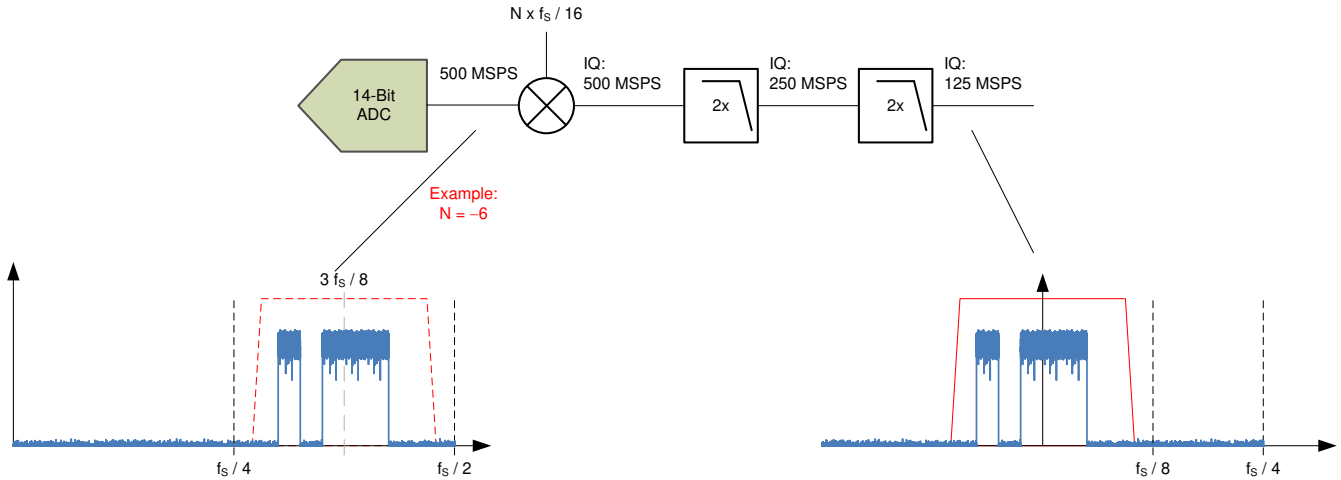

图 7-16. Frequency Response for Decimate-by-2, Low-Pass Filter (in Mode 6)



图 7-17. Zoomed View of Frequency Response

### 7.4.7 Overrange Indication

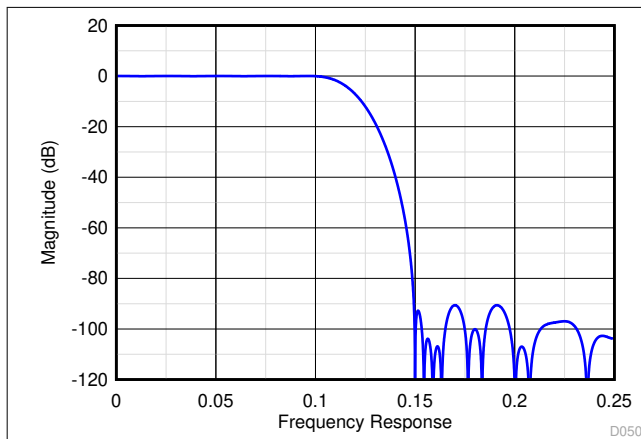
The ADS54J66 provides a fast overrange indication (FOVR) that can be presented in the digital output data stream via SPI configuration. When the FOVR indication is embedded in the output data stream, it replaces the LSB (normal 0) of the 16 bit going to the 8b/10b encoder as shown in 图 7-18.

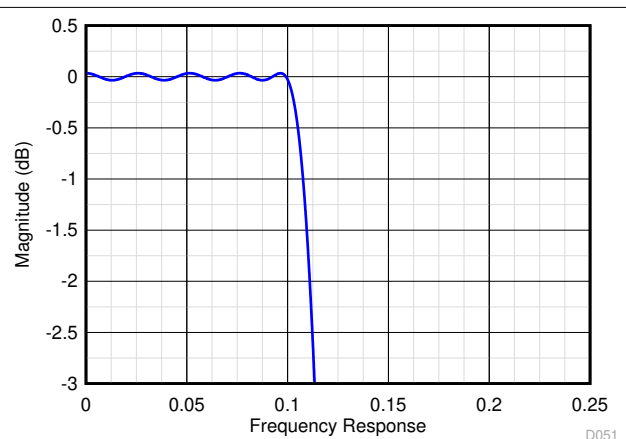

图 7-18. Timing Diagram for FOVR

The fast OVR is triggered if the input voltage exceeds the programmable overrange threshold and it gets presented after just 44 input clock cycles enabling a quicker reaction to an overrange event.

The input voltage level at which the overload is detected is referred to as the threshold. It is programmable using the FOVR THRESHOLD bits.

备注

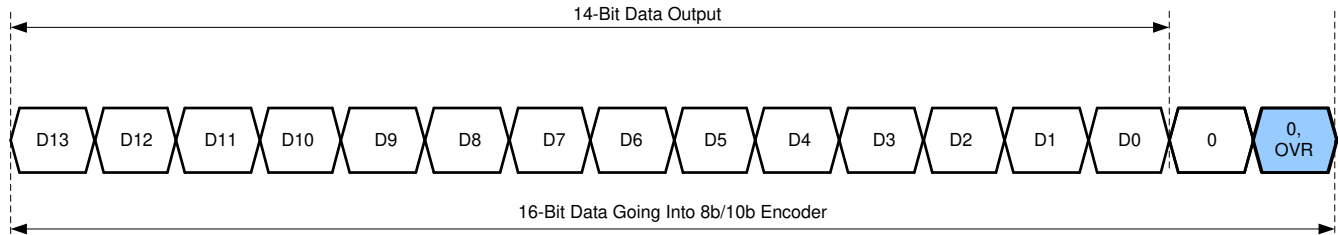
These register bits set the OVR threshold for all channels.

The input voltage level that fast OVR is triggered is:

Full-scale × [the decimal value of the FOVR threshold bits] / 255)

The default threshold is E3h (227), corresponding to a threshold of - 1 dBFS.

In terms of full-scale input, the fast OVR threshold can be calculated as shown in 方程式 1:

$$20 \times \log (<FOVR \text{ Threshold}> / 255). \tag{1}$$

表 7-8 is an example register write to set the FOVR threshold for all four channels.

表 7-8. Register Sequence for FOVR Configuration

ADDRESS	DATA	COMMENT
11h	80h	Go to master page
59h	20h	Set the ALWAYS WRITE 1 bit. This bit configures the OVR signal as fast OVR.
11h	0Fh	Go to ADC page
5Fh	FFh	Set FOVR threshold for all channels to 255
4004h	68h	Go to main digital page of the JESD bank
4003h	00h	
60ABh	01h	Enable bit D0 overwrite
70ABh	01h	Select FOVR to replace bit D0
60ADh	03h	
70ADh	03h	Pulse the IL RESET register bit. Register writes in main digital page take effect when the IL RESET register bit is pulsed.
6000h	01h	
7000h	01h	
6000h	00h	
7000h	00h	



### 7.4.8 Power-Down Mode

The ADS54J66 provides a highly-configurable power-down mode. Power-down can be enabled using the PDN pin or SPI register writes.

A power-down mask can be configured that allows a trade-off between wake-up time and power consumption in power-down mode. Two independent power-down masks can be configured: MASK 1 and MASK 2, as shown in [表 7-9](#). See the master page registers in [表 7-15](#) for further details.

**表 7-9. Register Address for Power-Down Modes**

REGISTER ADDRESS A[7:0] (Hex)	COMMENT	REGISTER DATA							
		7	6	5	4	3	2	1	0
<b>MASTER PAGE (80h)</b>									
20	MASK 1	PDN ADC CHAB				PDN ADC CHCD			
21		PDN BUFFER CHCD	PDN BUFFER CHAB		0	0	0	0	
23	MASK 2	PDN ADC CHAB				PDN ADC CHCD			
24		PDN BUFFER CHCD	PDN BUFFER CHAB		0	0	0	0	
26	CONFIG	GLOBAL PDN	OVERRIDE PDN PIN	PDN MASK SEL	0	0	0	0	0
53		0	MASK SYSREF	0	0	0	0	0	0
55		0	0	0	PDN MASK	0	0	0	0

To save power, the device can be put in complete power down by using the GLOBAL PDN register bit. However, when JESD link must remain up when putting the device in power down, the ADC and analog buffer can be powered down by using the PDN ADC CHx and PDN BUFFER CHx register bits after enabling the PDN MASK register bit. The PDN MASK SEL register bit can be used to select between MASK 1 or MASK 2. [表 7-10](#) shows power consumption for different combinations of the GLOBAL PDN, PDN ADC CHx, and PDN BUFF CHx register bits.

**表 7-10. Power Consumption in Different Power-Down Settings**

REGISTER BIT	COMMENT	IAVDD3V (mA)	IAVDD (mA)	IDVDD (mA)	IIOVDD (mA)	TOTAL POWER (W)
Default	After reset, with a full-scale input signal to both channels	0.340	0.365	0.184	0.533	2.675
GBL PDN = 1	The device is in complete power-down state	0.002	0.006	0.012	0.181	0.247
GBL PDN = 0, PDN ADC CHx = 1 (x = AB or CD)	The ADCs of one pair of channels are powered down	0.277	0.225	0.123	0.496	2.063
GBL PDN = 0, PDN BUFF CHx = 1 (x = AB or CD)	The input buffers of one pair of channels are powered down	0.266	0.361	0.187	0.527	2.445
GBL PDN = 0, PDN ADC CHx = 1, PDN BUFF CHx = 1 (x = AB or CD)	The ADCs and input buffers of one pair of channels are powered down	0.200	0.224	0.126	0.492	1.830
GBL PDN = 0, PDN ADC CHx = 1, PDN BUFF CHx = 1 (x = AB and CD)	The ADCs and input buffers of all channels are powered down	0.060	0.080	0.060	0.448	0.960

## 7.5 Programming

### 7.5.1 Device Configuration

The ADS54J66 can be configured using a serial programming interface, as described in this section. In addition, the device has one dedicated parallel pin (PDN) for controlling the power-down modes. The ADS54J66 supports a 24-bit (16-bit address, 8-bit data) SPI operation and uses paging (see the # 7.6.1 section) to access all register bits. 图 7-19 shows timing diagram for serial interface signals. SPI registers are grouped in two banks with each bank containing different pages (see 图 7-34).

First 4 MSBs of 16-bit address are special bits carrying information about register bank, page and channel to be programmed. 表 7-11 lists the purpose of each special bit.



图 7-19. Serial Interface Timing Diagram

表 7-11. Programing Details of Serial Interface

SPI BITS	DESCRIPTION	OPTIONS
R/W	Read/write bit	0 = SPI write 1 = SPI read back
M	SPI bank access	0 = Analog SPI bank (master and ADC page) 1 = Digital SPI bank (main digital, analog JESD, and digital JESD pages)
P	JESD page selection bit	0 = Page access 1 = Register access
CH	SPI access for a specific channel of the digital SPI bank	0 = Channel AB 1 = Channel CD By default, both channels are being addressed.
ADDR [11:0]	SPI address bits	—
DATA [7:0]	SPI data bits	—

### 7.5.1.1 Details of the Serial Interface

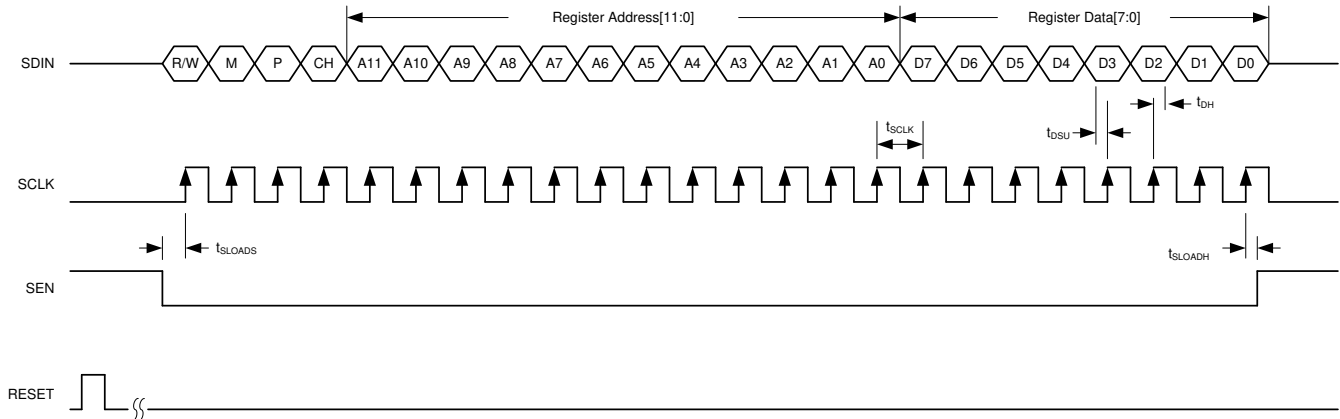
The ADC has a set of internal registers that can be accessed by the serial interface formed by the SEN (serial interface enable), SCLK (serial interface clock) and SDIN (serial interface data) pins. Serially shifting bits into the device is enabled when SEN is low. Serial data on SDIN are latched at every SCLK rising edge when SEN is active (low). The interface can function with SCLK frequencies from 5 MHz down to very low speeds (of a few hertz) and also with a non-50% SCLK duty cycle.

图 7-24 shows timing requirements for serial interface signals.

表 7-12. Serial Interface Timing Requirements<sup>(1)</sup>

		MIN	MAX	UNIT
$f_{SCLK}$	SCLK frequency (equal to $1 / t_{SCLK}$ )	> dc	20	MHz
$t_{SLOADS}$	SEN to SCLK setup time	25		ns
$t_{SLOADH}$	SCLK to SEN hold time	25		ns
$t_{DSU}$	SDATA setup time	25		ns
$t_{DH}$	SDATA hold time	25		ns

(1) Typical values are at 25°C. Minimum and maximum values are across the full temperature range of  $T_{MIN} = -40^{\circ}\text{C}$  to  $T_{MAX} = 100^{\circ}\text{C}$ ,  $AVDD3V = 3\text{ V}$ ,  $AVDD = 1.9\text{ V}$ , and  $DRVDD = 1.8\text{ V}$ , unless otherwise noted.

### 7.5.1.2 Serial Register Write: Analog Bank

The analog SPI bank contains of two pages (the master and ADC page). The internal register of the ADS54J66 analog SPI bank can be programmed by:

1. Drive the SEN pin low.
2. Initiate a serial interface cycle specifying the page address of the register whose content must be written.
  - Master page: write address 0011h with 80h.
  - ADC page: write address 0011h with 0Fh.
3. Write the register content as shown in 图 7-20. When a page is selected, multiple writes into the same page can be done.



图 7-20. Serial Register Write Timing Diagram

### 7.5.1.3 Serial Register Readout: Analog Bank

The content from one of the two analog banks can be read out by:

1. Drive the SEN pin low.
2. Select the page address of the register whose content must be read.
  - Master page: write address 0011h with 80h.
  - ADC page: write address 0011h with 0Fh.
3. Set the R/W bit to 1 and write the address to be read back.
4. Read back the register content on the SDOOUT pin, as shown in [图 7-21](#). When a page is selected, multiple read backs from the same page can be done.

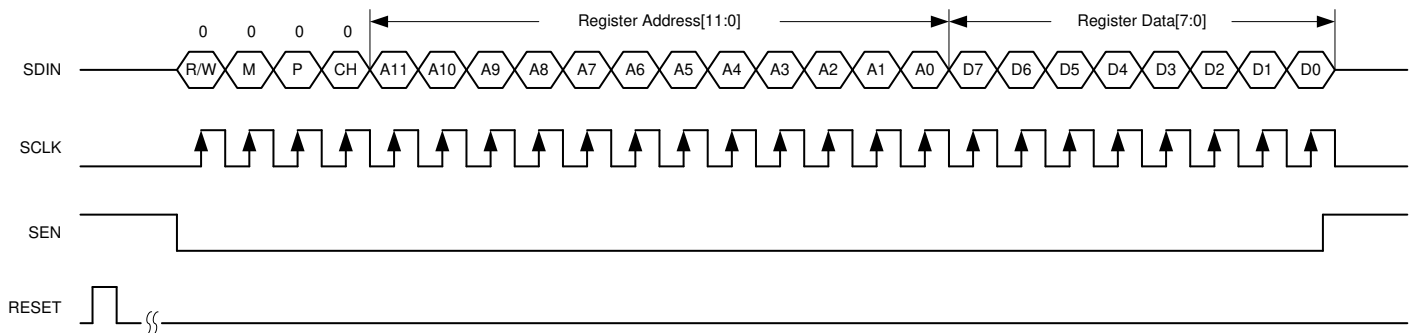
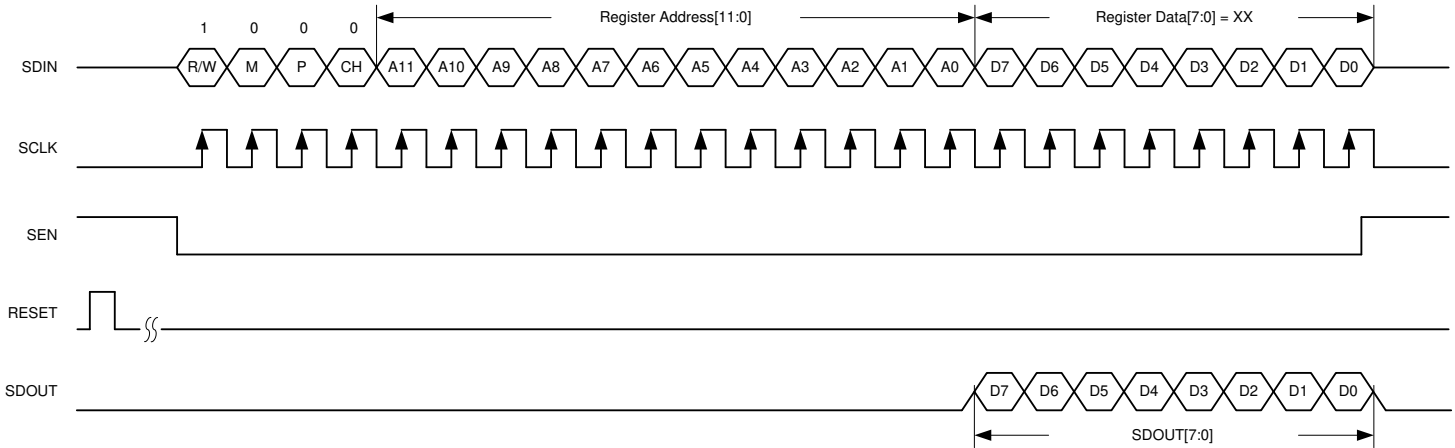

**图 7-21. Serial Register Read Timing Diagram**

### 7.5.1.4 JESD Bank SPI Page Selection

The JESD SPI bank contains five pages (main digital, interleaving engine, decimation filter, JESD digital, and JESD analog). The individual pages can be selected following these steps:

1. Drive the SEN pin low.
2. Set the M bit to 1 and specify the page with two register writes (Note: the P bit is set to 0)
  - Write address 4003h with 00h (LSB byte of the page address)
  - Write address 4004h MSB byte of the page address
  - Main digital page: write address = 4004h with 68h (default)
  - Digital JESD page: write address = 4004h with 69h
  - Analog JESD page: write address = 4004h with 6Ah
  - Interleaving engine page: write address = 4004h with 61h
  - Decimation filter page: write address = 4004h with 61h and 4003h with 41h

图 7-22 shows the serial interface signals when pages in the JESD bank are being accessed. Note that the P bit is set to 0.



图 7-22. SPI Timing Diagram for Accessing a Page in the JESD Bank

### 7.5.1.5 Serial Register Write: Digital Bank

The ADS54J66 is a quad-channel device and the JESD204B portion is configured individually for two channels (A, B and C, D) using the CH bit. Note that the P bit must be set to 1 for register writes.

1. Drive the SEN pin low.
2. Select the JESD bank page (Note: M bit = 1, P bit = 0)
  - Write address 4003h with 00h
  - Main digital page: write address = 4004h with 68h (default)
  - Digital JESD page: write address = 4004h with 69h
  - Analog JESD page: write address = 4004h with 6Ah
  - Interleaving Engine page: write address = 4004h with 61h
  - Decimation Filter page: write address = 4004h with 61h and 4003h with 41h
3. Set the M and P bit to 1 and select channels A, B (CH = 0) or C, D (CH = 1) and write the register content. When a page is selected, multiple writes into the same page can be done. By default, register writes are applied to both channel pairs (broadcast mode). To disable broadcast mode and enable individual channel writes, write address 4005h with 01h (default is 00h).

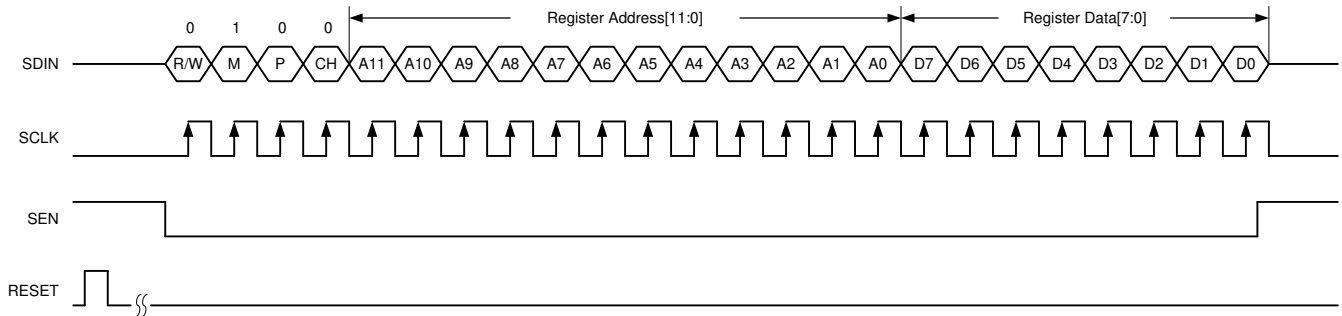
图 7-23 shows the serial interface signals when a register in the desired page of the JESD bank is programmed (note that the P bit must be set to 1 in this step).



图 7-23. SPI Timing Diagram for Writing a Register in the JESD Bank (After Page is Accessed)

### 7.5.1.6 Individual Channel Programming

By default, register writes are applied to both channels in a group (for example, the register writes are applied to channels A and B if the CH bit is 0, or the register writes are applied to channels C and D if the CH bit is 1). This form of programming is referred to as *broadcast mode*.

For pages located in the JESD bank, the device gives flexibility to program each channel individually. To enable individual channel writes, write address 4005h with 01h (default is 00h).

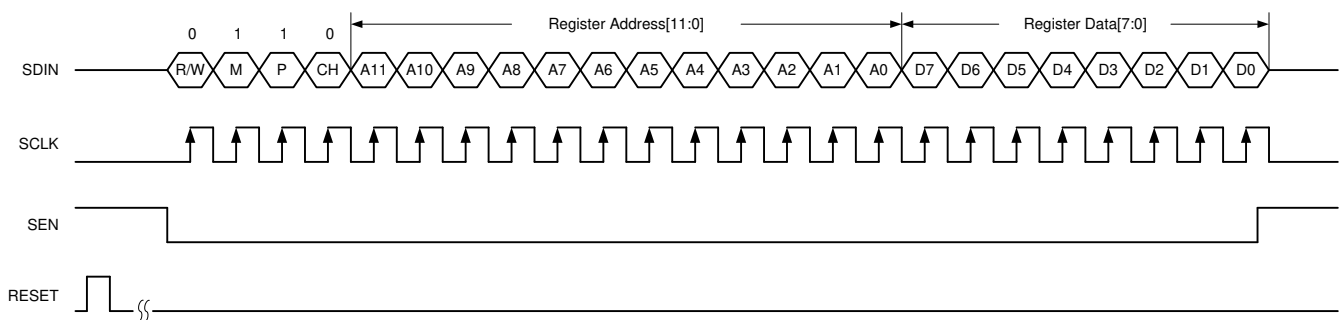
### 7.5.1.7 Serial Register Readout: JESD Bank

SPI read out of content in one of the three digital banks can be accomplished with the following steps:

1. Drive the SEN pin low.
2. Select the digital bank page (Note: M bit = 1, P bit = 0)
  - Write address 4003h with 00h
  - Main digital page: write address = 4004h with 68h
  - Digital JESD page: write address = 4004h with 69h
  - Analog JESD page: write address = 4004h with 6Ah
  - Interleaving engine page: write address = 4004h with 61h
  - Decimation filter page: write address = 4004h with 61h and 4003h with 41h
3. Set the R/W bit, M and P bit to 1 and select channels A, B or C, D and write the address to be read back.
4. Read back register content on the SDOUT pin. When a page is selected, multiple read backs from the same page can be done.

Figure 7-24 shows the serial interface signals when the contents of a register in the desired page of the JESD bank are being read-back (note that the P bit must be set to 1 in this step).



图 7-24. Serial Register Read Timing Diagram

### 7.5.2 JESD204B Interface

The ADS54J66 supports device subclass 1 with a maximum output data rate of 10 Gbps for each serial transmitter. 图 7-25 shows JESD20B block inside ADS54J66.

An external SYSREF signal is used to align all internal clock phases and the local multi frame clock to a specific sampling clock edge. This process allows synchronization of multiple devices in a system and minimizes timing and alignment uncertainty. The ADS54J66 supports single (for all four JESD links) or dual (for channel A, B and C, D) SYNCb inputs and can be configured via SPI as shown in 图 7-26.

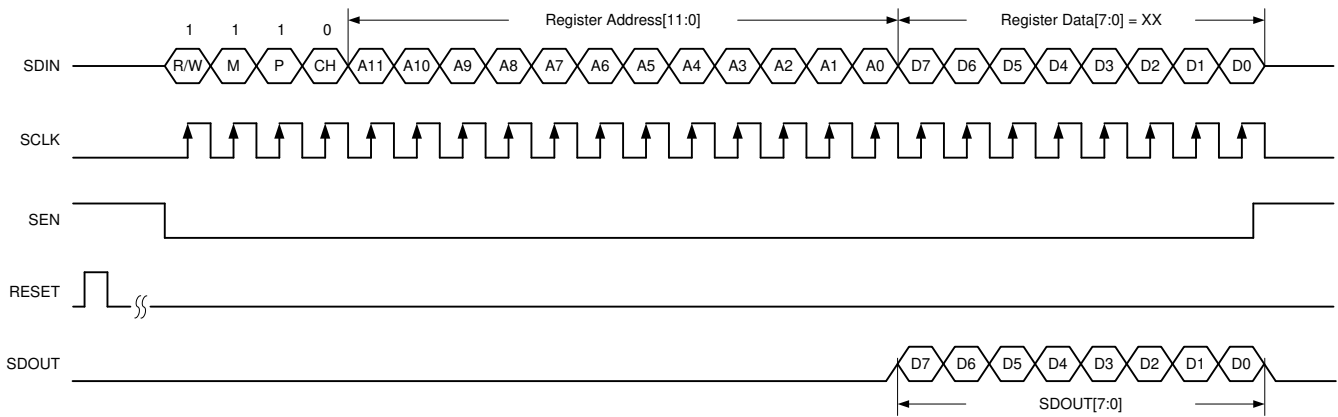

图 7-25. JESD Interface Block Diagram



图 7-26. JESD204B Transmitter Block

Depending on the ADC sampling rate, the JESD204B output interface can be operated with one lane per channel. The JESD204B setup and configuration of the frame assembly parameters is controlled through the SPI interface.

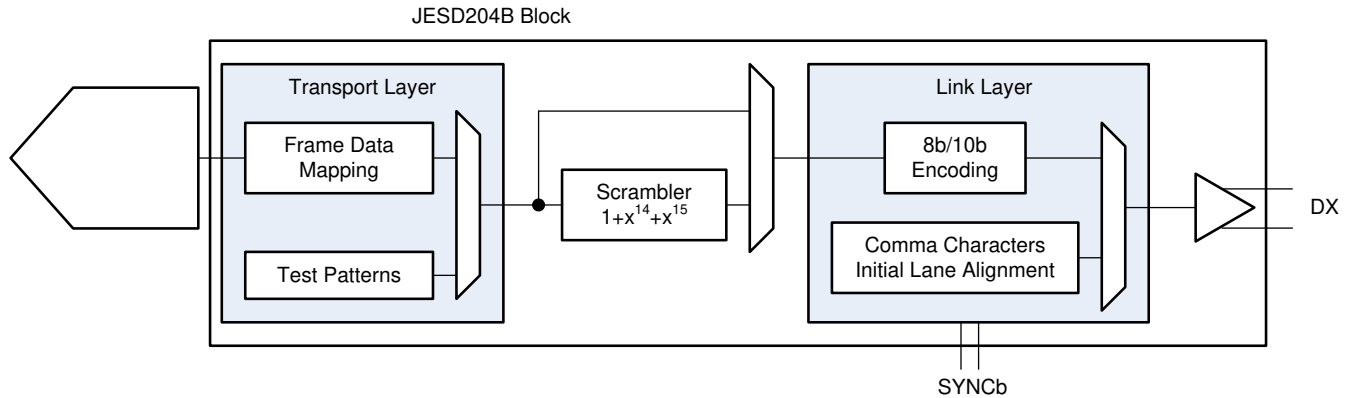
The JESD204B transmitter block consists of the transport layer, the data scrambler and the link layer. The transport layer maps the ADC output data into the selected JESD204B frame data format and manages if the ADC output data or test patterns are being transmitted. The link layer performs the 8b/10b data encoding as well as the synchronization and initial lane alignment using the SYNC input signal. Optionally, data from the transport layer can be scrambled.

### 7.5.2.1 JESD204B Initial Lane Alignment (ILA)

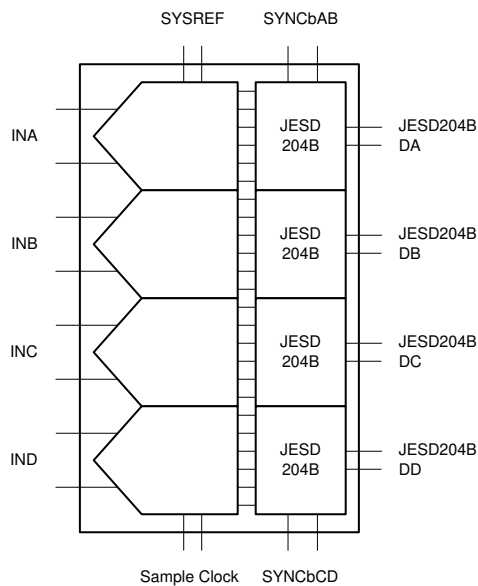
The initial lane alignment process is started by the receiving device by de-asserting the SYNCb signal. Upon detecting a logic low on the SYNC input pins, the ADS54J66 starts transmitting comma (K28.5) characters to establish code group synchronization as shown in [图 7-27](#).

When synchronization is completed the receiving device re-asserts the SYNCb signal and the ADS54J66 starts the initial lane alignment sequence with the next local multi frame clock boundary. The ADS54J66 transmits four multi-frames each containing K frames (K is SPI programmable). Each of the multi-frames contains the frame start and end symbols and the second multi-frame also contains the JESD204 link configuration data.

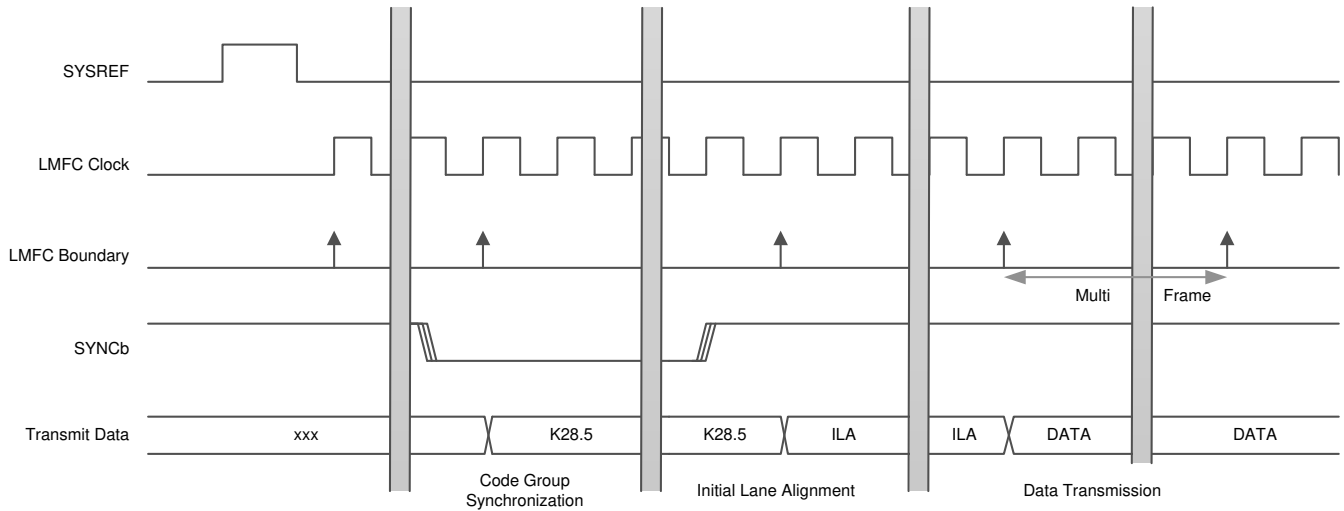

**图 7-27. ILA Sequence**



### 7.5.2.2 JESD204B Frame Assembly

The JESD204B standard defines the following parameters:

- L is the number of lanes per link.
- M is the number of converters per device.
- F is the number of octets per frame clock period.
- S is the number of samples per frame.

表 7-13 lists the available JESD204B formats and valid ranges for the ADS54J66. The ranges are limited by the Serdes line rate and the maximum ADC sample frequency.

**表 7-13. Available JESD204B Formats and Valid Ranges for the ADS54J66**

L	M	F	S	OPERATING MODE	DIGITAL MODE	OUTPUT FORMAT	JESD MODE <sup>(1)</sup>	JESD PLL MODE <sup>(2)</sup>	MAX ADC OUTPUT RATE (MSPS)	MAX $f_{SERDES}$ (Gbps)
4	8	4	1	0,5	2x decimation	Complex	40x	40x	250	10.0
4	4	2	1	2,4	2x decimation	Real	20x	20x	250	5.0
2	4	4	1	2,4	2x decimation	Real	40x	40x	250	10.0
4	8	4	1	6	4x decimation	Complex	40x	20x	125	5.0
4	4	2	1	7	2x decimation with 0-pad	Real	20x	40x	500	10.0
4	4	2	1	8	No decimation	Real	20x	40x	500	10.0

- (1) In register 01h of the JESD digital page.  
(2) In register 16h of the JESD analog page.

The detailed frame assembly is shown in 表 7-14.

**表 7-14. Detailed Frame Assembly**

	LMFS = 4841				LMFS = 4421				LMFS = 4421 (0-Pad)			
DA	A10[15:8]	A10[7:0]	AQ0[15:8]	AQ0[7:0]	A0[15:8]	A0[7:0]	A1[15:8]	A1[7:0]	A0[15:8]	A0[7:0]	0000 0000	0000 0000
DB	B10[15:8]	B10[7:0]	BQ0[15:8]	BQ0[7:0]	B0[15:8]	B0[7:0]	B1[15:8]	B1[7:0]	B0[15:8]	B0[7:0]	0000 0000	0000 0000
DC	C10[15:8]	C10[7:0]	CQ0[15:8]	CQ0[7:0]	C0[15:8]	C0[7:0]	C1[15:8]	C1[7:0]	C0[15:8]	C0[7:0]	0000 0000	0000 0000
DD	D10[15:8]	D10[7:0]	DQ0[15:8]	DQ0[7:0]	D0[15:8]	D0[7:0]	D1[15:8]	D1[7:0]	D0[15:8]	D0[7:0]	0000 0000	0000 0000

	LMFS = 2441							
DB	A0[15:8]		A0[7:0]		B0[15:8]		B0[7:0]	
DC	C0[15:8]		C0[7:0]		D0[15:8]		D0[7:0]	

### 7.5.2.3 JESD Output Switch

The ADS54J66 provides a digital cross point switch in the JESD204B block which allows internal routing of any output of the two ADCs within one channel pair to any of the two JESD204B serial transmitters in order to ease layout constraints. The cross-point switch routing is configured via SPI (address 21h in the JESD digital page, as shown in [图 7-28](#)).

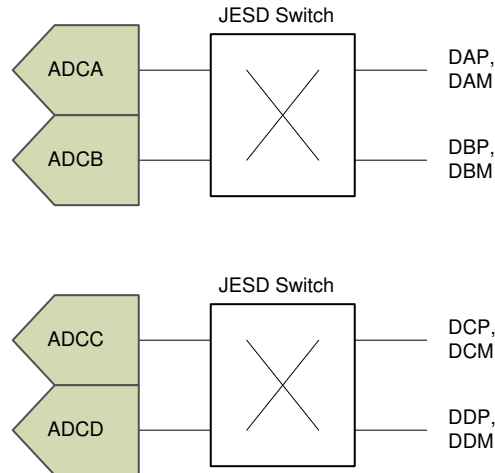

**图 7-28. Switching the Output Lanes**

#### 7.5.2.3.1 SERDES Transmitter Interface

Each of the 10 Gbps serdes transmitter outputs requires ac coupling between transmitter and receiver. The differential pair must be terminated with  $100\ \Omega$  as close to the receiving device as possible to avoid unwanted reflections and signal degradation as shown in [图 7-29](#).

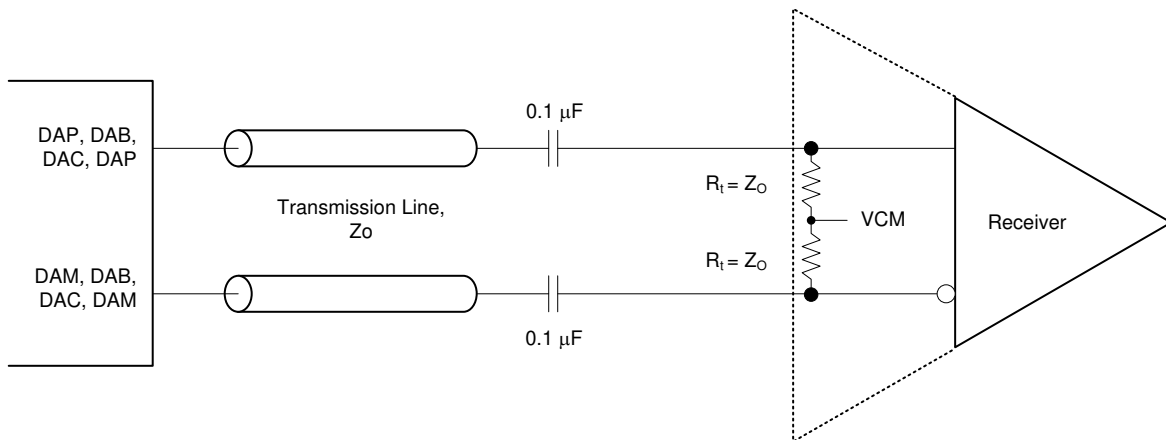

**图 7-29. SERDES Transmitter Connection to Receiver**

#### 7.5.2.3.2 SYNCb Interface

The ADS54J66 supports single (either SYNCb input controls all four JESD204B links) or dual (one SYNCb input controls two JESD204B lanes (DA, DB and DC, DD) SYNCb control. When using single SYNCb control, connect the unused input to differential logic low (SYNCbxxP = 0 V, SYNCbxxM = IOVDD).

### 7.5.2.3.3 Eye Diagram

图 7-30 到 图 7-33 显示 ADS54J66 在 5 Gbps 和 10 Gbps 下的串行输出眼图，分别使用默认和增加输出电压摆幅，与 JESD204B 掩模进行比较。



图 7-30. Eye at 5-Gbps Bit Rate with Default Output Swing



图 7-31. Eye at 5-Gbps Bit Rate with Increased Output Swing

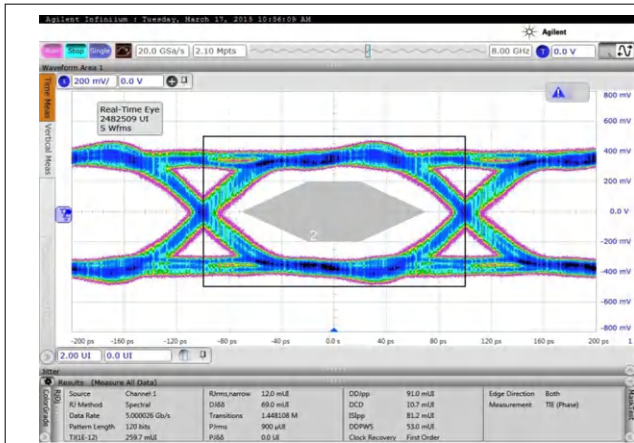

图 7-32. Eye at 10-Gbps Bit Rate with Default Output Swing

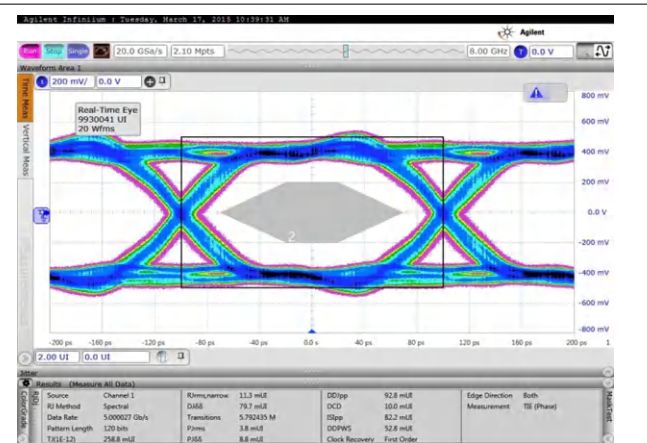

图 7-33. Eye at 10-Gbps Bit Rate with Increased Output Swing

## 7.6 Register Maps

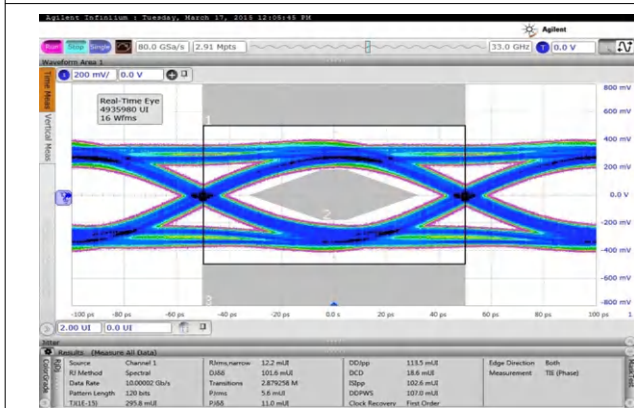
The conceptual diagram of the serial registers is shown in 图 7-34.

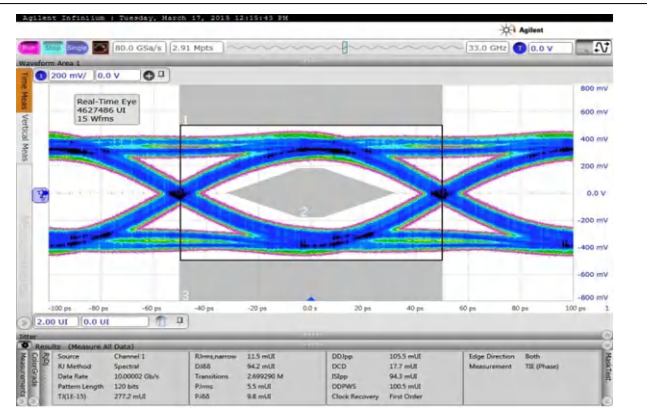

图 7-34. Serial Interface Registers

### 7.6.1 Detailed Register Information

The ADS54J66 contains two main SPI banks. The analog SPI bank gives access to the ADC cores and the digital SPI bank controls the serial interface. The analog SPI bank is divided into two pages (master and ADC) and the digital SPI bank is divided into five pages (main digital, interleaving engine, decimation filter, JESD digital, and JESD analog; see [图 7-34](#)). [表 7-15](#) gives a summary of all programmable registers in the pages of different banks in the ADS54J66.

**表 7-15. Register Map**

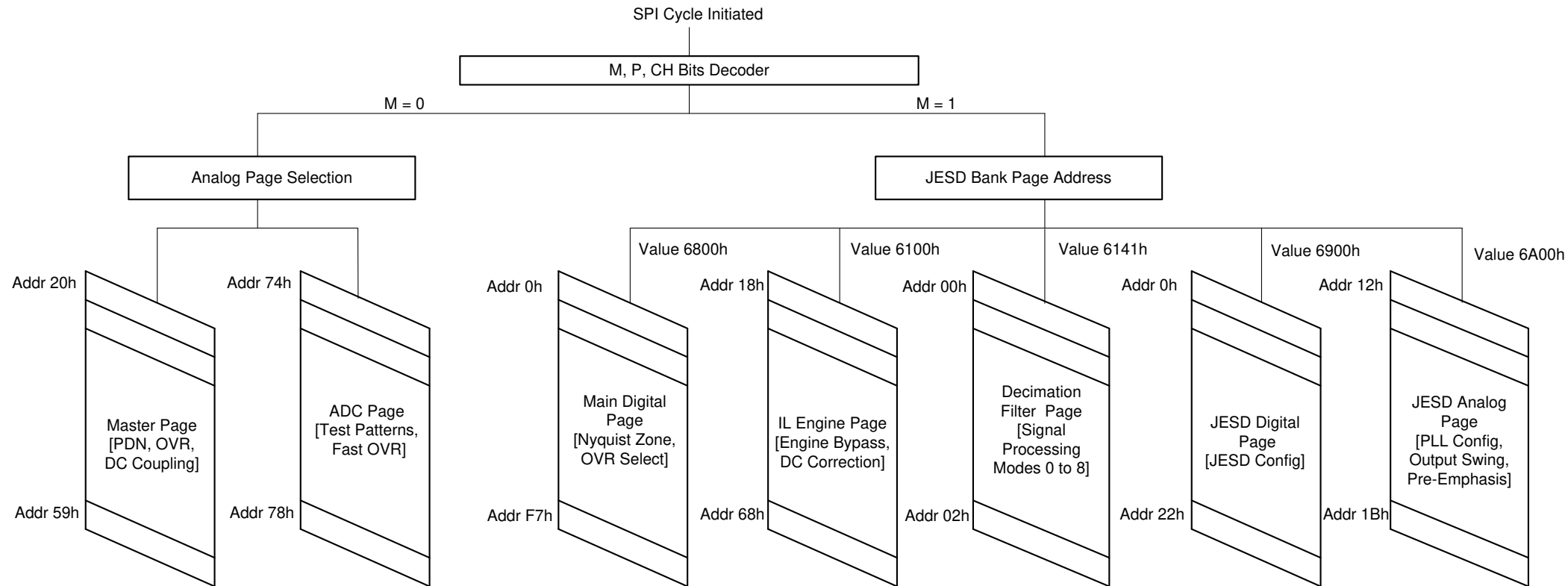
REGISTER ADDRESS A[7:0] (Hex)	REGISTER DATA							
	7	6	5	4	3	2	1	0
<b>GENERAL REGISTERS</b>								
0	RESET	0	0	0	0	0	0	RESET
3	JESD BANK PAGE SEL [7:0]							
4	JESD BANK PAGE SEL [15:8]							
5	0	0	0	0	0	0	0	DIS BROADCAST
11	ANALOG PAGE SELECTION [7:0]							
<b>MASTER PAGE (80h)</b>								
20	PDN ADC CHAB				PDN ADC CHCD			
21	PDN BUFFER CHCD		PDN BUFFER CHAB		0	0	0	0
23	PDN ADC CHAB				PDN ADC CHCD			
24	PDN BUFFER CHCD		PDN BUFFER CHAB		0	0	0	0
26	GLOBAL PDN	OVERRIDE PDN PIN	PDN MASK SEL	0	0	0	0	0
3A	0	BUFFER CURR INCREASE	0	0	0	0	0	0
39	ALWAYS WRITE 1		0	0	0	0	0	0
53	CLK DIV	MASK SYSREF	0	0	0	0	0	SET SYSREF
54	ENABLE MANUAL SYSREF	0	0	0	0	0	0	0
55	0	0	0	PDN MASK	0	0	0	0
56	0	0	0	0	INPUT BUFF CURR EN	0	0	0
59	0	0	ALWAYS WRITE 1	0	0	0	0	0
<b>ADC PAGE (0Fh)</b>								
5F	FOVR THRESH							
60	PULSE BIT CHC	0	0	0	0	0	0	0
61	0	0	0	0	HD3 NYQ2 CHCD	0	0	PULSE BIT CHD
6C	PULSE BIT CHA	0	0	0	0	0	0	0
6D	0	0	0	0	HD3 NYQ2 CHAB	0	0	PULSE BIT CHB
74	TEST PATTERN ON CHANNEL				0	0	0	0
75	CUSTOM PATTERN 1 [13:6]							
76	CUSTOM PATTERN 1 [5:0]						0	0
77	CUSTOM PATTERN 2 [13:6]							
78	CUSTOM PATTERN 2 [5:0]						0	0
<b>INTERLEAVING ENGINE PAGE (6100h)</b>								
18	0	0	0	0	0	0	IL BYPASS	
68	0	0	0	0	0	DC CORR DIS		0
<b>DECIMATION FILTER PAGE (6141h)</b>								
0	CHB/C FINE MIX				DDC MODE			
1	0	0	0	0	DDC MODE6 EN1	ALWAYS WRITE 1	CHB/C HPF EN	CHB/C COARSE MIX
2	0	0	CHA/D HPF EN	CHA/D COARSE MIX	CHA/D FINE MIX			
<b>MAIN DIGITAL PAGE (6800h)</b>								
0	0	0	0	0	0	0	0	IL RESET
42	0	0	0	0	0	NYQUIST ZONE		
4E	CTRL NYQUIST ZONE	0	0	0	0	0	0	0

**表 7-15. Register Map (continued)**

REGISTER ADDRESS A[7:0] (Hex)	REGISTER DATA								
	7	6	5	4	3	2	1	0	
AB	0	0	0	0	0	0	0	OVR EN	
F7	0	0	0	0	0	0	0	DIG RESET	
<b>JESD DIGITAL PAGE (6900h)</b>									
0	CTRL K	JESD MODE EN	DDC MODE6 EN2	TESTMODE EN	0	LANE ALIGN	FRAME ALIGN	TX LINK DIS	
1	SYNC REG	SYNC REG EN	SYNCB SEL AB/CD	0	DDC MODE6 EN3	0	JESD MODE		
2	LINK LAYER TESTMODE			LINK LAYER RPAT	LMFC MASK RESET	0	0	0	
3	FORCE LMFC COUNT	LMFC COUNT INIT					RELEASE ILANE SEQ		
5	SCRAMBLE EN	0	0	0	0	0	0	0	
6	0	0	0	FRAMES PER MULTI FRAME (K)					
21	OUPUT CHA MUX SEL		OUTPUT CHB MUX SEL		OUTPUT CHC MUX SEL		OUTPUT CHD MUX SEL		
22	0	0	0	0	OUT CHA INV	OUT CHB INV	OUT CHC INV	OUT CHD INV	
<b>JESD ANALOG PAGE (6A00h)</b>									
12	SEL EMP LANE A/D						0	0	
13	SEL EMP LANE B/C						0	0	
16	0	0	0	0	0	0	JESD PLL MODE		
17	0	PLL RESET	0	0	0	0	0	0	
1B	JESD SWING			0	0	0	0	0	

### 7.6.2 Example Register Writes

Global power down:

ADDRESS	DATA	COMMENT
11h	80h	Set master page
0026h	C0h	Set global power down

Change decimation mode 0 to mode 4 adjusting both the LMFS configuration (LMFS = 4841 to 4421) as well as serial output data rate (10 Gbps to 5 Gbps):

ADDRESS	DATA	COMMENT
4004h	69h	Select digital JESD page
4003h	00h	
6000h	40h	Enables JESD mode overwrite
6001h	01h	Select digital to 20x mode
4004h	6Ah	Select analog JESD page
6016h	00h	Set serdes PLL to 20x mode
4004h	61h	Select decimation filter page
4003h	41h	
6000h	CCh	Select mode 4 Digital mixer for channel AB set to $-4 (f_S / 4)$
6002h	0Ch	Digital mixer for channel CD set to $-4 (f_S / 4)$

表 7-16 lists the access codes for the ADS54J66 registers.

**表 7-16. ADS54J66 Access Type Codes**

Access Type	Code	Description
Read Type		
R	R	Read
RW	R-W	Read or write
Write Type		
W	W	Write
Reset or Default Value		
-n		Value after reset or the default value

### 7.6.3 Register Descriptions

#### 7.6.3.1 General Registers

##### 7.6.3.1.1 Register 0h (offset = 0h) [reset = 0h]

图 7-35. Register 0h

7	6	5	4	3	2	1	0
RESET	0	0	0	0	0	0	RESET
R/W-0h	W-0h	W-0h	W-0h	W-0h	W-0h	W-0h	R/W-0h

表 7-17. Register 0h Field Description

Bit	Name	Type	Reset	Description
7 <sup>(1)</sup>	RESET	R/W	0h	0 = Normal operation 1 = Internal software reset, clears back to 0
6-0	0	W	0h	Must write 0.
0 <sup>(1)</sup>	RESET	R/W	0h	0 = Normal operation 1 = Internal software reset, clears back to 0

(1) Both bits (7, 0) must be set simultaneously to exercise reset.

##### 7.6.3.1.2 Register 3h, 4h (offset = 3h, 4h) [reset = 0h]

图 7-36. Register 3h

7	6	5	4	3	2	1	0
JESD BANK PAGE SEL [7:0]							
R/W-0h							

图 7-37. Register 4h

7	6	5	4	3	2	1	0
JESD BANK PAGE SEL [16:8]							
R/W-0h							

表 7-18. Register 3h, 4h Field Description

Bit	Name	Type	Reset	Description
7-0	JESD BANK PAGE SEL	R/W	0h	Program these bits to access the desired page in the JESD bank. 6100h = Interleaving engine page selected 6141h = Decimation filter page selected 6800h = Main digital page selected 6900h = JESD digital page selected 6A00h = JESD analog page selected



### 7.6.3.1.3 Register 5h (offset = 5h) [reset = 0h]

图 7-38. Register 5h

7	6	5	4	3	2	1	0
0	0	0	0	0	0	0	DIS BROADCAST
W-0h	W-0h	W-0h	W-0h	W-0h	W-0h	W-0h	R/W-0h

表 7-19. Register 5h Field Description

Bit	Name	Type	Reset	Description
7-1	0	W	0h	Must write 0.
0	DIS BROADCAST	R/W	0h	0 = Normal operation. Channel A and B are programmed as a pair. Channel C and D are programmed as a pair. 1 = channel A and B can be individually programmed based on the CH bit. Similarly channel C and D can be individually programmed based on the CH bit.

### 7.6.3.1.4 Register 11h (offset = 11h) [reset = 0h]

图 7-39. Register 11h

7	6	5	4	3	2	1	0
ANALOG PAGE SELECTION [7:0]							
R/W-0h							

表 7-20. Register 11h Field Descriptions

Bit	Name	Type	Reset	Description
7-0	ANALOG PAGE SELECTION [7:0]	R/W	0h	Register page (only one page at a time can be addressed). Master page = 80h ADC page = 0Fh The five digital pages (main digital, interleaving engine, analog JESD, digital JESD, and decimation filter) are selected via the M bit. See 表 7-11 in the 节 7.5.1.1 section for more details.

### 7.6.3.2 Master Page (80h)

#### 7.6.3.2.1 Register 20h (address = 20h) [reset = 0h], Master Page (080h)

图 7-40. Register 20h

7	6	5	4	3	2	1	0
PDN ADC CHAB				PDN ADC CHCD			
R/W-0h				R/W-0h			

表 7-21. Registers 20h Field Descriptions

Bit	Field	Type	Reset	Description
7-4	PDN ADC CHAB	R/W	0h	There are two power-down masks that are controlled via the PDN mask register bit in address 55h. The power-down mask 1 or mask 2 are selected via register bit 5 in address 26h. Power-down mask 1: addresses 20h and 21h. Power-down mask 2: addresses 23h and 24h. See the 节 7.4.8 section for details.
3-0	PDN ADC CHCD	R/W	0h	

7.6.3.2.2 Register 21h (address = 21h) [reset = 0h], Master Page (080h)

图 7-41. Register 21h

7	6	5	4	3	2	1	0
PDN BUFFER CHCD		PDN BUFFER CHAB		0	0	0	0
R/W-0h		R/W-0h		W-0h	R/W-0h	R/W-0h	W-0h

表 7-22. Register 21h Field Descriptions

Bit	Field	Type	Reset	Description
7-6	PDN BUFFER CHCD	R/W	0h	There are two power-down masks that are controlled via the PDN mask register bit in address 55h. The power-down mask 1 or mask 2 are selected via register address 26h, bit 5. Power-down mask 1: addresses 20h and 21h. Power-down mask 2: addresses 23h and 24h. See the <a href="#">§ 7.4.8</a> section for details.
5-4	PDN BUFFER CHAB	R/W	0h	
3-0	0	W	0h	Must write 0.

7.6.3.2.3 Register 23h (address = 23h), Master Page (080h)

图 7-42. Register 23h

7	6	5	4	3	2	1	0
PDN ADC CHAB				PDN ADC CHCD			
R/W-0h				W-0h	R/W-0h	R/W-0h	W-0h

表 7-23. Register 23h Field Descriptions

Bit	Field	Type	Reset	Description
7-4	PDN ADC CHAB	R/W	0h	There are two power-down masks that are controlled via the PDN mask register bit in address 55h. The power-down mask 1 or mask 2 are selected via register bit 5 in address 26h. Power-down mask 1: addresses 20h and 21h. Power-down mask 2: addresses 23h and 24h. See the <a href="#">§ 7.4.8</a> section for details.
3-0	PDN ADC CHCD	R/W	0h	

**7.6.3.2.4 Register 24h (address = 24h) [reset = 0h], Master Page (080h)**

**图 7-43. Register 24h**

7	6	5	4	3	2	1	0
PDN BUFFER CHCD		PDN BUFFER CHAB		0	0	0	0
R/W-0h		R/W-0h		W-0h	R/W-0h	R/W-0h	R/W-0h

**表 7-24. Register 24h Field Descriptions**

Bit	Field	Type	Reset	Description
7-6	PDN BUFFER CHCD	R/W	0h	There are two power-down masks that are controlled via the PDN mask register bit in address 55h. The power-down mask 1 or mask 2 are selected via register address 26h, bit 5. Power-down mask 1: addresses 20h and 21h. Power-down mask 2: addresses 23h and 24h. See the <a href="#">§ 7.4.8</a> section for details.
5-4	PDN BUFFER CHAB	R/W	0h	
3-0	0	W	0h	Must write 0.

**7.6.3.2.5 Register 26h (address = 26h), Master Page (080h)**

**表 7-25. Register 26h**

7	6	5	4	3	2	1	0
GLOBAL PDN	OVERRIDE PDN PIN	PDN MASK SEL	0	0	0	0	0
R/W-0h	R/W-0h	R/W-0h	R/W-0h	R/W-0h	R/W-0h	R/W-0h	R/W-0h

**表 7-26. Register 26h Field Descriptions**

Bit	Field	Type	Reset	Description
7	GLOBAL PDN	R/W	0h	Bit 6 (OVERRIDE PDN PIN) must be set before this bit can be programmed. 0 = Normal operation 1 = Global power-down via the SPI
6	OVERRIDE PDN PIN	R/W	0h	This bit ignores the power-down pin control. 0 = Normal operation 1 = Ignores inputs on the power-down pin
5	PDN MASK SEL	R/W	0h	This bit selects power-down mask 1 or mask 2. 0 = Power-down mask 1 1 = Power-down mask 2
4-0	0	R/W	0h	Must write 0

7.6.3.2.6 Register 3Ah (address = 3Ah) [reset = 0h], Master Page (80h)

图 7-44. Register 3Ah

7	6	5	4	3	2	1	0
0	BUFFER CURR INCREASE	0	0	0	0	0	0
W-0h	R/W-0h	W-0h	W-0h	W-0h	W-0h	W-0h	W-0h

表 7-27. Register 3Ah Field Descriptions

Bit	Name	Type	Reset	Description
7	0	W	0h	Must write 0.
6	BUFFER CURR INCREASE	R/W	0h	0 = Normal operation 1 = Increases AVDD3V current by 30 mA., improves HD3, helpful for second and third Nyquist application. Make sure that the INPUT BUF CUR EN register bit is also set to 1.
5-0	0	W	0h	Must write 0.

7.6.3.2.7 Register 39h (address = 39h) [reset = 0h], Master Page (80h)

图 7-45. Register 39h

7	6	5	4	3	2	1	0
ALWAYS WRITE 1	0	0	0	0	0	0	0
R/W-0h	W-0h	W-0h	W-0h	W-0h	W-0h	W-0h	W-0h

表 7-28. Register 39h Field Descriptions

Bit	Name	Type	Reset	Description
7-6	ALWAYS WRITE 1	R/W	0h	Always set these bits to 11.
5-0	0	W	0h	Must write 0.

7.6.3.2.8 Register 53h (address = 53h) [reset = 0h], Master Page (80h)

图 7-46. Register 53h Register

7	6	5	4	3	2	1	0
CLK DIV	MASK SYSREF	0	0	0	0	0	SET SYSREF
R/W-0h	R/W-0h	W-0h	W-0h	W-0h	W-0h	W-0h	W-0h

表 7-29. Register 53h Field Descriptions

Bit	Name	Type	Reset	Description
7	CLK DIV	R/W	0h	This bit configures the input clock divider. 0 = Divide-by-4 1 = Divide-by-2 (must be enabled for proper operation of the ADS54J66)
6	MASK SYSREF	R/W	0h	0 = Normal operation 1 = Ignores the SYSREF input
5-1	0	W	0h	Must write 0.
0	SET SYSREF	R/W	0h	0 = SYSREF signal inside device is set as 0 1 = SYSREF signal inside device is set as 1

**7.6.3.2.9 Register 54h (address = 54h) [reset = 0h], Master Page (80h)**

**图 7-47. Register 54h Register**

7	6	5	4	3	2	1	0
ENABLE MANUAL SYSREF	0	0	0	0	0	0	0
R/W-0h	W-0h	W-0h	W-0h	W-0h	W-0h	W-0h	W-0h

**表 7-30. Register 54h Field Descriptions**

Bit	Name	Type	Reset	Description
7	ENABLE MANUAL SYSREF	R/W	0h	This bit enables manual SYSREF using SPI when disabling the pin control. After setting this bit, the SET SYSREF register bit can be used to apply SYSREF.
6-1	0	W	0h	Must write 0.

**7.6.3.2.10 Register 55h (address = 55h) [reset = 0h], Master Page (80h)**

**图 7-48. Register 55h**

7	6	5	4	3	2	1	0
0	0	0	PDN MASK	0	0	0	0
W-0h	W-0h	W-0h	R/W-0h	W-0h	W-0h	W-0h	W-0h

**表 7-31. Register 55h Field Descriptions**

Bit	Name	Type	Reset	Description
7-5	0	W	0h	Must write 0.
4	PDN MASK	R/W	0h	Power-down via register bit. 0 = Normal operation 1 = Power down enabled powering down internal blocks specified in the selected power-down mask
3-0	0	W	0h	Must write 0.

**7.6.3.2.11 Register 56h (address = 56h) [reset = 0h], Master Page (80h)**

**图 7-49. Register 56h**

7	6	5	4	3	2	1	0
0	0	0	0	INPUT BUFF CURR EN	0	0	0
W-0h	W-0h	W-0h	W-0h	R/W-0h	W-0h	W-0h	W-0h

**表 7-32. Register 56h Field Descriptions**

Bit	Name	Type	Reset	Description
7-4	0	W	0h	Must write 0.
3	INPUT BUFF CURR EN	R/W	0h	0 = Normal operation 1 = Increases AVDD3V current by 30 mA., improves HD3, helpful for second Nyquist application. Make sure that the BUFFER CURR INCREASE register bit is also set to 1.
2-0	0	W	0h	Must write 0.

**7.6.3.2.12 Register 59h (address = 59h) [reset = 0h], Master Page (80h)**
**图 7-50. Register 59h**

7	6	5	4	3	2	1	0
0	0	ALWAYS WRITE 1	0	0	0	0	0
W-0h	W-0h	R/W-0h	W-0h	W-0h	W-0h	W-0h	W-0h

**表 7-33. Register 59h Field Descriptions**

Bit	Name	Type	Reset	Description
7-6	0	W	0h	Must write 0.
5	ALWAYS WRITE 1	R/W	0h	Always set this bit to 1.
4-0	0	W	0h	Must write 0.

### 7.6.3.3 ADC Page (0Fh)

#### 7.6.3.3.1 Register 5Fh (address = 5Fh) [reset = 0h], ADC Page (0Fh)

图 7-51. Register 5Fh

7	6	5	4	3	2	1	0
FOVR THRESH							
R/W-0h							

表 7-34. Register 5Fh Field Descriptions

Bit	Name	Type	Reset	Description
7-0	FOVR THRESH	R/W	0h	These bits control the location of FAST OVR threshold for all four channels together; see the <a href="#">节 7.4.7</a> section.

#### 7.6.3.3.2 Register 60h (address = 60h) [reset = 0h], ADC Page (0Fh)

图 7-52. Register 60h

7	6	5	4	3	2	1	0
PULSE BIT CHC	0	0	0	0	0	0	0
R/W-0h	W-0h	W-0h	W-0h	W-0h	W-0h	W-0h	W-0h

表 7-35. Register 60h Field Descriptions

Bit	Name	Type	Reset	Description
7	PULSE BIT CHC	R/W	0h	Pulse this bit to improve HD3 for 2nd Nyquist frequencies ( $f_{IN} > 250$ MHz) for channel C. <sup>(1)</sup> Before pulsing this bit, the HD3 NYQ2 CHCD register bit must be set to 1.
6-0	0	W	0h	Must write 0.

(1) Pulsing = set the bit to 1 and then reset to 0.

#### 7.6.3.3.3 Register 61h (address = 61h) [reset = 0h], ADC Page (0Fh)

图 7-53. Register 61h

7	6	5	4	3	2	1	0
0	0	0	0	HD3 NYQ2 CHCD	0	0	PULSE BIT CHD
W-0h	W-0h	W-0h	W-0h	R/W-0h	W-0h	W-0h	R/W-0h

表 7-36. Register 61h Field Descriptions

Bit	Name	Type	Reset	Description
7-4	0	W	0h	Must write 0.
3	HD3 NYQ2 CHCD	R/W	0h	Set this bit to improve HD3 for 2nd Nyquist frequencies ( $f_{IN} > 250$ MHz) for channel C and D. When this bit is set, the PULSE BIT CHx register bits must be pulsed to obtain the improvement in corresponding channels.
2-1	0	W	0h	Must write 0.
0	PULSE BIT CHD	R/W	0h	Pulse this bit to improve HD3 for 2nd Nyquist frequencies ( $f_{IN} > 250$ MHz) for channel D. <sup>(1)</sup> Before pulsing this bit, the HD3 NYQ2 CHCD register bit must be set to 1.

(1) Pulsing = set the bit to 1 and then reset to 0.

### 7.6.3.3.4 Register 6Ch (address = 6Ch) [reset = 0h], ADC Page (0Fh)

图 7-54. Register 6Ch

7	6	5	4	3	2	1	0
PULSE BIT CHA	0	0	0	0	0	0	0
R/W-0h	W-0h	W-0h	W-0h	W-0h	W-0h	W-0h	W-0h

表 7-37. Register 6Ch Field Descriptions

Bit	Name	Type	Reset	Description
7	PULSE BIT CHA	R/W	0h	Pulse this bit to improve HD3 for 2nd Nyquist frequencies ( $f_{IN} > 250$ MHz) for channel A. <sup>(1)</sup> Before pulsing this bit, the HD3 NYQ2 CHCAB register bit must be set to 1.
6-0	0	W	0h	Must write 0.

(1) Pulsing = set the bit to 1 and then reset to 0.

### 7.6.3.3.5 Register 6Dh (address = 6Dh) [reset = 0h], ADC Page (0Fh)

图 7-55. Register 6Dh

7	6	5	4	3	2	1	0
0	0	0	0	HD3 NYQ2 CHAB	0	0	PULSE BIT CHB
W-0h	W-0h	W-0h	W-0h	R/W-0h	W-0h	W-0h	R/W-0h

表 7-38. Register 6Dh Field Descriptions

Bit	Name	Type	Reset	Description
7-4	0	W	0h	Must write 0.
3	HD3 NYQ2 CHAB	R/W	0h	Set this bit to improve HD3 for 2nd Nyquist frequencies ( $f_{IN} > 250$ MHz) for channel A and B. When this bit is set, the PULSE BIT CHx register bits must be pulsed to obtain the improvement in corresponding channels.
2-1	0	W	0h	Must write 0.
0	PULSE BIT CHB	R/W	0h	Pulse this bit to improve HD3 for 2nd Nyquist frequencies ( $f_{IN} > 250$ MHz) for channel B. <sup>(1)</sup> Before pulsing this bit, the HD3 NYQ2 CHAB register bit must be set to 1.

(1) Pulsing = set the bit to 1 and then reset to 0.



**7.6.3.3.6 Register 74h (address = 74h) [reset = 0h], ADC Page (0Fh)**

**表 7-39. Register 74h**

7	6	5	4	3	2	1	0
TEST PATTERN ON CHANNEL				0	0	0	0
R/W-0h				W-0h	W-0h	W-0h	W-0h

**表 7-40. Register 74h Field Descriptions**

Bit	Field	Type	Reset	Description
7-4	TEST PATTERN ON CHANNEL	R/W	0h	Test pattern output on channel A and B 0000 = Normal operation using ADC output data 0001 = Outputs all 0s 0010 = Outputs all 1s 0011 = Outputs toggle pattern: Output data are an alternating sequence of 101010101010 and 010101010101 0100 = Output digital ramp: output data increment by one LSB every clock cycle from code 0 to 16384 0110 = Single pattern: output data are custom pattern 1 (75h and 76h) 0111 = Double pattern: output data alternate between custom pattern 1 and custom pattern 2 1000 = Deskew pattern: output data are 2AAAh 1001 = SYNC pattern: output data are 7FFFh See the <a href="#">§ 8.1.6</a> section for more details. To use the test patterns, the interleave engine must be in bypass and the DC correction disabled (page 6100h addresses 0x18 and 0x68) and the ADC must be in bypass mode.
3-0	0	W	0h	Must write 0.

**7.6.3.3.7 Register 75h (address = 75h) [reset = 0h], ADC Page (0Fh)**

**表 7-41. Register 75h**

7	6	5	4	3	2	1	0
CUSTOM PATTERN 1[13:6]							
R/W-0h							

**表 7-42. Register 75h Field Descriptions**

Bit	Name	Type	Reset	Description
7-0	CUSTOM PATTERN	R/W	0h	These bits set the custom pattern (13-6) for all channels; see the <a href="#">§ 8.1.6</a> section for more details.

**7.6.3.3.8 Register 76h (address = 76h) [reset = 0h], ADC Page (0Fh)**

**表 7-43. Register 76h**

7	6	5	4	3	2	1	0
CUSTOM PATTERN 1[ 5:0]						0	0
R/W-0h						W-0h	W-0h

**表 7-44. Register 76h Field Descriptions**

Bit	Name	Type	Reset	Description
7-2	CUSTOM PATTERN	R/W	0h	These bits set the custom pattern (5-0) for all channels; see the <a href="#">§ 8.1.6</a> section for more details.
1-0	0	W	0h	Must write 0.

7.6.3.3.9 Register 77h (address = 77h) [reset = 0h], ADC Page (0Fh)

表 7-45. Register 77h

7	6	5	4	3	2	1	0
CUSTOM PATTERN 2[13:6]							
R/W-0h							

表 7-46. Register 77h Field Descriptions

Bit	Name	Type	Reset	Description
7-0	CUSTOM PATTERN	R/W	0h	These bits set the custom pattern (13-6) for all channels; see the <a href="#"># 8.1.6</a> section for more details.

7.6.3.3.10 Register 78h (address = 78h) [reset = 0h], ADC Page (0Fh)

表 7-47. Register 78h

7	6	5	4	3	2	1	0
CUSTOM PATTERN 2[ 5:0]						0	0
R/W-0h						W-0h	W-0h

表 7-48. Register 78h Field Descriptions

Bit	Name	Type	Reset	Description
7-2	CUSTOM PATTERN	R/W	0h	These bits set the custom pattern (5-0) for all channels; see the <a href="#"># 8.1.6</a> section for more details.
1-0	0	W	0h	Must write 0.

### 7.6.3.4 Interleaving Engine Page (6100h)

#### 7.6.3.4.1 Register 18h (address = 18h) [reset = 0h], Interleaving Engine Page (6100h)

图 7-56. Register 18h

7	6	5	4	3	2	1	0
0	0	0	0	0	0	IL BYPASS	
W-0h	W-0h	W-0h	W-0h	W-0h	W-0h	R/W-0h	

表 7-49. Register 18h Field Descriptions

Bit	Name	Type	Reset	Description
7-2	0	W	0h	Must write 0.
1-0	IL BYPASS	R/W	0h	These bits allow bypassing of the interleaving correction, which is to be used when ADC test patterns are enabled. 00 = Interleaving correction enabled 11 = Interleaving correction bypassed

#### 7.6.3.4.2 Register 68h (address = 68h) [reset = 0h], Interleaving Engine Page (6100h)

图 7-57. Register 68h

7	6	5	4	3	2	1	0
0	0	0	0	0	DC CORR DIS		0
W-0h	W-0h	W-0h	W-0h	W-0h	R/W-0h		W-0h

表 7-50. Register 68h Field Descriptions

Bit	Name	Type	Reset	Description
7-3	0	W	0h	Must write 0.
2-1	DC CORR DIS	R/W	0h	These bits enable the dc offset correction loop. 00 = DC offset correction enabled 11 = DC offset correction disabled Others = Do not use
0	0	W	0h	Must write 0.

### 7.6.3.5 Decimation Filter Page (6141h) Registers

#### 7.6.3.5.1 Register 0h (address = 0h) [reset = 0h], Decimation Filter Page (6141h)

图 7-58. Register 0h

7	6	5	4	3	2	1	0
CHB/C FINE MIX				DDC MODE			
R/W-0h				R/W-0h			

表 7-51. 0h Field Descriptions

Bit	Field	Type	Reset	Description
7-4	CHB/C FINE MIX	R/W	0h	These bits select fine mixing frequency for the $N \times f_S / 16$ mixer, where N is a twos complement number varying from - 8 to 7. 0000 = N is 0 0001 = N is 1 0010 = N is 2 ... 0111 = N is 7 1000 = N is - 8 ... 1111 = N is - 1
3-0	DDC MODE	R/W	0h	These bits select DDC mode for all channels; see 表 7-52 for bit settings.

表 7-52. DDC MODE Bit Settings

SETTING	MODE	DESCRIPTION
000	0	$f_S / 4$ mixing with decimation-by-2, complex output
001	-	N/A
010	2	Decimation-by-2, high or low pass filter, real output
011	-	N/A
100	4	Decimation-by-2, $N \times f_S / 16$ mixer, real output
101	5	Decimation-by-2, $N \times f_S / 16$ mixer, complex output
110	6	Decimation-by-4, $N \times f_S / 16$ mixer, complex output. Make sure the DDC MODE 6 EN[3:1] register bits are also set to 111.
111	7	Decimation-by-2, $N \times f_S / 16$ mixer, insert 0, real output
1000	8	No decimation, no mixing, straight 500-MSPS data output
Others	-	Do not use

**7.6.3.5.2 Register 1h (address = 1h) [reset = 0h], Decimation Filter Page (6141h)**

**图 7-59. Register 1h**

7	6	5	4	3	2	1	0
0	0	0	0	DDC MODE6 EN1	ALWAYS WRITE 1	CHB/C HPF EN	CHB/C COARSE MIX
W-0h	W-0h	W-0h	W-0h	R/W-0h	R/W-0h	R/W-0h	R/W-0h

**表 7-53. Register 1h Field Descriptions**

Bit	Name	Type	Reset	Description
7-4	0	W	0h	Must write 0.
3	DDC MODE6 EN1	R/W	0h	Set this bit along with the DDC MODE6 EN2 and DDC MODE6 EN3 register bits for proper operation of mode 6. 0 = Default 1 = Use for proper operation of DDC mode 6
2	ALWAYS WRITE 1	R/W	0h	Always write this bit to 1.
1	CHB/C HPF EN	R/W	0h	This bit enables the high-pass filter for DDC mode 2 for channel B and C. 0 = Low-pass filter enabled 1 = High-pass filter enabled
0	CHB/C COARSE MIX	R/W	0h	This bit selects the $f_S / 4$ mixer phase for DDC mode 0 for channel B and C. 0 = Mix with $f_S / 4$ 1 = Mix with $-f_S / 4$

**7.6.3.5.3 Register 2h (address = 2h) [reset = 0h], Decimation Filter Page (6141h)**

**图 7-60. Register 2h**

7	6	5	4	3	2	1	0
0	0	CHA/D HPF EN	CHA/D COARSE MIX	CHA/D FINE MIX			
W-0h	W-0h	R/W-0h	R/W-0h	R/W-0h			

**表 7-54. 2h Field Descriptions**

Bit	Name	Type	Reset	Description
7-6	0	W	0h	Must write 0.
5	CHA/D HPF EN	R/W	0h	This bit enables the high-pass filter for DDC mode 2 for channel A and D. 0 = Low-pass filter enabled 1 = High-pass filter enabled
4	CHA/D COARSE MIX	R/W	0h	This bit selects the $f_S / 4$ mixer phase for DDC mode 0 for channel A and D. 0 = Mix with $f_S / 4$ 1 = Mix with $-f_S / 4$
3-0	CHA/D FINE MIX	R/W	0h	These bits select the fine mixing frequency for the $N \times f_S / 16$ mixer, where N is a twos complement number varying from -8 to 7. 0000 = N is 0 0001 = N is 1 0010 = N is 2 ... 0111 = N is 7 1000 = N is -8 ... 1111 = N is -1

### 7.6.3.6 Main Digital Page (6800h) Registers

#### 7.6.3.6.1 Register 0h (address = 0h) [reset = 0h], Main Digital Page (6800h)

图 7-61. Register 0h

7	6	5	4	3	2	1	0
0	0	0	0	0	0	0	IL RESET
W-0h	W-0h	W-0h	W-0h	W-0h	W-0h	W-0h	R/W-0h

表 7-55. Register 0h Field Descriptions

Bit	Name	Type	Reset	Description
7-1	0	W	0h	Must write 0.
0	IL RESET	R/W	0h	This bit resets the interleaving engine. This bit is not a self-clearing bit and must be pulsed <sup>(1)</sup> . Any register bit in the main digital page (6800h) takes effect only after this bit is pulsed. Also, note that pulsing this bit clears registers in the interleaving page (6100h). 0 = Normal operation 0 → 1 → 0 = Interleaving engine reset

(1) Pulsing = set the bit to 1 and then reset to 0.

#### 7.6.3.6.2 Register 42h (address = 42h) [reset = 0h], Main Digital Page (6800h)

图 7-62. Register 42h

7	6	5	4	3	2	1	0
0	0	0	0	0	NYQUIST ZONE		
W-0h	W-0h	W-0h	W-0h	W-0h	R/W-0h		

表 7-56. Register 42h Field Descriptions

Bit	Name	Type	Reset	Description
7-3	0	W	0h	Must write 0.
2-0	NYQUIST ZONE	R/W	0h	These bits provide Nyquist zone information to the interleaving engine. Make sure the CTRL NYQUIST register bit is set to 1. 000 = 1 <sup>st</sup> Nyquist zone (input frequencies between 0 to $f_S / 2$ ) 001 = 2 <sup>nd</sup> Nyquist zone (input frequencies between $f_S / 2$ to $f_S$ ) 010 = 3 <sup>rd</sup> Nyquist zone (input frequencies between $f_S$ to $3 f_S / 2$ ) ... 111 = 8 <sup>th</sup> Nyquist zone (input frequencies between $7 f_S / 2$ to $4 f_S$ )

#### 7.6.3.6.3 Register 4Eh (address = 4Eh) [reset = 0h], Main Digital Page (6800h)

图 7-63. Register 4Eh

7	6	5	4	3	2	1	0
CTRL NYQUIST	0	0	0	0	0	0	0
R/W-0h	W-0h	W-0h	W-0h	W-0h	W-0h	W-0h	W-0h

表 7-57. Register 4Eh Field Descriptions

Bit	Name	Type	Reset	Description
7	CTRL NYQUIST	R/W	0h	Enables Nyquist zone control using register bits NYQUIST ZONE. 0 = Selection disabled 1 = Selection enabled
6-0	0	W	0h	Must write 0.

**7.6.3.6.4 Register ABh (address = ABh) [reset = 0h], Main Digital Page (6800h)**

**图 7-64. Register ABh**

7	6	5	4	3	2	1	0
0	0	0	0	0	0	0	OVR EN
W-0h	W-0h	W-0h	W-0h	W-0h	W-0h	W-0h	R/W-0h

**表 7-58. Register ABh Field Descriptions**

Bit	Field	Type	Reset	Description
7-1	0	W	0h	Must write 0.
0	OVR EN	R/W	0h	Set this bit to enable the OVR ON LSB register bit. 0 = Normal operation 1 = OVR ON LSB enabled

**7.6.3.6.5 Register ADh (address = ADh) [reset = 0h], Main Digital Page (6800h)**

**图 7-65. Register ADh**

7	6	5	4	3	2	1	0
0	0	0	0	OVR ON LSB			
W-0h	W-0h	W-0h	W-0h	R/W-0h			

**表 7-59. Register ADh Field Descriptions**

Bit	Field	Type	Reset	Description
7-4	0	W	0h	Must write 0.
3-0	OVR EN	R/W	0h	Set this bit to bring OVR on two LSBs of the 16-bit output. Make sure the OVR EN register bit is set to 1. 0000 = Bits 0 and 1 of the 16-bit data are noise bits 0011 = OVR comes on bit 0 of the 16-bit data 1100 = OVR comes on bit 1 of the 16-bit data 1111 = OVR comes on both bits 0 and 1 of the 16-bit data

**7.6.3.6.6 Register F7h (address = F7h) [reset = 0h], Main Digital Page (68h)**

**图 7-66. Register F7h**

7	6	5	4	3	2	1	0
0	0	0	0	0	0	0	DIG RESET
W-0h	W-0h	W-0h	W-0h	W-0h	W-0h	W-0h	R/W-0h

**表 7-60. Register F7h Field Descriptions**

Bit	Field	Type	Reset	Description
7-1	0	W	0h	Must write 0.
0	DIG RESET	R/W	0h	Self-clearing reset for the digital block. Does not include the interleaving correction. 0 = Normal operation 1 = Digital reset

### 7.6.3.7 JESD Digital Page (6900h) Registers

#### 7.6.3.7.1 Register 0h (address = 0h) [reset = 0h], JESD Digital Page (6900h)

图 7-67. Register 0h

7	6	5	4	3	2	1	0
CTRL K	JESD MODE EN	DDC MODE6 EN2	TESTMODE EN	0	LANE ALIGN	FRAME ALIGN	TX LINK DIS
R/W-0h	R/W-0h	R/W-0h	R/W-0h	W-0h	R/W-0h	R/W-0h	R/W-0h

表 7-61. Register 0h Field Descriptions

Bit	Name	Type	Reset	Description
7	CTRL K	R/W	0h	Enable bit for a number of frames per multi frame. 0 = Default is five frames per multi frame 1 = Frames per multi frame can be set in register 06h
6	JESD MODE EN	R/W	0h	Allows changing the JESD MODE setting in register 01h (bits 1-0) 0 = Disabled 1 = Enables changing the JESD MODE setting. This setting is to be used with MODE2 and MODE4 only.
5	DDC MODE6 EN2	R/W	0h	Set this bit along with the DDC MODE6 EN1 and DDC MODE6 EN3 register bits for proper operation of mode 6. 0 = Default 1 = Use for proper operation of DDC mode 6
4	TESTMODE EN	R/W	0h	This bit generates the long transport layer test pattern mode, as per section 5.1.6.3 of the JESD204B specification. 0 = Test mode disabled 1 = Test mode enabled
3	0	W	0h	Must write 0.
2	LANE ALIGN	R/W	0h	This bit inserts the lane alignment character (K28.3) for the receiver to align to lane boundary, as per section 5.3.3.5 of the JESD204B specification. 0 = Normal operation 1 = Inserts lane alignment characters
1	FRAME ALIGN	R/W	0h	This bit inserts the lane alignment character (K28.7) for the receiver to align to lane boundary, as per section 5.3.3.5 of the JESD204B specification. 0 = Normal operation 1 = Inserts frame alignment characters
0	TX LINK DIS	R/W	0h	This bit disables sending the initial link alignment (ILA) sequence when SYNC is de-asserted. 0 = Normal operation 1 = ILA disabled



**7.6.3.7.2 Register 1h (address = 1h) [reset = 0h], JESD Digital Page (6900h)**

**图 7-68. Register 1h**

7	6	5	4	3	2	1	0
SYNC REG	SYNC REG EN	SYNCB SEL AB/CD	0	DDC MODE6 EN3	0	JESD MODE	
R/W-0h	R/W-0h	R/W-0h	W-0h	R/W-0h	W-0h	R/W-0h	

**表 7-62. Register 1h Field Descriptions**

Bit	Name	Type	Reset	Description
7	SYNC REG	R/W	0h	SYNC register (bit 6 must be enabled). 0 = Normal operation 1 = ADC output data are replaced with K28.5 characters
6	SYNC REG EN	R/W	0h	Enables bit for SYNC operation. 0 = Normal operation 1 = ADC output data overwrite enabled
5	SYNCB SEL AB/CD	R/W	0h	This bit selects which SYNCb input controls the JESD interface; must be configured for ch AB and ch CD. 0 = SYNCbAB 1 = SYNCbCD
4	0	W	0h	Must write 0.
3	DDC MODE6 EN3	R/W	0h	Set this bit along with the DDC MODE6 EN1 and DDC MODE6 EN2 register bits for proper operation of mode 6. 0 = Default 1 = Use for proper operation of DDC mode 6
2	0	W	0h	Must write 0.
1-0	JESD MODE	R/W	0h	These bits select the number of serial JESD output lanes per ADC. The JESD MODE EN (00h) and JESD PLL MODE register (JESD ANALOG page, register 16h) must also be set accordingly. 01 = 20x mode 10 = 40x mode 11 = 80x mode All others = Not used

### 7.6.3.7.3 Register 2h (address = 2h) [reset = 0h], JESD Digital Page (6900h)

图 7-69. Register 2h

7	6	5	4	3	2	1	0
LINK LAYER TESTMODE		LINK LAYER RPAT		LMFC MASK RESET	0	0	0
R/W-0h		R/W-0h		R/W-0h	W-0h	W-0h	W-0h

表 7-63. Register 2h Field Descriptions

Bit	Name	Type	Reset	Description
7-5	LINK LAYER TESTMODE	R/W	0h	These bits generate a pattern according to clause 5.3.3.8.2 of the JESD204B document. 000 = Normal ADC data 001 = D21.5 (high-frequency jitter pattern) 010 = K28.5 (mixed-frequency jitter pattern) 011 = Repeat initial lane alignment (generates a K28.5 character and continuously repeats lane alignment sequences) 100 = 12-octet RPAT jitter pattern
4	LINK LAYER RPAT	R/W	0h	This bit changes the running disparity in the modified RPAT pattern test mode (only when the link layer test mode = 100). 0 = Normal operation 1 = Changes disparity
3	LMFC MASK RESET	R/W	0h	0 = Default 1 = Resets the LMFC mask
2-0	0	W	0h	Must write 0.

### 7.6.3.7.4 Register 3h (address = 3h) [reset = 0h], JESD Digital Page (6900h)

图 7-70. Register 3h

7	6	5	4	3	2	1	0
FORCE LMFC COUNT	LMFC COUNT INIT				RELEASE ILANE SEQ		
R/W-0h	R/W-0h				R/W-0h		

表 7-64. Register 3h Field Descriptions

Bit	Name	Type	Reset	Description
7	FORCE LMFC COUNT	R/W	0h	This bit forces the LMFC count. 0 = Normal operation 1 = Enables using a different starting value for the LMFC counter
6-2	LMFC COUNT INIT	R/W	0h	SYSREF coming to the digital block resets the LMFC count to 0 and K28.5 stops coming when the LMFC count reaches 31. The initial value that the LMFC count resets to can be set using LMFC COUNT INIT. In this manner, Rx can be synchronized early because it receives the LANE ALIGNMENT SEQUENCE early. The FORCE LMFC COUNT register bit must be enabled.
1-0	RELEASE ILANE SEQ	R/W	0h	These bits delay the generation of lane alignment sequence by 0, 1, 2, or 3 multi frames after code group synchronization. 00 = 0 01 = 1 10 = 2 11 = 3

7.6.3.7.5 Register 5h (address = 5h) [reset = 0h], JESD Digital Page (6900h)

图 7-71. Register 5h

7	6	5	4	3	2	1	0
SCRAMBLE EN	0	0	0	0	0	0	0
R/W-0h	W-0h	W-0h	W-0h	W-0h	W-0h	W-0h	W-0h

表 7-65. Register 5h Field Descriptions

Bit	Name	Type	Reset	Description
7	SCRAMBLE EN	R/W	0h	Scramble enable bit in the JESD204B interface. 0 = Scrambling disabled 1 = Scrambling enabled
6-0	0	W	0h	Must write 0.

7.6.3.7.6 Register 6h (address = 6h) [reset = 0h], JESD Digital Page (6900h)

图 7-72. Register 6h

7	6	5	4	3	2	1	0
0	0	0	FRAMES PER MULTI FRAME (K)				
W-0h	W-0h	W-0h	R/W-0h				

表 7-66. Register 6h Field Descriptions

Bit	Name	Type	Reset	Description
7-5	0	W	0h	Must write 0.
4-0	FRAMES PER MULTI FRAME (K)	R/W	0h	These bits set the number of multi frames. Actual K is the value in hex + 1 (that is, 0Fh is K = 16).

7.6.3.7.7 Register 21h (address = 21h) [reset = 0h], JESD Digital Page (6900h)

图 7-73. Register 21h

7	6	5	4	3	2	1	0
OUTPUT CHA MUX SEL		OUTPUT CHB MUX SEL		OUTPUT CHC MUX SEL		OUTPUT CHD MUX SEL	
R/W-0h		R/W-0h		R/W-0h		R/W-0h	

表 7-67. 21h Field Descriptions

Bit	Name	Type	Reset	Description
7-6	OUTPUT CHA MUX SEL	R/W	0h	SERDES lane swap with ch B. 00 = Ch A is output on lane DA 10 = Ch A is output on lane DB 01, 11 = Do not use. Can only be used in 4 lane mode.
5-4	OUTPUT CHB MUX SEL	R/W	0h	SERDES lane swap with ch A. 00 = Ch B is output on lane DB 10 = Ch B is output on lane DA 01, 11 = Do not use. Can only be used in 4 lane mode.
3-2	OUTPUT CHC MUX SEL	R/W	0h	SERDES lane swap with ch D. 00 = Ch C is output on lane DC 10 = Ch C is output on lane DD 01, 11 = Do not use. Can only be used in 4 lane mode.
1-0	OUTPUT CHD MUX SEL	R/W	0h	SERDES lane swap with ch C. 00 = Ch D is output on lane DD 10 = Ch D is output on lane DC 01, 11 = Do not use. Can only be used in 4 lane mode.

**7.6.3.7.8 Register 22h (address = 22h) [reset = 0h], JESD Digital Page (6900h)**

**图 7-74. Register 22h**

7	6	5	4	3	2	1	0
0	0	0	0	OUT CHA INV	OUT CHB INV	OUT CHC INV	OUT CHD INV
W-0h	W-0h	W-0h	W-0h	R/W-0h	R/W-0h	R/W-0h	R/W-0h

**表 7-68. 22h Field Descriptions**

Bit	Name	Type	Reset	Description
7-4	0	W	0h	Must write 0.
3-0	OUT CHA, CHB, CHC and CH D INV	R/W	0h	Polarity inversion of JESD output of CHA, CHB, CHC and CHD. 00 = Normal operation 0011 = Output polarity of CHB and CHD inverted. 1100 = Output polarity of CHA and CHC inverted. 1111 = Output of all channels inverted. All others = Do not use.

**7.6.3.8 JESD Analog Page (6A00h) Register**

**7.6.3.8.1 Register 12h, 13h (address 12h, 13h) [reset = 0h], JESD Analog Page (6Ah)**

**图 7-75. Register 12h**

7	6	5	4	3	2	1	0
SEL EMP LANE DA/DD						0	0
R/W-0h						W-0h	W-0h

**图 7-76. Register 13h**

7	6	5	4	3	2	1	0
SEL EMP LANE DB/DC						0	0
R/W-0h						W-0h	W-0h

**表 7-69. 12h, 13h Field Descriptions**

Bit	Name	Type	Reset	Description
7-2	SEL EMP LANE DA/DD SEL EMP LANE DB/DC	R/W	0h	Selects the amount of de-emphasis for the JESD output transmitter. The de-emphasis value in dB is measured as the ratio between the peak value after the signal transition to the settled value of the voltage in one bit period. 0 = 0 dB 1 = - 1 dB 3 = - 2 dB 7 = - 4.1 dB 15 = - 6.2 dB 31 = - 8.2 dB 63 = - 11.5 dB
1-0	0	W	0h	Must write 0.

**7.6.3.8.2 Register 16h (address = 16h) [reset = 0h], JESD Analog Page (6A00h)**

**图 7-77. Register 16h**

7	6	5	4	3	2	1	0
0	0	0	0	0	0	JESD PLL MODE	
W-0h	W-0h	W-0h	W-0h	W-0h	W-0h	R/W-0h	

**表 7-70. Register 16h Field Descriptions**

Bit	Name	Type	Reset	Description
7-2	0	W	0h	Must write 0.
1-0	JESD PLL MODE	R/W	0h	These bits select the JESD PLL multiplication factor and must match the JESD MODE setting. 00 = 20x mode 01 = Not used 10 = 40x mode 11 = Not used

**7.6.3.8.3 Register 17h (address = 17h) [reset = 0h], JESD Analog Page (6A00h)**

**图 7-78. Register 17h**

7	6	5	4	3	2	1	0
0	PLL RESET	0	0	0	0	0	0
W-0h	R/W-0h	W-0h	W-0h	W-0h	W-0h	W-0h	W-0h

**表 7-71. Register 17h Field Descriptions**

Bit	Name	Type	Reset	Description
7	0	W	0h	Must write 0.
6	PLL RESET	R/W	0h	When SERDES line is < 5 Gbps, pulse this bit after powering up the device. 0 = Default 0 > 1 > 0 = The PLL RESET bit is pulsed.
5-0	0	W	0h	Must write 0.

**7.6.3.8.4 Register 1Bh (address = 1Bh) [reset = 0h], JESD Analog Page (6A00h)**

**图 7-79. Register 1Bh**

7	6	5	4	3	2	1	0
JESD SWING			0	0	0	0	0
R/W-0h			W-0h	W-0h	W-0h	W-0h	W-0h

**表 7-72. Register 1Bh Field Descriptions**

Bit	Name	Type	Reset	Description
7-5	JESD SWING	R/W	0h	To program the JESD swing, first disable broadcast mode by setting the DIS BROADCAST register bit to 1. Then keep the bit CH = 1 while programming the JESD SWING bits. For example, to set the swing as 930 mVpp: i) Write address 4005h, value 01h to disable broadcast mode. ii) Write address 4004h, value 6Ah; and 4003h, value 00h to access the JESD analog page. iii) Write address 701Bh, value A0h to set the swing as 930 mVpp. 0 = 860 mV <sub>PP</sub> 1 = 810 mV <sub>PP</sub> 2 = 770 mV <sub>PP</sub> 3 = 745 mV <sub>PP</sub> 4 = 960 mV <sub>PP</sub> 5 = 930 mV <sub>PP</sub> 6 = 905 mV <sub>PP</sub> 7 = 880 mV <sub>PP</sub>

表 7-72. Register 1Bh Field Descriptions (continued)

Bit	Name	Type	Reset	Description
4-0	0	W	0h	Must write 0.

## 8 Application Information Disclaimer

### 备注

以下应用部分中的信息不属于 TI 器件规格的范围，TI 不担保其准确性和完整性。TI 的客户应负责确定器件是否适用于其应用。客户应验证并测试其设计，以确保系统功能。

## 8.1 Application Information

### 8.1.1 Start-Up Sequence

The following steps are recommended as the power-up sequence with the ADS54J66 in DDC mode 8 (no decimation) with LMFS = 4421 (shown in [表 8-1](#)).

表 8-1. Recommended Power-Up Sequence

STEP	DESCRIPTION	REGISTER ADDRESS	REGISTER DATA	COMMENT
1	Power up the IOVDD 1.15-V supply before the 1.9-V supply. All other supplies (AVDD 1.9-V and AVDD 3-V supply) can be supplied in any order.	—	—	—
2	Pulse a hardware reset (low to high to low) on pin 48.	—	—	—
	Alternatively, the device can be reset with an analog reset and a digital reset.	0000h 4004h 4003h 4002h 4001h 60F7h 60F7h 70F7h 70F7h	81h 68h 00h 00h 00h 01h 00h 01h 00h	—
3	Set the input clock divider.	0011h	80h	Select the master page in the analog bank.
		0053h	80h	Set the clock divider to divide-by-2.
		0039h	C0h	Set the ALWAYS WRITE 1 bit for all channels.
		0059h	20h	Set the ALWAYS WRITE 1 bit for all channels.
4	Reset the interleaving correction engine in register 6800h of the main digital page of the JESD bank. (Register access is already set to page 6800h in step 2.)	6000h	01h	Resets the interleaving engine for channel A, B (because the device is in broadcast mode).
		6000h	00h	Resets the interleaving engine for channel C, D (because the device is in broadcast mode).
		7000h	01h	Resets the interleaving engine for channel C, D (because the device is in broadcast mode).
		7000h	00h	Resets the interleaving engine for channel C, D (because the device is in broadcast mode).
5	Set DDC mode 8 for all channels (no decimation, 14-bit, 500-MSPS data output).	4004h	61h	Select the decimation filter page of the JESD bank.
		4003h	41h	Select the decimation filter page of the JESD bank.
		6000h	08h	Select DDC mode 8 for channel A, B.
		7000h	08h	Select DDC mode 8 for channel C, D.
		6001h 7001h	04h 04h	Set the ALWAYS WRITE 1 bit for channel A, B. Set the ALWAYS WRITE 1 bit for channel C, D.
6	Default registers for the analog page of the JESD bank.	4003h	00h	Select the analog page in the JESD bank.
		4004h	6Ah	Select the analog page in the JESD bank.
		6016h	02h	PLL mode 40x for channel A, B.
		7016h	02h	PLL mode 40x for channel C, D.
7	Default registers for the digital page of the JESD bank.	4003h	00h	Select the digital page in the JESD bank.
		4004h	69h	Select the digital page in the JESD bank.
		6000h	20h	Enable JESD MODE control for channel A, B.
		6001h	01h	Set JESD MODE to 20x mode for LMFS = 4421.
		7000h	20h	Enable JESD MODE control for channel C, D.
		7001h	01h	Set JESD MODE to 20x mode for LMFS = 4421.
		6000h	80h	Set CTRL K for channel A, B.
		6006h	0Fh	Set K to 16.
		7000h	80h	Set CTRL K for channel C, D.
		7006h	0Fh	Set K to 16.

表 8-1. Recommended Power-Up Sequence (continued)

STEP	DESCRIPTION	REGISTER ADDRESS	REGISTER DATA	COMMENT
8	Enable a single SYNCb input (on the SYNCbAB pin).	4005h 7001h	01h 20h	Disable broadcast mode. Use SYNCbABP, SYNCbABM to issue a SYNC request for all four channels.
9	Pulse SYNCbAB (pins 55 and 56) from high to low.	—	—	K28.5 characters are transmitted by all four channels (CGS phase).
10	Pulse SYNCbAB (pins 55 and 56) from low to high.	—	—	The ILA sequence begins and lasts for four multiframe. The device transmits ADC data after the ILA sequence ends.

8.1.2 Hardware Reset

8.1.2.1 Register Initialization

After power-up, the internal registers can be initialized to their default values through a hardware reset by applying a high pulse on the RESET pin (of durations greater than 10 ns), as shown in 图 8-1. Alternatively, the serial interface registers can be cleared a set of register writes as described in the 节 8.1.1 section. 表 8-2 lists the timing requirements for the pulse signal on the RESET pin.

8.1.2.2

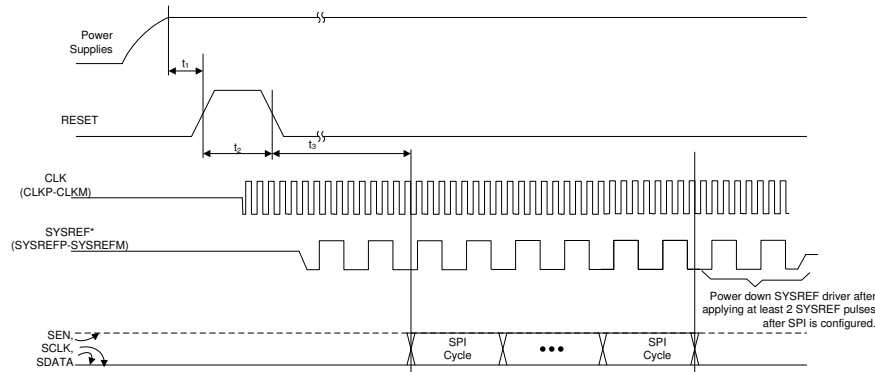

\* The SYSREF signal resets the input clock divider, the LMFC counter in the JESD block, and the NCO counters in the DDC block. Applying the SYSREF signal before configuring SPI is recommended. After SPI is configured, either the SYSREF driver can be powered down, or the SYSREF buffer inside the device can be powered down to avoid degradation in the ADC performance resulting from the SYSREF signal coupling to the ADC analog inputs.

图 8-1. Hardware Reset Timing Diagram

表 8-2. Timing Requirements for Hardware Reset

	MIN	TYP	MAX	UNIT
$t_1$ Power-on delay from power-up to active high RESET pulse	1			ms
$t_2$ Reset pulse duration : active high RESET pulse duration	10			ns
$t_3$ Register write delay from RESET disable to SEN active	100			ns

8.1.3 SYSREF Signal

Apply SYSREF after reset and before configuring the device. After the device is configured to the desired mode, the SYSREF driver can be disabled. Optionally, SYSREF can be masked inside the device using the MASK SYSREF register bit.

The SYSREF signal is sampled by the ADS54J66 device clock, and is used to reset the input clock divider that generates the sampling clock for the two interleaving ADC cores. The SYSREF signal also resets the local multiframe clock (LMFC) counter inside the JESD block, and the divider in the decimation filter block of the data converter. SYSREF is required to be a subharmonic of the LMFC frequency. The LMFC clock frequency



depends upon the device clock frequency, the DDC decimation option, and the JESD link settings (LMFS). The SYSREF signal is also recommended to be a low frequency signal (less than 5 MHz) in order to reduce coupling to the signal path both on the PCB as well as internal to the device.

表 8-3 shows that the external SYSREF signal must be a subharmonic of the internal LMFC clock.

The SYSREF frequency is equal to LMFC / N with N = 0, 1, 2, and so forth.

**表 8-3. LMFC Clock Frequency**

LMFS CONFIGURATION	DECIMATION	LMFC CLOCK
4421	—	$f_S^{(1)} / K^{(2)}$
...	...	...
4841	4x	$f_S / (4 \times K)$
2441	2x	$f_S / (2 \times K)$
4421	2x	$f_S / (2 \times K)$
4841	2x	$f_S / (2 \times K)$

(1)  $f_S$  = sampling (device) clock frequency.

(2) K = number of frames per multiframe (JESD digital page 6900h, address 06h, D4-D0).

### 8.1.4 SNR and Clock Jitter

The signal-to-noise ratio of the ADC is limited by three different factors (as shown in 方程式 2): the quantization noise is typically not noticeable in pipeline converters and is 84 dB for a 14-bit ADC. The thermal noise limits the SNR at low input frequencies and the clock jitter sets the SNR for higher input frequencies.

$$SNR_{ADC} [dBc] = -20 \log \sqrt{\left(10^{-\frac{SNR_{Quantization\ Noise}}{20}}\right)^2 + \left(10^{-\frac{SNR_{Thermal\ Noise}}{20}}\right)^2 + \left(10^{-\frac{SNR_{Jitter}}{20}}\right)^2} \quad (2)$$

The SNR limitation resulting from sample clock jitter can be calculated by 方程式 3:

$$SNR_{jitter} [dBc] = -20 \log(2\pi \times f_{in} \times T_{jitter}) \quad (3)$$

The total clock jitter ( $T_{jitter}$ ) has two components: the internal aperture jitter (120 fs for the ADS54J66) that is set by the noise of the clock input buffer and the external clock jitter.  $T_{jitter}$  can be calculated by 方程式 4:

$$T_{jitter} = \sqrt{(T_{jitter, Ext\_Clock\_Input})^2 + (T_{Aperture\_ADC})^2} \quad (4)$$

External clock jitter can be minimized by using high-quality clock sources and jitter cleaners as well as band-pass filters at the clock input; a faster clock slew rate also improves the ADC aperture jitter.

The ADS54J66 has a thermal noise of approximately 72 dBFS and an internal aperture jitter of 120 fs.

### 8.1.5 Idle Channel Histogram

图 8-2 shows a histogram of output codes for when no signal is applied at the analog inputs of the ADS54J66. 图 8-3 shows that when the dc offset correction block of the device is bypassed, the output code histogram becomes multi-modal with as many as four peaks. This (TBD this what?) happens because the ADS54J66 is a 4-way interleaved ADC with each ADC core having a different internal dc offset.



图 8-4 shows that when the dc offset correction block is frozen (instead of bypassing), the output code histogram improves (compared to when bypassed). However, when the temperature changes, the dc offset difference among interleaving cores may increase resulting in increased spacing between peaks in the histogram.



### 8.1.6 ADC Test Pattern

The ADS54J66 provides several different options to output test patterns instead of the actual output data of the ADC in order to simplify bring up of the JESD204B digital interface link. The output data path is shown in 图 8-5.

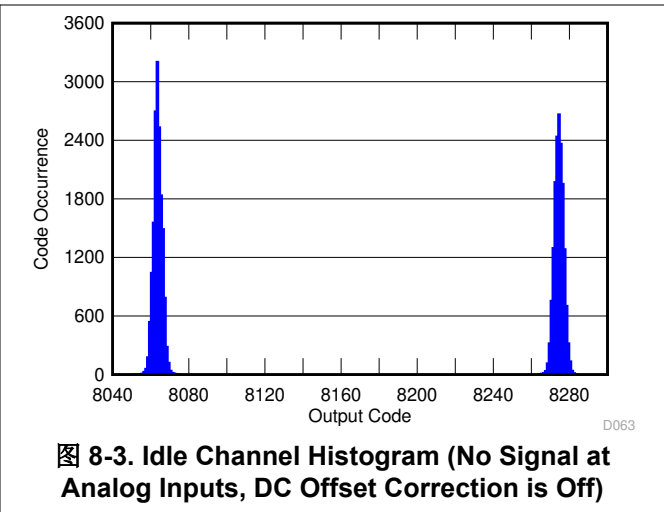
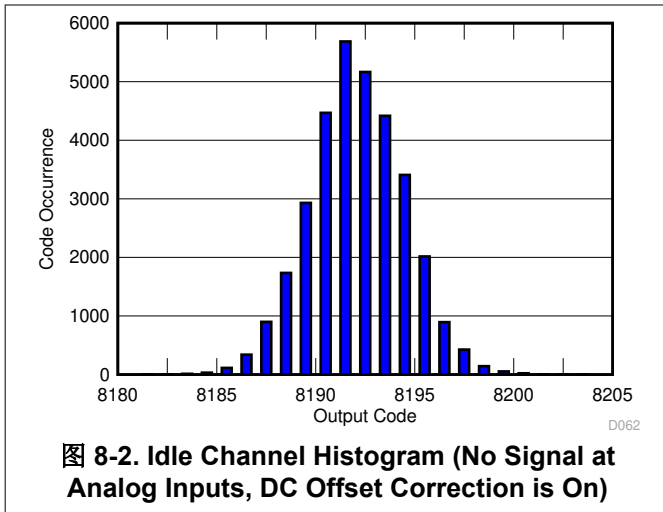
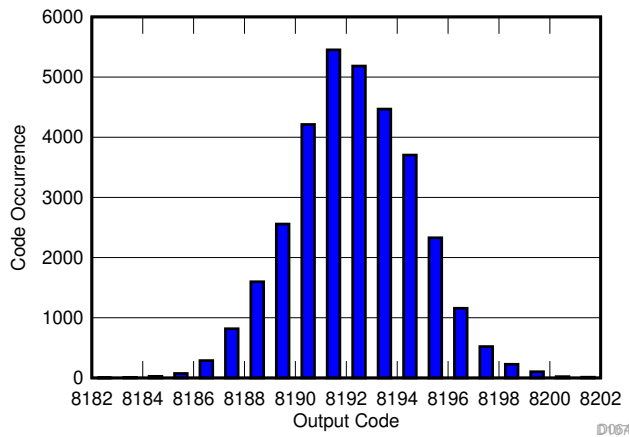

图 8-5. ADC Test Pattern

#### 8.1.6.1 ADC Section

The ADC test pattern replaces the actual output data of the ADC. The following test patterns are available in register 74h. In order to properly obtain the test pattern output, the interleaving correction must be disabled (6100h, address 18h) and DDC mode-8 must be selected (un-decimated output).

In un-decimated output (DDC mode-8), the device supports LMFS = 4421 only. Available ADC test patterns are summarized in 表 8-4.

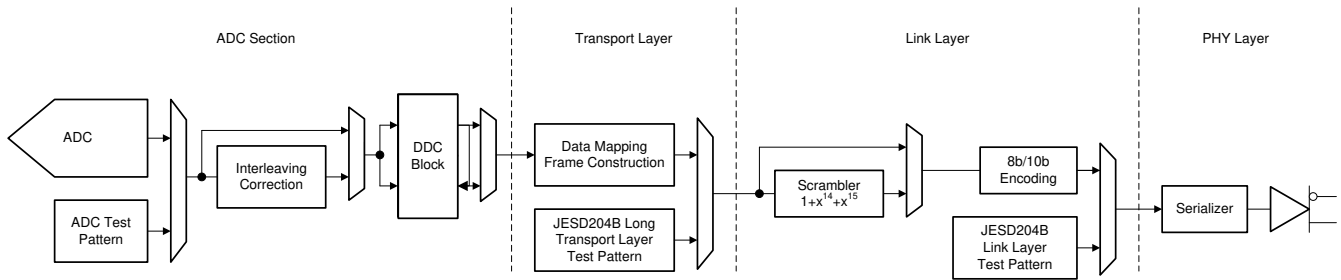
表 8-4. ADC Test Pattern Settings

BIT	NAME	DEFAULT	DESCRIPTION
7-4	TEST PATTERN	0000	These bits provide the test pattern output on channels A and B. 0000 = Normal operation using ADC output data 0001 = Outputs all 0s 0010 = Outputs all 1s 0011 = Outputs toggle pattern: output data are an alternating sequence of 101010101010 and 010101010101 0100 = Output digital ramp: output data increment by one LSB every clock cycle from code 0 to 16384 0110 = Single pattern: output data are custom pattern 1 (75h and 76h) 0111 = Double pattern: output data alternate between custom pattern 1 and custom pattern 2 1000 = Deskew pattern: output data are 2AAAh 1001 = SYNC pattern: output data are 3FFFh

#### 8.1.6.2 Transport Layer Pattern

The transport layer maps the ADC output data into 8-bit octets and constructs the JESD204B frames using the LMFS parameters. Tail bits or 0s are added when needed. Alternatively, the JESD204B long transport layer test pattern can be substituted as shown in 表 8-5.

表 8-5. Transport Layer Test Mode

BIT	NAME	DEFAULT	DESCRIPTION
4	TESTMODE EN	0	This bit generates the long transport layer test pattern mode according to clause 5.1.6.3 of the JESD204B specification. 0 = Test mode disabled 1 = Test mode enabled

### 8.1.6.3 Link Layer Pattern

The link layer contains the scrambler and the 8b/10b encoding of any data passed on from the transport layer. Additionally, the link layer also controls the initial lane alignment sequence that can be manually restarted. The link layer test patterns are intended for testing the quality of the link (jitter testing and so forth). The test patterns do not pass through the 8b/10b encoder and contain the options shown in [表 8-6](#).

**表 8-6. Link Layer Test Mode**

BIT	NAME	DEFAULT	DESCRIPTION
7-5	LINK LAYER TESTMODE	000	These bits generate the pattern according to clause 5.3.3.8.2 of the JESD204B document. 000 = Normal ADC data 001 = D21.5 (high-frequency jitter pattern) 010 = K28.5 (mixed-frequency jitter pattern) 011 = Repeat initial lane alignment (generates a K28.5 character and repeats lane alignment sequences continuously) 100 = 12-octet RPAT jitter pattern

Furthermore, a  $2^{15}$  PRBS can be enabled by setting up a custom test pattern (AAAA) in the ADC section and running that through the 8b/10b encoder with scrambling enabled.

## 8.2 Typical Application

The ADS54J66 is designed for wideband receiver applications demanding excellent dynamic range over a large input frequency range. A typical schematic for an ac-coupled dual receiver (dual FPGA with dual SYNC) is shown in [Figure 8-6](#).

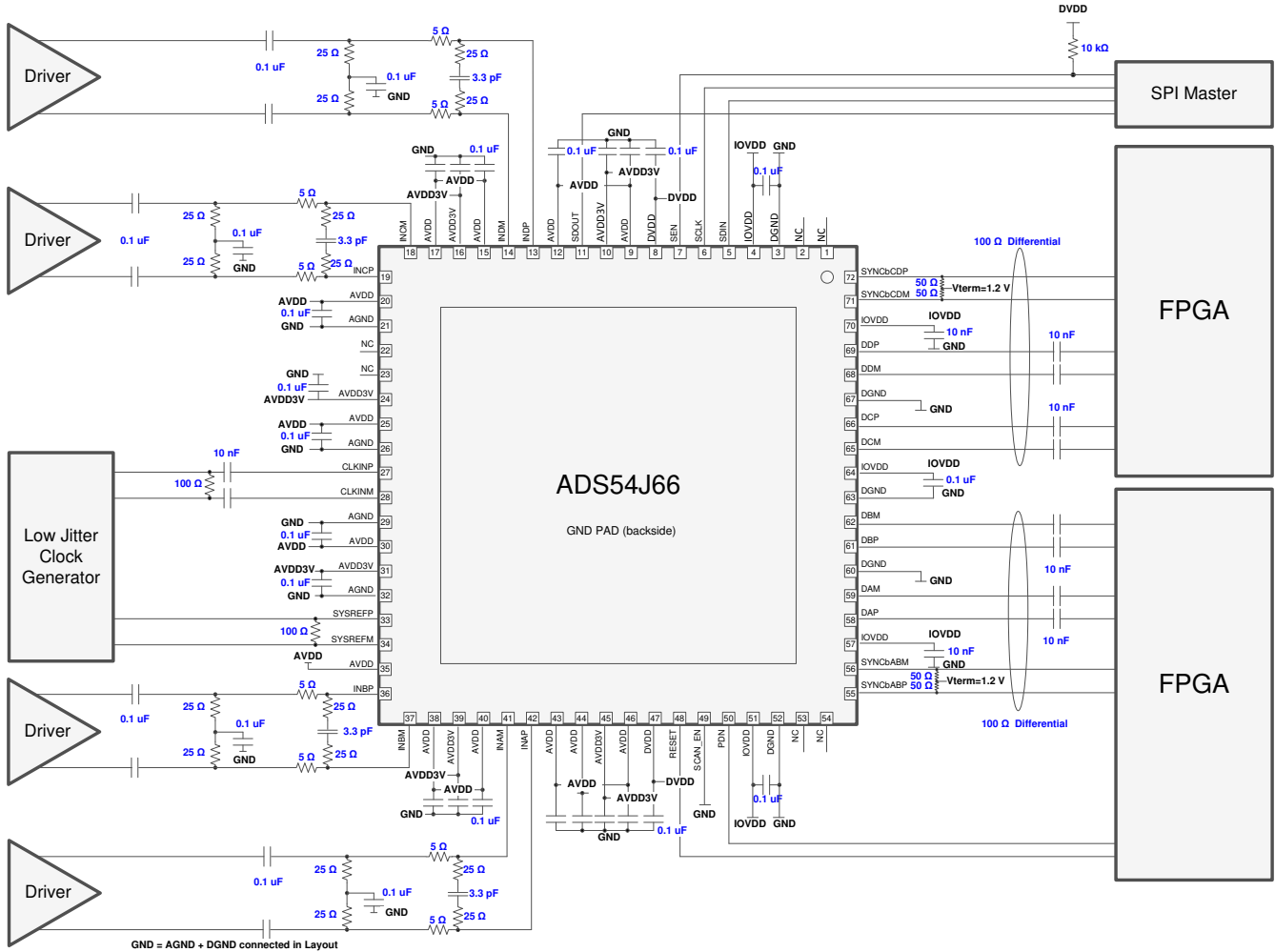

GND = AGND and DGND are connected in the PCB layout.

**Figure 8-6. Application Diagram for the ADS54J66**

### 8.2.1 Design Requirements

By using the simple drive circuit of [Figure 8-6](#) (when the amplifier drives the ADC) or [Figure 7-1](#) (when transformers drive the ADC), uniform performance can be obtained over a wide frequency range. The buffers present at the analog inputs of the device help isolate the external drive source from the switching currents of the sampling circuit.

### 8.2.2 Detailed Design Procedure

For optimum performance, the analog inputs must be driven differentially. This architecture improves the common-mode noise immunity and even-order harmonic rejection. A small resistor (5 Ohm to 10 Ohm) in series with each input pin is recommended to damp out ringing caused by package parasitics, as shown in [Figure 8-6](#).

### 8.2.3 Application Curves

图 8-7 and 图 8-8 show the typical performance at 190 MHz and 230 MHz, respectively.

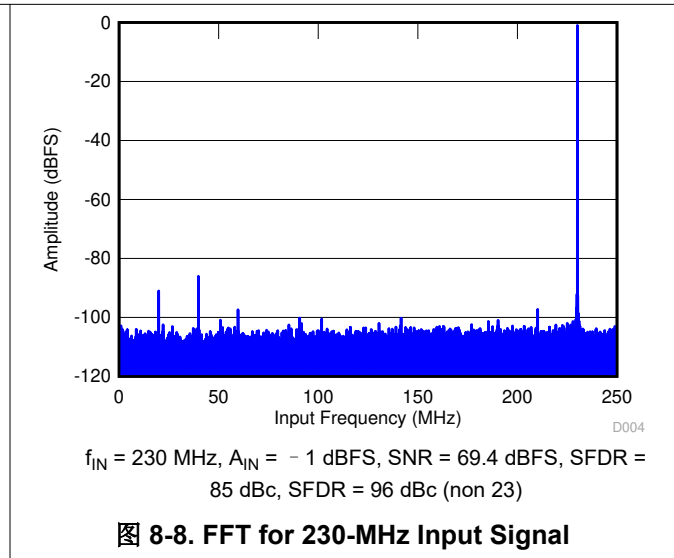
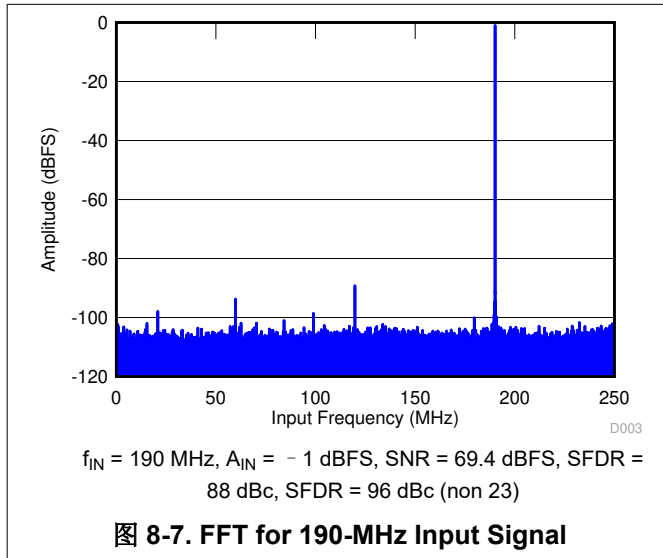

### 8.3 Power Supply Recommendations

The device requires a 1.15-V nominal supply for IOVDD, a 1.9-V nominal supply for DVDD, a 1.9-V nominal supply for AVDD, and a 3.0-V nominal supply for AVDD3V. For detailed information regarding the operating voltage minimum and maximum specifications of different supplies, see the [# 6.3](#) table.

#### 8.3.1 Power Sequencing and Initialization

[图 8-9](#) shows the suggested power-up sequencing for the device. The 1.15-V IOVDD supply must rise before the 1.9-V DVDD supply. If the 1.9-V DVDD supply rises before the 1.15-V IOVDD supply, then the internal default register settings may not load properly. The other supplies (the 3-V AVDD3V and the 1.9-V AVDD), can come up in any order during the power sequence. The power supplies can ramp up at any rate and there is no hard requirement for the time delay between IOVDD ramp up to DVDD ramp-up (can be in orders of microseconds but is recommend to be a few milliseconds).

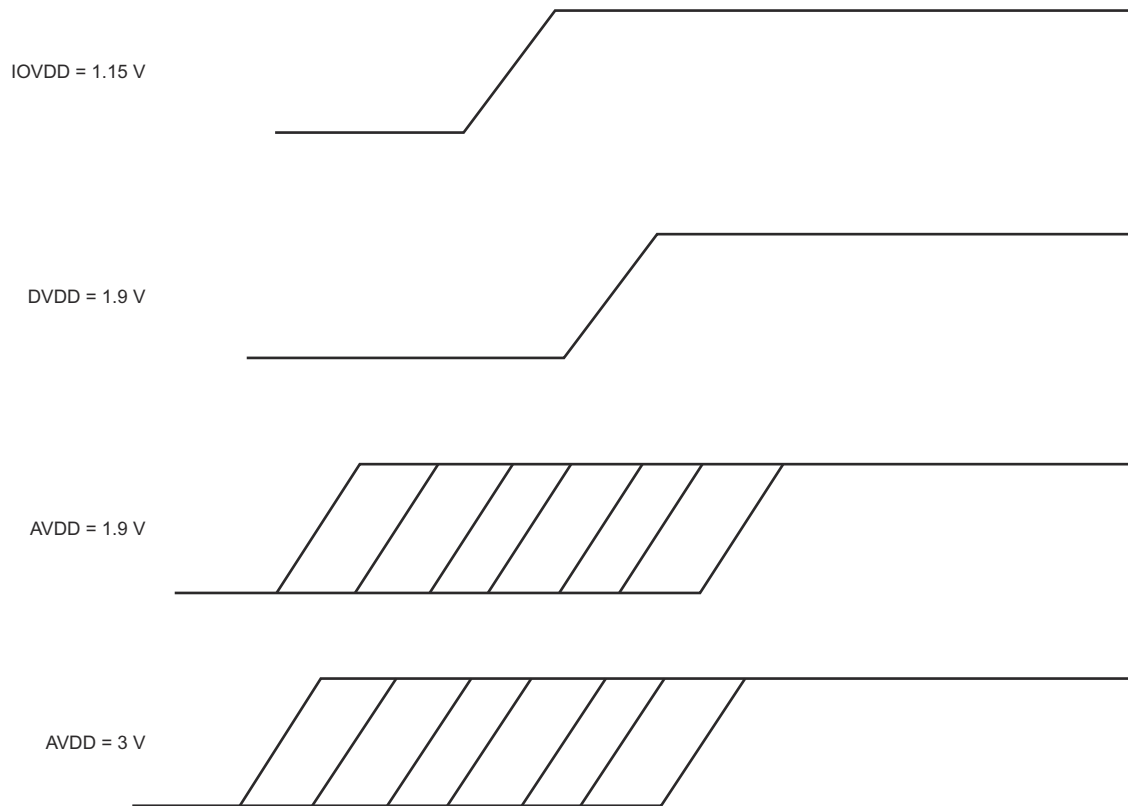

**图 8-9. Power Sequencing for the ADS54J66 Device**

## 8.4 Layout

### 8.4.1 Layout Guidelines

The device evaluation module (EVM) layout can be used as a reference layout to obtain the best performance. A layout diagram of the EVM top layer is provided in [图 8-10](#). A complete layout of the EVM is available at the [ADS54J66 EVM folder](#). Some important points to remember during board layout are:

- Analog inputs are located on opposite sides of the device pinout for minimum crosstalk on the package level. To minimize crosstalk onboard, the analog inputs must exit the pinout in opposite directions, as shown in the reference layout of [图 8-10](#) as much as possible.
- Connect INP of all unused analog inputs to AVDD and the INM to GND or vice versa.
- In the device pinout, the sampling clock is located on a side perpendicular to the analog inputs in order to minimize coupling between them. This configuration is also maintained on the reference layout of [图 8-10](#) as much as possible.
- Keep digital outputs away from the analog inputs. When these digital outputs exit the pinout, the digital output traces must not be kept parallel to the analog input traces because this configuration can result in coupling from the digital outputs to the analog inputs and degrade performance. All digital output traces to the receiver [such as a field-programmable gate array (FPGA) or an application-specific integrated circuit (ASIC)] must be matched in length to avoid skew among outputs.
- Connect a 100 Ohm differential resistor across unused SERDES outputs to limit the swing which will occur if unterminated.
- At each power-supply pin (AVDD, DVDD, or AVDDD3V), keep a 0.1- $\mu$ F decoupling capacitor close to the device. A separate decoupling capacitor group consisting of a parallel combination of 10- $\mu$ F, 1- $\mu$ F, and 0.1- $\mu$ F capacitors can be kept close to the supply source.

### 8.4.2 Layout Example



图 8-10. ADS54J66EVM Layout



## 9 Device and Documentation Support

### 9.1 接收文档更新通知

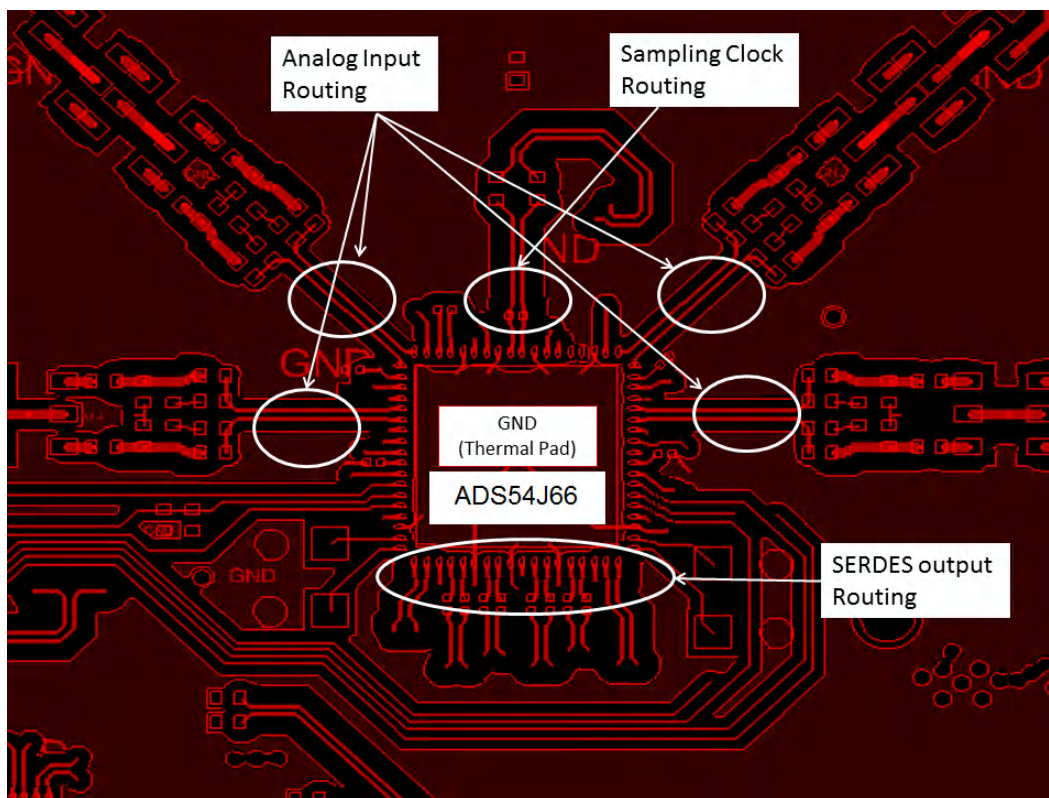
要接收文档更新通知，请导航至 [ti.com](http://ti.com) 上的器件产品文件夹。点击 [订阅更新](#) 进行注册，即可每周接收产品信息更改摘要。有关更改的详细信息，请查看任何已修订文档中包含的修订历史记录。

### 9.2 支持资源

[TI E2E™ 支持论坛](#) 是工程师的重要参考资料，可直接从专家获得快速、经过验证的解答和设计帮助。搜索现有解答或提出自己的问题可获得所需的快速设计帮助。

链接的内容由各个贡献者“按原样”提供。这些内容并不构成 TI 技术规范，并且不一定反映 TI 的观点；请参阅 TI 的《[使用条款](#)》。

### 9.3 商标

TI E2E™ is a trademark of Texas Instruments.

所有商标均为其各自所有者的财产。

### 9.4 Electrostatic Discharge Caution



This integrated circuit can be damaged by ESD. Texas Instruments recommends that all integrated circuits be handled with appropriate precautions. Failure to observe proper handling and installation procedures can cause damage.

ESD damage can range from subtle performance degradation to complete device failure. Precision integrated circuits may be more susceptible to damage because very small parametric changes could cause the device not to meet its published specifications.

### 9.5 术语表

[TI 术语表](#) 本术语表列出并解释了术语、首字母缩略词和定义。

## 10 Mechanical, Packaging, and Orderable Information

The following pages include mechanical, packaging, and orderable information. This information is the most current data available for the designated devices. This data is subject to change without notice and revision of this document. For browser-based versions of this data sheet, refer to the left-hand navigation.

**PACKAGING INFORMATION**

Orderable Device	Status (1)	Package Type	Package Drawing	Pins	Package Qty	Eco Plan (2)	Lead finish/ Ball material (6)	MSL Peak Temp (3)	Op Temp (°C)	Device Marking (4/5)	Samples
ADS54J66IRMP	ACTIVE	VQFN	RMP	72	168	RoHS & Green	NIPDAU	Level-3-260C-168 HR	-40 to 85	AZ54J66	<a href="#">Samples</a>
ADS54J66IRMPT	ACTIVE	VQFN	RMP	72	250	RoHS & Green	NIPDAU	Level-3-260C-168 HR	-40 to 85	AZ54J66	<a href="#">Samples</a>

(1) The marketing status values are defined as follows:

**ACTIVE:** Product device recommended for new designs.

**LIFEBUY:** TI has announced that the device will be discontinued, and a lifetime-buy period is in effect.

**NRND:** Not recommended for new designs. Device is in production to support existing customers, but TI does not recommend using this part in a new design.

**PREVIEW:** Device has been announced but is not in production. Samples may or may not be available.

**OBSOLETE:** TI has discontinued the production of the device.

(2) **RoHS:** TI defines "RoHS" to mean semiconductor products that are compliant with the current EU RoHS requirements for all 10 RoHS substances, including the requirement that RoHS substance do not exceed 0.1% by weight in homogeneous materials. Where designed to be soldered at high temperatures, "RoHS" products are suitable for use in specified lead-free processes. TI may reference these types of products as "Pb-Free".

**RoHS Exempt:** TI defines "RoHS Exempt" to mean products that contain lead but are compliant with EU RoHS pursuant to a specific EU RoHS exemption.

**Green:** TI defines "Green" to mean the content of Chlorine (Cl) and Bromine (Br) based flame retardants meet JS709B low halogen requirements of <=1000ppm threshold. Antimony trioxide based flame retardants must also meet the <=1000ppm threshold requirement.

(3) MSL, Peak Temp. - The Moisture Sensitivity Level rating according to the JEDEC industry standard classifications, and peak solder temperature.

(4) There may be additional marking, which relates to the logo, the lot trace code information, or the environmental category on the device.

(5) Multiple Device Markings will be inside parentheses. Only one Device Marking contained in parentheses and separated by a "~" will appear on a device. If a line is indented then it is a continuation of the previous line and the two combined represent the entire Device Marking for that device.

(6) Lead finish/Ball material - Orderable Devices may have multiple material finish options. Finish options are separated by a vertical ruled line. Lead finish/Ball material values may wrap to two lines if the finish value exceeds the maximum column width.

**Important Information and Disclaimer:**The information provided on this page represents TI's knowledge and belief as of the date that it is provided. TI bases its knowledge and belief on information provided by third parties, and makes no representation or warranty as to the accuracy of such information. Efforts are underway to better integrate information from third parties. TI has taken and continues to take reasonable steps to provide representative and accurate information but may not have conducted destructive testing or chemical analysis on incoming materials and chemicals. TI and TI suppliers consider certain information to be proprietary, and thus CAS numbers and other limited information may not be available for release.

In no event shall TI's liability arising out of such information exceed the total purchase price of the TI part(s) at issue in this document sold by TI to Customer on an annual basis.



# RMP0072A

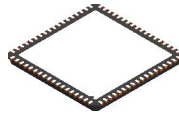

# PACKAGE OUTLINE

## VQFN - 0.9 mm max height

VQFN

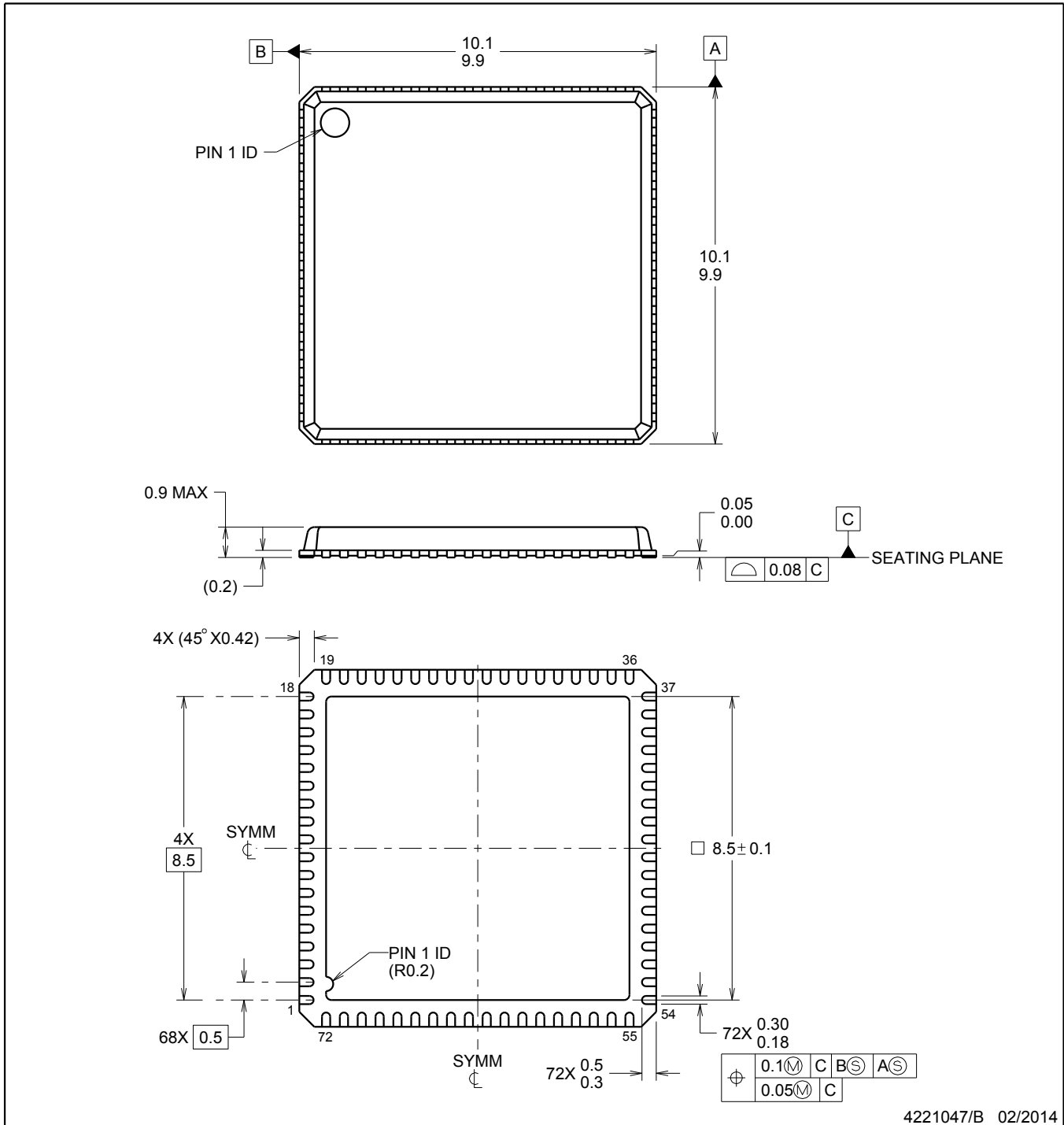

4221047/B 02/2014

### NOTES:

1. All linear dimensions are in millimeters. Any dimensions in parenthesis are for reference only. Dimensioning and tolerancing per ASME Y14.5M.
2. This drawing is subject to change without notice.
3. The package thermal pad must be soldered to the printed circuit board for thermal and mechanical performance.

# EXAMPLE BOARD LAYOUT

RMP0072A

VQFN - 0.9 mm max height

VQFN

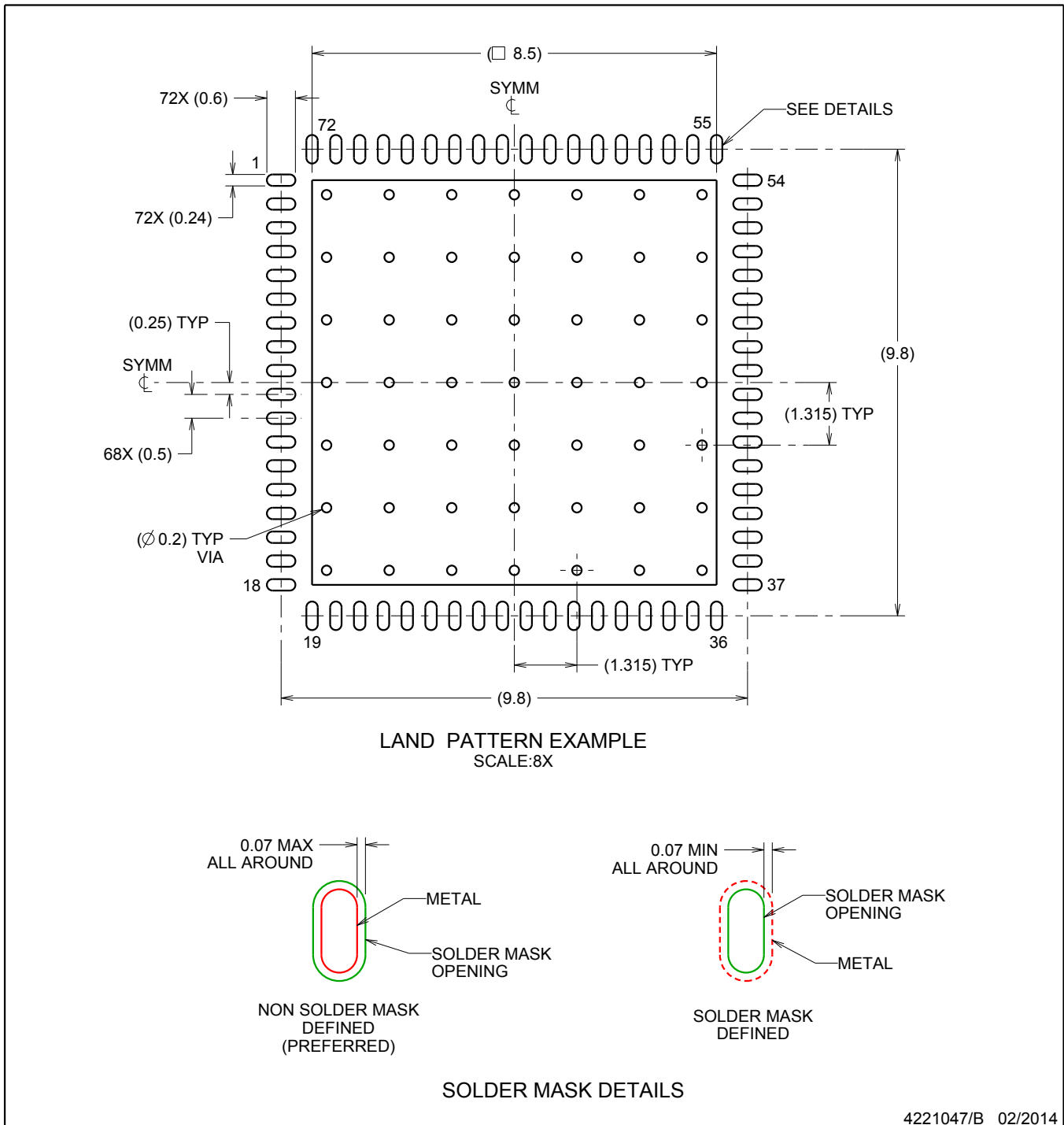

4221047/B 02/2014

NOTES: (continued)

- This package is designed to be soldered to a thermal pad on the board. For more information, see QFN/SON PCB application report in literature No. SLUA271 ([www.ti.com/lit/slua271](http://www.ti.com/lit/slua271)).

# EXAMPLE STENCIL DESIGN

RMP0072A

VQFN - 0.9 mm max height

VQFN

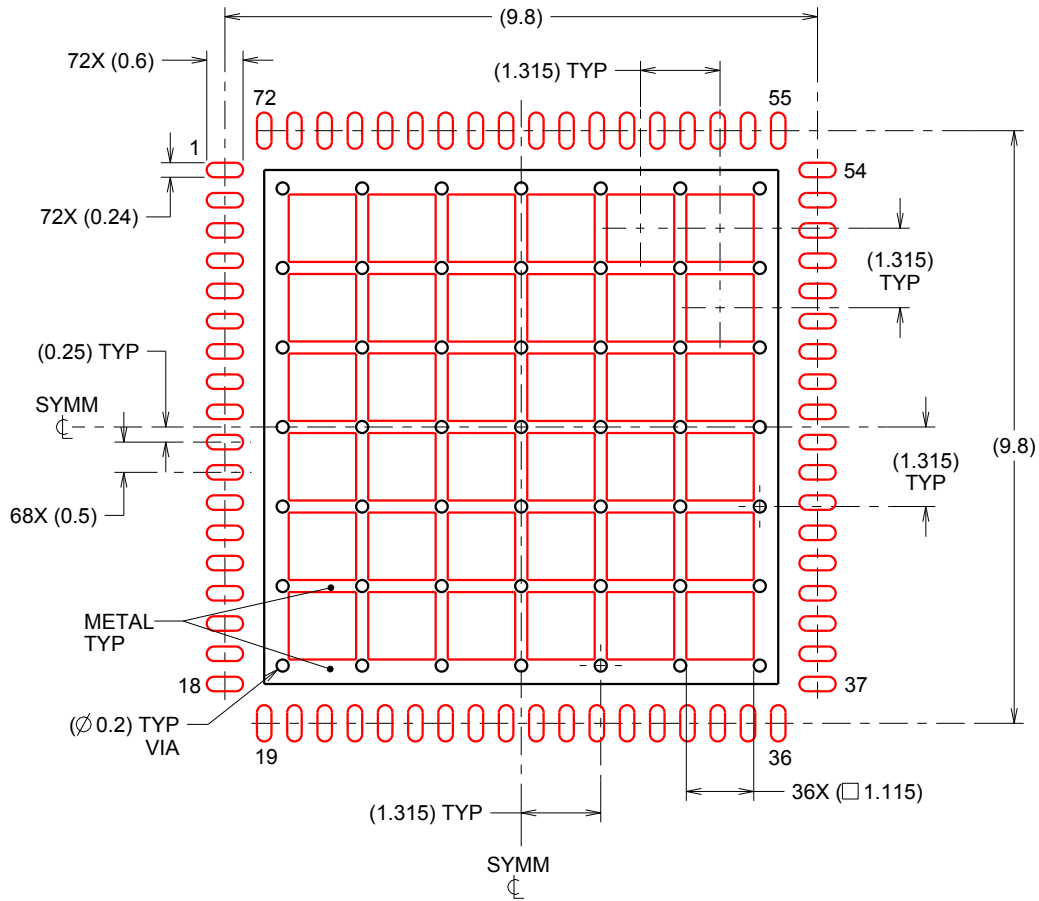

SOLDER PASTE EXAMPLE  
 BASED ON 0.125 mm THICK STENCIL

EXPOSED PAD  
 62% PRINTED SOLDER COVERAGE BY AREA  
 SCALE:8X

4221047/B 02/2014

NOTES: (continued)

5. Laser cutting apertures with trapezoidal walls and rounded corners may offer better paste release. IPC-7525 may have alternate design recommendations.

## 重要声明和免责声明

TI“按原样”提供技术和可靠性数据（包括数据表）、设计资源（包括参考设计）、应用或其他设计建议、网络工具、安全信息和其他资源，不保证没有瑕疵且不做任何明示或暗示的担保，包括但不限于对适销性、某特定用途方面的适用性或不侵犯任何第三方知识产权的暗示担保。

这些资源可供使用 TI 产品进行设计的熟练开发人员使用。您将自行承担以下全部责任：(1) 针对您的应用选择合适的 TI 产品，(2) 设计、验证并测试您的应用，(3) 确保您的应用满足相应标准以及任何其他功能安全、信息安全、监管或其他要求。

这些资源如有变更，恕不另行通知。TI 授权您仅可将这些资源用于研发本资源所述的 TI 产品的应用。严禁对这些资源进行其他复制或展示。您无权使用任何其他 TI 知识产权或任何第三方知识产权。您应全额赔偿因在这些资源的使用中对 TI 及其代表造成的任何索赔、损害、成本、损失和债务，TI 对此概不负责。

TI 提供的产品受 [TI 的销售条款](#) 或 [ti.com](#) 上其他适用条款/TI 产品随附的其他适用条款的约束。TI 提供这些资源并不会扩展或以其他方式更改 TI 针对 TI 产品发布的适用的担保或担保免责声明。

TI 反对并拒绝您可能提出的任何其他或不同的条款。

邮寄地址：Texas Instruments, Post Office Box 655303, Dallas, Texas 75265

Copyright © 2023，德州仪器 (TI) 公司