

具有 12GSPS DAC 和 3GSPS ADC 的 AFE7900 4T6R 射频采样 AFE

1 特性

- [申请完整数据表](#)
- 四通道射频采样 12 GSPS 发送 DAC
- 四通道射频采样 3 GSPS 接收 ADC
- 双通道射频采样 3 GSPS 反馈 (辅助 RX) ADC
- 最大射频信号带宽：
 - 4TX 或 2FB : 1200 MHz 或 2TX : 2400 MHz
 - RX) : 1200 MHz (无 FB) 、 600 MHz (带 FB)
- 射频频率范围：
 - TX : 5MHz - 7.4GHz
 - RX/FB : 5MHz -7.4GHz
- 数字步进衰减器 (DSA) :
 - TX : 40 dB 范围, 0.125 dB 步进
 - RX 或 FB : 25 dB 范围, 0.5 dB 步进
- 用于 TX 和 RX 的单频带或双频带 DUC/DDC
- 每个 TX/RX 和 FB 为 16 个 NCO
- 可选内部 PLL/VCO, 提供 DAC 或 ADC 采样率下的 DAC/ADC 时钟或外部时钟
- Sysref 对齐检测器
- 串行器/解串器数据接口：
 - 可兼容 JESD204B 和 JESD204C
 - 8 个高达 29.5 Gbps 的串行器/解串器收发器
 - 子类 1 多器件同步
- 封装 : 17mm × 17mm FCBGA, 间距 0.8 mm

2 应用

- [雷达](#)
- [导引头前端](#)
- [国防无线电](#)
- [战术通信基础设施](#)
- [无线通信测试](#)

3 说明

AFE7900 是一款高性能、高带宽、多通道收发器, 集成了四个射频采样发送链、四个射频采样接收链和两个射频采样反馈链 (总计六个射频采样 ADC)。此器件具有高达 7.4GHz 的工作频率, 支持直接在 L、S 和 C 频带频率范围内进行射频采样, 无需额外的频率转换级。密度和灵活性提高后可支持高通道数、多任务系统。

TX 信号路径支持插值和数字上变频选项, 从而为四个 TX 提供高达 1200MHz 的信号带宽, 或者为两个 TX 提供高达 2400MHz 的信号带宽。DUC 的输出驱动一个 12GSPS DAC (数模转换器), 通过混合模式输出选项增强在第二奈奎斯特区的运行。DAC 输出包括一个具有 40dB 范围以及 1dB 模拟和 0.125dB 数字步进的可选增益放大器 (TX DSA)。

每个接收器链均包含一个 25dB 范围的数字步进衰减器 (DSA), 后跟一个 3GSPS 模数转换器 (ADC)。每个接收器通道都有多个模拟峰值功耗检测器和各种数字功耗检测器, 可辅助进行外部或内部自主自动增益控制器, 另外还具有一个射频过载检测器, 用于提供器件可靠性保护。灵活的抽取选项可为数据带宽提供高达 1200MHz 的优化 (对于四条不带 FB 路径的 RX), 或为带两条 FB 路径 (每条 1200MHz 带宽) 提供 600MHz 的优化。

该器件包含一个 SYSREF 时序检测器, 用于优化相对于器件时钟的 SYSREF 输入时序。

封装信息

器件型号	封装 ⁽¹⁾	封装尺寸 ⁽²⁾
AFE7900	FC-BGA	17 mm × 17 mm

(1) 如需了解更多信息, 请参阅 [机械、封装和可订购信息](#)。

(2) 封装尺寸 (长 × 宽) 为标称值, 并包括引脚 (如适用)。



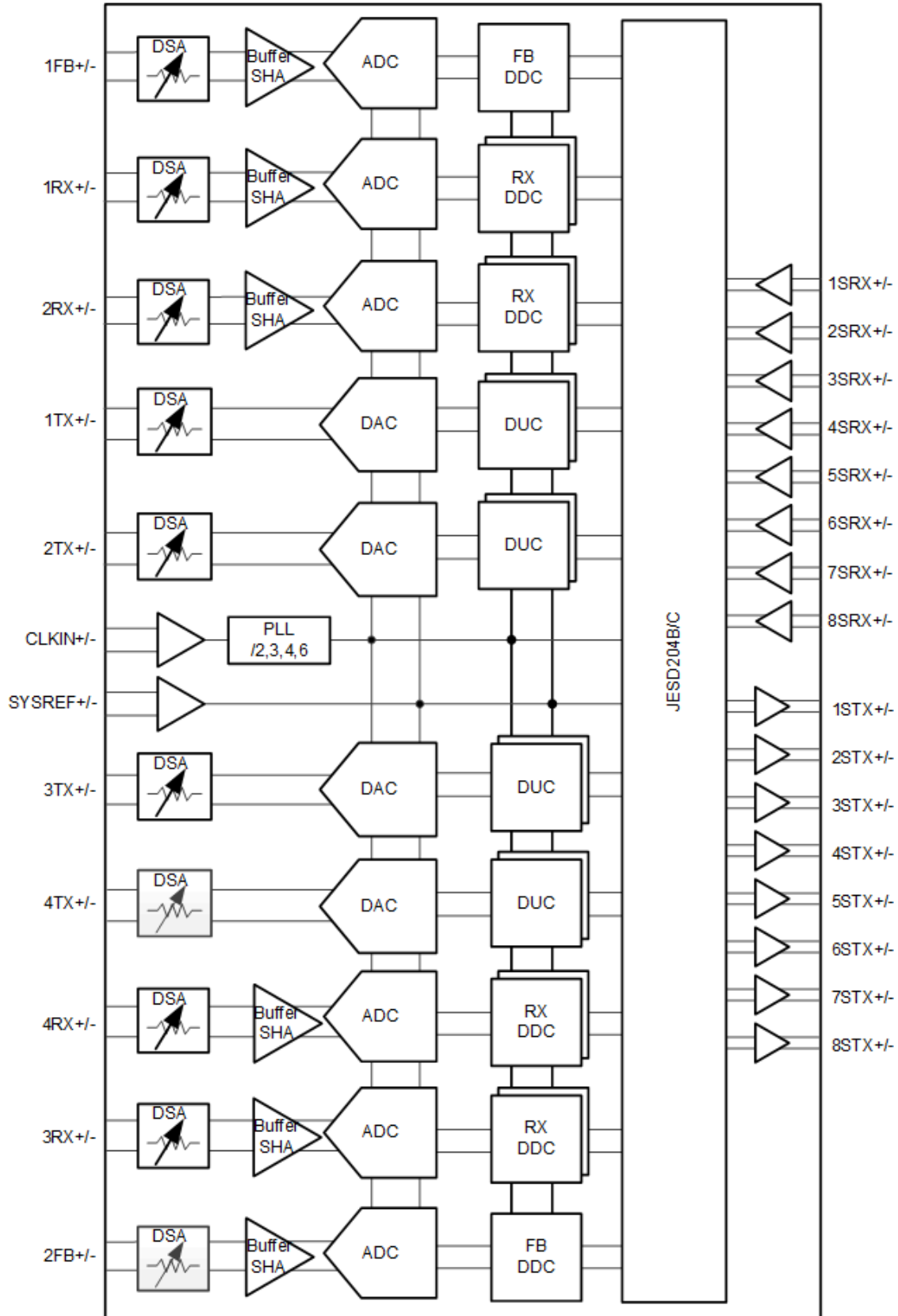

功能方框图

Table of Contents

<p>1 特性..... 1</p> <p>2 应用..... 1</p> <p>3 说明..... 1</p> <p>4 Revision History..... 3</p> <p>5 Specifications..... 4</p> <p> 5.1 Absolute Maximum Ratings..... 4</p> <p> 5.2 ESD Ratings..... 4</p> <p> 5.3 Recommended Operating Conditions..... 5</p> <p> 5.4 Thermal Information..... 5</p> <p> 5.5 Transmitter Electrical Characteristics..... 6</p> <p> 5.6 RF ADC Electrical Characteristics..... 15</p> <p> 5.7 PLL/VCO/Clock Electrical Characteristics..... 21</p>	<p> 5.8 Digital Electrical Characteristics..... 23</p> <p> 5.9 Power Supply Electrical Characteristics..... 25</p> <p> 5.10 Timing Requirements..... 30</p> <p> 5.11 Switching Characteristics..... 31</p> <p> 5.12 Typical Characteristics..... 32</p> <p>6 Device and Documentation Support..... 151</p> <p> 6.1 接收文档更新通知..... 151</p> <p> 6.2 支持资源..... 151</p> <p> 6.3 商标..... 151</p> <p> 6.4 静电放电警告..... 151</p> <p> 6.5 术语表..... 151</p> <p>7 Mechanical, Packaging, and Orderable Information 151</p>
---	---

4 Revision History

注：以前版本的页码可能与当前版本的页码不同

Changes from August 6, 2021 to June 14, 2023 (from Revision A (August 2021) to Revision B (June 2023))

	Page
• 更改了“封装信息”表以加入注释 2.....	1
• Changed I_{IH} and I_{IL} units to μA	23
• Changed 0RX - 3RX to 1RX - 4RX in several plots.....	55
• Changed 0RX - 3RX to 1RX - 4RX in several plots.....	60
• Changed 0TX - 3TX to 1TX - 4TX.....	73
• Removed dither plot. This is set automatically in the configuration software.....	73
• Deleted TX Clock Dither Enabled from all TX Typical Characteristics Sections.....	73
• Change 0TX - 3TX to 1TX to 4TX in several plots.....	103
• Removed figure vs dither. This is set automatically in the configuration software.....	103
• Changed 0TX - 3TX to 1TX - 4TX.....	116
• Removed dither plot. This is set automatically in the configuration software.....	116
• Change 0TX - 3TX to 1TX - 4TX.....	137
• Changed 1 st Nyquist zone output to 2 nd Nyquist zone output.....	137

Changes from Revision * (February 2021) to Revision A (August 2021)

	Page
• 向“申请完整数据表”添加了特性.....	1
• Added the Specification tables to the data sheet.....	4

5 Specifications

5.1 Absolute Maximum Ratings

over operating free-air temperature range (unless otherwise noted)⁽¹⁾

		MIN	MAX	UNIT
Supply Voltage Range	DVDD0P9, VDDT0P9	- 0.3	1.2	V
	VDD1P2RX, VDD1P2TXCLK, VDD1P2TXENC, VDD1P2PLL, VDD1P2PLLCLKREF, VDD1P2FB, VDD1P2FBCML, VDD1P2RXCML	- 0.3	1.4	V
	VDD1P8RX, VDD1P8RXCLK, VDD1P8TX, VDD1P8TXDAC, VDD1P8TXENC, VDD1P8PLL, VDD1P8PLLVC0, VDD1P8FB, VDD1P8FBCLK, VDD1P8GPIO, VDDA1P8	- 0.5	2.1	V
Pin Voltage Range	{1/2/3/4}RXIN+/-	- 0.5	VDDR1P8+0.3	V
	1FBIN+/-, 2FB+/-	- 0.5	VDDFB1P8+0.3	V
	{1/2/3/4}TXOUT+/-	- 0.5	VDDTX1P8+0.3	V
	REFCLK+/-, SYSREF+/-	- 0.3	1.4	V
	{1:8}SRX+/-	- 0.3	1.4	V
	{1:8}STX+/-	- 0.3	1.4	V
	GPIO{B/C/D/E}x, SPICLK, SPISDIO, SPISDO, SPISEN, RESETZ, BISTB0, BISTB1	- 0.5	VDD1P8GPIO + 0.3	V
	IFORCE, VSENSE	- 0.3	VDDCLK1P8 + 0.3	V
SRDAMUX1, SRDAMUX2	- 0.3	VDDA1P8+0.3	V	
Peak Input Current	any input		20	mA
T _J	Junction temperature		150	°C
T _{stg}	Storage temperature	- 65	150	°C

- (1) Stresses beyond those listed under *Absolute Maximum Rating* may cause permanent damage to the device. These are stress ratings only, which do not imply functional operation of the device at these or any other conditions beyond those indicated under *Recommended Operating Conditions*. Exposure to absolute-maximum-rated conditions for extended periods may affect device reliability.

5.2 ESD Ratings

			VALUE	UNIT
V _(ESD)	Electrostatic discharge	Human body model (HBM), per ANSI/ESDA/ JEDEC JS-001, all pins ⁽¹⁾	1000	V
		Charged device model (CDM), per JEDEC specification JESD22-C101, all pins	150	

- (1) JEDEC document JEP155 states that 500-V HBM allows safe manufacturing with a standard ESD control process.

5.3 Recommended Operating Conditions

over operating free-air temperature range (unless otherwise noted)

		MIN	NOM	MAX	UNIT
DVDD0P9, VDDT0P9	Supply voltage 0.9V	0.9	0.925	0.95	V
VDD1P2{RX/TXCLK/TXENC/FB/PLL/PLLCLKREF/FBCML/RXCML}	Supply voltage 1.2V	1.15	1.2	1.25	V
VDD1P8{RX/RXCLK/TX/TXDAC/TXENC/PLL/PLLVCO/FB/FBCLK/GPIO}, VDDA1P8	Supply voltage 1.8V	1.75	1.8	1.85	V
T _A	Ambient temperature	- 40		85	°C
T _J	Operating Junction Temperature			110 ⁽¹⁾	°C
	Maximum Operating Junction Temperature	125			°C

- (1) Prolonged use at or above this junction temperature can increase the device failure-in-time (FIT) rate. Refer to [SBAA403 application note](#) for additional details

5.4 Thermal Information

THERMAL METRIC ⁽¹⁾		AFE7900	UNIT
		FC-BGA	
		400 PINS	
R _{θJA}	Junction-to-ambient thermal resistance	16.2	°C/W
R _{θJC(top)}	Junction-to-case (top) thermal resistance	0.42	°C/W
R _{θJB}	Junction-to-board thermal resistance	4.85	°C/W
Ψ _{JT}	Junction-to-top characterization parameter	0.12	°C/W
Ψ _{JB}	Junction-to-board characterization parameter	4.6	°C/W

- (1) For more information about traditional and new thermal metrics, see the [Semiconductor and IC Package Thermal Metrics](#) application report.

5.5 Transmitter Electrical Characteristics

Typical values at $T_A = +25^\circ\text{C}$, full temperature range is $T_{A,\text{MIN}} = -40^\circ\text{C}$ to $T_{J,\text{MAX}} = +110^\circ\text{C}$; TX Input Rate = 491.52MSPS below 6GHz and 750MSPS above 6GHz, $f_{\text{DAC}} = 11796.48\text{MSPS}$ below 6GHz and $f_{\text{DAC}} = 9000\text{MSPS}$ above 6GHz; PLL clock mode below 6GHz output frequency and External clock mode above 6GHz output frequency; interleave mode for 1st Nyquist, non-interleave mix mode for 2nd Nyquist, nominal power supplies; 1 tone at -1 dBFS; DSA Attenuation = 0dB, unless otherwise noted.

PARAMETER		TEST CONDITIONS	MIN	TYP	MAX	UNIT
DAC_{RES}	DAC resolution			14		bits
f_{RFout}	RF output frequency range	$f_{\text{DAC}} = 12 \text{ GSPS}, 1^{\text{st}} \text{ Nyquist}$	5		6000	MHz
		$f_{\text{DAC}} = 9 \text{ GSPS}, 1^{\text{st}} \text{ Nyquist}$	5		4500	
		$f_{\text{DAC}} = 9 \text{ GSPS}, 2^{\text{nd}} \text{ Nyquist}$	4500		7400	
		$f_{\text{DAC}} = 6 \text{ GSPS}, 1^{\text{st}} \text{ Nyquist}$	5		3000	
		$f_{\text{DAC}} = 6 \text{ GSPS}, 2^{\text{nd}} \text{ Nyquist}$	3000		6000	
$P_{\text{max_FS}}$	Max Full Scale Output Power, max gain 1 tone, at device pins	$f_{\text{out}} = 10 \text{ MHz}, f_{\text{DAC}} = 6\text{GSPS}, -0.1\text{dBFS}$		6.5		dBm
		$f_{\text{out}} = 30 \text{ MHz}, f_{\text{DAC}} = 6\text{GSPS}, -0.1\text{dBFS}$		6.5		dBm
		$f_{\text{out}} = 400 \text{ MHz}, f_{\text{DAC}} = 6\text{GSPS}, -0.1\text{dBFS}$		5.6		dBm
		$f_{\text{out}} = 850 \text{ MHz}, f_{\text{DAC}} = 5898.24 \text{ MSPS}, -0.5\text{dBFS}$		4.3		dBm
		$f_{\text{out}} = 1800 \text{ MHz}, f_{\text{DAC}} = 5898.24 \text{ MSPS}, -0.5\text{dBFS}$		3.2		dBm
		$f_{\text{out}} = 2600 \text{ MHz}, f_{\text{DAC}} = 8847.36 \text{ MSPS}, -0.5\text{dBFS}$		2.3		dBm
		$f_{\text{out}} = 3500 \text{ MHz}, -0.5\text{dBFS}$		2.9		dBm
		$f_{\text{out}} = 4900 \text{ MHz}, -0.5\text{dBFS}$		-0.6		dBm
		$f_{\text{out}} = 3500 \text{ MHz}, f_{\text{DAC}} = 5898.24 \text{ MSPS}, -0.5\text{dBFS}, \text{straight mode}$		-2.3		dBm
		$f_{\text{out}} = 4900 \text{ MHz}, f_{\text{DAC}} = 5898.24 \text{ MSPS}, -0.5\text{dBFS}, \text{straight mode}$		-3.4		dBm
		$f_{\text{out}} = 4900 \text{ MHz}, f_{\text{DAC}} = 8847.36 \text{ MSPS}, -0.5\text{dBFS}, \text{straight mode}$		-3.9		dBm
R_{TERM}	Output termination resistor	Default setting		100		Ω
$\text{ATT}_{\text{range}}$	DSA Attenuation range			40		dB
ATT_{step}	DSA Analog Attenuation step			1.0		dB
	DSA Attenuation step accuracy (DNL) (2)	$0 < \text{Atten} < 40\text{dB}, \text{after calibration}$		± 0.1		dB
		$0 < \text{Atten} < 40\text{dB}, \text{before calibration}$		± 0.2		
ATT_{step}	DSA Gain Steps Phase accuracy, any 8dB range (2)	$f_{\text{out}} = 30\text{MHz}$		± 1		deg
		$f_{\text{out}} = 400\text{MHz}$		± 1		deg
		$f_{\text{out}} = 850\text{MHz}$		± 1		deg
		$f_{\text{out}} = 1800\text{MHz}$		± 1		deg
		$f_{\text{out}} = 2600\text{MHz}$		± 1		deg
		$f_{\text{out}} = 3500\text{MHz}$		± 1		
		$f_{\text{out}} = 4900\text{MHz}$		± 1		deg
G_{flat}	Gain flatness	any 20MHz		0.1		dB
		600MHz BW, $F_{\text{out}} < 4.9\text{G}$		1.2		

5.5 Transmitter Electrical Characteristics (continued)

Typical values at $T_A = +25^\circ\text{C}$, full temperature range is $T_{A,MIN} = -40^\circ\text{C}$ to $T_{J,MAX} = +110^\circ\text{C}$; TX Input Rate = 491.52MSPS below 6GHz and 750MSPS above 6GHz, $f_{DAC} = 11796.48\text{MSPS}$ below 6GHz and $f_{DAC} = 9000\text{MSPS}$ above 6GHz; PLL clock mode below 6GHz output frequency and External clock mode above 6GHz output frequency; interleave mode for 1st Nyquist, non-interleave mix mode for 2nd Nyquist, nominal power supplies; 1 tone at -1 dBFS; DSA Attenuation = 0dB, unless otherwise noted.

PARAMETER		TEST CONDITIONS	MIN	TYP	MAX	UNIT
IMD3	3rd Order Intermodulation distortion	$f_{DAC} = 6\text{ GSPS}$, $f_{out} = 5\text{MHz} \pm 1\text{MHz}$, -7dBFS each tone		-48		dBc
		$f_{DAC} = 6\text{ GSPS}$, $f_{out} = 30\text{MHz} \pm 1\text{MHz}$, -7dBFS each tone		-47		dBc
		$f_{DAC} = 6\text{ GSPS}$, $f_{out} = 400\text{MHz} \pm 2\text{MHz}$, -7dBFS each tone		-51		dBc
		$f_{out} = 850\text{MHz} \pm 10\text{MHz}$, -7dBFS each tone		-61		dBc
		$f_{out} = 1800\text{MHz} \pm 10\text{MHz}$, -7dBFS each tone		-62		dBc
		$f_{out} = 2600\text{MHz} \pm 10\text{MHz}$, -7dBFS each tone		-64		dBc
		$f_{out} = 3500\text{MHz} \pm 10\text{MHz}$, -7dBFS each tone		-63		dBc
		$f_{out} = 4900\text{MHz} \pm 10\text{MHz}$, -7dBFS each tone		-64		dBc
		$f_{out} = 5\text{MHz} \pm 1\text{MHz}$, -13dBFS each tone		-72		dBc
		$f_{DAC} = 6\text{ GSPS}$, $f_{out} = 30\text{MHz} \pm 1\text{MHz}$, -13dBFS each tone		-71		dBc
		$f_{DAC} = 6\text{ GSPS}$, $f_{out} = 400\text{MHz} \pm 2\text{MHz}$, -13dBFS each tone		-72		dBc
		$f_{out} = 850\text{MHz} \pm 10\text{MHz}$, -13dBFS each tone		-73		dBc
		$f_{out} = 1800\text{MHz} \pm 10\text{MHz}$, -13dBFS each tone		-75		dBc
		$f_{out} = 2600\text{MHz} \pm 10\text{MHz}$, -13dBFS each tone		-79		dBc
		$f_{out} = 3500\text{MHz} \pm 10\text{MHz}$, -13dBFS each tone		-77		dBc
$f_{out} = 4900\text{MHz} \pm 10\text{MHz}$, -13dBFS each tone		-77		dBc		
SFDR	Spurious Free Dynamic Range (within Nyquist zone)	$f_{out} = 30\text{ MHz}$, $f_{DAC} = 6000\text{ MSPS}$, interleave mode, 20Gbps SerDes rate		45		dBc
		$f_{out} = 400\text{ MHz}$, $f_{DAC} = 6000\text{ MSPS}$, interleave mode, 20Gbps SerDes rate		48		dBc
		$f_{out} = 850\text{ MHz}$, $f_{DAC} = 11796.48\text{ MSPS}$		62		dBc
		$f_{out} = 1800\text{ MHz}$, $f_{DAC} = 11796.48\text{ MSPS}$		56		dBc
		$f_{out} = 2600\text{ MHz}$, $f_{DAC} = 11796.48\text{ MSPS}$		39		dBc
		$f_{out} = 3500\text{ MHz}$, $f_{DAC} = 11796.48\text{ MSPS}$		42		dBc
		$f_{out} = 4900\text{ MHz}$, $f_{DAC} = 11796.48\text{ MSPS}$		60		dBc

5.5 Transmitter Electrical Characteristics (continued)

Typical values at $T_A = +25^\circ\text{C}$, full temperature range is $T_{A,\text{MIN}} = -40^\circ\text{C}$ to $T_{J,\text{MAX}} = +110^\circ\text{C}$; TX Input Rate = 491.52MSPS below 6GHz and 750MSPS above 6GHz, $f_{\text{DAC}} = 11796.48\text{MSPS}$ below 6GHz and $f_{\text{DAC}} = 9000\text{MSPS}$ above 6GHz; PLL clock mode below 6GHz output frequency and External clock mode above 6GHz output frequency; interleave mode for 1st Nyquist, non-interleave mix mode for 2nd Nyquist, nominal power supplies; 1 tone at -1 dBFS; DSA Attenuation = 0dB, unless otherwise noted.

PARAMETER		TEST CONDITIONS	MIN	TYP	MAX	UNIT
$f_s/2 - f_{\text{OUT}}$	Interleaving Image	$f_{\text{DAC}} = 5898.24\text{MSPS}$, interleave mode		-47		dBc
		$f_{\text{DAC}} = 8847.36\text{MSPS}$, interleave mode		-43		dBc
		$f_{\text{DAC}} = 11796.48\text{MSPS}$, interleave mode		-43		dBc
HD2	2 nd Harmonic Distortion (within Nyquist zone)	$f_{\text{DAC}} = 6\text{GSPS}$, $f_{\text{out}} = 5\text{MHz}$		-72		dBc
		$f_{\text{DAC}} = 6\text{GSPS}$, $f_{\text{out}} = 30\text{MHz}$		-75		dBc
		$f_{\text{DAC}} = 6\text{GSPS}$, $f_{\text{out}} = 100\text{MHz}$		-73		dBc
		$f_{\text{out}} = 400\text{MHz}$		-46		dBc
		$f_{\text{out}} = 850\text{MHz}$		-65		dBc
		$f_{\text{out}} = 1800\text{MHz}$		-68		dBc
		$f_{\text{out}} = 2600\text{MHz}$		-47		dBc
		$f_{\text{out}} = 3500\text{MHz}$		-59		dBc
		$f_{\text{out}} = 4900\text{MHz}$		-48		dBc
		$f_{\text{out}} = 850\text{MHz}$, $A_{\text{OUT}} = -12\text{dBFS}$		-74		dBc
		$f_{\text{out}} = 1800\text{MHz}$, $A_{\text{OUT}} = -12\text{dBFS}$		-67		dBc
		$f_{\text{out}} = 2600\text{MHz}$, $A_{\text{OUT}} = -12\text{dBFS}$		-58		dBc
		$f_{\text{out}} = 3500\text{MHz}$, $A_{\text{OUT}} = -12\text{dBFS}$		-69		dBc
$f_{\text{out}} = 4900\text{MHz}$, $A_{\text{OUT}} = -12\text{dBFS}$		-59		dBc		
HD3	3 rd Harmonic Distortion (within Nyquist zone)	$f_{\text{DAC}} = 6\text{GSPS}$, $f_{\text{out}} = 5\text{MHz}$		-46		dBc
		$f_{\text{DAC}} = 6\text{GSPS}$, $f_{\text{out}} = 30\text{MHz}$		-48		dBc
		$f_{\text{DAC}} = 6\text{GSPS}$, $f_{\text{out}} = 100\text{MHz}$		-49		dBc
		$f_{\text{DAC}} = 6\text{GSPS}$, $f_{\text{out}} = 400\text{MHz}$		-49		dBc
		$f_{\text{out}} = 850\text{MHz}$		-56		dBc
		$f_{\text{out}} = 1800\text{MHz}$		-58		dBc
		$f_{\text{out}} = 2600\text{MHz}$		-60		dBc
		$f_{\text{out}} = 3500\text{MHz}$		-63		dBc
		$f_{\text{out}} = 4900\text{MHz}$		-66		dBc
		$f_{\text{DAC}} = 6\text{GSPS}$, $f_{\text{out}} = 5\text{MHz}$, $A_{\text{OUT}} = -12\text{dBFS}$		-83		dBc
		$f_{\text{DAC}} = 6\text{GSPS}$, $f_{\text{out}} = 30\text{MHz}$, $A_{\text{OUT}} = -12\text{dBFS}$		-83		dBc
		$f_{\text{DAC}} = 6\text{GSPS}$, $f_{\text{out}} = 100\text{MHz}$, $A_{\text{OUT}} = -12\text{dBFS}$		-82		dBc
		$f_{\text{DAC}} = 6\text{GSPS}$, $f_{\text{out}} = 400\text{MHz}$, $A_{\text{OUT}} = -12\text{dBFS}$		-79		dBc
		$f_{\text{out}} = 850\text{MHz}$, $A_{\text{OUT}} = -12\text{dBFS}$		-87		dBc
		$f_{\text{out}} = 1800\text{MHz}$, $A_{\text{OUT}} = -12\text{dBFS}$		-84		dBc
		$f_{\text{out}} = 2600\text{MHz}$, $A_{\text{OUT}} = -12\text{dBFS}$		-79		dBc
		$f_{\text{out}} = 3500\text{MHz}$, $A_{\text{OUT}} = -12\text{dBFS}$		-84		dBc
		$f_{\text{out}} = 4900\text{MHz}$, $A_{\text{OUT}} = -12\text{dBFS}$		-88		dBc

5.5 Transmitter Electrical Characteristics (continued)

Typical values at $T_A = +25^\circ\text{C}$, full temperature range is $T_{A,\text{MIN}} = -40^\circ\text{C}$ to $T_{J,\text{MAX}} = +110^\circ\text{C}$; TX Input Rate = 491.52MSPS below 6GHz and 750MSPS above 6GHz, $f_{\text{DAC}} = 11796.48\text{MSPS}$ below 6GHz and $f_{\text{DAC}} = 9000\text{MSPS}$ above 6GHz; PLL clock mode below 6GHz output frequency and External clock mode above 6GHz output frequency; interleave mode for 1st Nyquist, non-interleave mix mode for 2nd Nyquist, nominal power supplies; 1 tone at -1 dBFS; DSA Attenuation = 0dB, unless otherwise noted.

PARAMETER		TEST CONDITIONS	MIN	TYP	MAX	UNIT
HD _n , n >= 4	Harmonic Distortion n >= 4 (within Nyquist zone)	$f_{\text{DAC}} = 6 \text{ GSPS}, f_{\text{out}} = 5 \text{ MHz}$		-58		dBc
		$f_{\text{DAC}} = 6 \text{ GSPS}, f_{\text{out}} = 30 \text{ MHz}$		-60		dBc
		$f_{\text{DAC}} = 6 \text{ GSPS}, f_{\text{out}} = 100 \text{ MHz}$		-61		dBc
		$f_{\text{DAC}} = 6 \text{ GSPS}, f_{\text{out}} = 400 \text{ MHz}$		-50		dBc
		$f_{\text{out}} = 850 \text{ MHz}$		-85		dBc
		$f_{\text{out}} = 1800 \text{ MHz}$		-90		dBc
		$f_{\text{out}} = 2600 \text{ MHz}$		-84		dBc
		$f_{\text{out}} = 3500 \text{ MHz}$		-86		dBc
		$f_{\text{out}} = 4900 \text{ MHz}$		-87		dBc
		$f_{\text{DAC}} = 6 \text{ GSPS}, f_{\text{out}} = 5 \text{ MHz}, A_{\text{OUT}} = -12\text{dBFS}$		-92		dBc
		$f_{\text{DAC}} = 6 \text{ GSPS}, f_{\text{out}} = 30 \text{ MHz}, A_{\text{OUT}} = -12\text{dBFS}$		-94		dBc
		$f_{\text{DAC}} = 6 \text{ GSPS}, f_{\text{out}} = 100 \text{ MHz}, A_{\text{OUT}} = -12\text{dBFS}$		-93		dBc
		$f_{\text{DAC}} = 6 \text{ GSPS}, f_{\text{out}} = 400 \text{ MHz}, A_{\text{OUT}} = -12\text{dBFS}$		-85		dBc
		$f_{\text{out}} = 850 \text{ MHz}, A_{\text{OUT}} = -12\text{dBFS}$		-89		dBc
		$f_{\text{out}} = 1800 \text{ MHz}, A_{\text{OUT}} = -12\text{dBFS}$		-92		dBc
		$f_{\text{out}} = 2600 \text{ MHz}, A_{\text{OUT}} = -12\text{dBFS}$		-87		dBc
		$f_{\text{out}} = 3500 \text{ MHz}, A_{\text{OUT}} = -12\text{dBFS}$		-88		dBc
$f_{\text{out}} = 4900 \text{ MHz}, A_{\text{OUT}} = -12\text{dBFS}$		-89		dBc		
SFDR +/- 250 MHz	Spurious Free Dynamic Range within +/- 250 MHz	$f_{\text{DAC}} = 6 \text{ GSPS}, f_{\text{out}} = 400 \text{ MHz}$		87		dBc
		$f_{\text{out}} = 850 \text{ MHz}, f_{\text{DAC}} = 11796.48 \text{ MSPS}$		84		dBc
		$f_{\text{out}} = 1800 \text{ MHz}, f_{\text{DAC}} = 11796.48 \text{ MSPS}$		78		dBc
		$f_{\text{out}} = 2600 \text{ MHz}, f_{\text{DAC}} = 11796.48 \text{ MSPS}$		80		dBc
		$f_{\text{out}} = 3500 \text{ MHz}, f_{\text{DAC}} = 11796.48 \text{ MSPS}$		81		dBc
		$f_{\text{out}} = 4900 \text{ MHz}, f_{\text{DAC}} = 11796.48 \text{ MSPS}$		74		dBc
$f_s/4$	Fixed Spur	$f_{\text{DAC}} = 5898.24\text{MSPS}, f_{\text{OUT}} = f_{\text{DAC}}/4\text{-}50\text{MHz}$		-95		dBFS
		$f_{\text{DAC}} = 8847.36\text{MSPS}, f_{\text{OUT}} = f_{\text{DAC}}/4\text{-}50\text{MHz}$		-88		dBFS
		$f_{\text{DAC}} = 11796.48\text{MSPS}, f_{\text{OUT}} = f_{\text{DAC}}/4\text{-}50\text{MHz}$		-76		dBFS
$f_s/2$	Fixed Spur	$f_{\text{DAC}} = 5898.24\text{MSPS}, f_{\text{OUT}} = f_{\text{DAC}}/2\text{-}50\text{MHz}$		-52		dBFS
		$f_{\text{DAC}} = 8847.36\text{MSPS}, f_{\text{OUT}} = f_{\text{DAC}}/2\text{-}50\text{MHz}$		-45		dBFS
		$f_{\text{DAC}} = 11796.48 \text{ MSPS}, f_{\text{OUT}} = f_{\text{DAC}}/2\text{-}50\text{MHz}$		-49		dBFS

5.5 Transmitter Electrical Characteristics (continued)

Typical values at $T_A = +25^\circ\text{C}$, full temperature range is $T_{A,\text{MIN}} = -40^\circ\text{C}$ to $T_{J,\text{MAX}} = +110^\circ\text{C}$; TX Input Rate = 491.52MSPS below 6GHz and 750MSPS above 6GHz, $f_{\text{DAC}} = 11796.48\text{MSPS}$ below 6GHz and $f_{\text{DAC}} = 9000\text{MSPS}$ above 6GHz; PLL clock mode below 6GHz output frequency and External clock mode above 6GHz output frequency; interleave mode for 1st Nyquist, non-interleave mix mode for 2nd Nyquist, nominal power supplies; 1 tone at -1 dBFS; DSA Attenuation = 0dB, unless otherwise noted.

PARAMETER		TEST CONDITIONS	MIN	TYP	MAX	UNIT
$3*f_s/4$	Fixed Spur	2nd Nyquist, $f_{\text{DAC}} = 5898.24\text{MSPS}$, $f_{\text{OUT}}=3*f_{\text{DAC}}/4-50\text{MHz}$		-82		dBFS
		2nd Nyquist, $f_{\text{DAC}} = 8847.36\text{MSPS}$, $f_{\text{OUT}}=3*f_{\text{DAC}}/4-50\text{MHz}$		-75		dBFS
		2nd Nyquist, $f_{\text{DAC}} = 11796.48\text{MSPS}$, $f_{\text{OUT}}=3*f_{\text{DAC}}/4-50\text{MHz}$		-49		dBFS
ACPR _{1xcarr}	ACPR - 1 carrier, LTE 20MHz E-TM1.1 carrier $f_{\text{out}} = 0.85\text{ GHz}$	Atten=0dB, $f_{\text{DAC}} = 11796.48\text{MSPS}$, Pout=-13dBFS		-70		dBc
		Atten=20dB, $f_{\text{DAC}} = 11796.48\text{MSPS}$, Pout=-13dBFS		-66		dBc
		Atten=28dB, $f_{\text{DAC}} = 11796.48\text{MSPS}$, Pout=-13dBFS		-62		dBc
		Atten=39dB, $f_{\text{DAC}} = 11796.48\text{MSPS}$, Pout=-13dBFS		-51		dBc
ACPR _{1xcarr}	ACPR - 1 carrier, LTE 20MHz E-TM1.1 carrier $f_{\text{out}} = 1.8425\text{ GHz}$	Atten=0dB, $f_{\text{DAC}} = 11796.48\text{MSPS}$, Pout=-13dBFS		-71		dBc
		Atten=20dB, $f_{\text{DAC}} = 11796.48\text{MSPS}$, Pout=-13dBFS		-66		dBc
		Atten=28dB, $f_{\text{DAC}} = 11796.48\text{MSPS}$, Pout=-13dBFS		-61		dBc
		Atten=39dB, $f_{\text{DAC}} = 11796.48\text{MSPS}$, Pout=-13dBFS		-50		dBc
ACPR _{1xcarr}	ACPR - 1 carrier, LTE 20MHz E-TM1.1 carrier $f_{\text{out}} = 2.6\text{ GHz}$	Atten=0dB, $f_{\text{DAC}} = 11796.48\text{MSPS}$, Pout=-13dBFS		-72		dBc
		Atten=20dB, $f_{\text{DAC}} = 11796.48\text{MSPS}$, Pout=-13dBFS		-66		dBc
		Atten=28dB, $f_{\text{DAC}} = 11796.48\text{MSPS}$, Pout=-13dBFS		-60		dBc
		Atten=39dB, $f_{\text{DAC}} = 11796.48\text{MSPS}$, Pout=-13dBFS		-49		dBc
ACPR _{1xcarr}	ACPR - 1 carrier, LTE 20MHz E-TM1.1 carrier $f_{\text{out}} = 3.5\text{ GHz}$	Atten=0dB, $f_{\text{DAC}} = 11796.48\text{MSPS}$, Pout=-13dBFS		-71		dBc
		Atten=20dB, $f_{\text{DAC}} = 11796.48\text{MSPS}$, Pout=-13dBFS		-65		dBc
		Atten=28dB, $f_{\text{DAC}} = 11796.48\text{MSPS}$, Pout=-13dBFS		-58		dBc
		Atten=39dB, $f_{\text{DAC}} = 11796.48\text{MSPS}$, Pout=-13dBFS		-47		dBc
ACPR _{1xcarr}	ACPR - 1 carrier, LTE 20MHz E-TM1.1 carrier $f_{\text{out}} = 4.9\text{ GHz}$	Atten=0dB, $f_{\text{DAC}} = 11796.48\text{MSPS}$, Pout=-13dBFS		-69		dBc
		Atten=20dB, $f_{\text{DAC}} = 11796.48\text{MSPS}$, Pout=-13dBFS		-64		dBc
		Atten=28dB, $f_{\text{DAC}} = 11796.48\text{MSPS}$, Pout=-13dBFS		-58		dBc
		Atten=39dB, $f_{\text{DAC}} = 11796.48\text{MSPS}$, Pout=-13dBFS		-47		dBc

5.5 Transmitter Electrical Characteristics (continued)

Typical values at $T_A = +25^\circ\text{C}$, full temperature range is $T_{A,\text{MIN}} = -40^\circ\text{C}$ to $T_{J,\text{MAX}} = +110^\circ\text{C}$; TX Input Rate = 491.52MSPS below 6GHz and 750MSPS above 6GHz, $f_{\text{DAC}} = 11796.48\text{MSPS}$ below 6GHz and $f_{\text{DAC}} = 9000\text{MSPS}$ above 6GHz; PLL clock mode below 6GHz output frequency and External clock mode above 6GHz output frequency; interleave mode for 1st Nyquist, non-interleave mix mode for 2nd Nyquist, nominal power supplies; 1 tone at -1 dBFS; DSA Attenuation = 0dB, unless otherwise noted.

PARAMETER		TEST CONDITIONS	MIN	TYP	MAX	UNIT
ACPR _{1xcarr}	ACPR - 1 carrier, NR 100MHz E-TM1.1 carrier $f_{\text{out}} = 2.6$ GHz	Atten=0dB, $f_{\text{DAC}} = 11796.48\text{MSPS}$, Pout=-13dBFS		-65		dBc
		Atten=20dB, $f_{\text{DAC}} = 11796.48\text{MSPS}$, Pout=-13dBFS		-59		dBc
		Atten=28dB, $f_{\text{DAC}} = 11796.48\text{MSPS}$, Pout=-13dBFS		-53		dBc
		Atten=39dB, $f_{\text{DAC}} = 11796.48\text{MSPS}$, Pout=-13dBFS		-41		dBc
ACPR _{1xcarr}	ACPR - 1 carrier, NR 100MHz E-TM1.1 carrier $f_{\text{out}} = 3.5$ GHz	Atten=0dB, $f_{\text{DAC}} = 11796.48\text{MSPS}$, Pout=-13dBFS		-63		dBc
		Atten=20dB, $f_{\text{DAC}} = 11796.48\text{MSPS}$, Pout=-13dBFS		-56		dBc
		Atten=28dB, $f_{\text{DAC}} = 11796.48\text{MSPS}$, Pout=-13dBFS		-49		dBc
		Atten=39dB, $f_{\text{DAC}} = 11796.48\text{MSPS}$, Pout=-13dBFS		-38		dBc
ACPR _{1xcarr}	ACPR - 1 carrier, NR 100MHz E-TM1.1 carrier $f_{\text{out}} = 4.9$ GHz	Atten=0dB, $f_{\text{DAC}} = 11796.48\text{MSPS}$, Pout=-13dBFS		-63		dBc
		Atten=20dB, $f_{\text{DAC}} = 11796.48\text{MSPS}$, Pout=-13dBFS		-56		dBc
		Atten=28dB, $f_{\text{DAC}} = 11796.48\text{MSPS}$, Pout=-13dBFS		-51		dBc
		Atten=39dB, $f_{\text{DAC}} = 11796.48\text{MSPS}$, Pout=-13dBFS		-41		dBc
EVM	Error Vector Magnitude, 1x 20MHz E-TM3.1/3.1a, no ref. clock noise	$F_{\text{out}} = 0.85$ GHz, $f_{\text{DAC}} = 11796.48\text{MSPS}$, $P_{\text{OUT}} = -13\text{dBFS}$		0.16		%
		$F_{\text{out}} = 1.8425$ GHz, $f_{\text{DAC}} = 11796.48\text{MSPS}$, $P_{\text{OUT}} = -13\text{dBFS}$		0.21		%
		$F_{\text{out}} = 2.6$ GHz, $f_{\text{DAC}} = 11796.48\text{MSPS}$, $P_{\text{OUT}} = -13\text{dBFS}$		0.24		%
		$F_{\text{out}} = 3.5$ GHz, $P_{\text{OUT}} = -13\text{dBFS}$		0.27		%
		$F_{\text{out}} = 4.9$ GHz, $P_{\text{OUT}} = -13\text{dBFS}$		0.38		%
NSD _{dBFS}	Noise Spectral Density 20MHz offset $f_{\text{OUT}} = 5$ MHz	Atten=0dB, $f_{\text{DAC}} = 6000\text{MSPS}$, 20Gbps SerDes rate, Pout=-12dBFS		-148		dBFS/Hz
		Atten=20dB, $f_{\text{DAC}} = 6000\text{MSPS}$, 20Gbps SerDes rate, Pout=-12dBFS		-143		dBFS/Hz
		Atten=28dB, $f_{\text{DAC}} = 6000\text{MSPS}$, 20Gbps SerDes rate, Pout=-12dBFS		-139		dBFS/Hz
		Atten=39dB, $f_{\text{DAC}} = 6000\text{MSPS}$, 20Gbps SerDes rate, Pout=-12dBFS		-129		dBFS/Hz
NSD _{dBFS}	Noise Spectral Density 20MHz offset $f_{\text{OUT}} = 30$ MHz	Atten=0dB, $f_{\text{DAC}} = 6000\text{MSPS}$, 20Gbps SerDes rate, Pout=-12dBFS		-154		dBFS/Hz
		Atten=20dB, $f_{\text{DAC}} = 6000\text{MSPS}$, 20Gbps SerDes rate, Pout=-12dBFS		-146		dBFS/Hz
		Atten=28dB, $f_{\text{DAC}} = 6000\text{MSPS}$, 20Gbps SerDes rate, Pout=-12dBFS		-142		dBFS/Hz
		Atten=39dB, $f_{\text{DAC}} = 6000\text{MSPS}$, 20Gbps SerDes rate, Pout=-12dBFS		-132		dBFS/Hz

5.5 Transmitter Electrical Characteristics (continued)

Typical values at $T_A = +25^\circ\text{C}$, full temperature range is $T_{A,\text{MIN}} = -40^\circ\text{C}$ to $T_{J,\text{MAX}} = +110^\circ\text{C}$; TX Input Rate = 491.52MSPS below 6GHz and 750MSPS above 6GHz, $f_{\text{DAC}} = 11796.48\text{MSPS}$ below 6GHz and $f_{\text{DAC}} = 9000\text{MSPS}$ above 6GHz; PLL clock mode below 6GHz output frequency and External clock mode above 6GHz output frequency; interleave mode for 1st Nyquist, non-interleave mix mode for 2nd Nyquist, nominal power supplies; 1 tone at -1 dBFS; DSA Attenuation = 0dB, unless otherwise noted.

PARAMETER		TEST CONDITIONS	MIN	TYP	MAX	UNIT
NSD _{dBFS}	Noise Spectral Density 20MHz offset $f_{\text{OUT}} = 100\text{ MHz}$	Atten=0dB, $f_{\text{DAC}} = 6000\text{MSPS}$, 20Gbps SerDes rate, Pout=-12dBFS		-158		dBFS/ Hz
		Atten=20dB, $f_{\text{DAC}} = 6000\text{MSPS}$, 20Gbps SerDes rate, Pout=-12dBFS		-150		dBFS/ Hz
		Atten=28dB, $f_{\text{DAC}} = 6000\text{MSPS}$, 20Gbps SerDes rate, Pout=-12dBFS		-146		dBFS/ Hz
		Atten=39dB, $f_{\text{DAC}} = 6000\text{MSPS}$, 20Gbps SerDes rate, Pout=-12dBFS		-136		dBFS/ Hz
NSD _{dBFS}	Noise Spectral Density 20MHz offset $f_{\text{OUT}} = 400\text{ MHz}$	Atten=0dB, $f_{\text{DAC}} = 6000\text{MSPS}$, 20Gbps SerDes rate, Pout=-12dBFS		-160		dBFS/ Hz
		Atten=20dB, $f_{\text{DAC}} = 6000\text{MSPS}$, 20Gbps SerDes rate, Pout=-12dBFS		-153		dBFS/ Hz
		Atten=28dB, $f_{\text{DAC}} = 6000\text{MSPS}$, 20Gbps SerDes rate, Pout=-12dBFS		-150		dBFS/ Hz
		Atten=39dB, $f_{\text{DAC}} = 6000\text{MSPS}$, 20Gbps SerDes rate, Pout=-12dBFS		-139		dBFS/ Hz
NSD _{dBFS}	Noise Spectral Density 20MHz offset $f_{\text{OUT}} = 0.85\text{ GHz}$	Atten=0dB, $f_{\text{DAC}} = 5898.24\text{MSPS}$, Pout=-13dBFS		-158.8		dBFS/ Hz
		Atten=20dB, $f_{\text{DAC}} = 5898.24\text{MSPS}$, Pout=-13dBFS		-152.7		dBFS/ Hz
		Atten=28dB, $f_{\text{DAC}} = 5898.24\text{MSPS}$, Pout=-13dBFS		-148.7		dBFS/ Hz
		Atten=39dB, $f_{\text{DAC}} = 5898.24\text{MSPS}$, Pout=-13dBFS		-137.9		dBFS/ Hz
NSD _{dBFS}	Noise Spectral Density 20MHz offset $f_{\text{OUT}} = 1.8\text{ GHz}$	Atten=0dB, $f_{\text{DAC}} = 5898.24\text{MSPS}$, Pout=-13dBFS		-157.9		dBFS/ Hz
		Atten=20dB, $f_{\text{DAC}} = 5898.24\text{MSPS}$, Pout=-13dBFS		-151.3		dBFS/ Hz
		Atten=28dB, $f_{\text{DAC}} = 5898.24\text{MSPS}$, Pout=-13dBFS		-145.6		dBFS/ Hz
		Atten=39dB, $f_{\text{DAC}} = 5898.24\text{MSPS}$, Pout=-13dBFS		-134.8		dBFS/ Hz
NSD _{dBFS}	Noise Spectral Density 20MHz offset $f_{\text{OUT}} = 2.6\text{ GHz}$	Atten=0dB, $f_{\text{DAC}} = 8847.36\text{MSPS}$, Pout=-13dBFS		-158.3		dBFS/ Hz
		Atten=20dB, $f_{\text{DAC}} = 8847.36\text{MSPS}$, Pout=-13dBFS		-151.6		dBFS/ Hz
		Atten=28dB, $f_{\text{DAC}} = 8847.36\text{MSPS}$, Pout=-13dBFS		-144.9		dBFS/ Hz
		Atten=39dB, $f_{\text{DAC}} = 8847.36\text{MSPS}$, Pout=-13dBFS		-134.0		dBFS/ Hz
NSD _{dBFS}	Noise Spectral Density 20MHz offset $F_{\text{out}} = 3.5\text{ GHz}$	Atten=0dB, $f_{\text{DAC}} = 11796.48\text{MSPS}$, Pout=-13dBFS		-158.2		dBFS/ Hz
		Atten=20dB, $f_{\text{DAC}} = 11796.48\text{MSPS}$, Pout=-13dBFS		-150.9		dBFS/ Hz
		Atten=28dB, $f_{\text{DAC}} = 11796.48\text{MSPS}$, Pout=-13dBFS		-144.4		dBFS/ Hz
		Atten=39dB, $f_{\text{DAC}} = 11796.48\text{MSPS}$, Pout=-13dBFS		-133.4		dBFS/ Hz

5.5 Transmitter Electrical Characteristics (continued)

Typical values at $T_A = +25^\circ\text{C}$, full temperature range is $T_{A,\text{MIN}} = -40^\circ\text{C}$ to $T_{J,\text{MAX}} = +110^\circ\text{C}$; TX Input Rate = 491.52MSPS below 6GHz and 750MSPS above 6GHz, $f_{\text{DAC}} = 11796.48\text{MSPS}$ below 6GHz and $f_{\text{DAC}} = 9000\text{MSPS}$ above 6GHz; PLL clock mode below 6GHz output frequency and External clock mode above 6GHz output frequency; interleave mode for 1st Nyquist, non-interleave mix mode for 2nd Nyquist, nominal power supplies; 1 tone at -1 dBFS; DSA Attenuation = 0dB, unless otherwise noted.

PARAMETER		TEST CONDITIONS	MIN	TYP	MAX	UNIT
NSD _{dBFS}	Noise Spectral Density 20MHz offset $F_{\text{out}} = 4.9\text{ GHz}$	Atten=0dB, $f_{\text{DAC}} = 11796.48\text{MSPS}$, Pout=-13dBFS		-154.6		dBFS/ Hz
		Atten=20dB, $f_{\text{DAC}} = 11796.48\text{MSPS}$, Pout=-13dBFS		-147.0		dBFS/ Hz
		Atten=28dB, $f_{\text{DAC}} = 11796.48\text{MSPS}$, Pout=-13dBFS		-140.7		dBFS/ Hz
		Atten=39dB, $f_{\text{DAC}} = 11796.48\text{MSPS}$, Pout=-13dBFS		-129.9		dBFS/ Hz
S22	Output Return Loss, +/- fc * 10%	with matching		-12		dB
Isolation	Near Channel: 1TXOUT to 2TXOUT or 3TXOUT to 4TXOUT ⁽¹⁾	$f_{\text{out}} = 10\text{ MHz}$, $f_{\text{DAC}} = 6000\text{MSPS}$, straight mode ⁽³⁾		-96		dB
		$f_{\text{out}} = 30\text{ MHz}$, $f_{\text{DAC}} = 6000\text{MSPS}$, straight mode ⁽³⁾		-97		dB
		$f_{\text{out}} = 100\text{ MHz}$, $f_{\text{DAC}} = 6000\text{MSPS}$, straight mode ⁽³⁾		-102		dB
		$f_{\text{out}} = 400\text{ MHz}$, $f_{\text{DAC}} = 6000\text{MSPS}$, straight mode ⁽⁴⁾		-85		dB
		$f_{\text{out}} = 900\text{ MHz}$, $f_{\text{DAC}} = 8847.36\text{MSPS}$, straight mode		-80		dB
		$f_{\text{out}} = 1850\text{ MHz}$, $f_{\text{DAC}} =$ 8847.36MSPS, straight mode		-77		dB
		$f_{\text{out}} = 2600\text{ MHz}$, $f_{\text{DAC}} =$ 8847.36MSPS, straight mode		-64		dB
		$f_{\text{out}} = 3500\text{ MHz}$, $f_{\text{DAC}} =$ 8847.36MSPS, straight mode		-61		dB
		$f_{\text{out}} = 4900\text{ MHz}$, $f_{\text{DAC}} =$ 8847.36MSPS, straight mode		-60		dB
Isolation	Far Channel: 1/2TXOUT to 3/4TXOUT	$f_{\text{out}} = 10\text{ MHz}$, $f_{\text{DAC}} = 6000\text{MSPS}$, straight mode ⁽³⁾		-104		dB
		$f_{\text{out}} = 30\text{ MHz}$, $f_{\text{DAC}} = 6000\text{MSPS}$, straight mode ⁽³⁾		-100		dB
		$f_{\text{out}} = 100\text{ MHz}$, $f_{\text{DAC}} = 6000\text{MSPS}$, straight mode ⁽³⁾		-105		dB
		$f_{\text{out}} = 400\text{ MHz}$, $f_{\text{DAC}} = 6000\text{MSPS}$, straight mode ⁽⁴⁾		-97		dB
		$f_{\text{out}} = 900\text{ MHz}$, $f_{\text{DAC}} = 8847.36\text{MSPS}$, straight mode		-90		dB
		$f_{\text{out}} = 1850\text{ MHz}$, $f_{\text{DAC}} =$ 8847.36MSPS, straight mode		-91		dB
		$f_{\text{out}} = 2600\text{ MHz}$, $f_{\text{DAC}} =$ 8847.36MSPS, straight mode		-93		dB
		$f_{\text{out}} = 3500\text{ MHz}$, $f_{\text{DAC}} =$ 8847.36MSPS, straight mode		-94		dB
		$f_{\text{out}} = 4900\text{ MHz}$, $f_{\text{DAC}} =$ 8847.36MSPS, straight mode		-83.2		dB

5.5 Transmitter Electrical Characteristics (continued)

Typical values at $T_A = +25^\circ\text{C}$, full temperature range is $T_{A,\text{MIN}} = -40^\circ\text{C}$ to $T_{J,\text{MAX}} = +110^\circ\text{C}$; TX Input Rate = 491.52MSPS below 6GHz and 750MSPS above 6GHz, $f_{\text{DAC}} = 11796.48\text{MSPS}$ below 6GHz and $f_{\text{DAC}} = 9000\text{MSPS}$ above 6GHz; PLL clock mode below 6GHz output frequency and External clock mode above 6GHz output frequency; interleave mode for 1st Nyquist, non-interleave mix mode for 2nd Nyquist, nominal power supplies; 1 tone at -1 dBFS; DSA Attenuation = 0dB, unless otherwise noted.

PARAMETER		TEST CONDITIONS	MIN	TYP	MAX	UNIT
PN _{TXADD}	Additive Phase Noise External Clock Mode ⁽⁵⁾	$f_{\text{out}} = 3.7\text{GHz}$, $f_{\text{OFFSET}} = 100\text{Hz}$		-97		dBc/Hz
		$f_{\text{out}} = 3.7\text{GHz}$, $f_{\text{OFFSET}} = 1\text{kHz}$		-106		dBc/Hz
		$f_{\text{out}} = 3.7\text{GHz}$, $f_{\text{OFFSET}} = 10\text{kHz}$		-117		dBc/Hz
		$f_{\text{out}} = 3.7\text{GHz}$, $f_{\text{OFFSET}} = 100\text{kHz}$		-128		dBc/Hz
		$f_{\text{out}} = 3.7\text{GHz}$, $f_{\text{OFFSET}} = 1\text{MHz}$		-138		dBc/Hz
		$f_{\text{out}} = 3.7\text{GHz}$, $f_{\text{OFFSET}} = 10\text{MHz}$		-144		dBc/Hz

- (1) Measured with differential 100 ohm across TxP/M. The DC bias to 1.8V to each TxP/M at each pin remains and is not removed. Other external components on the TX paths are disconnected.
- (2) After DSA calibration procedure
- (3) measured with 1 μH DC feed inductor
- (4) measured with 0.39 μH DC feed inductor
- (5) Input clock phase noise subtracted.

5.6 RF ADC Electrical Characteristics

Typical values at $T_A = +25^\circ\text{C}$, full temperature range is $T_{A,\text{MIN}} = -40^\circ\text{C}$ to $T_{J,\text{MAX}} = +110^\circ\text{C}$; RX Output Rate = 491.52MSPS below 6GHz input frequency and 1500MSPS above 6GHz input frequency, $f_{\text{ADC}} = 2949.12\text{MSPS}$ below 6GHz and $f_{\text{ADC}} = 3000\text{MSPS}$ above 6GHz; PLL clock mode with $f_{\text{REF}} = 491.52\text{MHz}$ below 6GHz input frequency and External clock mode with $f_{\text{CLK}} = 11796.48\text{MHz}$ above 6GHz input frequency; nominal power supplies; DSA Setting =3dB; SerDes rate =24.33Gbps; unless otherwise noted.

PARAMETER		TEST CONDITIONS	MIN	TYP	MAX	UNIT
ADC _{RES}	ADC resolution			14		bits
F _{RFIn}	RF input frequency range		5		7400	MHz
P _{FS_CW,min}	Min Full scale input power, at device pins (1)	$f_{\text{IN}} = 5 \text{ MHz}$, DSA=0dB, $f_{\text{ADC}} = 1500\text{MSPS}$, $f_{\text{NCO}} = 17\text{MHz}$, Decimate by 48		-0.4		dBm
		$f_{\text{IN}} = 30 \text{ MHz}$, DSA=0dB, $f_{\text{ADC}} = 1500\text{MSPS}$, $f_{\text{NCO}} = 30\text{MHz}$, Decimate by 24		-2.2		dBm
		$f_{\text{IN}} = 410 \text{ MHz}$, DSA=0dB, $f_{\text{ADC}} = 3000\text{MSPS}$, $f_{\text{NCO}} = 400\text{MHz}$, Decimate by 12		-2.5		dBm
		$f_{\text{IN}} = 830 \text{ MHz}$, DSA=0dB		-2.9		dBm
		$f_{\text{IN}} = 1760 \text{ MHz}$, DSA=0dB		-2.8		dBm
		$f_{\text{IN}} = 2610 \text{ MHz}$, DSA=0dB		-1.8		dBm
		$f_{\text{IN}} = 3610 \text{ MHz}$, DSA=0dB		-0.4		dBm
		$f_{\text{IN}} = 4910 \text{ MHz}$, DSA=0dB		0.1		dBm
P _{FS_CW,MAX}	MAX Full scale input power - reliability limited, at device pins	$f_{\text{IN}} = 5 \text{ MHz}$, $f_{\text{ADC}} = 1500\text{MSPS}$, $f_{\text{NCO}} = 17\text{MHz}$, Decimate by 48		19.7		dBm
		$f_{\text{IN}} = 30 \text{ MHz}$, $f_{\text{ADC}} = 1500\text{MSPS}$, $f_{\text{NCO}} = 30\text{MHz}$, Decimate by 24		17.8		dBm
		$f_{\text{IN}} = 410 \text{ MHz}$, $f_{\text{ADC}} = 3000\text{MSPS}$, $f_{\text{NCO}} = 400\text{MHz}$, Decimate by 24		17.6		dBm
		$f_{\text{IN}} = 830 \text{ MHz}$		16.7		dBm
		$f_{\text{IN}} = 1760 \text{ MHz}$		17.0		dBm
		$f_{\text{IN}} = 2610 \text{ MHz}$		18		dBm
		$f_{\text{IN}} = 3610 \text{ MHz}$		18.5		dBm
		$f_{\text{IN}} = 4910 \text{ MHz}$		19.3		dBm
R _{TERM}	Input reference impedance			100.0		Ω
ATT _{range}	DSA Attenuation range			25.0		dB
ATT _{step}	DSA Attenuation step			0.5		dB
	DSA Attenuation step accuracy	$\Delta = \text{Gatt}(X) - \text{Gatt}(X-1)$, $F_{\text{in}} = 3610\text{MHz}$, after calibration		0.1		dB
	DSA Gain Steps Phase accuracy any 8dB range	$F_{\text{in}} = 3610\text{MHz}$, after calibration		0.9		deg
	DSA Gain Steps Phase accuracy any 8dB range	$F_{\text{in}} = 4910\text{MHz}$, after calibration		1.8		deg
G _{flat}	Gain flatness	Measured Over 80MHz BW		0.2		dB
		Measured Over 200MHz BW		0.5		dB
		Measured Over 400MHz BW		1.1		dB

5.6 RF ADC Electrical Characteristics (continued)

Typical values at $T_A = +25^\circ\text{C}$, full temperature range is $T_{A,\text{MIN}} = -40^\circ\text{C}$ to $T_{J,\text{MAX}} = +110^\circ\text{C}$; RX Output Rate = 491.52MSPS below 6GHz input frequency and 1500MSPS above 6GHz input frequency, $f_{\text{ADC}} = 2949.12\text{MSPS}$ below 6GHz and $f_{\text{ADC}} = 3000\text{MSPS}$ above 6GHz; PLL clock mode with $f_{\text{REF}} = 491.52\text{MHz}$ below 6GHz input frequency and External clock mode with $f_{\text{CLK}} = 11796.48\text{MHz}$ above 6GHz input frequency; nominal power supplies; DSA Setting =3dB; SerDes rate =24.33Gbps; unless otherwise noted.

PARAMETER		TEST CONDITIONS	MIN	TYP	MAX	UNIT
NSD	Noise Density ⁽³⁾ (small signal = -30dBFS)	$f_{\text{IN}} = 5\text{ MHz}$, DSA = 3dB, $f_{\text{ADC}} = 1500\text{MSPS}$, $f_{\text{NCO}} = 17\text{MHz}$, Decimate by 48		-147.1		dBFS/Hz
		$f_{\text{IN}} = 30\text{ MHz}$, DSA = 3dB, $f_{\text{ADC}} = 1500\text{MSPS}$, $f_{\text{NCO}} = 30\text{MHz}$, Decimate by 24		-150.7		dBFS/Hz
		$f_{\text{IN}} = 410\text{ MHz}$, DSA = 3dB, $f_{\text{ADC}} = 3000\text{MSPS}$, $f_{\text{NCO}} = 400\text{MHz}$, Decimate by 24		-155.4		dBFS/Hz
		$f_{\text{IN}} = 830\text{ MHz}$, DSA = 3dB		-156.2		dBFS/Hz
		$f_{\text{IN}} = 1760\text{ MHz}$, DSA = 3dB		-156.0		dBFS/Hz
		$f_{\text{IN}} = 2610\text{ MHz}$, DSA = 3dB		-155.4		dBFS/Hz
		$f_{\text{IN}} = 3610\text{ MHz}$, DSA = 3dB		-155.1		dBFS/Hz
		$f_{\text{IN}} = 4910\text{ MHz}$, DSA = 3dB		-155.1		dBFS/Hz
		$f_{\text{IN}} = 5\text{ MHz}$, $f_{\text{ADC}} = 1500\text{MSPS}$, $f_{\text{NCO}} = 17\text{MHz}$, Decimate by 48, 3<=Atten<=22		-147.8		dBFS/Hz
		$f_{\text{IN}} = 30\text{ MHz}$, $f_{\text{ADC}} = 1500\text{MSPS}$, $f_{\text{NCO}} = 30\text{MHz}$, Decimate by 24, 3<=Atten<=22		-151.5		dBFS/Hz
		$f_{\text{IN}} = 410\text{ MHz}$, 3<=Atten<=22, $f_{\text{ADC}} = 3000\text{MSPS}$, $f_{\text{NCO}} = 400\text{MHz}$, Decimate by 24		-156.6		dBFS/Hz
		$f_{\text{IN}} = 830\text{ MHz}$, 3<=Atten<=22		-156.0		dBFS/Hz
		$f_{\text{IN}} = 1760\text{ MHz}$, 3<=Atten<=25		-155.8		dBFS/Hz
		$f_{\text{IN}} = 2610\text{ MHz}$, 3<=Atten<=25		-155.7		dBFS/Hz
$f_{\text{IN}} = 3610\text{ MHz}$, 3<=Atten<=25		-155.4		dBFS/Hz		
$f_{\text{IN}} = 4910\text{ MHz}$, 3<=Atten<=25		-155.8		dBFS/Hz		
NF _{min}	Noise Figure min DSA Atten=0 - 3dB	$f_{\text{IN}} = 5\text{ MHz}$, $f_{\text{ADC}} = 1500\text{MSPS}$, $f_{\text{NCO}} = 17\text{MHz}$, Decimate by 48		29.4		dB
		$f_{\text{IN}} = 30\text{ MHz}$, $f_{\text{ADC}} = 1500\text{MSPS}$, $f_{\text{NCO}} = 30\text{MHz}$, Decimate by 24		24.5		dB
		$f_{\text{IN}} = 410\text{ MHz}$, $f_{\text{ADC}} = 3000\text{MSPS}$, $f_{\text{NCO}} = 400\text{MHz}$, Decimate by 24		19.3		dB
		$f_{\text{IN}} = 830\text{ MHz}$		19.1		dB
		$f_{\text{IN}} = 1760\text{ MHz}$		19.0		dB
		$f_{\text{IN}} = 2610\text{ MHz}$		20.9		dB
		$f_{\text{IN}} = 3610\text{ MHz}$		22.8		dB
$f_{\text{IN}} = 4910\text{ MHz}$		22.4		dB		

5.6 RF ADC Electrical Characteristics (continued)

Typical values at $T_A = +25^\circ\text{C}$, full temperature range is $T_{A,\text{MIN}} = -40^\circ\text{C}$ to $T_{J,\text{MAX}} = +110^\circ\text{C}$; RX Output Rate = 491.52MSPS below 6GHz input frequency and 1500MSPS above 6GHz input frequency, $f_{\text{ADC}} = 2949.12\text{MSPS}$ below 6GHz and $f_{\text{ADC}} = 3000\text{MSPS}$ above 6GHz; PLL clock mode with $f_{\text{REF}} = 491.52\text{MHz}$ below 6GHz input frequency and External clock mode with $f_{\text{CLK}} = 11796.48\text{MHz}$ above 6GHz input frequency; nominal power supplies; DSA Setting =3dB; SerDes rate =24.33Gbps; unless otherwise noted.

PARAMETER		TEST CONDITIONS	MIN	TYP	MAX	UNIT
NF	Noise Figure ⁽⁴⁾ DSA Atten=4dB	$f_{\text{IN}} = 5\text{ MHz}$, $f_{\text{ADC}} = 1500\text{MSPS}$, $f_{\text{NCO}} = 17\text{MHz}$, Decimate by 48		30.6		dB
		$f_{\text{IN}} = 30\text{ MHz}$, $f_{\text{ADC}} = 1500\text{MSPS}$, $f_{\text{NCO}} = 30\text{MHz}$, Decimate by 24		25.1		dB
		$f_{\text{IN}} = 410\text{ MHz}$, $f_{\text{ADC}} = 3000\text{MSPS}$, $f_{\text{NCO}} = 400\text{MHz}$, Decimate by 24		20.1		dB
		$f_{\text{IN}} = 830\text{ MHz}$		20.0		dB
		$f_{\text{IN}} = 1760\text{ MHz}$		20.6		dB
		$f_{\text{IN}} = 2610\text{ MHz}$		21.9		dB
		$f_{\text{IN}} = 3610\text{ MHz}$		23.5		dB
		$f_{\text{IN}} = 4910\text{ MHz}$		22.3		dB
NF _{max}	Noise Figure DSA Atten=20dB	$f_{\text{IN}} = 5\text{ MHz}$, $f_{\text{ADC}} = 1500\text{MSPS}$, $f_{\text{NCO}} = 17\text{MHz}$, Decimate by 48		45.9		dB
		$f_{\text{IN}} = 30\text{ MHz}$, $f_{\text{ADC}} = 1500\text{MSPS}$, $f_{\text{NCO}} = 30\text{MHz}$, Decimate by 24		40.2		dB
		$f_{\text{IN}} = 410\text{ MHz}$, $f_{\text{ADC}} = 3000\text{MSPS}$, $f_{\text{NCO}} = 400\text{MHz}$, Decimate by 24		35.0		dB
		$f_{\text{IN}} = 830\text{ MHz}$		34.7		dB
		$f_{\text{IN}} = 1760\text{ MHz}$		35.2		dB
		$f_{\text{IN}} = 2610\text{ MHz}$		36.0		dB
		$f_{\text{IN}} = 3610\text{ MHz}$		37.3		dB
		$f_{\text{IN}} = 4910\text{ MHz}$		37.6		dB
IMD3	3 rd order intermodulation 2 tones at at $f_{\text{IN}} \pm 10\text{MHz}$ -7dBFS each tone	$f_{\text{IN}} = 30 \pm 1\text{ MHz}$, $f_{\text{ADC}} = 1500\text{MSPS}$, $f_{\text{NCO}} = 30\text{MHz}$, Decimate by 24		-82		dBc
		$f_{\text{IN}} = 400\text{MHz}$ and 405MHz , $f_{\text{ADC}} = 3000\text{MSPS}$, $f_{\text{NCO}} = 400\text{MHz}$, Decimate by 24		-75		dBc
		$f_{\text{IN}} = 840\text{ MHz}$		-82		dBc
		$f_{\text{IN}} = 1770\text{ MHz}$		-84		dBc
		$f_{\text{IN}} = 2610\text{ MHz}$		-74		dBc
		$f_{\text{IN}} = 3610\text{ MHz}$		-77		dBc
		$f_{\text{IN}} = 4920\text{ MHz}$		-76		dBc
SFDR	Spurious Free Dynamic Range within output bandwidth, $A_{\text{IN}} = -3\text{ dBFS}$	$f_{\text{IN}} = 5\text{ MHz}$, $f_{\text{ADC}} = 1500\text{MSPS}$, $f_{\text{NCO}} = 17\text{MHz}$, Decimate by 48		78		dBFS
		$f_{\text{IN}} = 30\text{ MHz}$, $f_{\text{ADC}} = 1500\text{MSPS}$, $f_{\text{NCO}} = 30\text{MHz}$, Decimate by 24		100		dBFS
		$f_{\text{IN}} = 410\text{ MHz}$, $f_{\text{ADC}} = 3000\text{MSPS}$, $f_{\text{NCO}} = 400\text{MHz}$, Decimate by 24		94		dBFS
		$f_{\text{IN}} = 830\text{ MHz}$		88		dBFS
		$f_{\text{IN}} = 1760\text{ MHz}$		81		dBFS
		$f_{\text{IN}} = 2610\text{ MHz}$		88		dBFS
		$f_{\text{IN}} = 3610\text{ MHz}$		84		dBFS
		$f_{\text{IN}} = 4910\text{ MHz}$		79		dBFS

5.6 RF ADC Electrical Characteristics (continued)

Typical values at $T_A = +25^\circ\text{C}$, full temperature range is $T_{A,\text{MIN}} = -40^\circ\text{C}$ to $T_{J,\text{MAX}} = +110^\circ\text{C}$; RX Output Rate = 491.52MSPS below 6GHz input frequency and 1500MSPS above 6GHz input frequency, $f_{\text{ADC}} = 2949.12\text{MSPS}$ below 6GHz and $f_{\text{ADC}} = 3000\text{MSPS}$ above 6GHz; PLL clock mode with $f_{\text{REF}} = 491.52\text{MHz}$ below 6GHz input frequency and External clock mode with $f_{\text{CLK}} = 11796.48\text{MHz}$ above 6GHz input frequency; nominal power supplies; DSA Setting =3dB; SerDes rate =24.33Gbps; unless otherwise noted.

PARAMETER		TEST CONDITIONS	MIN	TYP	MAX	UNIT
HD2	2nd Harmonic Distortion $A_{\text{IN}} = -3 \text{ dBFS}^{(2)}$	$f_{\text{IN}} = 5 \text{ MHz}$, $f_{\text{ADC}} = 1500\text{MSPS}$, $f_{\text{NCO}} = 17\text{MHz}$, Decimate by 48		-84		dBFS
		$f_{\text{IN}} = 30 \text{ MHz}$, $f_{\text{ADC}} = 1500\text{MSPS}$, Bypass Mode (TI only test mode)		-91		dBFS
		$f_{\text{IN}} = 410 \text{ MHz}$, $f_{\text{ADC}} = 3000\text{MSPS}$, Bypass Mode (TI only test mode)		-90		dBFS
		$f_{\text{IN}} = 830 \text{ MHz}$		-86		dBFS
		$f_{\text{IN}} = 1760 \text{ MHz}$		-90		dBFS
		$f_{\text{IN}} = 2610 \text{ MHz}$		-88		dBFS
		$f_{\text{IN}} = 3610 \text{ MHz}$		-87		dBFS
		$f_{\text{IN}} = 4910 \text{ MHz}$		-84		dBFS
HD3	3rd Harmonic Distortion $A_{\text{IN}} = -3 \text{ dBFS}$	$f_{\text{IN}} = 5 \text{ MHz}$, $f_{\text{ADC}} = 1500\text{MSPS}$, $f_{\text{NCO}} = 17\text{MHz}$, Decimate by 48		-78		dBFS
		$f_{\text{IN}} = 30 \text{ MHz}$, $f_{\text{ADC}} = 1500\text{MSPS}$, Bypass Mode (TI only test mode)		-96		dBFS
		$f_{\text{IN}} = 410 \text{ MHz}$, $f_{\text{ADC}} = 3000\text{MSPS}$, Bypass Mode (TI only test mode)		-94		dBFS
		$f_{\text{IN}} = 830 \text{ MHz}$		-80		dBFS
		$f_{\text{IN}} = 1760 \text{ MHz}$		-85		dBFS
		$f_{\text{IN}} = 2610 \text{ MHz}$		-86		dBFS
		$f_{\text{IN}} = 3610 \text{ MHz}$		-78		dBFS
		$f_{\text{IN}} = 4910 \text{ MHz}$		-75		dBFS
HDn, n>3	SFDR excl. HD2 and HD3 $A_{\text{IN}} = -3 \text{ dBFS}$	$f_{\text{IN}} = 5 \text{ MHz}$, $f_{\text{ADC}} = 1500\text{MSPS}$, $f_{\text{NCO}} = 17\text{MHz}$, Decimate by 48		-94		dBFS
		$f_{\text{IN}} = 30 \text{ MHz}$, $f_{\text{ADC}} = 1500\text{MSPS}$, $f_{\text{NCO}} = 30\text{MHz}$, Decimate by 24		-94		dBFS
		$f_{\text{IN}} = 410 \text{ MHz}$, $f_{\text{ADC}} = 3000\text{MSPS}$, $f_{\text{NCO}} = 400\text{MHz}$, Decimate by 24		-94		dBFS
		$f_{\text{IN}} = 830 \text{ MHz}$		-88		dBFS
		$f_{\text{IN}} = 1760 \text{ MHz}$		-81		dBFS
		$f_{\text{IN}} = 2610 \text{ MHz}$		-88		dBFS
		$f_{\text{IN}} = 3610 \text{ MHz}$		-84		dBFS
		$f_{\text{IN}} = 4910 \text{ MHz}$		-82		dBFS
SFDR	Spurious Free Dynamic Range $A_{\text{IN}} = -13 \text{ dBFS}$	$f_{\text{IN}} = 5 \text{ MHz}$, $f_{\text{ADC}} = 1500\text{MSPS}$, $f_{\text{NCO}} = 17\text{MHz}$, Decimate by 48		101		dBFS
		$f_{\text{IN}} = 30 \text{ MHz}$, $f_{\text{ADC}} = 1500\text{MSPS}$, $f_{\text{NCO}} = 30\text{MHz}$, Decimate by 24		105		dBFS
		$f_{\text{IN}} = 410 \text{ MHz}$, $f_{\text{ADC}} = 3000\text{MSPS}$, $f_{\text{NCO}} = 400\text{MHz}$, Decimate by 24		95		dBFS
		$f_{\text{IN}} = 830 \text{ MHz}$		89		dBFS
		$f_{\text{IN}} = 1760 \text{ MHz}$		89		dBFS
		$f_{\text{IN}} = 2610 \text{ MHz}$		95		dBFS
		$f_{\text{IN}} = 3610 \text{ MHz}$		87		dBFS
		$f_{\text{IN}} = 4910 \text{ MHz}$		90		dBFS

5.6 RF ADC Electrical Characteristics (continued)

Typical values at $T_A = +25^\circ\text{C}$, full temperature range is $T_{A,\text{MIN}} = -40^\circ\text{C}$ to $T_{J,\text{MAX}} = +110^\circ\text{C}$; RX Output Rate = 491.52MSPS below 6GHz input frequency and 1500MSPS above 6GHz input frequency, $f_{\text{ADC}} = 2949.12\text{MSPS}$ below 6GHz and $f_{\text{ADC}} = 3000\text{MSPS}$ above 6GHz; PLL clock mode with $f_{\text{REF}} = 491.52\text{MHz}$ below 6GHz input frequency and External clock mode with $f_{\text{CLK}} = 11796.48\text{MHz}$ above 6GHz input frequency; nominal power supplies; DSA Setting =3dB; SerDes rate =24.33Gbps; unless otherwise noted.

PARAMETER		TEST CONDITIONS	MIN	TYP	MAX	UNIT
HD2	2nd Harmonic Distortion ⁽²⁾ $A_{\text{IN}} = -13\text{ dBFS}$	$f_{\text{IN}} = 5\text{ MHz}$, $f_{\text{ADC}} = 1500\text{MSPS}$, $f_{\text{NCO}} = 17\text{MHz}$, Decimate by 48		-104		dBFS
		$f_{\text{IN}} = 30\text{ MHz}$, $f_{\text{ADC}} = 1500\text{MSPS}$, Bypass Mode (TI only test mode)		-91		dBFS
		$f_{\text{IN}} = 410\text{ MHz}$, $f_{\text{ADC}} = 3000\text{MSPS}$, Bypass Mode (TI only test mode)		-104		dBFS
		$f_{\text{IN}} = 830\text{ MHz}$, with board trim		-79		dBFS
		$f_{\text{IN}} = 1760\text{ MHz}$, with board trim		-102		dBFS
		$f_{\text{IN}} = 2610\text{ MHz}$, with board trim		-100		dBFS
		$f_{\text{IN}} = 3610\text{ MHz}$, with board trim		-101		dBFS
		$f_{\text{IN}} = 4910\text{ MHz}$, with board trim		-99		dBFS
HD3	3rd Harmonic Distortion $A_{\text{IN}} = -13\text{ dBFS}$	$f_{\text{IN}} = 5\text{ MHz}$, $f_{\text{ADC}} = 1500\text{MSPS}$, $f_{\text{NCO}} = 17\text{MHz}$, Decimate by 48		-103		dBFS
		$f_{\text{IN}} = 30\text{ MHz}$, $f_{\text{ADC}} = 1500\text{MSPS}$, Bypass Mode (TI only test mode)		-84		dBFS
		$f_{\text{IN}} = 381\text{ MHz}$, $f_{\text{ADC}} = 3000\text{MSPS}$, Bypass Mode (TI only test mode)		-91		dBFS
		$f_{\text{IN}} = 830\text{ MHz}$		-95		dBFS
		$f_{\text{IN}} = 1760\text{ MHz}$		-95		dBFS
		$f_{\text{IN}} = 2610\text{ MHz}$		-98		dBFS
		$f_{\text{IN}} = 3610\text{ MHz}$		-97		dBFS
		$f_{\text{IN}} = 4910\text{ MHz}$		-94		dBFS
HDn, n>3	SFDR excl. HD2 and HD3 $A_{\text{IN}} = -13\text{ dBFS}$	$f_{\text{IN}} = 5\text{ MHz}$, $f_{\text{ADC}} = 1500\text{MSPS}$, $f_{\text{NCO}} = 17\text{MHz}$, Decimate by 48		-104		dBFS
		$f_{\text{IN}} = 30\text{ MHz}$, $f_{\text{ADC}} = 1500\text{MSPS}$, $f_{\text{NCO}} = 30\text{MHz}$, Decimate by 24		-105		dBFS
		$f_{\text{IN}} = 410\text{ MHz}$, $f_{\text{ADC}} = 3000\text{MSPS}$, $f_{\text{NCO}} = 400\text{MHz}$, Decimate by 24		-95		dBFS
		$f_{\text{IN}} = 830\text{ MHz}$		-89		dBFS
		$f_{\text{IN}} = 1760\text{ MHz}$		-89		dBFS
		$f_{\text{IN}} = 2610\text{ MHz}$		-95		dBFS
		$f_{\text{IN}} = 3610\text{ MHz}$		-90		dBFS
		$f_{\text{IN}} = 4910\text{ MHz}$		-90		dBFS
RX-RX/FB Isolation	Near Channel: 1RXIN to 2RXIN 3RXIN to 4RXIN 1FBIN to 1RXIN 2FBIN to 3RXIN	$f_{\text{IN}} = 5\text{ MHz}$, $f_{\text{ADC}} = 1500\text{MSPS}$, $f_{\text{NCO}} = 17\text{MHz}$, Decimate by 48		-98		dB
		$f_{\text{IN}} = 30\text{ MHz}$, $f_{\text{ADC}} = 1500\text{MSPS}$, $f_{\text{NCO}} = 30\text{MHz}$, Decimate by 24		-98		dB
		$f_{\text{IN}} = 400\text{ MHz}$		-88		dB
		$f_{\text{IN}} = 830\text{ MHz}$		-77		dB
		$f_{\text{IN}} = 1760\text{ MHz}$		-71		dB
		$f_{\text{IN}} = 2610\text{ MHz}$		-74		dB
		$f_{\text{IN}} = 3610\text{ MHz}$		-77		dB
		$f_{\text{IN}} = 4910\text{ MHz}$		-65		dB

5.6 RF ADC Electrical Characteristics (continued)

Typical values at $T_A = +25^\circ\text{C}$, full temperature range is $T_{A,\text{MIN}} = -40^\circ\text{C}$ to $T_{J,\text{MAX}} = +110^\circ\text{C}$; RX Output Rate = 491.52MSPS below 6GHz input frequency and 1500MSPS above 6GHz input frequency, $f_{\text{ADC}} = 2949.12\text{MSPS}$ below 6GHz and $f_{\text{ADC}} = 3000\text{MSPS}$ above 6GHz; PLL clock mode with $f_{\text{REF}} = 491.52\text{MHz}$ below 6GHz input frequency and External clock mode with $f_{\text{CLK}} = 11796.48\text{MHz}$ above 6GHz input frequency; nominal power supplies; DSA Setting =3dB; SerDes rate =24.33Gbps; unless otherwise noted.

PARAMETER		TEST CONDITIONS	MIN	TYP	MAX	UNIT
TX-FB Isolation	Near Channel: 1TXOUT to 1FBIN 3TXOUT to 2FBIN	$f_{\text{IN}} = 5\text{ MHz}$, $f_{\text{ADC}} = 1500\text{MSPS}$, $f_{\text{NCO}} = 17\text{MHz}$, Decimate by 48		-92		dB
		$f_{\text{IN}} = 30\text{ MHz}$, $f_{\text{ADC}} = 1500\text{MSPS}$, $f_{\text{NCO}} = 30\text{MHz}$, Decimate by 24		-93		dB
		$f_{\text{IN}} = 400\text{ MHz}$		-92		dB
		$f_{\text{IN}} = 830\text{ MHz}$		-84		dB
		$f_{\text{IN}} = 1760\text{ MHz}$		-88		dB
		$f_{\text{IN}} = 2610\text{ MHz}$		-86		dB
		$f_{\text{IN}} = 3610\text{ MHz}$		-82		dB
		$f_{\text{IN}} = 4910\text{ MHz}$		-81		dB
TX-RX Isolation	Far Channel: 1TXOUT to 1RXIN 3TXOUT to 2RXIN	$f_{\text{IN}} = 5\text{ MHz}$, $f_{\text{ADC}} = 1500\text{MSPS}$, $f_{\text{NCO}} = 17\text{MHz}$, Decimate by 48		-105		dB
		$f_{\text{IN}} = 30\text{ MHz}$, $f_{\text{ADC}} = 1500\text{MSPS}$, $f_{\text{NCO}} = 30\text{MHz}$, Decimate by 24		-101		dB
		$f_{\text{IN}} = 400\text{ MHz}$		-99		dB
		$f_{\text{IN}} = 830\text{ MHz}$		-86		dB
		$f_{\text{IN}} = 1760\text{ MHz}$		-87		dB
		$f_{\text{IN}} = 2610\text{ MHz}$		-84		dB
		$f_{\text{IN}} = 3610\text{ MHz}$		-82		dB
		$f_{\text{IN}} = 4910\text{ MHz}$		-82		dB

- (1) The input fullscale at minimum attenuation can be reduce by adding a digital gain range to the DSA, extending the useful range of the DSA. The noise figure remains constant over the digital gain range.
- (2) After HD2 trim on specific printed circuit board.
- (3) From DSA = 3dB down to 0dB, NSD increases 1dB per DSA dB
- (4) NF increase 1dB per DSA 1dB above DSA = 3dB

5.7 PLL/VCO/Clock Electrical Characteristics

Typical values at TA = +25°C, full temperature range is T_{A,MIN} = -40°C to T_{J,MAX} = +110°C; Reference clock input frequency 491.52MHz (unless otherwise noted), f_{DAC} = f_{VCO}, f_{OUT} = f_{DAC}/4, normalized to f_{VCO}.

PARAMETER		TEST CONDITIONS	MIN	TYP	MAX	UNIT
f _{VCO1}	VCO1 min frequency				7.2	GHz
	VCO1 max frequency		7.68			GHz
f _{VCO2}	VCO2 min frequency				8.848	GHz
	VCO2 max frequency		9.216			GHz
f _{VCO3}	VCO3 min frequency				9.8304	GHz
	VCO3 max frequency		10.24			GHz
f _{VCO4}	VCO4 min frequency				11.7965	GHz
	VCO4 max frequency		12.288			GHz
DIV _{DAC}	DAC sample rate divider			1, 2 or 3		
DIV _{FBADC}	ADC sample rate divider from DAC sample rate			1, 2, 3, 4, 6 or 8		
DIV _{RXADC}	ADC sample rate divider			1, 2, 3, 4, 6 or 8		
PN _{VCO}	Closed Loop Phase Noise F _{PLL} = 11.79848 GHz F _{REF} =491.52MHz	600kHz		-113		dBc/Hz
		800kHz		-116		dBc/Hz
		1MHz		-119		dBc/Hz
		1.8MHz		-125		dBc/Hz
		5MHz		-133		dBc/Hz
		50MHz		-141		dBc/Hz
	Closed Loop Phase Noise F _{PLL} =8.84736 GHz F _{REF} =491.52MHz	600kHz		-114		dBc/Hz
		800kHz		-118		dBc/Hz
		1MHz		-120		dBc/Hz
		1.8MHz		-127		dBc/Hz
		5MHz		-135		dBc/Hz
		50MHz		-142		dBc/Hz
	Closed Loop Phase Noise F _{PLL} = 9.8403 GHz F _{REF} =491.52MHz	600kHz		-113		dBc/Hz
		800kHz		-116		dBc/Hz
		1MHz		-119		dBc/Hz
		1.8MHz		-125		dBc/Hz
		5MHz		-134		dBc/Hz
		50MHz		-140		dBc/Hz
	Closed Loop Phase Noise F _{PLL} = 7.86432GHz F _{REF} =491.52MHz	600kHz		-116		dBc/Hz
		800kHz		-119		dBc/Hz
		1MHz		-122		dBc/Hz
		1.8MHz		-127		dBc/Hz
		5MHz		-136		dBc/Hz
		50MHz		-143		dBc/Hz
F _{rms}	Clock PLL integrated phase error ⁽¹⁾	f _{PLL} =11.79848 GHz, [1KHz, 100MHz]		-43.4		dBc/Hz
		f _{PLL} =8.8536 GHz, [1KHz, 100MHz]		-47.6		dBc/Hz
		f _{PLL} =9.8304 GHz, [1KHz, 100MHz]		-46.2		dBc/Hz
f _{PFD}	PFD frequency		100		500	MHz
PN _{pll_flat}	Normalized PLL flat Noise	f _{VCO} = 11796.48MHz		-226.5		dBc/Hz

5.7 PLL/VCO/Clock Electrical Characteristics (continued)

Typical values at $T_A = +25^\circ\text{C}$, full temperature range is $T_{A,\text{MIN}} = -40^\circ\text{C}$ to $T_{J,\text{MAX}} = +110^\circ\text{C}$; Reference clock input frequency 491.52MHz (unless otherwise noted), $f_{\text{DAC}} = f_{\text{VCO}}$, $f_{\text{OUT}} = f_{\text{DAC}}/4$, normalized to f_{VCO} .

PARAMETER		TEST CONDITIONS	MIN	TYP	MAX	UNIT
F_{REF}	Input Clock frequency		0.1		12	GHz
V_{SS}	Input Clock level		0.6		1.8	Vppdiff
Coupling				AC Coupling Only		
	REFCLK input impedance ⁽²⁾	Parallel resistance		100		Ω
		Parallel capacitance		0.5		pF

- (1) Single Sideband, not including the reference clock contribution
(2) Refer to S11 data available from TI for impedance vs frequency

5.8 Digital Electrical Characteristics

Typical values at TA = +25°C, full temperature range is T_{A,MIN} = -40°C to T_{J,MAX} = +110°C (unless otherwise noted)

PARAMETER		TEST CONDITIONS	MIN	TYP	MAX	UNIT
CML SerDes Inputs [8:1]SRX+/-						
V _{SRDIFF}	SerDes Receiver Input Amplitude	differential	100		1200	mVpp
V _{SRCOM}	SerDes Input Common Mode			400		mV
Z _{SRdiff}	SerDes Internal Differential Termination ⁽¹⁾			100		Ω
F _{SerDes}	SerDes Bit Rate	Full rate mode	19		29.5	Gbps
		Half rate mode	9.5		16.25	Gbps
		Quarter rate mode	4.75		8.125	Gbps
	Insertion Loss Tolerance ⁽²⁾	Serdes supply = 1.8V		25		dB
TJ	Total Jitter Tolerance				0.42	UI
CML SerDes Outputs [8:1]STX+/-						
V _{STDIFF}	SerDes Transmitter Output Amplitude	differential	500		1000	mVpp
V _{STCOM}	SerDes Output Common Mode		0.4	0.45	0.55	V
Z _{STdiff}	SerDes Output Impedance			100		Ω
TRF	Output rise and fall time	20-80%	8			ps
TEQS	Equalization range				7	dB
TTJ	Output total jitter				0.21	UI
CMOS I/O: GPIO{B/C/D/E}x, SPICLK, SPISDIO, SPISDO, SPISEN, RESETZ, BISTB0, BISTB1						
V _{IH}	High-Level Input Voltage		0.6×VDD1 P8GPIO			V
V _{IL}	Low-Level Input Voltage		0.4×VDD1 P8GPIO			V
I _{IH}	High-Level Input Current		- 250		250	μA
I _{IL}	Low-Level Input Current		- 250		250	μA
C _L	CMOS input capacitance			2		pF
V _{OH}	High-Level Input Voltage		VDD1P8G PIO - 0.2			V
V _{OL}	Low-Level Input Voltage				0.2	V
Differential Inputs: SYSREF+/- Mode A						
F _{SYSREFMAX}	SYSREF Input Frequency Maximum			40		MHz
V _{SWINGSRMAX}	SYSREF Input Swing Maximum			1.8		Vppdiff ⁽³⁾
V _{SWINGSRMIN}	SYSREF Input Swing Minimum	f _{REF} < 500MHz		0.3		Vppdiff ⁽³⁾
V _{SWINGSRMIN}	SYSREF Input Swing Minimum	f _{REF} > 500MHz		0.6		Vppdiff ⁽³⁾
V _{COMSRMAX}	SYSREF Input Common Mode Voltage Maximum			0.8		V
V _{COMSRMIN}	SYSREF Input Common Mode Voltage Minimum			0.6		V
Z _T	Input termination	differential		100 ⁽¹⁾		Ω
C _L	Input capacitance	Each pin to GND		0.5		pF
LVDS Inputs: 0SYNCIN+/- and 1SYNCIN+/-						
V _{ICOM}	Input Common Voltage			1.2		V
V _{ID}	Differential Input Voltage swing			450		Vppdiff ⁽³⁾
Z _T	Input termination	differential		100		Ω
LVDS Outputs: 0SYNCOUT+/- and 1SYNCOUT+/-						
V _{OCOM}	Output Common Voltage			1.2		V

5.8 Digital Electrical Characteristics (continued)

Typical values at $T_A = +25^\circ\text{C}$, full temperature range is $T_{A,\text{MIN}} = -40^\circ\text{C}$ to $T_{J,\text{MAX}} = +110^\circ\text{C}$ (unless otherwise noted)

PARAMETER		TEST CONDITIONS	MIN	TYP	MAX	UNIT
V_{OD}	Differential Output Voltage swing			500		Vppdiff ⁽³⁾
Z_T	Internal Termination			100		Ω

- (1) SYSREF termination is programmable between $100\ \Omega$, $150\ \Omega$ and $300\ \Omega$
- (2) Loss tolerance is bump to bump from STX to SRX
- (3) Vppdiff is the difference between the maximum differential voltage (positive value) and minimum differential voltage (negative value).

5.9 Power Supply Electrical Characteristics

Typical values at $T_A = +25^\circ\text{C}$, full temperature range is $T_{A,MIN} = -40^\circ\text{C}$ to $T_{J,MAX} = +110^\circ\text{C}$; TX Input Rate = 737.28MSPS, $f_{DAC} = 8847.36\text{MSPS}$ interleave mode; $f_{ADC} = 2949.12\text{MSPS}$; nominal power supplies; 1 tone at -1 dBFS; DSA Attenuation = 0dB; SerDes rate = 24.33Gbps; unless otherwise noted.

PARAMETER		TEST CONDITIONS	MIN	TYP	MAX	UNIT	
I_{VDD1P8}	Group 3A: VDD1P8FB + VDD1P8RX + VDD1P8TX	Mode 1: 4T2F - FDD FB 100% on, no RX TX/FB Rate: 491.52 Msps Single Band: 12x Int, FB 6x Dec $f_{DAC} = 5898.24$ SPS $f_{ADC} = 2949.12\text{MSPS}$ $f_{TX} = 1.85$ GHz 64/66 coding, 16.22Gbps TX: 4-8-4-1, FB: 2-4-4-1		948.2		mA	
	Group 3B: VDD1P8FBCLK + VDD1P8RXCLK + VDD1P8TXDAC+ VDD1P8GPIO + VDDA1P8			533.7		mA	
	Group 3C: VDD1P8PLL + VDD1P8PLLVCO			77.3		mA	
I_{VDD1P2}	Group 2A: VDD1P2FB + VDD1P2RX				299.4		mA
	Group 2B: VDD1P2TXCLK + VDD1P2TXENC				804.5		mA
	Group 2C: VDD1P2FBCML + VDD1P2RXCML + VDD1P2PLLCLKREF				49.1		mA
I_{VDD0P9}	Group 1A: DVDD0P9 + VDDT0P9				2041.3		mA
P_{diss}	Power Dissipation				6027.1		mW
I_{VDD1P8}	Group 3A: VDD1P8FB + VDD1P8RX + VDD1P8TX		Mode 2: 4T4R - TDD 1F shared with RX TX 75%, RX 25%, FB 75% Dual Band: 12x Int, FB 6x Dec, RX 24x Dec TX/FB Rate 491.52 Msps RX Rate 122.88 Msps $f_{DAC} = 8847.36\text{MSPS}$ $f_{ADC} = 2949.12\text{MSPS}$ $f_{OUT}=f_{IN} = 1.9, 2.6$ GHz 64/66 coding, 16.22Gbps TX: 8-16-4-1, FB: 2-4-4-1, RX: 2-16-16-1		820.4		mA
	Group 3B: VDD1P8FBCLK + VDD1P8RXCLK + VDD1P8TXDAC+ VDD1P8GPIO + VDDA1P8			735.2		mA	
	Group 3C: VDD1P8PLL + VDD1P8PLLVCO			74.4		mA	
I_{VDD1P2}	Group 2A: VDD1P2FB + VDD1P2RX				289.0		mA
	Group 2B: VDD1P2TXCLK + VDD1P2TXENC				822.0		mA
	Group 2C: VDD1P2FBCML + VDD1P2RXCML + VDD1P2PLLCLKREF				45.6		mA
I_{VDD0P9}	Group 1A: DVDD0P9 + VDDT0P9				2263.8		mA
P_{diss}	Power Dissipation				6359.2		mW
I_{VDD1P8}	Group 3A: VDD1P8FB + VDD1P8RX + VDD1P8TX	Mode 3: 4T4R2F - FDD FB 100% on TX Dual Band: 12x Int, FB 6x Dec RX Dual Band: RX 24x TX/FB Rate 491.52 Msps RX Rate 122.88 Msps $f_{DAC} = 11796.48$ MSPS $f_{ADC} = 2949.12$ MSPS $f_{TX} = 1.85 + 2.15$ GHz $f_{RX} = 1.75 + 1.88$ GHz 64/66 coding, 16.22Gbps TX: 8-16-4-1, FB: 2-4-4-1, RX: 2-16-16-1			1668.6		mA
	Group 3B: VDD1P8FBCLK + VDD1P8RXCLK + VDD1P8TXDAC+ VDD1P8GPIO + VDDA1P8			965.1		mA	
	Group 3C: VDD1P8PLL + VDD1P8PLLVCO			77.6		mA	
I_{VDD1P2}	Group 2A: VDD1P2FB + VDD1P2RX				893.4		mA
	Group 2B: VDD1P2TXCLK + VDD1P2TXENC				879.5		mA
	Group 2C: VDD1P2FBCML + VDD1P2RXCML + VDD1P2PLLCLKREF				50.7		mA
I_{VDD0P9}	Group 1A: DVDD0P9 + VDDT0P9				3826.9		mA
P_{diss}	Power Dissipation				10513.0		mW

5.9 Power Supply Electrical Characteristics (continued)

Typical values at $T_A = +25^\circ\text{C}$, full temperature range is $T_{A,\text{MIN}} = -40^\circ\text{C}$ to $T_{J,\text{MAX}} = +110^\circ\text{C}$; TX Input Rate = 737.28MSPS, $f_{\text{DAC}} = 8847.36\text{MSPS}$ interleave mode; $f_{\text{ADC}} = 2949.12\text{MSPS}$; nominal power supplies; 1 tone at -1 dBFS; DSA Attenuation = 0dB; SerDes rate = 24.33Gbps; unless otherwise noted.

PARAMETER		TEST CONDITIONS	MIN	TYP	MAX	UNIT
I_{VDD1P8}	Group 3A: VDD1P8FB + VDD1P8RX + VDD1P8TX	Mode 4: 4T4R2F - FDD FB 100% on 7.5 GSPS DAC, 2.5 GSPS ADC Single Band: 15x Int, FB 5x Dec Dual Band: RX 20x TX/FB Rate 491.52 Msps RX Rate 122.88 Msps $f_{\text{DAC}} = 7372.8\text{ MSPS}$ $f_{\text{ADC}} = 2457.6\text{ MSPS}$ $f_{\text{TX}} = 1.85 + 2.15\text{ GHz}$ $f_{\text{RX}} = 1.75 + 1.88\text{ GHz}$ 64/66 coding, 16.22Gbps TX: 4-8-4-1, FB: 2-4-4-1, RX: 2-16-16-1	1611.5			mA
	Group 3B: VDD1P8FBCLK + VDD1P8RXCLK + VDD1P8TXDAC+ VDD1P8GPIO + VDDA1P8		694.5			mA
	Group 3C: VDD1P8PLL + VDD1P8PLLVC0		72.8			mA
I_{VDD1P2}	Group 2A: VDD1P2FB + VDD1P2RX		768.5			mA
	Group 2B: VDD1P2TXCLK + VDD1P2TXENC		940.5			mA
	Group 2C: VDD1P2FBCML + VDD1P2RXCML + VDD1P2PLLCLKREF		45.5			mA
I_{VDD0P9}	Group 1A: DVDD0P9 + VDDT0P9		3000.5			mA
P_{diss}	Power Dissipation		9087.4			mW
I_{VDD1P8}	Group 3A: VDD1P8FB + VDD1P8RX + VDD1P8TX		Mode 5: 4T4R - TDD 1F shared with RX TX 75%, RX 25%, FB 75% Single Band: 12x Int, FB 3x Dec, RX 6x Dec TX/FB Rate = 983.04 Msps RX Rate 491.52 Msps $f_{\text{DAC}} = 11796.48\text{ MSPS}$ $f_{\text{ADC}} = 2949.12\text{ MSPS}$ $f_{\text{TX}} = 3.5\text{ GHz}$ $f_{\text{RX}} = 3.5\text{ GHz}$ 64/66 coding, 16.22Gbps TX: 8-8-2-1, FB: 4-4-4-2, RX: 4-8-4-1	821.8		
	Group 3B: VDD1P8FBCLK + VDD1P8RXCLK + VDD1P8TXDAC+ VDD1P8GPIO + VDDA1P8	808.5				mA
	Group 3C: VDD1P8PLL + VDD1P8PLLVC0	77.4				mA
I_{VDD1P2}	Group 2A: VDD1P2FB + VDD1P2RX	289.5				mA
	Group 2B: VDD1P2TXCLK + VDD1P2TXENC	682.0				mA
	Group 2C: VDD1P2FBCML + VDD1P2RXCML + VDD1P2PLLCLKREF	49.0				mA
I_{VDD0P9}	Group 1A: DVDD0P9 + VDDT0P9	2123.3				mA
P_{diss}	Power Dissipation	6209.3				mW
I_{VDD1P8}	Group 3A: VDD1P8FB + VDD1P8RX + VDD1P8TX	Mode 8: same configuration as mode 7, Sleep Mode. SLEEP pin is pull high.		20.3		
	Group 3B: VDD1P8FBCLK + VDD1P8RXCLK + VDD1P8TXDAC+ VDD1P8GPIO + VDDA1P8		292.8			mA
	Group 3C: VDD1P8PLL + VDD1P8PLLVC0		12.6			mA
I_{VDD1P2}	Group 2A: VDD1P2FB + VDD1P2RX		4.6			mA
	Group 2B: VDD1P2TXCLK + VDD1P2TXENC		54.3			mA
	Group 2C: VDD1P2FBCML + VDD1P2RXCML + VDD1P2PLLCLKREF		15.3			mA
I_{VDD0P9}	Group 1A: DVDD0P9 + VDDT0P9		313.1			mA
P_{diss}	Power Dissipation		956.8			mW

5.9 Power Supply Electrical Characteristics (continued)

Typical values at $T_A = +25^\circ\text{C}$, full temperature range is $T_{A,MIN} = -40^\circ\text{C}$ to $T_{J,MAX} = +110^\circ\text{C}$; TX Input Rate = 737.28MSPS, $f_{DAC} = 8847.36\text{MSPS}$ interleave mode; $f_{ADC} = 2949.12\text{MSPS}$; nominal power supplies; 1 tone at -1 dBFS; DSA Attenuation = 0dB; SerDes rate = 24.33Gbps; unless otherwise noted.

PARAMETER		TEST CONDITIONS	MIN	TYP	MAX	UNIT
I_{VDD1P8}	Group 3A: VDD1P8FB + VDD1P8RX + VDD1P8TX	Mode 9: 4T4R2F - FDD FB 100% on TX Single Band: 24x Int, FB 12x Dec RX Single Band: RX 24x TX/FB Rate 245.76 Msps RX Rate 122.88 Msps $f_{DAC} = 5898.24\text{ MSPS}$ $f_{ADC} = 2949.12\text{ MSPS}$ $f_{TX} = 0.85\text{ GHz}$ $f_{RX} = 0.8\text{ GHz}$ 8/10 coding, 9.8304Gbps TX: 4-8-4-1, FB: 2-4-4-1, RX: 2-8-8-1		1593.2		mA
	Group 3B: VDD1P8FBCLK + VDD1P8RXCLK + VDD1P8TXDAC+ VDD1P8GPIO + VDDA1P8			840.6		mA
	Group 3C: VDD1P8PLL + VDD1P8PLLVC0			77.3		mA
I_{VDD1P2}	Group 2A: VDD1P2FB + VDD1P2RX			905.0		mA
	Group 2B: VDD1P2TXCLK + VDD1P2TXENC			817.7		mA
	Group 2C: VDD1P2FBCML + VDD1P2RXCML + VDD1P2PLLCLKREF			52.1		mA
I_{VDD0P9}	Group 1A: DVDD0P9 + VDDT0P9			2405.2		mA
P_{diss}	Power Dissipation			8814.3		mW
I_{VDD1P8}	Group 3A: VDD1P8FB + VDD1P8RX + VDD1P8TX		Mode 10: 4T4R2F - FDD FB 100% on TX Single Band: 18x Int, FB 6x Dec RX Single Band: RX 12x TX/FB Rate 491.52 Msps RX Rate 245.76 Msps $f_{DAC} = 8847.36\text{ MSPS}$ $f_{ADC} = 2949.12\text{ MSPS}$ $f_{TX} = 1.85\text{ GHz}$ $f_{RX} = 1.75\text{ GHz}$ 8/10 coding, 9.8304Gbps TX: 8-8-2-1, FB: 4-4-2-1, RX: 4-8-4-1		1626.2	
	Group 3B: VDD1P8FBCLK + VDD1P8RXCLK + VDD1P8TXDAC+ VDD1P8GPIO + VDDA1P8			976.4		mA
	Group 3C: VDD1P8PLL + VDD1P8PLLVC0			74.6		mA
I_{VDD1P2}	Group 2A: VDD1P2FB + VDD1P2RX			902.7		mA
	Group 2B: VDD1P2TXCLK + VDD1P2TXENC			1111.9		mA
	Group 2C: VDD1P2FBCML + VDD1P2RXCML + VDD1P2PLLCLKREF			48.0		mA
I_{VDD0P9}	Group 1A: DVDD0P9 + VDDT0P9			3578.9		mA
P_{diss}	Power Dissipation			10515.0		mW
I_{VDD1P8}	Group 3A: VDD1P8FB + VDD1P8RX + VDD1P8TX	Mode 11a: TDD 4T1FB (RX in Standby) Single Band: 8x Int, FB 2x Dec, RX uses FB TX/FB/RX Rate = 1474.56 Msps $f_{DAC} = 11796.48\text{ MSPS}$, interleave mode, $f_{ADC} = 2949.12\text{ MSPS}$ $f_{TX} = f_{RX} = 3.7\text{ GHz}$ 64/66 coding, 24.33 Gbps TX: 8-8-2-1, FB/RX: 8-8-2-1			797	
	Group 3B: VDD1P8FBCLK + VDD1P8RXCLK + VDD1P8TXDAC+ VDD1P8GPIO + VDDA1P8			817		mA
	Group 3C: VDD1P8PLL + VDD1P8PLLVC0			73.2		mA
I_{VDD1P2}	Group 2A: VDD1P2FB + VDD1P2RX			179		mA
	Group 2B: VDD1P2TXCLK + VDD1P2TXENC			906		mA
	Group 2C: VDD1P2FBCML + VDD1P2RXCML + VDD1P2PLLCLKREF			70.5		mA
I_{VDD0P9}	Group 1A: DVDD0P9 + VDDT0P9			2483		mA
P_{diss}	Power Dissipation			6754		mW

5.9 Power Supply Electrical Characteristics (continued)

Typical values at $T_A = +25^\circ\text{C}$, full temperature range is $T_{A,\text{MIN}} = -40^\circ\text{C}$ to $T_{J,\text{MAX}} = +110^\circ\text{C}$; TX Input Rate = 737.28MSPS, $f_{\text{DAC}} = 8847.36\text{MSPS}$ interleave mode; $f_{\text{ADC}} = 2949.12\text{MSPS}$; nominal power supplies; 1 tone at -1 dBFS; DSA Attenuation = 0dB; SerDes rate = 24.33Gbps; unless otherwise noted.

PARAMETER		TEST CONDITIONS	MIN	TYP	MAX	UNIT
I_{VDD1P8}	Group 3A: VDD1P8FB + VDD1P8RX + VDD1P8TX	Mode 11b: TDD 4R (TX in Standby) Single Band: 8x Int, FB 2x Dec, RX uses FB TX/FB/RX Rate = 1474.56 Msps $f_{\text{DAC}} = 11796.48\text{ MSPS}$, interleave mode, $f_{\text{ADC}} = 2949.12\text{ MSPS}$ $f_{\text{TX}} = f_{\text{RX}} = 3.7\text{ GHz}$ 64/66 coding, 24.33 Gbps TX: 8-8-2-1, FB/RX: 8-8-2-1		726		mA
	Group 3B: VDD1P8FBCLK + VDD1P8RXCLK + VDD1P8TXDAC + VDD1P8GPIO + VDDA1P8			876		mA
	Group 3C: VDD1P8PLL + VDD1P8PLLCO			72.8		mA
I_{VDD1P2}	Group 2A: VDD1P2FB + VDD1P2RX			583		mA
	Group 2B: VDD1P2TXCLK + VDD1P2TXENC			270		mA
	Group 2C: VDD1P2FBCML + VDD1P2RXCML + VDD1P2PLLCLKREF			71.6		mA
I_{VDD0P9}	Group 1A: DVDD0P9 + VDDT0P9		2130		mA	
P_{diss}	Power Dissipation		6124		mW	

5.9 Power Supply Electrical Characteristics (continued)

Typical values at $T_A = +25^\circ\text{C}$, full temperature range is $T_{A,\text{MIN}} = -40^\circ\text{C}$ to $T_{J,\text{MAX}} = +110^\circ\text{C}$; TX Input Rate = 737.28MSPS, $f_{\text{DAC}} = 8847.36\text{MSPS}$ interleave mode; $f_{\text{ADC}} = 2949.12\text{MSPS}$; nominal power supplies; 1 tone at -1 dBFS; DSA Attenuation = 0dB; SerDes rate = 24.33Gbps; unless otherwise noted.

PARAMETER		TEST CONDITIONS	MIN	TYP	MAX	UNIT
I_{VDD1P8}	Group 3A: VDD1P8FB + VDD1P8RX + VDD1P8TX	Mode 11c: TDD 4T4R1FB average TX/FB: 75%, RX 25% Single Band: 8x Int, FB 2x Dec, RX uses FB TX/FB/RX Rate = 1474.56 Msps $f_{\text{DAC}} = 11796.48\text{ MSPS}$, interleave mode, $f_{\text{ADC}} = 2949.12\text{ MSPS}$ $f_{\text{TX}} = f_{\text{RX}} = 3.7\text{ GHz}$ 64/66 coding, 24.33 Gbps TX: 8-8-2-1, FB/RX: 8-8-2-1		779		mA
	Group 3B: VDD1P8FBCLK + VDD1P8RXCLK + VDD1P8TXDAC+ VDD1P8GPIO + VDDA1P8			832		mA
	Group 3C: VDD1P8PLL + VDD1P8PLLCO			73.1		mA
I_{VDD1P2}	Group 2A: VDD1P2FB + VDD1P2RX			280		mA
	Group 2B: VDD1P2TXCLK + VDD1P2TXENC			747		mA
	Group 2C: VDD1P2FBCML + VDD1P2RXCML + VDD1P2PLLCLKREF			70.8		mA
I_{VDD0P9}	Group 1A: DVDD0P9 + VDDT0P9			2395		mA
P_{diss}	Power Dissipation			6596		mW
I_{VDD1P8}	Group 3A: VDD1P8FB + VDD1P8RX + VDD1P8TX		Mode 11d: FDD 4T4R Single Band: 8x Int, RX uses FB TX/FB/RX Rate = 1474.56 Msps $f_{\text{DAC}} = 11796.48\text{ MSPS}$, interleave mode, $f_{\text{ADC}} = 2949.12\text{ MSPS}$ $f_{\text{TX}} = f_{\text{RX}} = 3.7\text{ GHz}$ 64/66 coding, 24.33 Gbps TX: 8-8-2-1, FB/RX: 8-8-2-1		1236	
	Group 3B: VDD1P8FBCLK + VDD1P8RXCLK + VDD1P8TXDAC+ VDD1P8GPIO + VDDA1P8			915		mA
	Group 3C: VDD1P8PLL + VDD1P8PLLCO			73.2		mA
I_{VDD1P2}	Group 2A: VDD1P2FB + VDD1P2RX			583		mA
	Group 2B: VDD1P2TXCLK + VDD1P2TXENC			923		mA
	Group 2C: VDD1P2FBCML + VDD1P2RXCML + VDD1P2PLLCLKREF			72		mA
I_{VDD0P9}	Group 1A: DVDD0P9 + VDDT0P9			3097		mA
P_{diss}	Power Dissipation			8798		mW

5.10 Timing Requirements

Typical values at $T_A = +25^\circ\text{C}$, full temperature range is $T_{A,\text{MIN}} = -40^\circ\text{C}$ to $T_{J,\text{MAX}} = +110^\circ\text{C}$; TX Input Rate = 491.52MSPS, $f_{\text{DAC}} = 8847.36\text{MSPS}$; $f_{\text{ADC}} = 2949.12\text{MSPS}$; nominal power supplies; 1 tone at -1 dBFS; DSA Attenuation = 0dB; SerDes rate = 24.33Gbps; unless otherwise noted.

		MIN	NOM	MAX	UNIT
Timing: SYSREF+/-					
$t_{\text{s}}(\text{SYSREF})$	Setup Time, SYSREF+/- Valid to Rising Edge of CLK+/-		50		ps
$t_{\text{h}}(\text{SYSREF})$	Hold Time, SYSREF+/- Valid after Rising Edge of CLK+/-		50		ps
Timing: Serial ports					
$t_{\text{s}}(\text{SENB})$	Setup Time, SENB to Rising Edge of SCLK		15		ns
$t_{\text{h}}(\text{SENB})$	Hold Time, SENB after last Rising Edge of SCLK ⁽¹⁾		$5 + t_{\text{sCLK}}$		ns
$t_{\text{s}}(\text{SDIO})$	Setup Time, SDIO valid to Rising Edge of SCLK		15		ns
$t_{\text{h}}(\text{SDIO})$	Hold Time, SDIO valid after Rising Edge of SCLK		5		ns
$t_{\text{s}}(\text{SCLK_W})$	Minimum SCLK period: registers write		25		ns
$t_{\text{s}}(\text{SCLK_R})$	Minimum SCLK period: registers read		50		ns
$t_{\text{d}}(\text{data_out})$	Minimum Data Output delay after Falling Edge of SCLK		0		ns
	Maximum Data Output delay after Falling Edge of SCLK		15		ns
t_{RESET}	Minimum RESETZ Pulse Width		1		ms

(1) SDEN\ need to be held one more extra clock cycle with the last SCLK edge

5.11 Switching Characteristics

Typical values at $T_A = +25^\circ\text{C}$, full temperature range is $T_{A,MIN} = -40^\circ\text{C}$ to $T_{J,MAX} = +110^\circ\text{C}$; TX Input Rate = 491.52MSPS, $f_{DAC} = 8847.36\text{MSPS}$; $f_{ADC} = 2949.12\text{MSPS}$; nominal power supplies; 1 tone at -1 dBFS; DSA Attenuation = 0dB; SerDes rate = 24.33Gbps; unless otherwise noted.

PARAMETER		TEST CONDITIONS	MIN	TYP	MAX	UNIT
TX Channel Latency						
	SerDes Receiver Analog Delay	Full rate		2.8		ns
$t_{JESD\text{TX}}$	JESD to TX output Latency	LMFSHd=2-8-8-1, 368.64 MSPS input rate, 24x Interpolation, Serdes rate = 16.22Gbps (JESD204C)		152		interface clock cycles ⁽¹⁾
		LMFSHd=8-16-4-1, 491.52 MSPS 24x Interpolation, Serdes rate = 16.22Gbps (JESD204C)		176		
		LMFSHd=4-16-8-1, 245.76 MSPS 48x Interpolation, Serdes rate = 16.22Gbps (JESD204C)		124		
		LMFSHd=2-16-16-1, 122.88 MSPS 96x Interpolation, Serdes rate = 16.22Gbps (JESD204C)		97		
RX Channel Latency						
	SerDes Transmitter Analog Delay			3.6		ns
$t_{JESD\text{RX}}$	RX input to JESD output Latency	LMFS=2-16-16-1, 122.88 MSPS, 24x Decimation, Serdes rate = 16.22Gbps (JESD204C)		92		interface clock cycles ⁽¹⁾
		LMFS=4-16-8-1, 245.76 MSPS, 12x Decimation, Serdes rate = 16.22Gbps (JESD204C)		108		
		LMFS=2-8-8-1, 368.64 MSPS, 8x Decimation, Serdes rate = 16.22Gbps (JESD204C)		118		
		LMFS=4-8-4-1, 491.52 MSPS, 6x Decimation, Serdes rate = 16.22Gbps (JESD204C)		153		
FB Channel Latency						
	SerDes Transmitter Analog Delay			3.6		ns
$t_{JESD\text{FB}}$	FB input to JESD output Latency	LMFS=1-2-8-1, 368.64 MSPS, 8x Decimation		151		interface clock cycles ⁽¹⁾
		LMFS=2-4-4-1, 491.52 MSPS, 6x Decimation		177		

(1) Interface clock cycles is the period of the digital interface clock rate, e.g. 1GSPS = 1ns.

5.12 Typical Characteristics

5.12.1 RX Typical Characteristics 30 MHz and 400 MHz

Typical values at $T_A = +25^\circ\text{C}$. Default conditions at 30MHz: ADC Sampling Rate = 1500 MSPS, output sample rate = 62.5 MSPS (decimate by 24x), PLL clock mode with $f_{REF} = 500\text{ MHz}$, $A_{IN} = -3\text{ dBFS}$, DSA setting = 3 dB. Default conditions at 400 MHz: ADC Sampling Rate = 1500 MSPS, output sample rate = 125 MSPS (decimate by 12x), PLL clock mode with $f_{REF} = 500\text{ MHz}$, $A_{IN} = -3\text{ dBFS}$, DSA setting = 3 dB.



图 5-1. RX In-Band Gain Flatness, $f_{IN} = 30\text{ MHz}$



$$\text{Differential Amplitude Error} = P_{IN}(\text{DSA Setting} - 1) - P_{IN}(\text{DSA Setting}) + 1$$

图 5-2. RX Uncalibrated Differential Amplitude Error vs DSA Setting at 30 MHz

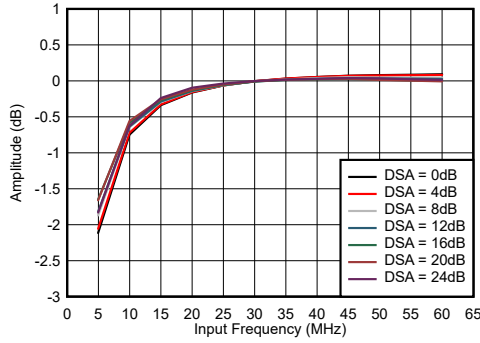
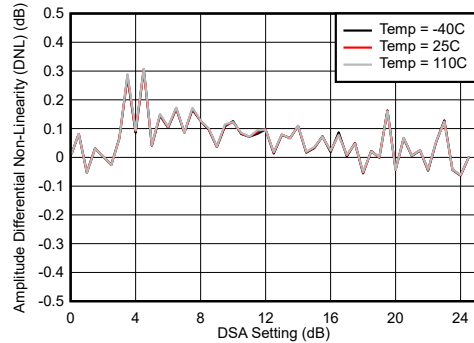
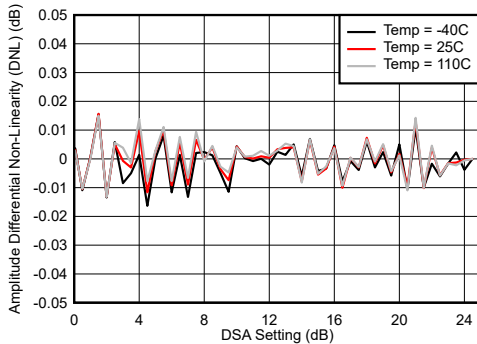

$$\text{Differential Amplitude Error} = P_{IN}(\text{DSA Setting} - 1) - P_{IN}(\text{DSA Setting}) + 1$$

图 5-3. RX Calibrated Differential Amplitude Error vs DSA Setting at 30 MHz

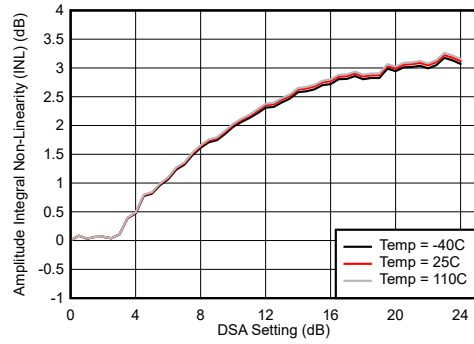

$$\text{Integrated Amplitude Error} = P_{IN}(\text{DSA Setting}) - P_{IN}(\text{DSA Setting} = 0) + (\text{DSA Setting})$$

图 5-4. RX Uncalibrated Integrated Amplitude Error vs DSA Setting at 30 MHz

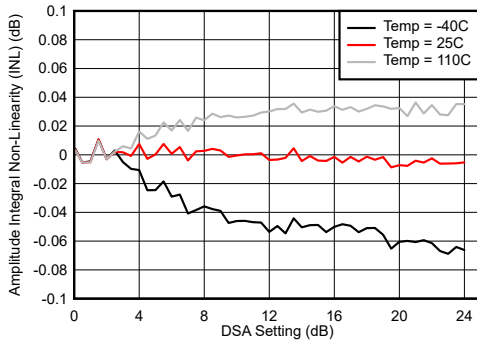

$$\text{Integrated Amplitude Error} = P_{IN}(\text{DSA Setting}) - P_{IN}(\text{DSA Setting} = 0) + (\text{DSA Setting})$$

图 5-5. RX Calibrated Integrated Amplitude Error vs DSA Setting at 30 MHz

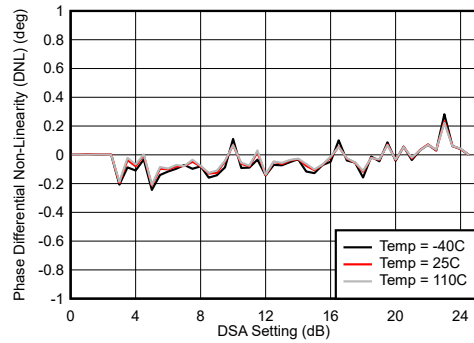

$$\text{Differential Phase Error} = \text{Phase}_{IN}(\text{DSA Setting} - 1) - \text{Phase}_{IN}(\text{DSA Setting})$$

图 5-6. RX Uncalibrated Differential Phase Error vs DSA Setting at 30 MHz

5.12.1 RX Typical Characteristics 30 MHz and 400 MHz (continued)

Typical values at $T_A = +25^\circ\text{C}$. Default conditions at 30MHz: ADC Sampling Rate = 1500 MSPS, output sample rate = 62.5 MSPS (decimate by 24x), PLL clock mode with $f_{REF} = 500\text{ MHz}$, $A_{IN} = -3\text{ dBFS}$, DSA setting = 3 dB. Default conditions at 400 MHz: ADC Sampling Rate = 1500 MSPS, output sample rate = 125 MSPS (decimate by 12x), PLL clock mode with $f_{REF} = 500\text{ MHz}$, $A_{IN} = -3\text{ dBFS}$, DSA setting = 3 dB.

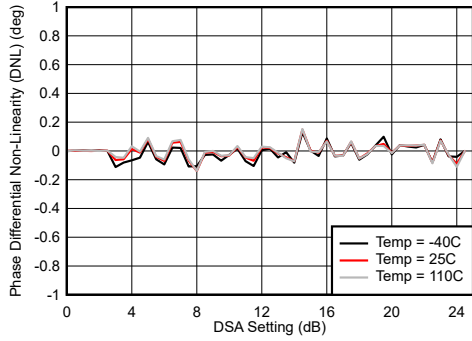

$$\text{Differential Phase Error} = \text{Phase}_{IN}(\text{DSA Setting} - 1) - \text{Phase}_{IN}(\text{DSA Setting})$$

图 5-7. RX Calibrated Differential Phase Error vs DSA Setting at 30 MHz

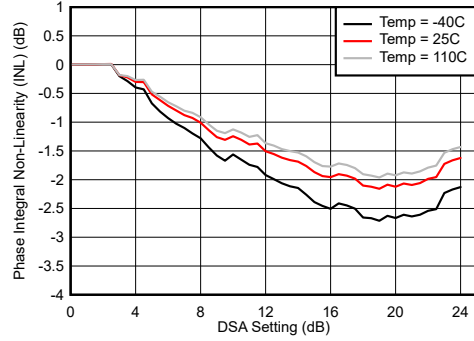

$$\text{Integrated Phase Error} = \text{Phase}(\text{DSA Setting}) - \text{Phase}(\text{DSA Setting} = 0)$$

图 5-8. RX Uncalibrated Integrated Phase Error vs DSA Setting at 30 MHz

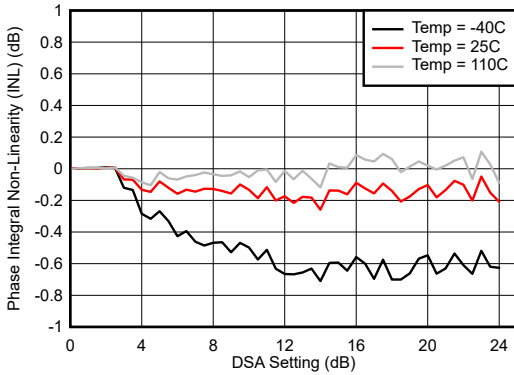

With 0.8 GHz matching

$$\text{Integrated Phase Error} = \text{Phase}(\text{DSA Setting}) - \text{Phase}(\text{DSA Setting} = 0)$$

图 5-9. RX Calibrated Integrated Phase Error vs DSA Setting at 30 MHz

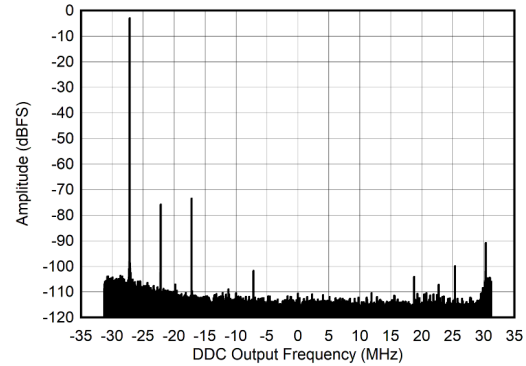

$A_{IN} = -3\text{ dBFS}$, $f_{ADC} = 1500\text{ MSPS}$, $f_{NCO} = 32.13\text{ MHz}$,
Decimate by 24x

图 5-10. RX Output FFT at 5 MHz

5.12.1 RX Typical Characteristics 30 MHz and 400 MHz (continued)

Typical values at $T_A = +25^\circ\text{C}$. Default conditions at 30MHz: ADC Sampling Rate = 1500 MSPS, output sample rate = 62.5 MSPS (decimate by 24x), PLL clock mode with $f_{\text{REF}} = 500\text{ MHz}$, $A_{\text{IN}} = -3\text{ dBFS}$, DSA setting = 3 dB. Default conditions at 400 MHz: ADC Sampling Rate = 1500 MSPS, output sample rate = 125 MSPS (decimate by 12x), PLL clock mode with $f_{\text{REF}} = 500\text{ MHz}$, $A_{\text{IN}} = -3\text{ dBFS}$, DSA setting = 3 dB.

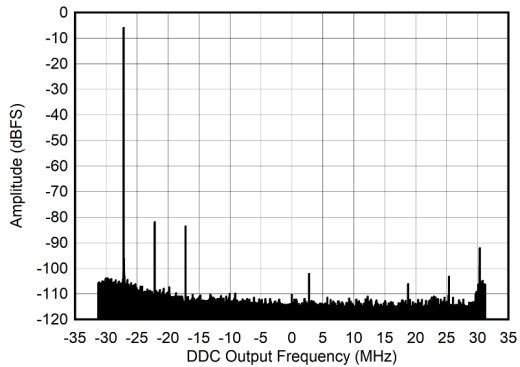

$A_{\text{IN}} = -6\text{ dBFS}$, $f_{\text{ADC}} = 1500\text{ MSPS}$, $f_{\text{NCO}} = 32.$, Decimate by 24x

图 5-11. RX Output FFT at 5 MHz

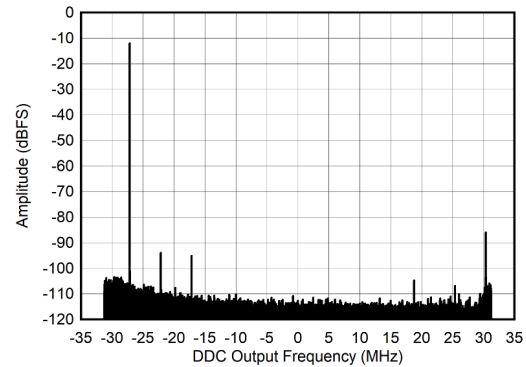

$A_{\text{IN}} = -12\text{ dBFS}$, $f_{\text{ADC}} = 1500\text{ MSPS}$, $f_{\text{NCO}} = 32.13\text{ MHz}$, Decimate by 24x

图 5-12. RX Output FFT at 5 MHz

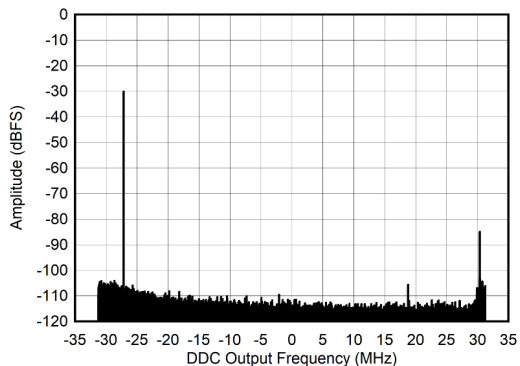

$A_{\text{IN}} = -30\text{ dBFS}$, $f_{\text{ADC}} = 1500\text{ MSPS}$, $f_{\text{NCO}} = 32.13\text{ MHz}$, Decimate by 24x

图 5-13. RX Output FFT at 5 MHz

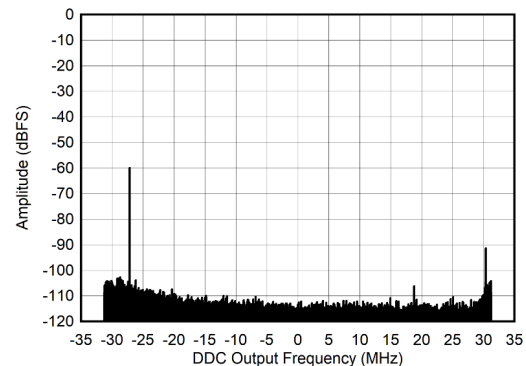

$A_{\text{IN}} = -60\text{ dBFS}$, $f_{\text{ADC}} = 1500\text{ MSPS}$, $f_{\text{NCO}} = 32.13\text{ MHz}$, Decimate by 24x

图 5-14. RX Output FFT at 5 MHz

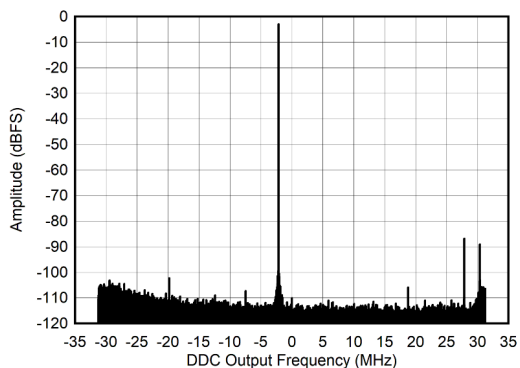

$A_{\text{IN}} = -3\text{ dBFS}$, $f_{\text{ADC}} = 1500\text{ MSPS}$, $f_{\text{NCO}} = 32.13\text{ MHz}$, Decimate by 24x

图 5-15. RX Output FFT at 30 MHz

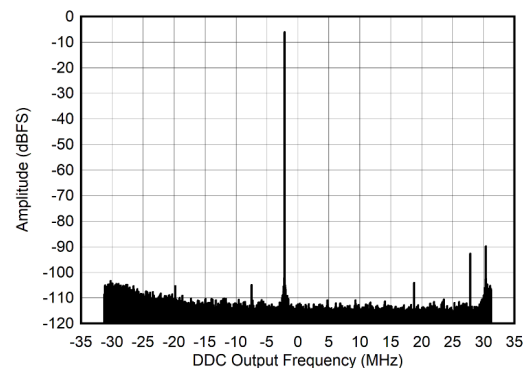

$A_{\text{IN}} = -6\text{ dBFS}$, $f_{\text{ADC}} = 1500\text{ MSPS}$, $f_{\text{NCO}} = 32.13\text{ MHz}$, Decimate by 24x

图 5-16. RX Output FFT at 30 MHz

5.12.1 RX Typical Characteristics 30 MHz and 400 MHz (continued)

Typical values at $T_A = +25^\circ\text{C}$. Default conditions at 30MHz: ADC Sampling Rate = 1500 MSPS, output sample rate = 62.5 MSPS (decimate by 24x), PLL clock mode with $f_{REF} = 500\text{ MHz}$, $A_{IN} = -3\text{ dBFS}$, DSA setting = 3 dB. Default conditions at 400 MHz: ADC Sampling Rate = 1500 MSPS, output sample rate = 125 MSPS (decimate by 12x), PLL clock mode with $f_{REF} = 500\text{ MHz}$, $A_{IN} = -3\text{ dBFS}$, DSA setting = 3 dB.

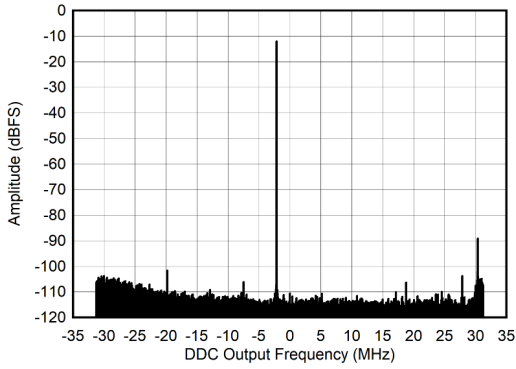

$A_{IN} = -12\text{ dBFS}$, $f_{ADC} = 1500\text{ MSPS}$, $f_{NCO} = 32.13\text{ MHz}$,
 Decimate by 24x

图 5-17. RX Output FFT at 30 MHz

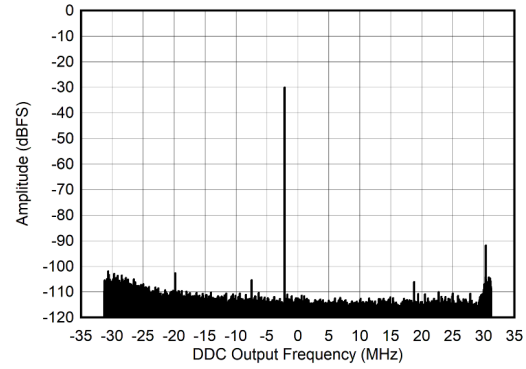

$A_{IN} = -30\text{ dBFS}$, $f_{ADC} = 1500\text{ MSPS}$, $f_{NCO} = 32.13\text{ MHz}$,
 Decimate by 24x

图 5-18. RX Output FFT at 30 MHz

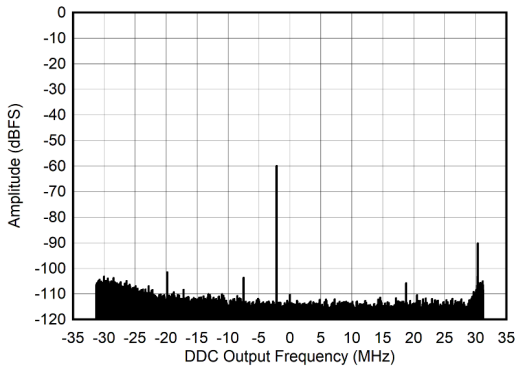

$A_{IN} = -60\text{ dBFS}$, $f_{ADC} = 1500\text{ MSPS}$, $f_{NCO} = 32.13\text{ MHz}$,
 Decimate by 24x

图 5-19. RX Output FFT at 30 MHz

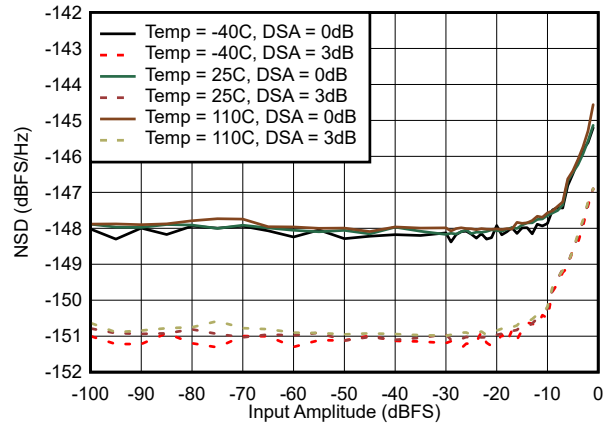

$f_{ADC} = 1500\text{ MSPS}$, $f_{NCO} = 32.13\text{ MHz}$, Decimate by 24x

图 5-20. NSD vs Input Amplitude at 30 MHz with DSA = 0 and 3dB

5.12.1 RX Typical Characteristics 30 MHz and 400 MHz (continued)

Typical values at $T_A = +25^\circ\text{C}$. Default conditions at 30MHz: ADC Sampling Rate = 1500 MSPS, output sample rate = 62.5 MSPS (decimate by 24x), PLL clock mode with $f_{REF} = 500\text{ MHz}$, $A_{IN} = -3\text{ dBFS}$, DSA setting = 3 dB. Default conditions at 400 MHz: ADC Sampling Rate = 1500 MSPS, output sample rate = 125 MSPS (decimate by 12x), PLL clock mode with $f_{REF} = 500\text{ MHz}$, $A_{IN} = -3\text{ dBFS}$, DSA setting = 3 dB.

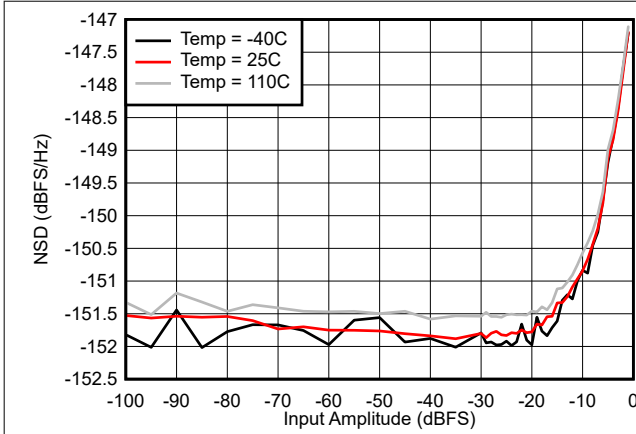

$f_{ADC} = 1500\text{ MSPS}$, $f_{NCO} = 32.13\text{ MHz}$, Decimate by 24x

图 5-21. NSD vs Input Amplitude at 30 MHz with DSA = 12

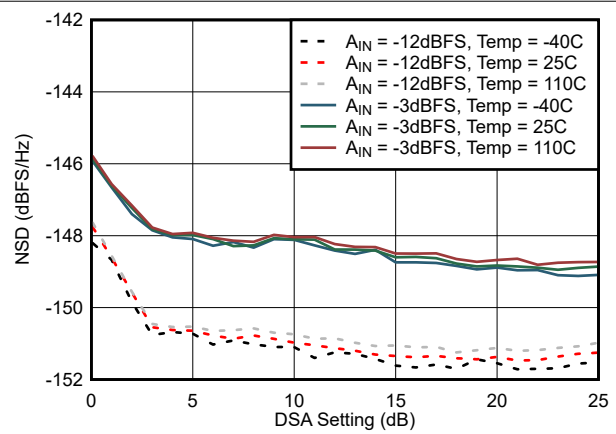

$f_{ADC} = 1500\text{ MSPS}$, $f_{NCO} = 32.13\text{ MHz}$, Decimate by 24x

图 5-22. NSD vs DSA Attenuation at 30 MHz

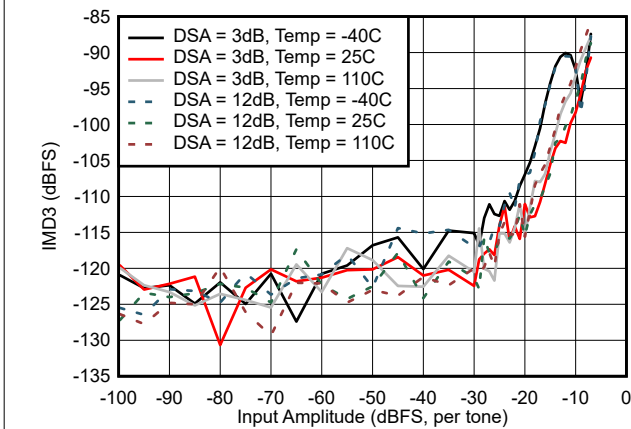

$f_{ADC} = 1500\text{ MSPS}$, $f_{NCO} = 32.13\text{ MHz}$, Decimate by 24x

图 5-23. IMD3 vs Input Amplitude at 30 MHz

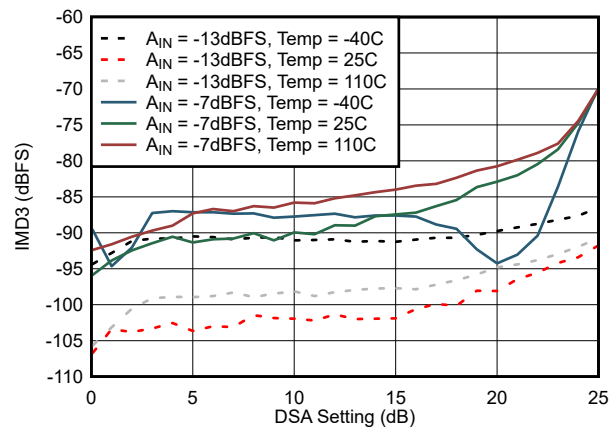

$f_{ADC} = 1500\text{ MSPS}$, $f_{NCO} = 32.13\text{ MHz}$, Decimate by 24x

图 5-24. IMD3 vs DSA Setting at 30 MHz

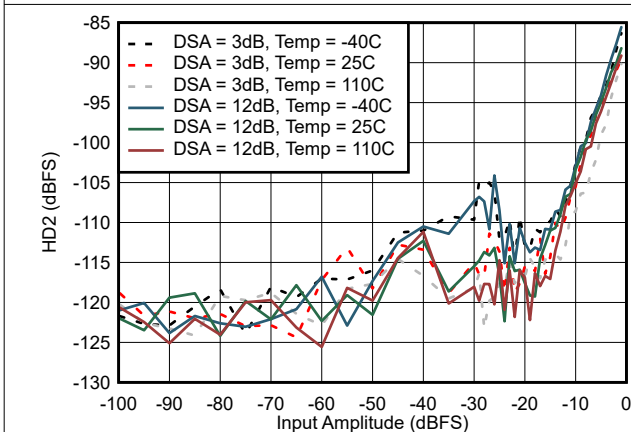

$f_{ADC} = 1500\text{ MSPS}$, $f_{NCO} = 32.13\text{ MHz}$, Decimate by 24x

图 5-25. HD2 vs Input Amplitude at 30 MHz

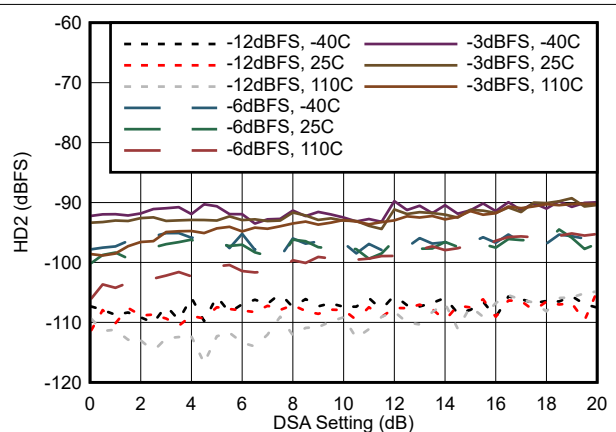

$f_{ADC} = 1500\text{ MSPS}$, $f_{NCO} = 32.$, Decimate by 24x

图 5-26. HD2 vs DSA Setting at 30 MHz

5.12.1 RX Typical Characteristics 30 MHz and 400 MHz (continued)

Typical values at $T_A = +25^\circ\text{C}$. Default conditions at 30MHz: ADC Sampling Rate = 1500 MSPS, output sample rate = 62.5 MSPS (decimate by 24x), PLL clock mode with $f_{\text{REF}} = 500$ MHz, $A_{\text{IN}} = -3$ dBFS, DSA setting = 3 dB. Default conditions at 400 MHz: ADC Sampling Rate = 1500 MSPS, output sample rate = 125 MSPS (decimate by 12x), PLL clock mode with $f_{\text{REF}} = 500$ MHz, $A_{\text{IN}} = -3$ dBFS, DSA setting = 3 dB.

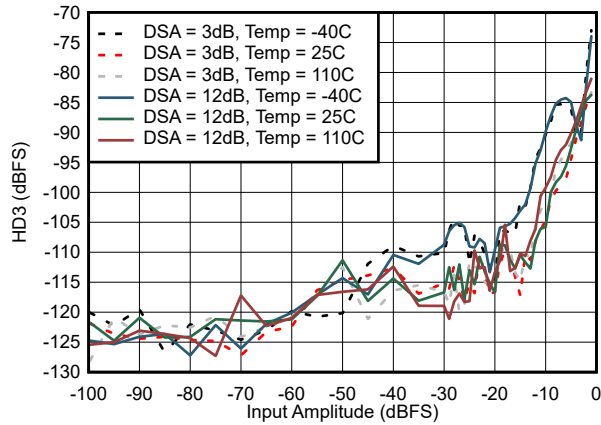

$f_{\text{ADC}} = 1500$ MSPS, $f_{\text{NCO}} = 32.13$ MHz, Decimate by 24x

图 5-27. HD3 vs Input Amplitude at 30 MHz

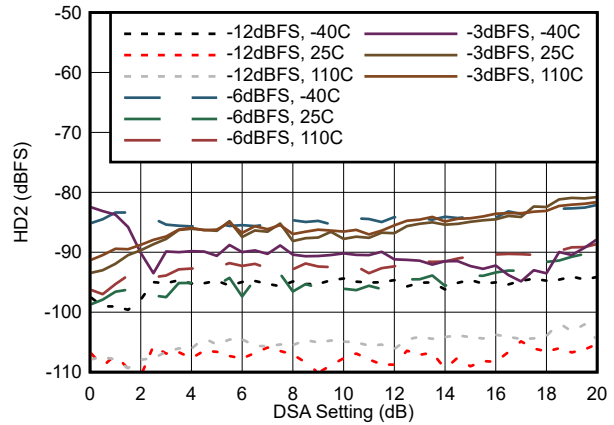

$f_{\text{ADC}} = 1500$ MSPS, $f_{\text{NCO}} = 32.13$ MHz, Decimate by 24x

图 5-28. HD3 vs DSA Setting at 30 MHz

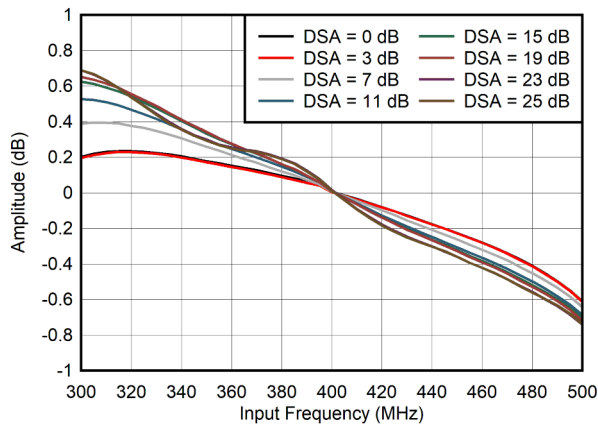

Normalized to 4000 MHz

图 5-29. RX In-Band Gain Flatness, $f_{\text{IN}} = 400$ MHz

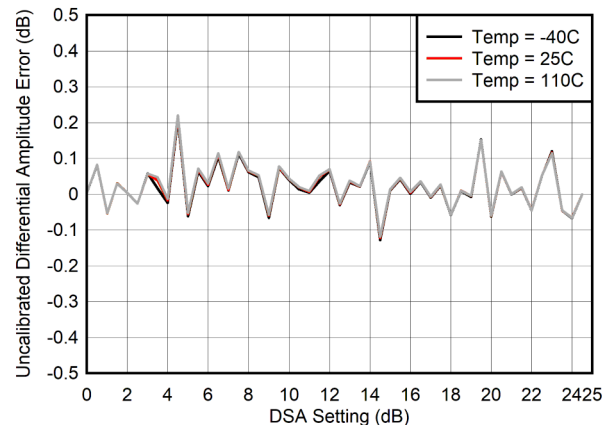

$$\text{Differential Amplitude Error} = P_{\text{IN}}(\text{DSA Setting} - 1) - P_{\text{IN}}(\text{DSA Setting} + 1)$$

图 5-30. RX Uncalibrated Differential Amplitude Error vs DSA Setting at 30 MHz

5.12.1 RX Typical Characteristics 30 MHz and 400 MHz (continued)

Typical values at $T_A = +25^\circ\text{C}$. Default conditions at 30MHz: ADC Sampling Rate = 1500 MSPS, output sample rate = 62.5 MSPS (decimate by 24x), PLL clock mode with $f_{REF} = 500$ MHz, $A_{IN} = -3$ dBFS, DSA setting = 3 dB. Default conditions at 400 MHz: ADC Sampling Rate = 1500 MSPS, output sample rate = 125 MSPS (decimate by 12x), PLL clock mode with $f_{REF} = 500$ MHz, $A_{IN} = -3$ dBFS, DSA setting = 3 dB.

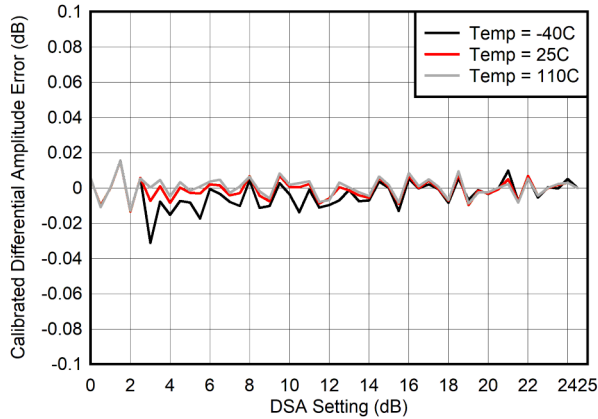

$$\text{Differential Amplitude Error} = P_{IN}(\text{DSA Setting} - 1) - P_{IN}(\text{DSA Setting}) + 1$$

图 5-31. RX Calibrated Differential Amplitude Error vs DSA Setting at 400 MHz

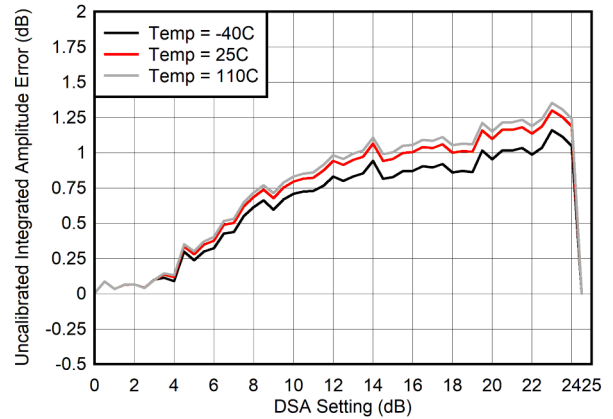

$$\text{Integrated Amplitude Error} = P_{IN}(\text{DSA Setting}) - P_{IN}(\text{DSA Setting} = 0) + (\text{DSA Setting})$$

图 5-32. RX Uncalibrated Integrated Amplitude Error vs DSA Setting at 400 MHz

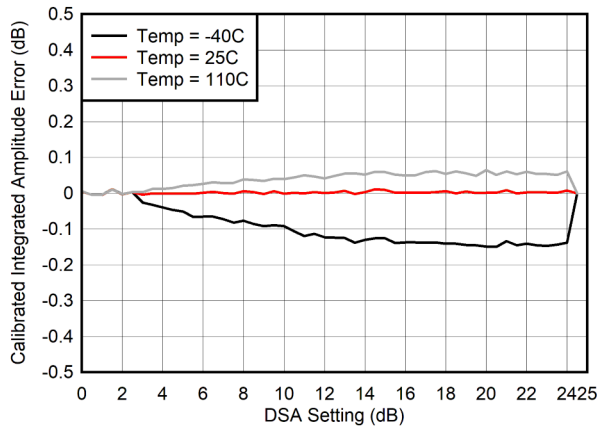

$$\text{Integrated Amplitude Error} = P_{IN}(\text{DSA Setting}) - P_{IN}(\text{DSA Setting} = 0) + (\text{DSA Setting})$$

图 5-33. RX Calibrated Integrated Amplitude Error vs DSA Setting at 400 MHz

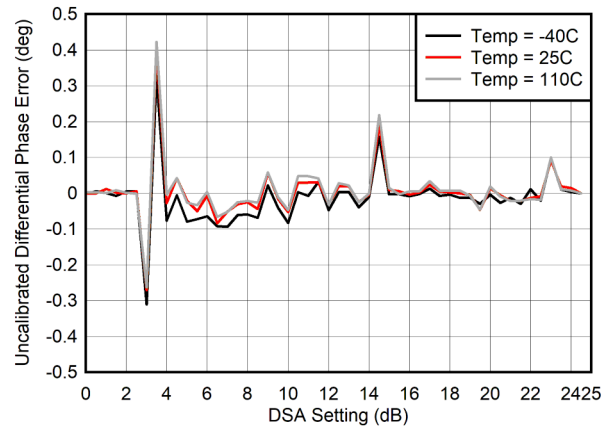

$$\text{Differential Phase Error} = \text{Phase}_{IN}(\text{DSA Setting} - 1) - \text{Phase}_{IN}(\text{DSA Setting})$$

图 5-34. RX Uncalibrated Differential Phase Error vs DSA Setting at 400 MHz

5.12.1 RX Typical Characteristics 30 MHz and 400 MHz (continued)

Typical values at $T_A = +25^\circ\text{C}$. Default conditions at 30MHz: ADC Sampling Rate = 1500 MSPS, output sample rate = 62.5 MSPS (decimate by 24x), PLL clock mode with $f_{REF} = 500$ MHz, $A_{IN} = -3$ dBFS, DSA setting = 3 dB. Default conditions at 400 MHz: ADC Sampling Rate = 1500 MSPS, output sample rate = 125 MSPS (decimate by 12x), PLL clock mode with $f_{REF} = 500$ MHz, $A_{IN} = -3$ dBFS, DSA setting = 3 dB.

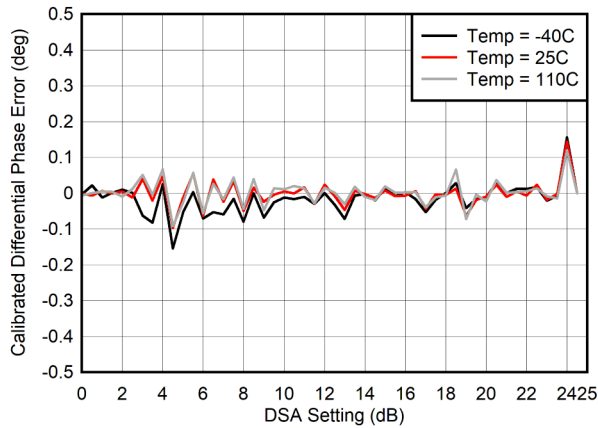

$$\text{Differential Phase Error} = \text{Phase}_{IN}(\text{DSA Setting} - 1) - \text{Phase}_{IN}(\text{DSA Setting})$$

图 5-35. RX Calibrated Differential Phase Error vs DSA Setting at 400 MHz

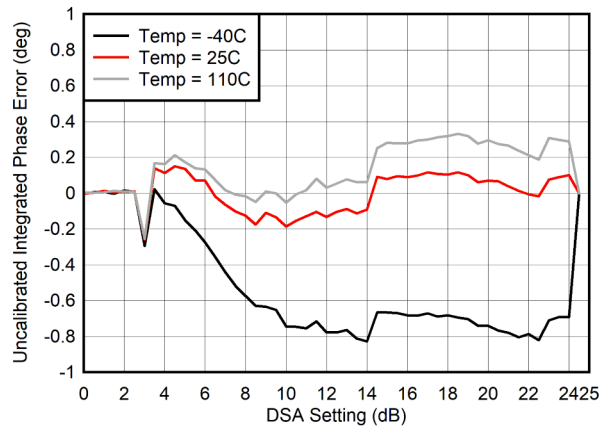

$$\text{Integrated Phase Error} = \text{Phase}(\text{DSA Setting}) - \text{Phase}(\text{DSA Setting} = 0)$$

图 5-36. RX Uncalibrated Integrated Phase Error vs DSA Setting at 400 MHz

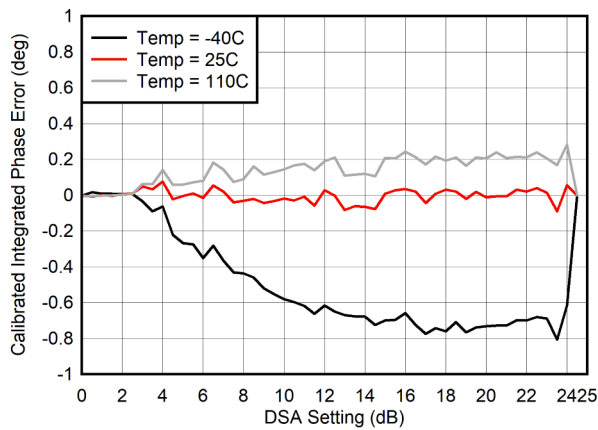

$$\text{Integrated Phase Error} = \text{Phase}(\text{DSA Setting}) - \text{Phase}(\text{DSA Setting} = 0)$$

图 5-37. RX Calibrated Integrated Phase Error vs DSA Setting at 400 MHz

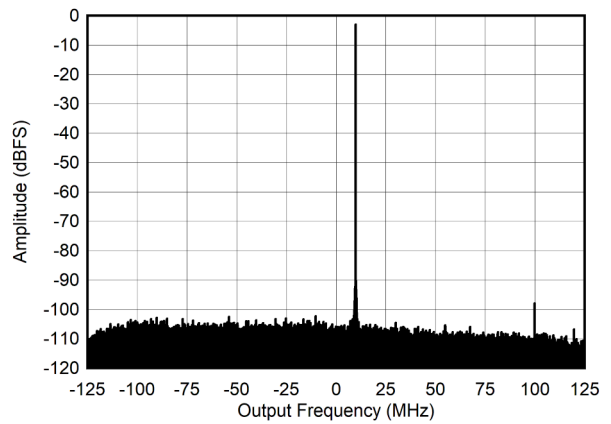

$f_{NCO} = 400\text{MHz}$

图 5-38. RX Output FFT at 405 MHz and -3dBFS

5.12.1 RX Typical Characteristics 30 MHz and 400 MHz (continued)

Typical values at $T_A = +25^\circ\text{C}$. Default conditions at 30MHz: ADC Sampling Rate = 1500 MSPS, output sample rate = 62.5 MSPS (decimate by 24x), PLL clock mode with $f_{\text{REF}} = 500$ MHz, $A_{\text{IN}} = -3$ dBFS, DSA setting = 3 dB. Default conditions at 400 MHz: ADC Sampling Rate = 1500 MSPS, output sample rate = 125 MSPS (decimate by 12x), PLL clock mode with $f_{\text{REF}} = 500$ MHz, $A_{\text{IN}} = -3$ dBFS, DSA setting = 3 dB.

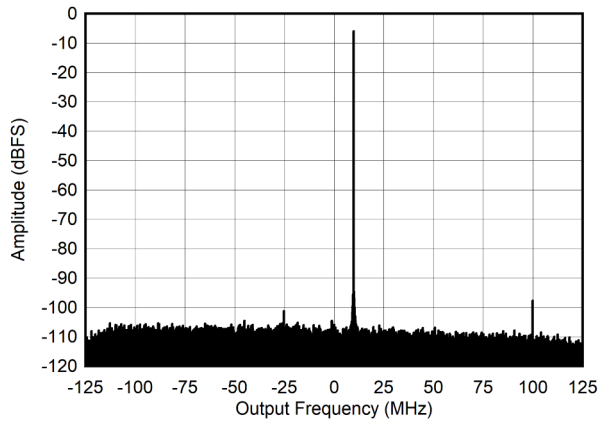

$f_{\text{NCO}} = 400\text{MHz}$

图 5-39. RX Output FFT at 405 MHz and -6dBFS

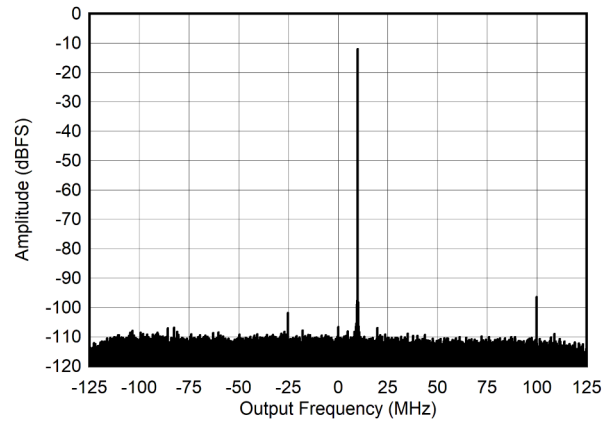

$f_{\text{NCO}} = 400\text{MHz}$

图 5-40. RX Output FFT at 405 MHz and -12dBFS

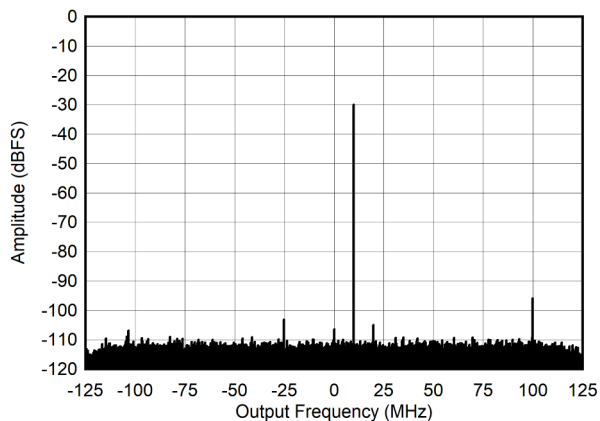

$f_{\text{NCO}} = 400\text{MHz}$

图 5-41. RX Output FFT at 405 MHz and -30dBFS

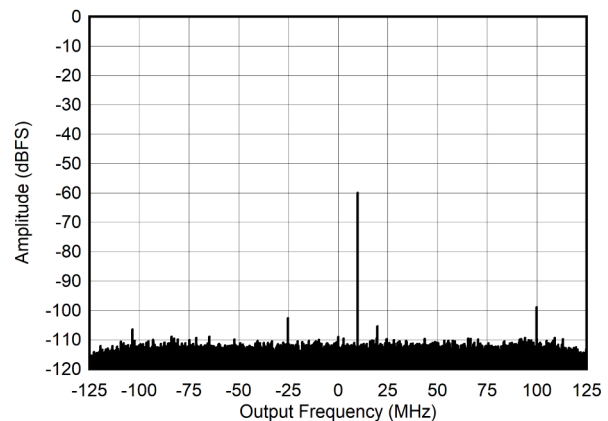

$f_{\text{NCO}} = 400\text{MHz}$

图 5-42. RX Output FFT at 405 MHz and -60dBFS

5.12.1 RX Typical Characteristics 30 MHz and 400 MHz (continued)

Typical values at $T_A = +25^\circ\text{C}$. Default conditions at 30MHz: ADC Sampling Rate = 1500 MSPS, output sample rate = 62.5 MSPS (decimate by 24x), PLL clock mode with $f_{REF} = 500\text{ MHz}$, $A_{IN} = -3\text{ dBFS}$, DSA setting = 3 dB. Default conditions at 400 MHz: ADC Sampling Rate = 1500 MSPS, output sample rate = 125 MSPS (decimate by 12x), PLL clock mode with $f_{REF} = 500\text{ MHz}$, $A_{IN} = -3\text{ dBFS}$, DSA setting = 3 dB.



图 5-43. NSD vs Input Amplitude at 400MHz



图 5-44. NSD vs DSA Setting at 400MHz

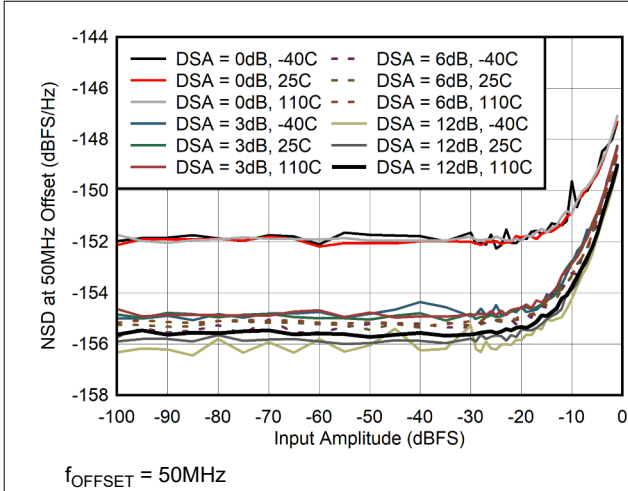

图 5-45. IMD3 vs Input Amplitude at 400MHz

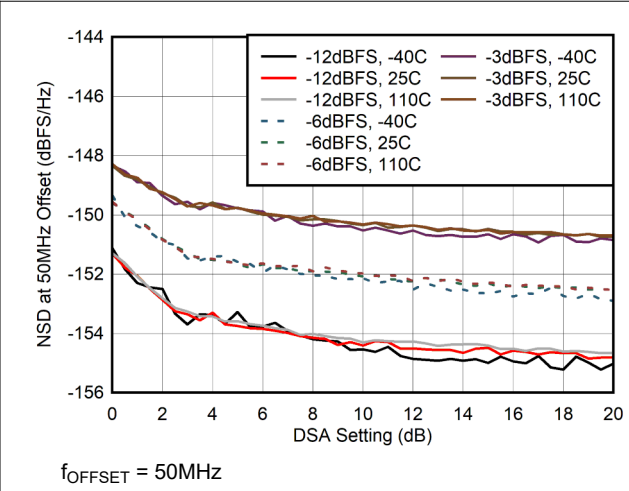

图 5-46. IMD3 vs DSA Setting at 400MHz

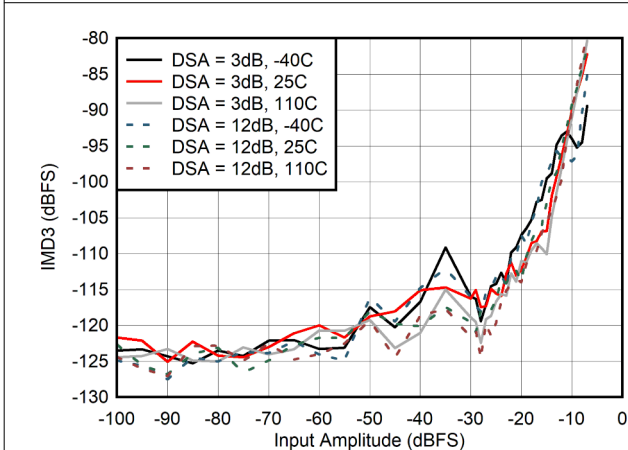

图 5-47. IMD3 vs Tone Spacing at 400MHz

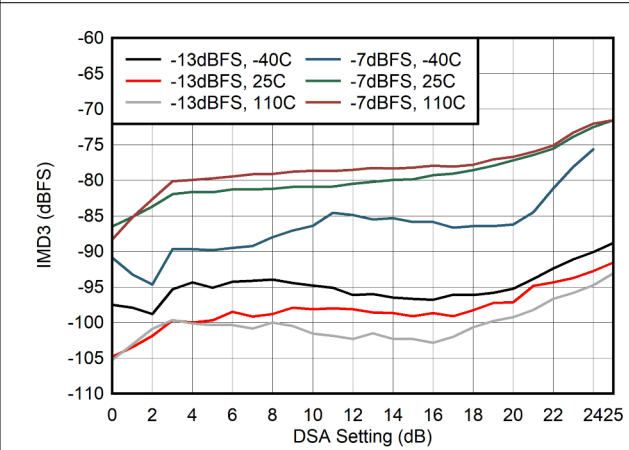

图 5-48. HD3 vs Input Amplitude at 400MHz

5.12.1 RX Typical Characteristics 30 MHz and 400 MHz (continued)

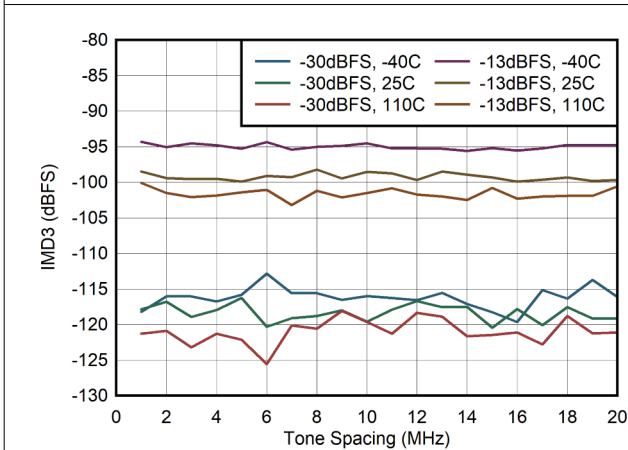
Typical values at $T_A = +25^\circ\text{C}$. Default conditions at 30MHz: ADC Sampling Rate = 1500 MSPS, output sample rate = 62.5 MSPS (decimate by 24x), PLL clock mode with $f_{\text{REF}} = 500$ MHz, $A_{\text{IN}} = -3$ dBFS, DSA setting = 3 dB. Default conditions at 400 MHz: ADC Sampling Rate = 1500 MSPS, output sample rate = 125 MSPS (decimate by 12x), PLL clock mode with $f_{\text{REF}} = 500$ MHz, $A_{\text{IN}} = -3$ dBFS, DSA setting = 3 dB.

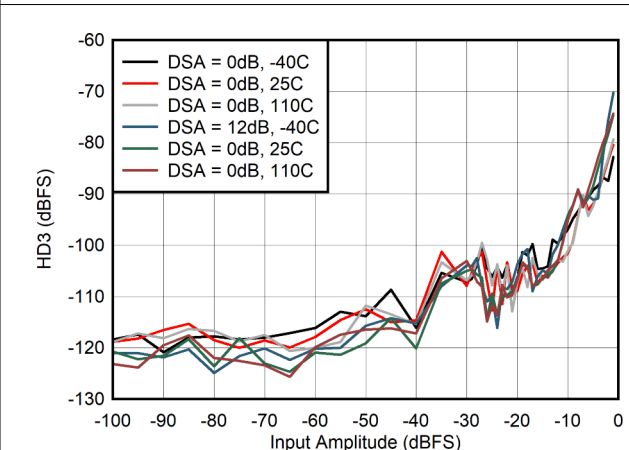

图 5-49. HD3 vs DSA Setting at 400MHz

5.12.2 RX Typical Characteristics at 800MHz

Typical values at $T_A = +25^\circ\text{C}$, ADC Sampling Rate = 2949.12 GHz. Default conditions: output sample rate = 491.52MSPS (decimate by 6), PLL clock mode with $f_{REF} = 491.52\text{MHz}$, $A_{IN} = -3 \text{ dBFS}$, DSA setting = 4 dB.

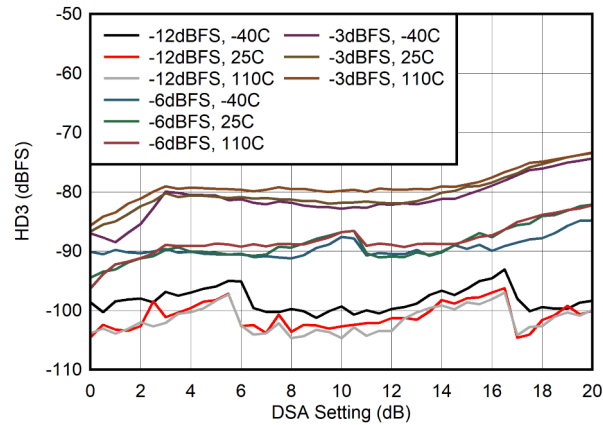
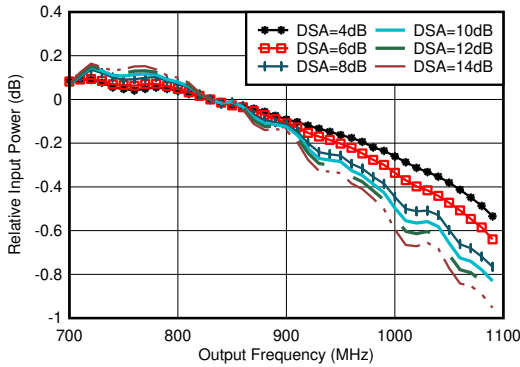

With 0.8 GHz matching, normalized to 830 MHz

图 5-50. RX In-Band Gain Flatness for Channel 1RX, $f_{IN} = 830$ MHz

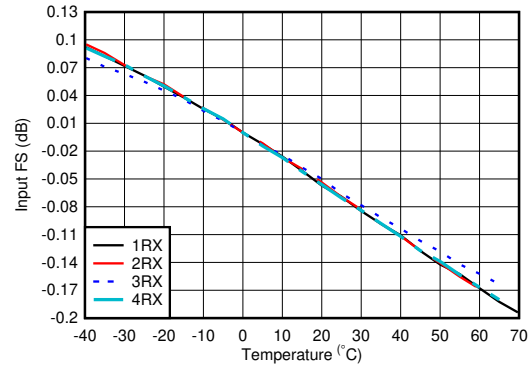

With 0.8 GHz matching, normalized to fullscale at 25°C for each channel

图 5-51. RX Input Fullscale vs Temperature and Channel at 800MHz

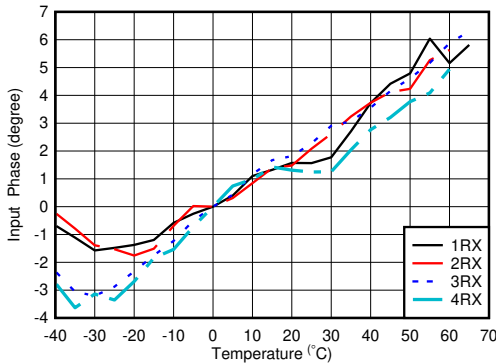

With 0.8 GHz matching, normalized to phase at 25°C

图 5-52. RX Input Phase vs Temperature and DSA at $f_{OUT} = 0.8$ GHz

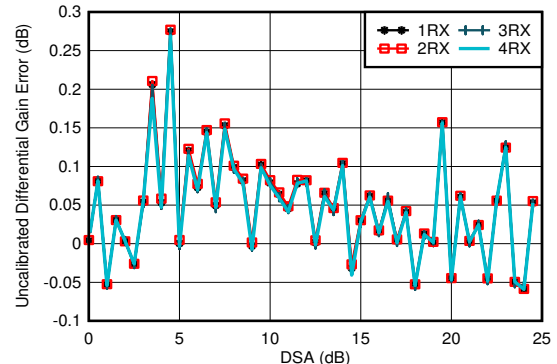

With 0.8 GHz matching

$$\text{Differential Amplitude Error} = P_{IN}(\text{DSA Setting} - 1) - P_{IN}(\text{DSA Setting}) + 1$$

图 5-53. RX Uncalibrated Differential Amplitude Error vs DSA Setting at 0.8 GHz

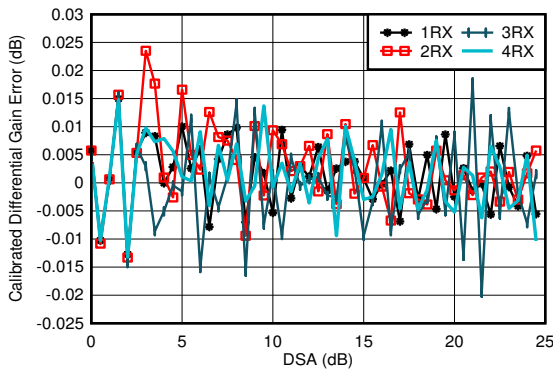

With 0.8 GHz matching

$$\text{Differential Amplitude Error} = P_{IN}(\text{DSA Setting} - 1) - P_{IN}(\text{DSA Setting}) + 1$$

图 5-54. RX Calibrated Differential Amplitude Error vs DSA Setting at 0.8 GHz

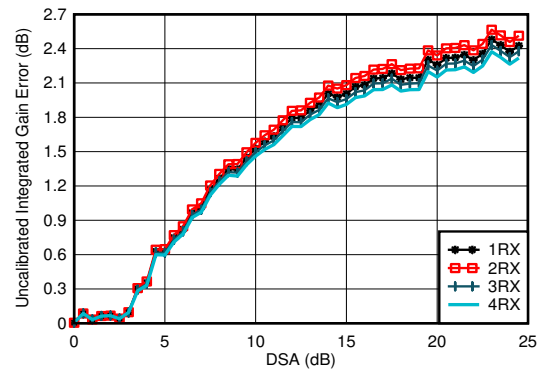

With 0.8 GHz matching

$$\text{Integrated Amplitude Error} = P_{IN}(\text{DSA Setting}) - P_{IN}(\text{DSA Setting} = 0) + (\text{DSA Setting})$$

图 5-55. RX Uncalibrated Integrated Amplitude Error vs DSA Setting at 0.8 GHz

5.12.2 RX Typical Characteristics at 800MHz (continued)

Typical values at $T_A = +25^\circ\text{C}$, ADC Sampling Rate = 2949.12 GHz. Default conditions: output sample rate = 491.52MSPS (decimate by 6), PLL clock mode with $f_{REF} = 491.52\text{MHz}$, $A_{IN} = -3 \text{ dBFS}$, DSA setting = 4 dB.

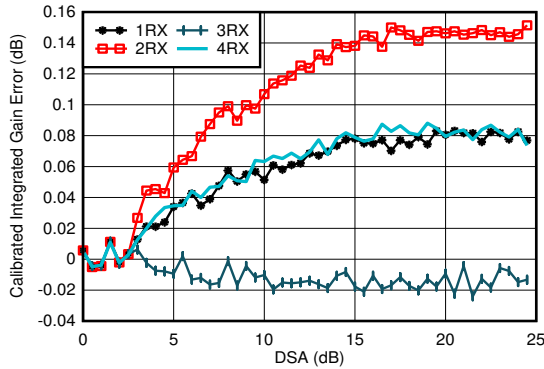

With 0.8 GHz matching

$$\text{Integrated Amplitude Error} = P_{IN}(\text{DSA Setting}) - P_{IN}(\text{DSA Setting} = 0) + (\text{DSA Setting})$$

图 5-56. RX Calibrated Integrated Amplitude Error vs DSA Setting at 2.6 GHz

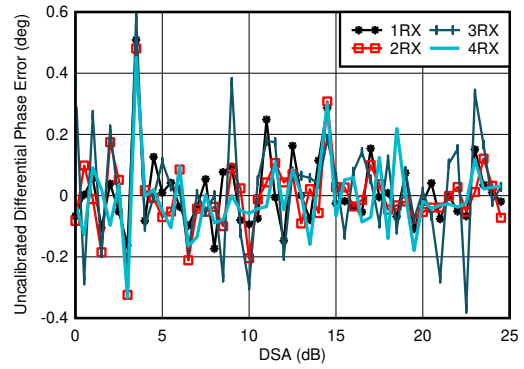

With 0.8 GHz matching

$$\text{Differential Phase Error} = \text{Phase}_{IN}(\text{DSA Setting} - 1) - \text{Phase}_{IN}(\text{DSA Setting})$$

图 5-57. RX Uncalibrated Differential Phase Error vs DSA Setting at 0.8 GHz

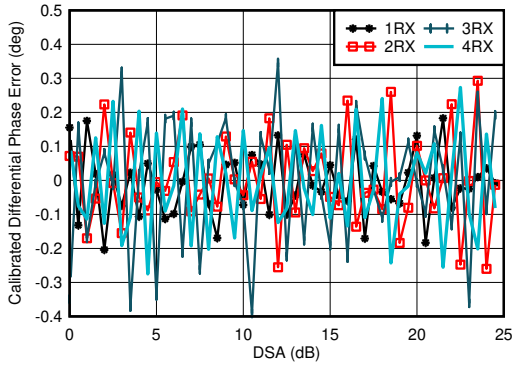

With 0.8 GHz matching

$$\text{Differential Phase Error} = \text{Phase}_{IN}(\text{DSA Setting} - 1) - \text{Phase}_{IN}(\text{DSA Setting})$$

图 5-58. RX Calibrated Differential Phase Error vs DSA Setting at 0.8 GHz

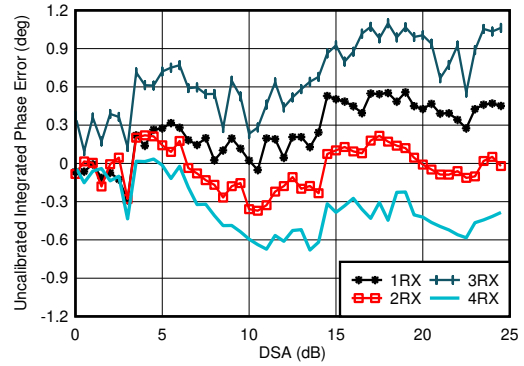

With 0.8 GHz matching

$$\text{Integrated Phase Error} = \text{Phase}(\text{DSA Setting}) - \text{Phase}(\text{DSA Setting} = 0)$$

图 5-59. RX Uncalibrated Integrated Phase Error vs DSA Setting at 0.8 GHz

5.12.2 RX Typical Characteristics at 800MHz (continued)

Typical values at $T_A = +25^\circ\text{C}$, ADC Sampling Rate = 2949.12 GHz. Default conditions: output sample rate = 491.52MSPS (decimate by 6), PLL clock mode with $f_{REF} = 491.52\text{MHz}$, $A_{IN} = -3 \text{ dBFS}$, DSA setting = 4 dB.

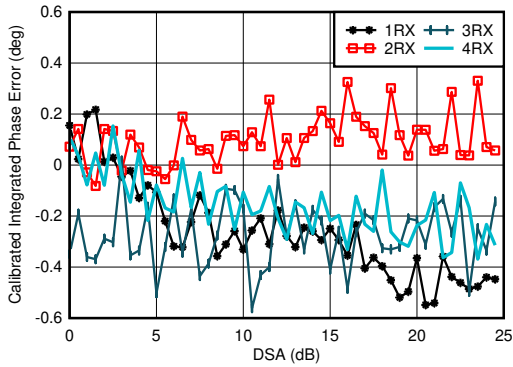

With 0.8 GHz matching
Integrated Phase Error = Phase(DSA Setting) - Phase(DSA Setting = 0)

图 5-60. RX Calibrated Integrated Phase Error vs DSA Setting at 0.8 GHz

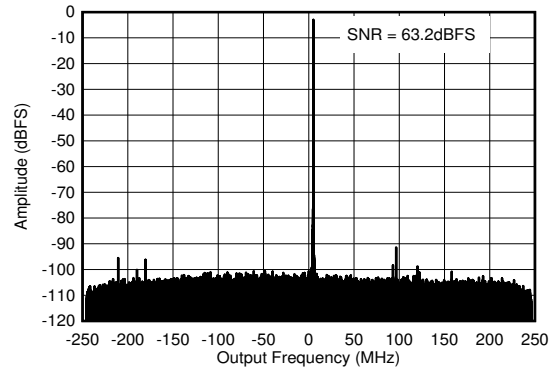

With 0.8 GHz matching, $f_{IN} = 840 \text{ MHz}$, $A_{IN} = -3 \text{ dBFS}$

图 5-61. RX Output FFT at 0.8 GHz

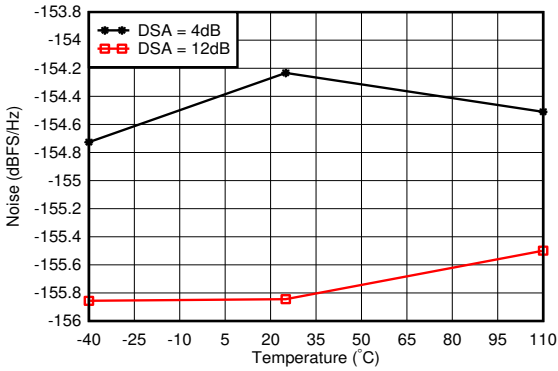

With 0.8 GHz matching, 12.5-MHz offset from tone

图 5-62. RX Noise Spectral Density vs Temperature at 0.8 GHz

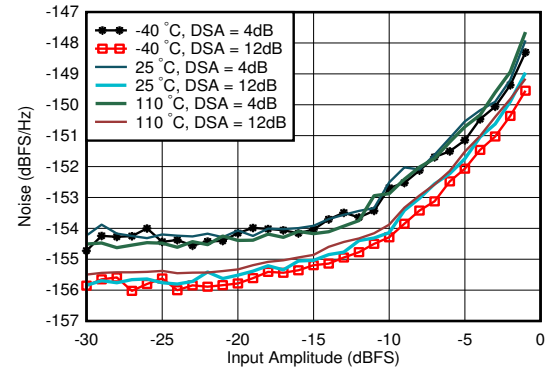

With 0.8 GHz matching, DSA Setting = 12 dB, 12.5-MHz offset from tone

图 5-63. RX Noise Spectral Density vs Input Amplitude and Temperature at 0.8 GHz

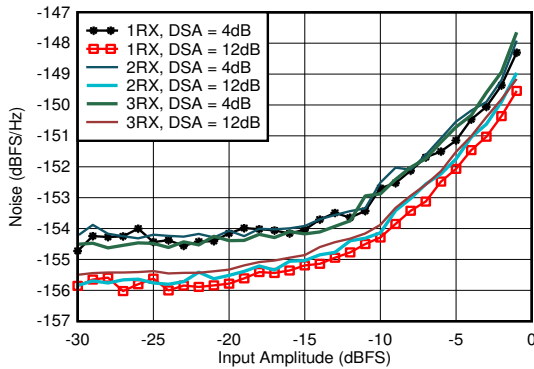

With 0.8 GHz matching, 12.5-MHz offset from tone

图 5-64. RX Noise Spectral Density vs Input Amplitude and Channel at 0.8 GHz

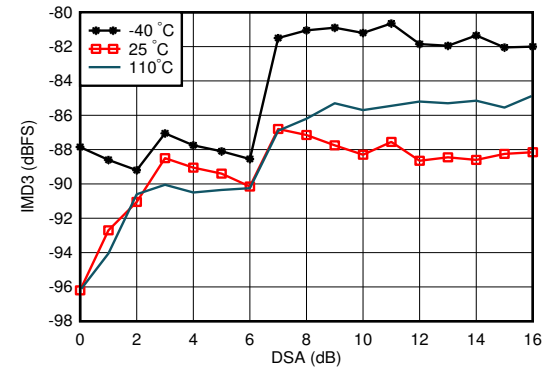

A. With 0.8 GHz matching, each tone -7 dBFS, tone spacing = 20 MHz

图 5-65. RX IMD3 vs DSA Setting and Temperature at 0.8 GHz

5.12.2 RX Typical Characteristics at 800MHz (continued)

Typical values at $T_A = +25^\circ\text{C}$, ADC Sampling Rate = 2949.12 GHz. Default conditions: output sample rate = 491.52MSPS (decimate by 6), PLL clock mode with $f_{REF} = 491.52\text{MHz}$, $A_{IN} = -3\text{ dBFS}$, DSA setting = 4 dB.

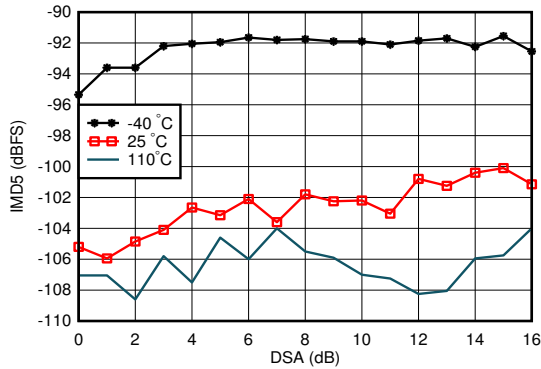

With 0.8 GHz matching, each tone -7 dBFS, tone spacing = 20 MHz

图 5-66. RX IMD5 vs DSA Setting and Temperature at 0.8 GHz

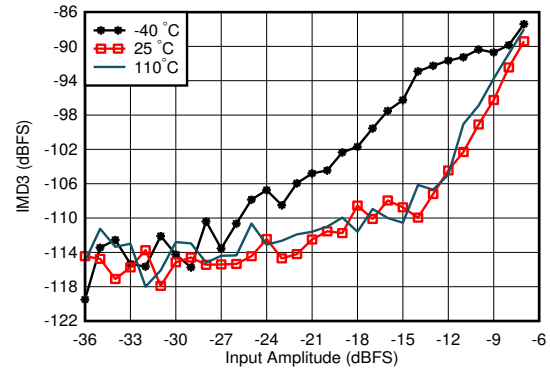

With 0.8 GHz matching, tone spacing = 20 MHz, DSA = 4 dB

图 5-67. RX IMD3 vs Input Level and Temperature at 0.8 GHz

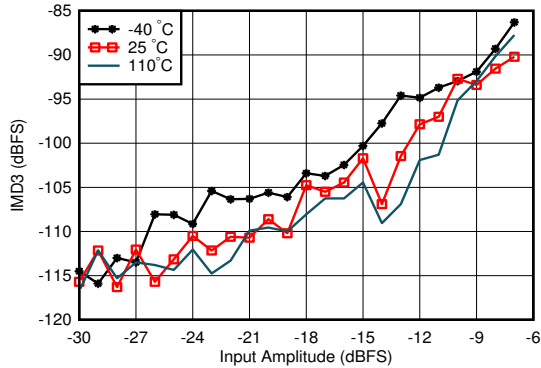

With 0.8 GHz matching, tone spacing = 20 MHz, DSA = 12 dB

图 5-68. RX IMD3 vs Input Level and Temperature at 0.8 GHz

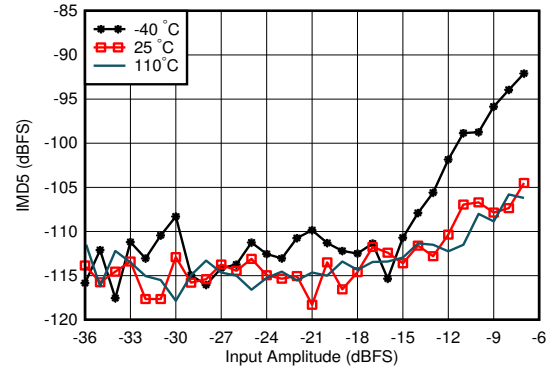

With 0.8 GHz matching, tone spacing = 20 MHz, DSA = 12 dB

图 5-69. RX IMD5 vs Input Level and Temperature at 0.8 GHz

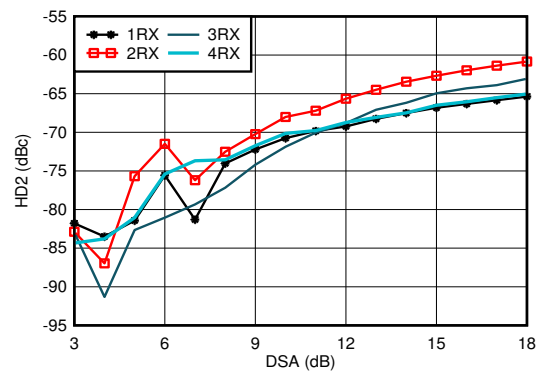

With 0.8 GHz matching, measured after HD2 trim, DDC bypass mode (TI only mode for characterization)

图 5-70. RX HD2 vs DSA Setting and Channel at 0.8 GHz

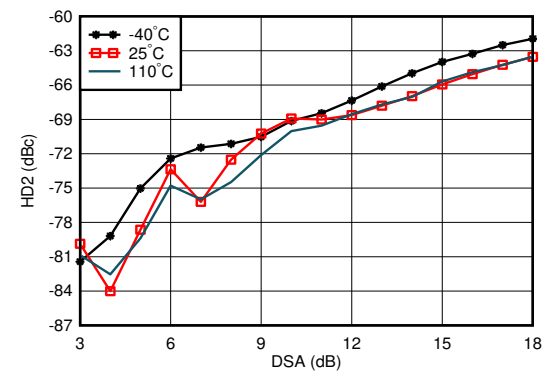

With 0.8 GHz matching, measured after HD2 trim, DDC bypass mode (TI only mode for characterization)

图 5-71. RX HD2 vs DSA Setting and Temperature at 0.8 GHz

5.12.2 RX Typical Characteristics at 800MHz (continued)

Typical values at $T_A = +25^\circ\text{C}$, ADC Sampling Rate = 2949.12 GHz. Default conditions: output sample rate = 491.52MSPS (decimate by 6), PLL clock mode with $f_{REF} = 491.52\text{MHz}$, $A_{IN} = -3 \text{ dBFS}$, DSA setting = 4 dB.

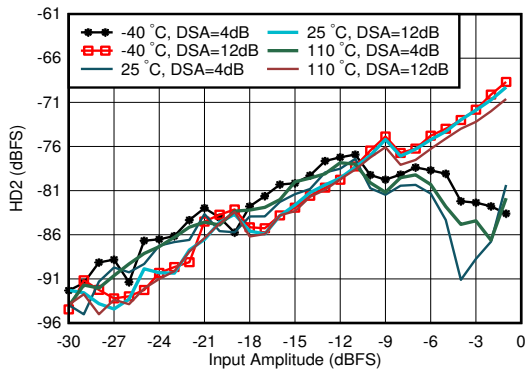

With 0.8 GHz matching, measured after HD2 trim, DDC bypass mode (TI only mode for characterization)

图 5-72. RX HD2 vs Input Level and Temperature at 0.8 GHz

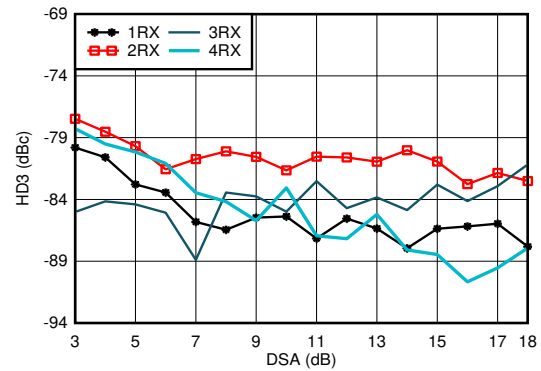

With 0.8 GHz matching, DDC bypass mode (TI only mode for characterization)

图 5-73. RX HD3 vs DSA Setting and Channel at 0.8 GHz

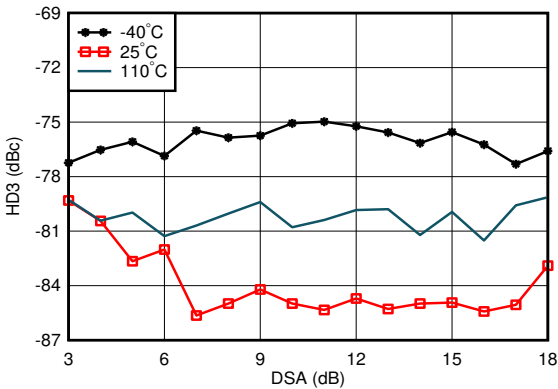

With 0.8 GHz matching, DDC bypass mode (TI only mode for characterization)

图 5-74. RX HD3 vs DSA Setting and Temperature at 0.8 GHz

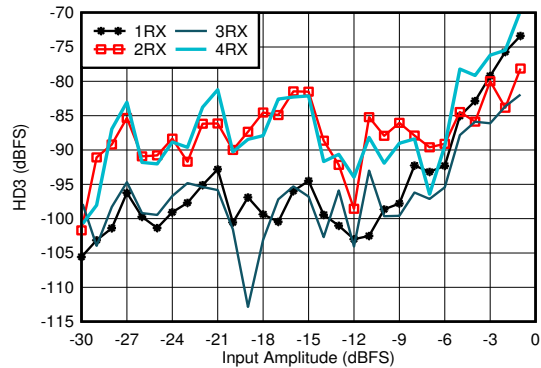

With 0.8 GHz matching, DDC bypass mode (TI only mode for characterization)

图 5-75. RX HD3 vs Input Level and Channel at 0.8 GHz

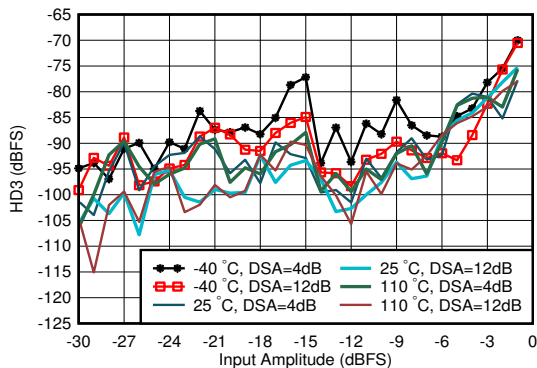

With 0.8 GHz matching, DDC bypass mode (TI only mode for characterization)

图 5-76. RX HD3 vs Input Level and Temperature at 0.8 GHz

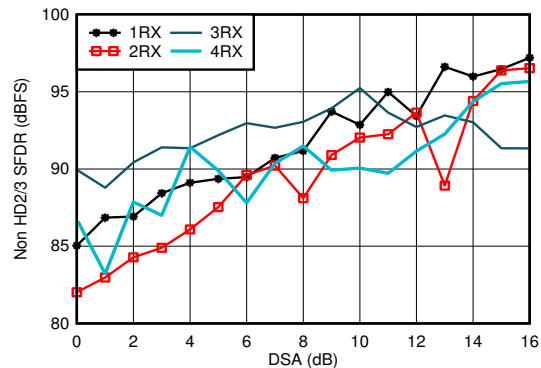

With 0.8 GHz matching

图 5-77. RX Non-HD2/3 vs DSA Setting at 0.8 GHz

5.12.2 RX Typical Characteristics at 800MHz (continued)

Typical values at $T_A = +25^\circ\text{C}$, ADC Sampling Rate = 2949.12 GHz. Default conditions: output sample rate = 491.52MSPS (decimate by 6), PLL clock mode with $f_{REF} = 491.52\text{MHz}$, $A_{IN} = -3 \text{ dBFS}$, DSA setting = 4 dB.

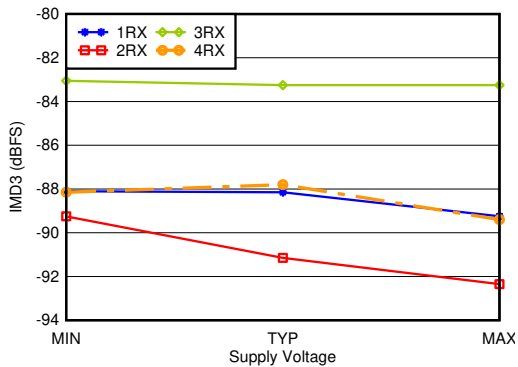

With 0.8 GHz matching, -7 dBFS each tone, 20-MHz tone spacing, all supplies at MIN, TYP, or MAX recommended operating voltages

图 5-78. RX IMD3 vs Supply and Channel at 0.8 GHz

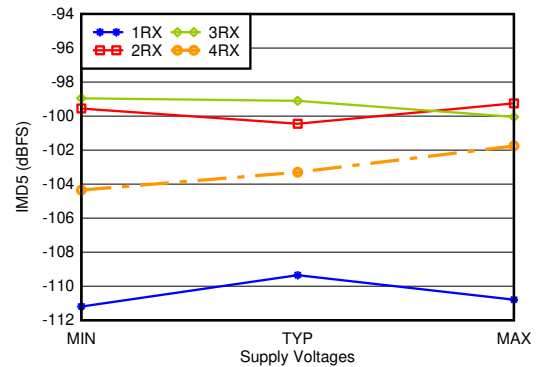

With 0.8 GHz matching, -7 dBFS each tone, 20-MHz tone spacing, all supplies at MIN, TYP, or MAX recommended operating voltages

图 5-79. RX IMD5 vs Supply and Channel at 0.8 GHz

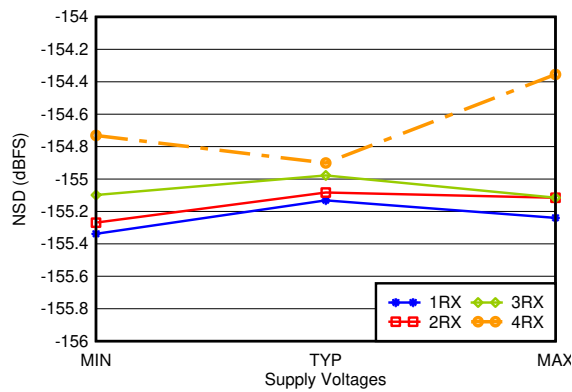

With 0.8 GHz matching, 12.5-MHz offset, all supplies at MIN, TYP, or MAX recommended operating voltages

图 5-80. RX Noise Spectral Density vs Supply and Channel at 0.8 GHz

5.12.3 RX Typical Characteristics 1.75GHz to 1.9GHz

Typical values at $T_A = +25^\circ\text{C}$, ADC Sampling Rate = 2949.12 GHz. Default conditions: output sample rate = 491.52MSPS (decimate by 6), PLL clock mode with $f_{REF} = 491.52\text{MHz}$, $A_{IN} = -3 \text{ dBFS}$, DSA setting = 4 dB.

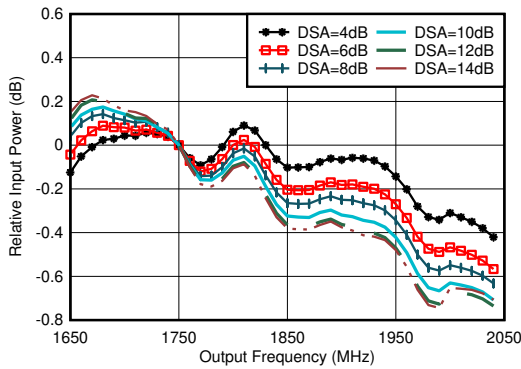

With 1.8 GHz matching, normalized to 1.75 GHz

图 5-81. RX In-Band Gain Flatness, $f_{IN} = 1750 \text{ MHz}$

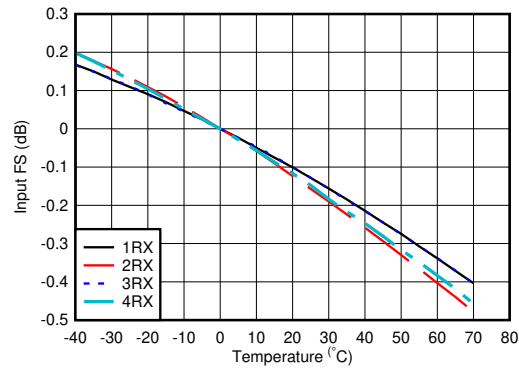

With 1.8 GHz matching, normalized to fullscale at 25°C for each channel

图 5-82. RX Input Fullscale vs Temperature and Channel at 1.75 GHz

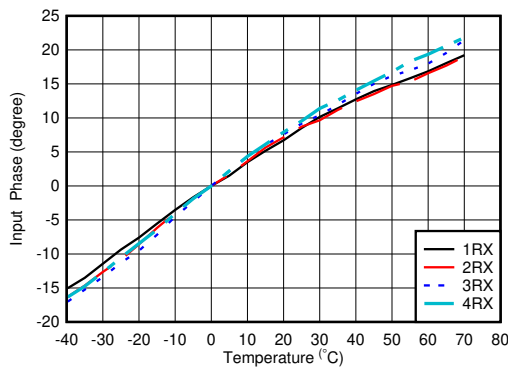

With 2.6 GHz matching, normalized to phase at 25°C

图 5-83. RX Input Phase vs Temperature and DSA at $f_{IN} = 1.75 \text{ GHz}$

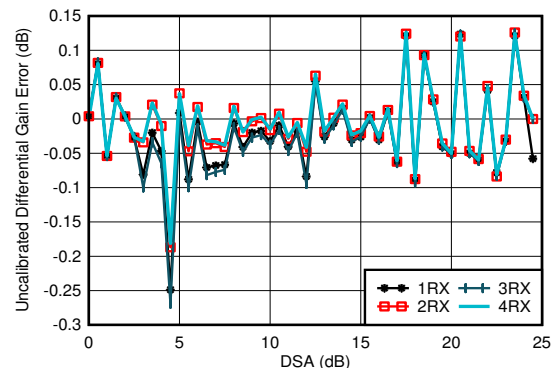

With 1.8 GHz matching

$$\text{Differential Amplitude Error} = P_{IN}(\text{DSA Setting} - 1) - P_{IN}(\text{DSA Setting}) + 1$$

图 5-84. RX Uncalibrated Differential Amplitude Error vs DSA Setting at 1.75 GHz

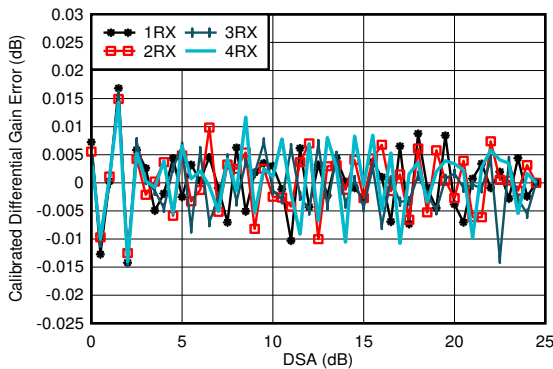

With 1.8 GHz matching

$$\text{Differential Amplitude Error} = P_{IN}(\text{DSA Setting} - 1) - P_{IN}(\text{DSA Setting}) + 1$$

图 5-85. RX Calibrated Differential Amplitude Error vs DSA Setting at 1.75 GHz

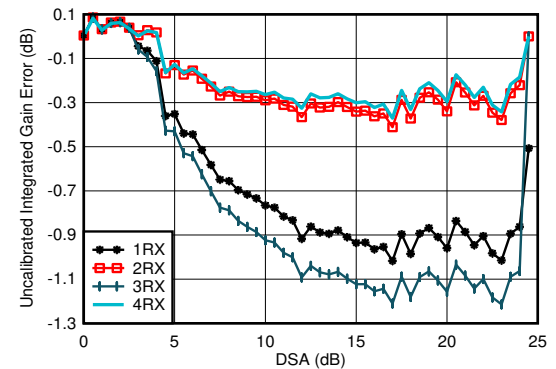

With 1.8 GHz matching

$$\text{Integrated Amplitude Error} = P_{IN}(\text{DSA Setting}) - P_{IN}(\text{DSA Setting} = 0) + (\text{DSA Setting})$$

图 5-86. RX Uncalibrated Integrated Amplitude Error vs DSA Setting at 1.75 GHz

5.12.3 RX Typical Characteristics 1.75GHz to 1.9GHz (continued)

Typical values at $T_A = +25^\circ\text{C}$, ADC Sampling Rate = 2949.12 GHz. Default conditions: output sample rate = 491.52MSPS (decimate by 6), PLL clock mode with $f_{REF} = 491.52\text{MHz}$, $A_{IN} = -3\text{ dBFS}$, DSA setting = 4 dB.

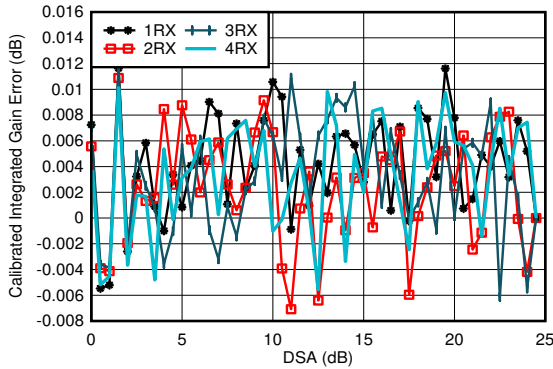

With 1.8 GHz matching

$$\text{Integrated Amplitude Error} = P_{IN}(\text{DSA Setting}) - P_{IN}(\text{DSA Setting} = 0) + (\text{DSA Setting})$$

图 5-87. RX Calibrated Integrated Amplitude Error vs DSA Setting at 1.75 GHz

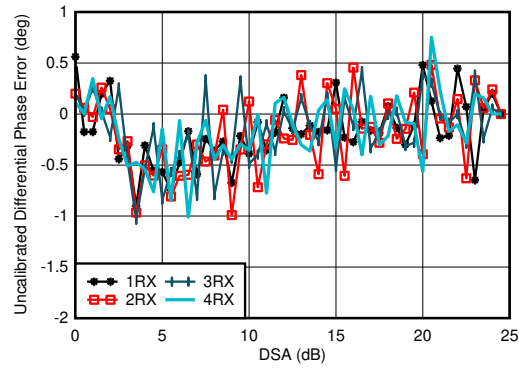

With 1.8 GHz matching

$$\text{Differential Phase Error} = \text{Phase}_{IN}(\text{DSA Setting} - 1) - \text{Phase}_{IN}(\text{DSA Setting})$$

图 5-88. RX Uncalibrated Differential Phase Error vs DSA Setting at 1.75 GHz

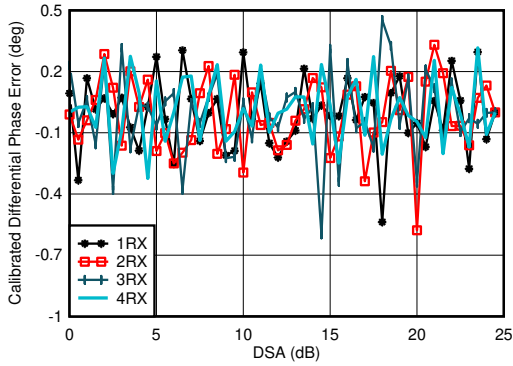

With 1.8 GHz matching

$$\text{Differential Phase Error} = \text{Phase}_{IN}(\text{DSA Setting} - 1) - \text{Phase}_{IN}(\text{DSA Setting})$$

图 5-89. RX Calibrated Differential Phase Error vs DSA Setting at 1.75 GHz

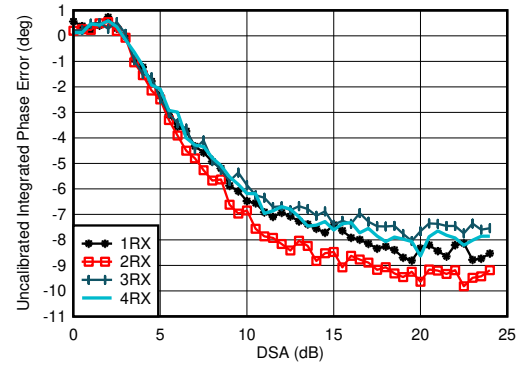

With 1.8 GHz matching

$$\text{Integrated Phase Error} = \text{Phase}(\text{DSA Setting}) - \text{Phase}(\text{DSA Setting} = 0)$$

图 5-90. RX Uncalibrated Integrated Phase Error vs DSA Setting at 1.75 GHz

5.12.3 RX Typical Characteristics 1.75GHz to 1.9GHz (continued)

Typical values at $T_A = +25^\circ\text{C}$, ADC Sampling Rate = 2949.12 GHz. Default conditions: output sample rate = 491.52MSPS (decimate by 6), PLL clock mode with $f_{REF} = 491.52\text{MHz}$, $A_{IN} = -3 \text{ dBFS}$, DSA setting = 4 dB.

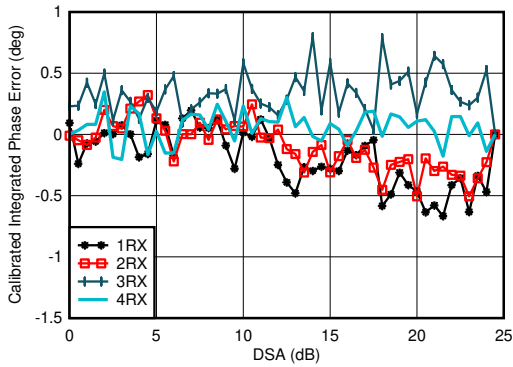

With 1.8 GHz matching
Integrated Phase Error = Phase(DSA Setting) - Phase(DSA Setting = 0)

图 5-91. RX Calibrated Integrated Phase Error vs DSA Setting at 1.75 GHz

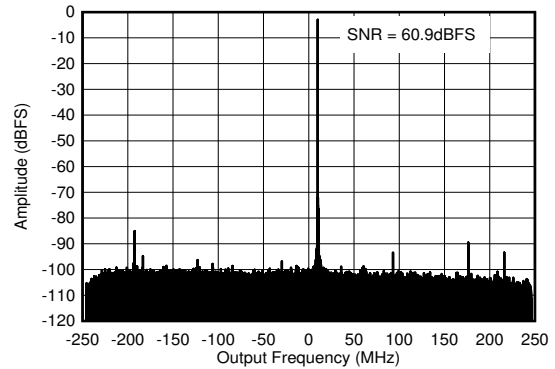

With 1.8 GHz matching, $f_{IN} = 2610 \text{ MHz}$, $A_{IN} = -3 \text{ dBFS}$

图 5-92. RX Output FFT at 1.75 GHz

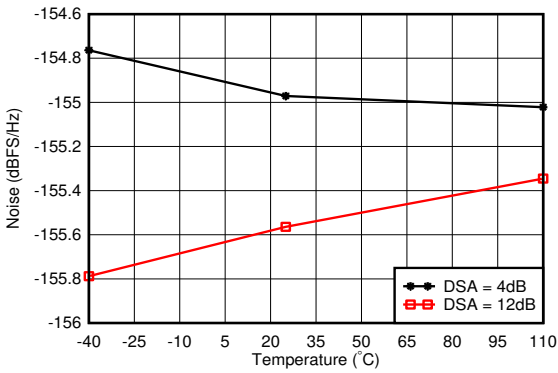

With 1.8 GHz matching, 12.5-MHz offset from tone

图 5-93. RX Noise Spectral Density vs Temperature at 1.75 GHz

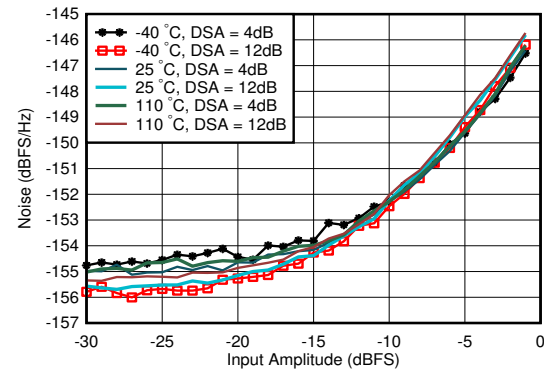

With 1.8 GHz matching, DSA Setting = 12 dB, 12.5-MHz offset from tone

图 5-94. RX Noise Spectral Density vs Input Amplitude and Temperature at 1.75 GHz

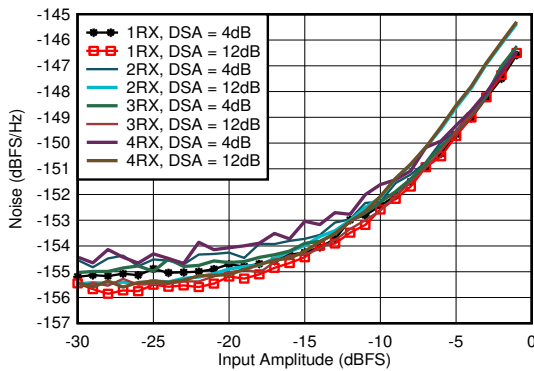

With 1.8 GHz matching, 12.5-MHz offset from tone

图 5-95. RX Noise Spectral Density vs Input Amplitude and Channel at 1.75 GHz

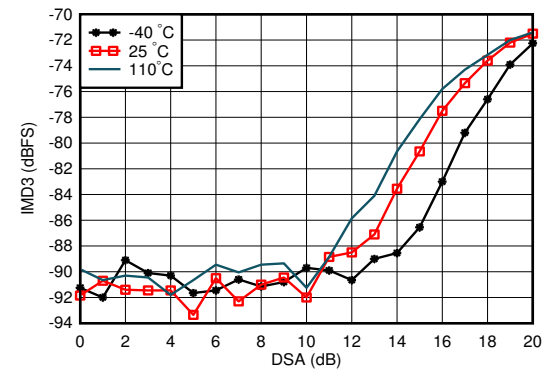

With 1.8 GHz matching, each tone -7 dBFS, tone spacing = 20 MHz

图 5-96. RX IMD3 vs DSA Setting and Temperature at 1.75 GHz

5.12.3 RX Typical Characteristics 1.75GHz to 1.9GHz (continued)

Typical values at $T_A = +25^\circ\text{C}$, ADC Sampling Rate = 2949.12 MHz. Default conditions: output sample rate = 491.52MSPS (decimate by 6), PLL clock mode with $f_{\text{REF}} = 491.52\text{MHz}$, $A_{\text{IN}} = -3 \text{ dBFS}$, DSA setting = 4 dB.

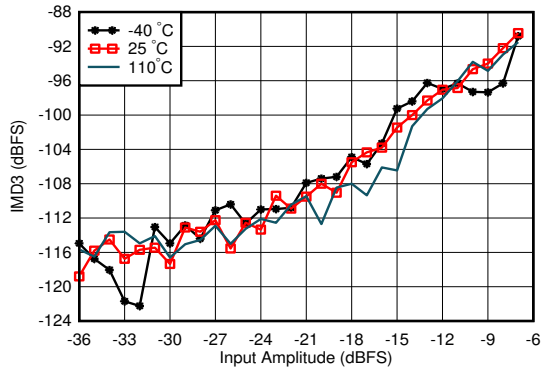

With 1.8 GHz matching, tone spacing = 20 MHz, DSA = 4 dB

图 5-97. RX IMD3 vs Input Level and Temperature at 1.75 GHz

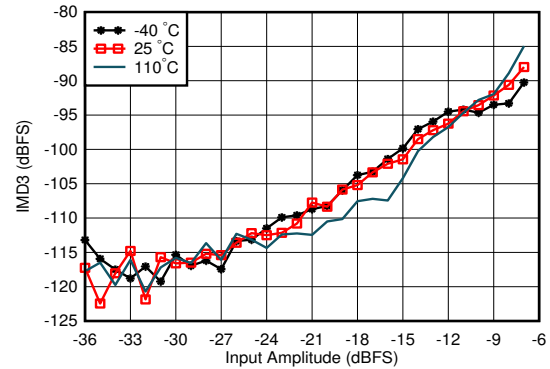

With 1.8 GHz matching, tone spacing = 20 MHz, DSA = 12 dB

图 5-98. RX IMD3 vs Input Level and Temperature at 1.75 GHz

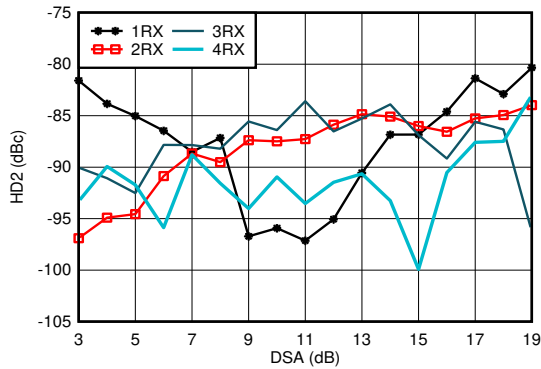

With 1.8 GHz matching, $f_{\text{in}} = 1900\text{MHz}$, measured after HD2 trim, DDC bypass mode (TI only mode for characterization)

图 5-99. RX HD2 vs DSA Setting and Channel at 1.9 GHz

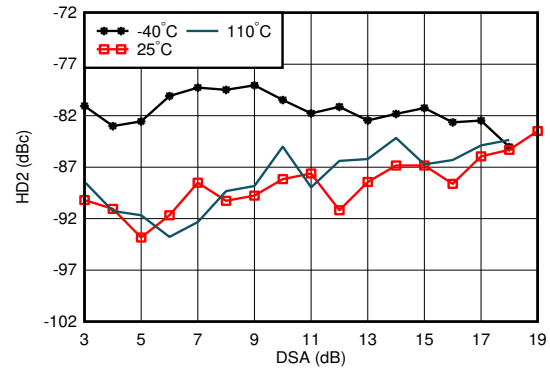

With 1.8 GHz matching, $f_{\text{in}} = 1900\text{MHz}$, measured after HD2 trim, DDC bypass mode (TI only mode for characterization)

图 5-100. RX HD2 vs DSA Setting and Temperature at 1.9 GHz

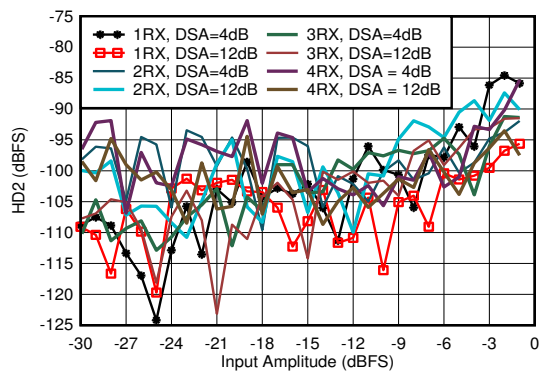

With 1.8 GHz matching, $f_{\text{in}} = 1900\text{MHz}$, measured after HD2 trim, DDC bypass mode (TI only mode for characterization)

图 5-101. RX HD2 vs Input Amplitude and Channel at 1.9 GHz

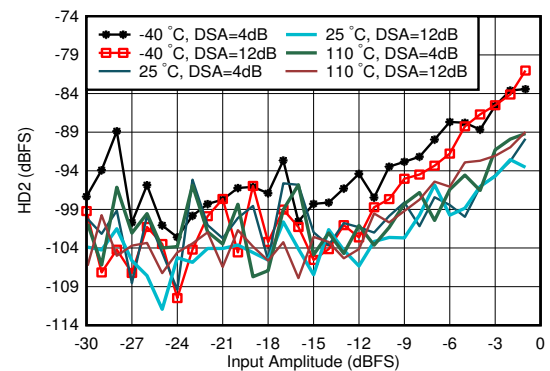

With 1.8 GHz matching, $f_{\text{in}} = 1900\text{MHz}$, measured after HD2 trim, DDC bypass mode (TI only mode for characterization)

图 5-102. RX HD2 vs Input Amplitude and Temperature at 1.9 GHz

5.12.3 RX Typical Characteristics 1.75GHz to 1.9GHz (continued)

Typical values at $T_A = +25^\circ\text{C}$, ADC Sampling Rate = 2949.12 GHz. Default conditions: output sample rate = 491.52MSPS (decimate by 6), PLL clock mode with $f_{REF} = 491.52\text{MHz}$, $A_{IN} = -3 \text{ dBFS}$, DSA setting = 4 dB.

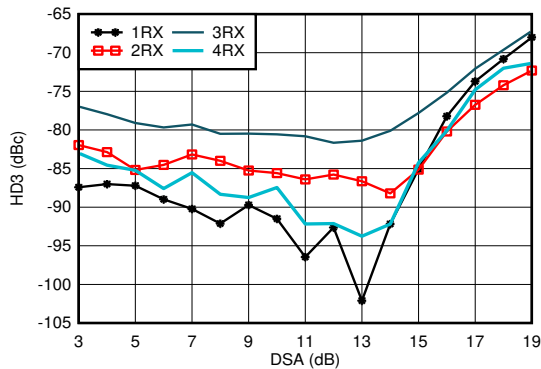

With 1.8 GHz matching, $f_{in} = 1900\text{MHz}$, DDC bypass mode (TI only mode for characterization)

图 5-103. RX HD3 vs DSA Setting and Channel at 1.9 GHz

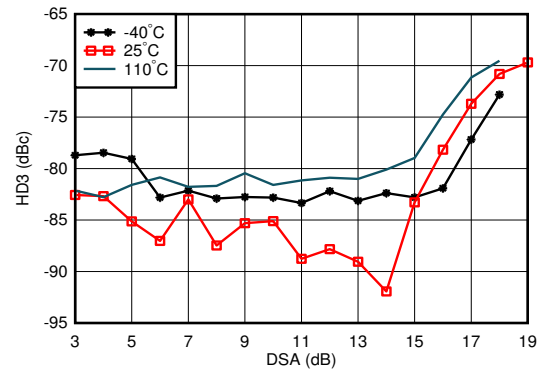

With 1.8 GHz matching, $f_{in} = 1900\text{MHz}$, DDC bypass mode (TI only mode for characterization)

图 5-104. RX HD3 vs DSA Setting and Temperature at 1.9 GHz

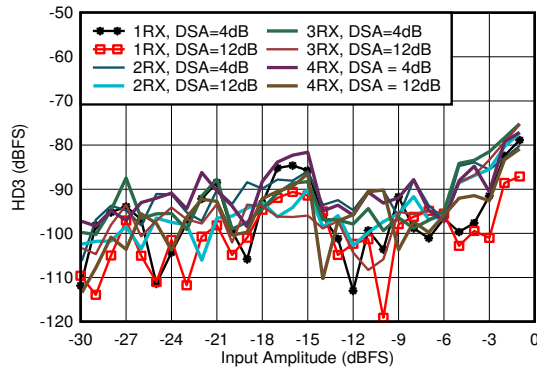

With 1.8 GHz matching, $f_{in} = 1900\text{MHz}$, DDC bypass mode (TI only mode for characterization)

图 5-105. RX HD3 vs Input Level and Channel at 1.9 GHz

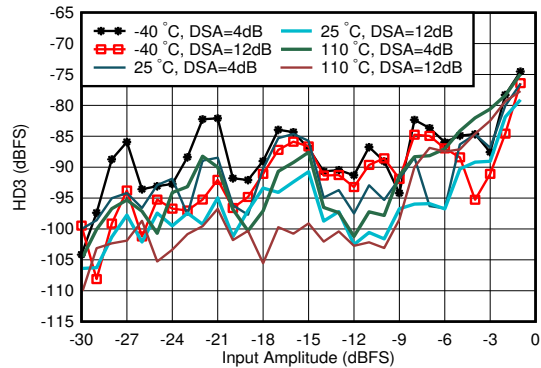

With 1.8 GHz matching, $f_{in} = 1900\text{MHz}$, DDC bypass mode (TI only mode for characterization)

图 5-106. RX HD3 vs Input Level and Temperature at 1.9 GHz

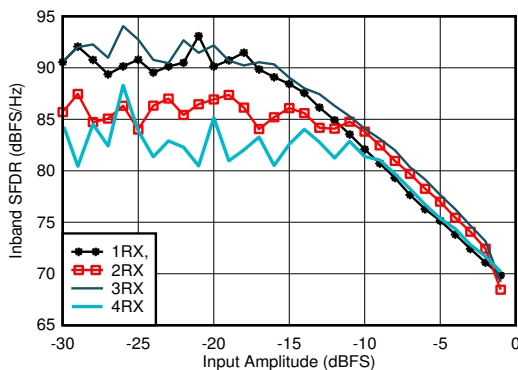

With 1.8 GHz matching, decimated by 3

图 5-107. RX In-Band SFDR ($\pm 400 \text{ MHz}$) vs Input Amplitude at 1.75 GHz

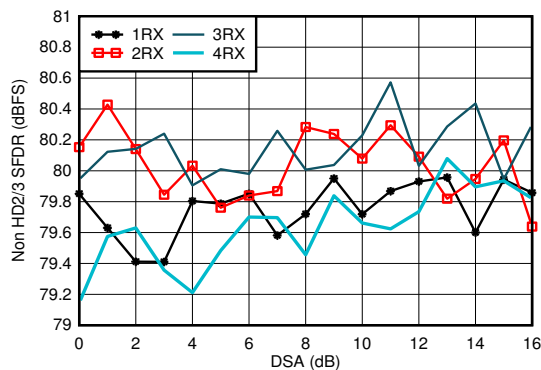

With 1.8 GHz matching

图 5-108. RX Non-HD2/3 vs DSA Setting at 1.75 GHz

5.12.3 RX Typical Characteristics 1.75GHz to 1.9GHz (continued)

Typical values at $T_A = +25^\circ\text{C}$, ADC Sampling Rate = 2949.12 GHz. Default conditions: output sample rate = 491.52MSPS (decimate by 6), PLL clock mode with $f_{REF} = 491.52\text{MHz}$, $A_{IN} = -3 \text{ dBFS}$, DSA setting = 4 dB.

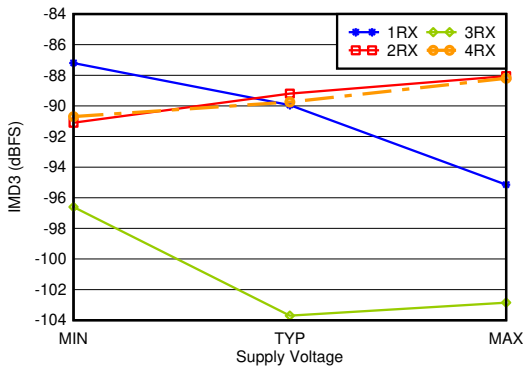

With 1.8 GHz matching, -7 dBFS each tone, 20-MHz tone spacing, all supplies at MIN, TYP, or MAX recommended operating voltages

图 5-109. RX IMD3 vs Supply and Channel at 1.75 GHz

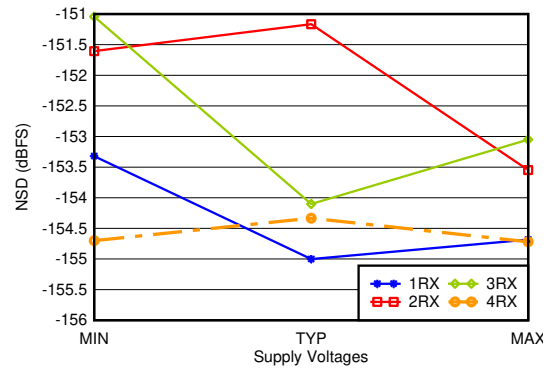

With 1.8 GHz matching, 12.5-MHz offset, all supplies at MIN, TYP, or MAX recommended operating voltages

图 5-110. RX Noise Spectral Density vs Supply and Channel at 1.75 GHz

5.12.4 RX Typical Characteristics 2.6GHz

Typical values at $T_A = +25^\circ\text{C}$, ADC Sampling Rate = 2949.12 MHz. Default conditions: output sample rate = 491.52MSPS (decimate by 6), PLL clock mode with $f_{REF} = 491.52\text{MHz}$, $A_{IN} = -3 \text{ dBFS}$, DSA setting = 4 dB.

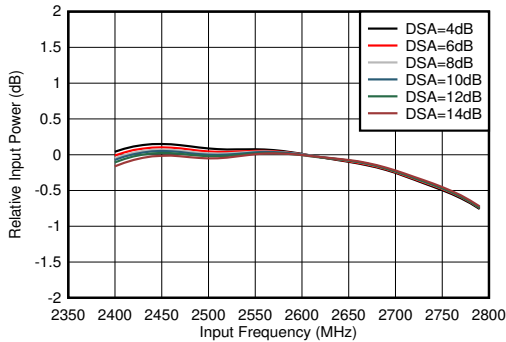

With matching, normalized to power at 2.6 GHz for each DSA setting

图 5-111. RX Inband Gain Flatness, $f_{IN} = 2600 \text{ MHz}$

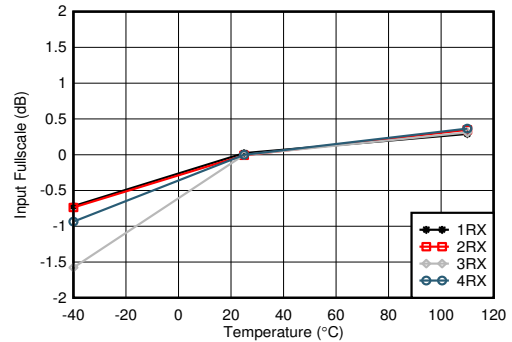

With 2.6 GHz matching, normalized to fullscale at 25°C for each channel

图 5-112. RX Input Fullscale vs Temperature and Channel at 2.6 GHz

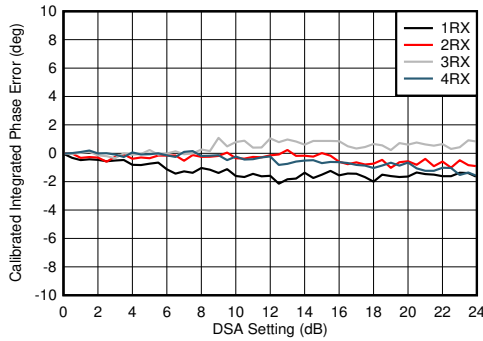

With 2.6 GHz matching
Integrated Phase Error = Phase(DSA Setting) - Phase(DSA Setting = 0)

图 5-113. RX Calibrated Integrated Phase Error vs DSA Setting at 2.6 GHz

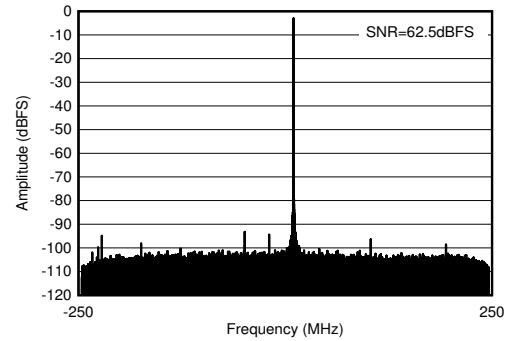

With 2.6 GHz matching, $f_{IN} = 2610 \text{ MHz}$, $A_{IN} = -3 \text{ dBFS}$

图 5-114. RX Output FFT at 2.6 GHz

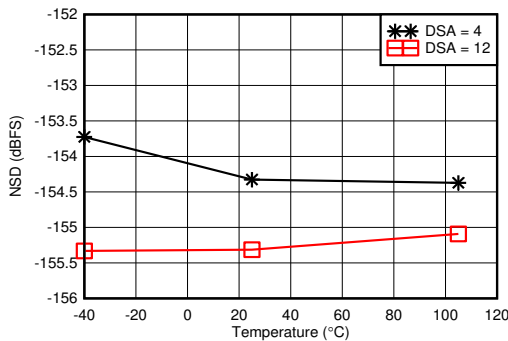

With 2.6 GHz matching, 12.5-MHz offset from tone

图 5-115. RX Noise Spectral Density vs Temperature at 2.6 GHz

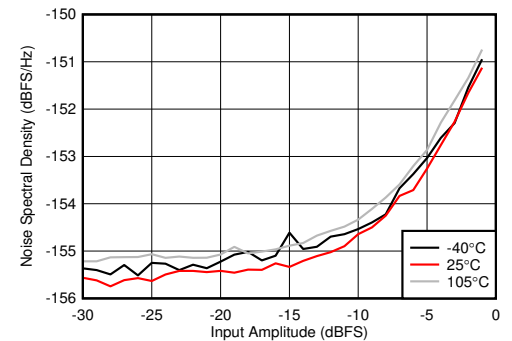

With 2.6 GHz matching, DSA Setting = 12 dB, 12.5-MHz offset from tone

图 5-116. RX Noise Spectral Density vs Input Amplitude and Temperature at 2.6 GHz

5.12.4 RX Typical Characteristics 2.6GHz (continued)

Typical values at $T_A = +25^\circ\text{C}$, ADC Sampling Rate = 2949.12 MHz. Default conditions: output sample rate = 491.52MSPS (decimate by 6), PLL clock mode with $f_{REF} = 491.52\text{MHz}$, $A_{IN} = -3 \text{ dBFS}$, DSA setting = 4 dB.

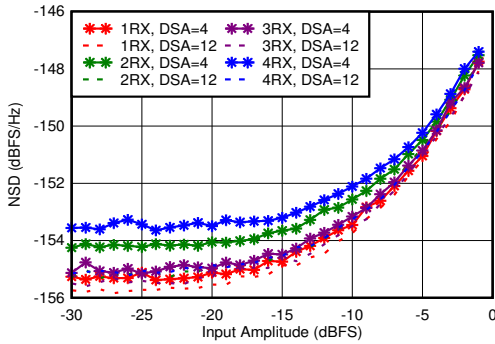

With 2.6 GHz matching, 12.5-MHz offset from tone

图 5-117. RX Noise Spectral Density vs Input Amplitude and Channel at 2.6 GHz

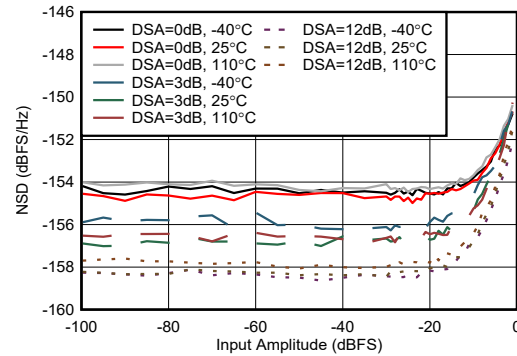

50-MHz offset from tone, external clock mode

图 5-118. RX Noise Spectral Density vs Input Amplitude at 2.61 GHz (Ext. Clock)

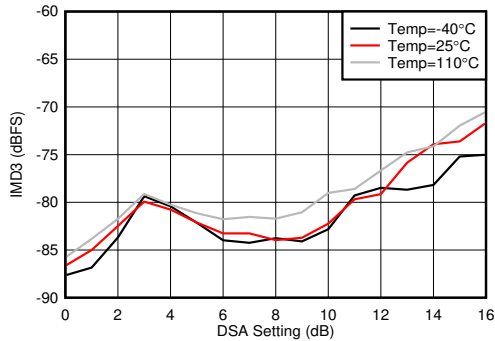

With 2.6 GHz matching, each tone - 7 dBFS, tone spacing = 20 MHz

图 5-119. RX IMD3 vs DSA Setting and Temperature at 2.6 GHz

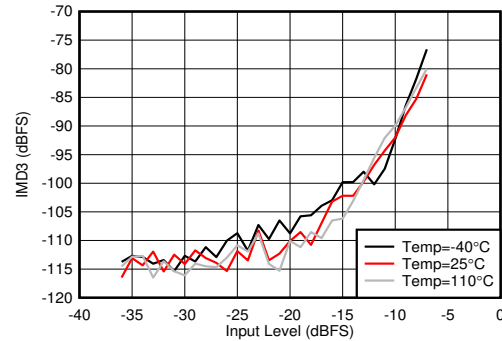

With 2.6 GHz matching, tone spacing = 20 MHz, DSA = 4 dB

图 5-120. RX IMD3 vs Input Level and Temperature at 2.6 GHz

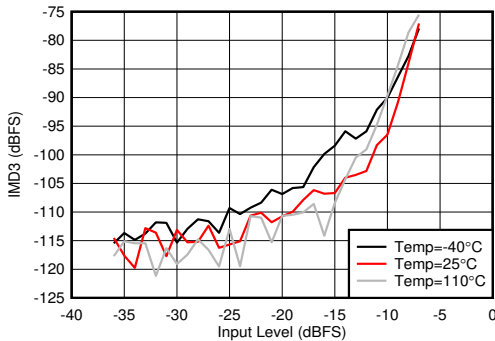

With 2.6 GHz matching, tone spacing = 20 MHz, DSA = 12 dB

图 5-121. RX IMD3 vs Input Level and Temperature at 2.6 GHz

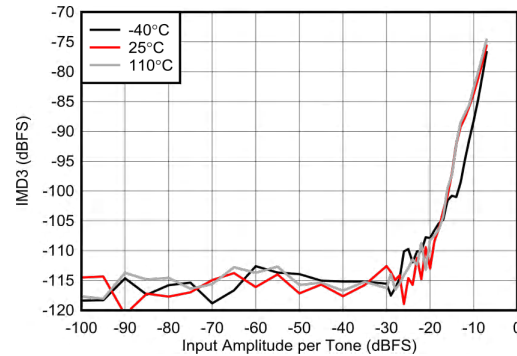

Tone spacing = 50 MHz, External clock mode

图 5-122. RX IMD3 vs Input Level at 2.6 GHz (Ext. Clock)

5.12.4 RX Typical Characteristics 2.6GHz (continued)

Typical values at $T_A = +25^\circ\text{C}$, ADC Sampling Rate = 2949.12 MHz. Default conditions: output sample rate = 491.52MSPS (decimate by 6), PLL clock mode with $f_{REF} = 491.52\text{MHz}$, $A_{IN} = -3\text{ dBFS}$, DSA setting = 4 dB.

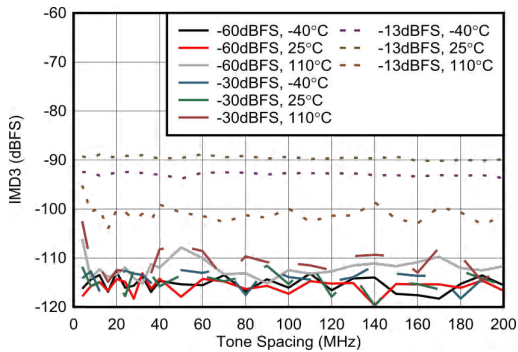

External clock mode

图 5-123. RX IMD3 vs Tone Spacing at 2.6 GHz (Ext. Clock)

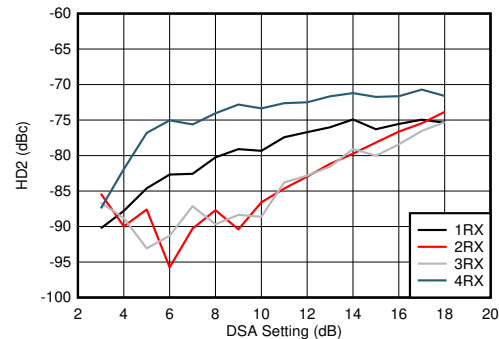

With 2.6 GHz matching, DDC bypass mode (TI only mode for characterization)

图 5-124. RX HD2 vs DSA Setting and Channel at 2.6 GHz

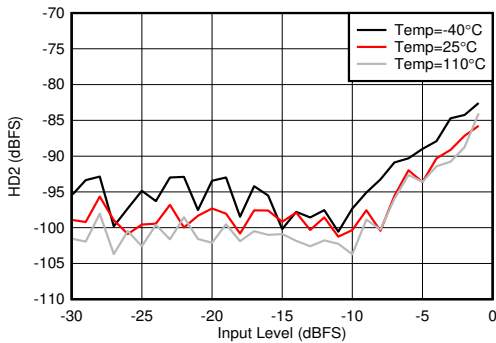

With 2.6 GHz matching, DDC bypass mode (TI only mode for characterization)

图 5-125. RX HD2 vs Input Level and Temperature at 2.6 GHz

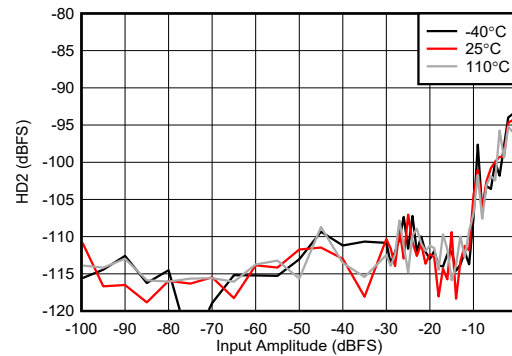

External clock mode

图 5-126. RX HD2 vs Input Level and Temperature at 2.6 GHz

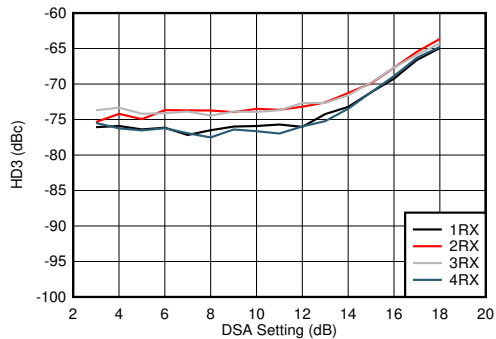

With 2.6 GHz matching, DDC bypass mode (TI only mode for characterization)

图 5-127. RX HD3 vs DSA Setting and Channel at 2.6 GHz

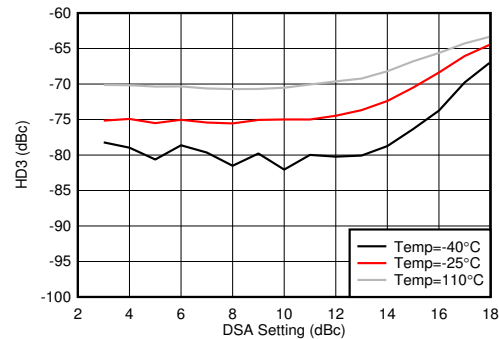

With 2.6 GHz matching, DDC bypass mode (TI only mode for characterization)

图 5-128. RX HD3 vs DSA Setting and Temperature at 2.6 GHz

5.12.4 RX Typical Characteristics 2.6GHz (continued)

Typical values at $T_A = +25^\circ\text{C}$, ADC Sampling Rate = 2949.12 MHz. Default conditions: output sample rate = 491.52MSPS (decimate by 6), PLL clock mode with $f_{REF} = 491.52\text{MHz}$, $A_{IN} = -3\text{ dBFS}$, DSA setting = 4 dB.

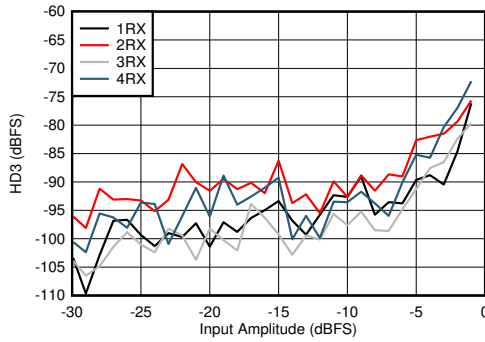

With 2.6 GHz matching, DDC bypass mode (TI only mode for characterization)

图 5-129. RX HD3 vs Input Level and Channel at 2.6 GHz

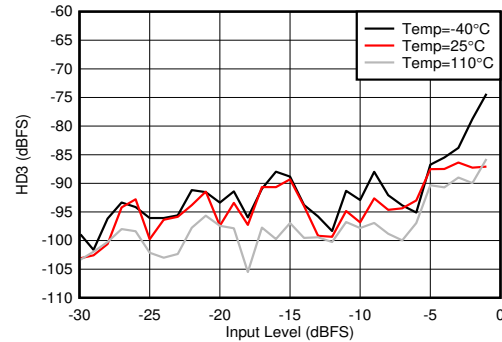

With 2.6 GHz matching, DDC bypass mode (TI only mode for characterization)

图 5-130. RX HD3 vs Input Level and Temperature at 2.6 GHz

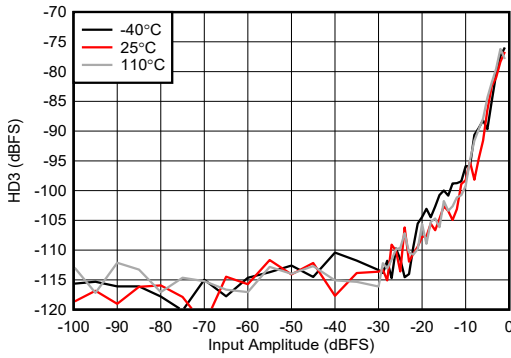

External clock mode

图 5-131. RX HD3 vs Input Level and Temperature at 2.6 GHz

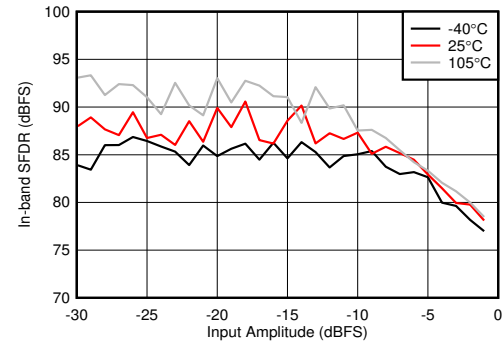

With 2.6 GHz matching, decimate by 4

图 5-132. RX In-Band SFDR ($\pm 300\text{ MHz}$) vs Input Amplitude and Temperature at 2.6 GHz

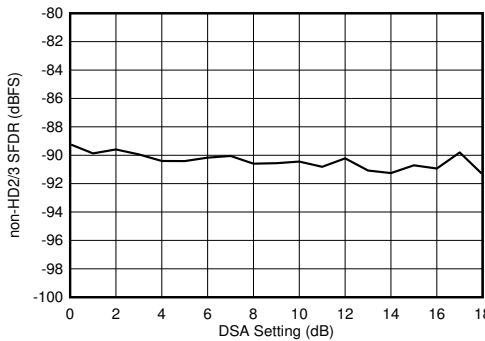

With 2.6 GHz matching

图 5-133. RX Non-HD2/3 vs DSA Setting at 2.6 GHz

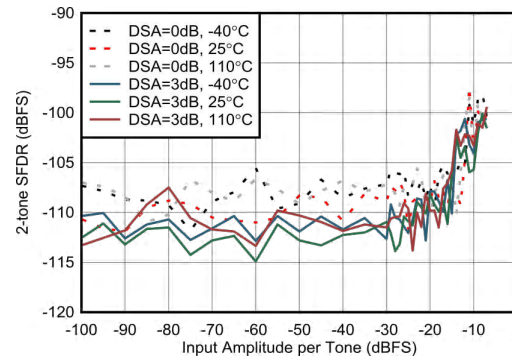

External clock mode, 50MHz tone spacing, excluding 3rd order distortion

图 5-134. RX 2-tone SFDR vs Input Amplitude at 2.6 GHz

5.12.4 RX Typical Characteristics 2.6GHz (continued)

Typical values at $T_A = +25^\circ\text{C}$, ADC Sampling Rate = 2949.12 MHz. Default conditions: output sample rate = 491.52MSPS (decimate by 6), PLL clock mode with $f_{REF} = 491.52\text{MHz}$, $A_{IN} = -3\text{ dBFS}$, DSA setting = 4 dB.

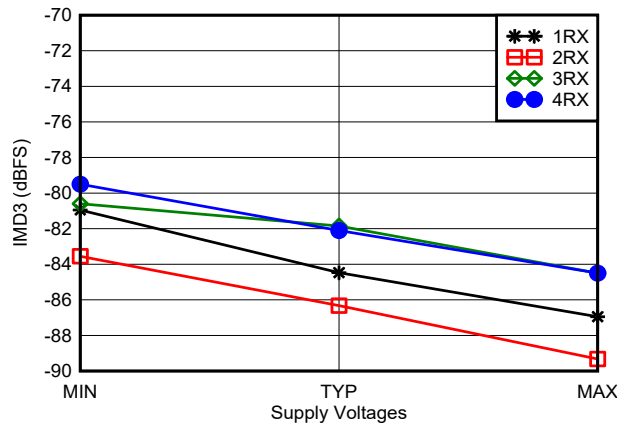

With 2.6 GHz matching, -7 dBFS each tone, 20-MHz tone spacing, all supplies at MIN, TYP, or MAX recommended operating voltages

图 5-135. RX IMD3 vs Supply and Channel at 2.6 GHz

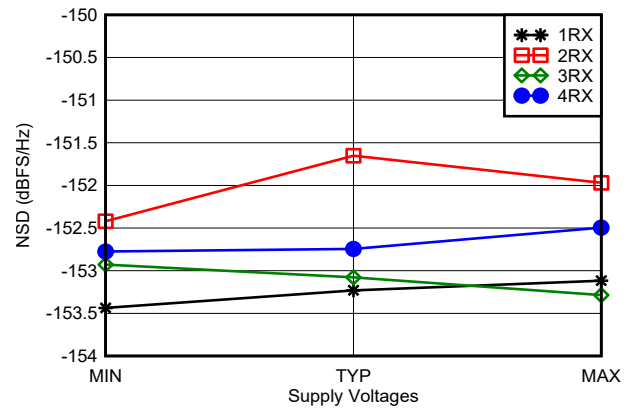

With 2.6 GHz matching, 12.5-MHz offset, all supplies at MIN, TYP, or MAX recommended operating voltages

图 5-136. RX Noise Spectral Density vs Supply and Channel at 2.6 GHz

5.12.5 RX Typical Characteristics 3.5GHz

Typical values at $T_A = +25^\circ\text{C}$, ADC Sampling Rate = 2949.12 GHz. Default conditions: output sample rate = 491.52MSPS (decimate by 6), PLL clock mode with $f_{REF} = 491.52\text{MHz}$, $A_{IN} = -3\text{ dBFS}$, DSA setting = 4 dB.

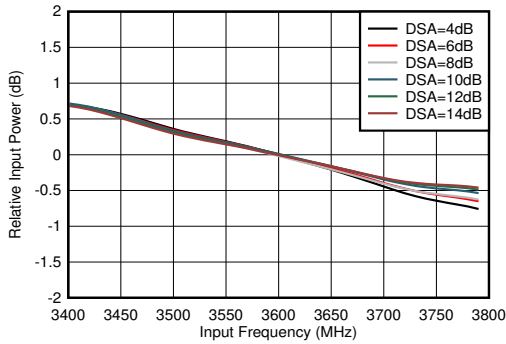

With 3.6 GHz matching, normalized to 3.6 GHz

图 5-137. RX In-Band Gain Flatness, $f_{IN} = 3600\text{ MHz}$

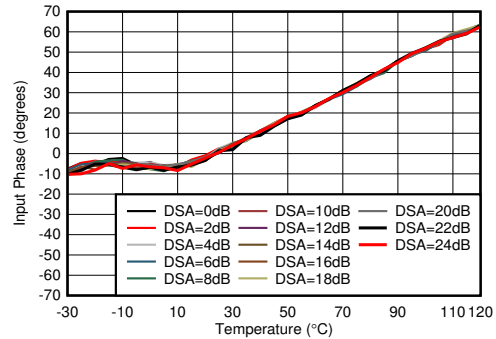

With 3.6 GHz matching, normalized to phase at 25°C

图 5-138. RX Input Phase vs Temperature at 3.6 GHz

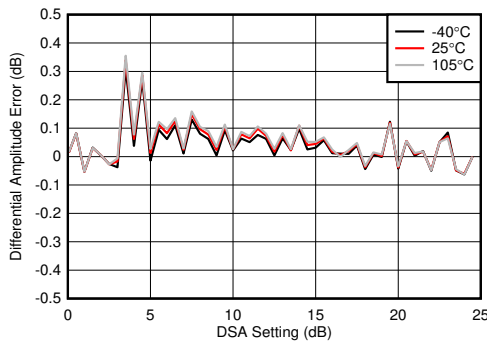

With 3.6 GHz matching

$$\text{Differential Amplitude Error} = P_{IN}(\text{DSA Setting} - 1) - P_{IN}(\text{DSA Setting}) + 1$$

图 5-139. RX Uncalibrated Differential Amplitude Error vs DSA Setting at 3.6 GHz

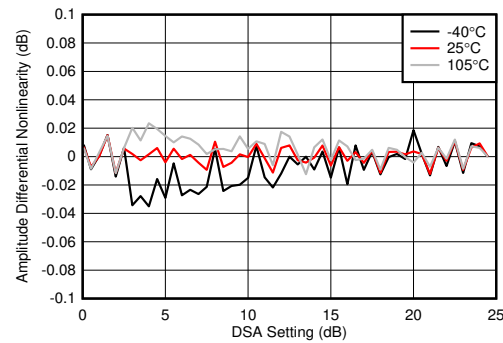

With 3.6 GHz matching

$$\text{Differential Amplitude Error} = P_{IN}(\text{DSA Setting} - 1) - P_{IN}(\text{DSA Setting}) + 1$$

图 5-140. RX Calibrated Differential Amplitude Error vs DSA Setting at 3.6 GHz

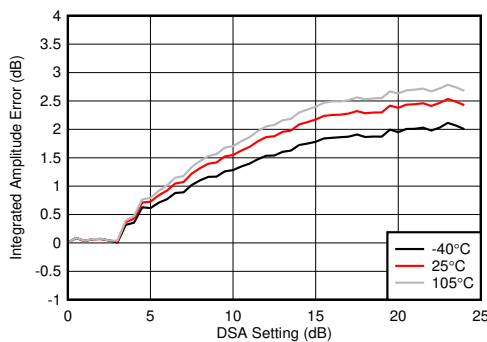

With 3.6 GHz matching

$$\text{Integrated Amplitude Error} = P_{IN}(\text{DSA Setting}) - P_{IN}(\text{DSA Setting} = 0) + (\text{DSA Setting})$$

图 5-141. RX Uncalibrated Integrated Amplitude Error vs DSA Setting at 3.6 GHz

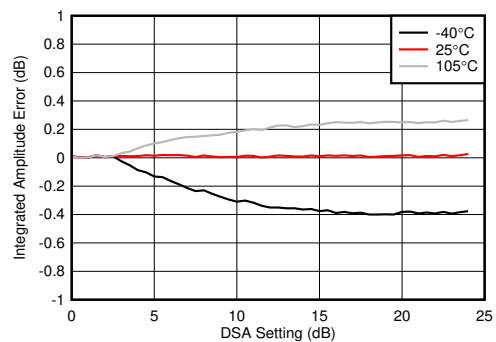

With 3.6 GHz matching

$$\text{Integrated Amplitude Error} = P_{IN}(\text{DSA Setting}) - P_{IN}(\text{DSA Setting} = 0) + (\text{DSA Setting})$$

图 5-142. RX Calibrated Integrated Amplitude Error vs DSA Setting at 3.6 GHz

5.12.5 RX Typical Characteristics 3.5GHz (continued)

Typical values at $T_A = +25^\circ\text{C}$, ADC Sampling Rate = 2949.12 MHz. Default conditions: output sample rate = 491.52MSPS (decimate by 6), PLL clock mode with $f_{\text{REF}} = 491.52\text{MHz}$, $A_{\text{IN}} = -3 \text{ dBFS}$, DSA setting = 4 dB.

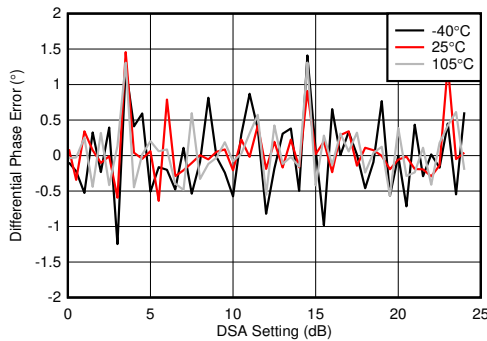

With 3.6 GHz matching
Differential Phase Error = $\text{Phase}_{\text{IN}}(\text{DSA Setting} - 1) - \text{Phase}_{\text{IN}}(\text{DSA Setting})$

图 5-143. RX Uncalibrated Phase Error vs DSA Setting at 3.6 GHz

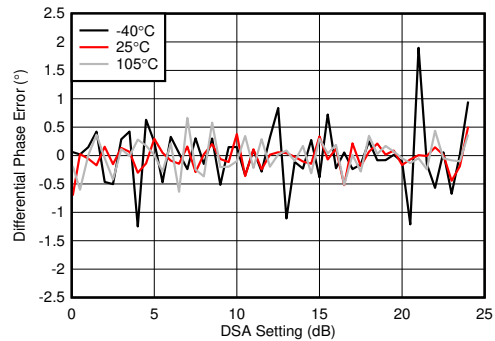

With 3.6 GHz matching
Differential Phase Error = $\text{Phase}_{\text{IN}}(\text{DSA Setting} - 1) - \text{Phase}_{\text{IN}}(\text{DSA Setting})$

图 5-144. RX Calibrated Differential Phase Error vs DSA Setting at 3.6 GHz

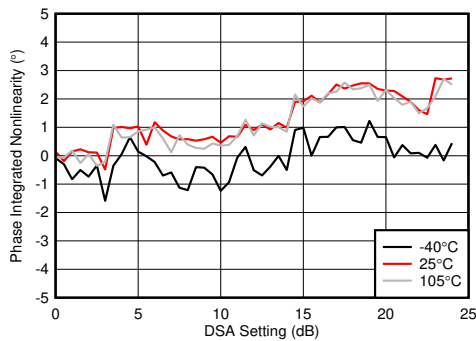

With 3.6 GHz matching
Integrated Phase Error = $\text{Phase}(\text{DSA Setting}) - \text{Phase}(\text{DSA Setting} = 0)$

图 5-145. RX Uncalibrated Integrated Phase Error vs DSA Setting at 3.6 GHz

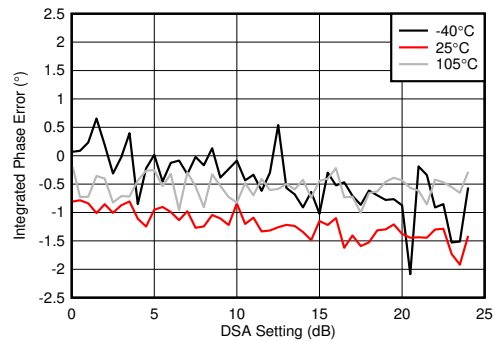

With 3.6 GHz matching
Integrated Phase Error = $\text{Phase}(\text{DSA Setting}) - \text{Phase}(\text{DSA Setting} = 0)$

图 5-146. RX Calibrated Integrated Phase Error vs DSA Setting at 3.6 GHz

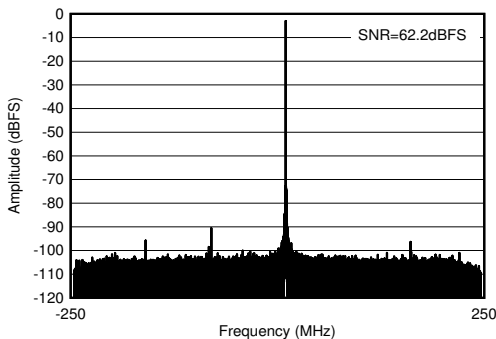

With 3.6 GHz matching, $f_{\text{IN}} = 3610 \text{ MHz}$, $A_{\text{IN}} = -3 \text{ dBFS}$

图 5-147. RX Output FFT at 3.6 GHz

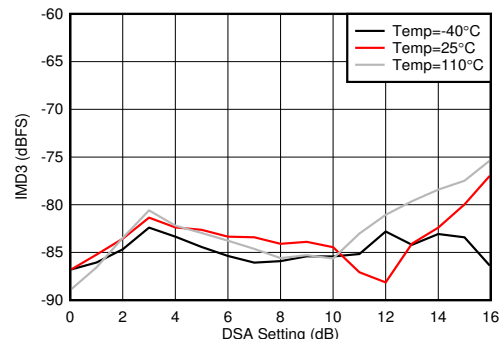

With 3.5 GHz matching, each tone at -7 dBFS , 20-MHz tone spacing

图 5-148. RX IMD3 vs DSA Setting and Temperature at 3.6 GHz

5.12.5 RX Typical Characteristics 3.5GHz (continued)

Typical values at $T_A = +25^\circ\text{C}$, ADC Sampling Rate = 2949.12 MHz. Default conditions: output sample rate = 491.52MSPS (decimate by 6), PLL clock mode with $f_{REF} = 491.52\text{MHz}$, $A_{IN} = -3\text{ dBFS}$, DSA setting = 4 dB.

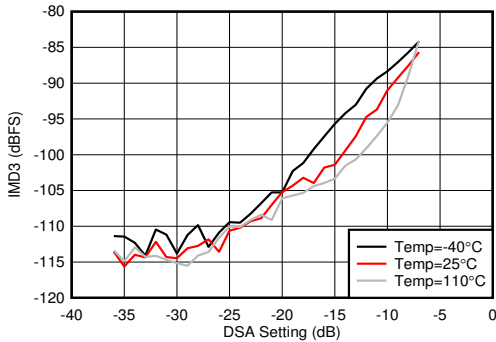

With 3.5 GHz matching, 20-MHz tone spacing

图 5-149. RX IMD3 vs Input Level and Temperature at 3.6 GHz

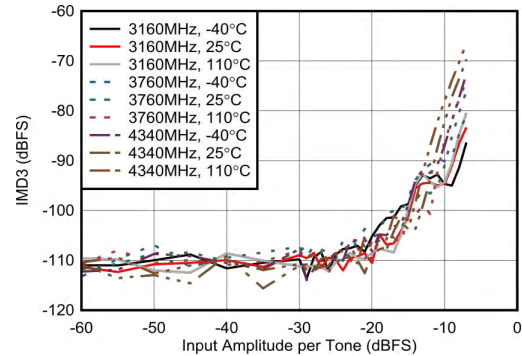

External clock mode, 20-MHz tone spacing, 2x Decimation

图 5-150. RX IMD3 vs Input Level

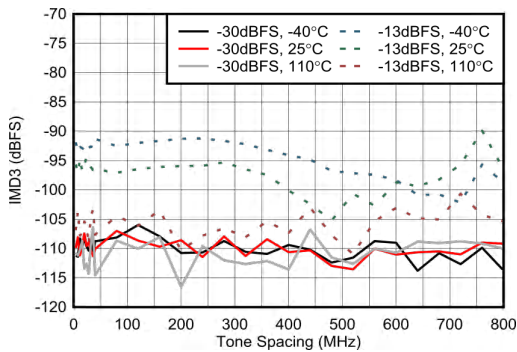

External clock mode, 2x Decimation

图 5-151. RX IMD3 vs Tone Spacing at 3.76GHz

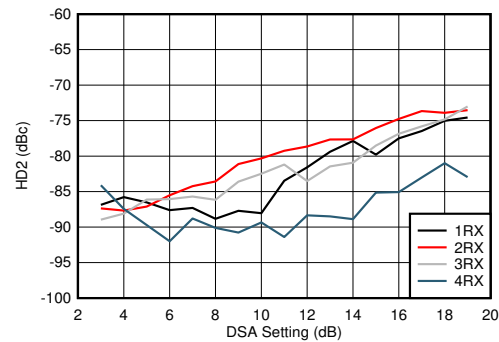

With 3.5 GHz matching, DDC bypass mode (TI only mode for characterization)

图 5-152. RX HD2 vs DSA Setting and Channel at 3.6 GHz

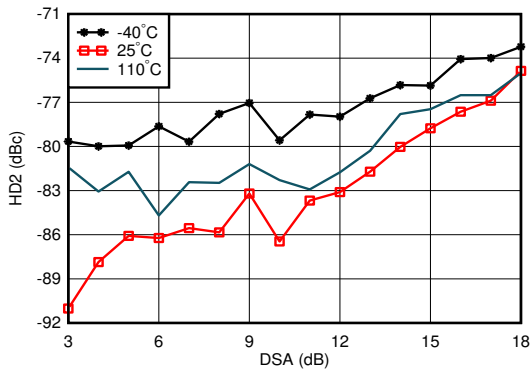

With 3.5 GHz matching, DDC bypass mode (TI only mode for characterization)

图 5-153. RX HD2 vs DSA Setting and Temperature at 3.6 GHz

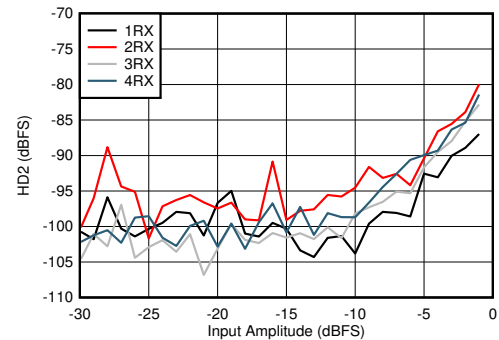

With 3.5 GHz matching, DDC bypass mode (TI only mode for characterization)

图 5-154. RX HD2 vs Input Level and Channel at 3.6 GHz

5.12.5 RX Typical Characteristics 3.5GHz (continued)

Typical values at $T_A = +25^\circ\text{C}$, ADC Sampling Rate = 2949.12 MHz. Default conditions: output sample rate = 491.52MSPS (decimate by 6), PLL clock mode with $f_{REF} = 491.52\text{MHz}$, $A_{IN} = -3\text{ dBFS}$, DSA setting = 4 dB.

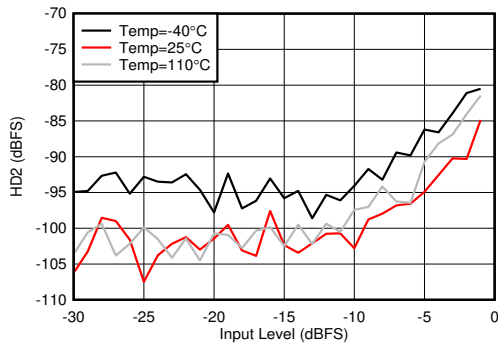

With 3.5 GHz matching, DDC bypass mode (TI only mode for characterization)

图 5-155. RX HD2 vs Input Level and Temperature at 3.6 GHz

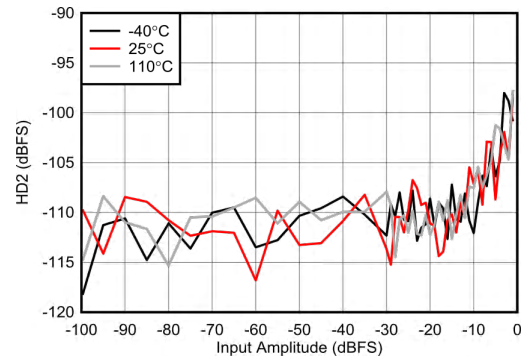

External clock mode, 2x Decimation

图 5-156. RX HD2 vs Input Level at 3.76 GHz

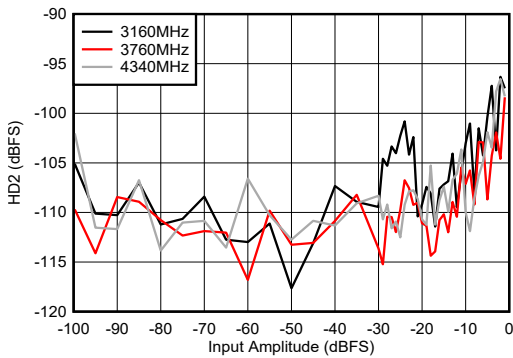

External clock mode, 25°C, 2x Decimation

图 5-157. RX HD2 vs Input Level

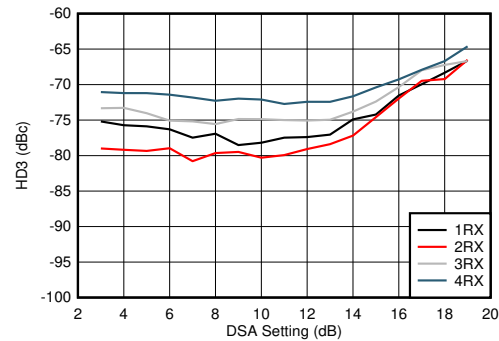

With 3.5 GHz matching, DDC bypass mode (TI only mode for characterization)

图 5-158. RX HD3 vs DSA Setting and Channel at 3.6 GHz

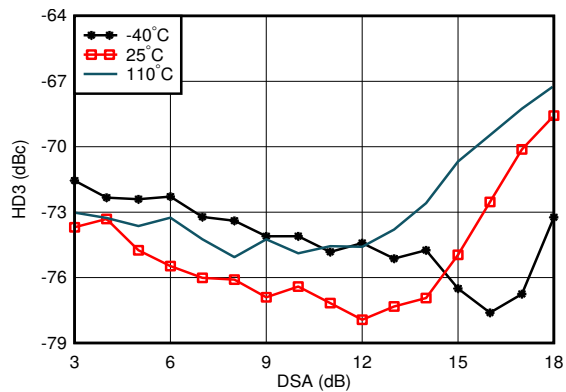

With 3.5 GHz matching, DDC bypass mode (TI only mode for characterization)

图 5-159. RX HD3 vs DSA Setting and Temperature at 3.6 GHz

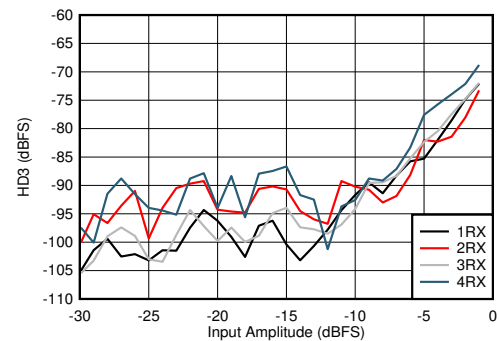

With 3.5 GHz matching, DDC bypass mode (TI only mode for characterization)

图 5-160. RX HD3 vs Input Level and Channel at 3.6 GHz

5.12.5 RX Typical Characteristics 3.5GHz (continued)

Typical values at $T_A = +25^\circ\text{C}$, ADC Sampling Rate = 2949.12 GHz. Default conditions: output sample rate = 491.52MSPS (decimate by 6), PLL clock mode with $f_{REF} = 491.52\text{MHz}$, $A_{IN} = -3 \text{ dBFS}$, DSA setting = 4 dB.

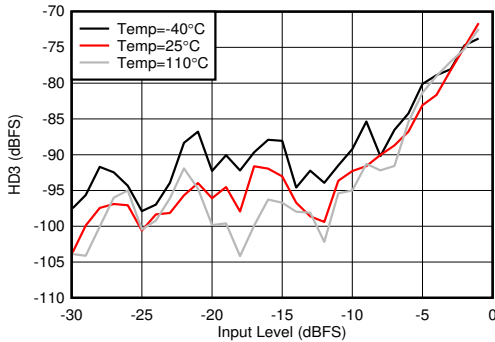

With 3.5 GHz matching, DDC bypass mode (TI only mode for characterization)

图 5-161. RX HD3 vs Input Level and Temperature at 3.6 GHz

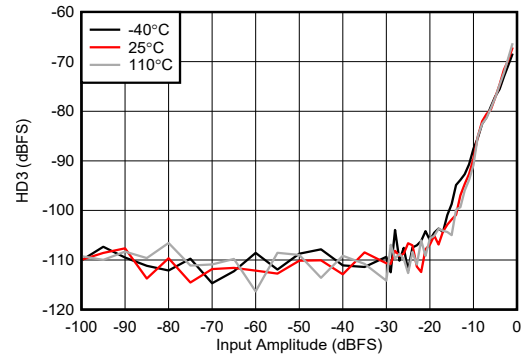

External clock mode, 2x Decimation

图 5-162. RX HD3 vs Input Level at 3.76GHz

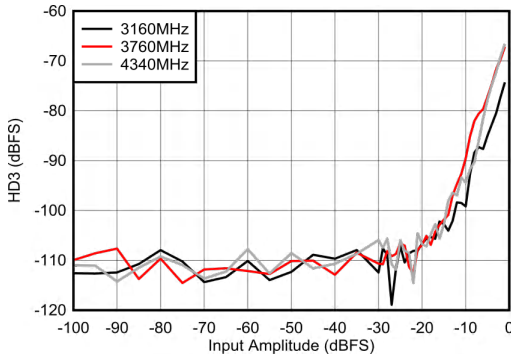

External clock mode, 25°C, 2x Decimation

图 5-163. RX HD3 vs Input Level

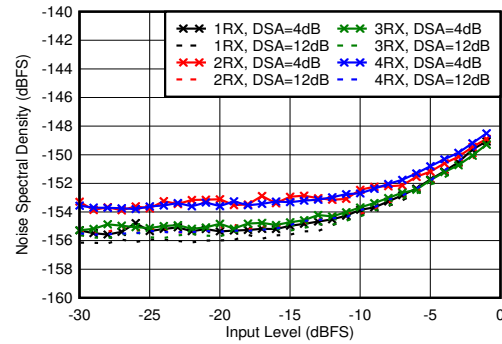

With 3.5 GHz matching, 12.5-MHz offset from tone

图 5-164. RX Noise Spectral Density vs Input Level and DSA Setting at 3.6 GHz

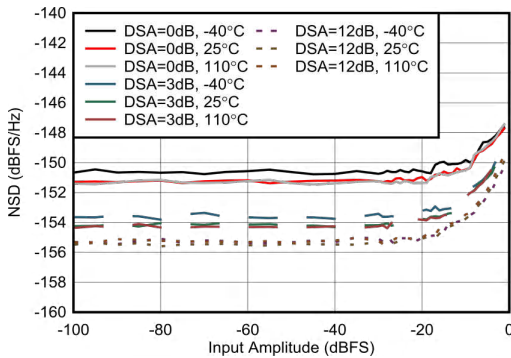

External clock mode, 25°C, 2x Decimation

图 5-165. RX Noise Spectral Density vs Input Level at 3.76GHz

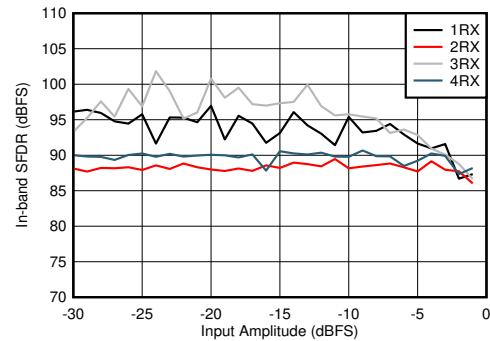

With 3.5 GHz matching

图 5-166. RX In-Band SFDR ($\pm 200 \text{ MHz}$) vs Input Level and Channel at 3.6 GHz

5.12.5 RX Typical Characteristics 3.5GHz (continued)

Typical values at $T_A = +25^\circ\text{C}$, ADC Sampling Rate = 2949.12 MHz. Default conditions: output sample rate = 491.52MSPS (decimate by 6), PLL clock mode with $f_{REF} = 491.52\text{MHz}$, $A_{IN} = -3\text{ dBFS}$, DSA setting = 4 dB.

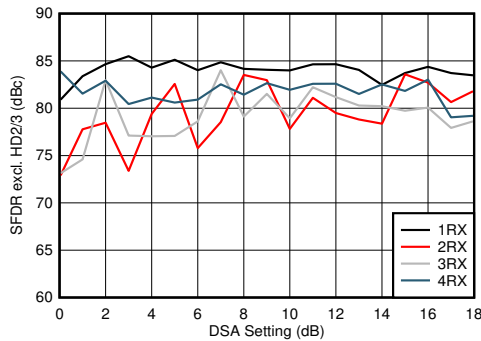

With 3.5 GHz matching

图 5-167. RX SFDR Excluding HD2/3 vs DSA Setting and Channel at 3.6 GHz

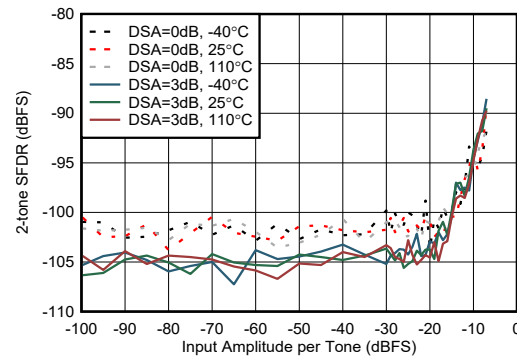

External clock mode, 20MHz tone spacing, excluding 3rd order distortion

图 5-168. RX 2-tone SFDR vs Input Amplitude and DSA Setting at 3.7 GHz

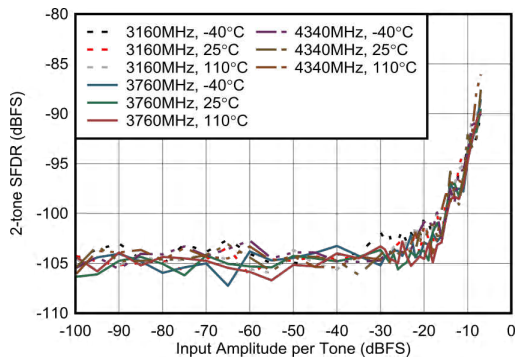

External clock mode, 20MHz tone spacing, excluding 3rd order distortion

图 5-169. RX 2-tone SFDR vs Input Amplitude and Frequency at 3.7 GHz

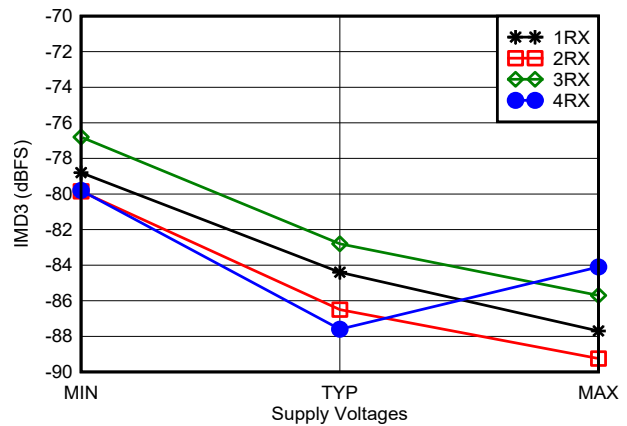

With 3.6 GHz matching, -7 dBFS each tone, 20-MHz tone spacing, all supplies at MIN, TYP, or MAX recommended operating voltages

图 5-170. RX IMD3 vs Supply Voltage and Channel at 3.6 GHz

5.12.5 RX Typical Characteristics 3.5GHz (continued)

Typical values at $T_A = +25^\circ\text{C}$, ADC Sampling Rate = 2949.12 MHz. Default conditions: output sample rate = 491.52MSPS (decimate by 6), PLL clock mode with $f_{REF} = 491.52\text{MHz}$, $A_{IN} = -3\text{ dBFS}$, DSA setting = 4 dB.

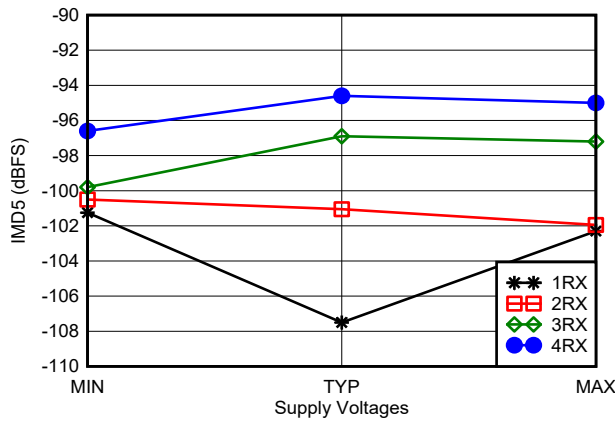

With 3.6 GHz matching, -7 dBFS each tone, 20-MHz tone spacing, all supplies at MIN, TYP, or MAX recommended operating voltages

图 5-171. RX IMD5 vs Supply Voltage and Channel at 3.6 GHz

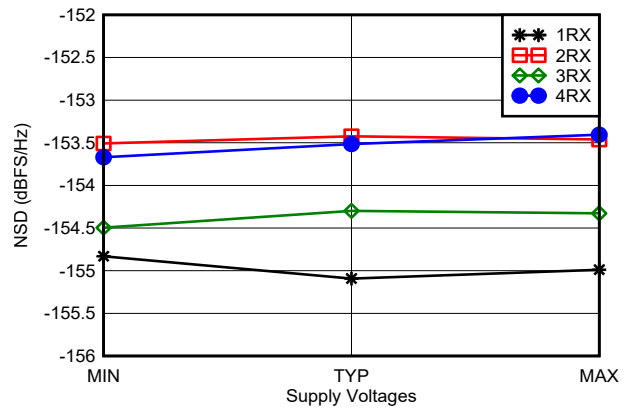

With 3.6 GHz matching, tone at -20 dBFS, 12.5-MHz offset frequency, all supplies at MIN, TYP, or MAX recommended operating voltages

图 5-172. RX Noise Spectral Density vs Supply Voltage and Channel at 3.6 GHz

5.12.6 RX Typical Characteristics 4.9GHz

Typical values at $T_A = +25^\circ\text{C}$, ADC Sampling Rate = 2949.12 MHz. Default conditions: output sample rate = 491.52MSPS (decimate by 6), PLL clock mode with $f_{REF} = 491.52\text{MHz}$, $A_{IN} = -3\text{ dBFS}$, DSA setting = 4 dB.

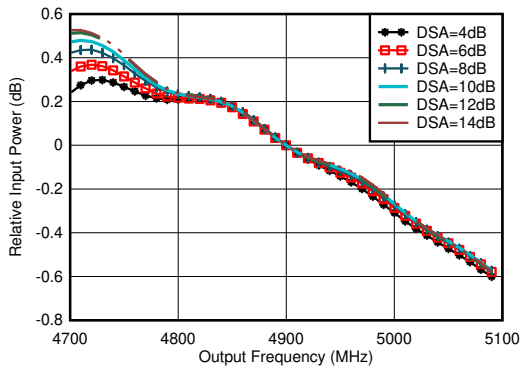

With matching, normalized to power at 4.9GHz for each DSA setting

图 5-173. RX Inband Gain Flatness, $f_{IN} = 4900\text{ MHz}$

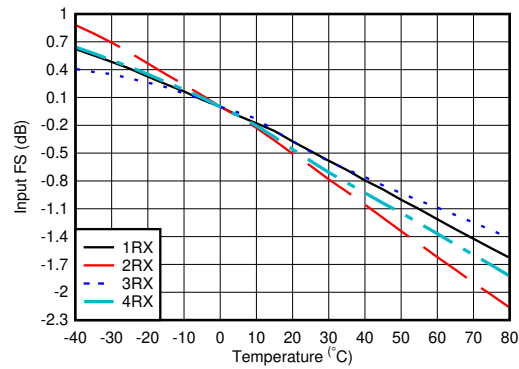

With 4.9 GHz matching, normalized to fullscale at 25°C for each channel

图 5-174. RX Input Fullscale vs Temperature and Channel at 4.9 GHz

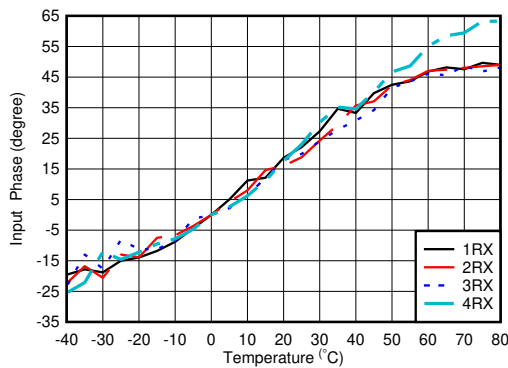

With 4.9 GHz matching, normalized to phase at 25°C

图 5-175. RX Input Phase vs Temperature and DSA at $f_{OUT} = 4.9\text{ GHz}$

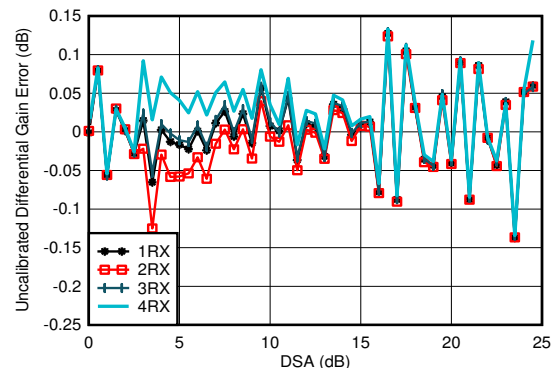

With 4.9 GHz matching

$$\text{Differential Amplitude Error} = P_{IN}(\text{DSA Setting} - 1) - P_{IN}(\text{DSA Setting}) + 1$$

图 5-176. RX Uncalibrated Differential Amplitude Error vs DSA Setting at 4.9 GHz

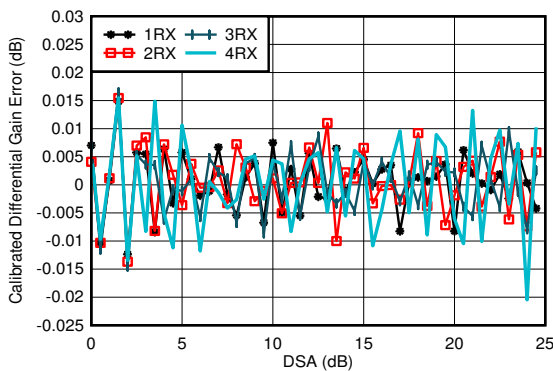

With 4.9 GHz matching

$$\text{Differential Amplitude Error} = P_{IN}(\text{DSA Setting} - 1) - P_{IN}(\text{DSA Setting}) + 1$$

图 5-177. RX Calibrated Differential Amplitude Error vs DSA Setting at 4.9 GHz

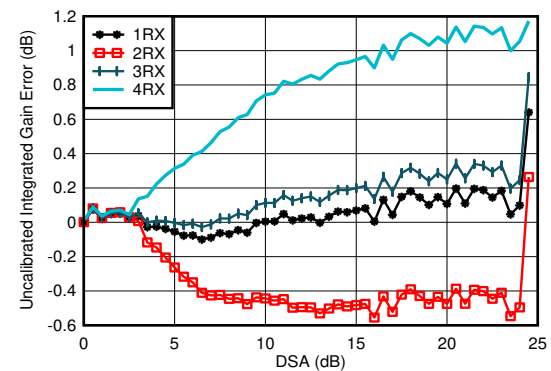

With 4.9 GHz matching

$$\text{Integrated Amplitude Error} = P_{IN}(\text{DSA Setting}) - P_{IN}(\text{DSA Setting} = 0) + (\text{DSA Setting})$$

图 5-178. RX Uncalibrated Integrated Amplitude Error vs DSA Setting at 4.9 GHz

5.12.6 RX Typical Characteristics 4.9GHz (continued)

Typical values at $T_A = +25^\circ\text{C}$, ADC Sampling Rate = 2949.12 MHz. Default conditions: output sample rate = 491.52MSPS (decimate by 6), PLL clock mode with $f_{REF} = 491.52\text{MHz}$, $A_{IN} = -3\text{ dBFS}$, DSA setting = 4 dB.

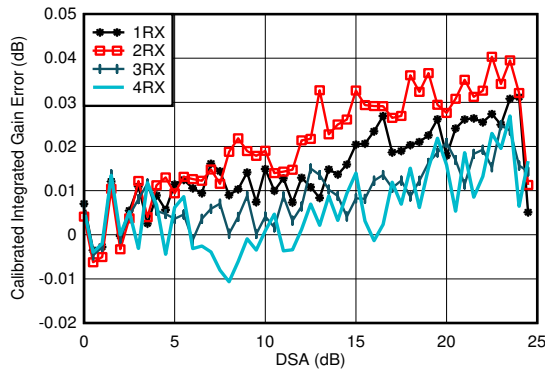

With 4.9 GHz matching

$$\text{Integrated Amplitude Error} = P_{IN}(\text{DSA Setting}) - P_{IN}(\text{DSA Setting} = 0) + (\text{DSA Setting})$$

图 5-179. RX Calibrated Integrated Amplitude Error vs DSA Setting at 4.9 GHz

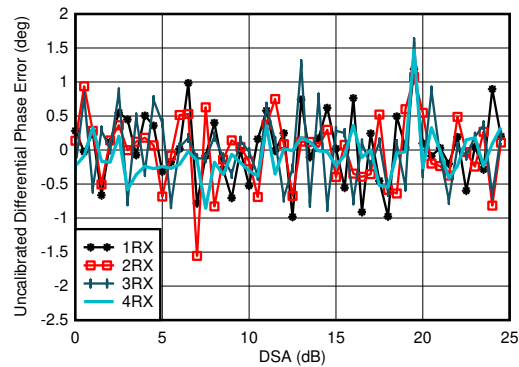

With 4.9 GHz matching

$$\text{Differential Phase Error} = \text{Phase}_{IN}(\text{DSA Setting} - 1) - \text{Phase}_{IN}(\text{DSA Setting})$$

图 5-180. RX Uncalibrated Differential Phase Error vs DSA Setting at 4.9 GHz

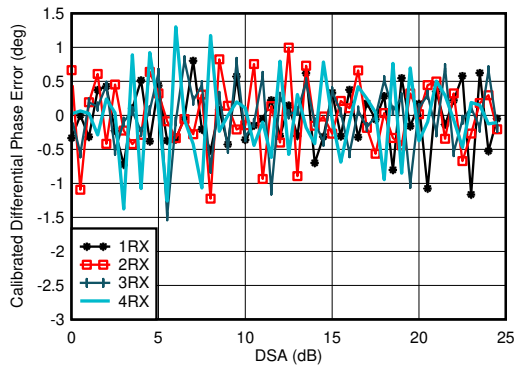

With 4.9 GHz matching

$$\text{Differential Phase Error} = \text{Phase}_{IN}(\text{DSA Setting} - 1) - \text{Phase}_{IN}(\text{DSA Setting})$$

图 5-181. RX Calibrated Differential Phase Error vs DSA Setting at 4.9 GHz

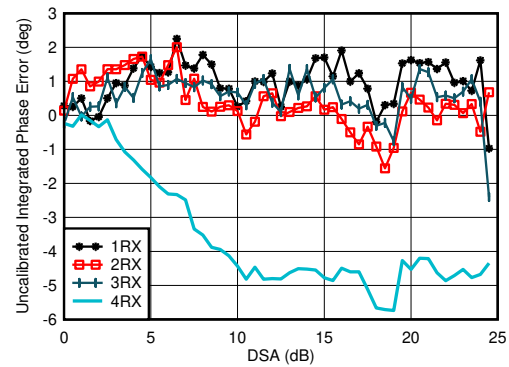

With 4.9 GHz matching

$$\text{Integrated Phase Error} = \text{Phase}(\text{DSA Setting}) - \text{Phase}(\text{DSA Setting} = 0)$$

图 5-182. RX Uncalibrated Integrated Phase Error vs DSA Setting at 4.9 GHz

5.12.6 RX Typical Characteristics 4.9GHz (continued)

Typical values at $T_A = +25^\circ\text{C}$, ADC Sampling Rate = 2949.12 MHz. Default conditions: output sample rate = 491.52MSPS (decimate by 6), PLL clock mode with $f_{REF} = 491.52\text{MHz}$, $A_{IN} = -3\text{ dBFS}$, DSA setting = 4 dB.

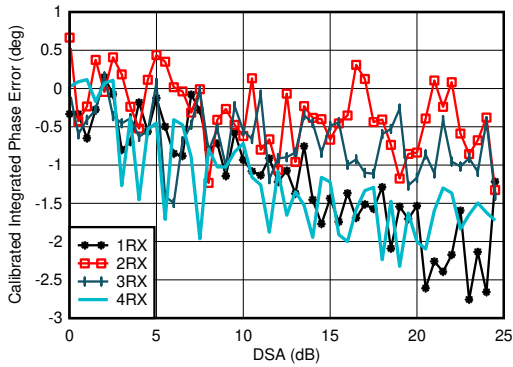

With 4.9 GHz matching
Integrated Phase Error = Phase(DSA Setting) - Phase(DSA Setting = 0)

图 5-183. RX Calibrated Integrated Phase Error vs DSA Setting at 4.9 GHz

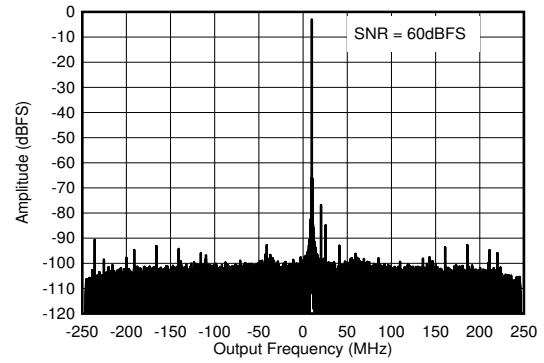

With 4.9 GHz matching, $f_{IN} = 4910\text{ MHz}$, $A_{IN} = -3\text{ dBFS}$

图 5-184. RX Output FFT at 4.9 GHz

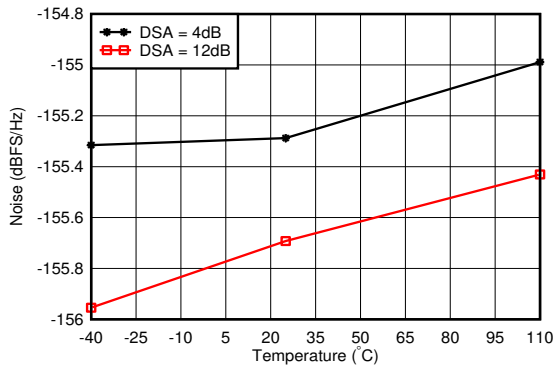

With 4.9 GHz matching, 12.5-MHz offset from tone

图 5-185. RX Noise Spectral Density vs Temperature at 4.9 GHz

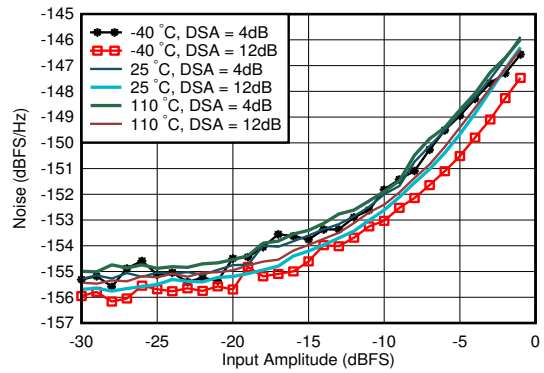

With 4.9 GHz matching, DSA Setting = 12 dB, 12.5-MHz offset from tone

图 5-186. RX Noise Spectral Density vs Input Amplitude and Temperature at 4.9 GHz

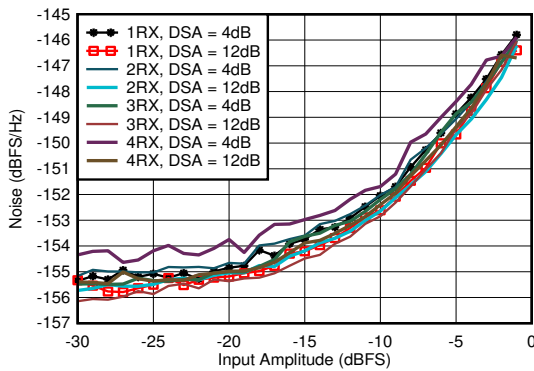

With 4.9 GHz matching, 12.5-MHz offset from tone

图 5-187. RX Noise Spectral Density vs Input Amplitude and Channel at 4.9 GHz

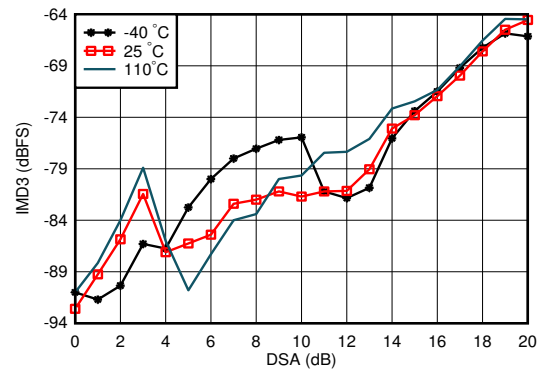

With 4.9 GHz matching, each tone -7 dBFS , tone spacing = 20 MHz

图 5-188. RX IMD3 vs DSA Setting and Temperature at 4.9 GHz

5.12.6 RX Typical Characteristics 4.9GHz (continued)

Typical values at $T_A = +25^\circ\text{C}$, ADC Sampling Rate = 2949.12 MHz. Default conditions: output sample rate = 491.52MSPS (decimate by 6), PLL clock mode with $f_{REF} = 491.52\text{MHz}$, $A_{IN} = -3\text{ dBFS}$, DSA setting = 4 dB.

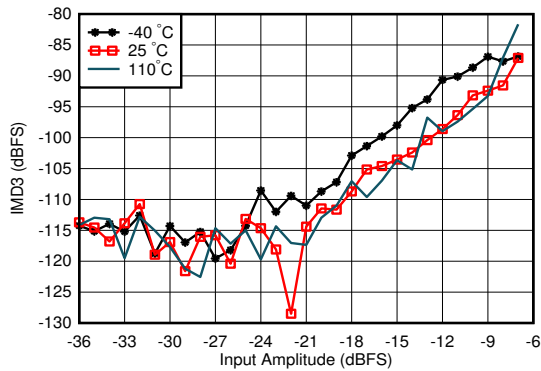

With 4.9 GHz matching, tone spacing = 20 MHz, DSA = 4 dB

图 5-189. RX IMD3 vs Input Level and Temperature at 4.9 GHz

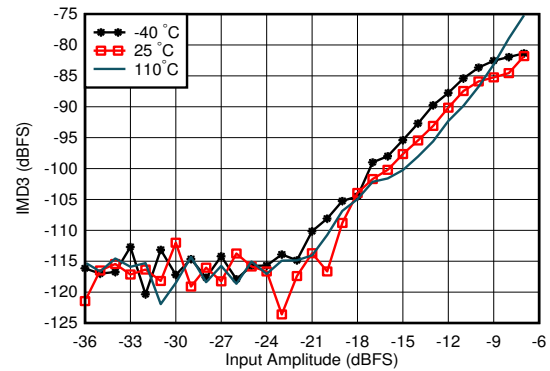

With 4.9 GHz matching, tone spacing = 20 MHz, DSA = 12 dB

图 5-190. RX IMD3 vs Input Level and Temperature at 4.9 GHz

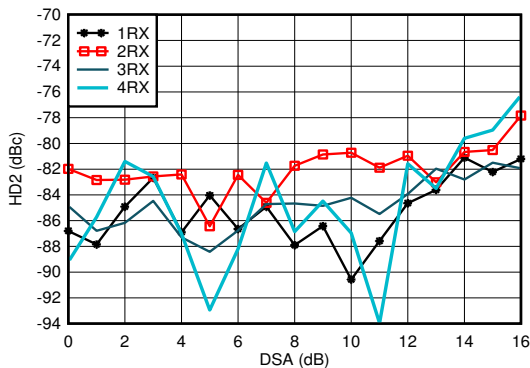

With 4.9 GHz matching, measured after HD2 trim, DDC bypass mode (TI only mode for characterization)

图 5-191. RX HD2 vs DSA Setting and Channel at 4.9 GHz

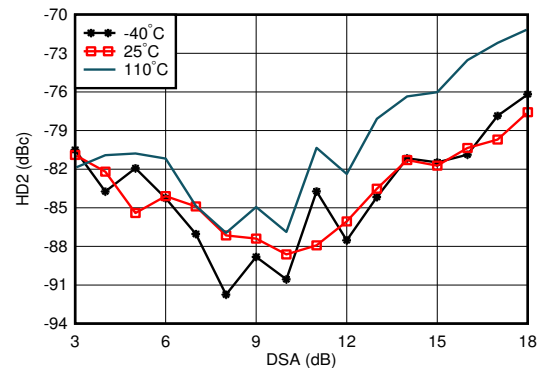

With 4.9 GHz matching, measured after HD2 trim, DDC bypass mode (TI only mode for characterization)

图 5-192. RX HD2 vs DSA and Temperature at 4.9 GHz

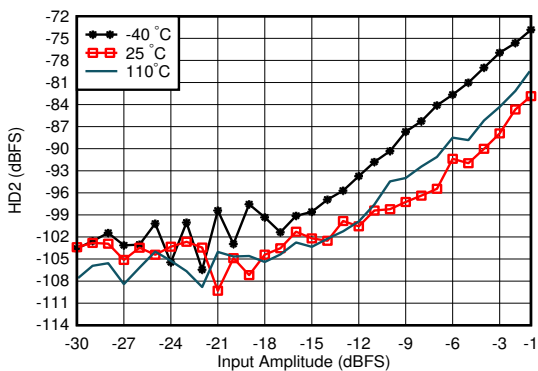

With 4.9 GHz matching, measured after HD2 trim, DDC bypass mode (TI only mode for characterization)

图 5-193. RX HD2 vs Input Level and Temperature at 4.9 GHz

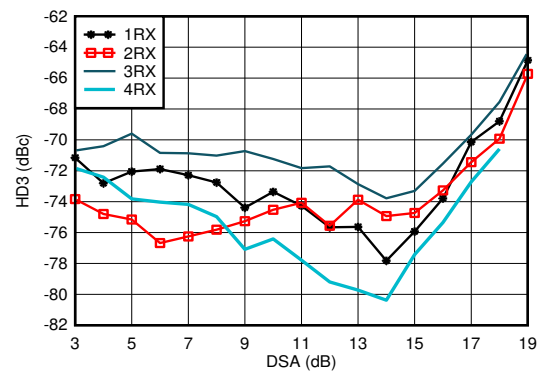

With 4.9 GHz matching, DDC bypass mode (TI only mode for characterization)

图 5-194. RX HD3 vs DSA Setting and Channel at 4.9 GHz

5.12.6 RX Typical Characteristics 4.9GHz (continued)

Typical values at $T_A = +25^\circ\text{C}$, ADC Sampling Rate = 2949.12 MHz. Default conditions: output sample rate = 491.52MSPS (decimate by 6), PLL clock mode with $f_{REF} = 491.52\text{MHz}$, $A_{IN} = -3 \text{ dBFS}$, DSA setting = 4 dB.

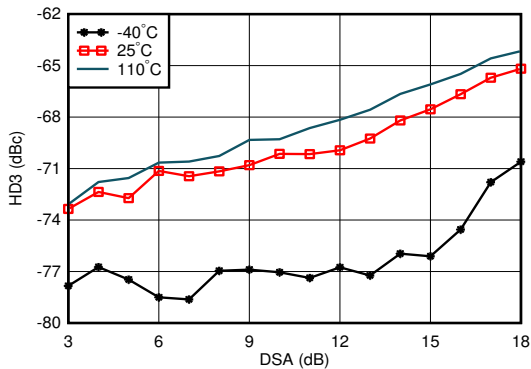

With 4.9 GHz matching, DDC bypass mode (TI only mode for characterization)

图 5-195. RX HD3 vs DSA Setting and Temperature at 4.9 GHz

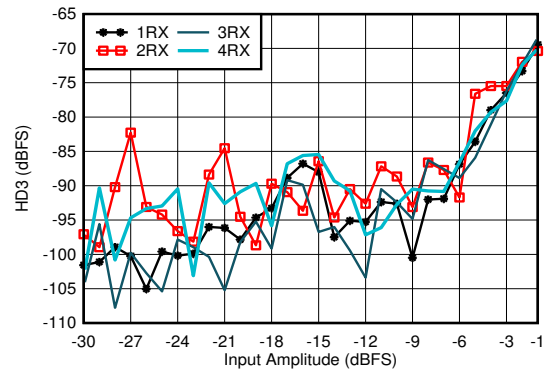

With 4.9 GHz matching, DDC bypass mode (TI only mode for characterization)

图 5-196. RX HD3 vs Input Level and Channel at 4.9 GHz

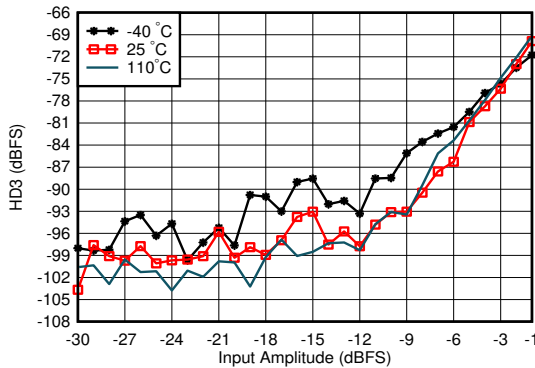

With 4.9 GHz matching, DDC bypass mode (TI only mode for characterization)

图 5-197. RX HD3 vs Input Level and Temperature at 4.9 GHz

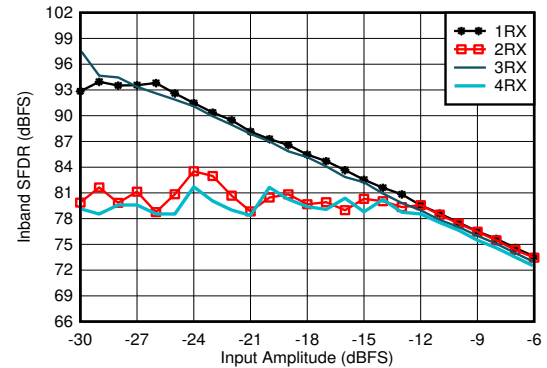

With 4.9 GHz matching, decimate by 3

图 5-198. RX In-Band SFDR ($\pm 400 \text{ MHz}$) vs Input Amplitude and Channel at 4.9 GHz

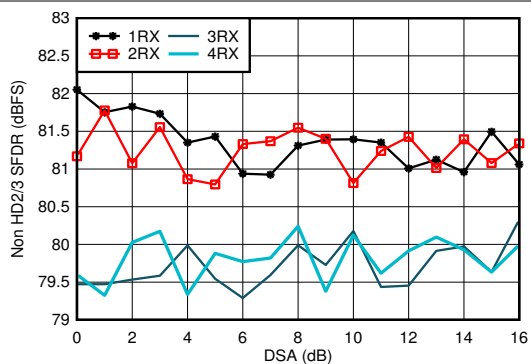

With 4.9 GHz matching

图 5-199. RX Non-HD2/3 vs DSA Setting at 4.9 GHz

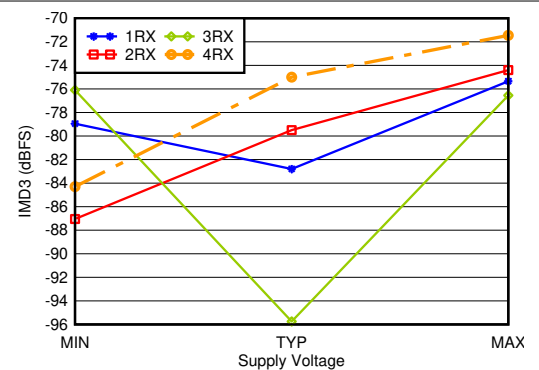

With 4.9 GHz matching, -7 dBFS each tone, 20-MHz tone spacing, all supplies at MIN, TYP, or MAX recommended operating voltages

图 5-200. RX IMD3 vs Supply and Channel at 4.9 GHz

5.12.6 RX Typical Characteristics 4.9GHz (continued)

Typical values at $T_A = +25^\circ\text{C}$, ADC Sampling Rate = 2949.12 GHz. Default conditions: output sample rate = 491.52MSPS (decimate by 6), PLL clock mode with $f_{REF} = 491.52\text{MHz}$, $A_{IN} = -3 \text{ dBFS}$, DSA setting = 4 dB.

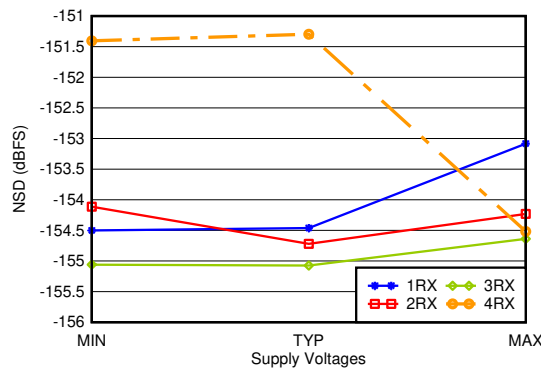

With 4.9 GHz matching, 12.5-MHz offset, all supplies at MIN, TYP, or MAX recommended operating voltages

图 5-201. RX Noise Spectral Density vs Supply and Channel at 4.9 GHz

5.12.7 TX Typical Characteristics at 30MHz and 400MHz

Typical values at $T_A = +25^\circ\text{C}$ with nominal supplies. Default conditions: TX input data rate = 125 MSPS, $f_{\text{DAC}} = 6000$ MSPS (48x interpolation), interleave mode, 1st Nyquist zone output, PLL clock mode with $f_{\text{REF}} = 500$ MHz. Additional default conditions for all plots, $A_{\text{OUT}} = -1$ dBFS, DSA = 0 dB, Sin(x)/x enabled, DSA calibrated.

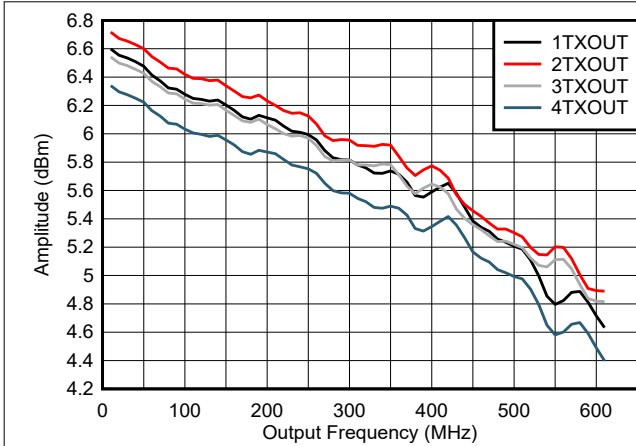

including PCB and cable losses

图 5-202. TX Output Fullscale vs Output Frequency: 5 MHz - 600 MHz

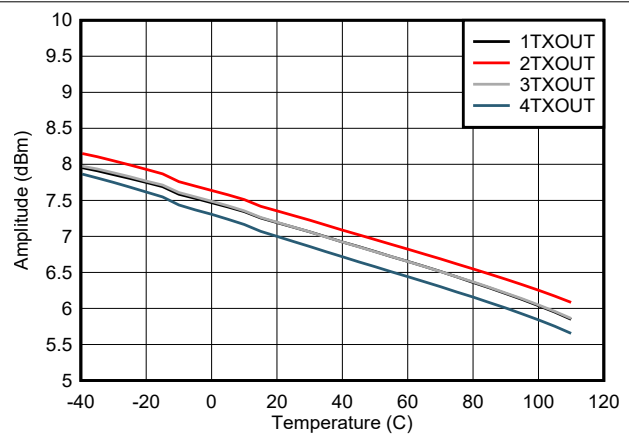

including PCB and cable losses

图 5-203. TX Output Fullscale vs Temperature at 30 MHz

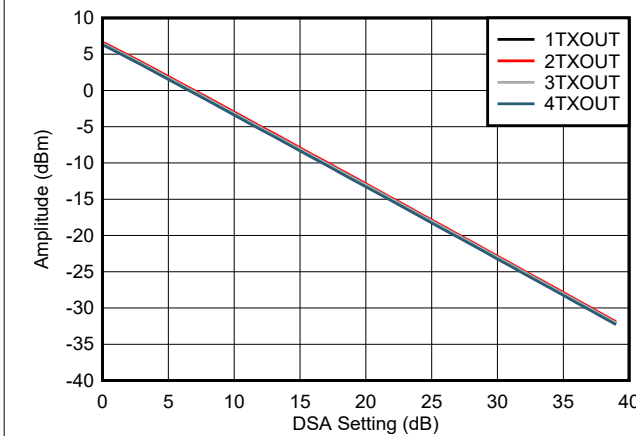

including PCB and cable losses

图 5-204. TX Output Fullscale vs DSA Setting at 30 MHz

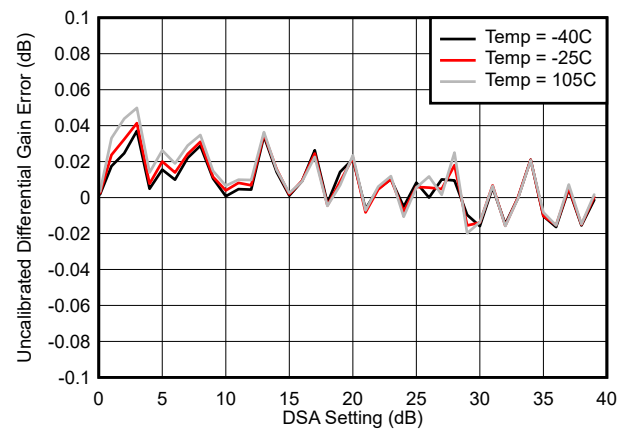

Differential Gain Error = $P_{\text{OUT}}(\text{DSA Setting} - 1) - P_{\text{OUT}}(\text{DSA Setting}) + 1$

图 5-205. Uncalibrated TX Differential Gain Error (DNL) at 30 MHz

5.12.7 TX Typical Characteristics at 30MHz and 400MHz (continued)

Typical values at $T_A = +25^\circ\text{C}$ with nominal supplies. Default conditions: TX input data rate = 125 MSPS, $f_{DAC} = 6000$ MSPS (48x interpolation), interleave mode, 1st Nyquist zone output, PLL clock mode with $f_{REF} = 500$ MHz. Additional default conditions for all plots, $A_{OUT} = -1$ dBFS, DSA = 0 dB, Sin(x)/x enabled, DSA calibrated.

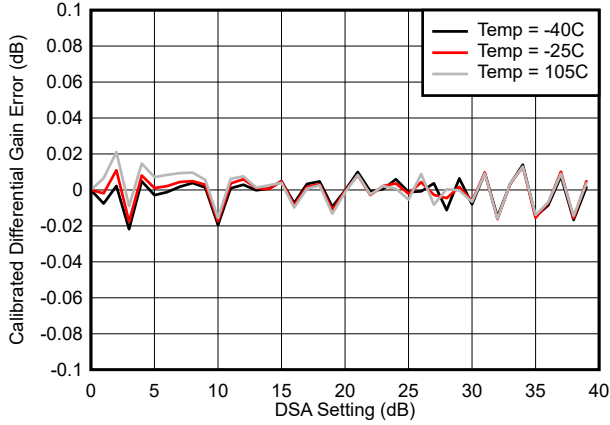

$$\text{Differential Gain Error} = P_{OUT}(\text{DSA Setting} - 1) - P_{OUT}(\text{DSA Setting}) + 1$$

图 5-206. Calibrated TX Differential Gain Error (DNL) at 30MHz

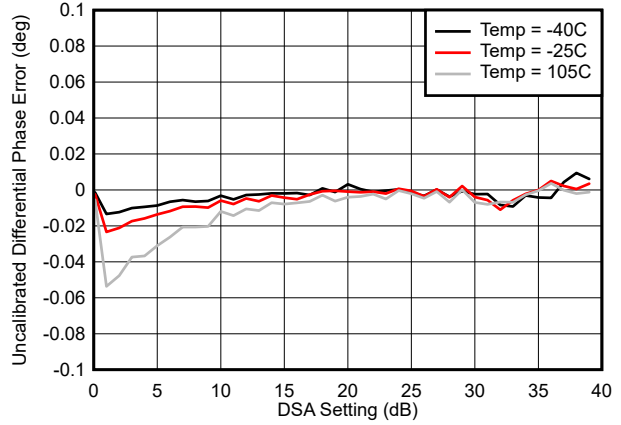

$$\text{Differential Gain Error} = P_{OUT}(\text{DSA Setting} - 1) - P_{OUT}(\text{DSA Setting}) + 1$$

图 5-207. Calibrated TX Differential Gain Error (DNL) at 30 MHz

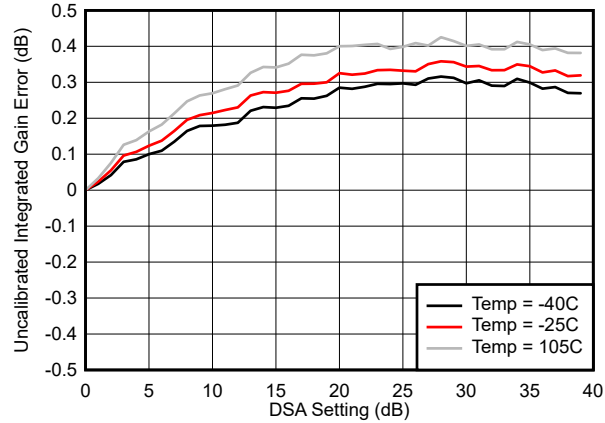

$$\text{Integrated Gain Error} = P_{OUT}(\text{DSA Setting}) - P_{OUT}(\text{DSASetting} = 0) + (\text{DSA Setting})$$

图 5-208. Uncalibrated TX Integrated Gain Error (INL) at 30 MHz

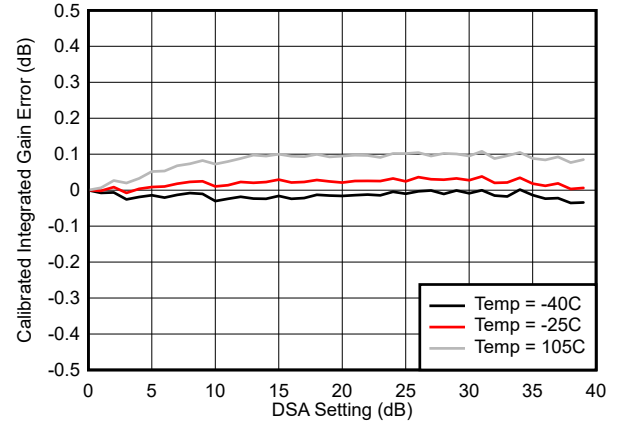

$$\text{Integrated Gain Error} = P_{OUT}(\text{DSA Setting}) - P_{OUT}(\text{DSASetting} = 0) + (\text{DSA Setting})$$

图 5-209. Calibrated TX Integrated Gain Error (INL) at 30 MHz

5.12.7 TX Typical Characteristics at 30MHz and 400MHz (continued)

Typical values at $T_A = +25^\circ\text{C}$ with nominal supplies. Default conditions: TX input data rate = 125 MSPS, $f_{\text{DAC}} = 6000$ MSPS (48x interpolation), interleave mode, 1st Nyquist zone output, PLL clock mode with $f_{\text{REF}} = 500$ MHz. Additional default conditions for all plots, $A_{\text{OUT}} = -1$ dBFS, DSA = 0 dB, Sin(x)/x enabled, DSA calibrated.

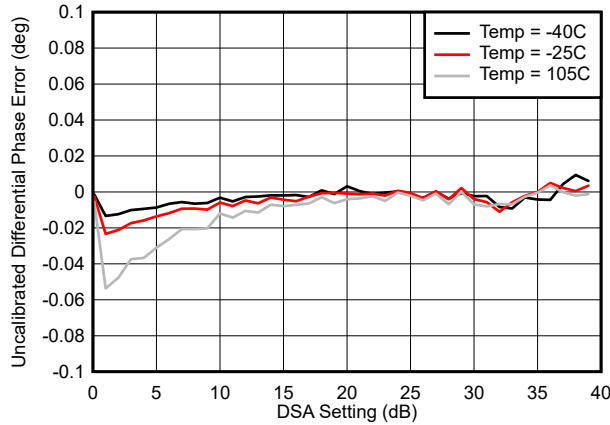

$$\text{Differential Phase Error} = \text{Phase}_{\text{OUT}}(\text{DSA Setting} - 1) - \text{Phase}_{\text{OUT}}(\text{DSA Setting})$$

图 5-210. Uncalibrated TX Differential Phase Error (DNL) at 30 MHz

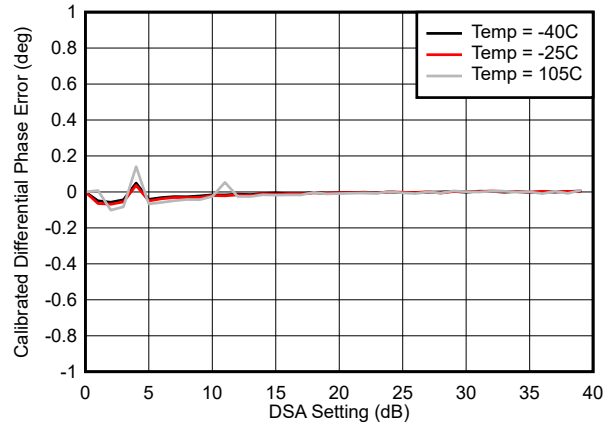

$$\text{Differential Phase Error} = \text{Phase}_{\text{OUT}}(\text{DSA Setting} - 1) - \text{Phase}_{\text{OUT}}(\text{DSA Setting})$$

图 5-211. Calibrated TX Differential Phase Error (DNL) at 30 MHz

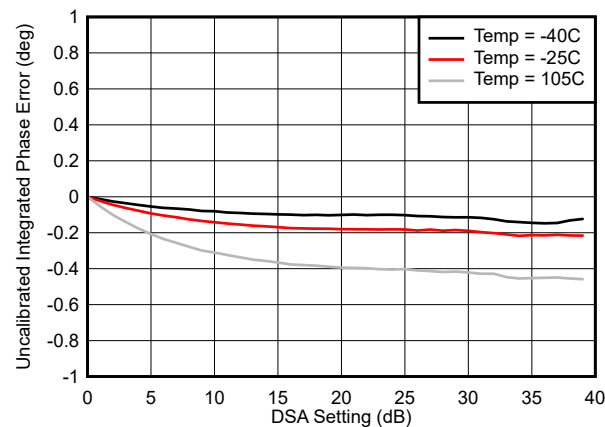

$$\text{Integrated Phase Error} = \text{Phase}_{\text{OUT}}(\text{DSA Setting}) - \text{Phase}_{\text{OUT}}(\text{DSASetting} = 0)$$

图 5-212. Uncalibrated TX Integrated Phase Error (INL) at 30 MHz

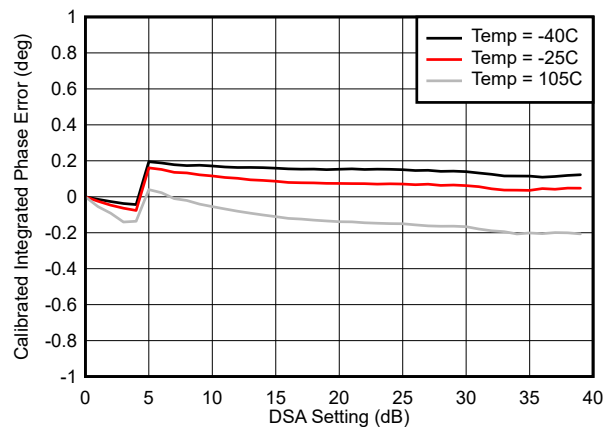

$$\text{Integrated Phase Error} = \text{Phase}_{\text{OUT}}(\text{DSA Setting}) - \text{Phase}_{\text{OUT}}(\text{DSASetting} = 0)$$

图 5-213. Calibrated TX Integrated Phase Error (INL) at 30 MHz

5.12.7 TX Typical Characteristics at 30MHz and 400MHz (continued)

Typical values at $T_A = +25^\circ\text{C}$ with nominal supplies. Default conditions: TX input data rate = 125 MSPS, $f_{\text{DAC}} = 6000$ MSPS (48x interpolation), interleave mode, 1st Nyquist zone output, PLL clock mode with $f_{\text{REF}} = 500$ MHz. Additional default conditions for all plots, $A_{\text{OUT}} = -1$ dBFS, DSA = 0 dB, Sin(x)/x enabled, DSA calibrated.



图 5-214. Single Tone Spectrum at 5 MHz and -1 dBFS (0 - 100 MHz)



图 5-215. Single Tone Spectrum at 5 MHz and -6 dBFS (0 - 100 MHz)

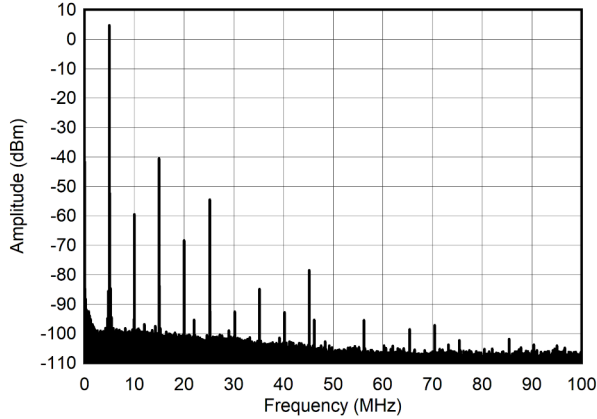

图 5-216. Single Tone Spectrum at 5 MHz and -12 dBFS (0 - 100 MHz)

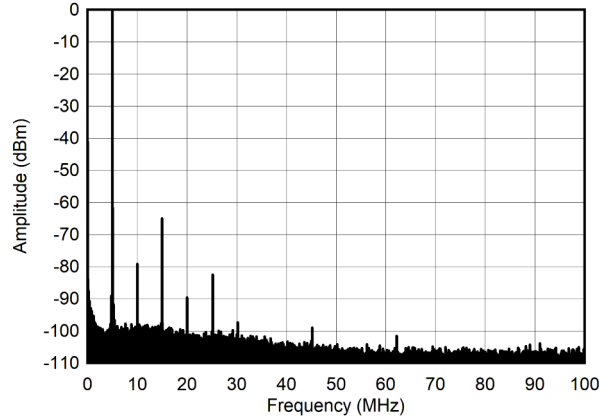

图 5-217. Single Tone Spectrum at 5 MHz and -30 dBFS (0 - 100 MHz)

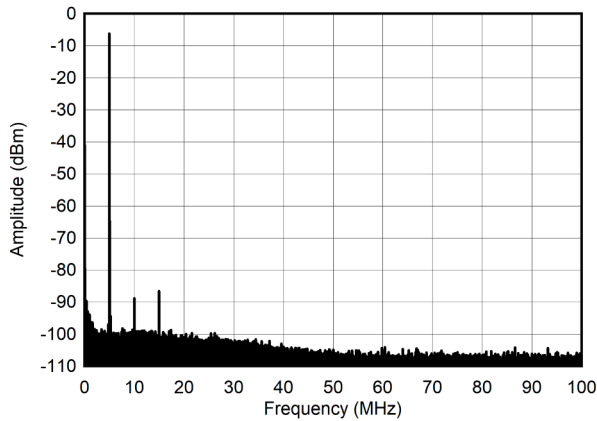

图 5-218. Single Tone Spectrum at 5 MHz and -60 dBFS (0 - 100 MHz)

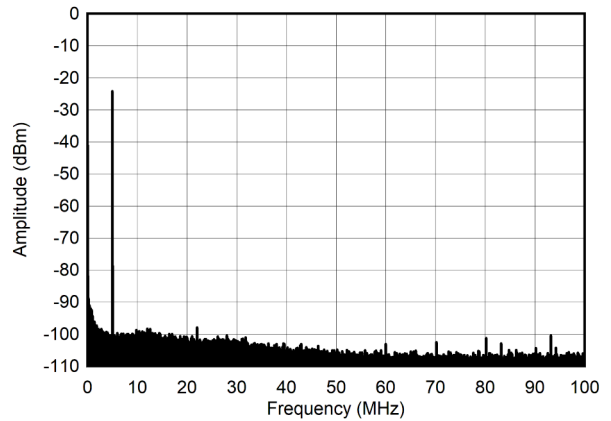

图 5-219. Single Tone Spectrum at 30 MHz and -1 dBFS (Nyquist)

5.12.7 TX Typical Characteristics at 30MHz and 400MHz (continued)

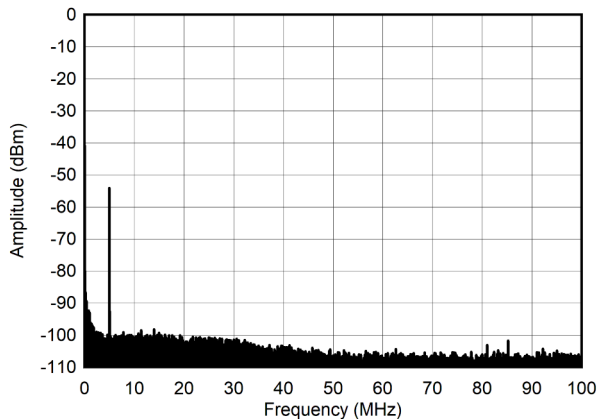
Typical values at $T_A = +25^\circ\text{C}$ with nominal supplies. Default conditions: TX input data rate = 125 MSPS, $f_{\text{DAC}} = 6000$ MSPS (48x interpolation), interleave mode, 1st Nyquist zone output, PLL clock mode with $f_{\text{REF}} = 500$ MHz. Additional default conditions for all plots, $A_{\text{OUT}} = -1$ dBFS, DSA = 0 dB, Sin(x)/x enabled, DSA calibrated.

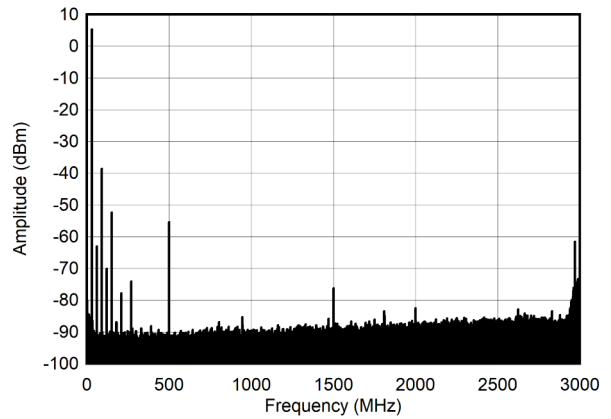
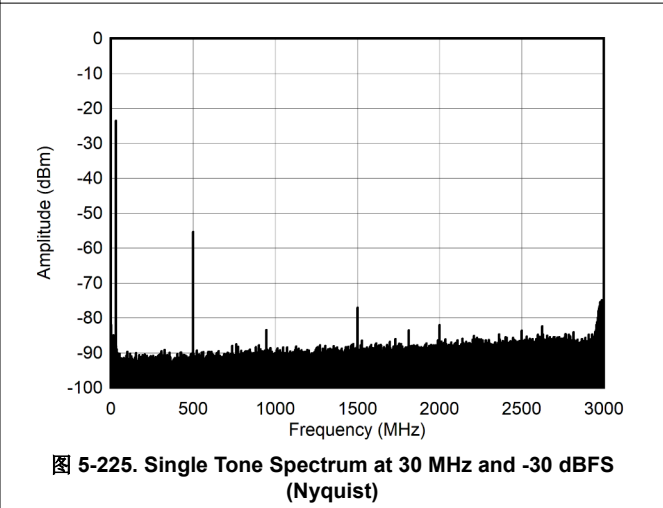
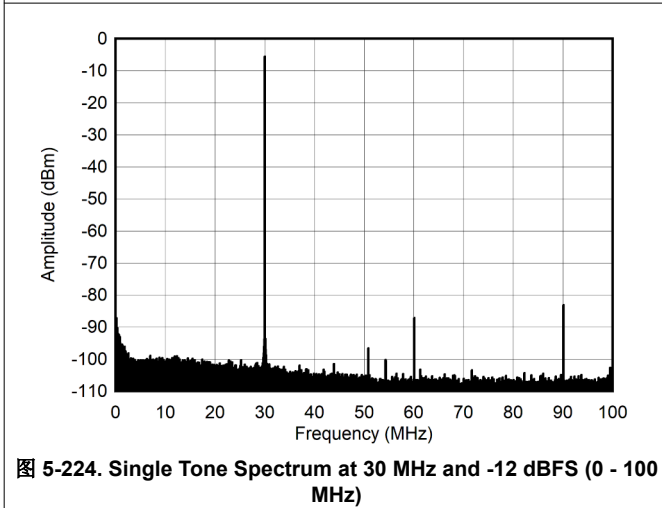
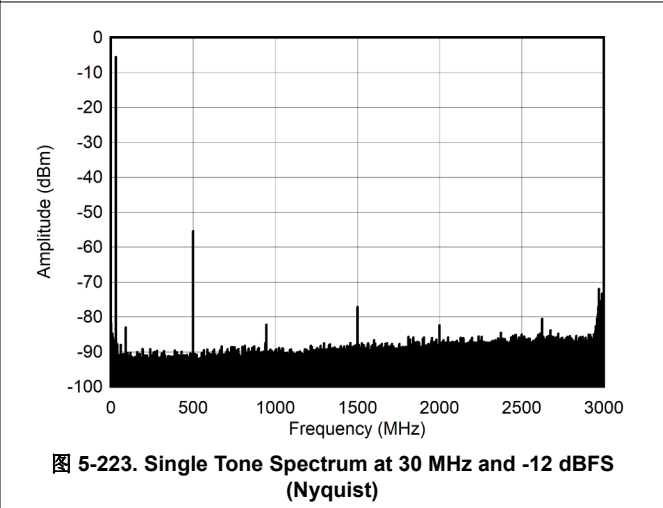
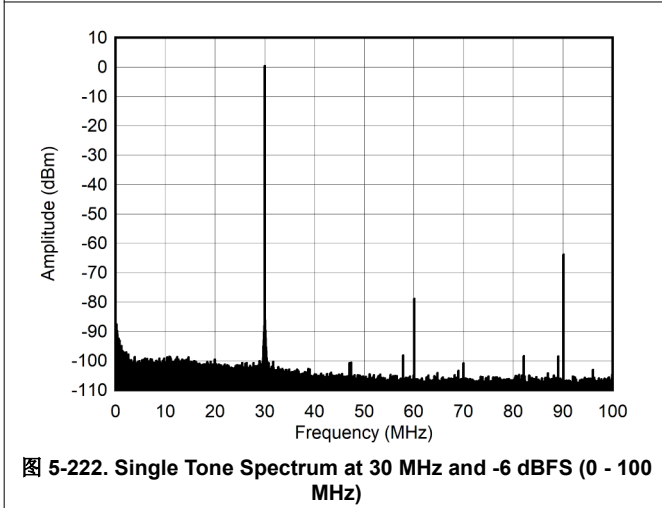
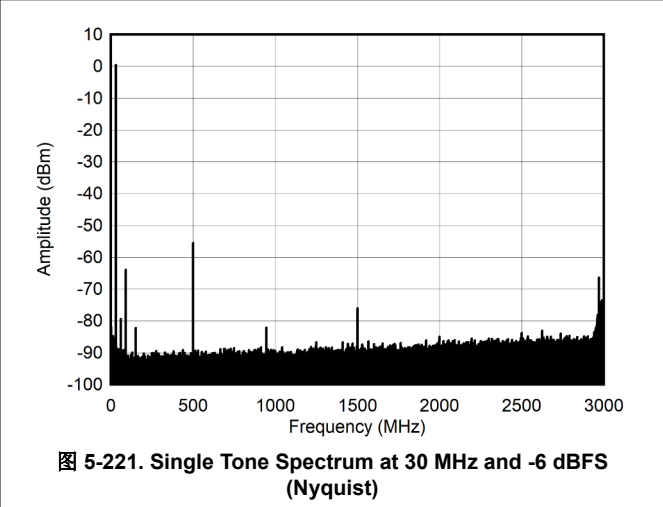
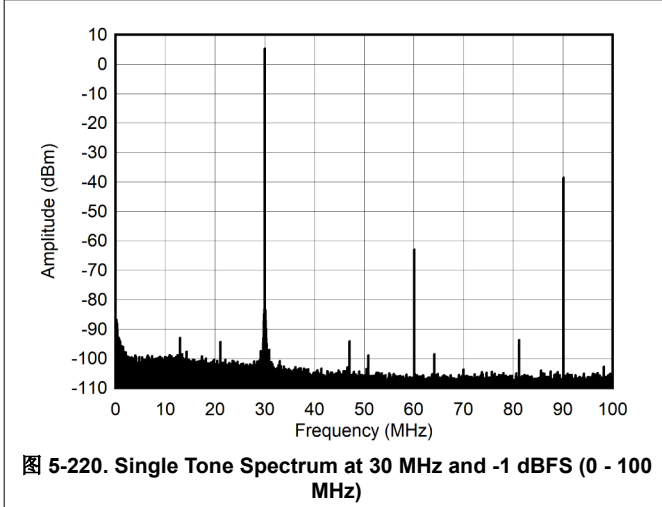

5.12.7 TX Typical Characteristics at 30MHz and 400MHz (continued)

Typical values at $T_A = +25^\circ\text{C}$ with nominal supplies. Default conditions: TX input data rate = 125 MSPS, $f_{\text{DAC}} = 6000$ MSPS (48x interpolation), interleave mode, 1st Nyquist zone output, PLL clock mode with $f_{\text{REF}} = 500$ MHz. Additional default conditions for all plots, $A_{\text{OUT}} = -1$ dBFS, DSA = 0 dB, Sin(x)/x enabled, DSA calibrated.

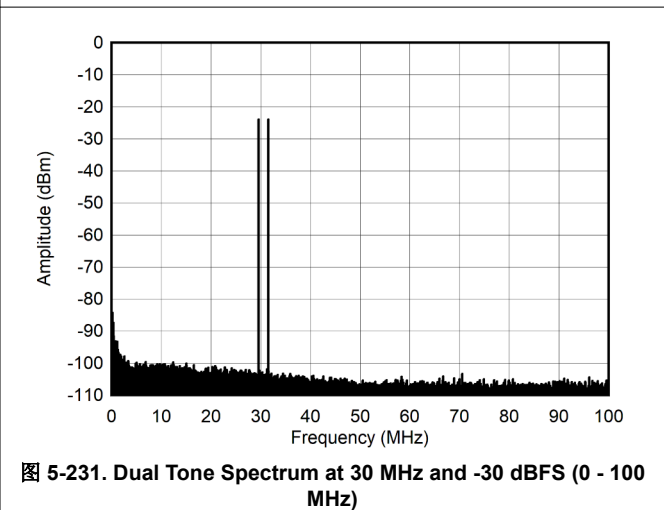
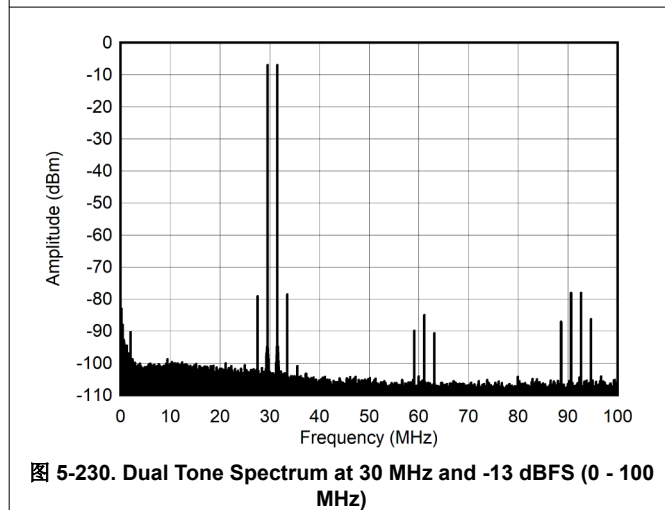
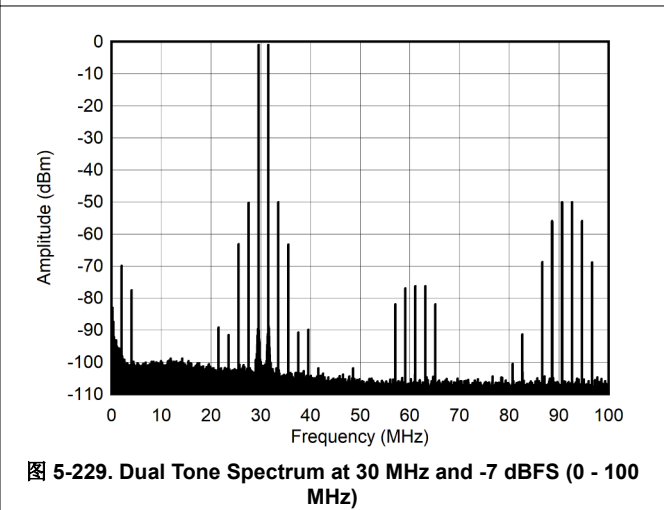
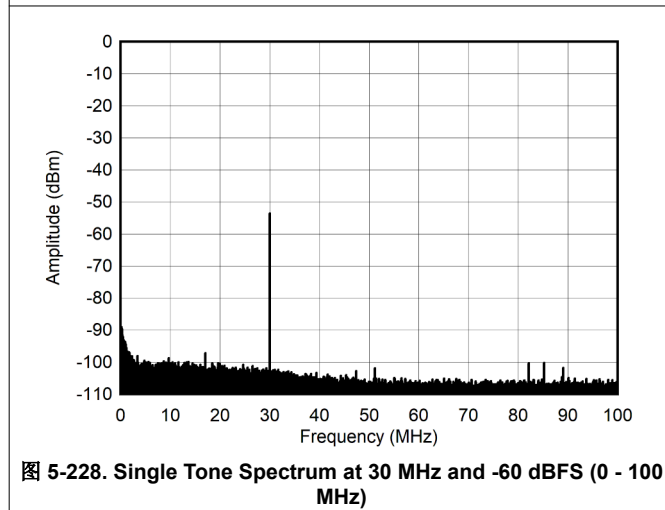
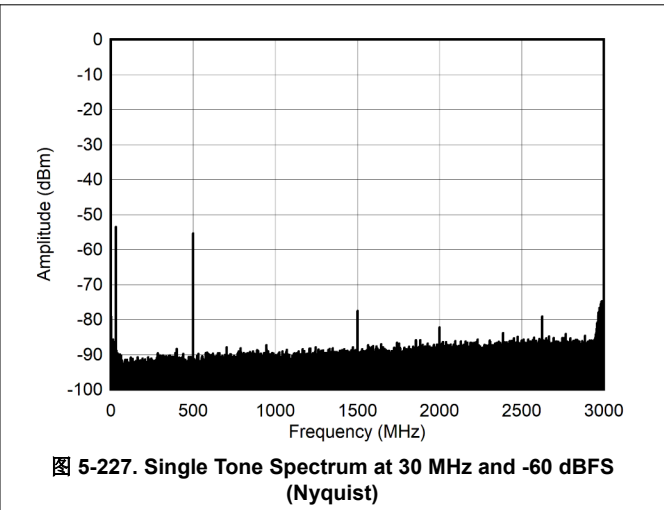
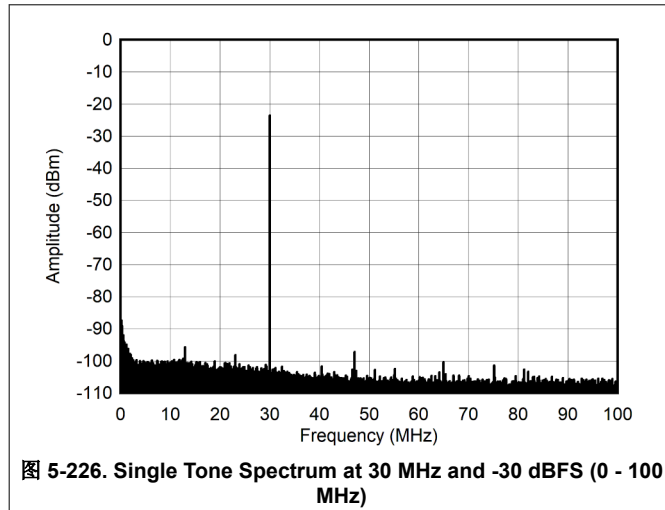

5.12.7 TX Typical Characteristics at 30MHz and 400MHz (continued)

Typical values at $T_A = +25^\circ\text{C}$ with nominal supplies. Default conditions: TX input data rate = 125 MSPS, $f_{DAC} = 6000$ MSPS (48x interpolation), interleave mode, 1st Nyquist zone output, PLL clock mode with $f_{REF} = 500$ MHz. Additional default conditions for all plots, $A_{OUT} = -1$ dBFS, DSA = 0 dB, Sin(x)/x enabled, DSA calibrated.

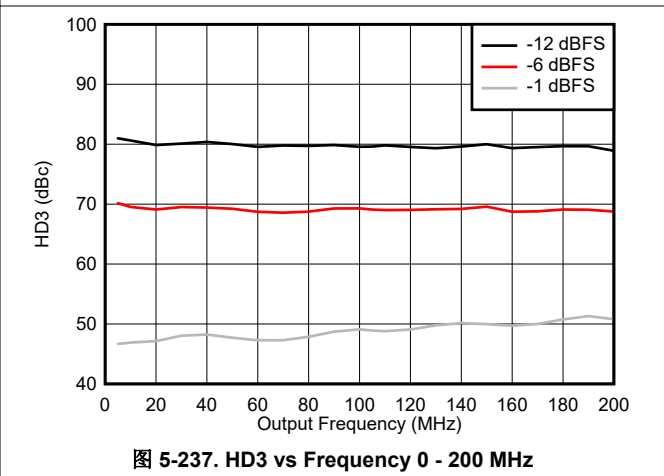
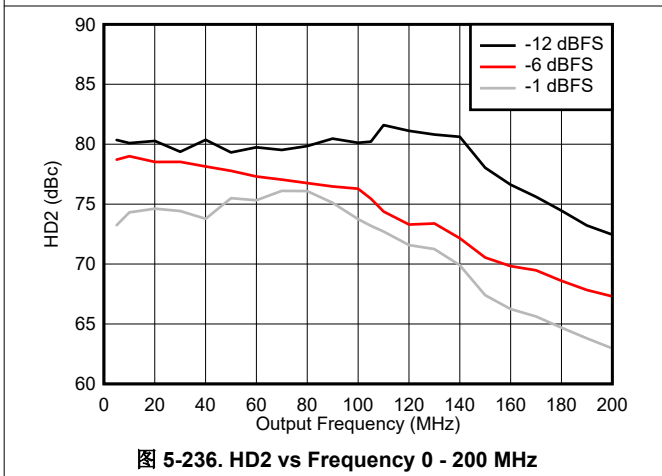
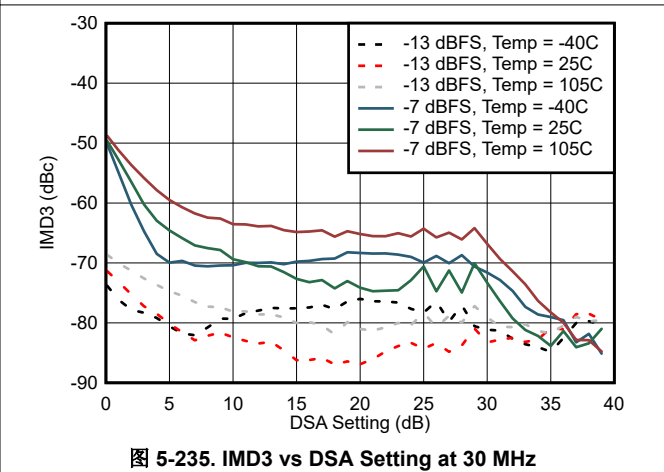
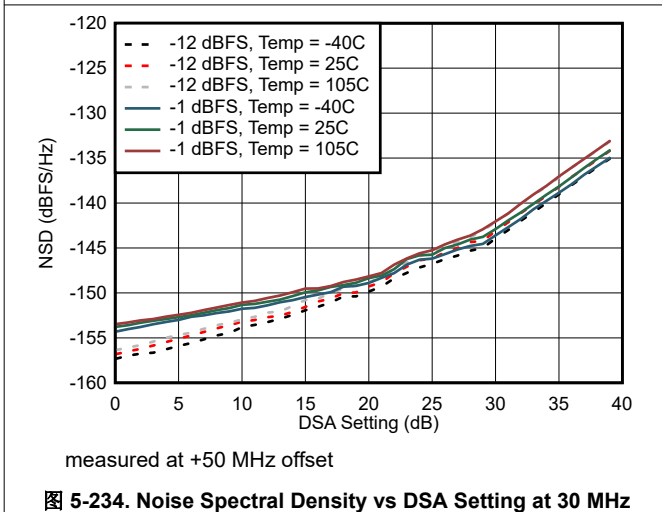
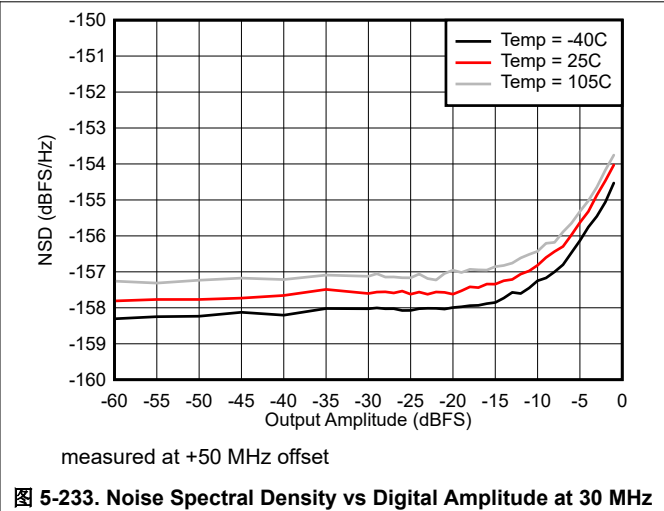
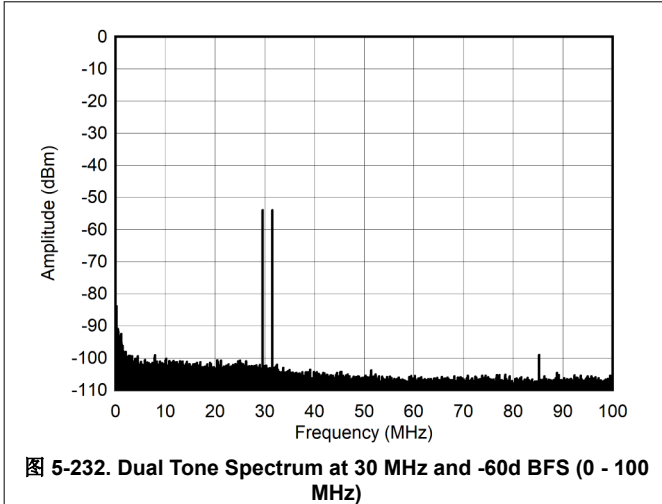

5.12.7 TX Typical Characteristics at 30MHz and 400MHz (continued)

Typical values at $T_A = +25^\circ\text{C}$ with nominal supplies. Default conditions: TX input data rate = 125 MSPS, $f_{\text{DAC}} = 6000$ MSPS (48x interpolation), interleave mode, 1st Nyquist zone output, PLL clock mode with $f_{\text{REF}} = 500$ MHz. Additional default conditions for all plots, $A_{\text{OUT}} = -1$ dBFS, DSA = 0 dB, Sin(x)/x enabled, DSA calibrated.

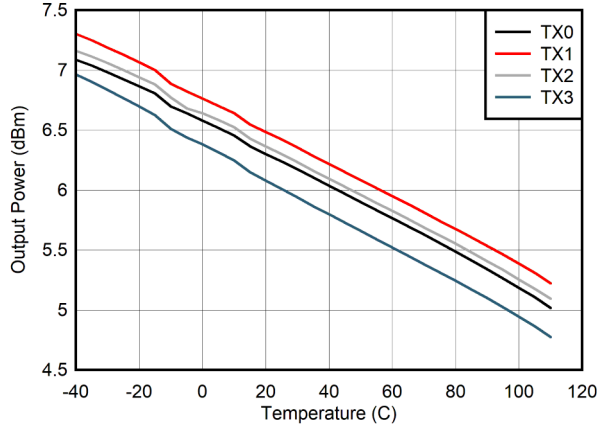

including PCB and cable losses

图 5-238. TX Output Fullscale vs Temperature at 400 MHz

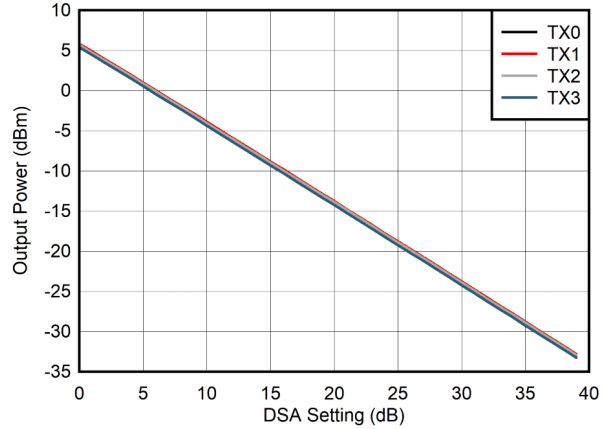

including PCB and cable losses

图 5-239. TX Output Fullscale vs DSA Setting at 400 MHz

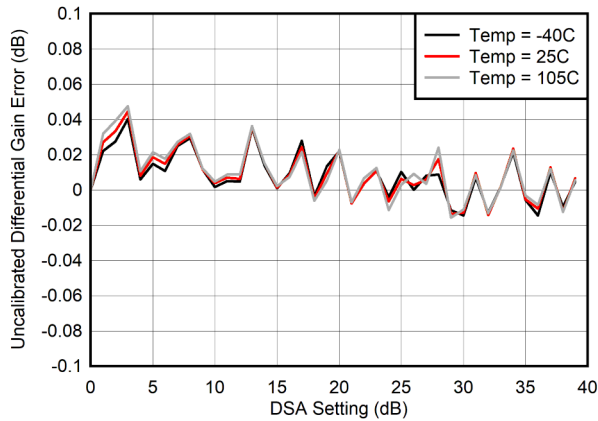

Differential Gain Error = $P_{\text{OUT}}(\text{DSA Setting} - 1) - P_{\text{OUT}}(\text{DSA Setting}) + 1$

图 5-240. Uncalibrated TX Differential Gain Error (DNL) at 400 MHz

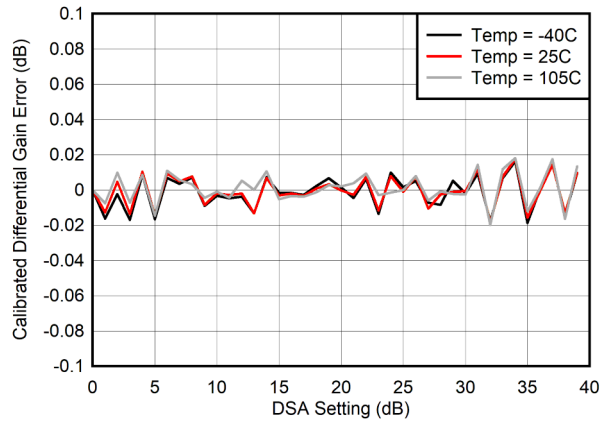

Differential Gain Error = $P_{\text{OUT}}(\text{DSA Setting} - 1) - P_{\text{OUT}}(\text{DSA Setting}) + 1$

图 5-241. Calibrated TX Differential Gain Error (DNL) at 400 MHz

5.12.7 TX Typical Characteristics at 30MHz and 400MHz (continued)

Typical values at $T_A = +25^\circ\text{C}$ with nominal supplies. Default conditions: TX input data rate = 125 MSPS, $f_{\text{DAC}} = 6000$ MSPS (48x interpolation), interleave mode, 1st Nyquist zone output, PLL clock mode with $f_{\text{REF}} = 500$ MHz. Additional default conditions for all plots, $A_{\text{OUT}} = -1$ dBFS, DSA = 0 dB, Sin(x)/x enabled, DSA calibrated.

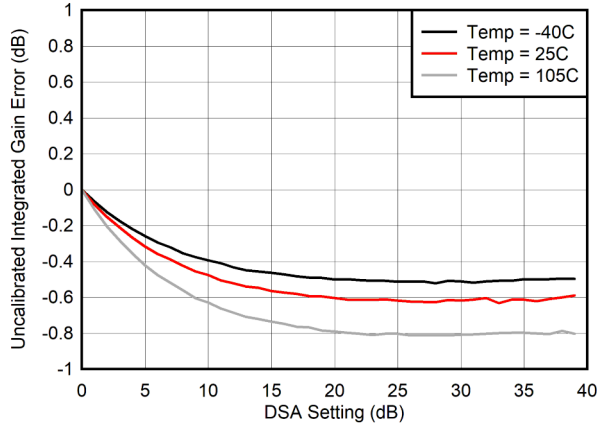

$$\text{Integrated Gain Error} = P_{\text{OUT}}(\text{DSA Setting}) - P_{\text{OUT}}(\text{DSASetting} = 0) + (\text{DSA Setting})$$

图 5-242. Uncalibrated TX Integrated Gain Error (INL) at 400 MHz

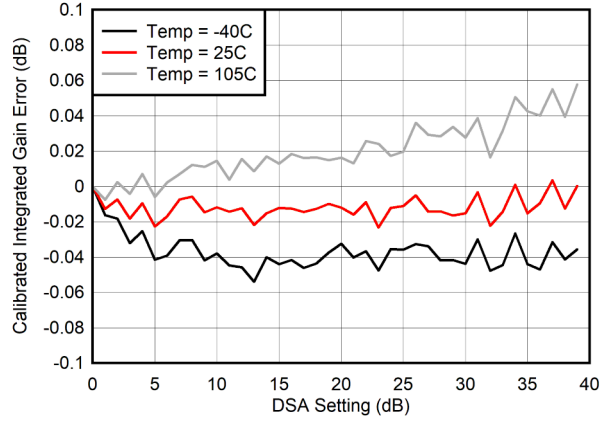

$$\text{Integrated Gain Error} = P_{\text{OUT}}(\text{DSA Setting}) - P_{\text{OUT}}(\text{DSASetting} = 0) + (\text{DSA Setting})$$

图 5-243. Calibrated TX Integrated Gain Error (INL) at 400 MHz

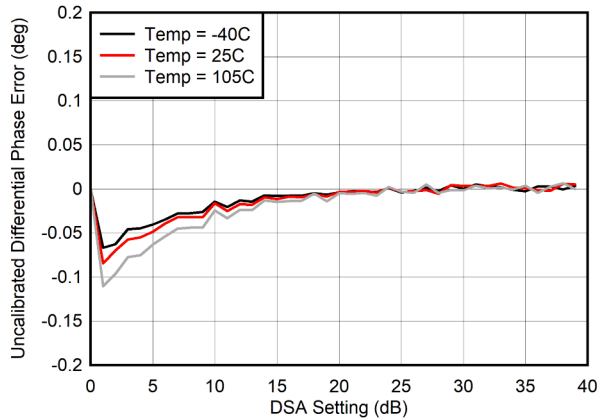

$$\text{Differential Phase Error} = \text{Phase}_{\text{OUT}}(\text{DSA Setting} - 1) - \text{Phase}_{\text{OUT}}(\text{DSA Setting})$$

图 5-244. Uncalibrated TX Differential Phase Error (DNL) at 400 MHz

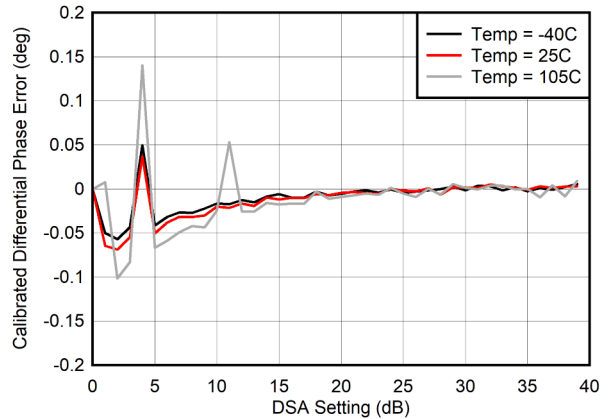

$$\text{Differential Phase Error} = \text{Phase}_{\text{OUT}}(\text{DSA Setting} - 1) - \text{Phase}_{\text{OUT}}(\text{DSA Setting})$$

图 5-245. Calibrated TX Differential Phase Error (DNL) at 400 MHz

5.12.7 TX Typical Characteristics at 30MHz and 400MHz (continued)

Typical values at $T_A = +25^\circ\text{C}$ with nominal supplies. Default conditions: TX input data rate = 125 MSPS, $f_{DAC} = 6000$ MSPS (48x interpolation), interleave mode, 1st Nyquist zone output, PLL clock mode with $f_{REF} = 500$ MHz. Additional default conditions for all plots, $A_{OUT} = -1$ dBFS, DSA = 0 dB, Sin(x)/x enabled, DSA calibrated.

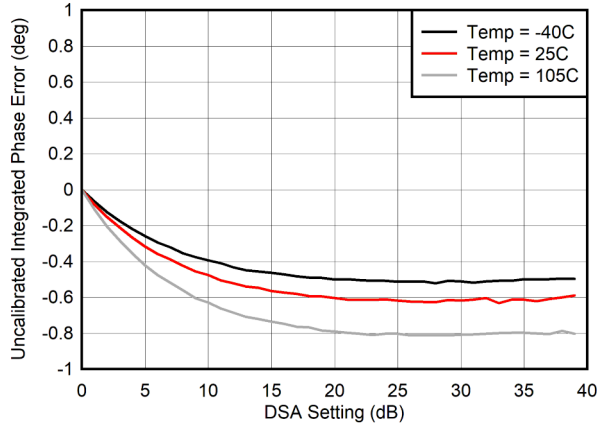

$$\text{Integrated Phase Error} = \text{Phase}_{OUT}(\text{DSA Setting}) - \text{Phase}_{OUT}(\text{DSASetting} = 0)$$

图 5-246. Uncalibrated TX Integrated Phase Error (INL) at 400 MHz

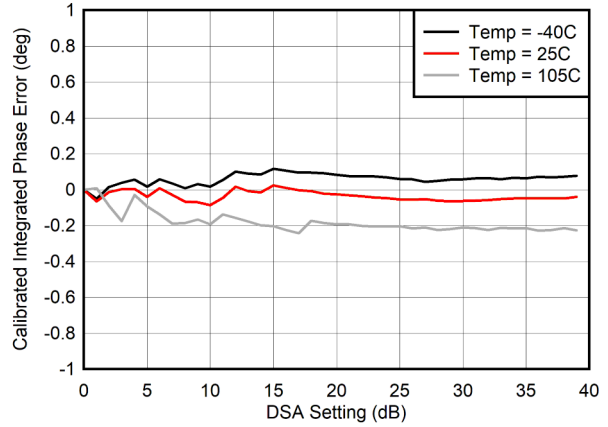

$$\text{Integrated Phase Error} = \text{Phase}_{OUT}(\text{DSA Setting}) - \text{Phase}_{OUT}(\text{DSASetting} = 0)$$

图 5-247. Calibrated TX Integrated Phase Error (INL) at 400 MHz



图 5-248. Single Tone Spectrum at 400 MHz and -1 dBFS (Nyquist)



图 5-249. Single Tone Spectrum at 400 MHz and -1 dBFS (±100MHz)

5.12.7 TX Typical Characteristics at 30MHz and 400MHz (continued)

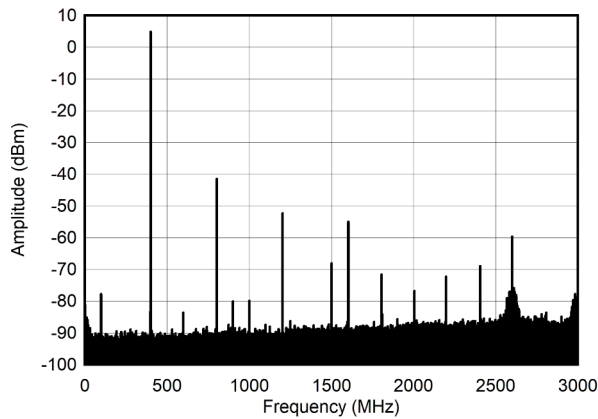
Typical values at $T_A = +25^\circ\text{C}$ with nominal supplies. Default conditions: TX input data rate = 125 MSPS, $f_{\text{DAC}} = 6000$ MSPS (48x interpolation), interleave mode, 1st Nyquist zone output, PLL clock mode with $f_{\text{REF}} = 500$ MHz. Additional default conditions for all plots, $A_{\text{OUT}} = -1$ dBFS, DSA = 0 dB, Sin(x)/x enabled, DSA calibrated.

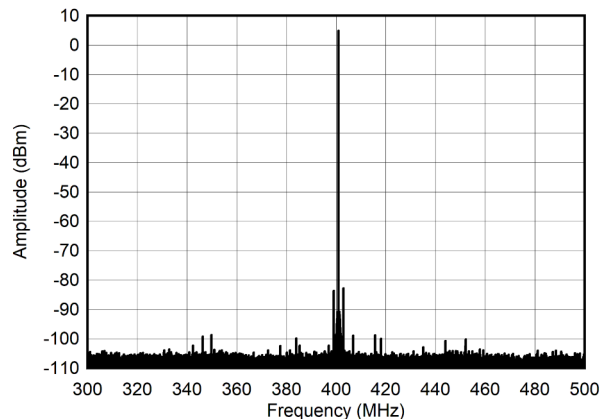

图 5-250. Single Tone Spectrum at 400 MHz and -6 dBFS (Nyquist)



图 5-251. Single Tone Spectrum at 400 MHz and -6 dBFS ($\pm 100\text{MHz}$)

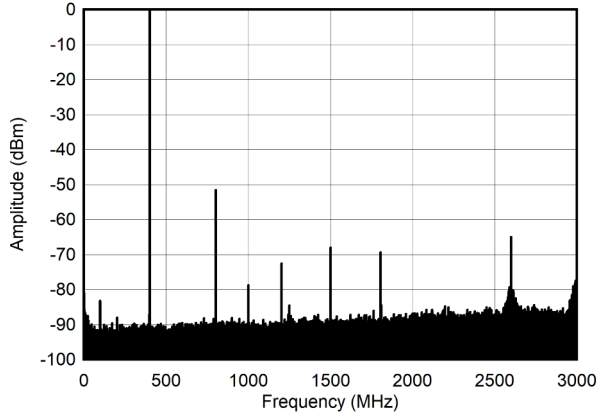

图 5-252. Single Tone Spectrum at 400 MHz and -12 dBFS (Nyquist)

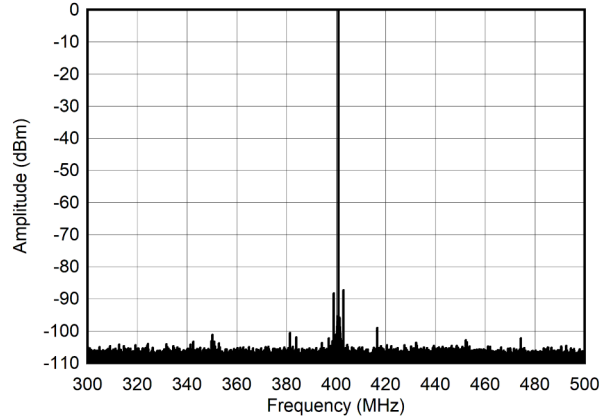

图 5-253. Single Tone Spectrum at 400 MHz and -12 dBFS ($\pm 100\text{MHz}$)

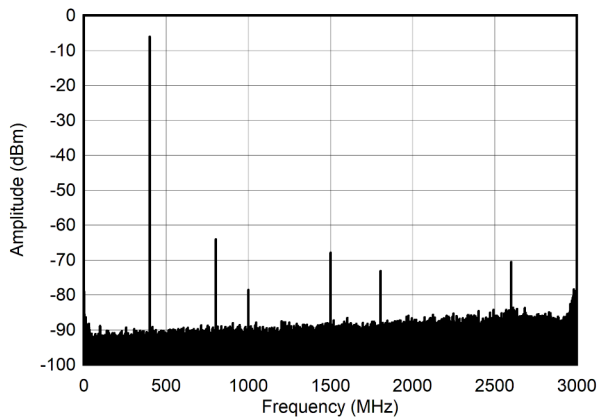

图 5-254. Single Tone Spectrum at 400 MHz and -30 dBFS (Nyquist)

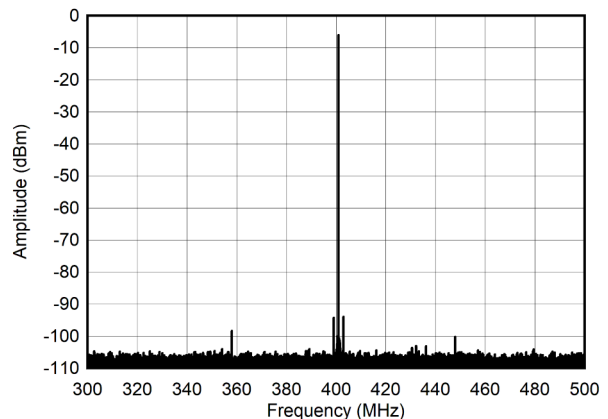

图 5-255. Single Tone Spectrum at 400 MHz and -30 dBFS ($\pm 100\text{MHz}$)

5.12.7 TX Typical Characteristics at 30MHz and 400MHz (continued)

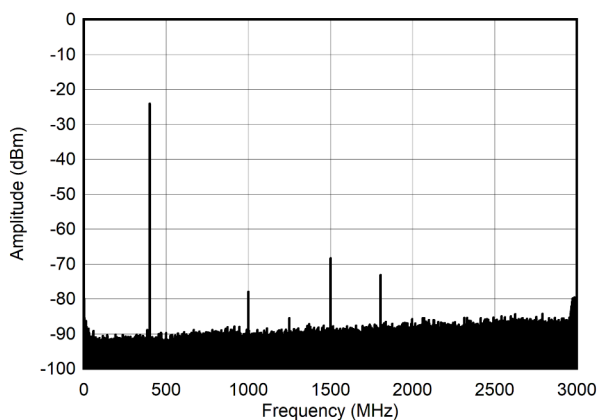
Typical values at $T_A = +25^\circ\text{C}$ with nominal supplies. Default conditions: TX input data rate = 125 MSPS, $f_{DAC} = 6000$ MSPS (48x interpolation), interleave mode, 1st Nyquist zone output, PLL clock mode with $f_{REF} = 500$ MHz. Additional default conditions for all plots, $A_{OUT} = -1$ dBFS, DSA = 0 dB, Sin(x)/x enabled, DSA calibrated.

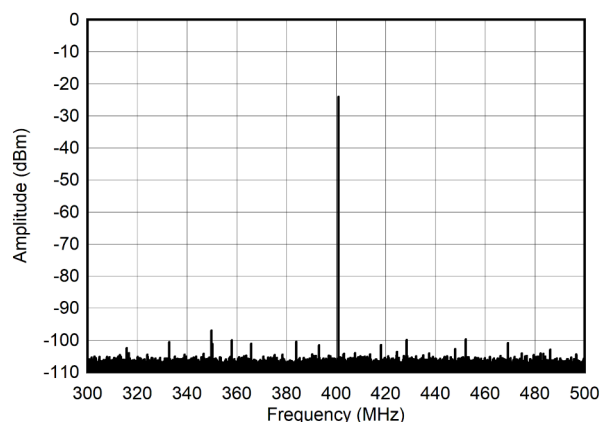

图 5-256. Single Tone Spectrum at 400 MHz and -60 dBFS (Nyquist)



图 5-257. Single Tone Spectrum at 400 MHz and -60 dBFS (±100MHz)

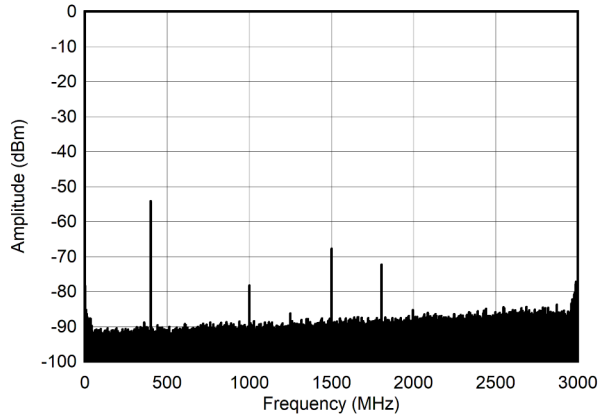

Tone Spacing = 4 MHz

图 5-258. Dual Tone Spectrum at 400 MHz and -7 dBFS (Nyquist)

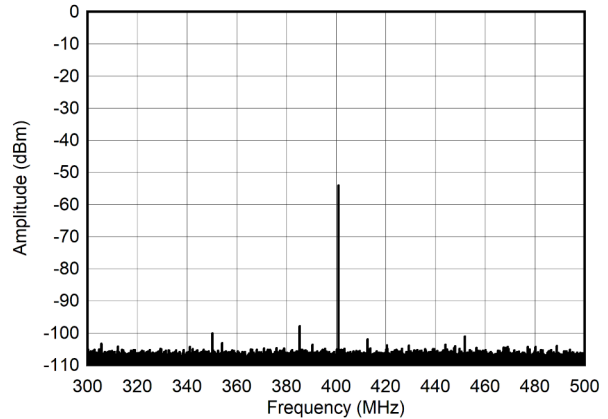
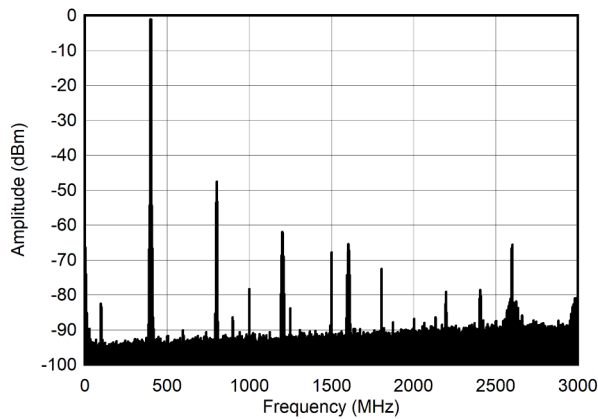
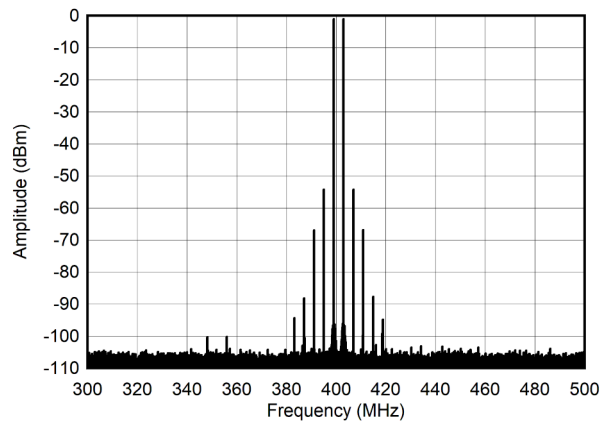

Tone Spacing = 4 MHz

图 5-259. Dual Tone Spectrum at 400 MHz and -7 dBFS (±100MHz)

5.12.7 TX Typical Characteristics at 30MHz and 400MHz (continued)

Typical values at $T_A = +25^\circ\text{C}$ with nominal supplies. Default conditions: TX input data rate = 125 MSPS, $f_{\text{DAC}} = 6000$ MSPS (48x interpolation), interleave mode, 1st Nyquist zone output, PLL clock mode with $f_{\text{REF}} = 500$ MHz. Additional default conditions for all plots, $A_{\text{OUT}} = -1$ dBFS, DSA = 0 dB, Sin(x)/x enabled, DSA calibrated.

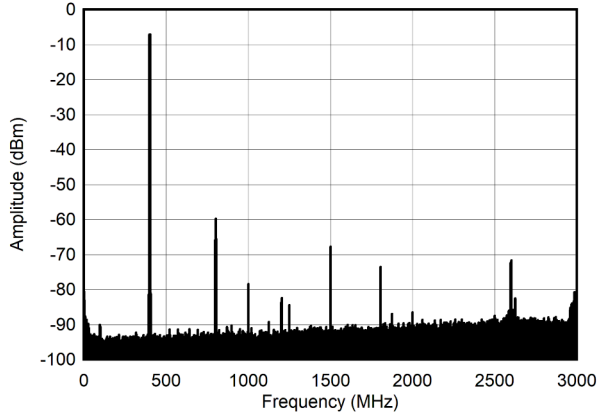

Tone Spacing = 4 MHz

图 5-260. Dual Tone Spectrum at 400 MHz and -13 dBFS (Nyquist)

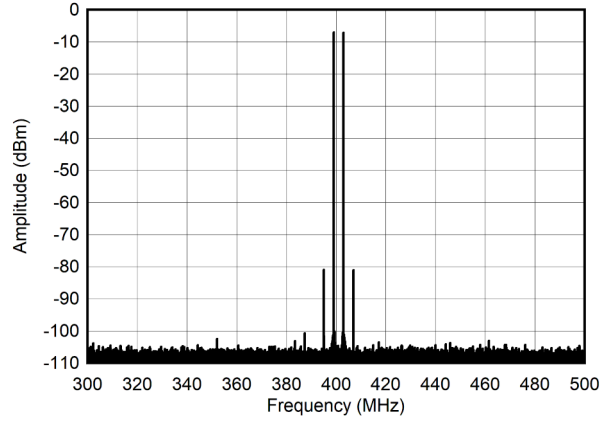

Tone Spacing = 4 MHz

图 5-261. Dual Tone Spectrum at 400 MHz and -13 dBFS (± 100 MHz)

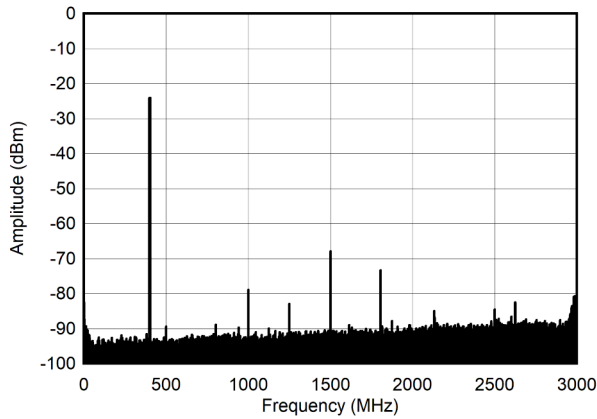

Tone Spacing = 4 MHz

图 5-262. Dual Tone Spectrum at 400 MHz and -30 dBFS (Nyquist)

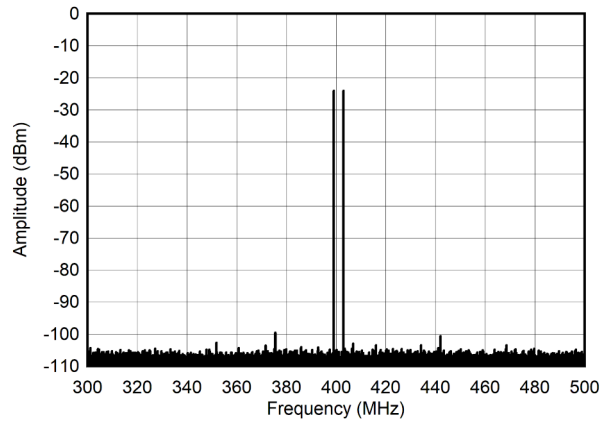

Tone Spacing = 4 MHz

图 5-263. Dual Tone Spectrum at 400 MHz and -30 dBFS (± 100 MHz)

5.12.7 TX Typical Characteristics at 30MHz and 400MHz (continued)

Typical values at $T_A = +25^\circ\text{C}$ with nominal supplies. Default conditions: TX input data rate = 125 MSPS, $f_{DAC} = 6000$ MSPS (48x interpolation), interleave mode, 1st Nyquist zone output, PLL clock mode with $f_{REF} = 500$ MHz. Additional default conditions for all plots, $A_{OUT} = -1$ dBFS, DSA = 0 dB, Sin(x)/x enabled, DSA calibrated.

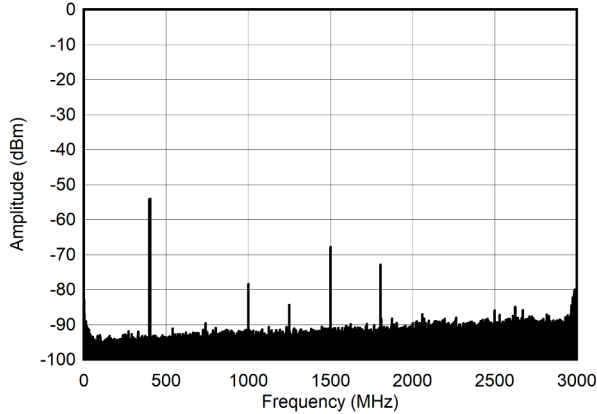

Tone Spacing = 4 MHz

图 5-264. Dual Tone Spectrum at 400 MHz and -60 dBFS (Nyquist)

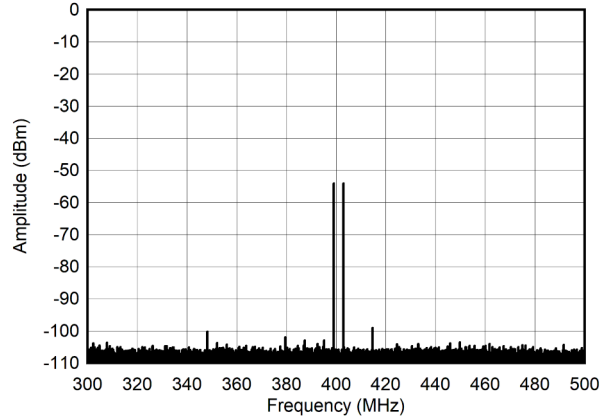

Tone Spacing = 4 MHz

图 5-265. Dual Tone Spectrum at 400 MHz and -60 dBFS ($\pm 100\text{MHz}$)

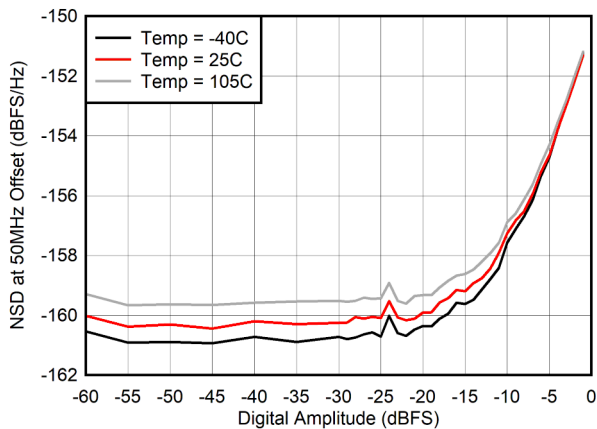

measured at 50 MHz offset

图 5-266. Noise Spectral Density vs Digital Amplitude at 400 MHz

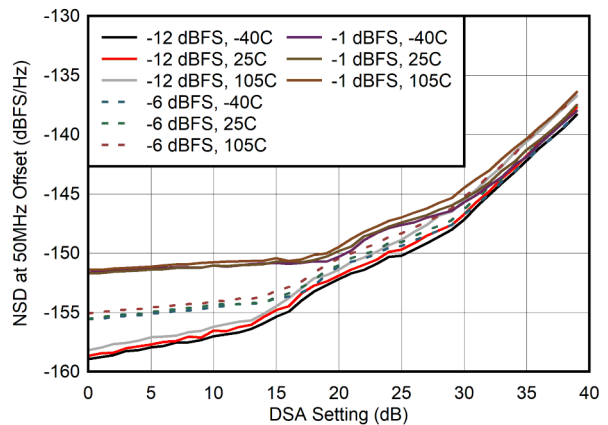

measured at 50 MHz offset

图 5-267. Noise Spectral Density vs DSA Setting at 400 MHz

5.12.7 TX Typical Characteristics at 30MHz and 400MHz (continued)

Typical values at $T_A = +25^\circ\text{C}$ with nominal supplies. Default conditions: TX input data rate = 125 MSPS, $f_{\text{DAC}} = 6000$ MSPS (48x interpolation), interleave mode, 1st Nyquist zone output, PLL clock mode with $f_{\text{REF}} = 500$ MHz. Additional default conditions for all plots, $A_{\text{OUT}} = -1$ dBFS, DSA = 0 dB, Sin(x)/x enabled, DSA calibrated.

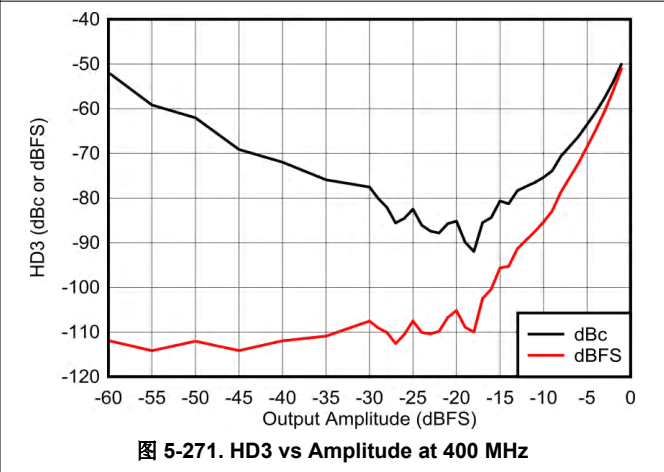
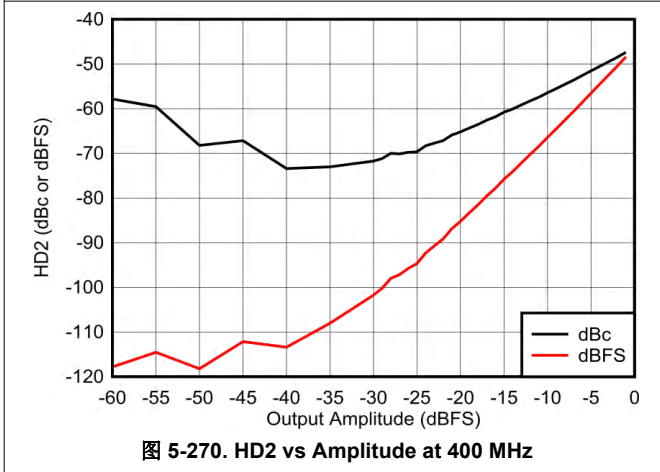
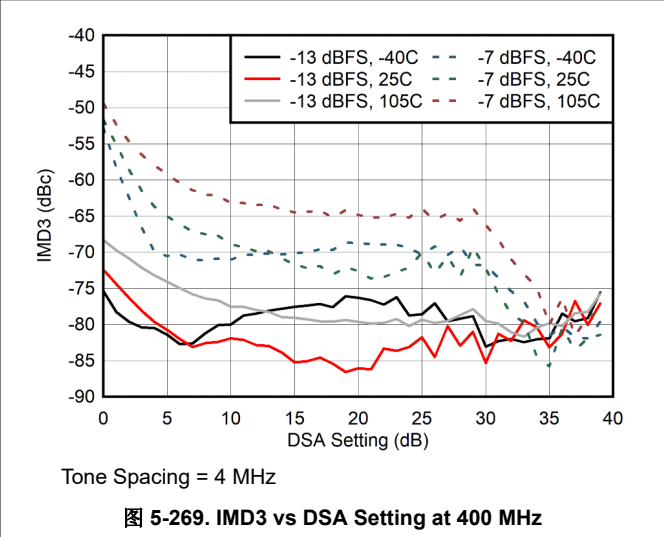
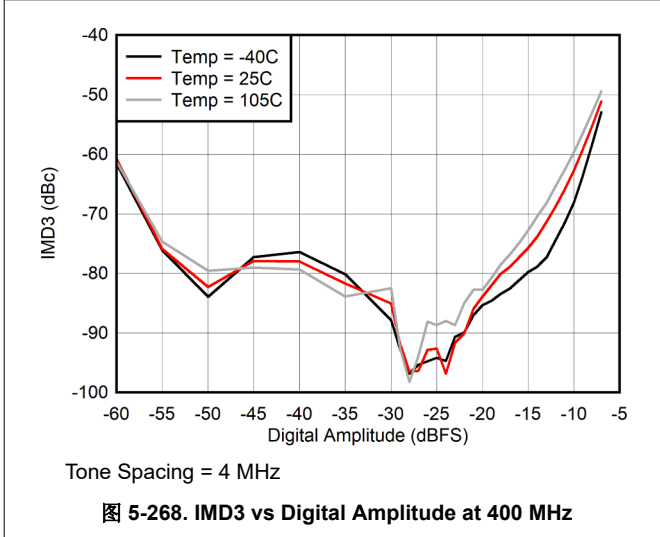

5.12.8 TX Typical Characteristics at 800MHz

Typical values at $T_A = +25^\circ\text{C}$ with nominal supplies. Unless otherwise noted, TX input data rate = 491.52MSPS, $f_{DAC} = 11796.48\text{MSPS}$, interleave mode, $A_{OUT} = -1\text{ dBFS}$, 1st Nyquist zone output, Internal PLL, $f_{REF} = 491.52\text{MSPS}$, 24x Interpolation, DSA = 0 dB, $\text{Sin}(x)/x$ enabled, DSA calibrated.

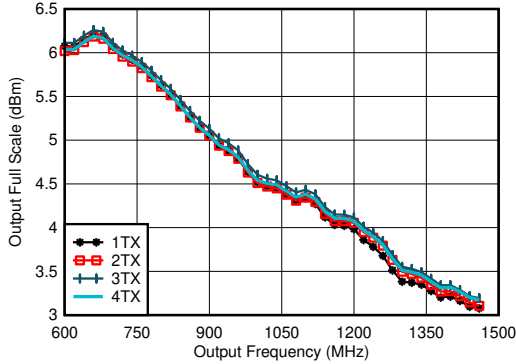

Including PCB and cable losses, $A_{out} = -0.5\text{dFBS}$, DSA = 0, 0.8 GHz matching

图 5-272. TX Full Scale vs RF Frequency and Channel at 5898.24MSPS, Straight Mode

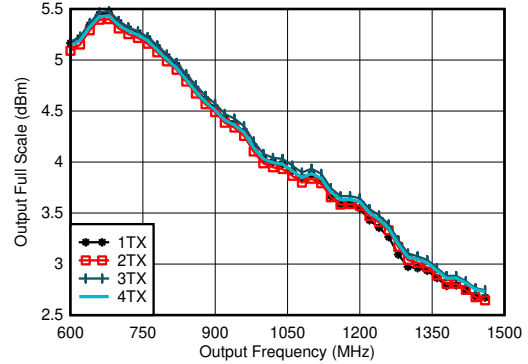

Including PCB and cable losses, $A_{out} = -0.5\text{dFBS}$, DSA = 0, 0.8 GHz matching

图 5-273. TX Full Scale vs RF Frequency and Channel at 8847.36MSPS, Straight Mode

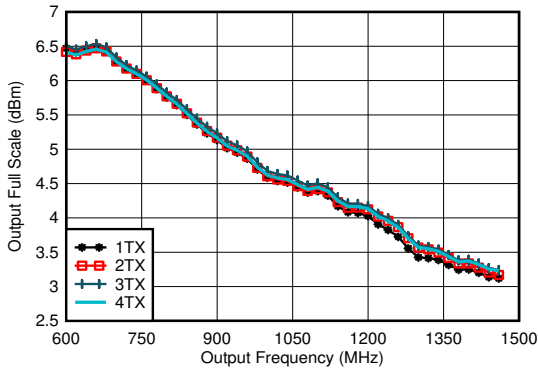

Including PCB and cable losses, $A_{out} = -0.5\text{dFBS}$, DSA = 0, 0.8 GHz matching

图 5-274. TX Full Scale vs RF Frequency and Channel at 5898.24MSPS, Interleave Mode

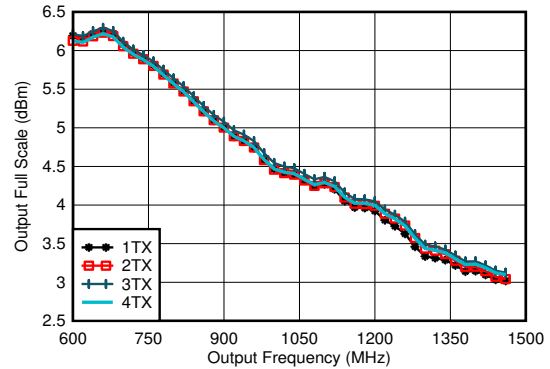

Including PCB and cable losses, $A_{out} = -0.5\text{dFBS}$, DSA = 0, 0.8 GHz matching

图 5-275. TX Full Scale vs RF Frequency and Channel at 8847.36MSPS, Interleave Mode

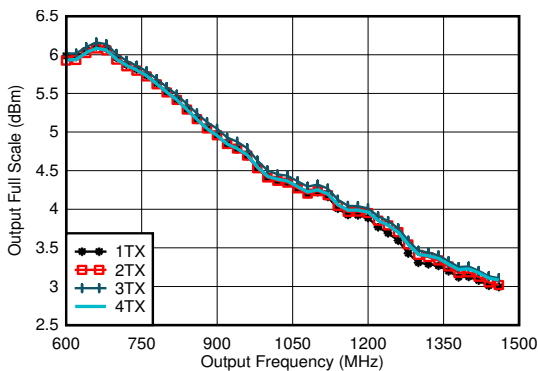

Including PCB and cable losses, $A_{out} = -0.5\text{dFBS}$, DSA = 0, 0.8 GHz matching

图 5-276. TX Full Scale vs RF Frequency and Channel at 11796.48MSPS, Interleave Mode

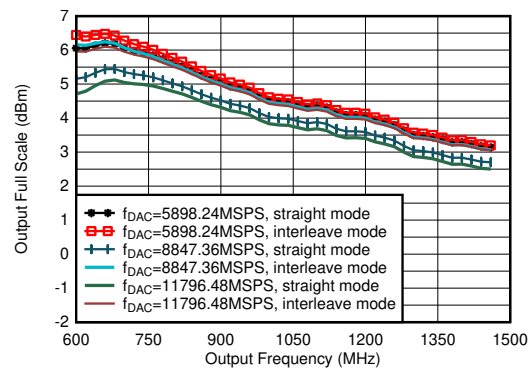

Including PCB and cable losses, $A_{out} = -0.5\text{dFBS}$, DSA = 0, 0.8 GHz matching

图 5-277. TX Output Fullscale vs Output Frequency

5.12.8 TX Typical Characteristics at 800MHz (continued)

Typical values at $T_A = +25^\circ\text{C}$ with nominal supplies. Unless otherwise noted, TX input data rate = 491.52MSPS, $f_{\text{DAC}} = 11796.48\text{MSPS}$, interleave mode, $A_{\text{OUT}} = -1 \text{ dBFS}$, 1st Nyquist zone output, Internal PLL, $f_{\text{REF}} = 491.52\text{MSPS}$, 24x Interpolation, DSA = 0 dB, Sin(x)/x enabled, DSA calibrated.

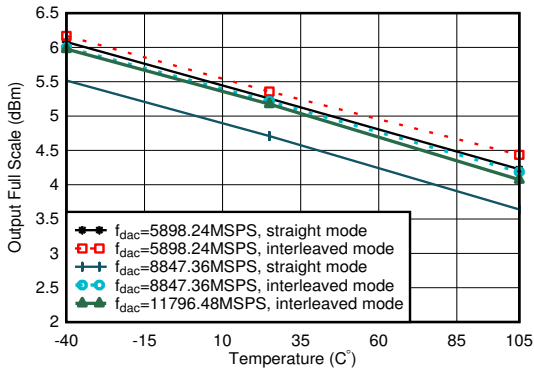

including PCB and cable losses, $A_{\text{out}} = -0.5\text{dBFS}$, DSA = 0, 0.8 GHz matching

图 5-278. TX Output Fullscale vs Temperature

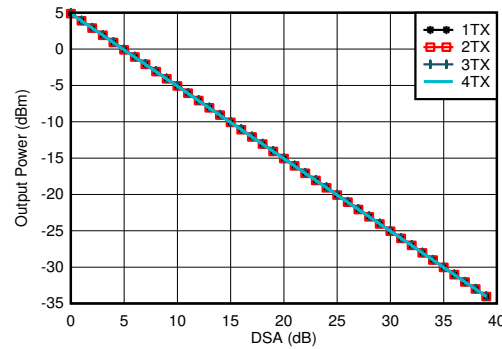

$f_{\text{DAC}} = 11796.48 \text{ MSPS}$, interleave mode, $A_{\text{out}} = -0.5\text{dBFS}$, matching 0.8 GHz

图 5-279. TX Output Power vs DSA Setting and Channel at 0.85 GHz

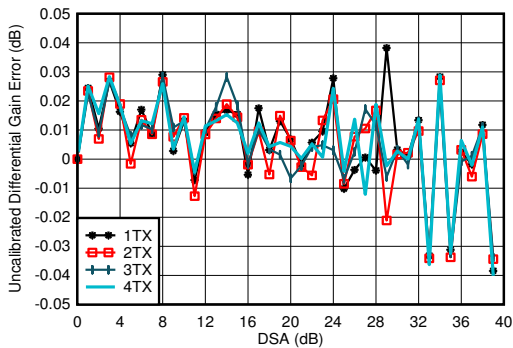

$f_{\text{DAC}}=5898.24\text{MSPS}$, interleave mode, matching at 0.8 GHz
Differential Gain Error = $P_{\text{OUT}}(\text{DSA Setting} - 1) - P_{\text{OUT}}(\text{DSA Setting}) + 1$

图 5-280. TX Uncalibrated Differential Gain Error vs DSA Setting and Channel at 0.85 GHz

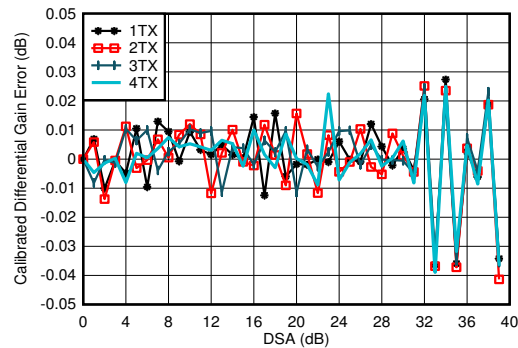

$f_{\text{DAC}}=5898.24\text{MSPS}$, interleave mode, matching at 0.8 GHz
Differential Gain Error = $P_{\text{OUT}}(\text{DSA Setting} - 1) - P_{\text{OUT}}(\text{DSA Setting}) + 1$

图 5-281. TX Calibrated Differential Gain Error vs DSA Setting and Channel at 0.85 GHz

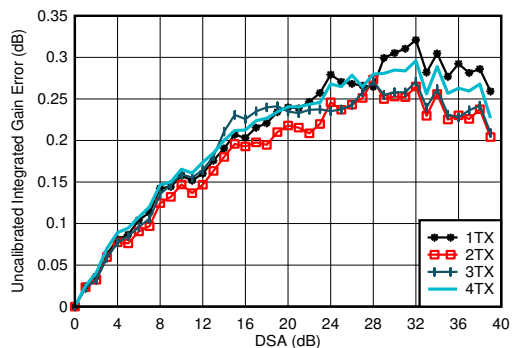

$f_{\text{DAC}}=5898.24\text{MSPS}$, interleave mode, matching at 0.8 GHz
Integrated Gain Error = $P_{\text{OUT}}(\text{DSA Setting}) - P_{\text{OUT}}(\text{DSA Setting} = 0) + \text{DSA Settings}$

图 5-282. TX Uncalibrated Integrated Gain Error vs DSA Setting and Channel at 0.85 GHz

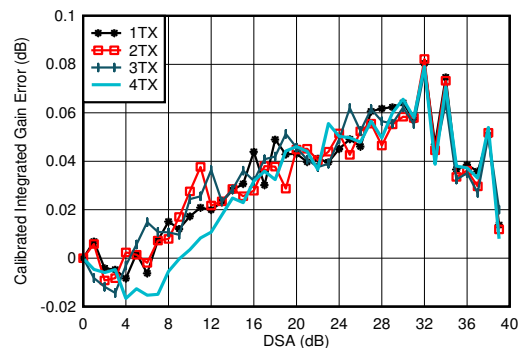

$f_{\text{DAC}}=5898.24\text{MSPS}$, interleave mode, matching at 0.8 GHz
Integrated Gain Error = $P_{\text{OUT}}(\text{DSA Setting}) - P_{\text{OUT}}(\text{DSA Setting} = 0) + \text{DSA Setting}$

图 5-283. TX Calibrated Integrated Gain Error vs DSA Setting and Channel at 0.85 GHz

5.12.8 TX Typical Characteristics at 800MHz (continued)

Typical values at $T_A = +25^\circ\text{C}$ with nominal supplies. Unless otherwise noted, TX input data rate = 491.52MSPS, $f_{\text{DAC}} = 11796.48\text{MSPS}$, interleave mode, $A_{\text{OUT}} = -1\text{ dBFS}$, 1st Nyquist zone output, Internal PLL, $f_{\text{REF}} = 491.52\text{MSPS}$, 24x Interpolation, DSA = 0 dB, Sin(x)/x enabled, DSA calibrated.

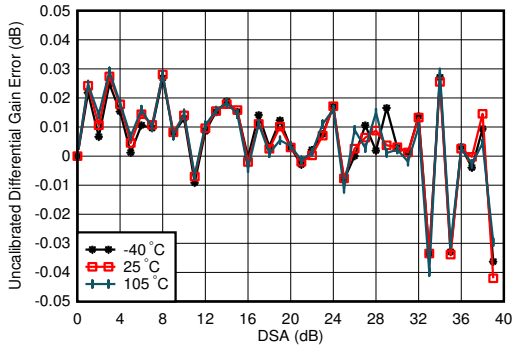

$f_{\text{DAC}} = 5898.24\text{MSPS}$, interleave mode, matching at 0.8 GHz
 Differential Gain Error = $P_{\text{OUT}}(\text{DSA Setting} - 1) - P_{\text{OUT}}(\text{DSA Setting}) + 1$

图 5-284. TX Uncalibrated Differential Gain Error vs DSA Setting and Temperature at 0.85 GHz

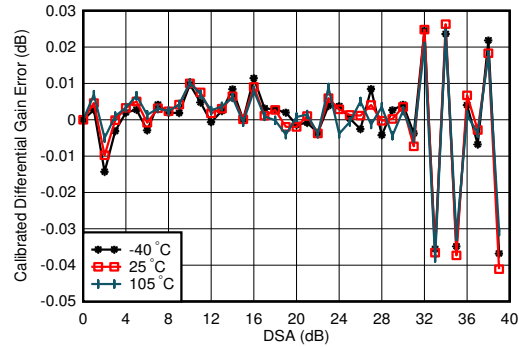

$f_{\text{DAC}} = 5898.24\text{MSPS}$, interleave mode, matching at 0.8 GHz
 Differential Gain Error = $P_{\text{OUT}}(\text{DSA Setting} - 1) - P_{\text{OUT}}(\text{DSA Setting}) + 1$

图 5-285. TX Calibrated Differential Gain Error vs DSA Setting and Temperature at 0.85 GHz

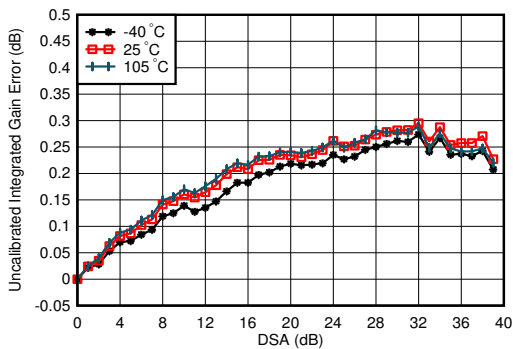

$f_{\text{DAC}} = 5898.24\text{MSPS}$, interleave mode, matching at 0.8 GHz
 Integrated Gain Error = $P_{\text{OUT}}(\text{DSA Setting}) - P_{\text{OUT}}(\text{DSA Setting} = 0) + \text{DSA Setting}$

图 5-286. TX Uncalibrated Integrated Gain Error vs DSA Setting and Temperature at 0.85 GHz

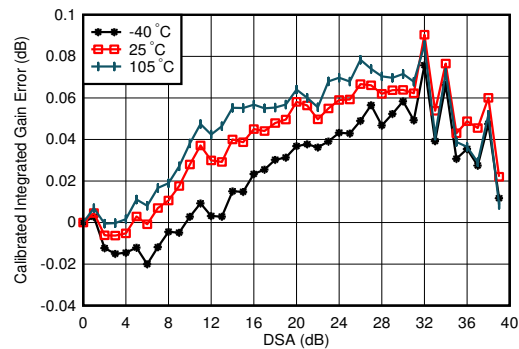

$f_{\text{DAC}} = 5898.24\text{MSPS}$, interleave mode, matching at 0.8 GHz
 Integrated Gain Error = $P_{\text{OUT}}(\text{DSA Setting}) - P_{\text{OUT}}(\text{DSA Setting} = 0) + \text{DSA Setting}$

图 5-287. TX Calibrated Integrated Gain Error vs DSA Setting and Temperature at 0.85 GHz

5.12.8 TX Typical Characteristics at 800MHz (continued)

Typical values at $T_A = +25^\circ\text{C}$ with nominal supplies. Unless otherwise noted, TX input data rate = 491.52MSPS, $f_{\text{DAC}} = 11796.48\text{MSPS}$, interleave mode, $A_{\text{OUT}} = -1\text{ dBFS}$, 1st Nyquist zone output, Internal PLL, $f_{\text{REF}} = 491.52\text{MSPS}$, 24x Interpolation, DSA = 0 dB, Sin(x)/x enabled, DSA calibrated.

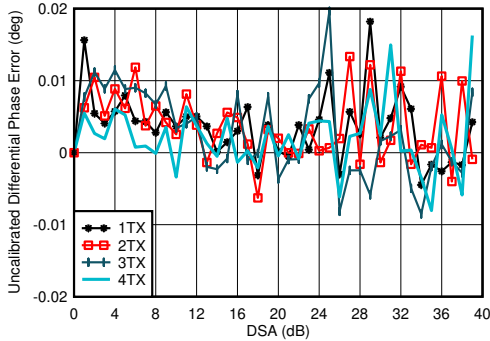

$f_{\text{DAC}} = 5898.24\text{MSPS}$, interleave mode, matching at 0.8 GHz
Differential Phase Error = $\text{Phase}_{\text{OUT}}(\text{DSA Setting} - 1) - \text{Phase}_{\text{OUT}}(\text{DSA Setting})$

图 5-288. TX Uncalibrated Differential Phase Error vs DSA Setting and Channel at 0.85 GHz

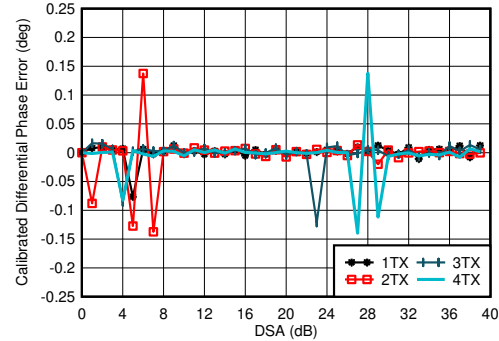

$f_{\text{DAC}} = 5898.24\text{MSPS}$, interleave mode, matching at 0.8 GHz
Differential Phase Error = $\text{Phase}_{\text{OUT}}(\text{DSA Setting} - 1) - \text{Phase}_{\text{OUT}}(\text{DSA Setting})$
Phase DNL spike may occur at any DSA setting.

图 5-289. TX Calibrated Differential Phase Error vs DSA Setting and Channel at 0.85 GHz

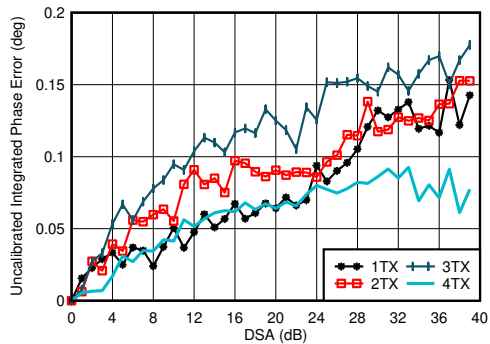

$f_{\text{DAC}} = 5898.24\text{MSPS}$, interleave mode, matching at 0.8 GHz
Integrated Phase Error = $\text{Phase}_{\text{OUT}}(\text{DSA Setting}) - \text{Phase}_{\text{OUT}}(\text{DSA Setting} = 0)$

图 5-290. TX Uncalibrated Integrated Phase Error vs DSA Setting and Channel at 0.85 GHz

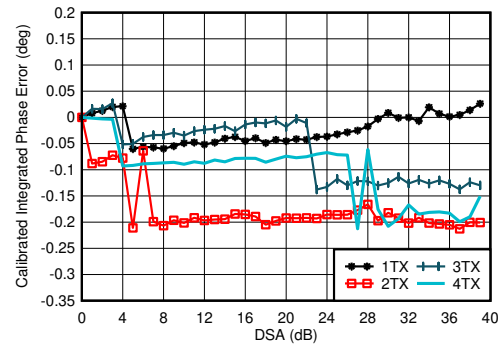

$f_{\text{DAC}} = 5898.24\text{MSPS}$, interleave mode, matching at 0.8 GHz
Integrated Phase Error = $\text{Phase}_{\text{OUT}}(\text{DSA Setting}) - \text{Phase}_{\text{OUT}}(\text{DSA Setting} = 0)$

图 5-291. TX Calibrated Integrated Phase Error vs DSA Setting and Channel at 0.85 GHz

5.12.8 TX Typical Characteristics at 800MHz (continued)

Typical values at $T_A = +25^\circ\text{C}$ with nominal supplies. Unless otherwise noted, TX input data rate = 491.52MSPS, $f_{\text{DAC}} = 11796.48\text{MSPS}$, interleave mode, $A_{\text{OUT}} = -1\text{ dBFS}$, 1st Nyquist zone output, Internal PLL, $f_{\text{REF}} = 491.52\text{MSPS}$, 24x Interpolation, DSA = 0 dB, Sin(x)/x enabled, DSA calibrated.

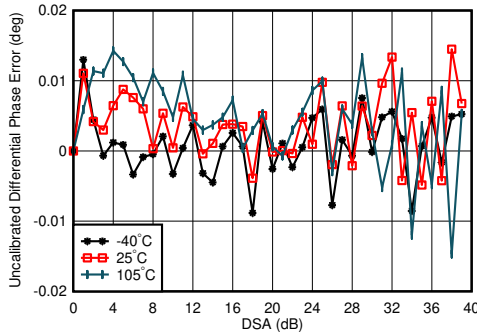

$f_{\text{DAC}} = 5898.24\text{MSPS}$, interleave mode, matching at 0.8 GHz
 Differential Phase Error = $\text{Phase}_{\text{OUT}}(\text{DSA Setting} - 1) - \text{Phase}_{\text{OUT}}(\text{DSA Setting}) + 1$

图 5-292. TX Uncalibrated Differential Phase Error vs DSA Setting and Temperature at 0.85 GHz

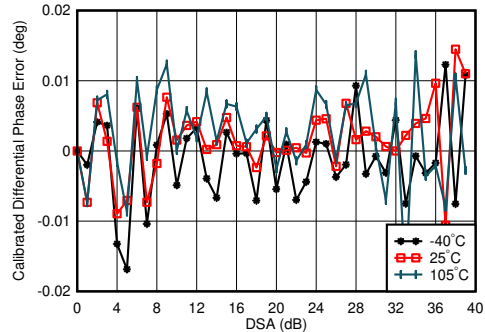

$f_{\text{DAC}} = 5898.24\text{MSPS}$, interleave mode, matching at 0.8 GHz, channel with the median variation over DSA setting at 25°C
 Differential Phase Error = $\text{Phase}_{\text{OUT}}(\text{DSA Setting} - 1) - \text{Phase}_{\text{OUT}}(\text{DSA Setting}) + 1$

图 5-293. TX Calibrated Differential Phase Error vs DSA Setting and Temperature at 0.85 GHz

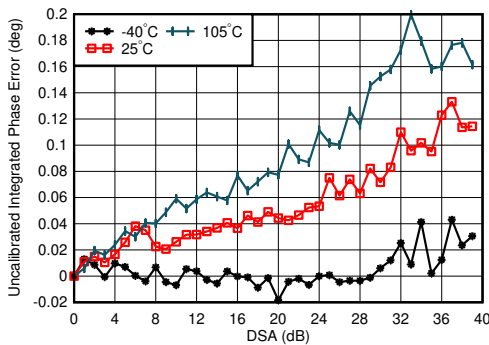

$f_{\text{DAC}} = 5898.24\text{MSPS}$, interleave mode, matching at 0.8 GHz
 Integrated Phase Error = $\text{Phase}_{\text{OUT}}(\text{DSA Setting}) - \text{Phase}_{\text{OUT}}(\text{DSA Setting} = 0)$

图 5-294. TX Uncalibrated Integrated Phase Error vs DSA Setting and Temperature at 0.85 GHz

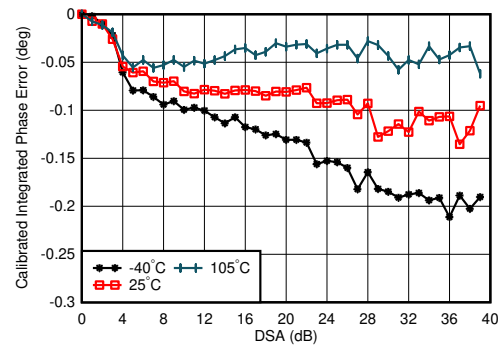

$f_{\text{DAC}} = 5898.24\text{MSPS}$, interleave mode, matching at 0.8 GHz
 Integrated Phase Error = $\text{Phase}_{\text{OUT}}(\text{DSA Setting}) - \text{Phase}_{\text{OUT}}(\text{DSA Setting} = 0)$

图 5-295. TX Calibrated Integrated Phase Error vs DSA Setting and Temperature at 0.85 GHz

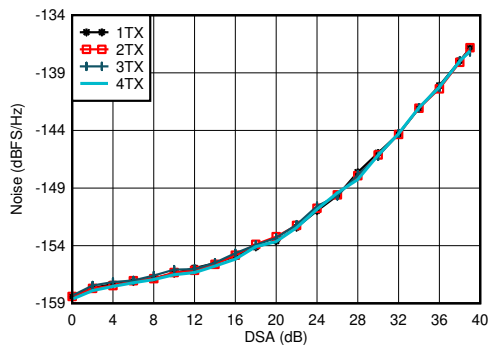

$f_{\text{DAC}} = 5898.24\text{MSPS}$, interleave mode, matching at 0.8 GHz,
 $P_{\text{OUT}} = -13\text{ dBFS}$

图 5-296. TX Output Noise vs Channel and Attenuation at 0.85 GHz

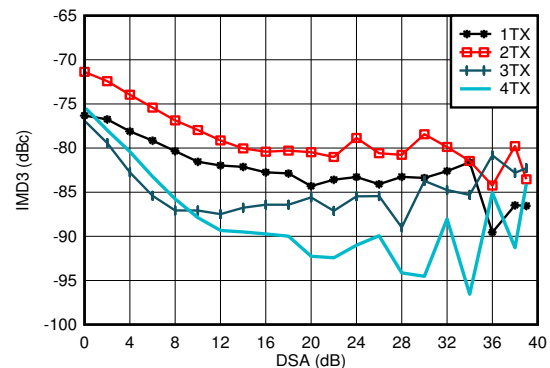

$f_{\text{DAC}} = 11796.48\text{MSPS}$, interleave mode, $f_{\text{CENTER}} = 0.85\text{ GHz}$, matching at 0.8 GHz, -13 dBFS each tone

图 5-297. TX IMD3 vs DSA Setting at 0.85 GHz

5.12.8 TX Typical Characteristics at 800MHz (continued)

Typical values at $T_A = +25^\circ\text{C}$ with nominal supplies. Unless otherwise noted, TX input data rate = 491.52MSPS, $f_{\text{DAC}} = 11796.48\text{MSPS}$, interleave mode, $A_{\text{OUT}} = -1\text{ dBFS}$, 1st Nyquist zone output, Internal PLL, $f_{\text{REF}} = 491.52\text{MSPS}$, 24x Interpolation, DSA = 0 dB, Sin(x)/x enabled, DSA calibrated.

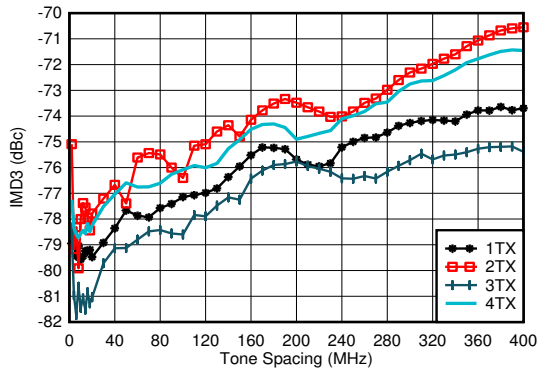

$f_{\text{DAC}} = 5898.24\text{MSPS}$, straight mode, $f_{\text{CENTER}} = 0.85\text{ GHz}$, matching at 0.8 GHz, -13 dBFS each tone

图 5-298. TX IMD3 vs Tone Spacing and Channel at 0.85 GHz

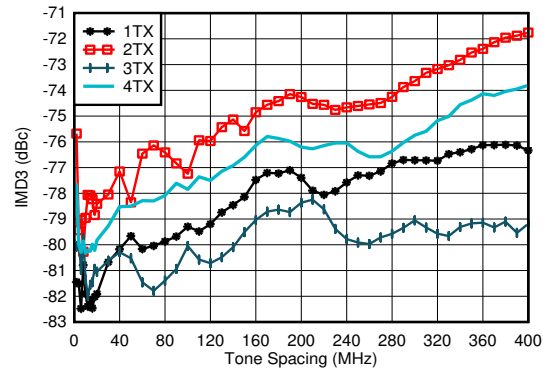

$f_{\text{DAC}} = 8847.36\text{MSPS}$, straight mode, $f_{\text{CENTER}} = 0.85\text{ GHz}$, matching at 0.8 GHz, -13 dBFS each tone

图 5-299. TX IMD3 vs Tone Spacing and Channel at 0.85 GHz

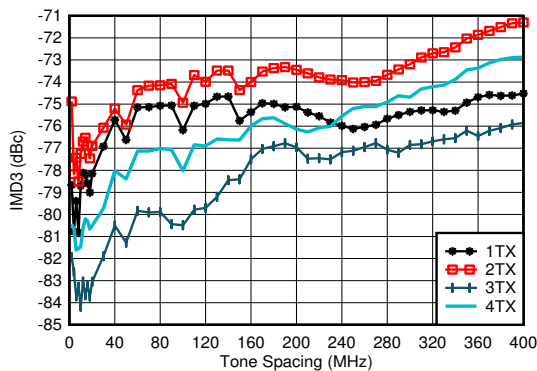

$f_{\text{DAC}} = 11796.48\text{MSPS}$, interleave mode, $f_{\text{CENTER}} = 0.85\text{ GHz}$, matching at 0.8 GHz, -13 dBFS each tone

图 5-300. TX IMD3 vs Tone Spacing and Channel at 0.85 GHz

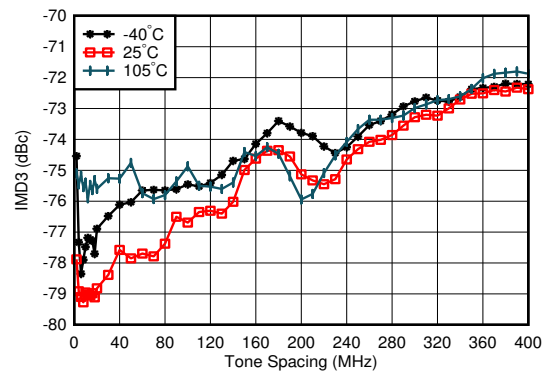

$f_{\text{DAC}} = 5898.24\text{MSPS}$, straight mode, $f_{\text{CENTER}} = 0.85\text{ GHz}$, matching at 0.8 GHz, -13 dBFS each tone, worst channel

图 5-301. TX IMD3 vs Tone Spacing and Temperature at 0.85 GHz

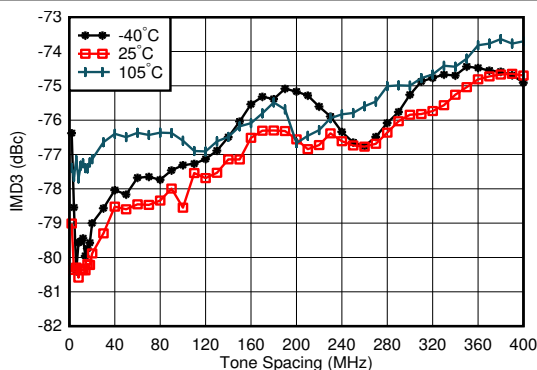

$f_{\text{DAC}} = 8847.36\text{MSPS}$, straight mode, $f_{\text{CENTER}} = 0.85\text{ GHz}$, matching at 0.8 GHz, -13 dBFS each tone, worst channel

图 5-302. TX IMD3 vs Tone Spacing and Temperature at 0.85 GHz

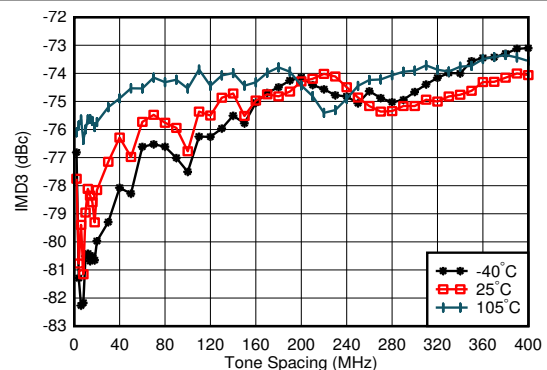

$f_{\text{DAC}} = 11796.48\text{MSPS}$, straight mode, $f_{\text{CENTER}} = 0.85\text{ GHz}$, matching at 0.8 GHz, -13 dBFS each tone, worst channel

图 5-303. TX IMD3 vs Tone Spacing and Temperature at 0.85 GHz

5.12.8 TX Typical Characteristics at 800MHz (continued)

Typical values at $T_A = +25^\circ\text{C}$ with nominal supplies. Unless otherwise noted, TX input data rate = 491.52MSPS, $f_{\text{DAC}} = 11796.48\text{MSPS}$, interleave mode, $A_{\text{OUT}} = -1\text{ dBFS}$, 1st Nyquist zone output, Internal PLL, $f_{\text{REF}} = 491.52\text{MSPS}$, 24x Interpolation, DSA = 0 dB, Sin(x)/x enabled, DSA calibrated.

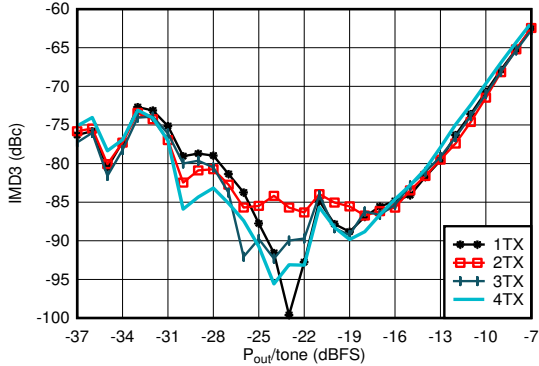

$f_{\text{DAC}} = 5898.24\text{MSPS}$, straight mode, $f_{\text{CENTER}} = 0.85\text{ GHz}$, $f_{\text{SPACING}} = 20\text{ MHz}$, matching at 0.8 GHz

图 5-304. TX IMD3 vs Digital Level at 0.85 GHz

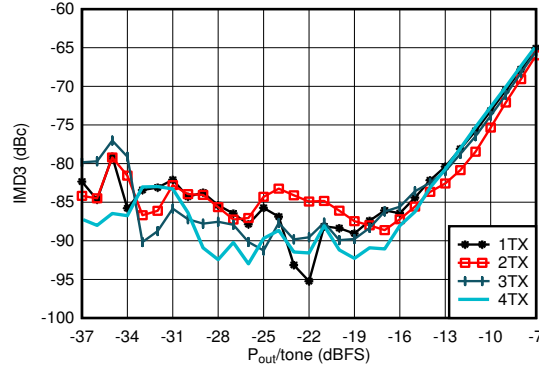

$f_{\text{DAC}} = 8847.36\text{MSPS}$, straight mode, $f_{\text{CENTER}} = 0.85\text{ GHz}$, $f_{\text{SPACING}} = 20\text{ MHz}$, matching at 0.8 GHz

图 5-305. TX IMD3 vs Digital Level at 0.85 GHz

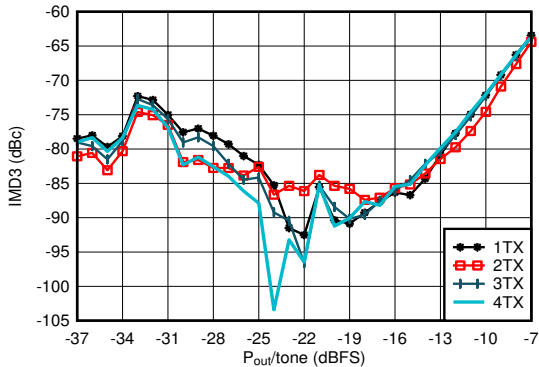

$f_{\text{DAC}} = 11796.48\text{MSPS}$, interleave mode, $f_{\text{CENTER}} = 0.85\text{ GHz}$, $f_{\text{SPACING}} = 20\text{ MHz}$, matching at 0.8 GHz

图 5-306. TX IMD3 vs Digital Level at 0.85 GHz

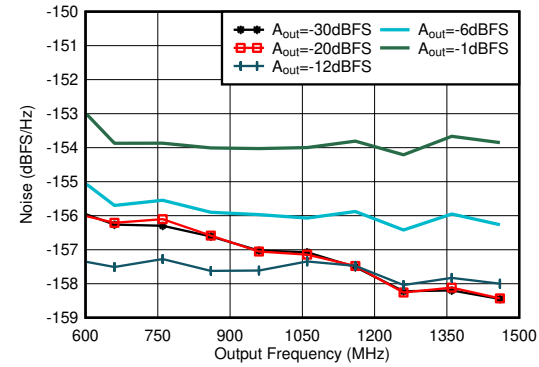

Matching at 0.8 GHz, Single tone, $f_{\text{DAC}} = 11.79648\text{GSPPS}$, interleave mode, 40-MHz offset, DSA = 0dB

图 5-307. TX Single Tone Output Noise vs Frequency and Amplitude at 0.85 GHz

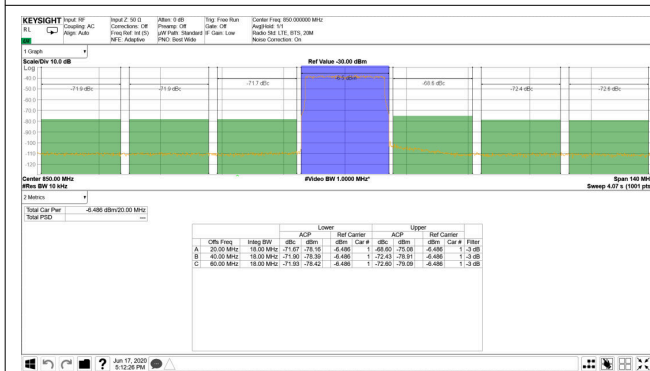

TM1.1, $P_{\text{OUT_RMS}} = -13\text{ dBFS}$

图 5-308. TX 20-MHz LTE Output Spectrum at 0.85 GHz

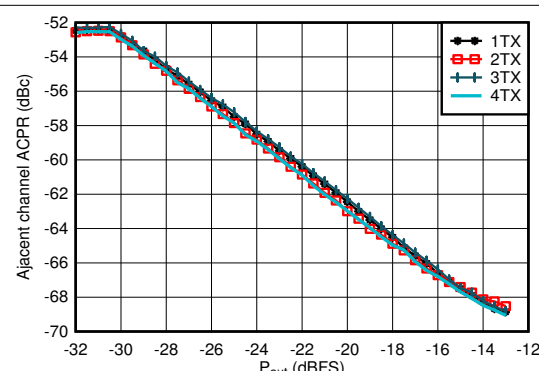

Matching at 0.8 GHz, single carrier 20-MHz BW TM1.1 LTE

图 5-309. TX 20-MHz LTE ACPR vs Digital Level at 0.85 GHz

5.12.8 TX Typical Characteristics at 800MHz (continued)

Typical values at $T_A = +25^\circ\text{C}$ with nominal supplies. Unless otherwise noted, TX input data rate = 491.52MSPS, $f_{\text{DAC}} = 11796.48\text{MSPS}$, interleave mode, $A_{\text{OUT}} = -1 \text{ dBFS}$, 1st Nyquist zone output, Internal PLL, $f_{\text{REF}} = 491.52\text{MSPS}$, 24x Interpolation, DSA = 0 dB, $\text{Sin}(x)/x$ enabled, DSA calibrated.

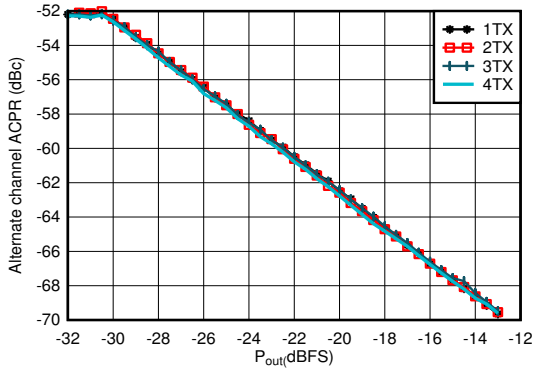

Matching at 0.8 GHz, single carrier 20-MHz BW TM1.1 LTE

图 5-310. TX 20-MHz LTE alt-ACPR vs Digital Level at 0.85 GHz

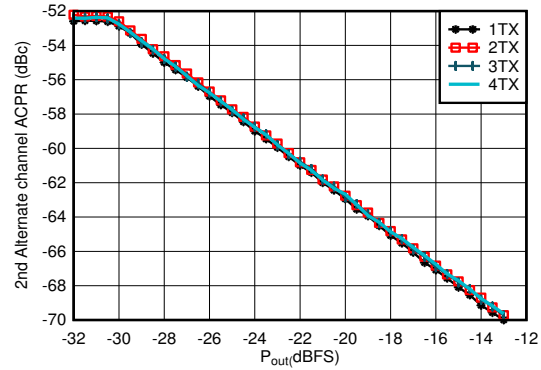

Matching at 0.8 GHz, single carrier 20-MHz BW TM1.1 LTE

图 5-311. TX 20-MHz LTE alt2-ACPR vs Digital Level at 0.85 GHz

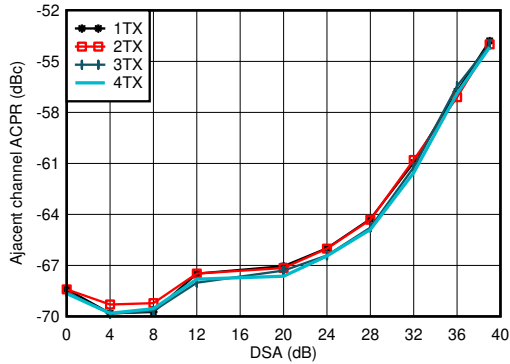

Matching at 0.8 GHz, single carrier 20-MHz BW TM1.1 LTE

图 5-312. TX 20-MHz LTE ACPR vs DSA at 0.85 GHz

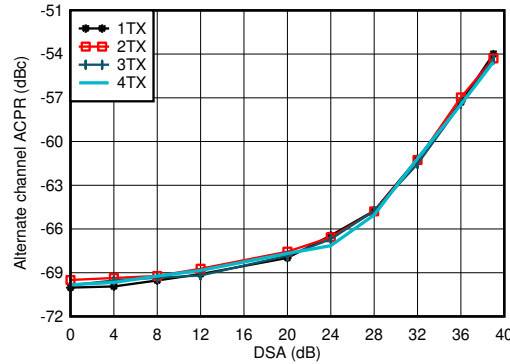

Matching at 0.8 GHz, single carrier 20-MHz BW TM1.1 LTE

图 5-313. TX 20-MHz LTE alt-ACPR vs DSA at 0.85 GHz

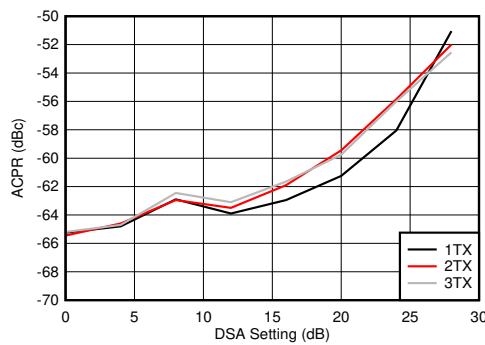

Matching at 0.8 GHz, single carrier 100-MHz BW TM1.1 NR

图 5-314. TX 100-MHz NR ACPR vs DSA at 0.85 GHz

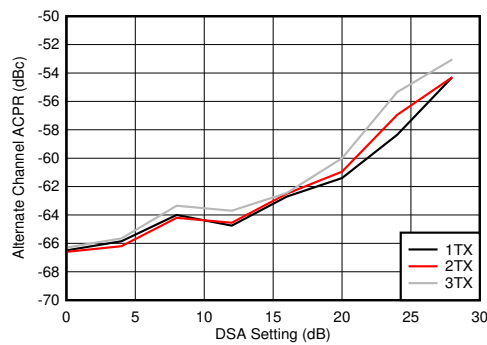

Matching at 0.8 GHz, single carrier 100-MHz BW TM1.1 NR

图 5-315. TX 100-MHz NR alt-ACPR vs DSA at 0.85 GHz

5.12.8 TX Typical Characteristics at 800MHz (continued)

Typical values at $T_A = +25^\circ\text{C}$ with nominal supplies. Unless otherwise noted, TX input data rate = 491.52MSPS, $f_{\text{DAC}} = 11796.48\text{MSPS}$, interleave mode, $A_{\text{OUT}} = -1\text{ dBFS}$, 1st Nyquist zone output, Internal PLL, $f_{\text{REF}} = 491.52\text{MSPS}$, 24x Interpolation, DSA = 0 dB, Sin(x)/x enabled, DSA calibrated.

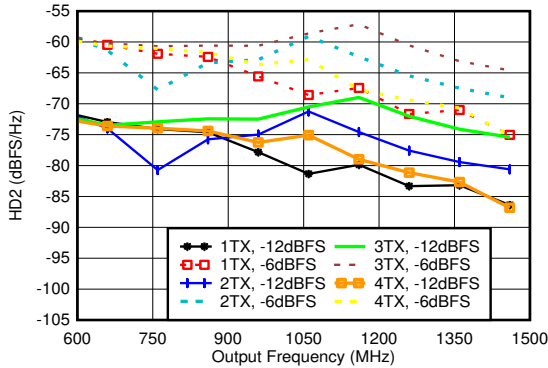

Matching at 0.8 GHz, $f_{\text{DAC}} = 5898.24\text{GSPS}$, straight mode

图 5-316. TX HD2 vs Digital Amplitude and Output Frequency at 0.85 GHz

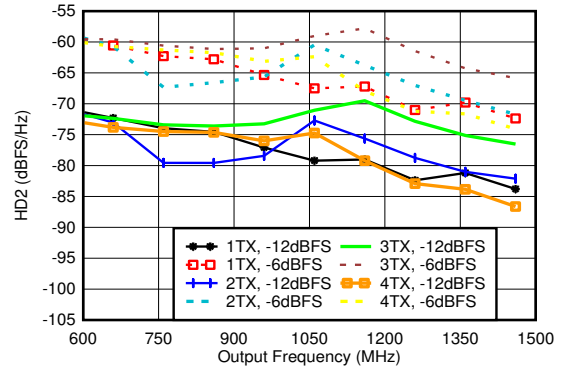

Matching at 0.8 GHz, $f_{\text{DAC}} = 8847.36\text{GSPS}$, straight mode

图 5-317. TX HD2 vs Digital Amplitude and Output Frequency at 0.85 GHz

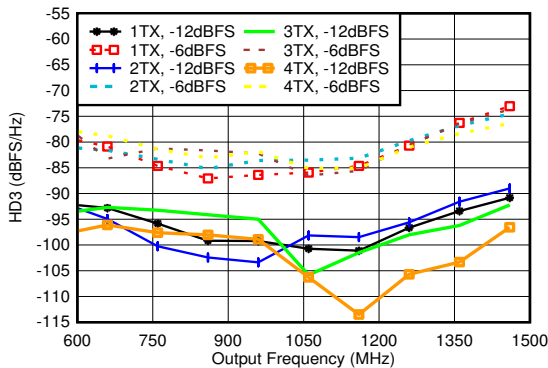

Matching at 0.8 GHz, $f_{\text{DAC}} = 5898.24\text{MSPS}$, straight mode, normalized to output power at harmonic frequency

图 5-318. TX HD3 vs Digital Amplitude and Output Frequency at 0.85 GHz

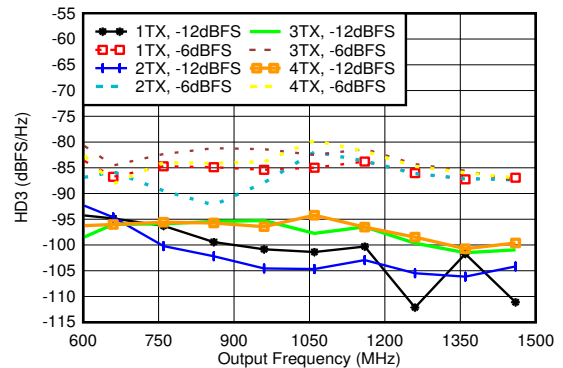

Matching at 0.8 GHz, $f_{\text{DAC}} = 8847.36\text{MSPS}$, straight mode, normalized to output power at harmonic frequency

图 5-319. TX HD3 vs Digital Amplitude and Output Frequency at 0.85 GHz

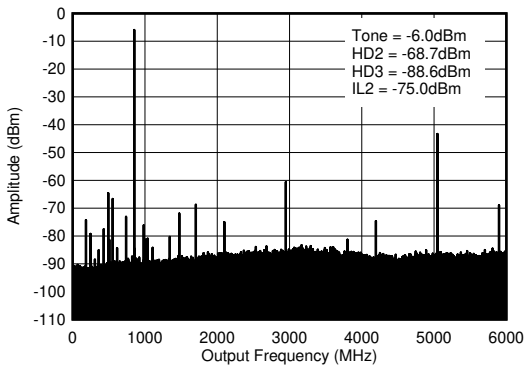

$f_{\text{DAC}} = 5898.24\text{MSPS}$, interleave mode, 0.8 GHz matching, includes PCB and cable losses. $IL_n = f_s/n \pm f_{\text{OUT}}$.

图 5-320. TX Single Tone (-12 dBFS) Output Spectrum at 0.85 GHz ($0-f_{\text{DAC}}$)

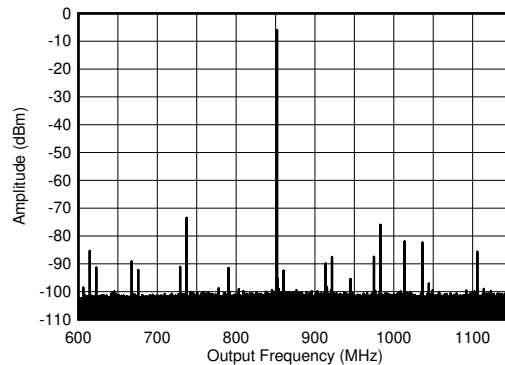

$f_{\text{DAC}} = 5898.24\text{MSPS}$, interleave mode, 0.8 GHz matching, includes PCB and cable losses

图 5-321. TX Single Tone (-12 dBFS) Output Spectrum at 0.85 GHz ($\pm 300\text{ MHz}$)

5.12.8 TX Typical Characteristics at 800MHz (continued)

Typical values at $T_A = +25^\circ\text{C}$ with nominal supplies. Unless otherwise noted, TX input data rate = 491.52MSPS, $f_{\text{DAC}} = 11796.48\text{MSPS}$, interleave mode, $A_{\text{OUT}} = -1 \text{ dBFS}$, 1st Nyquist zone output, Internal PLL, $f_{\text{REF}} = 491.52\text{MSPS}$, 24x Interpolation, DSA = 0 dB, Sin(x)/x enabled, DSA calibrated.

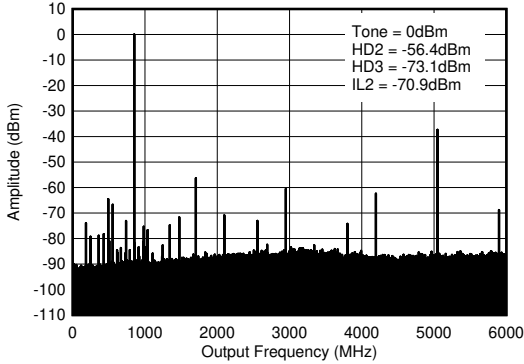

$f_{\text{DAC}} = 5898.24\text{MSPS}$, interleave mode, 0.8 GHz matching, includes PCB and cable losses. $\text{ILn} = f_s/n \pm f_{\text{OUT}}$.

图 5-322. TX Single Tone (-6 dBFS) Output Spectrum at 0.85 GHz (0- f_{DAC})

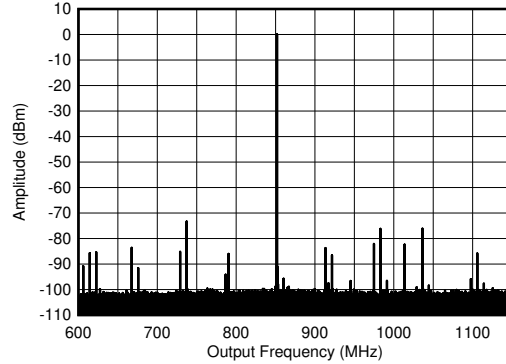

$f_{\text{DAC}} = 5898.24\text{MSPS}$, interleave mode, 0.8 GHz matching, includes PCB and cable losses

图 5-323. TX Single Tone (-6 dBFS) Output Spectrum at 0.85 GHz ($\pm 300 \text{ MHz}$)

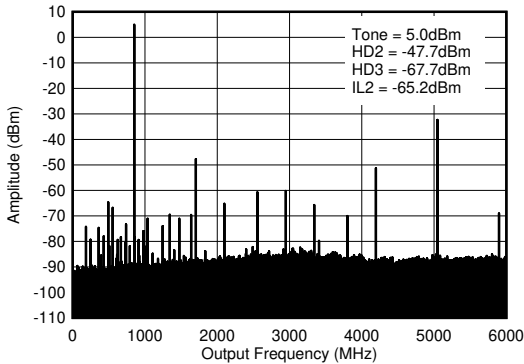

$f_{\text{DAC}} = 5898.24\text{MSPS}$, interleave mode, 0.8 GHz matching, includes PCB and cable losses. $\text{ILn} = f_s/n \pm f_{\text{OUT}}$.

图 5-324. TX Single Tone (-1 dBFS) Output Spectrum at 0.85 GHz (0- f_{DAC})

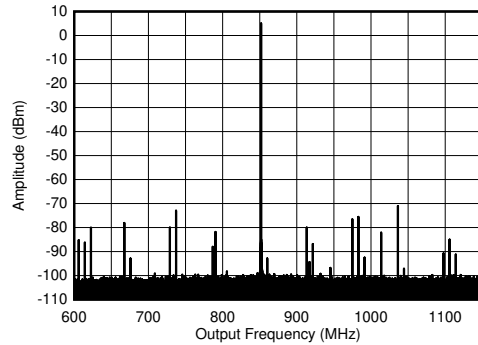

$f_{\text{DAC}} = 5898.24\text{MSPS}$, interleave mode, 0.8 GHz matching, includes PCB and cable losses

图 5-325. TX Single Tone (-1 dBFS) Output Spectrum at 0.85 GHz ($\pm 300 \text{ MHz}$)

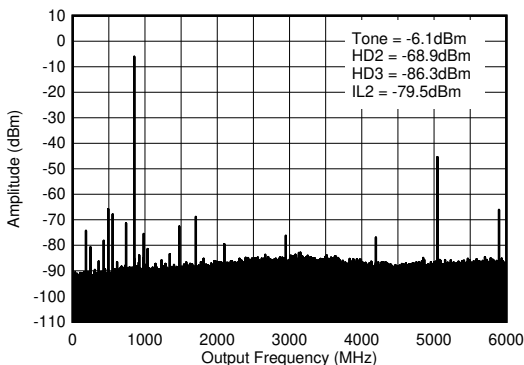

$f_{\text{DAC}} = 5898.24\text{MSPS}$, straight mode, 0.8 GHz matching, includes PCB and cable losses. $\text{ILn} = f_s/n \pm f_{\text{OUT}}$ and is due to mixing with digital clocks.

图 5-326. TX Single Tone (-12 dBFS) Output Spectrum at 0.85 GHz (0- f_{DAC})

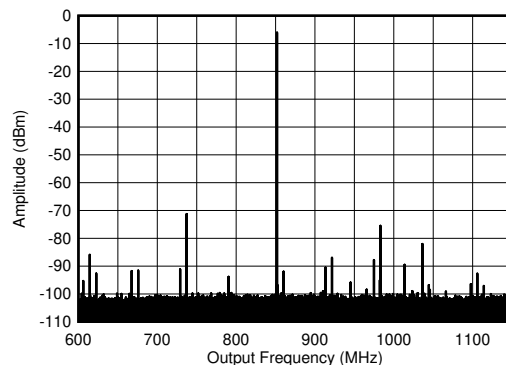

$f_{\text{DAC}} = 5898.24\text{MSPS}$, straight mode, 0.8 GHz matching, includes PCB and cable losses

图 5-327. TX Single Tone (-12 dBFS) Output Spectrum at 0.85 GHz ($\pm 300 \text{ MHz}$)

5.12.8 TX Typical Characteristics at 800MHz (continued)

Typical values at $T_A = +25^\circ\text{C}$ with nominal supplies. Unless otherwise noted, TX input data rate = 491.52MSPS, $f_{\text{DAC}} = 11796.48\text{MSPS}$, interleave mode, $A_{\text{OUT}} = -1\text{ dBFS}$, 1st Nyquist zone output, Internal PLL, $f_{\text{REF}} = 491.52\text{MSPS}$, 24x Interpolation, DSA = 0 dB, Sin(x)/x enabled, DSA calibrated.

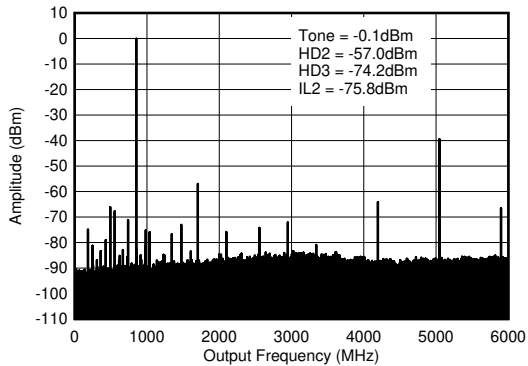

$f_{\text{DAC}} = 5898.24\text{MSPS}$, straight mode, 0.8 GHz matching, includes PCB and cable losses. $\text{IL}_n = f_s/n \pm f_{\text{OUT}}$ and is due to mixing with digital clocks.

图 5-328. TX Single Tone (-6 dBFS) Output Spectrum at 0.85 GHz ($0-f_{\text{DAC}}$)

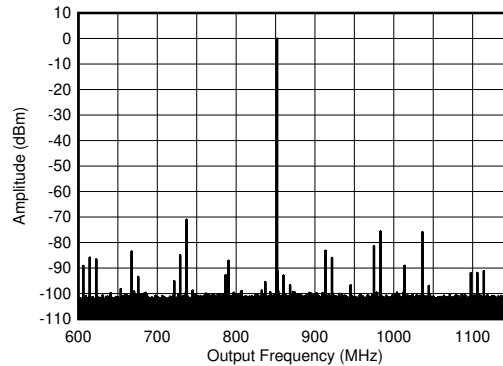

$f_{\text{DAC}} = 5898.24\text{MSPS}$, straight mode, 0.8 GHz matching, includes PCB and cable losses

图 5-329. TX Single Tone (-6 dBFS) Output Spectrum at 0.85 GHz ($\pm 300\text{ MHz}$)

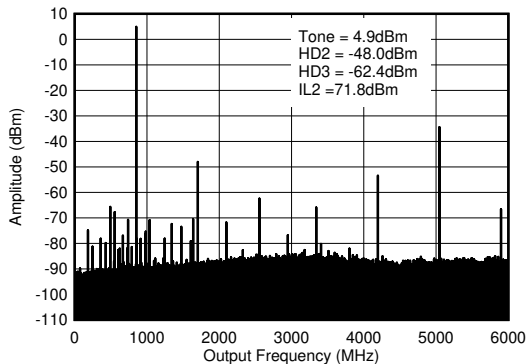

$f_{\text{DAC}} = 5898.24\text{MSPS}$, straight mode, 0.8 GHz matching, includes PCB and cable losses. $\text{IL}_n = f_s/n \pm f_{\text{OUT}}$ and is due to mixing with digital clocks.

图 5-330. TX Single Tone (-1 dBFS) Output Spectrum at 0.85 GHz ($0-f_{\text{DAC}}$)

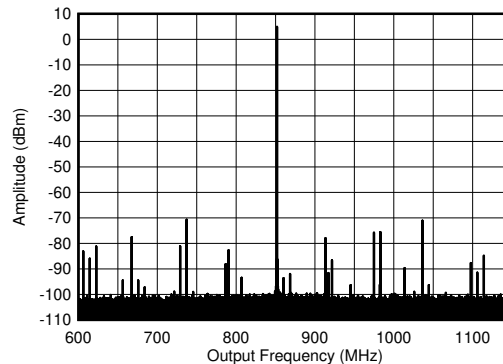

$f_{\text{DAC}} = 5898.24\text{MSPS}$, straight mode, 0.8 GHz matching, includes PCB and cable losses

图 5-331. TX Single Tone (-1 dBFS) Output Spectrum at 0.85 GHz ($\pm 300\text{ MHz}$)

5.12.9 TX Typical Characteristics at 1.8GHz

Typical values at $T_A = +25^\circ\text{C}$ with nominal supplies. Unless otherwise noted, TX input data rate = 491.52MSPS, $f_{\text{DAC}} = 11796.48\text{MSPS}$, interleave mode, $A_{\text{OUT}} = -1\text{ dBFS}$, 1st Nyquist zone output, Internal PLL, $f_{\text{REF}} = 491.52\text{MSPS}$, 24x Interpolation, DSA = 0 dB, Sin(x)/x enabled, DSA calibrated.

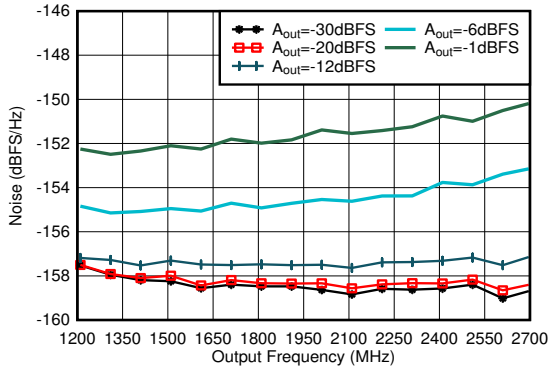

Matching at 1.8 GHz, Single tone, $f_{\text{DAC}} = 11.79648\text{GSPS}$, interleave mode, 40-MHz offset

图 5-332. TX Single Tone Output Noise vs Frequency and Amplitude at 1.8 GHz

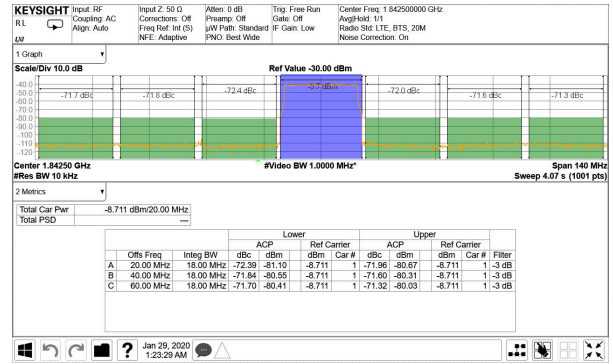

TM1.1, $P_{\text{OUT_RMS}} = -13\text{ dBFS}$

图 5-333. TX 20-MHz LTE Output Spectrum at 1.8425 GHz

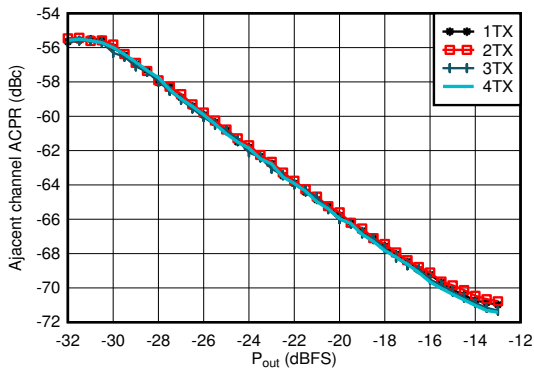

Matching at 1.8 GHz, single carrier 20-MHz BW TM1.1 LTE

图 5-334. TX 20-MHz LTE ACPR vs Digital Level at 1.8425 GHz

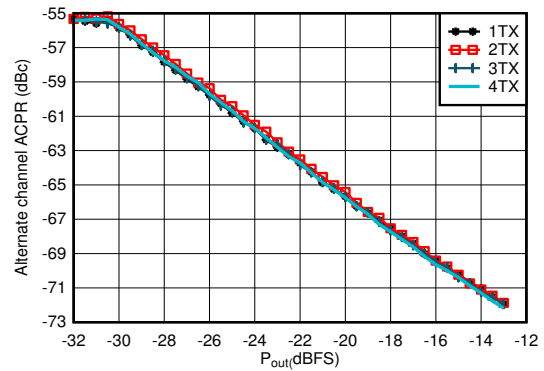

Matching at 1.8 GHz, single carrier 20-MHz BW TM1.1 LTE

图 5-335. TX 20-MHz LTE alt-ACPR vs Digital Level at 1.8425 GHz

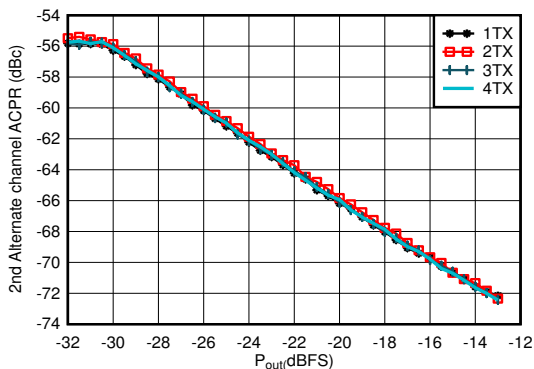

Matching at 1.8 GHz, single carrier 20-MHz BW TM1.1 LTE

图 5-336. TX 20-MHz LTE alt2-ACPR vs Digital Level at 1.8425 GHz

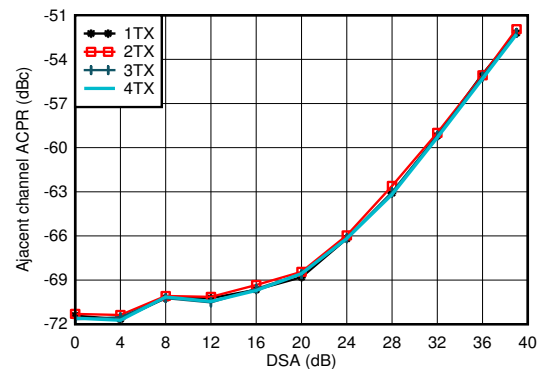

Matching at 1.8 GHz, single carrier 20-MHz BW TM1.1 LTE

图 5-337. TX 20-MHz LTE ACPR vs DSA at 1.8 GHz

5.12.9 TX Typical Characteristics at 1.8GHz (continued)

Typical values at $T_A = +25^\circ\text{C}$ with nominal supplies. Unless otherwise noted, TX input data rate = 491.52MSPS, $f_{\text{DAC}} = 11796.48\text{MSPS}$, interleave mode, $A_{\text{OUT}} = -1\text{ dBFS}$, 1st Nyquist zone output, Internal PLL, $f_{\text{REF}} = 491.52\text{MSPS}$, 24x Interpolation, DSA = 0 dB, Sin(x)/x enabled, DSA calibrated.

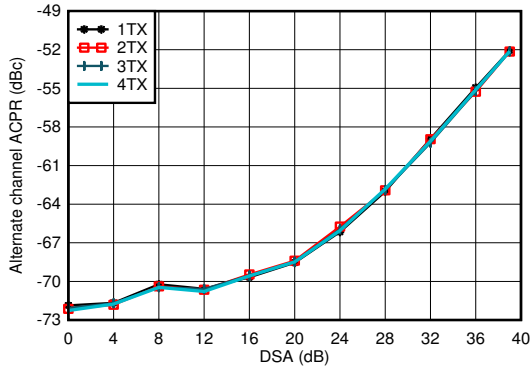

Matching at 1.8 GHz, single carrier 20-MHz BW TM1.1 LTE

图 5-338. TX 20-MHz LTE alt-ACPR vs DSA at 1.8 GHz

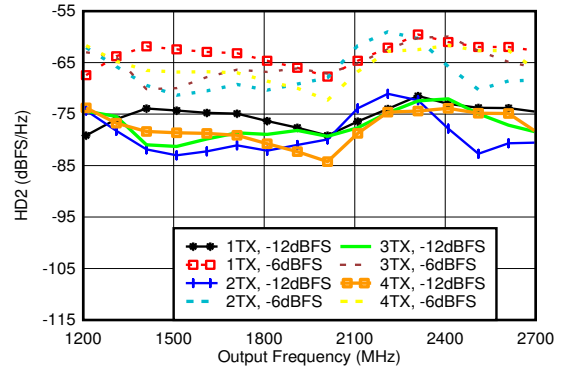

Matching at 1.8 GHz, $f_{\text{DAC}} = 11.79648\text{GSPS}$, interleave mode, normalized to output power at harmonic frequency

图 5-339. TX HD2 vs Digital Amplitude and Output Frequency at 1.8 GHz

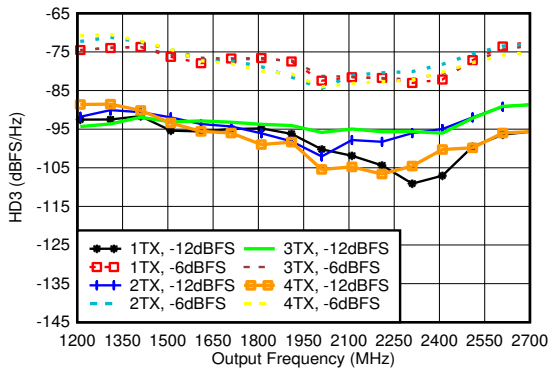

Matching at 1.8 GHz, $f_{\text{DAC}} = 11.79648\text{GSPS}$, interleave mode, normalized to output power at harmonic frequency

图 5-340. TX HD3 vs Digital Amplitude and Output Frequency at 1.8 GHz

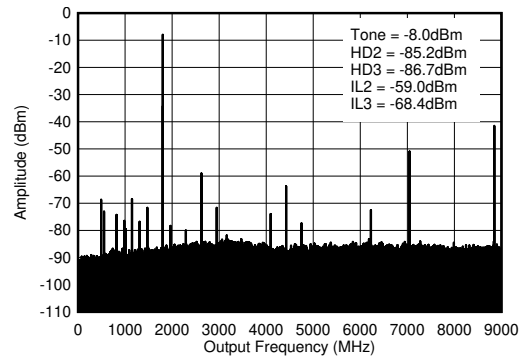

$f_{\text{DAC}} = 8847.36\text{MSPS}$, interleave mode, 1.8 GHz matching, includes PCB and cable losses. $IL_n = f_s/n \pm f_{\text{OUT}}$.

图 5-341. TX Single Tone (-12 dBFS) Output Spectrum at 1.8 GHz ($0-f_{\text{DAC}}$)

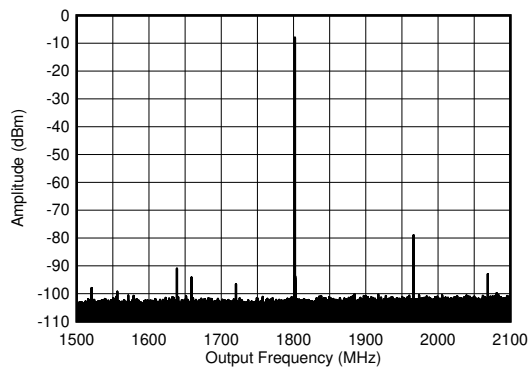

$f_{\text{DAC}} = 8847.36\text{MSPS}$, interleave mode, 1.8 GHz matching, includes PCB and cable losses

图 5-342. TX Single Tone (-12 dBFS) Output Spectrum at 1.8 GHz ($\pm 300\text{ MHz}$)

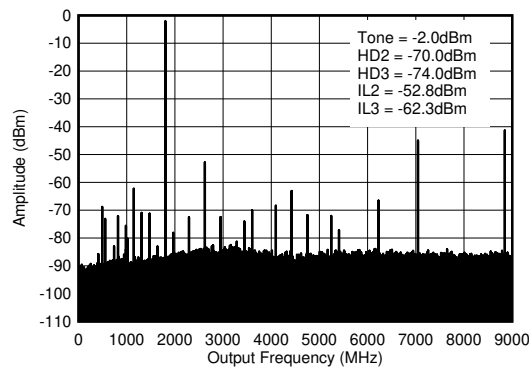

$f_{\text{DAC}} = 8847.36\text{MSPS}$, interleave mode, 1.8 GHz matching, includes PCB and cable losses. $IL_n = f_s/n \pm f_{\text{OUT}}$.

图 5-343. TX Single Tone (-6 dBFS) Output Spectrum at 1.8 GHz ($0-f_{\text{DAC}}$)

5.12.9 TX Typical Characteristics at 1.8GHz (continued)

Typical values at $T_A = +25^\circ\text{C}$ with nominal supplies. Unless otherwise noted, TX input data rate = 491.52MSPS, $f_{\text{DAC}} = 11796.48\text{MSPS}$, interleave mode, $A_{\text{OUT}} = -1 \text{ dBFS}$, 1st Nyquist zone output, Internal PLL, $f_{\text{REF}} = 491.52\text{MSPS}$, 24x Interpolation, DSA = 0 dB, Sin(x)/x enabled, DSA calibrated.

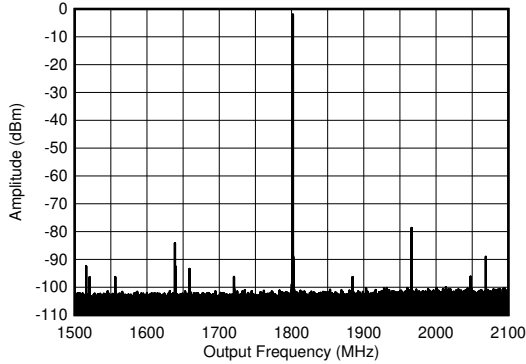

$f_{\text{DAC}} = 8847.36\text{MSPS}$, interleave mode, 1.8 GHz matching, includes PCB and cable losses

图 5-344. TX Single Tone (-6 dBFS) Output Spectrum at 1.8 GHz (± 300 MHz)

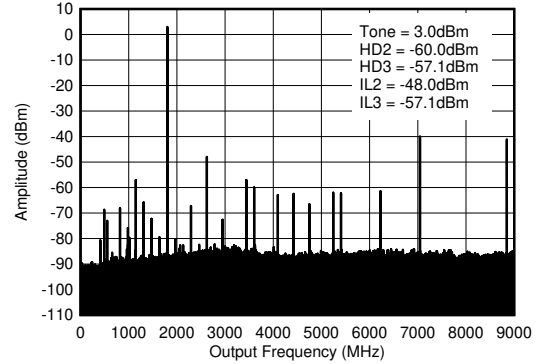

$f_{\text{DAC}} = 8847.36\text{MSPS}$, interleave mode, 1.8 GHz matching, includes PCB and cable losses. $IL_n = f_s/n \pm f_{\text{OUT}}$.

图 5-345. TX Single Tone (-1 dBFS) Output Spectrum at 1.8 GHz ($0-f_{\text{DAC}}$)

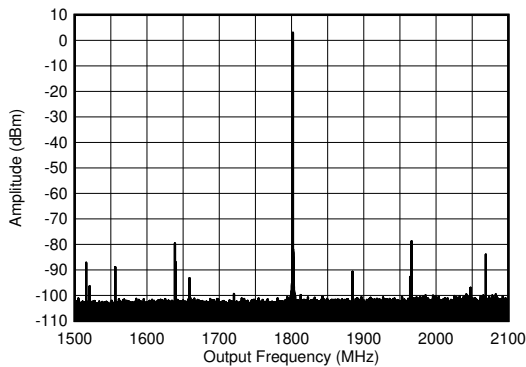

$f_{\text{DAC}} = 8847.36\text{MSPS}$, interleave mode, 1.8 GHz matching, includes PCB and cable losses

图 5-346. TX Single Tone (-1 dBFS) Output Spectrum at 1.8 GHz (± 300 MHz)

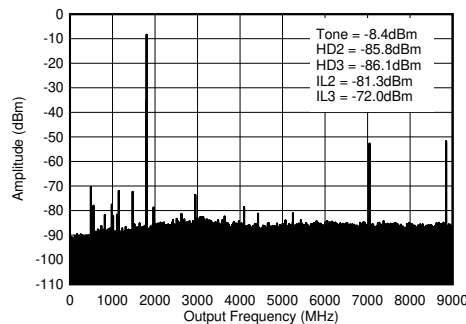

$f_{\text{DAC}} = 8847.36\text{MSPS}$, straight mode, 1.8 GHz matching, includes PCB and cable losses. $IL_n = f_s/n \pm f_{\text{OUT}}$ and is due to mixing with digital clocks.

图 5-347. TX Single Tone (-12 dBFS) Output Spectrum at 1.8 GHz ($0-f_{\text{DAC}}$)

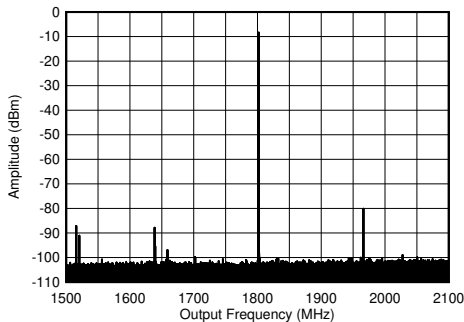

$f_{\text{DAC}} = 8847.36\text{MSPS}$, straight mode, 1.8 GHz matching, includes PCB and cable losses

图 5-348. TX Single Tone (-12 dBFS) Output Spectrum at 1.8 GHz (± 300 MHz)

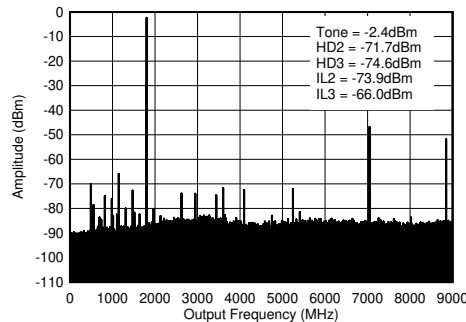

$f_{\text{DAC}} = 8847.36\text{MSPS}$, straight mode, 1.8 GHz matching, includes PCB and cable losses. $IL_n = f_s/n \pm f_{\text{OUT}}$ and is due to mixing with digital clocks.

图 5-349. TX Single Tone (-6 dBFS) Output Spectrum at 1.8 GHz ($0-f_{\text{DAC}}$)

5.12.9 TX Typical Characteristics at 1.8GHz (continued)

Typical values at $T_A = +25^\circ\text{C}$ with nominal supplies. Unless otherwise noted, TX input data rate = 491.52MSPS, $f_{\text{DAC}} = 11796.48\text{MSPS}$, interleave mode, $A_{\text{OUT}} = -1\text{ dBFS}$, 1st Nyquist zone output, Internal PLL, $f_{\text{REF}} = 491.52\text{MSPS}$, 24x Interpolation, DSA = 0 dB, $\text{Sin}(x)/x$ enabled, DSA calibrated.

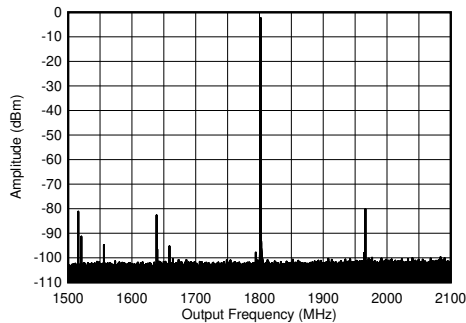

$f_{\text{DAC}} = 8847.36\text{MSPS}$, straight mode, 1.8 GHz matching, includes PCB and cable losses

图 5-350. TX Single Tone (- 6 dBFS) Output Spectrum at 1.8 GHz (± 300 MHz)

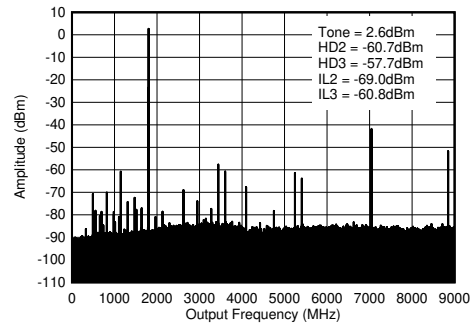

$f_{\text{DAC}} = 8847.36\text{MSPS}$, straight mode, 1.8 GHz matching, includes PCB and cable losses. $\text{ILn} = f_{\text{S}}/n \pm f_{\text{OUT}}$ and is due to mixing with digital clocks.

图 5-351. TX Single Tone (- 1 dBFS) Output Spectrum at 1.8 GHz ($0-f_{\text{DAC}}$)

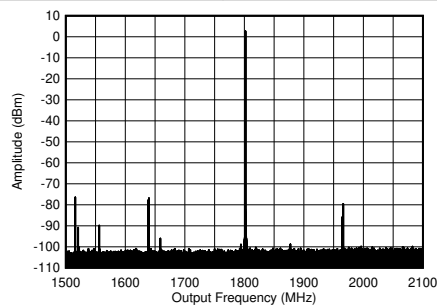

$f_{\text{DAC}} = 8847.36\text{MSPS}$, straight mode, 1.8 GHz matching, includes PCB and cable losses

图 5-352. TX Single Tone (- 1 dBFS) Output Spectrum at 1.8 GHz (± 300 MHz)

5.12.10 TX Typical Characteristics at 2.6GHz

Typical values at $T_A = +25^\circ\text{C}$ with nominal supplies. Unless otherwise noted, TX input data rate = 491.52MSPS, $f_{\text{DAC}} = 11796.48\text{MSPS}$, interleave mode, $A_{\text{OUT}} = -1 \text{ dBFS}$, 1st Nyquist zone output, Internal PLL, $f_{\text{REF}} = 491.52\text{MSPS}$, 24x Interpolation, DSA = 0 dB, Sin(x)/x enabled, DSA calibrated.

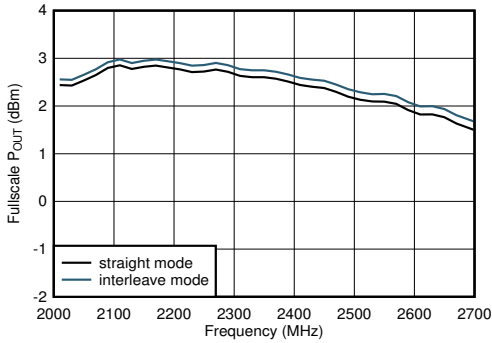

Including PCB and cable losses, $A_{\text{out}} = -0.5\text{dBFS}$, DSA = 0, 2.6 GHz matching

图 5-353. TX Full Scale vs RF Frequency at 5898.24MSPS

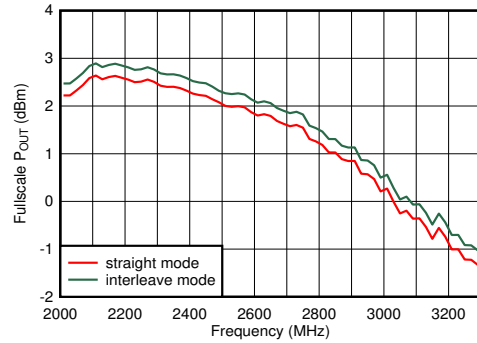

Including PCB and cable losses, $A_{\text{out}} = -0.5\text{dBFS}$, DSA = 0, 2.6 GHz matching

图 5-354. TX Full Scale vs RF Frequency at 8847.36MSPS

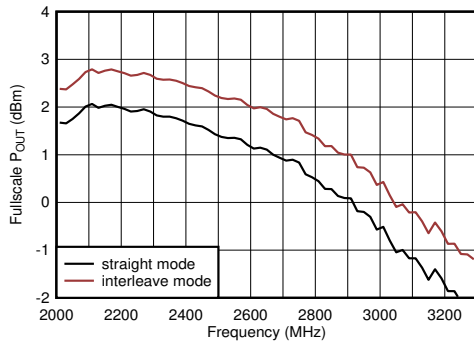

Including PCB and cable losses, $A_{\text{out}} = -0.5\text{dBFS}$, DSA = 0, 2.6 GHz matching

图 5-355. TX Full Scale vs RF Frequency at 11796.48MSPS

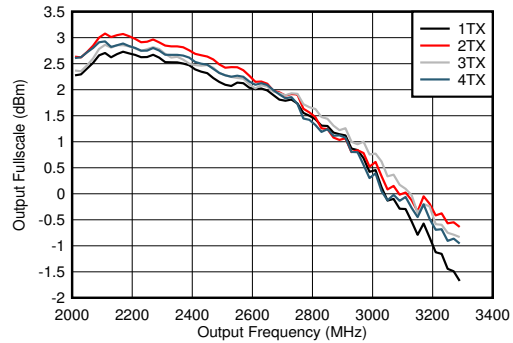

$f_{\text{DAC}} = 8847.36\text{MSPS}$, interleave mode, including PCB and cable losses, $A_{\text{out}} = -0.5\text{dBFS}$, DSA = 0, 2.6 GHz matching

图 5-356. TX Output Fullscale vs Output Frequency and Channel

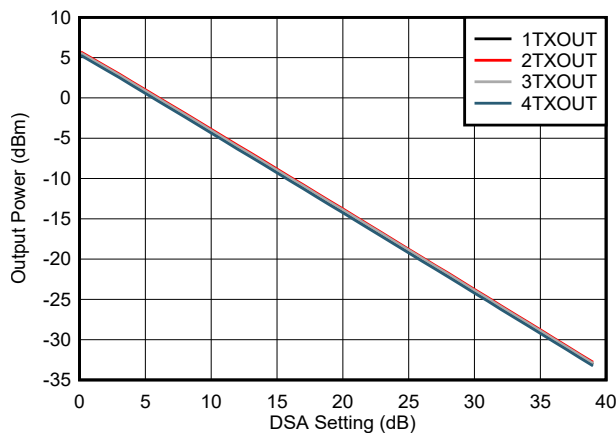

$f_{\text{DAC}} = 8847.36 \text{ MSPS}$, $A_{\text{out}} = -0.5\text{dBFS}$, matching 2.6 GHz

图 5-357. TX Output Power vs DSA Setting and Channel at 2.6 GHz

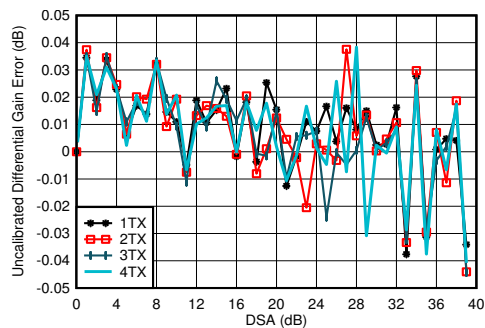

$f_{\text{DAC}} = 8847.36\text{MSPS}$, straight mode, matching at 2.6 GHz
Differential Gain Error = $P_{\text{OUT}}(\text{DSA Setting} - 1) - P_{\text{OUT}}(\text{DSA Setting}) + 1$

图 5-358. TX Uncalibrated Differential Gain Error vs DSA Setting and Channel at 2.6 GHz

5.12.10 TX Typical Characteristics at 2.6GHz (continued)

Typical values at $T_A = +25^\circ\text{C}$ with nominal supplies. Unless otherwise noted, TX input data rate = 491.52MSPS, $f_{\text{DAC}} = 11796.48\text{MSPS}$, interleave mode, $A_{\text{OUT}} = -1\text{ dBFS}$, 1st Nyquist zone output, Internal PLL, $f_{\text{REF}} = 491.52\text{MSPS}$, 24x Interpolation, DSA = 0 dB, Sin(x)/x enabled, DSA calibrated.

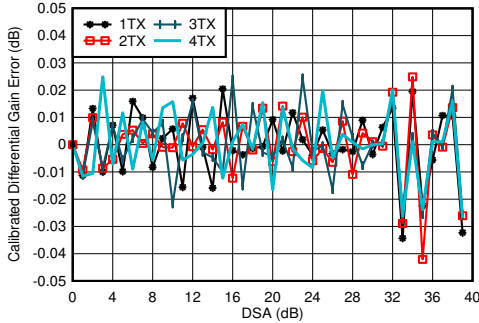

$f_{\text{DAC}} = 8847.36\text{MSPS}$, straight mode, matching at 2.6 GHz
 Differential Gain Error = $P_{\text{OUT}}(\text{DSA Setting} - 1) - P_{\text{OUT}}(\text{DSA Setting}) + 1$

图 5-359. TX Calibrated Differential Gain Error vs DSA Setting and Channel at 2.6 GHz

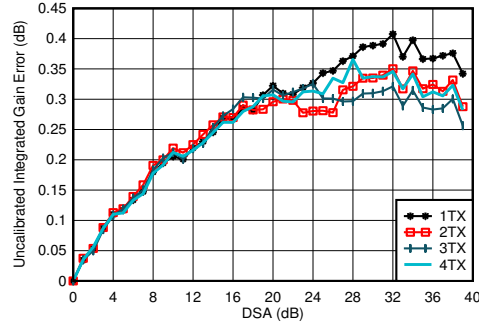

$f_{\text{DAC}} = 8847.36\text{MSPS}$, straight mode, matching at 2.6 GHz
 Integrated Gain Error = $P_{\text{OUT}}(\text{DSA Setting}) - P_{\text{OUT}}(\text{DSA Setting} = 0) + (\text{DSA Setting})$

图 5-360. TX Uncalibrated Integrated Gain Error vs DSA Setting and Channel at 2.6 GHz

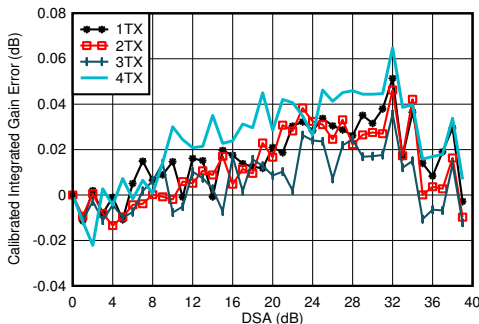

$f_{\text{DAC}} = 8847.36\text{MSPS}$, straight mode, matching at 2.6 GHz
 Integrated Gain Error = $P_{\text{OUT}}(\text{DSA Setting}) - P_{\text{OUT}}(\text{DSA Setting} = 0) + (\text{DSA Setting})$

图 5-361. TX Calibrated Integrated Gain Error vs DSA Setting and Channel at 2.6 GHz

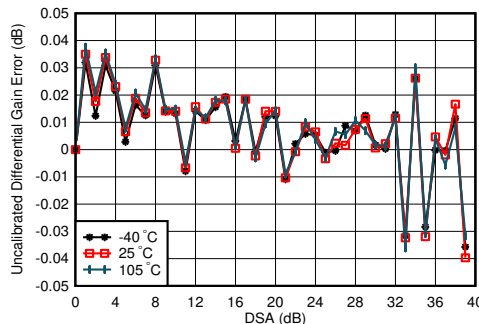

$f_{\text{DAC}} = 8847.36\text{MSPS}$, straight mode, matching at 2.6 GHz, channel with the median variation over DSA setting at 25°C
 Differential Gain Error = $P_{\text{OUT}}(\text{DSA Setting} - 1) - P_{\text{OUT}}(\text{DSA Setting}) + 1$

图 5-362. TX Uncalibrated Differential Gain Error vs DSA Setting and Temperature at 2.6 GHz

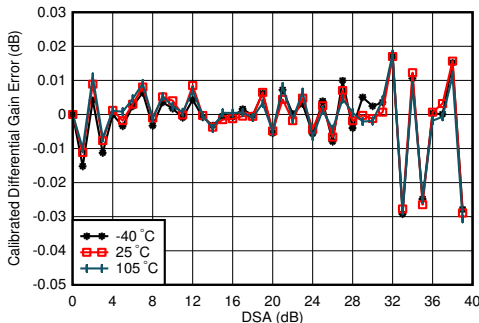

$f_{\text{DAC}} = 8847.36\text{MSPS}$, straight mode, matching at 2.6 GHz, channel with the median variation over DSA setting at 25°C
 Differential Gain Error = $P_{\text{OUT}}(\text{DSA Setting} - 1) - P_{\text{OUT}}(\text{DSA Setting}) + 1$

图 5-363. TX Calibrated Differential Gain Error vs DSA Setting and Temperature at 2.6 GHz

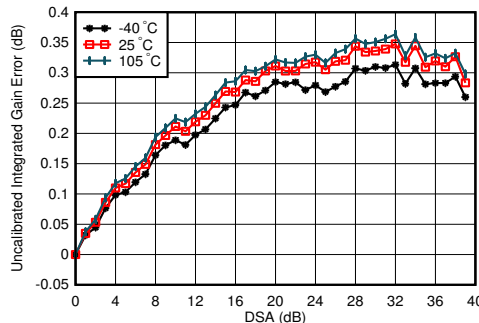

$f_{\text{DAC}} = 8847.36\text{MSPS}$, straight mode, matching at 2.6 GHz, channel with the median variation over DSA setting at 25°C
 Integrated Gain Error = $P_{\text{OUT}}(\text{DSA Setting}) - P_{\text{OUT}}(\text{DSA Setting} = 0) + (\text{DSA Setting})$

图 5-364. TX Uncalibrated Integrated Gain Error vs DSA Setting and Temperature at 2.6 GHz

5.12.10 TX Typical Characteristics at 2.6GHz (continued)

Typical values at $T_A = +25^\circ\text{C}$ with nominal supplies. Unless otherwise noted, TX input data rate = 491.52MSPS, $f_{\text{DAC}} = 11796.48\text{MSPS}$, interleave mode, $A_{\text{OUT}} = -1\text{ dBFS}$, 1st Nyquist zone output, Internal PLL, $f_{\text{REF}} = 491.52\text{MSPS}$, 24x Interpolation, DSA = 0 dB, Sin(x)/x enabled, DSA calibrated.

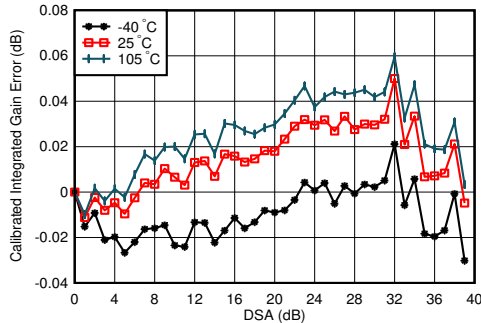

$f_{\text{DAC}} = 8847.36\text{MSPS}$, straight mode, matching at 2.6 GHz, channel with the median variation over DSA setting at 25°C
Integrated Gain Error = $P_{\text{OUT}}(\text{DSA Setting}) - P_{\text{OUT}}(\text{DSA Setting} = 0) + (\text{DSA Setting})$

图 5-365. TX Calibrated Integrated Gain Error vs DSA Setting and Temperature at 2.6 GHz

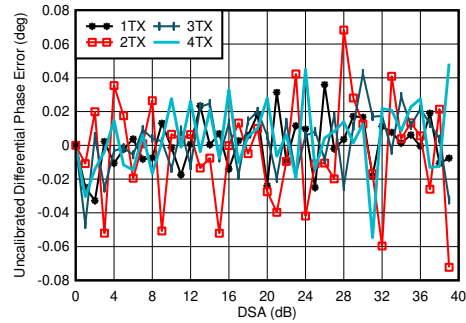

$f_{\text{DAC}} = 8847.36\text{MSPS}$, straight mode, matching at 2.6 GHz
Differential Phase Error = $\text{Phase}_{\text{OUT}}(\text{DSA Setting} - 1) - \text{Phase}_{\text{OUT}}(\text{DSA Setting})$

图 5-366. TX Uncalibrated Differential Phase Error vs DSA Setting and Channel at 2.6 GHz

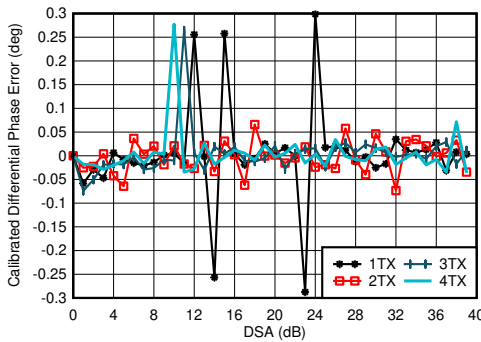

$f_{\text{DAC}} = 8847.36\text{MSPS}$, straight mode, matching at 2.6 GHz
Differential Phase Error = $\text{Phase}_{\text{OUT}}(\text{DSA Setting} - 1) - \text{Phase}_{\text{OUT}}(\text{DSA Setting})$
Phase DNL spike may occur at any DSA setting.

图 5-367. TX Calibrated Differential Phase Error vs DSA Setting and Channel at 2.6 GHz

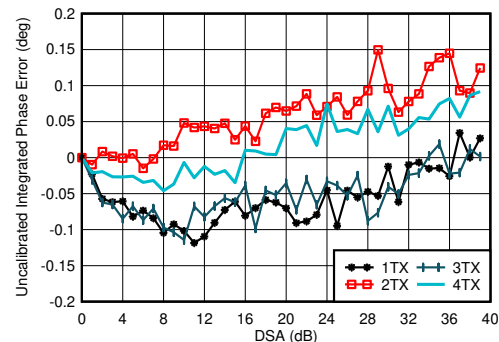

$f_{\text{DAC}} = 8847.36\text{MSPS}$, straight mode, matching at 2.6 GHz
Integrated Phase Error = $\text{Phase}(\text{DSA Setting}) - \text{Phase}(\text{DSA Setting} = 0)$

图 5-368. TX Uncalibrated Integrated Phase Error vs DSA Setting and Channel at 2.6 GHz

5.12.10 TX Typical Characteristics at 2.6GHz (continued)

Typical values at $T_A = +25^\circ\text{C}$ with nominal supplies. Unless otherwise noted, TX input data rate = 491.52MSPS, $f_{\text{DAC}} = 11796.48\text{MSPS}$, interleave mode, $A_{\text{OUT}} = -1\text{ dBFS}$, 1st Nyquist zone output, Internal PLL, $f_{\text{REF}} = 491.52\text{MSPS}$, 24x Interpolation, DSA = 0 dB, Sin(x)/x enabled, DSA calibrated.

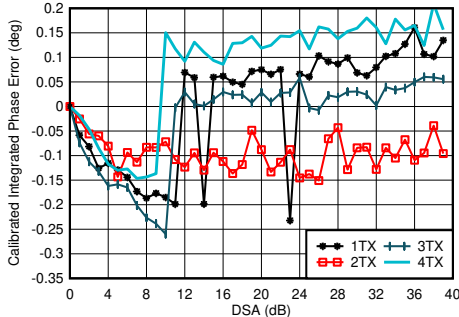

$f_{\text{DAC}} = 8847.36\text{MSPS}$, straight mode, matching at 2.6 GHz
Integrated Phase Error = Phase(DSA Setting) - Phase(DSA Setting = 0)

图 5-369. TX Calibrated Integrated Phase Error vs DSA Setting and Channel at 2.6 GHz

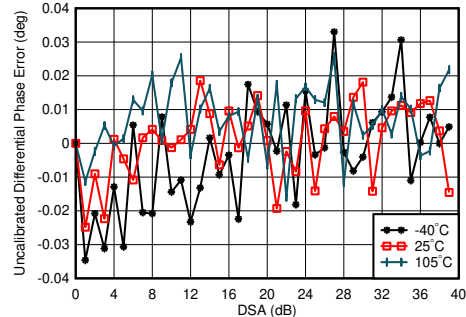

$f_{\text{DAC}} = 8847.36\text{MSPS}$, straight mode, matching at 2.6 GHz, channel with the median variation over DSA setting at 25°C
Differential Phase Error = Phase_{OUT}(DSA Setting - 1) - Phase_{OUT}(DSA Setting)

图 5-370. TX Uncalibrated Differential Phase Error vs DSA Setting and Temperature at 2.6 GHz

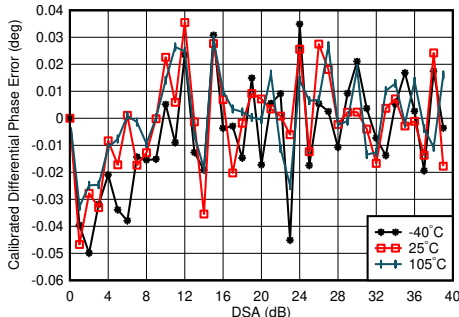

$f_{\text{DAC}} = 8847.36\text{MSPS}$, straight mode, matching at 2.6 GHz, channel with the median variation over DSA setting at 25°C
Differential Phase Error = Phase_{OUT}(DSA Setting - 1) - Phase_{OUT}(DSA Setting)

图 5-371. TX Calibrated Differential Phase Error vs DSA Setting and Temperature at 2.6 GHz

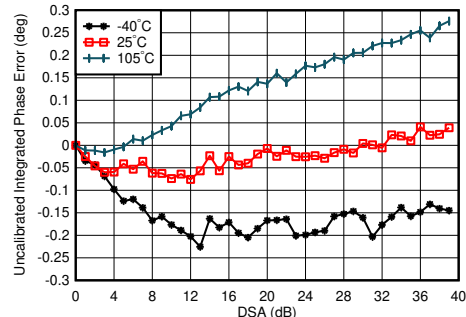

$f_{\text{DAC}} = 8847.36\text{MSPS}$, straight mode, matching at 2.6 GHz, channel with the medium variation over DSA setting at 25°C
Integrated Phase Error = Phase(DSA Setting) - Phase(DSA Setting = 0)

图 5-372. TX Uncalibrated Integrated Phase Error vs DSA Setting and Temperature at 2.6 GHz

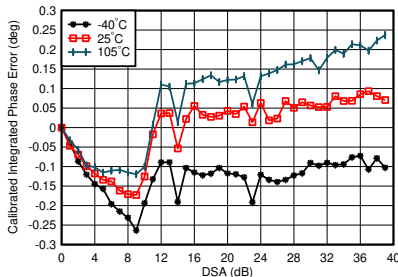

$f_{\text{DAC}} = 8847.36\text{MSPS}$, straight mode, matching at 2.6 GHz, channel with the median variation over DSA setting at 25°C
Integrated Phase Error = Phase(DSA Setting) - Phase(DSA Setting = 0)

图 5-373. TX Calibrated Integrated Phase Error vs DSA Setting and Temperature at 2.6 GHz

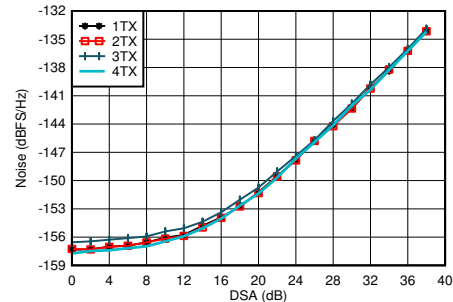

$f_{\text{DAC}} = 8847.36\text{MSPS}$, straight mode, matching at 2.6 GHz, $P_{\text{OUT}} = -13\text{ dBFS}$

图 5-374. TX Output Noise vs Channel and Attenuation at 2.6 GHz

5.12.10 TX Typical Characteristics at 2.6GHz (continued)

Typical values at $T_A = +25^\circ\text{C}$ with nominal supplies. Unless otherwise noted, TX input data rate = 491.52MSPS, $f_{\text{DAC}} = 11796.48\text{MSPS}$, interleave mode, $A_{\text{OUT}} = -1\text{ dBFS}$, 1st Nyquist zone output, Internal PLL, $f_{\text{REF}} = 491.52\text{MSPS}$, 24x Interpolation, DSA = 0 dB, Sin(x)/x enabled, DSA calibrated.

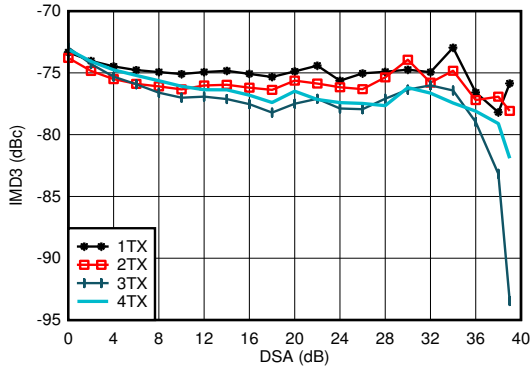

$f_{\text{DAC}} = 8847.36\text{MSPS}$, straight mode, $f_{\text{CENTER}} = 2.6\text{ GHz}$, matching at 2.6 GHz, -13 dBFS each tone

图 5-375. TX IMD3 vs DSA Setting at 2.6 GHz

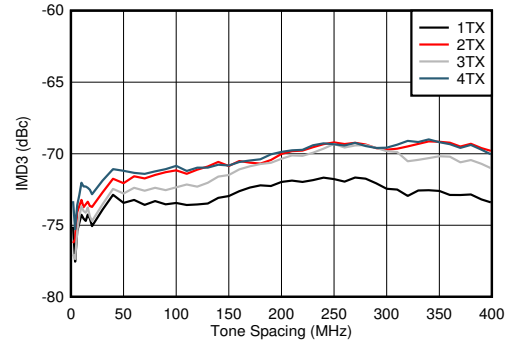

$f_{\text{DAC}} = 8847.36\text{MSPS}$, straight mode, $f_{\text{CENTER}} = 2.6\text{ GHz}$, matching at 2.6 GHz, -13 dBFS each tone

图 5-376. TX IMD3 vs Tone Spacing and Channel at 2.6 GHz

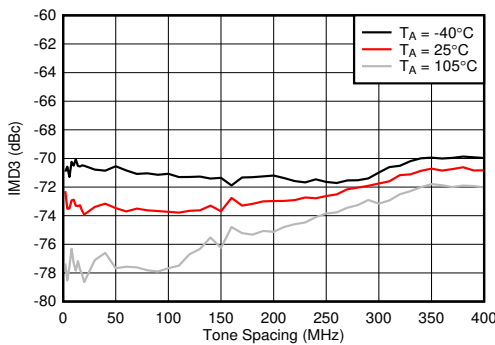

$f_{\text{DAC}} = 8847.36\text{MSPS}$, straight mode, $f_{\text{CENTER}} = 2.6\text{ GHz}$, matching at 2.6 GHz, -13 dBFS each tone, worst channel.

图 5-377. TX IMD3 vs Tone Spacing and Temperature at 2.6 GHz

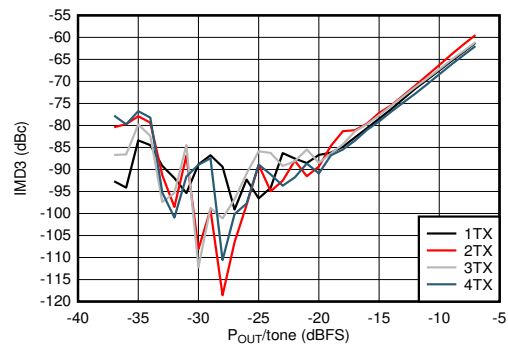

$f_{\text{DAC}} = 8847.36\text{MSPS}$, straight mode, $f_{\text{CENTER}} = 2.6\text{ GHz}$, $f_{\text{SPACING}} = 20\text{ MHz}$, matching at 2.6 GHz

图 5-378. TX IMD3 vs Digital Level at 2.6 GHz

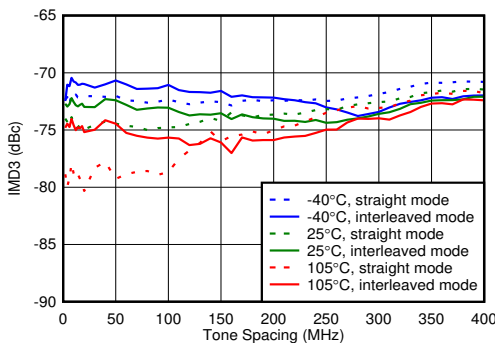

$f_{\text{DAC}} = 8847.36\text{MSPS}$, straight mode, $f_{\text{CENTER}} = 2.6\text{ GHz}$, matching at 2.6 GHz, -13 dBFS each tone

图 5-379. TX IMD3 vs Tone Spacing and Temperature

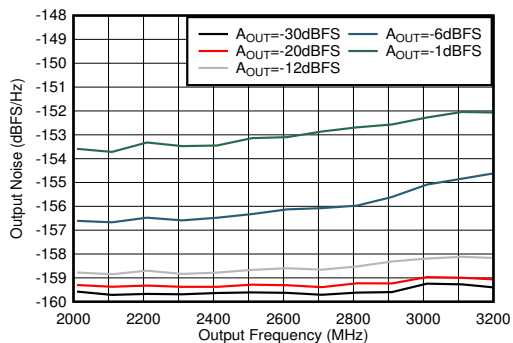

Matching at 2.6 GHz, Single tone, $f_{\text{DAC}} = 11.79648\text{GSPS}$, interleave mode, 40-MHz offset

图 5-380. TX Single Tone Output Noise vs Frequency and Amplitude at 2.6 GHz

5.12.10 TX Typical Characteristics at 2.6GHz (continued)

Typical values at $T_A = +25^\circ\text{C}$ with nominal supplies. Unless otherwise noted, TX input data rate = 491.52MSPS, $f_{\text{DAC}} = 11796.48\text{MSPS}$, interleave mode, $A_{\text{OUT}} = -1 \text{ dBFS}$, 1st Nyquist zone output, Internal PLL, $f_{\text{REF}} = 491.52\text{MSPS}$, 24x Interpolation, DSA = 0 dB, Sin(x)/x enabled, DSA calibrated.

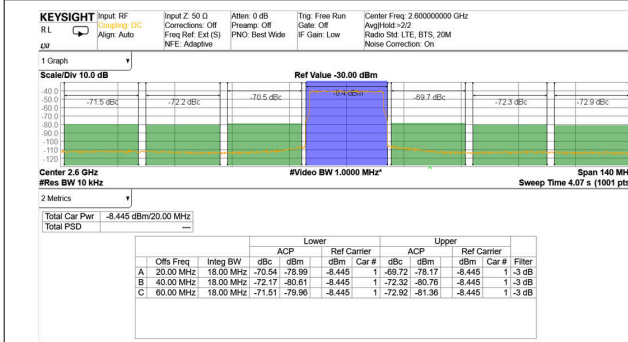

TM1.1, $P_{\text{OUT_RMS}} = -13 \text{ dBFS}$

图 5-381. TX 20-MHz LTE Output Spectrum at 2.6 GHz (Band 41)

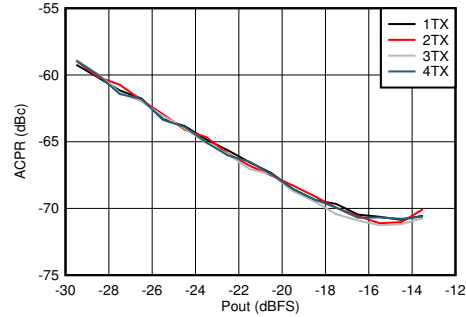

Matching at 2.6 GHz, single carrier 20-MHz BW TM1.1 LTE

图 5-382. TX 20-MHz LTE ACPR vs Digital Level at 2.6 GHz

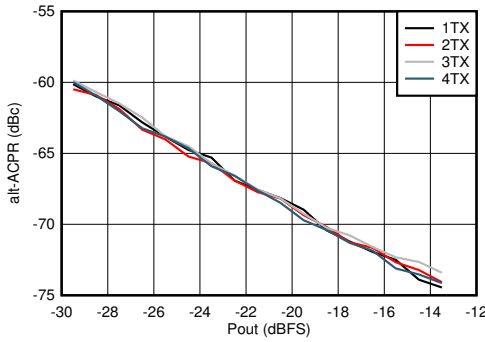

Matching at 2.6 GHz, single carrier 20-MHz BW TM1.1 LTE

图 5-383. TX 20-MHz LTE alt-ACPR vs Digital Level at 2.6 GHz

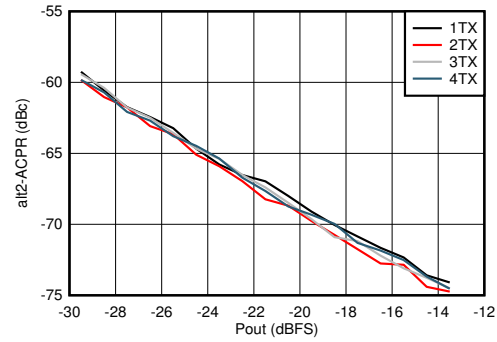

Matching at 2.6 GHz, single carrier 20-MHz BW TM1.1 LTE

图 5-384. TX 20-MHz LTE alt2-ACPR vs Digital Level at 2.6 GHz

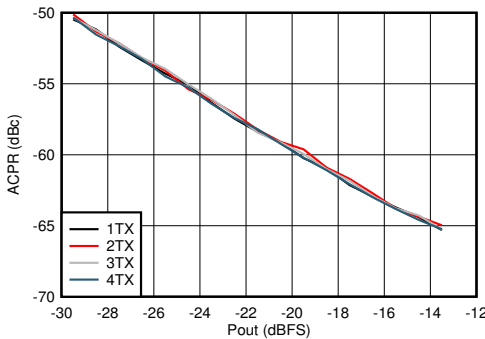

Matching at 2.6 GHz, single carrier 100-MHz BW TM1.1 NR

图 5-385. TX 100-MHz NR ACPR vs Digital Level at 2.6 GHz

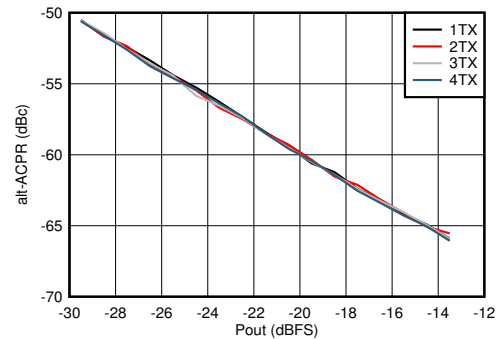

Matching at 2.6 GHz, single carrier 100-MHz BW TM1.1 NR

图 5-386. TX 100-MHz NR alt-ACPR vs Digital Level at 2.6 GHz

5.12.10 TX Typical Characteristics at 2.6GHz (continued)

Typical values at $T_A = +25^\circ\text{C}$ with nominal supplies. Unless otherwise noted, TX input data rate = 491.52MSPS, $f_{\text{DAC}} = 11796.48\text{MSPS}$, interleave mode, $A_{\text{OUT}} = -1\text{ dBFS}$, 1st Nyquist zone output, Internal PLL, $f_{\text{REF}} = 491.52\text{MSPS}$, 24x Interpolation, DSA = 0 dB, Sin(x)/x enabled, DSA calibrated.

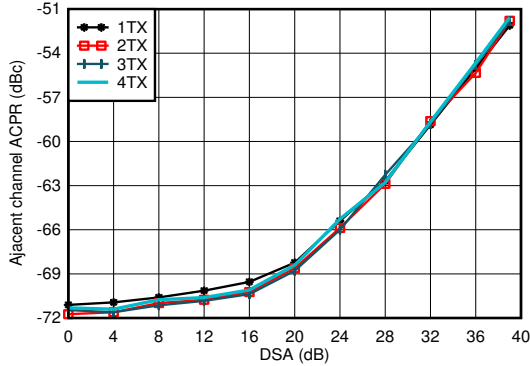

Matching at 2.6 GHz, single carrier 20-MHz BW TM1.1 LTE

图 5-387. TX 20-MHz LTE ACPR vs DSA at 2.6 GHz

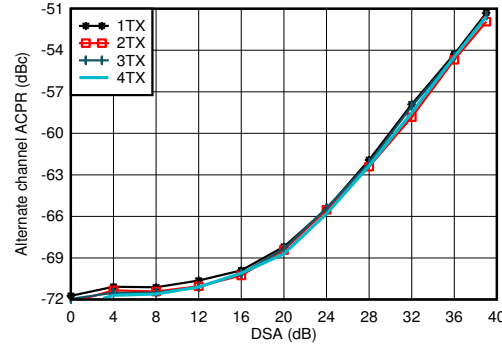

Matching at 2.6 GHz, single carrier 20-MHz BW TM1.1 LTE

图 5-388. TX 20-MHz LTE alt-ACPR vs DSA at 2.6 GHz

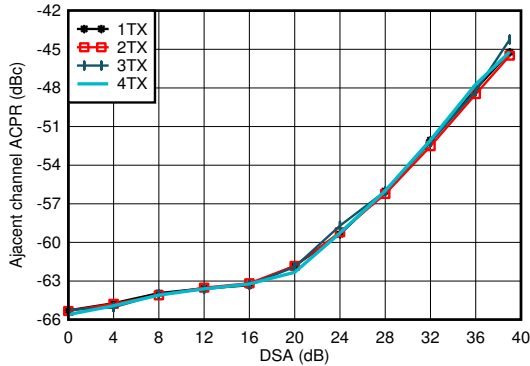

Matching at 2.6 GHz, single carrier 100-MHz BW TM1.1 NR

图 5-389. TX 100-MHz NR ACPR vs DSA at 2.6 GHz

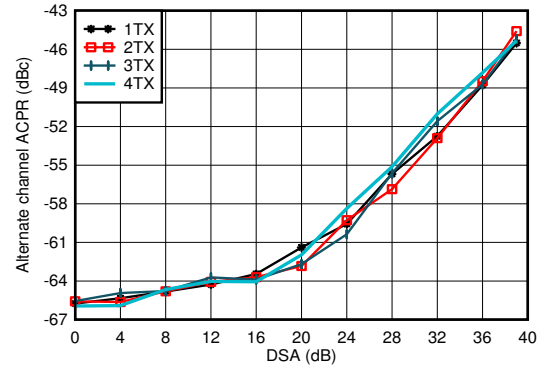

Matching at 2.6 GHz, single carrier 100-MHz BW TM1.1 NR

图 5-390. TX 100-MHz NR alt-ACPR vs DSA at 2.6 GHz

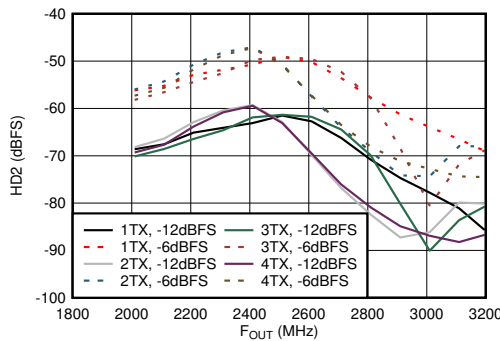

Matching at 2.6 GHz, $f_{\text{DAC}} = 11.79648\text{GSPS}$, interleave mode, normalized to output power at harmonic frequency

图 5-391. TX HD2 vs Digital Amplitude and Output Frequency at 2.6 GHz

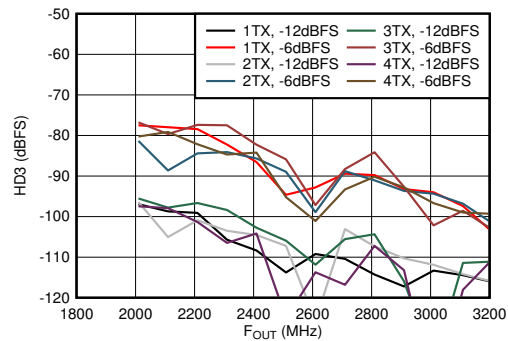

Matching at 2.6 GHz, $f_{\text{DAC}} = 11.79648\text{GSPS}$, interleave mode, normalized to output power at harmonic frequency

图 5-392. TX HD3 vs Digital Amplitude and Output Frequency at 2.6 GHz

5.12.10 TX Typical Characteristics at 2.6GHz (continued)

Typical values at $T_A = +25^\circ\text{C}$ with nominal supplies. Unless otherwise noted, TX input data rate = 491.52MSPS, $f_{\text{DAC}} = 11796.48\text{MSPS}$, interleave mode, $A_{\text{OUT}} = -1 \text{ dBFS}$, 1st Nyquist zone output, Internal PLL, $f_{\text{REF}} = 491.52\text{MSPS}$, 24x Interpolation, DSA = 0 dB, Sin(x)/x enabled, DSA calibrated.

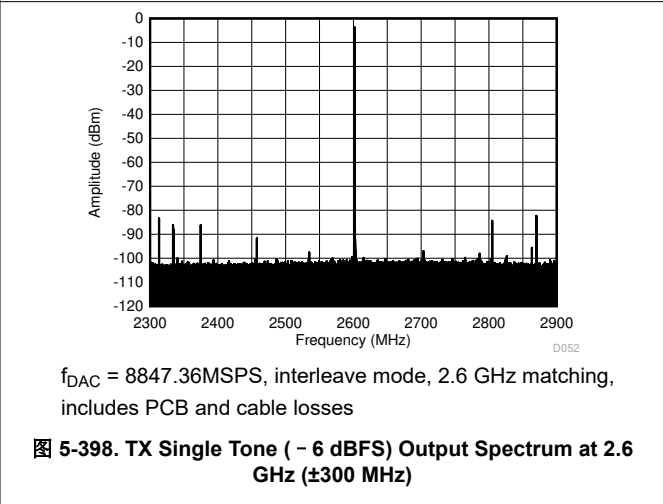
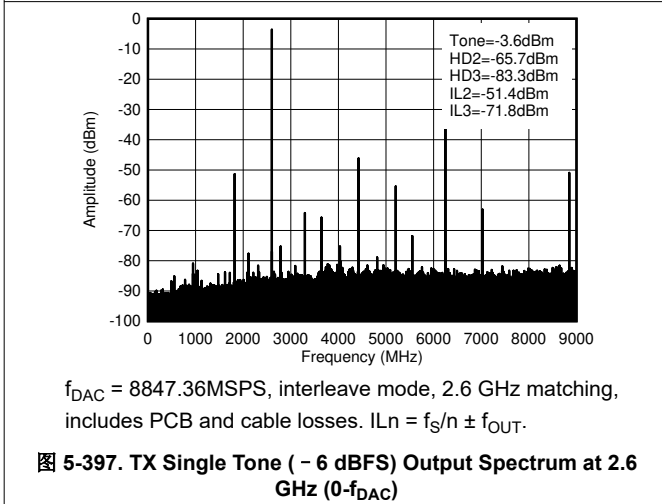
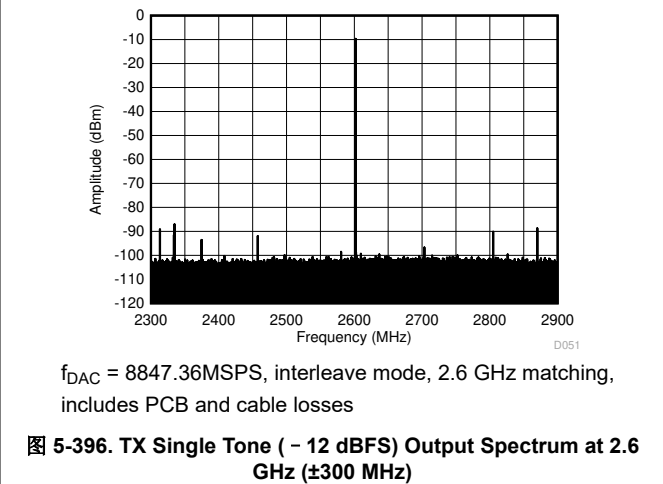
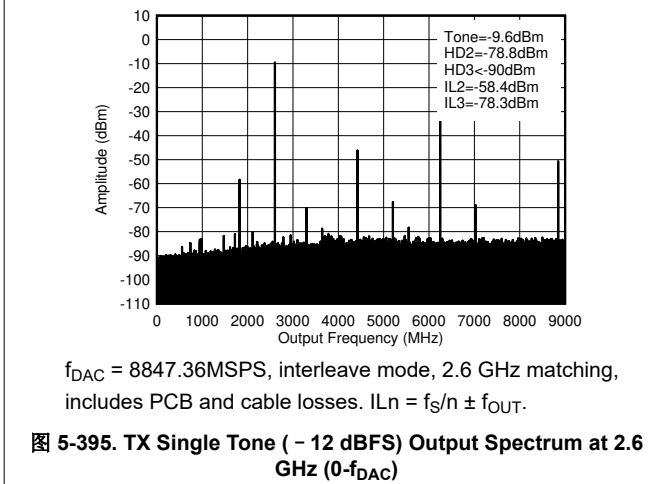
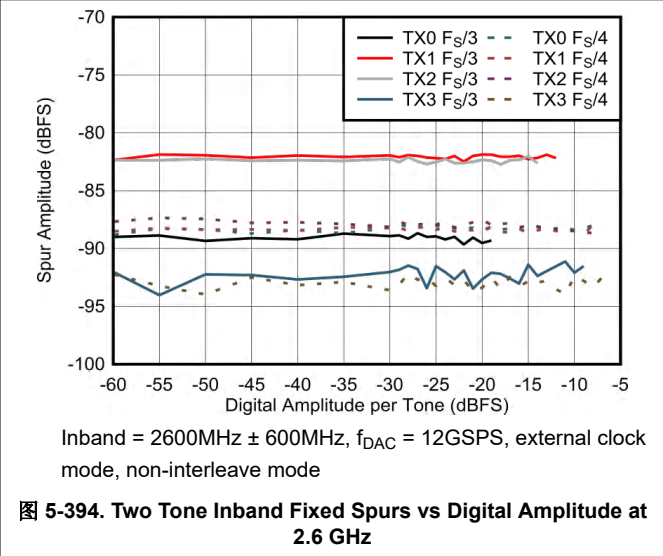
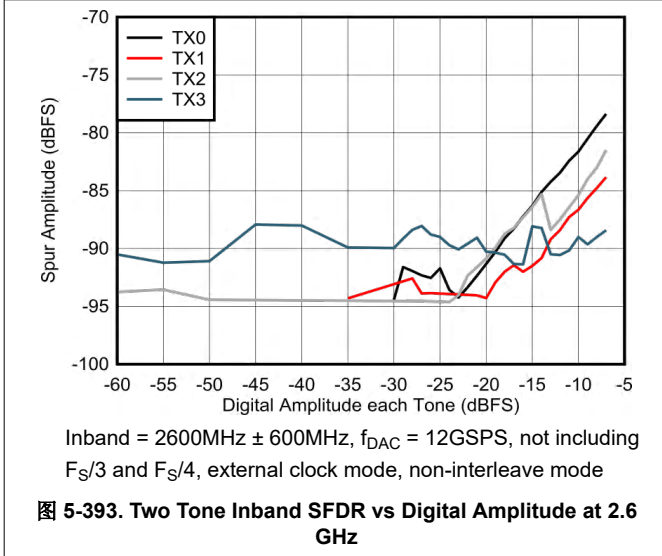

5.12.10 TX Typical Characteristics at 2.6GHz (continued)

Typical values at $T_A = +25^\circ\text{C}$ with nominal supplies. Unless otherwise noted, TX input data rate = 491.52MSPS, $f_{\text{DAC}} = 11796.48\text{MSPS}$, interleave mode, $A_{\text{OUT}} = -1 \text{ dBFS}$, 1st Nyquist zone output, Internal PLL, $f_{\text{REF}} = 491.52\text{MSPS}$, 24x Interpolation, DSA = 0 dB, Sin(x)/x enabled, DSA calibrated.

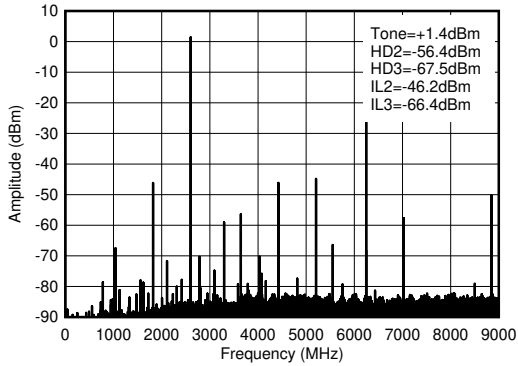

$f_{\text{DAC}} = 8847.36\text{MSPS}$, interleave mode, 2.6 GHz matching, includes PCB and cable losses. $\text{IL}_n = f_s/n \pm f_{\text{OUT}}$.

图 5-399. TX Single Tone (-1 dBFS) Output Spectrum at 2.6 GHz (0- f_{DAC})

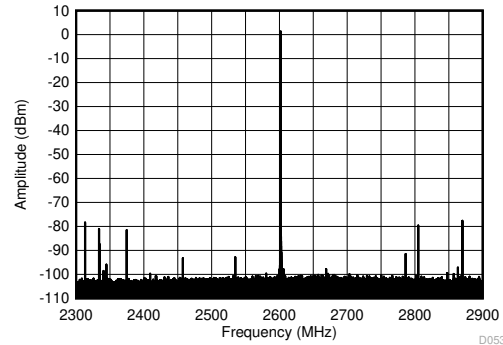

$f_{\text{DAC}} = 8847.36\text{MSPS}$, interleave mode, 2.6 GHz matching, includes PCB and cable losses

图 5-400. TX Single Tone (-1 dBFS) Output Spectrum at 2.6 GHz ($\pm 300 \text{ MHz}$)

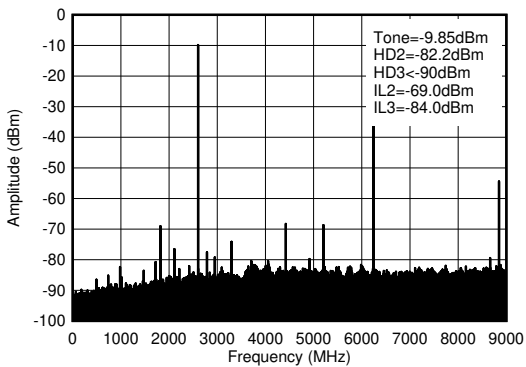

$f_{\text{DAC}} = 8847.36\text{MSPS}$, straight mode, 2.6 GHz matching, includes PCB and cable losses. $\text{IL}_n = f_s/n \pm f_{\text{OUT}}$ and is due to mixing with digital clocks.

图 5-401. TX Single Tone (-12 dBFS) Output Spectrum at 2.6 GHz (0- f_{DAC})

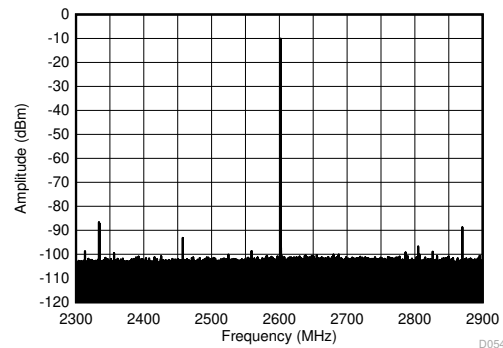

$f_{\text{DAC}} = 8847.36\text{MSPS}$, straight mode, 2.6 GHz matching, includes PCB and cable losses

图 5-402. TX Single Tone (-12 dBFS) Output Spectrum at 2.6 GHz ($\pm 300 \text{ MHz}$)

5.12.10 TX Typical Characteristics at 2.6GHz (continued)

Typical values at $T_A = +25^\circ\text{C}$ with nominal supplies. Unless otherwise noted, TX input data rate = 491.52MSPS, $f_{\text{DAC}} = 11796.48\text{MSPS}$, interleave mode, $A_{\text{OUT}} = -1\text{ dBFS}$, 1st Nyquist zone output, Internal PLL, $f_{\text{REF}} = 491.52\text{MSPS}$, 24x Interpolation, DSA = 0 dB, $\text{Sin}(x)/x$ enabled, DSA calibrated.

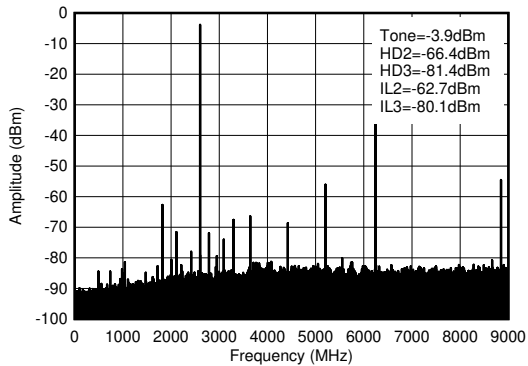

$f_{\text{DAC}} = 8847.36\text{MSPS}$, straight mode, 2.6 GHz matching, includes PCB and cable losses. $\text{IL}_n = f_s/n \pm f_{\text{OUT}}$ and is due to mixing with digital clocks.

图 5-403. TX Single Tone (- 6 dBFS) Output Spectrum at 2.6 GHz ($0-f_{\text{DAC}}$)

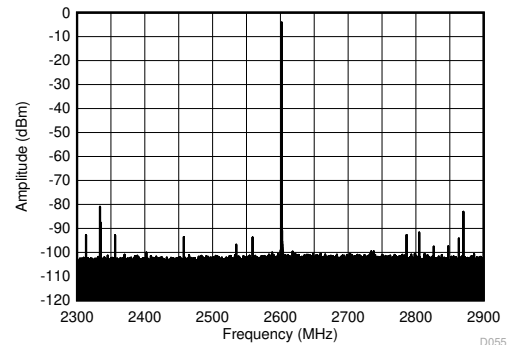

$f_{\text{DAC}} = 8847.36\text{MSPS}$, straight mode, 2.6 GHz matching, includes PCB and cable losses

图 5-404. TX Single Tone (- 6 dBFS) Output Spectrum at 2.6 GHz ($\pm 300\text{ MHz}$)

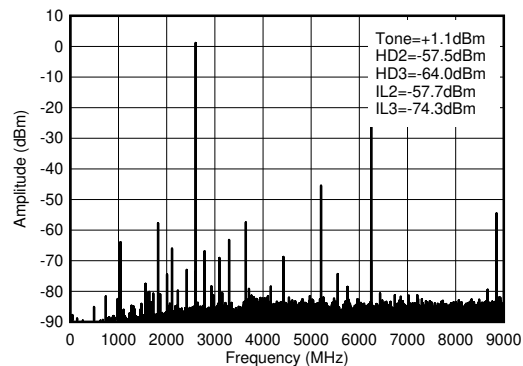

$f_{\text{DAC}} = 8847.36\text{MSPS}$, straight mode, 2.6 GHz matching, includes PCB and cable losses. $\text{IL}_n = f_s/n \pm f_{\text{OUT}}$ and is due to mixing with digital clocks.

图 5-405. TX Single Tone (- 1 dBFS) Output Spectrum at 2.6 GHz ($0-f_{\text{DAC}}$)

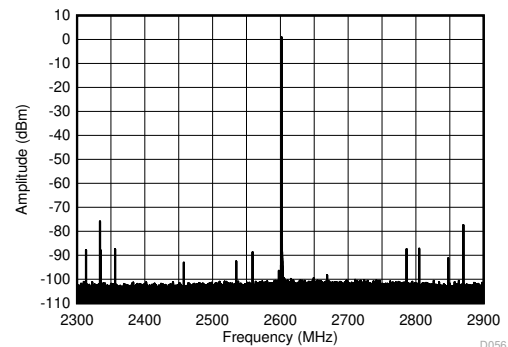

$f_{\text{DAC}} = 8847.36\text{MSPS}$, straight mode, 2.6 GHz matching, includes PCB and cable losses

图 5-406. TX Single Tone (- 1 dBFS) Output Spectrum at 2.6 GHz ($\pm 300\text{ MHz}$)

5.12.10 TX Typical Characteristics at 2.6GHz (continued)

Typical values at $T_A = +25^\circ\text{C}$ with nominal supplies. Unless otherwise noted, TX input data rate = 491.52MSPS, $f_{\text{DAC}} = 11796.48\text{MSPS}$, interleave mode, $A_{\text{OUT}} = -1 \text{ dBFS}$, 1st Nyquist zone output, Internal PLL, $f_{\text{REF}} = 491.52\text{MSPS}$, 24x Interpolation, DSA = 0 dB, Sin(x)/x enabled, DSA calibrated.

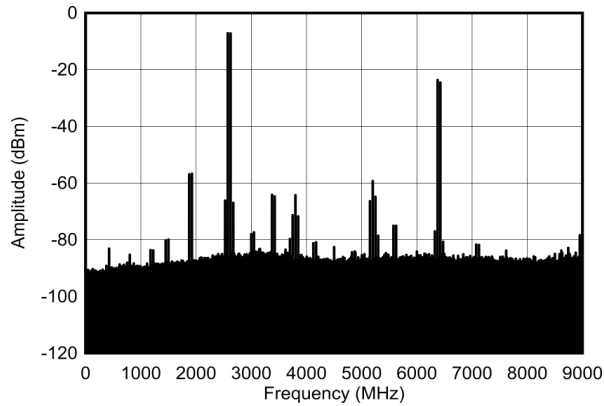

$f_{\text{DAC}} = 9000\text{MSPS}$, external clock mode, non-interleave mode

图 5-407. TX Dual Tone Output Spectrum at 2.6 GHz, -7dBFS each (0 - DAC)

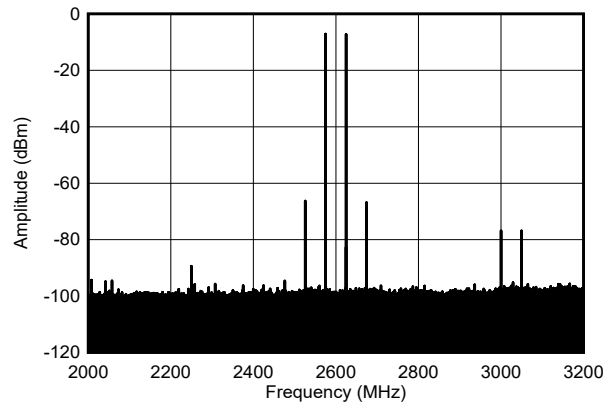

$f_{\text{DAC}} = 9000\text{MSPS}$, external clock mode, non-interleave mode

图 5-408. TX Dual Tone Output Spectrum at 2.6 GHz, -7dBFS each ($\pm 600 \text{ MHz}$)

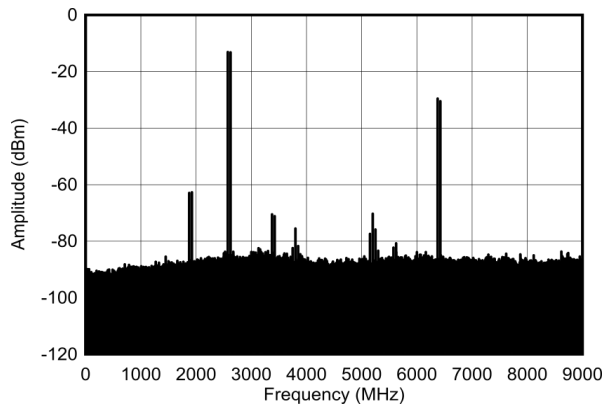

$f_{\text{DAC}} = 9000\text{MSPS}$, external clock mode, non-interleave mode

图 5-409. TX Dual Tone Output Spectrum at 2.6 GHz, -13dBFS each (0 - DAC)

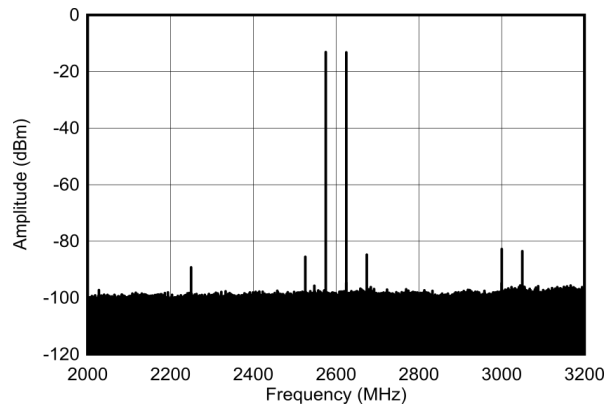

$f_{\text{DAC}} = 9000\text{MSPS}$, external clock mode, non-interleave mode

图 5-410. TX Dual Tone Output Spectrum at 2.6 GHz, -13dBFS each ($\pm 600 \text{ MHz}$)

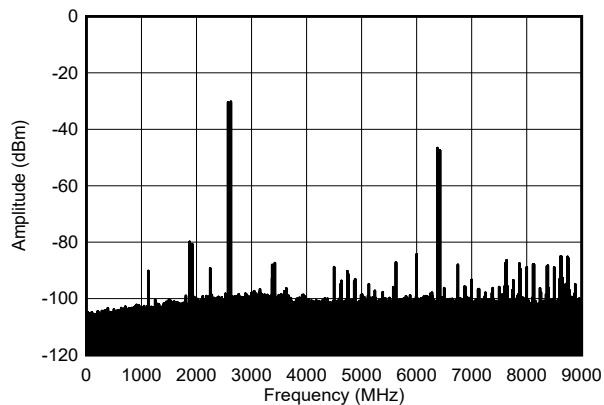

$f_{\text{DAC}} = 9000\text{MSPS}$, external clock mode, non-interleave mode

图 5-411. TX Dual Tone Output Spectrum at 2.6 GHz, -30dBFS each (0 - DAC)

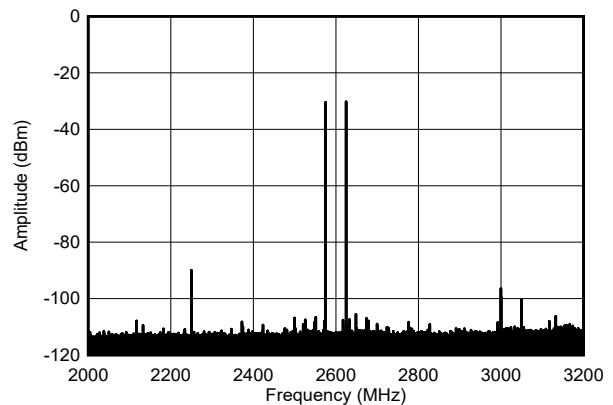

$f_{\text{DAC}} = 9000\text{MSPS}$, external clock mode, non-interleave mode

图 5-412. TX Dual Tone Output Spectrum at 2.6 GHz, -30dBFS each ($\pm 600 \text{ MHz}$)

5.12.10 TX Typical Characteristics at 2.6GHz (continued)

Typical values at $T_A = +25^\circ\text{C}$ with nominal supplies. Unless otherwise noted, TX input data rate = 491.52MSPS, $f_{\text{DAC}} = 11796.48\text{MSPS}$, interleave mode, $A_{\text{OUT}} = -1\text{ dBFS}$, 1st Nyquist zone output, Internal PLL, $f_{\text{REF}} = 491.52\text{MSPS}$, 24x Interpolation, DSA = 0 dB, Sin(x)/x enabled, DSA calibrated.

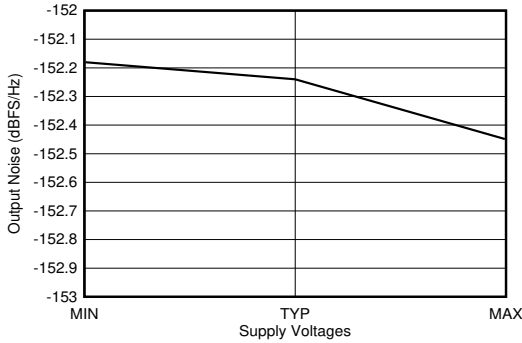

$f_{\text{DAC}} = 11796.48\text{MSPS}$, interleave mode, 2.6 GHz matching. 40-MHz offset from tone. Output Power = -1 dBFS. All supplies simultaneously at MIN, TYP, or MAX voltages.

图 5-413. TX Output Noise vs Supply Voltage at 2.6 GHz

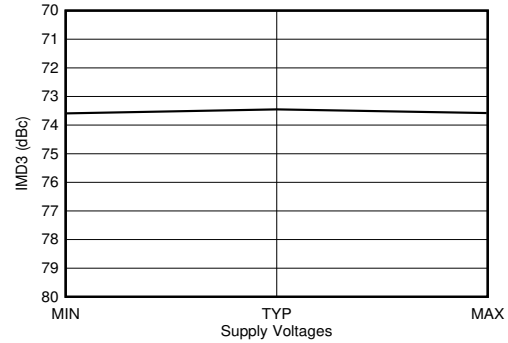

$f_{\text{DAC}} = 11796.48\text{MSPS}$, interleave mode, 2.6 GHz matching. 40-MHz offset from tone. Output Power = -13 dBFS. All supplies simultaneously at MIN, TYP, or MAX voltages.

图 5-414. TX IMD3 vs Supply Voltage at 2.6 GHz

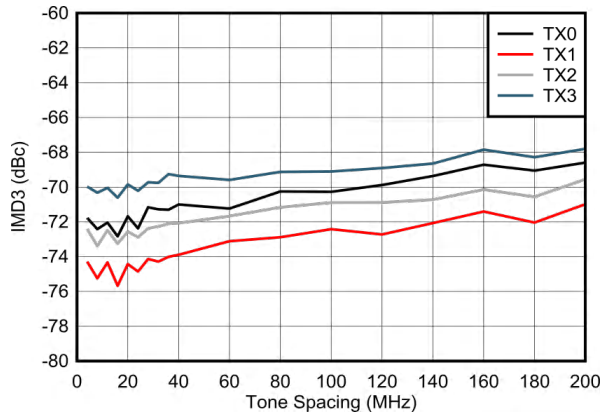

$f_{\text{DAC}} = 9000\text{MSPS}$, non-interleave mode, external clock mode

图 5-415. IMD3 vs Tone Spacing and Channel at 2.6 GHz

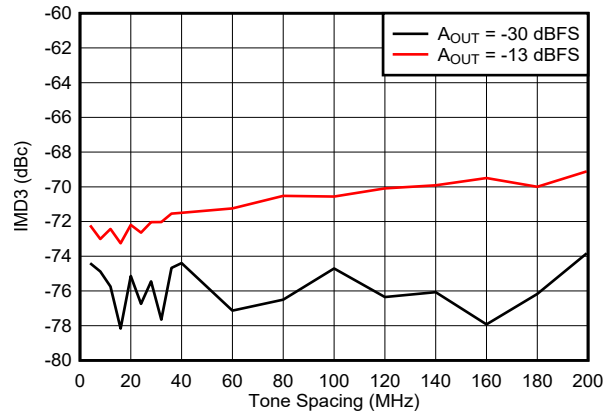

$f_{\text{DAC}} = 9000\text{MSPS}$, non-interleave mode, external clock mode

图 5-416. IMD3 vs Tone Spacing and Amplitude at 2.6 GHz

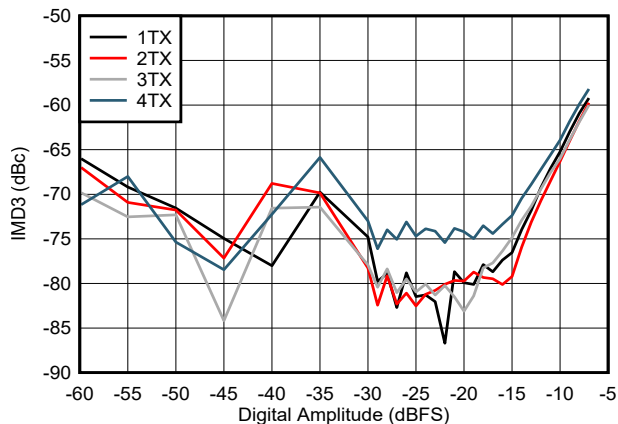

$f_{\text{DAC}} = 9000\text{MSPS}$, non-interleave mode, external clock mode

图 5-417. IMD3 vs Digital Amplitude and Channel at 2.6 GHz

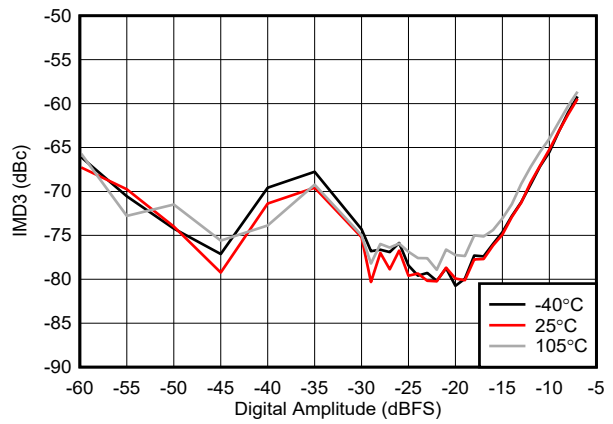

$f_{\text{DAC}} = 9000\text{MSPS}$, non-interleave mode, external clock mode

图 5-418. IMD3 vs Digital Amplitude and Temperature at 2.6 GHz

5.12.10 TX Typical Characteristics at 2.6GHz (continued)

Typical values at $T_A = +25^\circ\text{C}$ with nominal supplies. Unless otherwise noted, TX input data rate = 491.52MSPS, $f_{\text{DAC}} = 11796.48\text{MSPS}$, interleave mode, $A_{\text{OUT}} = -1\text{ dBFS}$, 1st Nyquist zone output, Internal PLL, $f_{\text{REF}} = 491.52\text{MSPS}$, 24x Interpolation, DSA = 0 dB, Sin(x)/x enabled, DSA calibrated.

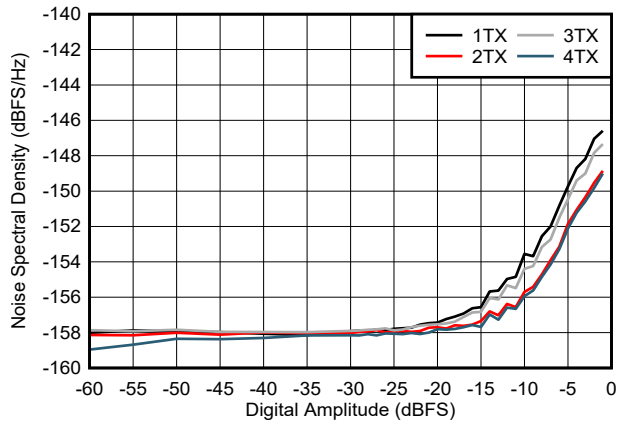

$f_{\text{DAC}} = 9000\text{MSPS}$, non-interleave mode, external clock mode, 50MHz offset

图 5-419. NSD vs Digital Amplitude and Channel at 2.6 GHz

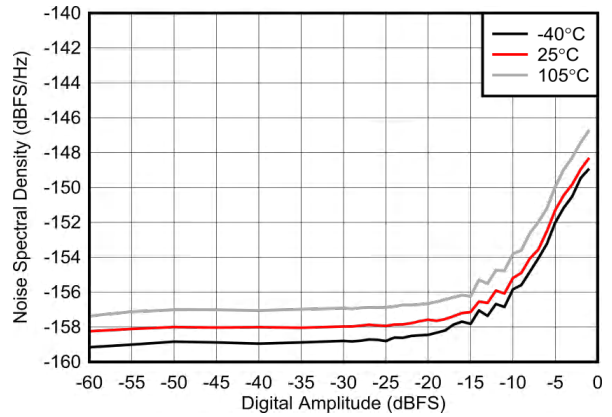

$f_{\text{DAC}} = 9000\text{MSPS}$, non-interleave mode, external clock mode, 50MHz offset

图 5-420. NSD vs Digital Amplitude and Temperature at 2.6 GHz

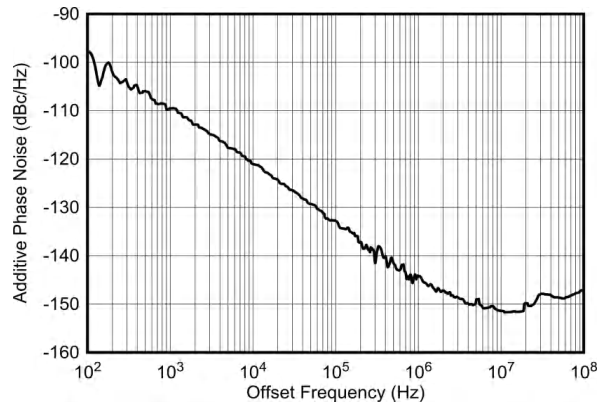

$f_{\text{DAC}} = f_{\text{CLK}} = 9000\text{MSPS}$, non-interleave mode

图 5-421. External Clock Additive Phase Noise at 2.6 GHz

5.12.11 TX Typical Characteristics at 3.5GHz

Typical values at $T_A = +25^\circ\text{C}$ with nominal supplies. Unless otherwise noted, TX input data rate = 491.52MSPS, $f_{\text{DAC}} = 11796.48\text{MSPS}$, interleave mode, $A_{\text{OUT}} = -1\text{ dBFS}$, 1st Nyquist zone output, Internal PLL, $f_{\text{REF}} = 491.52\text{MSPS}$, 24x Interpolation, DSA = 0 dB, Sin(x)/x enabled, DSA calibrated.

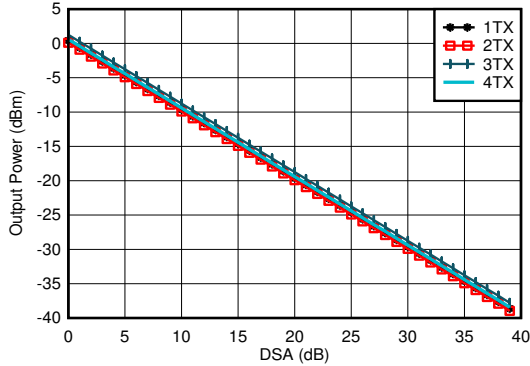

$A_{\text{out}} = -0.5\text{dBFS}$, 3.5 GHz Matching, included PCB and cable losses

图 5-422. TX Output Power vs DSA Setting at 3.5 GHz

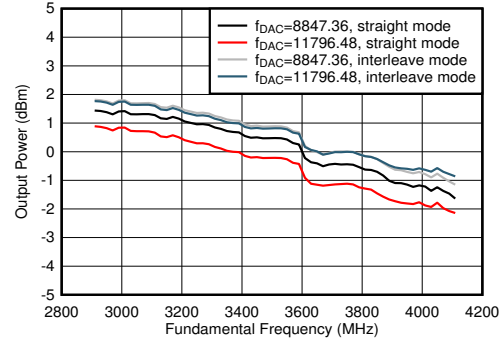

$A_{\text{out}} = -0.5\text{dBFS}$, 3.5 GHz Matching, included PCB and cable losses

图 5-423. TX Output Power vs Frequency

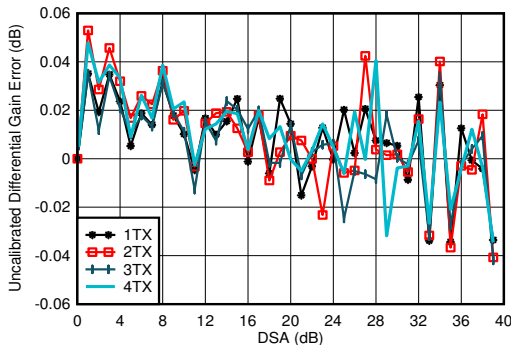

3.5 GHz Matching, included PCB and cable losses

$$\text{Differential Gain Error} = P_{\text{OUT}}(\text{DSA Setting} - 1) - P_{\text{OUT}}(\text{DSA Setting}) + 1$$

图 5-424. TX Uncalibrated Differential Gain Error vs DSA Setting and Channel at 3.5 GHz

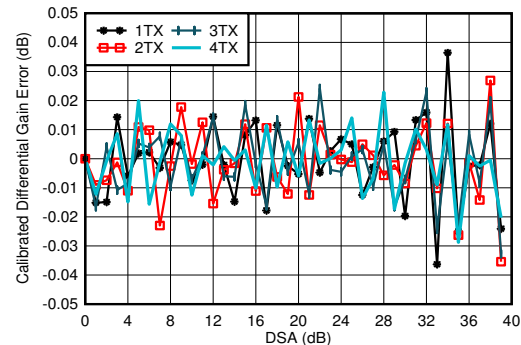

3.5 GHz Matching, included PCB and cable losses

$$\text{Differential Gain Error} = P_{\text{OUT}}(\text{DSA Setting} - 1) - P_{\text{OUT}}(\text{DSA Setting}) + 1$$

图 5-425. TX Calibrated Differential Gain Error vs DSA Setting and Channel at 3.5 GHz

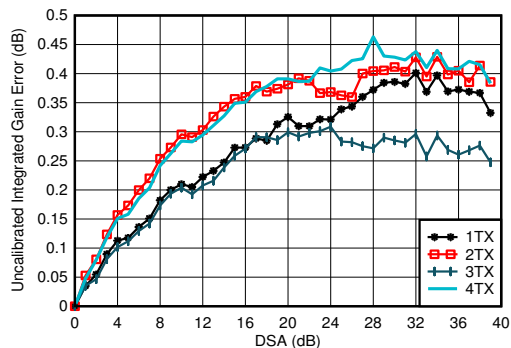

3.5 GHz Matching, included PCB and cable losses

$$\text{Integrated Gain Error} = P_{\text{OUT}}(\text{DSA Setting}) - P_{\text{OUT}}(\text{DSA Setting} = 0) + (\text{DSA Setting})$$

图 5-426. TX Uncalibrated Integrated Gain Error vs DSA Setting and Channel at 3.5 GHz

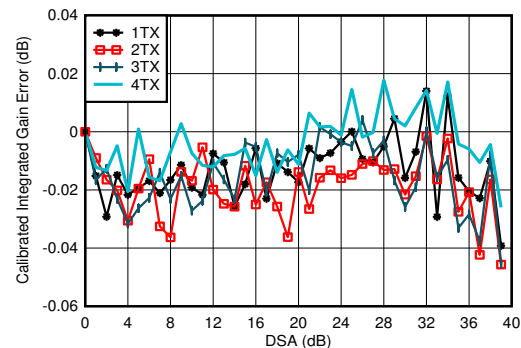

3.5 GHz Matching, included PCB and cable losses

$$\text{Integrated Gain Error} = P_{\text{OUT}}(\text{DSA Setting}) - P_{\text{OUT}}(\text{DSA Setting} = 0) + (\text{DSA Setting})$$

图 5-427. TX Calibrated Integrated Gain Error vs DSA Setting and Channel at 3.5 GHz

5.12.11 TX Typical Characteristics at 3.5GHz (continued)

Typical values at $T_A = +25^\circ\text{C}$ with nominal supplies. Unless otherwise noted, TX input data rate = 491.52MSPS, $f_{\text{DAC}} = 11796.48\text{MSPS}$, interleave mode, $A_{\text{OUT}} = -1\text{ dBFS}$, 1st Nyquist zone output, Internal PLL, $f_{\text{REF}} = 491.52\text{MSPS}$, 24x Interpolation, DSA = 0 dB, Sin(x)/x enabled, DSA calibrated.

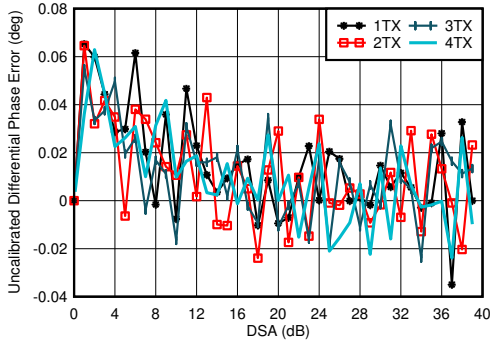

3.5 GHz Matching, included PCB and cable losses
Differential Phase Error = $\text{Phase}_{\text{OUT}}(\text{DSA Setting} - 1) - \text{Phase}_{\text{OUT}}(\text{DSA Setting})$

图 5-428. TX Uncalibrated Differential Phase Error vs DSA Setting and Channel at 3.5 GHz

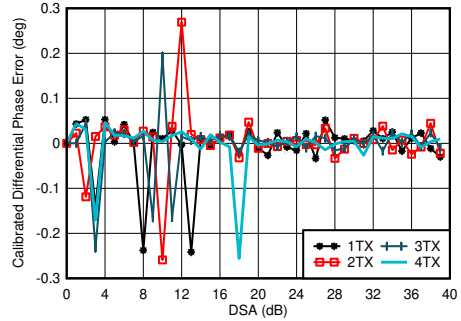

3.5 GHz Matching, included PCB and cable losses
Differential Phase Error = $\text{Phase}_{\text{OUT}}(\text{DSA Setting} - 1) - \text{Phase}_{\text{OUT}}(\text{DSA Setting})$. Phase DNL spike may occur at any DSA setting.

图 5-429. TX Calibrated Differential Phase Error vs DSA Setting and Channel at 3.5 GHz

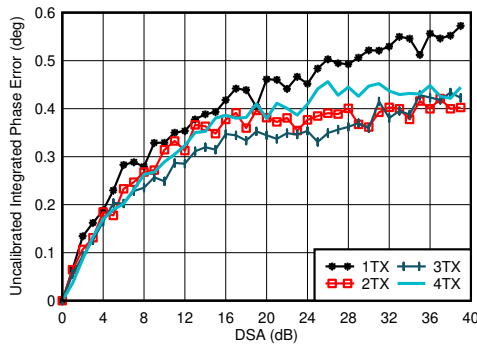

3.5 GHz Matching, included PCB and cable losses
Integrated Phase Error = $\text{Phase}(\text{DSA Setting}) - \text{Phase}(\text{DSA Setting} = 0)$

图 5-430. TX Uncalibrated Integrated Phase Error vs DSA Setting and Channel at 3.5 GHz

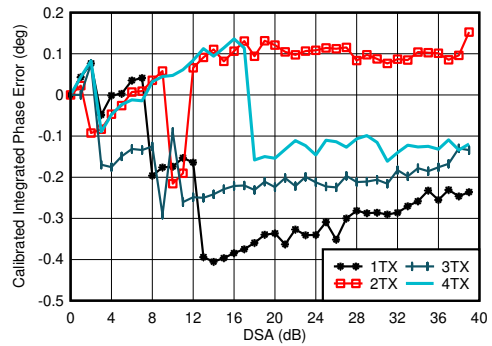

3.5 GHz Matching, included PCB and cable losses
Integrated Phase Error = $\text{Phase}(\text{DSA Setting}) - \text{Phase}(\text{DSA Setting} = 0)$

图 5-431. TX Calibrated Integrated Phase Error vs DSA Setting and Channel at 3.5 GHz

5.12.11 TX Typical Characteristics at 3.5GHz (continued)

Typical values at $T_A = +25^\circ\text{C}$ with nominal supplies. Unless otherwise noted, TX input data rate = 491.52MSPS, $f_{\text{DAC}} = 11796.48\text{MSPS}$, interleave mode, $A_{\text{OUT}} = -1\text{ dBFS}$, 1st Nyquist zone output, Internal PLL, $f_{\text{REF}} = 491.52\text{MSPS}$, 24x Interpolation, DSA = 0 dB, Sin(x)/x enabled, DSA calibrated.

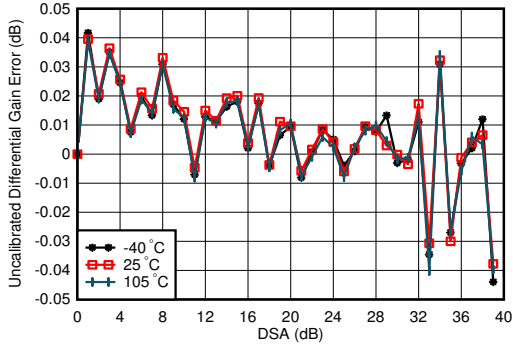

3.5 GHz Matching, 1TX
Differential Phase Error = $\text{Phase}_{\text{OUT}}(\text{DSA Setting} - 1) - \text{Phase}_{\text{OUT}}(\text{DSA Setting})$

图 5-432. TX Uncalibrated Differential Gain Error vs DSA Setting and Temperature at 3.5 GHz

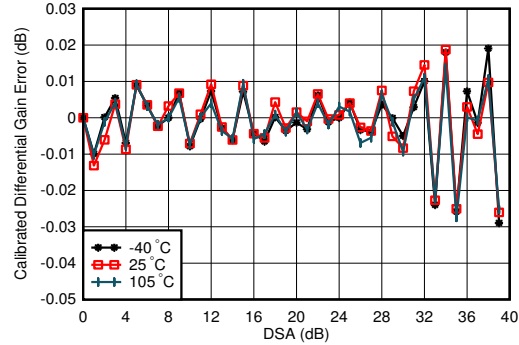

3.5 GHz Matching, 1TX, Calibrated at 25°C
Differential Phase Error = $\text{Phase}_{\text{OUT}}(\text{DSA Setting} - 1) - \text{Phase}_{\text{OUT}}(\text{DSA Setting})$

图 5-433. TX Calibrated Differential Gain Error vs DSA Setting and Temperature at 3.5 GHz

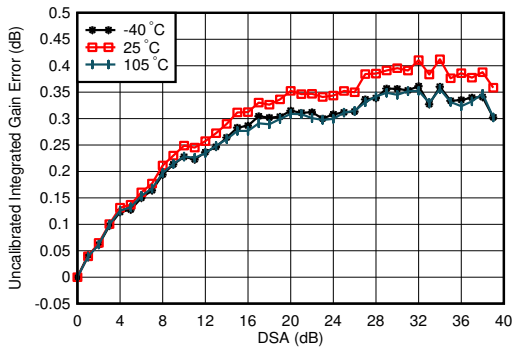

3.5 GHz Matching, 1TX
Integrated Phase Error = $\text{Phase}(\text{DSA Setting}) - \text{Phase}(\text{DSA Setting} = 0)$

图 5-434. TX Uncalibrated Integrated Gain Error vs DSA Setting and Temperature at 3.5 GHz

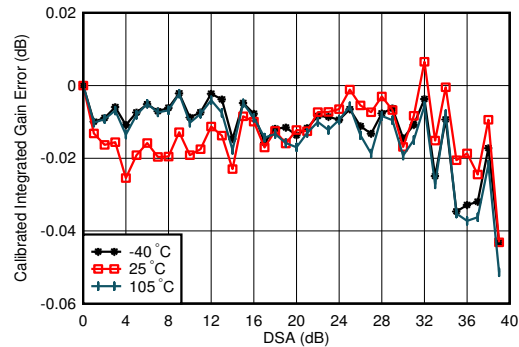

3.5 GHz Matching, 1TX, Calibrated at 25°C
Integrated Phase Error = $\text{Phase}(\text{DSA Setting}) - \text{Phase}(\text{DSA Setting} = 0)$

图 5-435. TX Calibrated Integrated Gain Error vs DSA Setting and Temperature at 3.5 GHz

5.12.11 TX Typical Characteristics at 3.5GHz (continued)

Typical values at $T_A = +25^\circ\text{C}$ with nominal supplies. Unless otherwise noted, TX input data rate = 491.52MSPS, $f_{\text{DAC}} = 11796.48\text{MSPS}$, interleave mode, $A_{\text{OUT}} = -1\text{ dBFS}$, 1st Nyquist zone output, Internal PLL, $f_{\text{REF}} = 491.52\text{MSPS}$, 24x Interpolation, DSA = 0 dB, Sin(x)/x enabled, DSA calibrated.

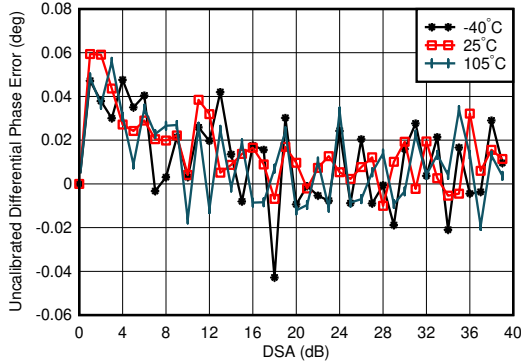

3.5 GHz Matching, 1TX
Differential Phase Error = $\text{Phase}_{\text{OUT}}(\text{DSA Setting} - 1) - \text{Phase}_{\text{OUT}}(\text{DSA Setting})$

图 5-436. TX Uncalibrated Differential Phase Error vs DSA setting and Temperature at 3.5 GHz

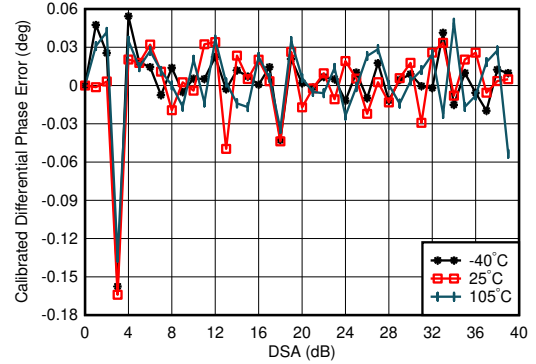

3.5 GHz Matching, 1TX, Calibrated at 25°C
Differential Phase Error = $\text{Phase}_{\text{OUT}}(\text{DSA Setting} - 1) - \text{Phase}_{\text{OUT}}(\text{DSA Setting})$

图 5-437. TX Calibrated Differential Phase Error vs DSA Setting and Temperature at 3.5 GHz

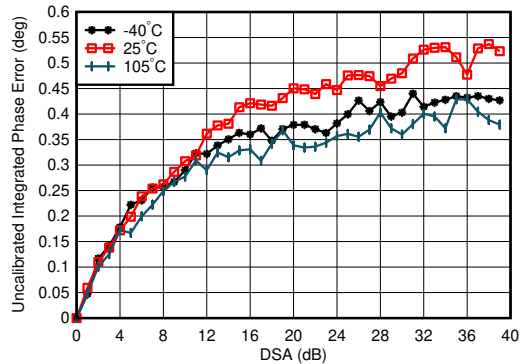

3.5 GHz Matching, 1TX
Integrated Phase Error = $\text{Phase}(\text{DSA Setting}) - \text{Phase}(\text{DSA Setting}=0)$

图 5-438. TX Uncalibrated Integrated Phase Error vs DSA Setting and Temperature at 3.5 GHz

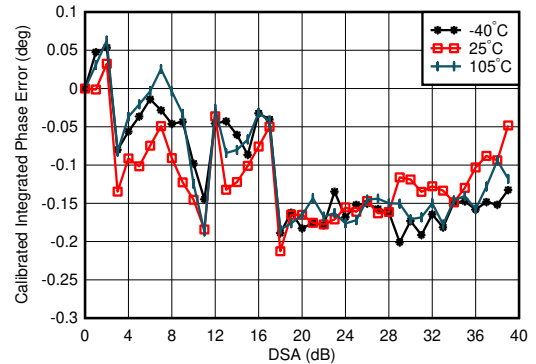

3.5 GHz Matching, 1TX, Calibrated at 25°C
Integrated Phase Error = $\text{Phase}(\text{DSA Setting}) - \text{Phase}(\text{DSA Setting} = 0)$

图 5-439. TX Calibrated Integrated Phase Error vs DSA Setting and Temperature at 3.5 GHz

5.12.11 TX Typical Characteristics at 3.5GHz (continued)

Typical values at $T_A = +25^\circ\text{C}$ with nominal supplies. Unless otherwise noted, TX input data rate = 491.52MSPS, $f_{\text{DAC}} = 11796.48\text{MSPS}$, interleave mode, $A_{\text{OUT}} = -1 \text{ dBFS}$, 1st Nyquist zone output, Internal PLL, $f_{\text{REF}} = 491.52\text{MSPS}$, 24x Interpolation, DSA = 0 dB, Sin(x)/x enabled, DSA calibrated.

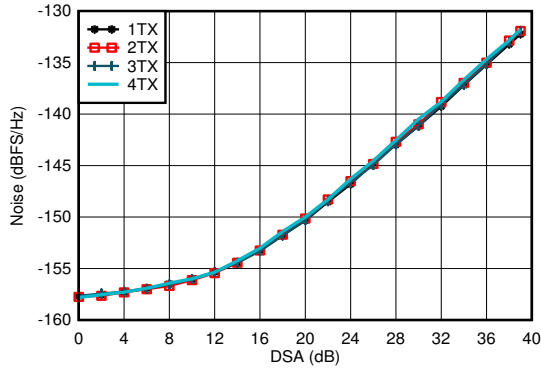

A. $f_{\text{DAC}}=11796.48\text{MSPS}$, interleave mode, matching at 3.5GHz, $A_{\text{out}} = -13 \text{ dBFS}$.

图 5-440. TX NSD vs DSA Setting at 3.5 GHz

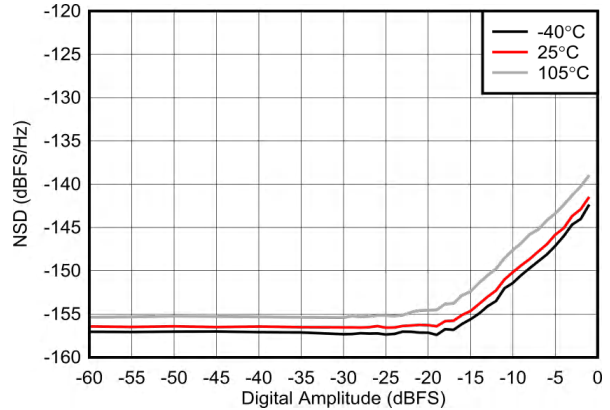

A. $f_{\text{DAC}}=12\text{MSPS}$, external clock mode, non-interleave mode

图 5-441. TX NSD vs Digital Amplitude and Temperature at 3.75 GHz

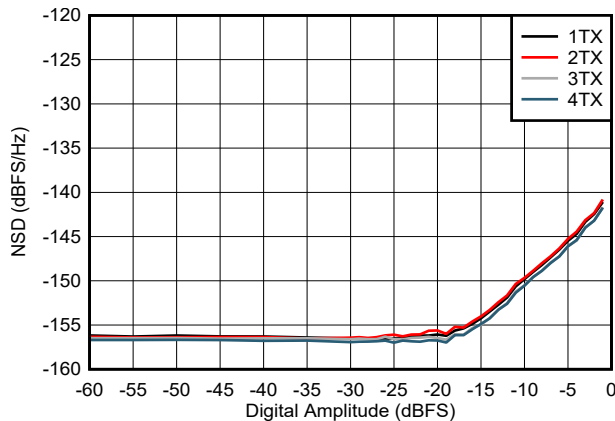

A. $f_{\text{DAC}}=12\text{MSPS}$, external clock mode, non-interleave mode

图 5-442. TX NSD vs Digital Amplitude and Channel at 3.75 GHz

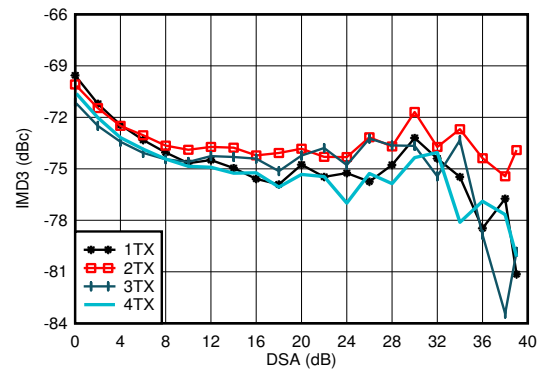

20-MHz tone spacing, 3.5 GHz Matching, -13 dBFS each tone, included PCB and cable losses

图 5-443. TX IMD3 vs DSA Setting at 3.5 GHz

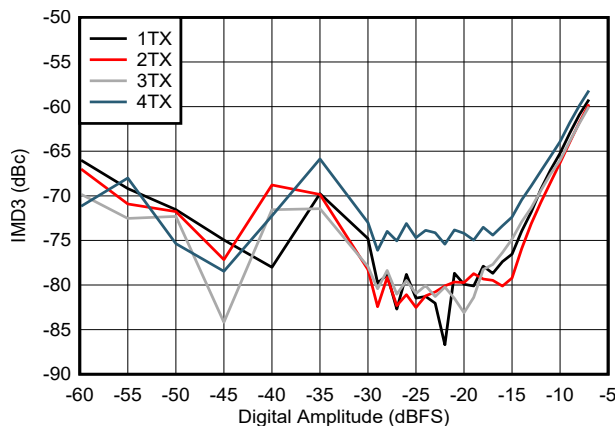

20-MHz tone spacing, 3.5 GHz Matching

图 5-444. TX IMD3 vs Digital Amplitude and Channel at 3.5 GHz

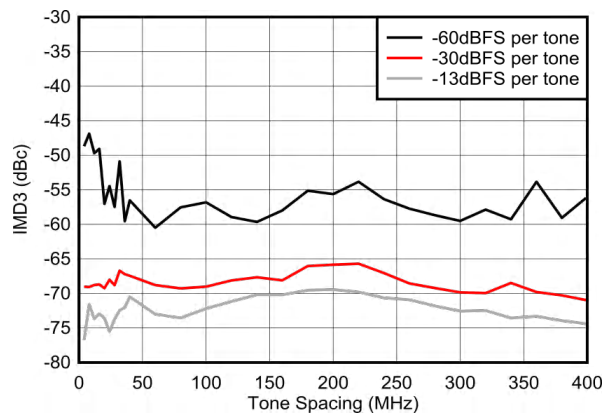

50-MHz tone spacing, external clock mode, non-interleave mode

图 5-445. TX IMD3 vs Tone Spacing and Amplitude at 3.75GHz

5.12.11 TX Typical Characteristics at 3.5GHz (continued)

Typical values at $T_A = +25^\circ\text{C}$ with nominal supplies. Unless otherwise noted, TX input data rate = 491.52MSPS, $f_{\text{DAC}} = 11796.48\text{MSPS}$, interleave mode, $A_{\text{OUT}} = -1\text{ dBFS}$, 1st Nyquist zone output, Internal PLL, $f_{\text{REF}} = 491.52\text{MSPS}$, 24x Interpolation, DSA = 0 dB, $\text{Sin}(x)/x$ enabled, DSA calibrated.

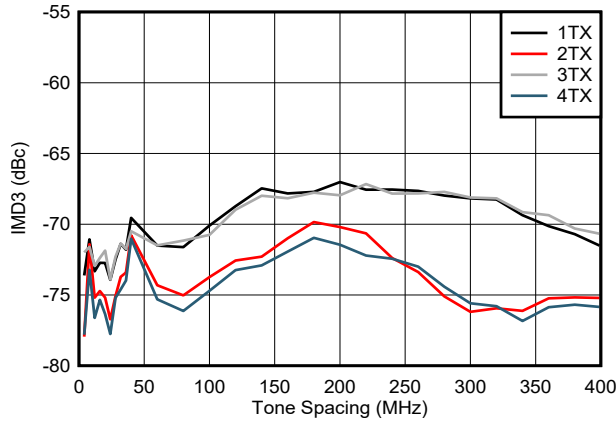

External clock mode, non-interleave mode

图 5-446. TX IMD3 vs Tone Spacing and Channel at 3.75GHz

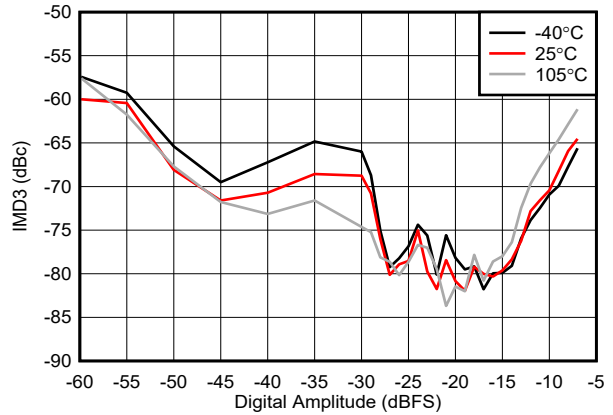

50-MHz tone spacing, external clock mode, non-interleave mode

图 5-447. TX IMD3 vs Digital Amplitude and Temperature at 3.75GHz

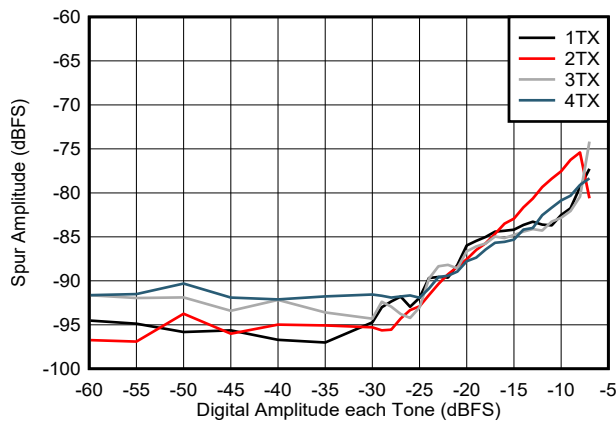

Inband = 3.75GHz \pm 600MHz, $f_{\text{DAC}} = 9\text{GSPS}$, external clock mode, non-interleave mode.

图 5-448. Two Tone Inband SFDR vs Digital Amplitude at 3.75GHz



3.5 GHz Matching, single carrier 20-MHz BW TM1.1 LTE

图 5-449. TX 20-MHz LTE Output Spectrum at 3.5 GHz (Band 42)

5.12.11 TX Typical Characteristics at 3.5GHz (continued)

Typical values at $T_A = +25^\circ\text{C}$ with nominal supplies. Unless otherwise noted, TX input data rate = 491.52MSPS, $f_{\text{DAC}} = 11796.48\text{MSPS}$, interleave mode, $A_{\text{OUT}} = -1 \text{ dBFS}$, 1st Nyquist zone output, Internal PLL, $f_{\text{REF}} = 491.52\text{MSPS}$, 24x Interpolation, DSA = 0 dB, $\text{Sin}(x)/x$ enabled, DSA calibrated.

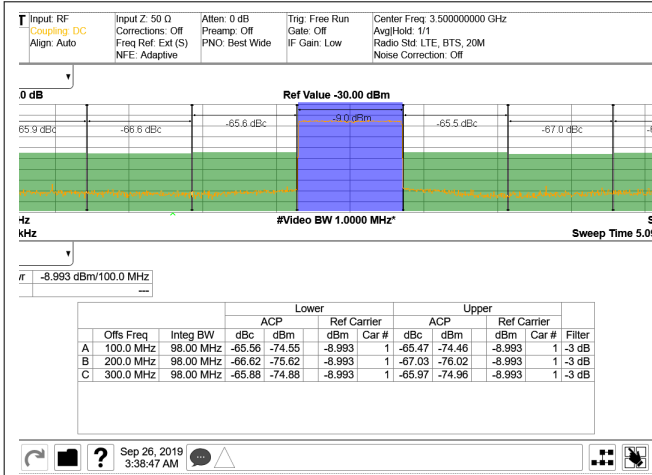

3.5 GHz Matching, single carrier 100-MHz BW NR TM1.1

图 5-450. TX 100-MHz NR Output Spectrum at 3.5 GHz (Band 42)

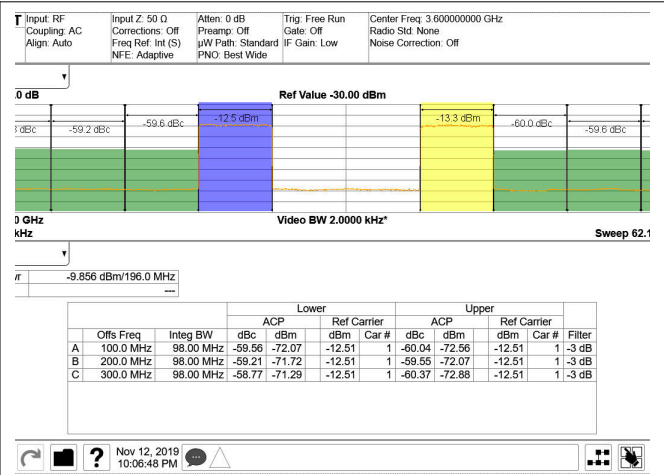

3.5 GHz Matching, single carrier 100-MHz BW NR TM1.1

图 5-451. TX 2 carrier 100-MHz NR Output Spectrum at 3.45 GHz and 3.75 GHz

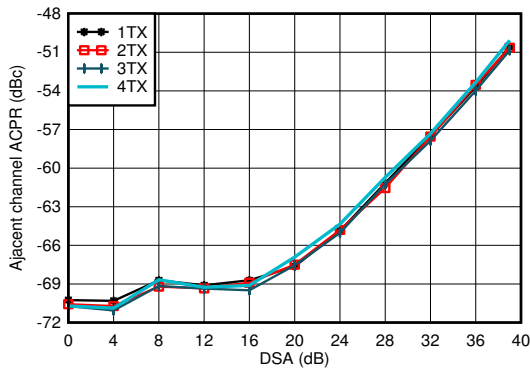

3.5 GHz Matching, single carrier 20-MHz BW TM1.1 LTE

图 5-452. TX 20-MHz LTE ACPR vs DSA Setting at 3.5 GHz

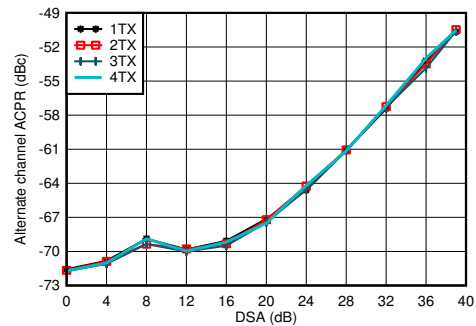

3.5 GHz Matching, single carrier 20-MHz BW TM1.1 LTE

图 5-453. TX 20-MHz LTE alt-ACPR vs DSA Setting at 3.5 GHz

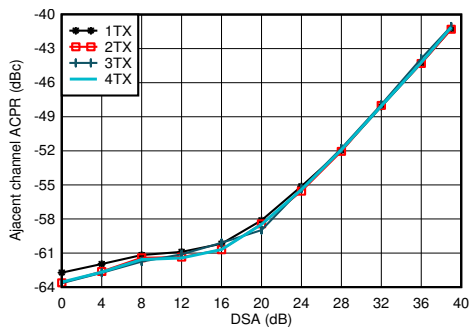

3.5 GHz Matching, single carrier 100-MHz BW NR TM1.1

图 5-454. TX 100-MHz NR ACPR vs DSA Setting at 3.5 GHz

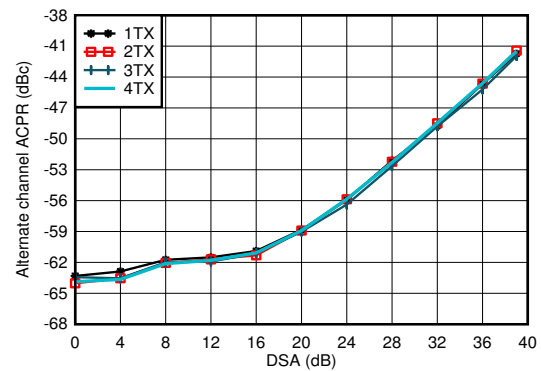

3.5 GHz Matching, single carrier 100-MHz BW NR TM1.1

图 5-455. TX 100-MHz NR alt-ACPR vs DSA Setting at 3.5 GHz

5.12.11 TX Typical Characteristics at 3.5GHz (continued)

Typical values at $T_A = +25^\circ\text{C}$ with nominal supplies. Unless otherwise noted, TX input data rate = 491.52MSPS, $f_{\text{DAC}} = 11796.48\text{MSPS}$, interleave mode, $A_{\text{OUT}} = -1\text{ dBFS}$, 1st Nyquist zone output, Internal PLL, $f_{\text{REF}} = 491.52\text{MSPS}$, 24x Interpolation, DSA = 0 dB, Sin(x)/x enabled, DSA calibrated.

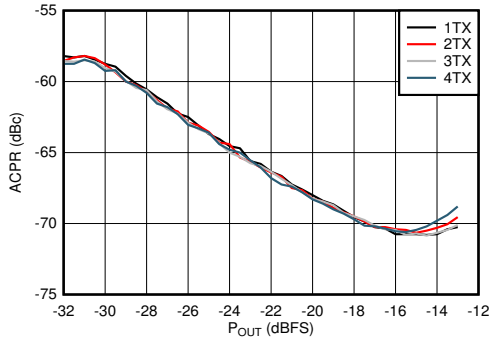

3.5 GHz Matching, single carrier 20-MHz BW TM1.1 LTE

图 5-456. TX 20-MHz LTE ACPR vs Digital Level at 3.5 GHz

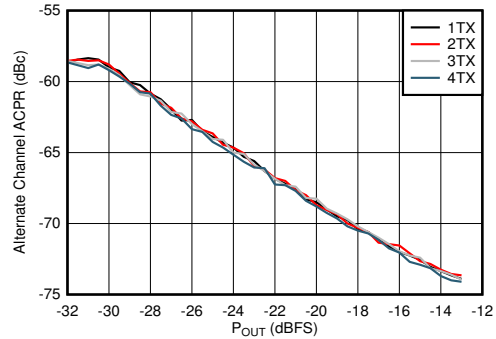

3.5 GHz Matching, single carrier 20-MHz BW TM1.1 LTE

图 5-457. TX 20-MHz LTE alt-ACPR vs Digital Level at 3.5 GHz

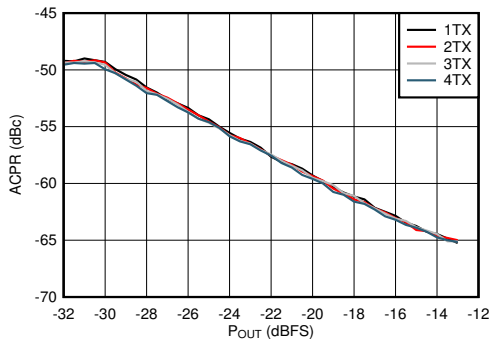

3.5 GHz Matching, single carrier 100-MHz BW NR TM1.1

图 5-458. TX 100-MHz NR ACPR vs Digital Level at 3.5 GHz

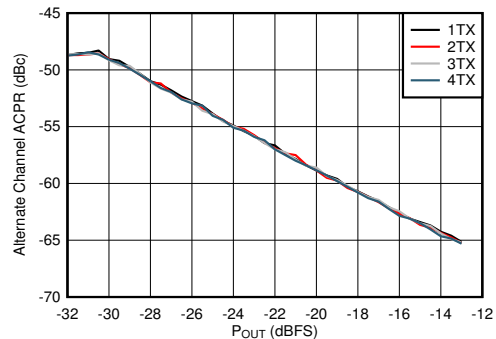

3.5 GHz Matching, single carrier 100-MHz BW NR TM1.1

图 5-459. TX 100-MHz NR alt-ACPR vs Digital Level at 3.5 GHz

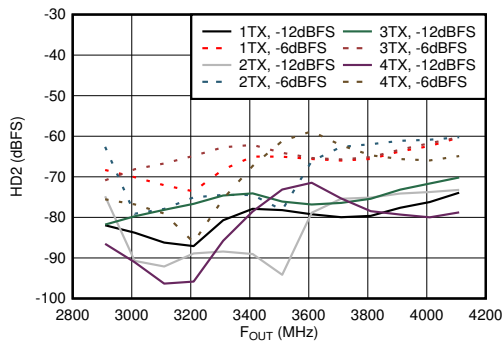

Matching at 3.5 GHz, $f_{\text{DAC}} = 11.79648\text{GSPS}$, interleave mode, normalized to output power at harmonic frequency

图 5-460. TX Single Tone HD2 vs Frequency and Digital Level at 3.5 GHz

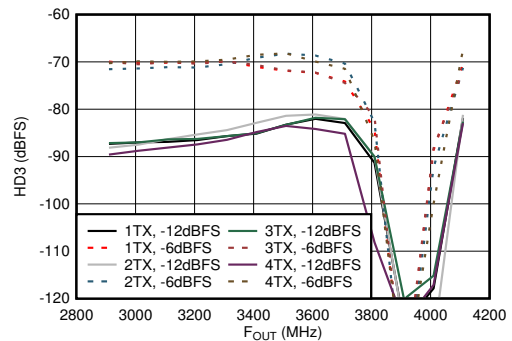

Matching at 3.5 GHz, $f_{\text{DAC}} = 11.79648\text{GSPS}$, interleave mode, normalized to output power at harmonic frequency. Dip is due to HD3 falling near DC.

图 5-461. TX Single Tone HD3 vs Frequency and Digital Level at 3.5 GHz

5.12.11 TX Typical Characteristics at 3.5GHz (continued)

Typical values at $T_A = +25^\circ\text{C}$ with nominal supplies. Unless otherwise noted, TX input data rate = 491.52MSPS, $f_{\text{DAC}} = 11796.48\text{MSPS}$, interleave mode, $A_{\text{OUT}} = -1\text{ dBFS}$, 1st Nyquist zone output, Internal PLL, $f_{\text{REF}} = 491.52\text{MSPS}$, 24x Interpolation, DSA = 0 dB, Sin(x)/x enabled, DSA calibrated.

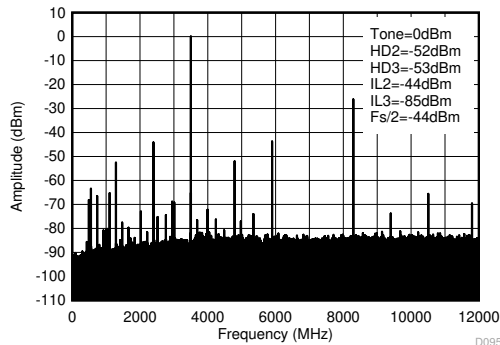

Matching at 3.5 GHz, $f_{\text{DAC}} = 11.79648\text{GSPS}$, interleave mode.

图 5-462. TX Single Tone (-1 dBFS) Output Spectrum at 3.5 GHz (0 - f_{DAC})

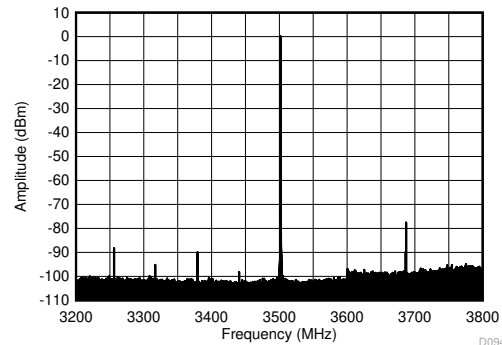

Matching at 3.5 GHz, $f_{\text{DAC}} = 11.79648\text{GSPS}$, interleave mode.

图 5-463. TX Single Tone (-1 dBFS) Output Spectrum at 3.5 GHz ($\pm 300\text{ MHz}$)

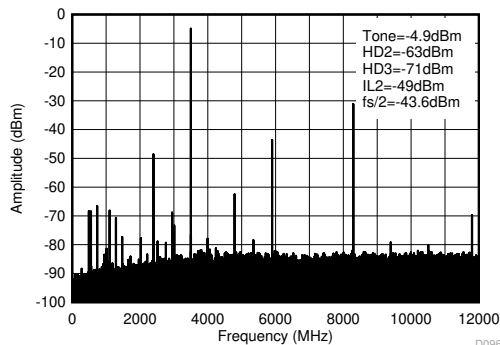

Matching at 3.5 GHz, $f_{\text{DAC}} = 11.79648\text{GSPS}$, interleave mode.

图 5-464. TX Single Tone (-6 dBFS) Output Spectrum at 3.5 GHz (0- f_{DAC})

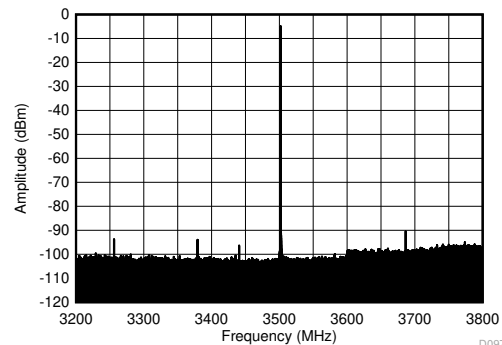

Matching at 3.5 GHz, $f_{\text{DAC}} = 11.79648\text{GSPS}$, interleave mode.

图 5-465. TX Single Tone (-6 dBFS) Output Spectrum at 3.5 GHz ($\pm 300\text{ MHz}$)

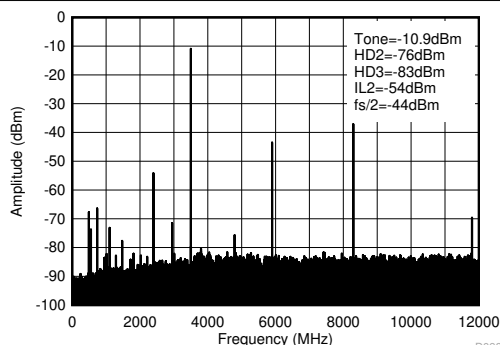

Matching at 3.5 GHz, $f_{\text{DAC}} = 11.79648\text{GSPS}$, interleave mode.

图 5-466. TX Single Tone (-12 dBFS) Output Spectrum at 3.5 GHz (0- f_{DAC})

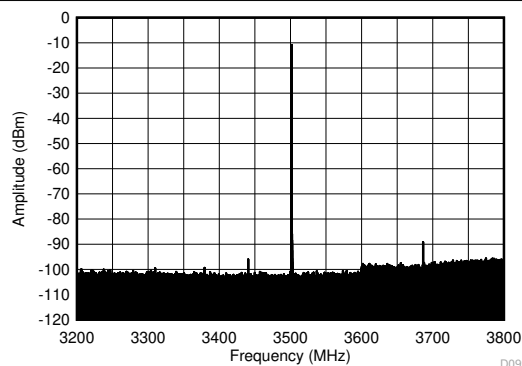

Matching at 3.5 GHz, $f_{\text{DAC}} = 11.79648\text{GSPS}$, interleave mode.

图 5-467. TX Single Tone (-12 dBFS) Output Spectrum at 3.5 GHz ($\pm 300\text{ MHz}$)

5.12.11 TX Typical Characteristics at 3.5GHz (continued)

Typical values at $T_A = +25^\circ\text{C}$ with nominal supplies. Unless otherwise noted, TX input data rate = 491.52MSPS, $f_{\text{DAC}} = 11796.48\text{MSPS}$, interleave mode, $A_{\text{OUT}} = -1\text{ dBFS}$, 1st Nyquist zone output, Internal PLL, $f_{\text{REF}} = 491.52\text{MSPS}$, 24x Interpolation, DSA = 0 dB, Sin(x)/x enabled, DSA calibrated.

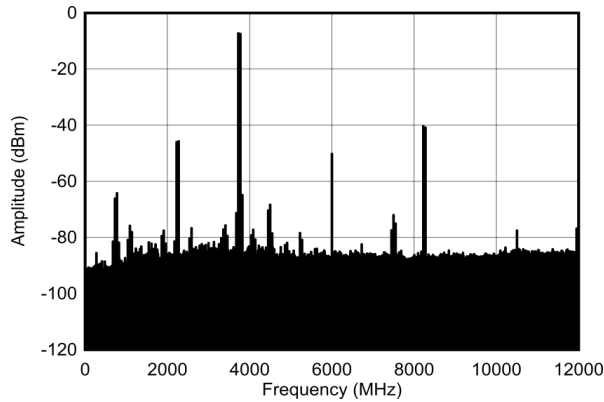

Matching at 3.5 GHz, 50MHz tone spacing, $f_{\text{DAC}} = 12\text{GSPS}$, non-interleave mode.

图 5-468. TX Dual Tone Output Spectrum at 3.75 GHz, -7dBFS each (0 - f_{DAC})

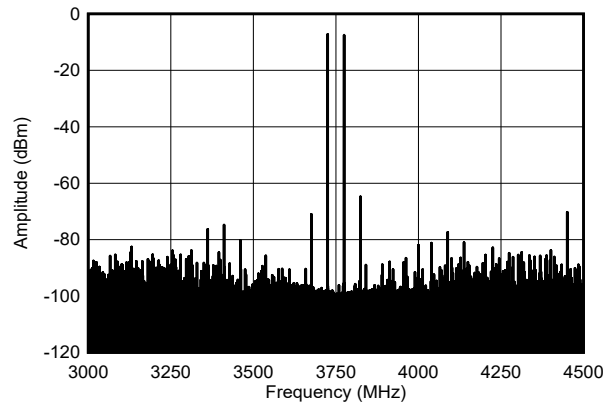

Matching at 3.5 GHz, 50MHz tone spacing, $f_{\text{DAC}} = 12\text{GSPS}$, non-interleave mode.

图 5-469. TX Dual Tone Output Spectrum at 3.75 GHz, -7dBFS each ($\pm 600\text{ MHz}$)

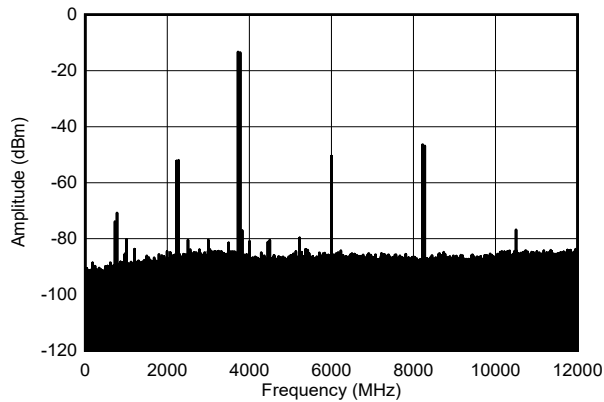

Matching at 3.5 GHz, 50MHz tone spacing, $f_{\text{DAC}} = 12\text{GSPS}$, non-interleave mode.

图 5-470. TX Dual Tone Output Spectrum at 3.75 GHz, -13dBFS each (0 - f_{DAC})

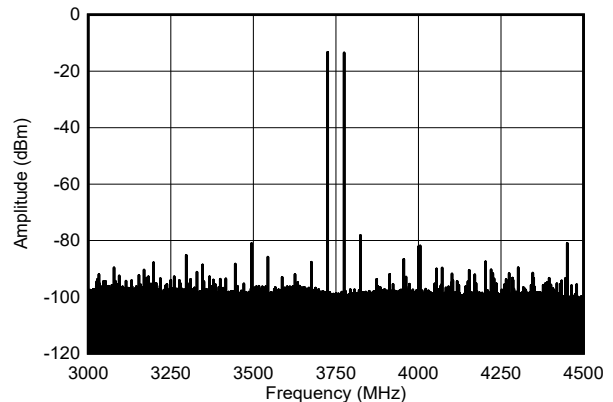

Matching at 3.5 GHz, 50MHz tone spacing, $f_{\text{DAC}} = 12\text{GSPS}$, non-interleave mode.

图 5-471. TX Dual Tone Output Spectrum at 3.75 GHz, -13dBFS each ($\pm 600\text{ MHz}$)

5.12.11 TX Typical Characteristics at 3.5GHz (continued)

Typical values at $T_A = +25^\circ\text{C}$ with nominal supplies. Unless otherwise noted, TX input data rate = 491.52MSPS, $f_{\text{DAC}} = 11796.48\text{MSPS}$, interleave mode, $A_{\text{OUT}} = -1\text{ dBFS}$, 1st Nyquist zone output, Internal PLL, $f_{\text{REF}} = 491.52\text{MSPS}$, 24x Interpolation, DSA = 0 dB, Sin(x)/x enabled, DSA calibrated.

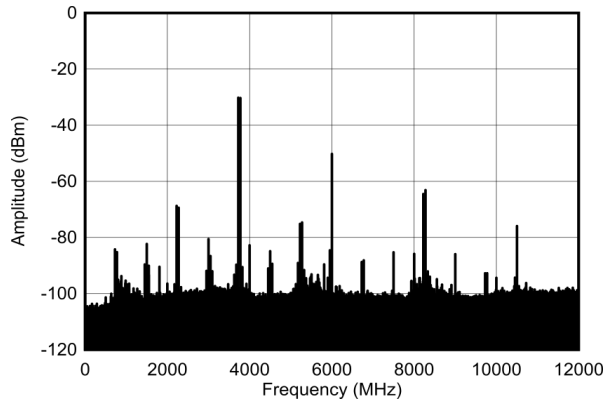

Matching at 3.5 GHz, 50MHz tone spacing, $f_{\text{DAC}} = 12\text{GSPS}$, non-interleave mode.

图 5-472. TX Dual Tone Output Spectrum at 3.75 GHz, -30dBFS each ($0 - f_{\text{DAC}}$)

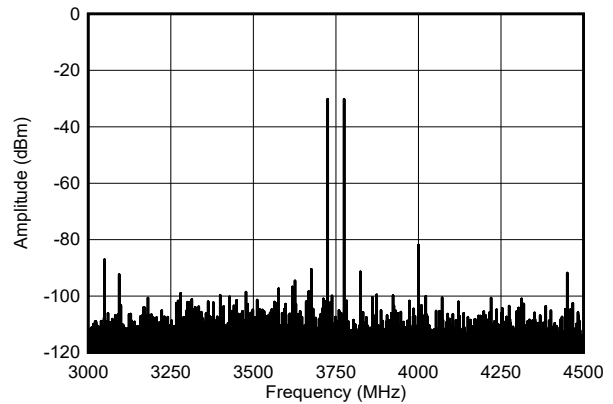

Matching at 3.5 GHz, 50MHz tone spacing, $f_{\text{DAC}} = 12\text{GSPS}$, non-interleave mode.

图 5-473. TX Dual Tone Output Spectrum at 3.75 GHz, -30dBFS each ($\pm 600\text{ MHz}$)

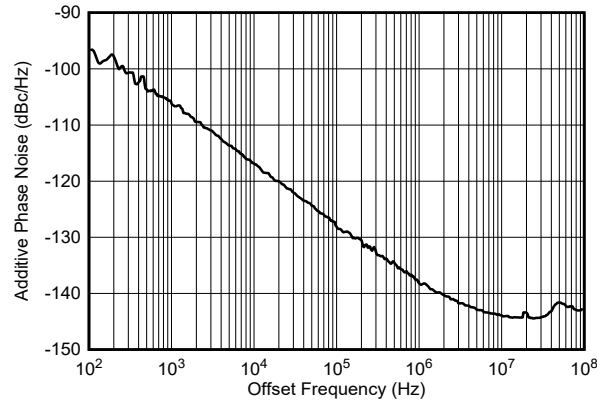

$f_{\text{DAC}} = f_{\text{CLK}} = 12\text{GSPS}$, non-interleave mode.

图 5-474. External Clock Additive Phase Noise at 3.7GHz

5.12.12 TX Typical Characteristics at 4.9GHz

Typical values at $T_A = +25^\circ\text{C}$ with nominal supplies. Unless otherwise noted, TX input data rate = 491.52MSPS, $f_{\text{DAC}} = 11796.48\text{MSPS}$, interleave mode, $A_{\text{OUT}} = -1 \text{ dBFS}$, 1st Nyquist zone output, Internal PLL, $f_{\text{REF}} = 491.52\text{MSPS}$, 24x Interpolation, DSA = 0 dB, Sin(x)/x enabled, DSA calibrated.

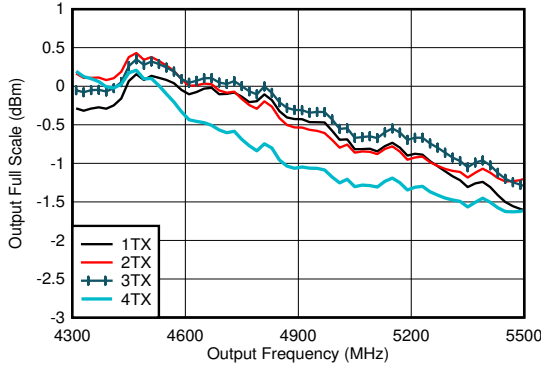

Excluding PCB and cable losses, $A_{\text{out}} = -0.5\text{dBFS}$, DSA = 0, 4.9 GHz matching

图 5-475. TX Full Scale vs RF Frequency and Channel at 11796.48MSPS

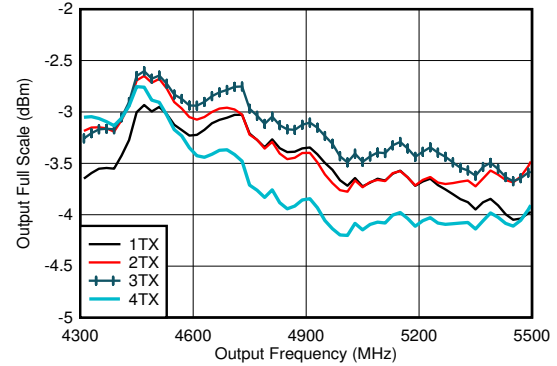

Excluding PCB and cable losses, $A_{\text{out}} = -0.5\text{dBFS}$, DSA = 0, 4.9 GHz matching

图 5-476. TX Full Scale vs RF Frequency and Channel at 5898.24MSPS, Mix Mode, 2nd Nyquist Zone

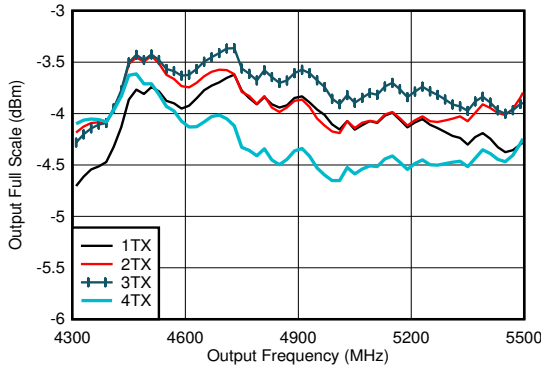

Excluding PCB and cable losses, $A_{\text{out}} = -0.5\text{dBFS}$, DSA = 0, 4.9 GHz matching

图 5-477. TX Full Scale vs RF Frequency and Channel at 8847.36MSPS, Mix Mode, 2nd Nyquist Zone

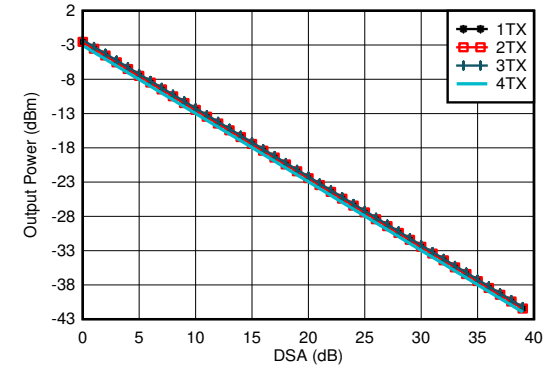

$f_{\text{DAC}} = 11796.48 \text{ MSPS}$, $A_{\text{out}} = -0.5\text{dBFS}$, matching 4.9 GHz

图 5-478. TX Output Power vs DSA Setting and Channel at 4.9 GHz

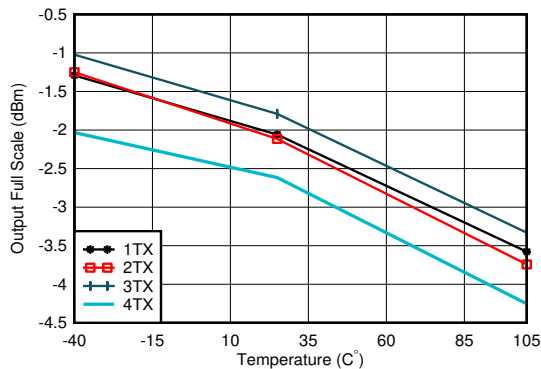

$A_{\text{out}} = -0.5\text{dBFS}$, 4.9 GHz Matching, PCB and cable losses included.

图 5-479. TX Full Scale Output Power vs Temperature and Channel at 4.9 GHz

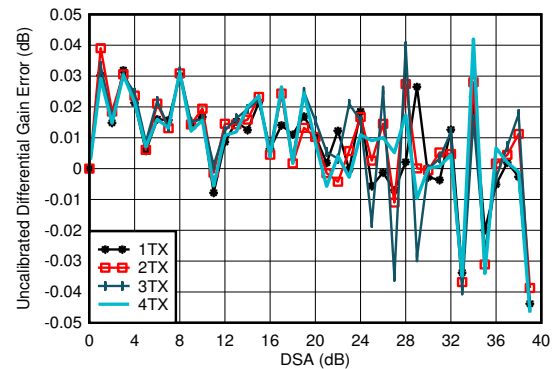

$f_{\text{DAC}} = 11796.48\text{MSPS}$, interleave mode, matching at 4.9 GHz
Differential Gain Error = $P_{\text{OUT}}(\text{DSA Setting} - 1) - P_{\text{OUT}}(\text{DSA Setting}) + 1$

图 5-480. TX Uncalibrated Differential Gain Error vs DSA Setting and Channel at 4.9 GHz

5.12.12 TX Typical Characteristics at 4.9GHz (continued)

Typical values at $T_A = +25^\circ\text{C}$ with nominal supplies. Unless otherwise noted, TX input data rate = 491.52MSPS, $f_{\text{DAC}} = 11796.48\text{MSPS}$, interleave mode, $A_{\text{OUT}} = -1\text{ dBFS}$, 1st Nyquist zone output, Internal PLL, $f_{\text{REF}} = 491.52\text{MSPS}$, 24x Interpolation, DSA = 0 dB, $\text{Sin}(x)/x$ enabled, DSA calibrated.

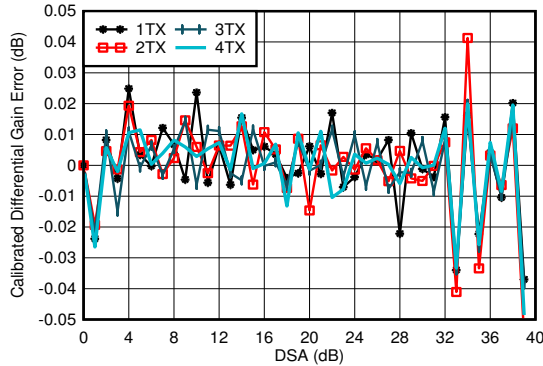

$f_{\text{DAC}}=11796.48\text{MSPS}$, interleave mode, matching at 4.9 GHz
 Differential Gain Error = $P_{\text{OUT}}(\text{DSA Setting} - 1) - P_{\text{OUT}}(\text{DSA Setting}) + 1$

图 5-481. TX Calibrated Differential Gain Error vs DSA Setting and Channel at 4.9 GHz

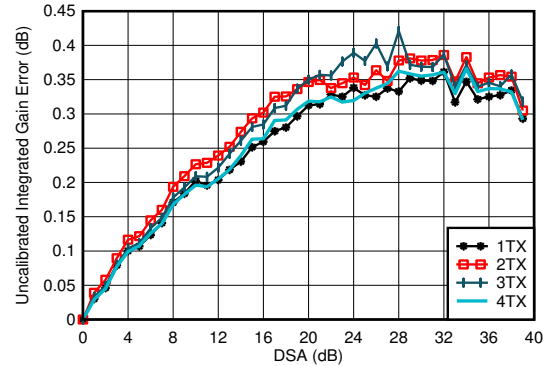

$f_{\text{DAC}}=11796.48\text{MSPS}$, interleave mode, matching at 4.9 GHz
 Integrated Gain Error = $P_{\text{OUT}}(\text{DSA Setting}) - P_{\text{OUT}}(\text{DSA Setting} = 0) + (\text{DSA Setting})$

图 5-482. TX Uncalibrated Integrated Gain Error vs DSA Setting and Channel at 4.9 GHz

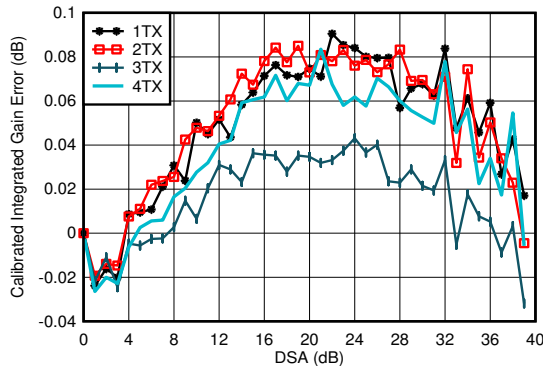

$f_{\text{DAC}} = 11796.48\text{MSPS}$, interleave mode, matching at 4.9 GHz
 Integrated Gain Error = $P_{\text{OUT}}(\text{DSA Setting}) - P_{\text{OUT}}(\text{DSA Setting} = 0) + (\text{DSA Setting})$

图 5-483. TX Calibrated Integrated Gain Error vs DSA Setting and Channel at 4.9 GHz

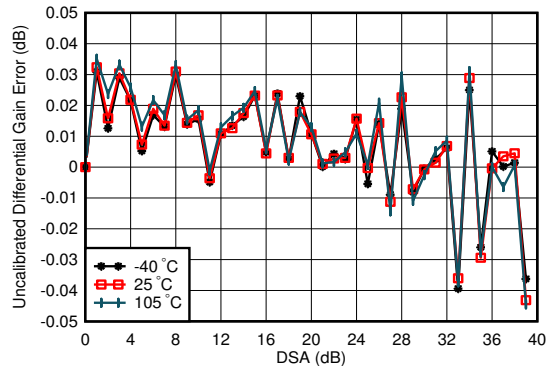

$f_{\text{DAC}} = 11796.48\text{MSPS}$, interleaved mode, matching at 4.9 GHz
 Differential Gain Error = $P_{\text{OUT}}(\text{DSA Setting} - 1) - P_{\text{OUT}}(\text{DSA Setting}) + 1$

图 5-484. TX Uncalibrated Differential Gain Error vs DSA Setting and Temperature at 4.9 GHz

5.12.12 TX Typical Characteristics at 4.9GHz (continued)

Typical values at $T_A = +25^\circ\text{C}$ with nominal supplies. Unless otherwise noted, TX input data rate = 491.52MSPS, $f_{\text{DAC}} = 11796.48\text{MSPS}$, interleaved mode, $A_{\text{OUT}} = -1\text{ dBFS}$, 1st Nyquist zone output, Internal PLL, $f_{\text{REF}} = 491.52\text{MSPS}$, 24x Interpolation, DSA = 0 dB, Sin(x)/x enabled, DSA calibrated.

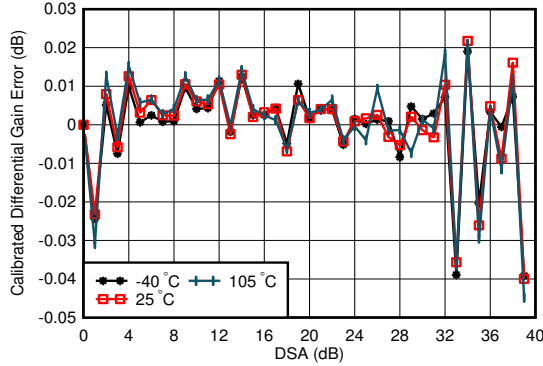

$f_{\text{DAC}} = 11796.48\text{MSPS}$, interleaved mode, matching at 4.9 GHz
 Differential Gain Error = $P_{\text{OUT}}(\text{DSA Setting} - 1) - P_{\text{OUT}}(\text{DSA Setting}) + 1$

图 5-485. TX Calibrated Differential Gain Error vs DSA Setting and Temperature at 4.9 GHz

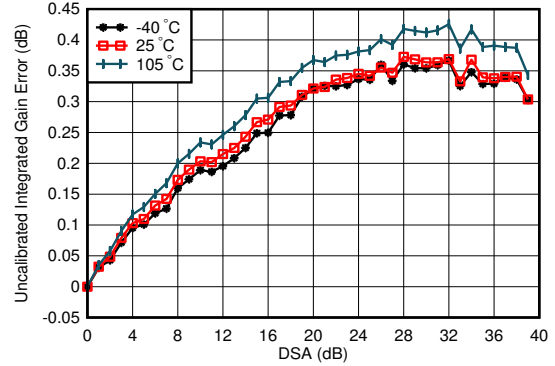

$f_{\text{DAC}} = 11796.48\text{MSPS}$, interleaved mode, matching at 4.9 GHz
 Integrated Gain Error = $P_{\text{OUT}}(\text{DSA Setting}) - P_{\text{OUT}}(\text{DSA Setting} = 0) + (\text{DSA Setting})$

图 5-486. TX Uncalibrated Integrated Gain Error vs DSA Setting and Temperature at 4.9 GHz

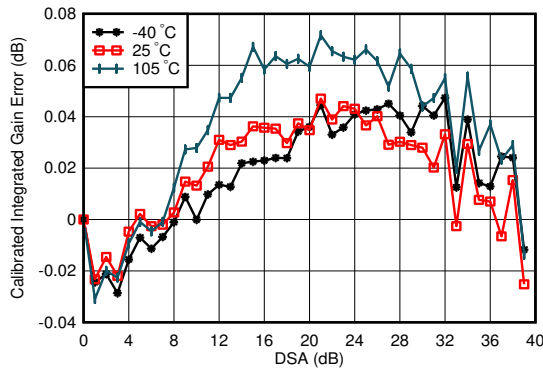

$f_{\text{DAC}} = 11796.48\text{MSPS}$, interleaved mode, matching at 4.9 GHz
 Integrated Gain Error = $P_{\text{OUT}}(\text{DSA Setting}) - P_{\text{OUT}}(\text{DSA Setting} = 0) + (\text{DSA Setting})$

图 5-487. TX Calibrated Integrated Gain Error vs DSA Setting and Temperature at 4.9 GHz

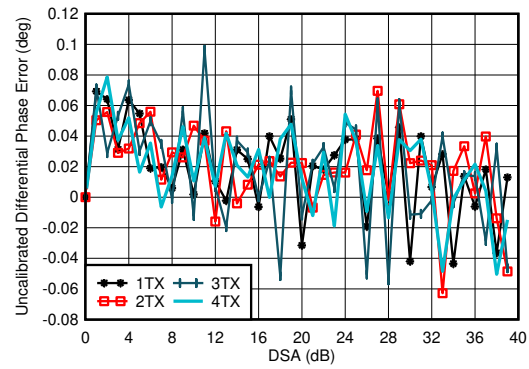

$f_{\text{DAC}} = 11796.48\text{MSPS}$, interleaved mode, matching at 4.9 GHz
 Differential Phase Error = $\text{Phase}_{\text{OUT}}(\text{DSA Setting} - 1) - \text{Phase}_{\text{OUT}}(\text{DSA Setting})$

图 5-488. TX Uncalibrated Differential Phase Error vs DSA Setting and Channel at 4.9 GHz

5.12.12 TX Typical Characteristics at 4.9GHz (continued)

Typical values at $T_A = +25^\circ\text{C}$ with nominal supplies. Unless otherwise noted, TX input data rate = 491.52MSPS, $f_{\text{DAC}} = 11796.48\text{MSPS}$, interleaved mode, $A_{\text{OUT}} = -1\text{ dBFS}$, 1st Nyquist zone output, Internal PLL, $f_{\text{REF}} = 491.52\text{MSPS}$, 24x Interpolation, DSA = 0 dB, Sin(x)/x enabled, DSA calibrated.

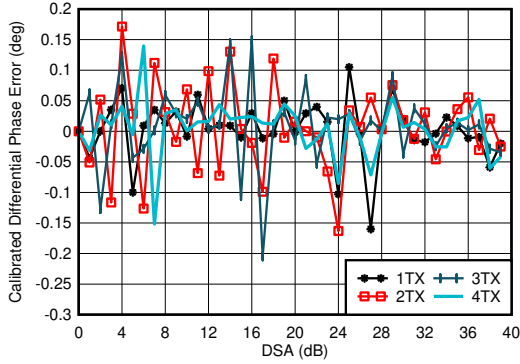

$f_{\text{DAC}} = 11796.48\text{MSPS}$, interleaved mode, matching at 4.9 GHz
 Differential Phase Error = $\text{Phase}_{\text{OUT}}(\text{DSA Setting} - 1) - \text{Phase}_{\text{OUT}}(\text{DSA Setting})$
 Phase DNL spike may occur at any DSA setting.

图 5-489. TX Calibrated Differential Phase Error vs DSA Setting and Channel at 4.9 GHz

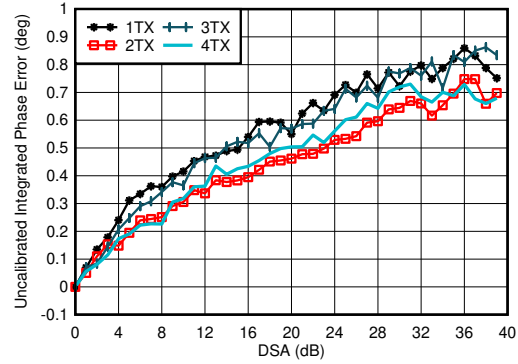

$f_{\text{DAC}} = 11796.48\text{MSPS}$, interleaved mode, matching at 4.9 GHz
 Integrated Phase Error = $\text{Phase}(\text{DSA Setting}) - \text{Phase}(\text{DSA Setting} = 0)$

图 5-490. TX Uncalibrated Integrated Phase Error vs DSA Setting and Channel at 4.9 GHz

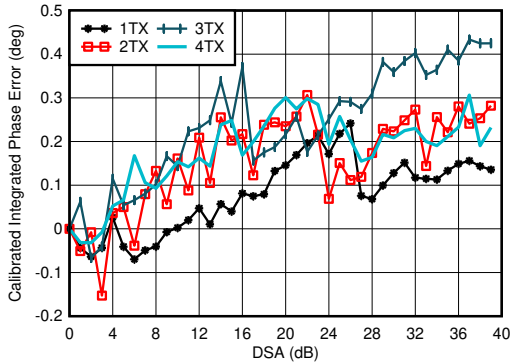

$f_{\text{DAC}} = 11796.48\text{MSPS}$, interleaved mode, matching at 4.9 GHz
 Integrated Phase Error = $\text{Phase}(\text{DSA Setting}) - \text{Phase}(\text{DSA Setting} = 0)$

图 5-491. TX Calibrated Integrated Phase Error vs DSA Setting and Channel at 4.9 GHz

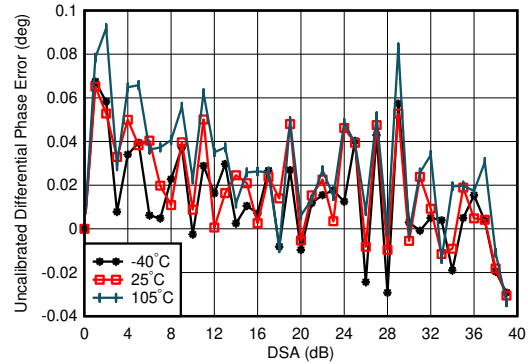

$f_{\text{DAC}} = 11796.48\text{MSPS}$, interleaved mode, matching at 4.9 GHz
 Differential Phase Error = $\text{Phase}_{\text{OUT}}(\text{DSA Setting} - 1) - \text{Phase}_{\text{OUT}}(\text{DSA Setting})$

图 5-492. TX Uncalibrated Differential Phase Error vs DSA Setting and Temperature at 4.9 GHz

5.12.12 TX Typical Characteristics at 4.9GHz (continued)

Typical values at $T_A = +25^\circ\text{C}$ with nominal supplies. Unless otherwise noted, TX input data rate = 491.52MSPS, $f_{\text{DAC}} = 11796.48\text{MSPS}$, interleaved mode, $A_{\text{OUT}} = -1\text{ dBFS}$, 1st Nyquist zone output, Internal PLL, $f_{\text{REF}} = 491.52\text{MSPS}$, 24x Interpolation, DSA = 0 dB, Sin(x)/x enabled, DSA calibrated.

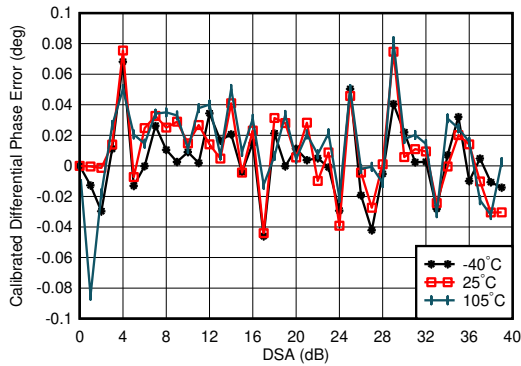

$f_{\text{DAC}} = 11796.48\text{MSPS}$, interleaved mode, matching at 4.9 GHz
Differential Phase Error = $\text{Phase}_{\text{OUT}}(\text{DSA Setting} - 1) - \text{Phase}_{\text{OUT}}(\text{DSA Setting})$

图 5-493. TX Calibrated Differential Phase Error vs DSA Setting and Temperature at 4.9 GHz

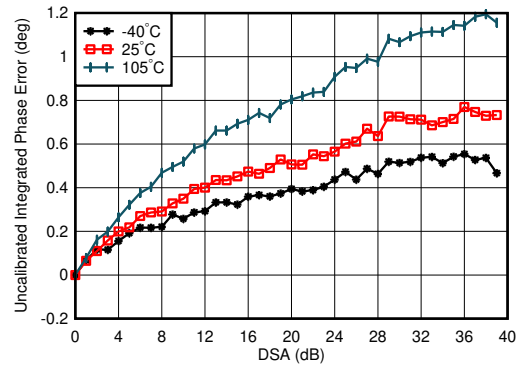

$f_{\text{DAC}} = 11796.48\text{MSPS}$, interleaved mode, matching at 4.9 GHz
Integrated Phase Error = $\text{Phase}(\text{DSA Setting}) - \text{Phase}(\text{DSA Setting} = 0)$

图 5-494. TX Uncalibrated Integrated Phase Error vs DSA Setting and Temperature at 4.9 GHz

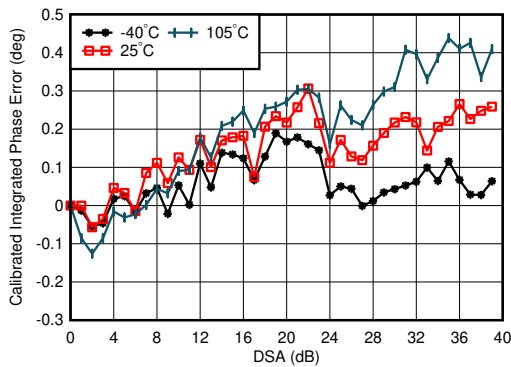

$f_{\text{DAC}} = 11796.48\text{MSPS}$, interleaved mode, matching at 4.9 GHz
Integrated Phase Error = $\text{Phase}(\text{DSA Setting}) - \text{Phase}(\text{DSA Setting} = 0)$

图 5-495. TX Calibrated Integrated Phase Error vs DSA Setting and Temperature at 4.9 GHz

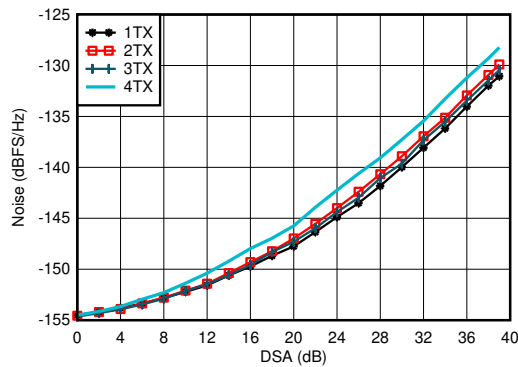

$f_{\text{DAC}} = 11796.48\text{MSPS}$, interleaved mode, matching at 4.9 GHz, $P_{\text{OUT}} = -13\text{ dBFS}$

图 5-496. TX Output Noise vs Channel and Attenuation at 4.9 GHz

5.12.12 TX Typical Characteristics at 4.9GHz (continued)

Typical values at $T_A = +25^\circ\text{C}$ with nominal supplies. Unless otherwise noted, TX input data rate = 491.52MSPS, $f_{\text{DAC}} = 11796.48\text{MSPS}$, interleave mode, $A_{\text{OUT}} = -1\text{ dBFS}$, 1st Nyquist zone output, Internal PLL, $f_{\text{REF}} = 491.52\text{MSPS}$, 24x Interpolation, DSA = 0 dB, Sin(x)/x enabled, DSA calibrated.

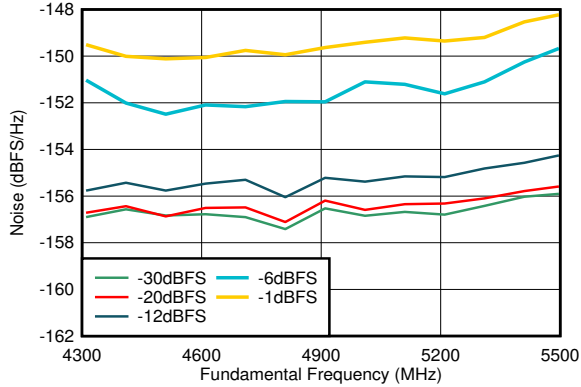

$f_{\text{DAC}} = 11796.48\text{MSPS}$, interleave mode, matching at 4.9GHz,
 $A_{\text{out}} = -13\text{ dBFS}$.

图 5-497. TX NSD vs Output Frequency and Digital Amplitude at 4.9 GHz (DSA=0dB)

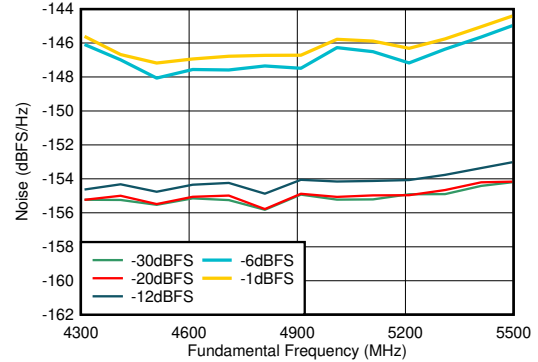

$f_{\text{DAC}} = 11796.48\text{MSPS}$, interleave mode, matching at 4.9GHz,
 $A_{\text{out}} = -13\text{ dBFS}$.

图 5-498. TX NSD vs Output Frequency and Digital Amplitude at 4.9GHz (DSA=6dB)

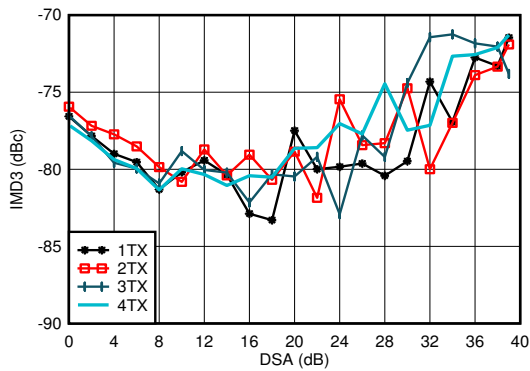

$f_{\text{DAC}} = 11796.48\text{MSPS}$, interleaved mode, matching at 4.9 GHz,
 $f_{\text{CENTER}} = 4.9\text{GHz}$, -13 dBFS each tone

图 5-499. TX IMD3 vs DSA Setting at 4.9 GHz

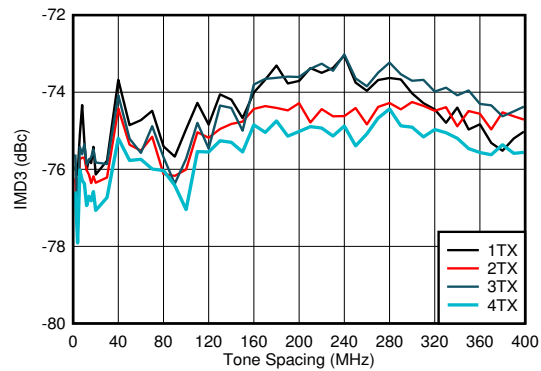

$f_{\text{DAC}} = 11796.48\text{MSPS}$, interleaved mode, matching at 4.9 GHz,
 $f_{\text{CENTER}} = 4.9\text{GHz}$, -13 dBFS each tone

图 5-500. TX IMD3 vs Tone Spacing and Channel at 4.9 GHz

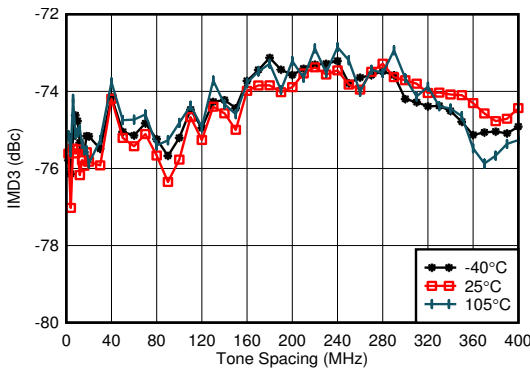

$f_{\text{DAC}} = 11796.48\text{MSPS}$, interleaved mode, matching at 4.9 GHz,
 $f_{\text{CENTER}} = 4.9\text{GHz}$, -13 dBFS each tone, worst channel

图 5-501. TX IMD3 vs Tone Spacing and Temperature at 4.9 GHz

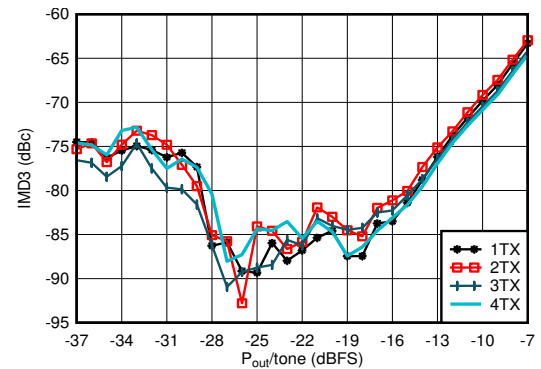

$f_{\text{DAC}} = 11796.48\text{MSPS}$, interleaved mode, matching at 4.9 GHz,
 $f_{\text{CENTER}} = 4.9\text{GHz}$, $f_{\text{SPACING}} = 20\text{ MHz}$

图 5-502. TX IMD3 vs Digital Level at 4.9 GHz

5.12.12 TX Typical Characteristics at 4.9GHz (continued)

Typical values at $T_A = +25^\circ\text{C}$ with nominal supplies. Unless otherwise noted, TX input data rate = 491.52MSPS, $f_{\text{DAC}} = 11796.48\text{MSPS}$, interleave mode, $A_{\text{OUT}} = -1\text{ dBFS}$, 1st Nyquist zone output, Internal PLL, $f_{\text{REF}} = 491.52\text{MSPS}$, 24x Interpolation, DSA = 0 dB, Sin(x)/x enabled, DSA calibrated.

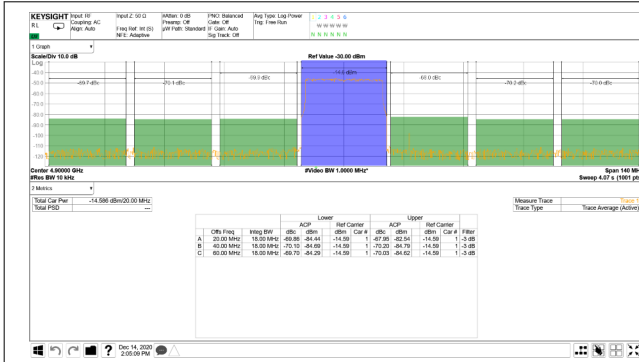

TM1.1, $P_{\text{OUT_RMS}} = -13\text{ dBFS}$

图 5-503. TX 20-MHz LTE Output Spectrum at 4.9 GHz

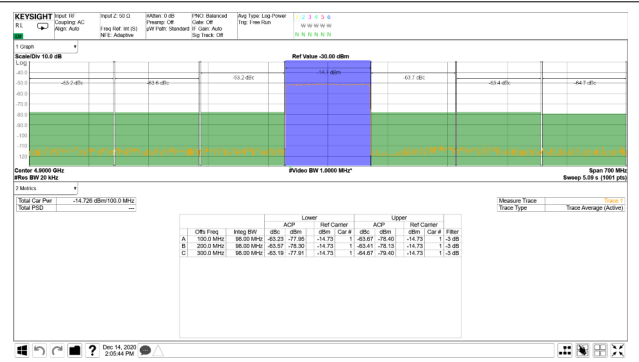

TM1.1, $P_{\text{OUT_RMS}} = -13\text{ dBFS}$

图 5-504. TX 100-MHz NR Output Spectrum at 4.9 GHz

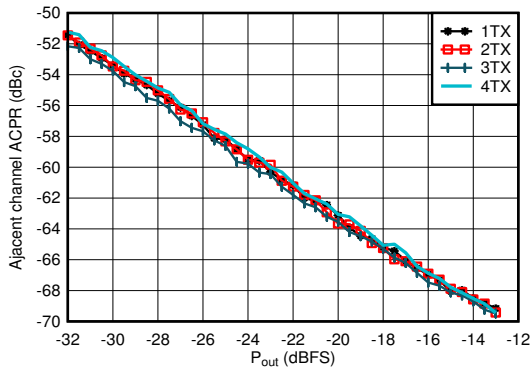

Matching at 4.9 GHz, single carrier 20-MHz BW TM1.1 LTE

图 5-505. TX 20-MHz LTE ACPR vs Digital Level at 4.9 GHz

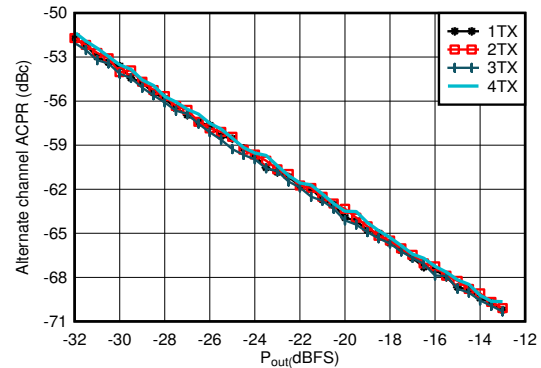

Matching at 4.9 GHz, single carrier 20-MHz BW TM1.1 LTE

图 5-506. TX 20-MHz LTE alt-ACPR vs Digital Level at 4.9 GHz

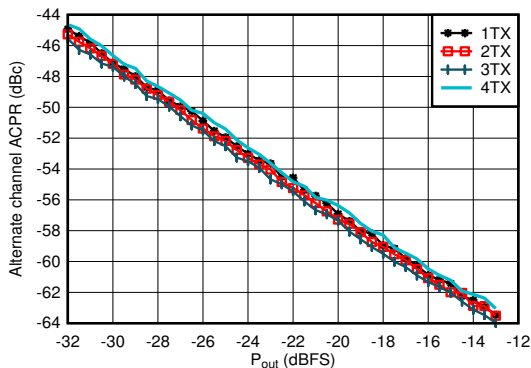

Matching at 4.9 GHz, single carrier 100-MHz BW TM1.1 NR

图 5-507. TX 100-MHz NR ACPR vs Digital Level at 4.9 GHz

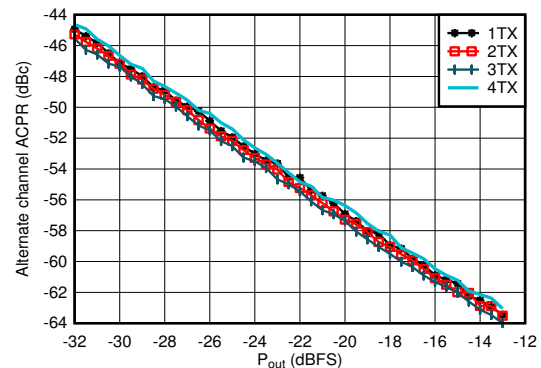

Matching at 4.9 GHz, single carrier 100-MHz BW TM1.1 NR

图 5-508. TX 100-MHz NR alt-ACPR vs Digital Level at 4.9 GHz

5.12.12 TX Typical Characteristics at 4.9GHz (continued)

Typical values at $T_A = +25^\circ\text{C}$ with nominal supplies. Unless otherwise noted, TX input data rate = 491.52MSPS, $f_{\text{DAC}} = 11796.48\text{MSPS}$, interleave mode, $A_{\text{OUT}} = -1\text{ dBFS}$, 1st Nyquist zone output, Internal PLL, $f_{\text{REF}} = 491.52\text{MSPS}$, 24x Interpolation, DSA = 0 dB, Sin(x)/x enabled, DSA calibrated.

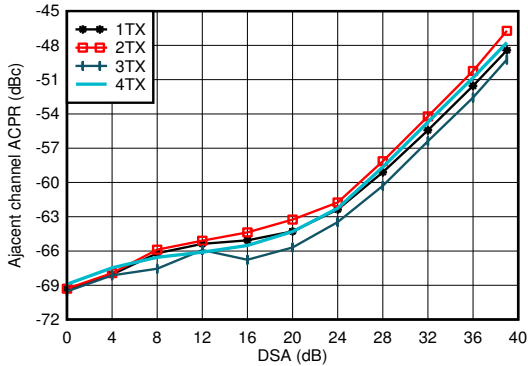

Matching at 4.9 GHz, single carrier 20-MHz BW TM1.1 LTE

图 5-509. TX 20-MHz LTE ACPR vs DSA at 4.9 GHz

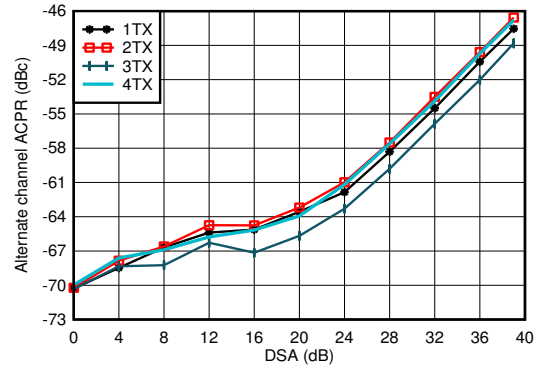

Matching at 4.9 GHz, single carrier 20-MHz BW TM1.1 LTE

图 5-510. TX 20-MHz LTE alt-ACPR vs DSA at 4.9 GHz

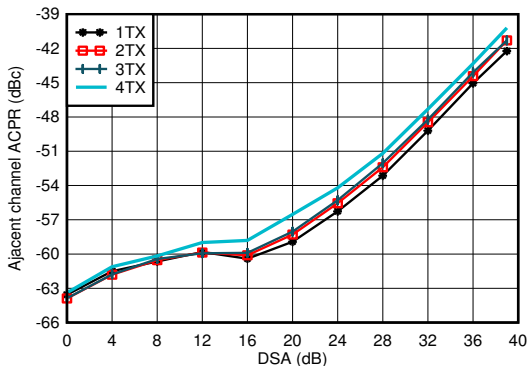

Matching at 4.9 GHz, single carrier 100-MHz BW TM1.1 NR

图 5-511. TX 100-MHz NR ACPR vs DSA at 4.9 GHz

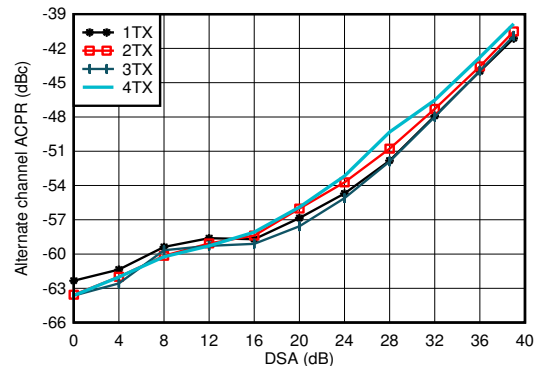

Matching at 4.9 GHz, single carrier 100-MHz BW TM1.1 NR

图 5-512. TX 100-MHz NR alt-ACPR vs DSA at 4.9 GHz

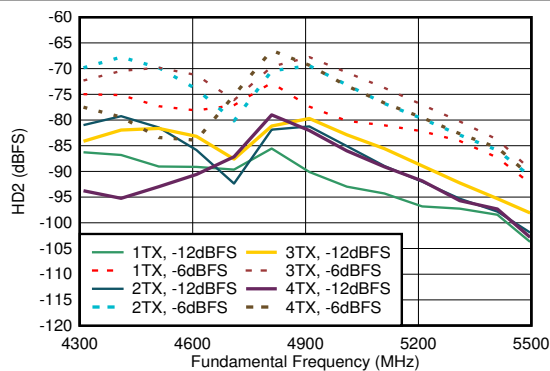

Matching at 4.9 GHz, $f_{\text{DAC}} = 11.79648\text{GSPPS}$, interleave mode, normalized to output power at harmonic frequency

图 5-513. TX HD2 vs Digital Amplitude and Output Frequency at 4.9 GHz

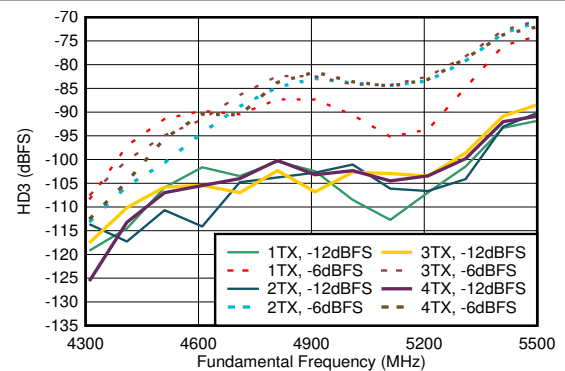

Matching at 4.9 GHz, $f_{\text{DAC}} = 11.79648\text{GSPPS}$, interleave mode, normalized to output power at harmonic frequency

图 5-514. TX HD3 vs Digital Amplitude and Output Frequency at 4.9 GHz

5.12.12 TX Typical Characteristics at 4.9GHz (continued)

Typical values at $T_A = +25^\circ\text{C}$ with nominal supplies. Unless otherwise noted, TX input data rate = 491.52MSPS, $f_{DAC} = 11796.48\text{MSPS}$, interleave mode, $A_{OUT} = -1\text{ dBFS}$, 1st Nyquist zone output, Internal PLL, $f_{REF} = 491.52\text{MSPS}$, 24x Interpolation, DSA = 0 dB, Sin(x)/x enabled, DSA calibrated.

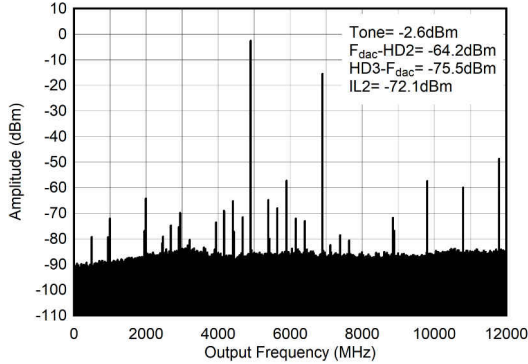

$f_{DAC} = 11796.48\text{MSPS}$, interleave mode, 4.9 GHz matching, includes PCB and cable losses. $IL_n = f_s/n \pm f_{OUT}$.

图 5-515. TX Single Tone (- 1 dBFS) Output Spectrum at 4.9 GHz (0- f_{DAC})

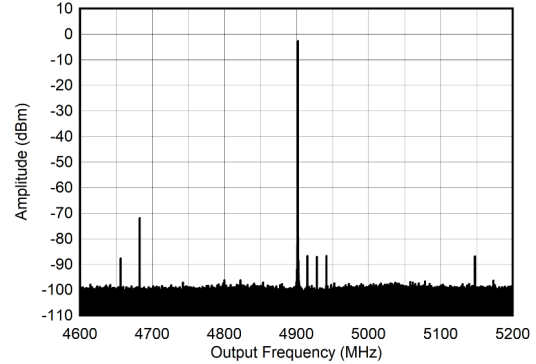

$f_{DAC} = 11796.48\text{MSPS}$, interleave mode, 4.9 GHz matching, includes PCB and cable losses

图 5-516. TX Single Tone (- 1 dBFS) Output Spectrum at 4.9 GHz ($\pm 300\text{ MHz}$)

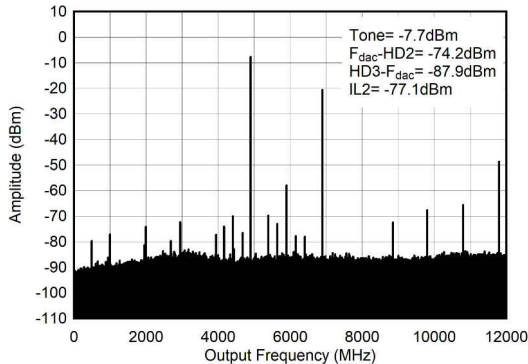

$f_{DAC} = 11796.48\text{MSPS}$, interleave mode, 4.9 GHz matching, includes PCB and cable losses. $IL_n = f_s/n \pm f_{OUT}$.

图 5-517. TX Single Tone (- 6 dBFS) Output Spectrum at 4.9 GHz (0- f_{DAC})

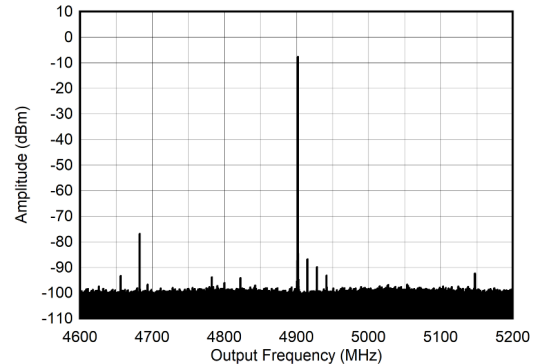

$f_{DAC} = 11796.48\text{MSPS}$, interleave mode, 4.9 GHz matching, includes PCB and cable losses

图 5-518. TX Single Tone (- 6 dBFS) Output Spectrum at 4.9 GHz ($\pm 300\text{ MHz}$)

5.12.12 TX Typical Characteristics at 4.9GHz (continued)

Typical values at $T_A = +25^\circ\text{C}$ with nominal supplies. Unless otherwise noted, TX input data rate = 491.52MSPS, $f_{\text{DAC}} = 11796.48\text{MSPS}$, interleave mode, $A_{\text{OUT}} = -1 \text{ dBFS}$, 1st Nyquist zone output, Internal PLL, $f_{\text{REF}} = 491.52\text{MSPS}$, 24x Interpolation, DSA = 0 dB, $\text{Sin}(x)/x$ enabled, DSA calibrated.

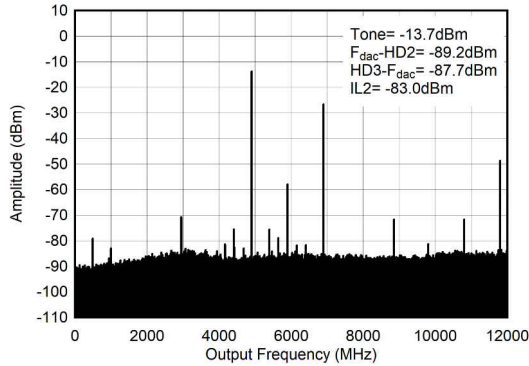

$f_{\text{DAC}} = 11796.48\text{MSPS}$, interleave mode, 4.9 GHz matching, includes PCB and cable losses. $\text{IL}_n = f_s/n \pm f_{\text{OUT}}$.

图 5-519. TX Single Tone (-12 dBFS) Output Spectrum at 4.9 GHz (0- f_{DAC})

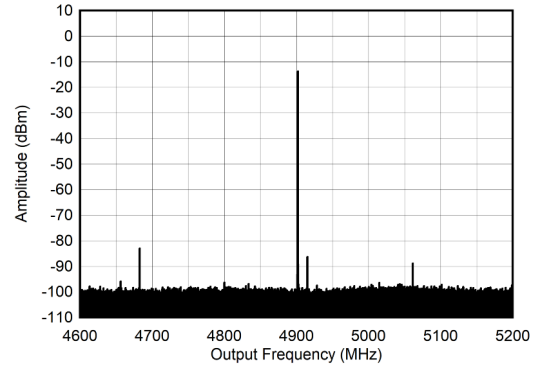

$f_{\text{DAC}} = 11796.48\text{MSPS}$, interleave mode, 4.9 GHz matching, includes PCB and cable losses

图 5-520. TX Single Tone (-12 dBFS) Output Spectrum at 4.9 GHz ($\pm 300 \text{ MHz}$)

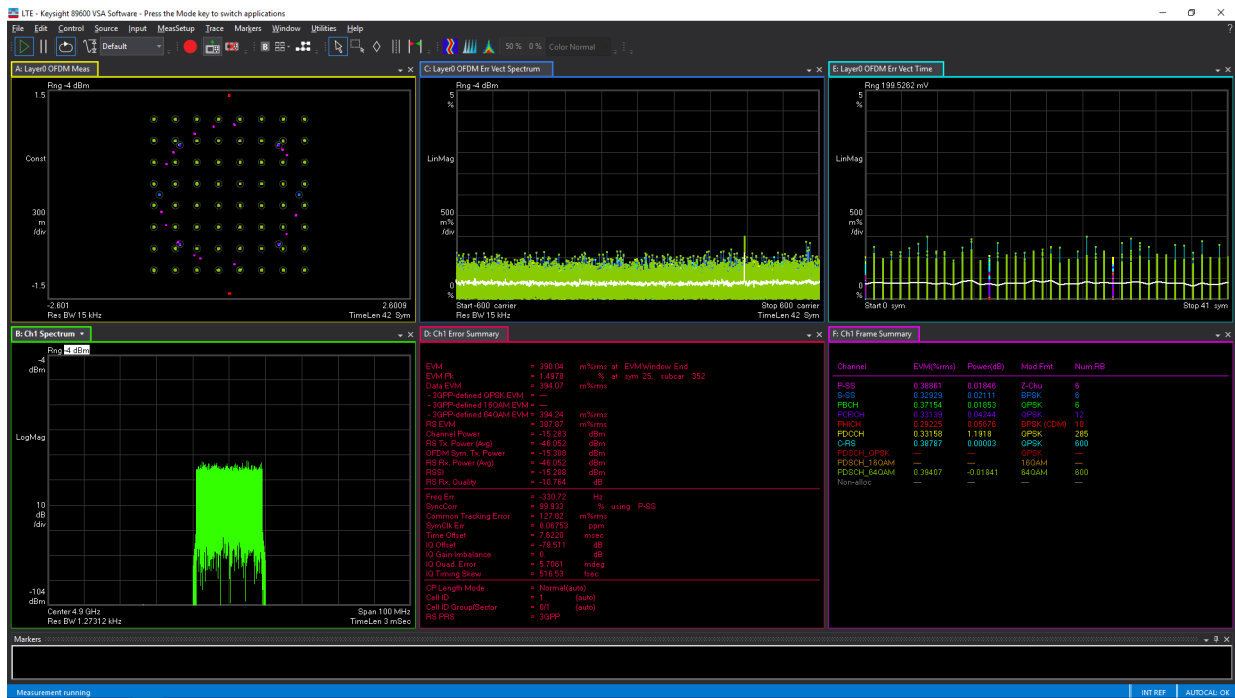

TM1.1, $P_{\text{OUT_RMS}} = -13 \text{ dBFS}$

图 5-521. TX 20-MHz LTE Error Vector Magnitude at 4.9 GHz

5.12.13 TX Typical Characteristics at 7.1GHz

Typical values at $T_A = +25^\circ\text{C}$ with nominal supplies. Unless otherwise noted, TX input data rate = 750MSPS, $f_{\text{DAC}} = 9000\text{MSPS}$, non-interleave mode, $A_{\text{OUT}} = -1 \text{ dBFS}$, 2nd Nyquist zone output, External clock mode, 12x Interpolation, DSA = 0 dB, Sin(x)/x enabled, DSA calibrated, TX Clock Dither Enabled, 7.1GHz matching.

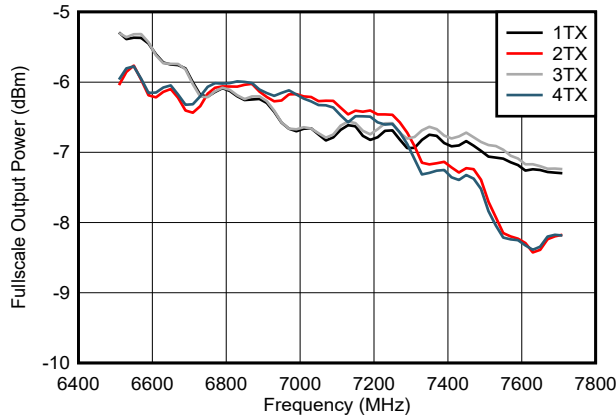

Excluding PCB and cable losses

图 5-522. TX Full Scale vs RF Frequency and Channel

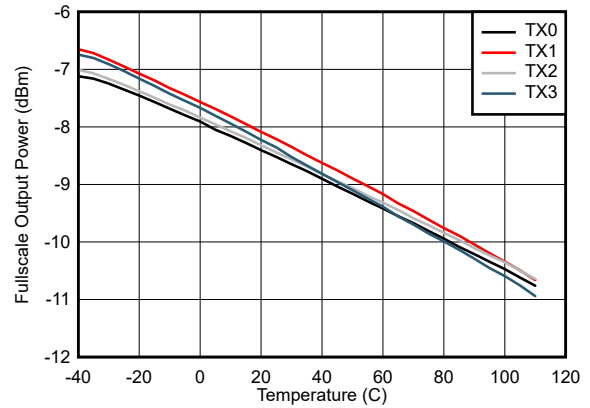

Excluding PCB and cable losses

图 5-523. TX Full Scale vs Temperature and Channel at 7.1GHz

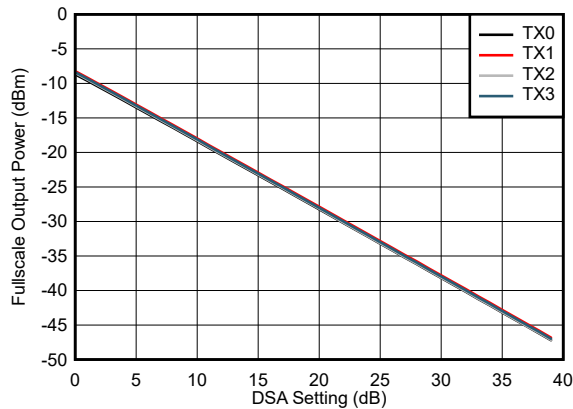

Excluding PCB and cable losses

图 5-524. TX Full Scale vs DSA Setting and Channel at 7.1 GHz

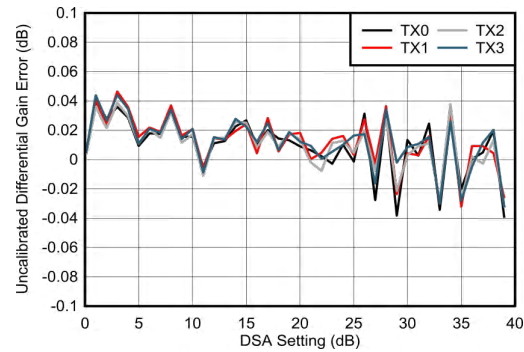

Differential Gain Error = Gain(DSA Setting - 1) - Gain(DSA Setting)

图 5-525. Uncalibrated Differential Gain Error vs Channel at 7.1 GHz

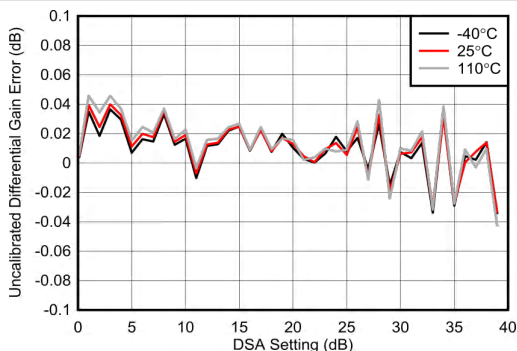

Differential Gain Error = Gain(DSA Setting - 1) - Gain(DSA Setting)

图 5-526. Uncalibrated Differential Gain Error vs Temperature at 7.1 GHz

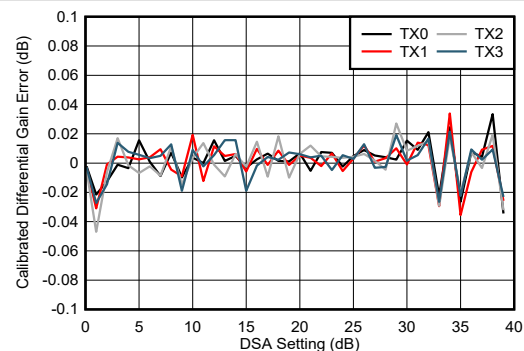

Differential Gain Error = Gain(DSA Setting - 1) - Gain(DSA Setting)

图 5-527. Calibrated Differential Gain Error vs Channel at 7.1 GHz

5.12.13 TX Typical Characteristics at 7.1GHz (continued)

Typical values at $T_A = +25^\circ\text{C}$ with nominal supplies. Unless otherwise noted, TX input data rate = 750MSPS, $f_{DAC} = 9000\text{MSPS}$, non-interleave mode, $A_{OUT} = -1\text{ dBFS}$, 2nd Nyquist zone output, External clock mode, 12x Interpolation, DSA = 0 dB, Sin(x)/x enabled, DSA calibrated, TX Clock Dither Enabled, 7.1GHz matching.

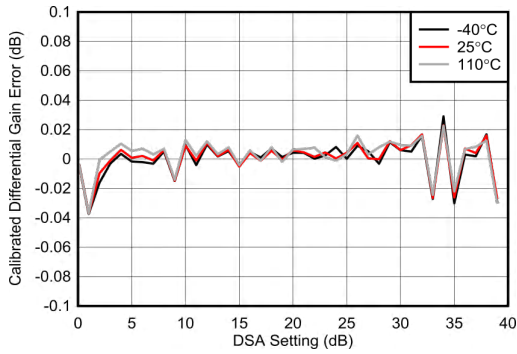

Differential Gain Error = Gain(DSA Setting - 1) - Gain(DSA Setting)

图 5-528. Calibrated Differential Gain Error vs Temperature at 7.1 GHz

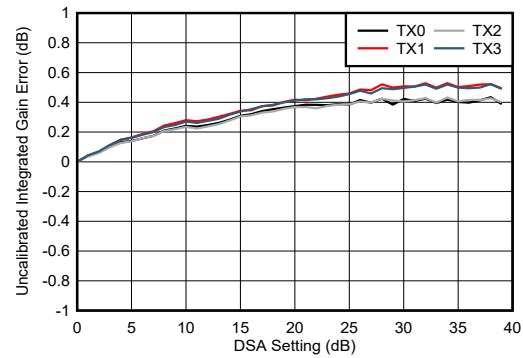

Integrated Gain Error = Gain(DSA Setting) - Gain(DSA Setting = 0).

图 5-529. Uncalibrated Integrated Gain Error vs Channel at 7.1 GHz

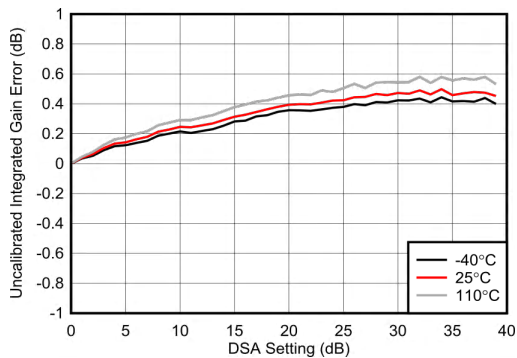

Integrated Gain Error = Gain(DSA Setting) - Gain(DSA Setting = 0).

图 5-530. Uncalibrated Integrated Gain Error vs Temperature at 7.1 GHz

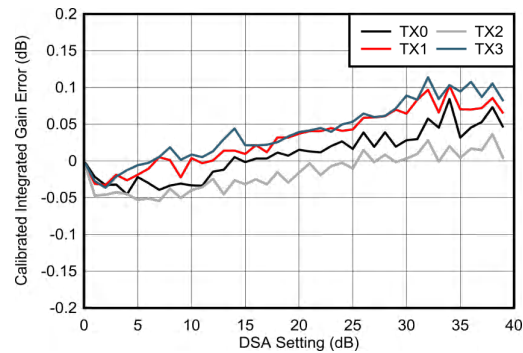

Integrated Gain Error = Gain(DSA Setting) - Gain(DSA Setting = 0).

图 5-531. Calibrated Integrated Gain Error vs Channel at 7.1 GHz

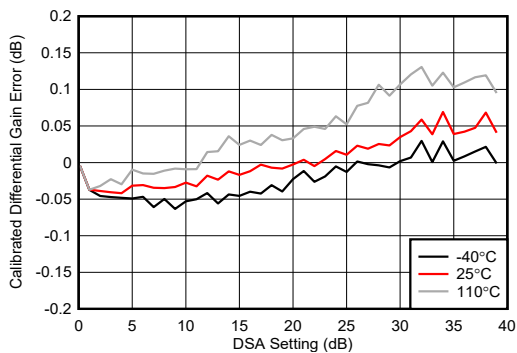

Integrated Gain Error = Gain(DSA Setting) - Gain(DSA Setting = 0).

图 5-532. Calibrated Integrated Gain Error vs Temperature at 7.1 GHz

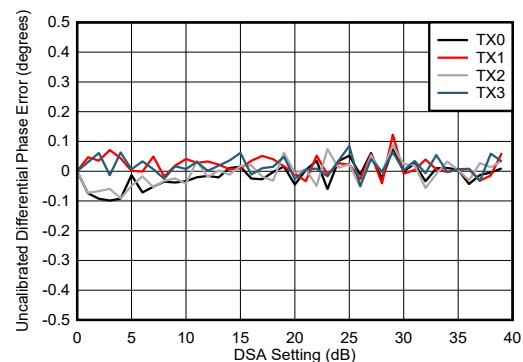

Differential Phase Error = Phase(DSA Setting - 1) - Phase(DSA Setting)

图 5-533. Uncalibrated Differential Phase Error vs Channel at 7.1 GHz

5.12.13 TX Typical Characteristics at 7.1GHz (continued)

Typical values at $T_A = +25^\circ\text{C}$ with nominal supplies. Unless otherwise noted, TX input data rate = 750MSPS, $f_{\text{DAC}} = 9000\text{MSPS}$, non-interleave mode, $A_{\text{OUT}} = -1\text{ dBFS}$, 2nd Nyquist zone output, External clock mode, 12x Interpolation, DSA = 0 dB, Sin(x)/x enabled, DSA calibrated, TX Clock Dither Enabled, 7.1GHz matching.

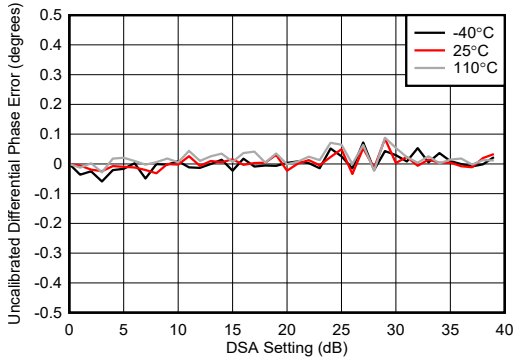

$$\text{Differential Phase Error} = \text{Phase}(\text{DSA Setting} - 1) - \text{Phase}(\text{DSA Setting})$$

图 5-534. Uncalibrated Differential Phase Error vs Temperature at 7.1 GHz

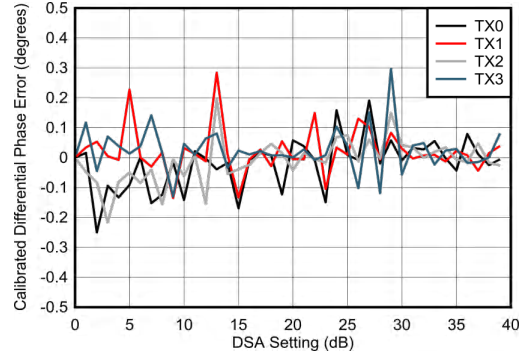

$$\text{Differential Phase Error} = \text{Phase}(\text{DSA Setting} - 1) - \text{Phase}(\text{DSA Setting})$$

图 5-535. Calibrated Differential Phase Error vs Channel at 7.1 GHz

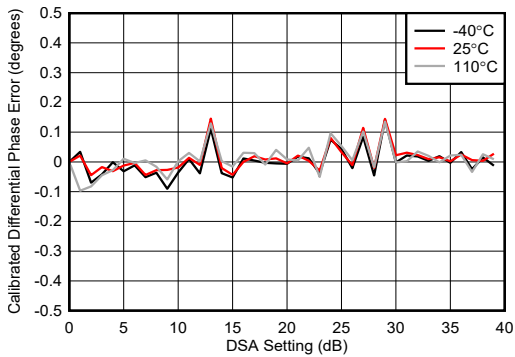

$$\text{Differential Phase Error} = \text{Phase}(\text{DSA Setting} - 1) - \text{Phase}(\text{DSA Setting})$$

图 5-536. Calibrated Differential Phase Error vs Temperature at 7.1 GHz

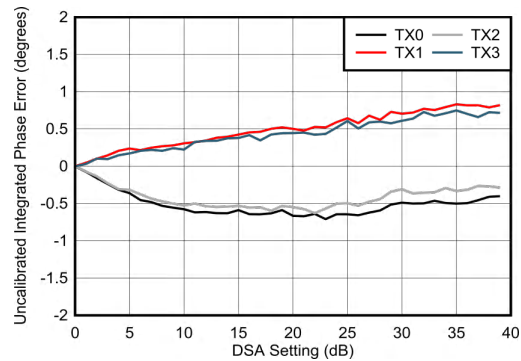

$$\text{Integrated Phase Error} = \text{Phase}(\text{DSA Setting}) - \text{Phase}(\text{DSA Setting} = 0)$$

图 5-537. Uncalibrated Integrated Phase Error vs Channel at 7.1 GHz

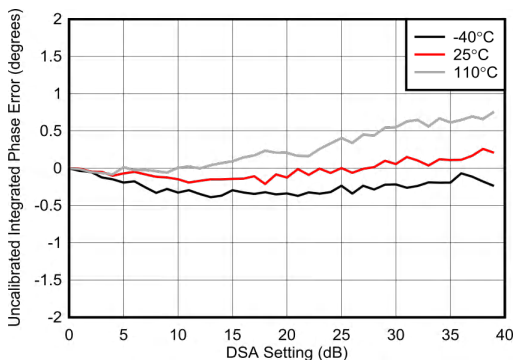

$$\text{Integrated Phase Error} = \text{Phase}(\text{DSA Setting}) - \text{Phase}(\text{DSA Setting} = 0)$$

图 5-538. Uncalibrated Integrated Phase Error vs Temperature at 7.1 GHz

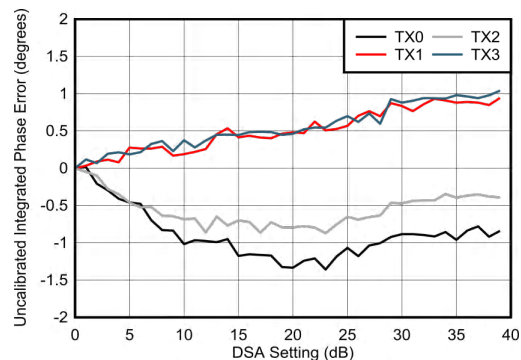

$$\text{Integrated Phase Error} = \text{Phase}(\text{DSA Setting}) - \text{Phase}(\text{DSA Setting} = 0)$$

图 5-539. Calibrated Integrated Phase Error vs Channel at 7.1 GHz

5.12.13 TX Typical Characteristics at 7.1GHz (continued)

Typical values at $T_A = +25^\circ\text{C}$ with nominal supplies. Unless otherwise noted, TX input data rate = 750MSPS, $f_{DAC} = 9000\text{MSPS}$, non-interleave mode, $A_{OUT} = -1\text{ dBFS}$, 2nd Nyquist zone output, External clock mode, 12x Interpolation, DSA = 0 dB, Sin(x)/x enabled, DSA calibrated, TX Clock Dither Enabled, 7.1GHz matching.

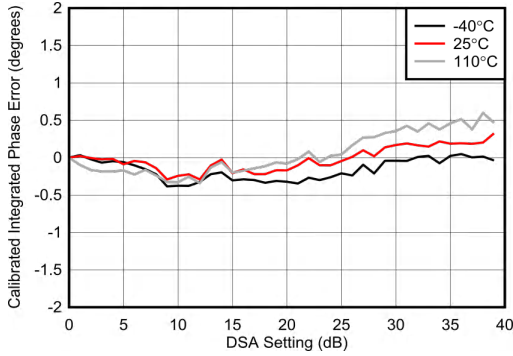

Integrated Phase Error = Phase(DSA Setting) - Phase(DSA Setting = 0)

图 5-540. Calibrated Integrated Phase Error vs Temperature at 7.1 GHz

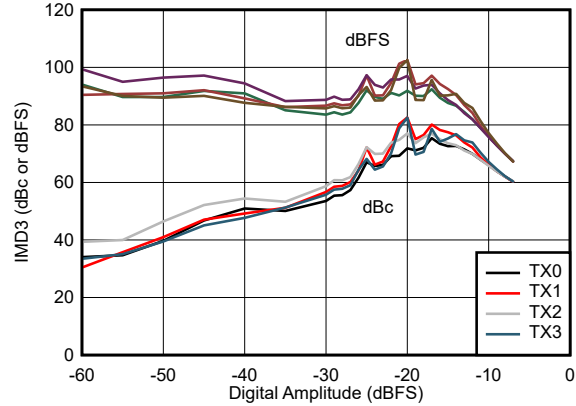

Tone spacing = 50MHz

图 5-541. IMD3 vs Digital Amplitude and Channel at 7.1 GHz

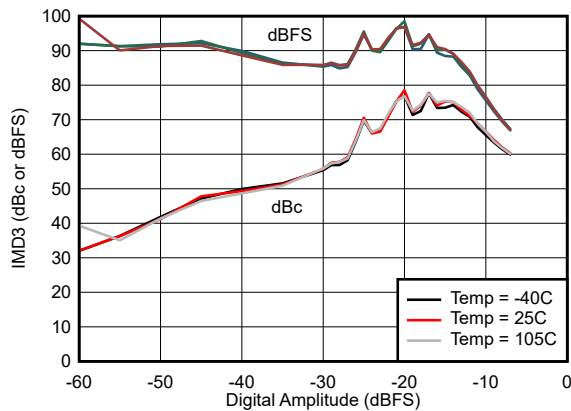

Tone spacing = 50MHz

图 5-542. IMD3 vs Digital Amplitude and Temperature at 7.1 GHz

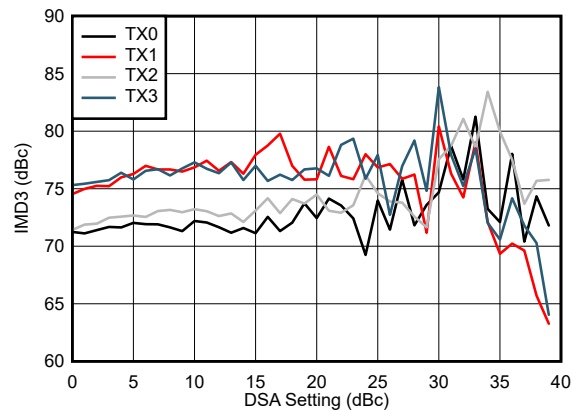

Tone spacing = 50MHz

图 5-543. IMD3 vs DSA Setting and Channel at 7.1 GHz

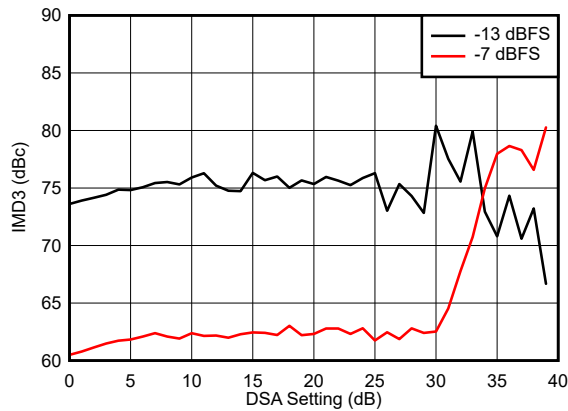

Tone spacing = 50MHz

图 5-544. IMD3 vs DSA Setting and Digital Amplitude at 7.1 GHz

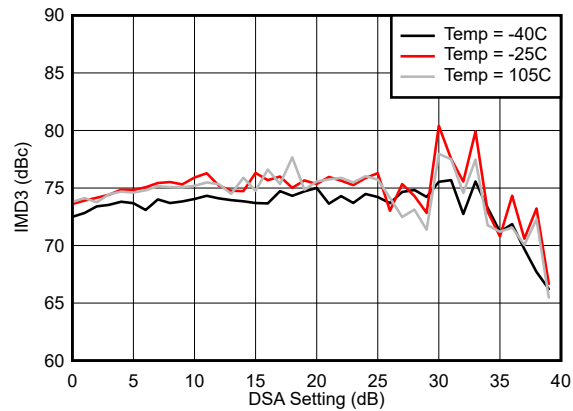

Tone spacing = 50MHz

图 5-545. IMD3 vs DSA Setting and Temperature at 7.1 GHz

5.12.13 TX Typical Characteristics at 7.1GHz (continued)

Typical values at $T_A = +25^\circ\text{C}$ with nominal supplies. Unless otherwise noted, TX input data rate = 750MSPS, $f_{\text{DAC}} = 9000\text{MSPS}$, non-interleave mode, $A_{\text{OUT}} = -1\text{ dBFS}$, 2nd Nyquist zone output, External clock mode, 12x Interpolation, DSA = 0 dB, Sin(x)/x enabled, DSA calibrated, TX Clock Dither Enabled, 7.1GHz matching.



图 5-546. IMD3 vs Tone Spacing and Channel at 7.1 GHz



图 5-547. IMD3 vs Tone Spacing and Digital Amplitude at 7.1 GHz

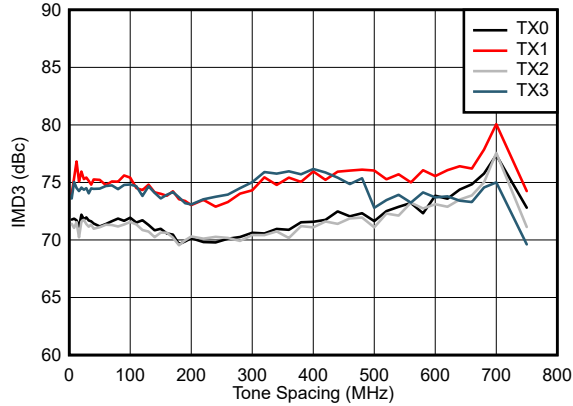

图 5-548. IMD3 vs Tone Spacing and Temperature at 7.1 GHz

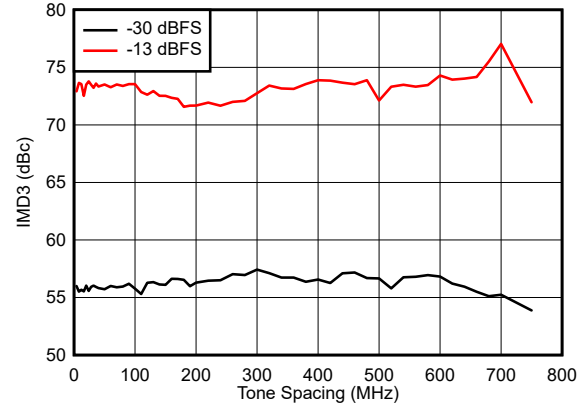

Tone at -12dBFS, 50MHz offset from tone

图 5-549. NSD vs DSA Setting and Channel at 7.1 GHz

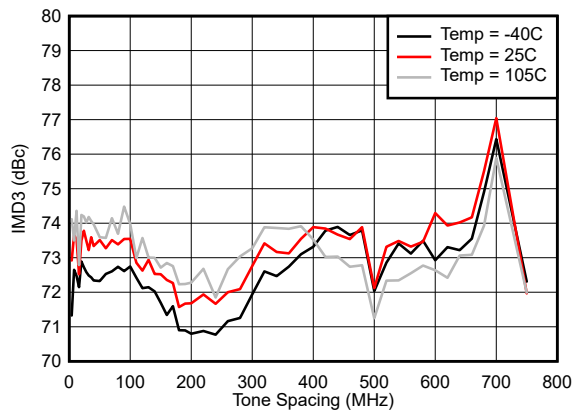
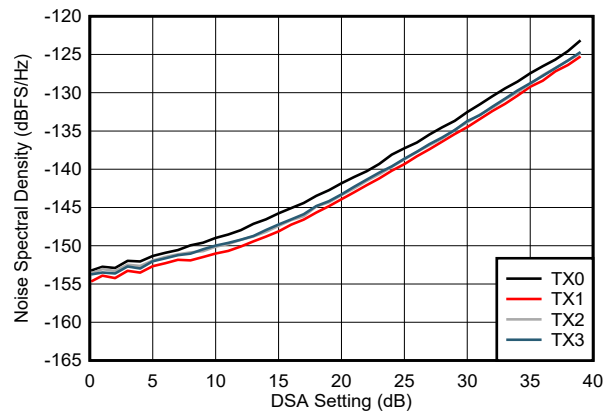
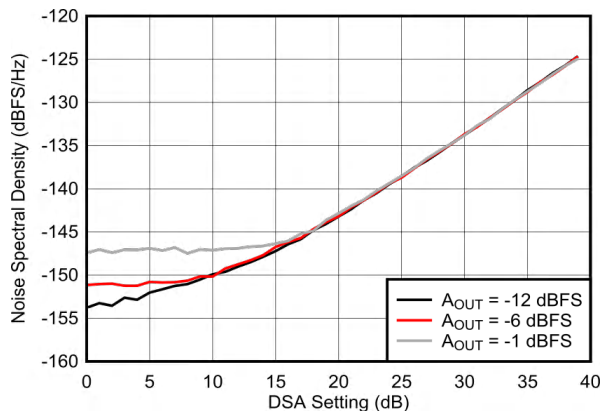

50MHz offset from tone

图 5-550. NSD vs DSA Setting and Amplitude at 7.1 GHz

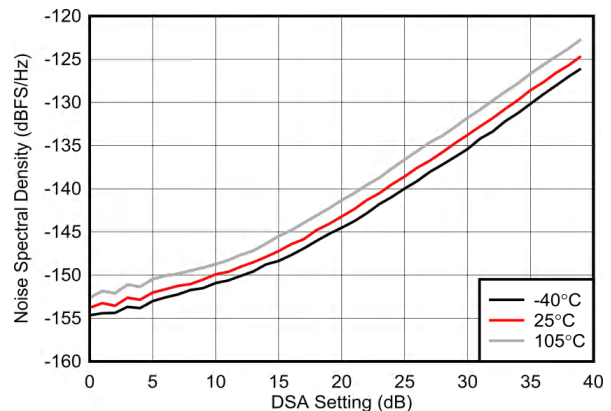

Tone at -12dBFS, 50MHz offset from tone

图 5-551. NSD vs DSA Setting and Temperature at 7.1 GHz

5.12.13 TX Typical Characteristics at 7.1GHz (continued)

Typical values at $T_A = +25^\circ\text{C}$ with nominal supplies. Unless otherwise noted, TX input data rate = 750MSPS, $f_{DAC} = 9000\text{MSPS}$, non-interleave mode, $A_{OUT} = -1\text{ dBFS}$, 2nd Nyquist zone output, External clock mode, 12x Interpolation, DSA = 0 dB, Sin(x)/x enabled, DSA calibrated, TX Clock Dither Enabled, 7.1GHz matching.

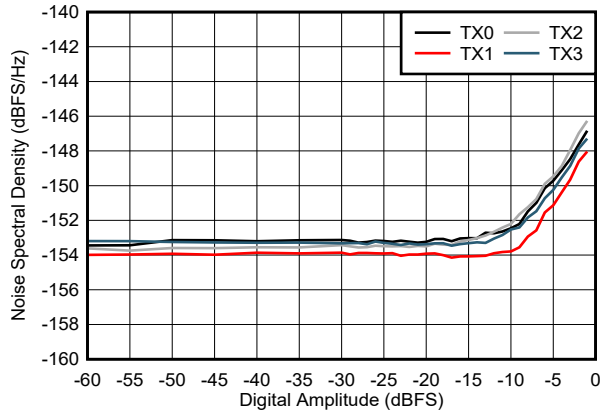

50MHz offset from tone

图 5-552. NSD vs Digital Amplitude and Channel at 7.1 GHz

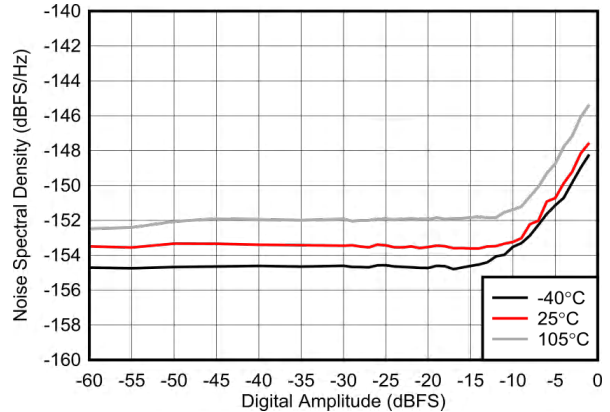

50MHz offset from tone

图 5-553. NSD vs Digital Amplitude and Temperature at 7.1 GHz

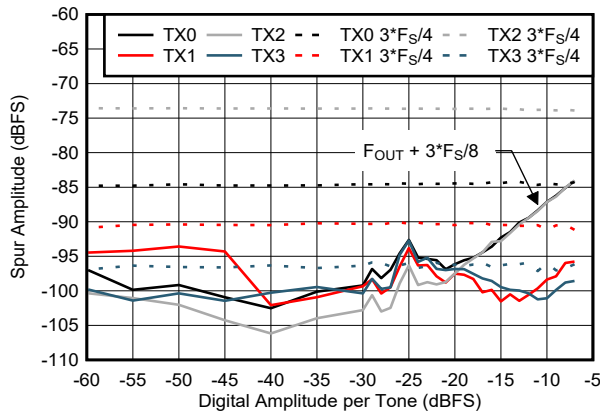

Inband = 7100MHz ± 600MHz, excluding IMD3 components, 3*Fs/4 spur not included and shown separately

图 5-554. Two Tone Inband SFDR vs Digital Amplitude at 7.1 GHz



图 5-555. Single Tone Output Spectrum at 7.1GHz, -1dBFS (Nyquist)



图 5-556. Single Tone Output Spectrum at 7.1GHz, -1dBFS (Inband)

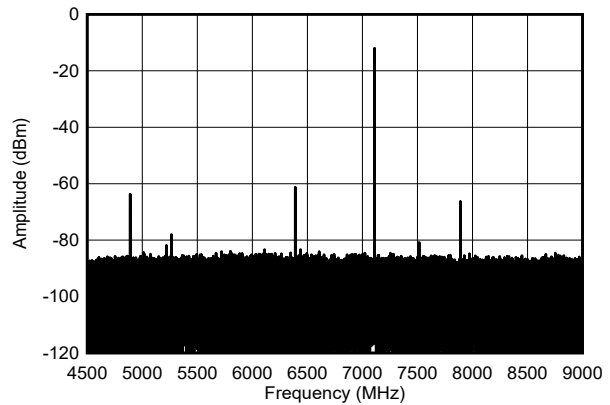

图 5-557. Single Tone Output Spectrum at 7.1GHz, -6dBFS (Nyquist)

5.12.13 TX Typical Characteristics at 7.1GHz (continued)

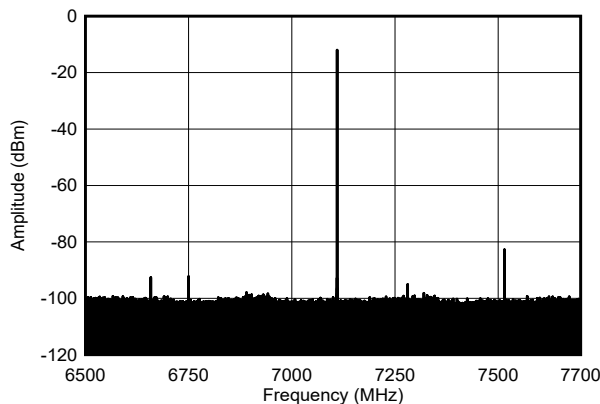
Typical values at $T_A = +25^\circ\text{C}$ with nominal supplies. Unless otherwise noted, TX input data rate = 750MSPS, $f_{\text{DAC}} = 9000\text{MSPS}$, non-interleave mode, $A_{\text{OUT}} = -1\text{ dBFS}$, 2nd Nyquist zone output, External clock mode, 12x Interpolation, DSA = 0 dB, Sin(x)/x enabled, DSA calibrated, TX Clock Dither Enabled, 7.1GHz matching.

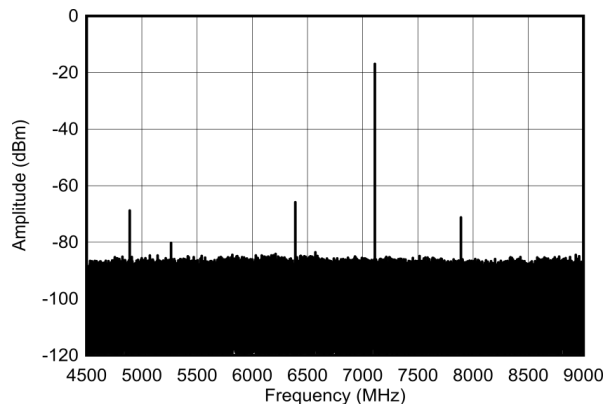

图 5-558. Single Tone Output Spectrum at 7.1GHz, -6dBFS (Inband)



图 5-559. Single Tone Output Spectrum at 7.1GHz, -12dBFS (Nyquist)

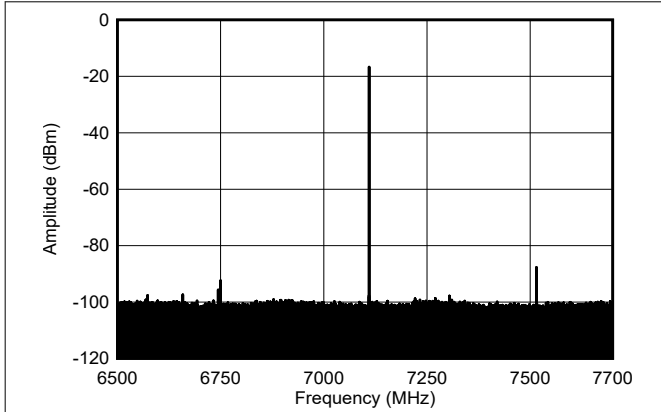

图 5-560. Single Tone Output Spectrum at 7.1GHz, -12dBFS (Inband)

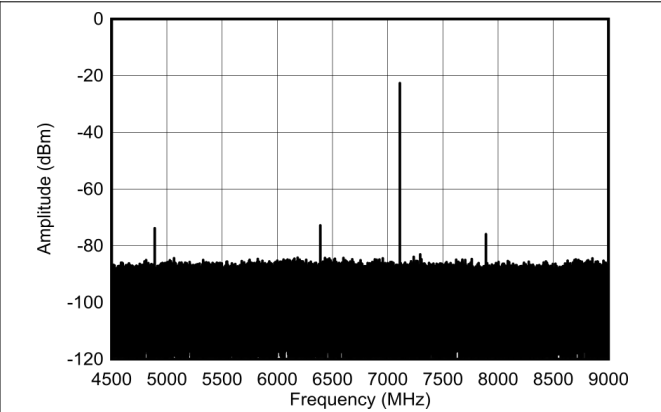

50MHz Tone Spacing

图 5-561. Two Tone Output Spectrum at 7.1GHz, -7dBFS each (Nyquist)

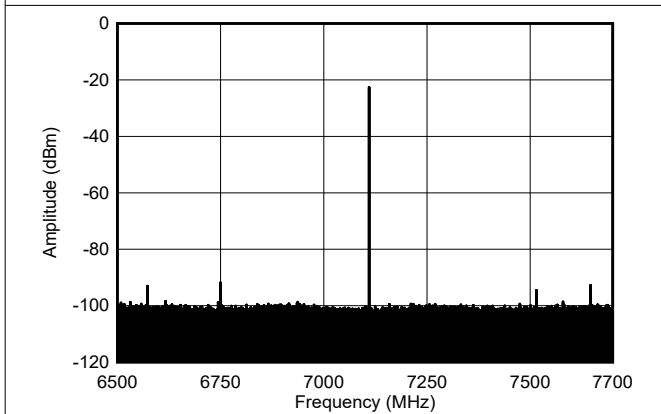
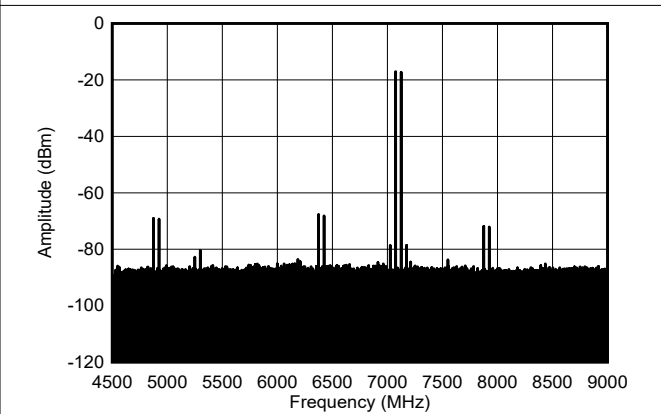
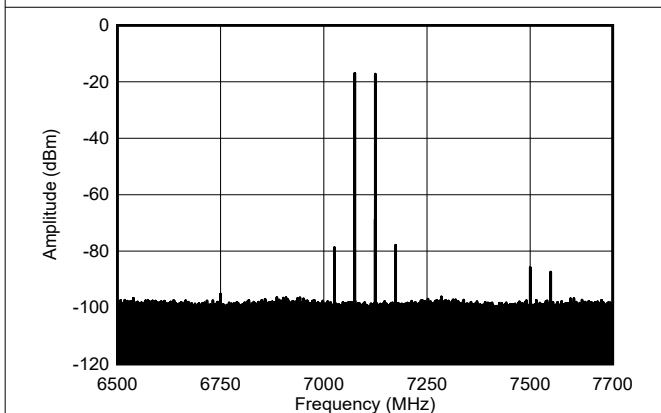

50MHz Tone Spacing

图 5-562. Two Tone Output Spectrum at 7.1GHz, -7dBFS each (Inband)

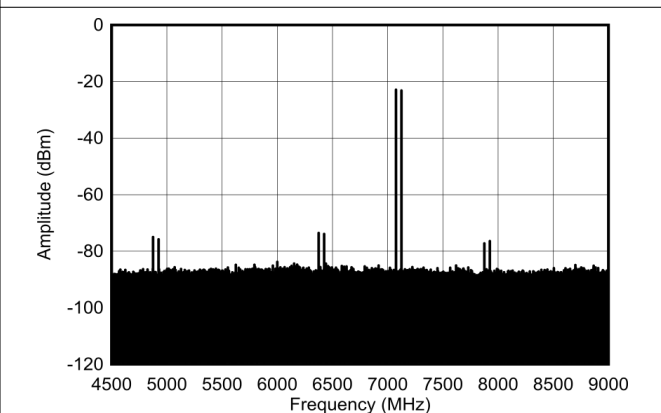

50MHz Tone Spacing

图 5-563. Two Tone Output Spectrum at 7.1GHz, -13dBFS each (Nyquist)

5.12.13 TX Typical Characteristics at 7.1GHz (continued)

Typical values at $T_A = +25^\circ\text{C}$ with nominal supplies. Unless otherwise noted, TX input data rate = 750MSPS, $f_{DAC} = 9000\text{MSPS}$, non-interleave mode, $A_{OUT} = -1\text{ dBFS}$, 2nd Nyquist zone output, External clock mode, 12x Interpolation, DSA = 0 dB, Sin(x)/x enabled, DSA calibrated, TX Clock Dither Enabled, 7.1GHz matching.



图 5-564. Two Tone Output Spectrum at 7.1GHz, -13dBFS each (Inband)



图 5-565. Two Tone Output Spectrum at 7.1GHz, -30dBFS each (Nyquist)

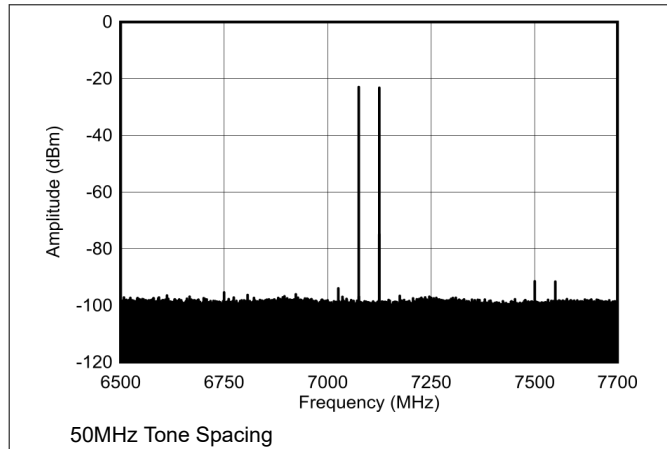

图 5-566. Two Tone Output Spectrum at 7.1GHz, -30dBFS each (Inband)

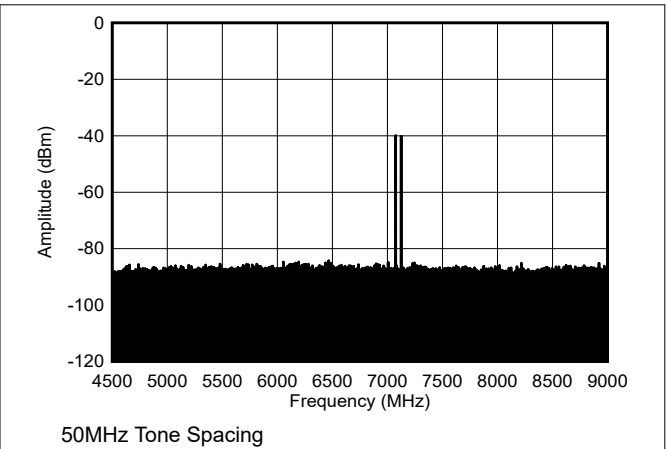

图 5-567. External Clock Additive Phase Noise at 7.1 GHz

5.12.14 PLL and Clock Typical Characteristics

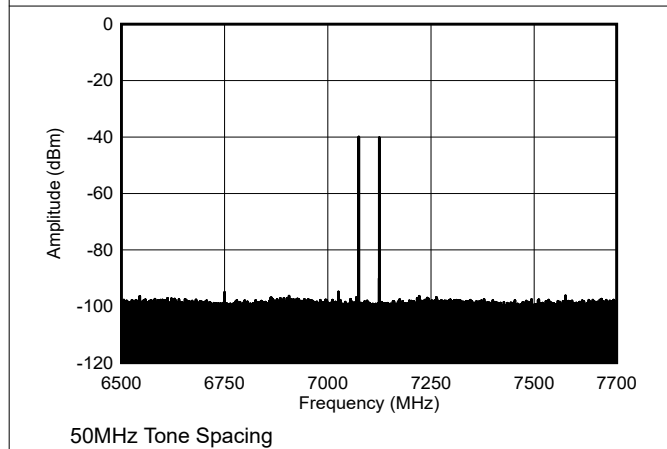
Typical values at $T_A = +25^\circ\text{C}$ with nominal supplies. Unless otherwise noted, $f_{\text{REF}} = 491.52 \text{ MHz}$, Phase noise measured at TX output

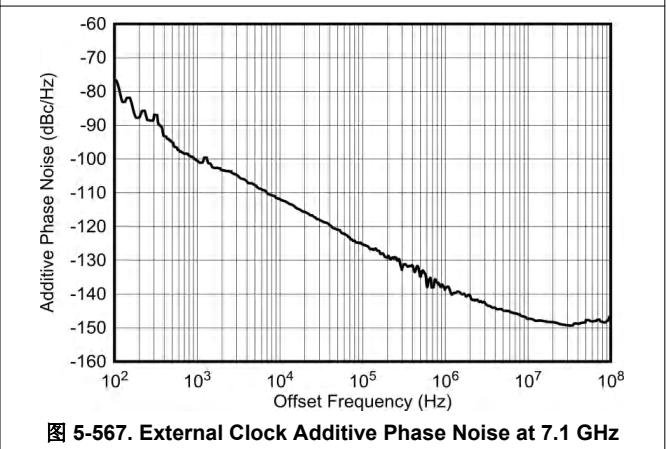
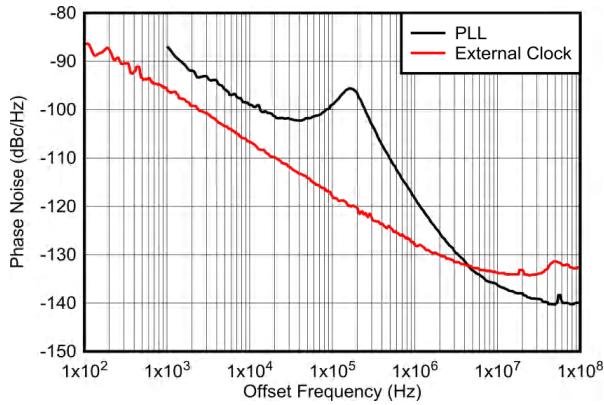

measured at TX output, normalized to 12GHz by $20 \cdot \log_{10}(12\text{GHz}/F_{\text{OUT}})$

图 5-568. Phase Noise vs Offset Frequency for PLL and External Clock at 12GHz

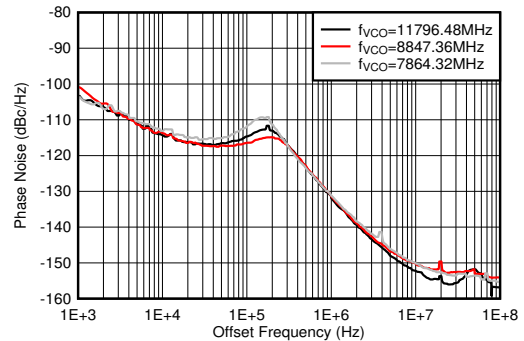

PLL enabled, $f_{\text{REF}} = 491.52\text{MSPS}$, measured at 2TXOUT

图 5-569. Phase Noise vs Offset Frequency and f_{VCO} at $f_{\text{OUT}} = 2610 \text{ MHz}$

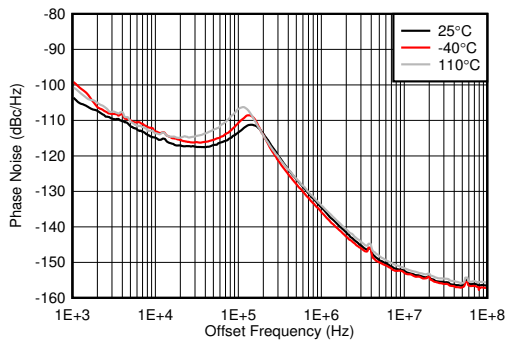

PLL enabled, $f_{\text{VCO}} = 11796.48 \text{ MHz}$, $f_{\text{REF}} = 491.52\text{MSPS}$, measured at 2TXOUT

图 5-570. Phase Noise for 12-GHz VCO vs Offset Frequency and Temperature at $f_{\text{OUT}} = 1910 \text{ MHz}$

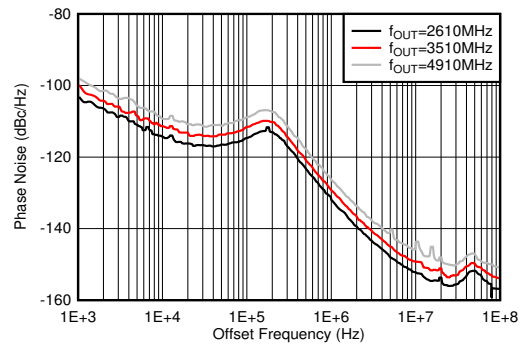

PLL enabled, $f_{\text{VCO}} = 11796.48 \text{ MHz}$, $f_{\text{REF}} = 491.52\text{MSPS}$, measured at 2TXOUT

图 5-571. Phase Noise for 12-GHz VCO vs Offset Frequency and f_{OUT} at 25°C

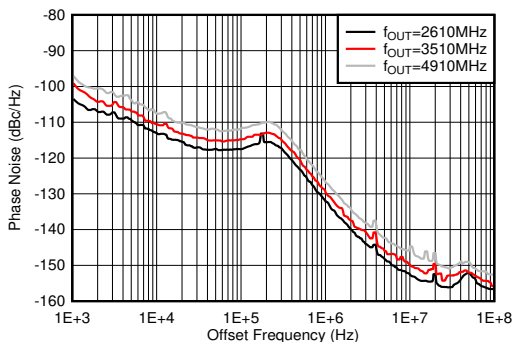

PLL enabled, $f_{\text{VCO}} = 11796.48 \text{ MHz}$, $f_{\text{REF}} = 491.52\text{MSPS}$, measured at 2TXOUT

图 5-572. Phase Noise for 12-GHz VCO vs Offset Frequency and f_{OUT} at -40°C

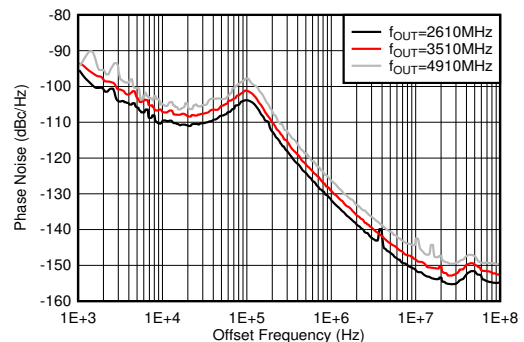

PLL enabled, $f_{\text{VCO}} = 11796.48 \text{ MHz}$, $f_{\text{REF}} = 491.52\text{MSPS}$, measured at 2TXOUT

图 5-573. Phase Noise for 12-GHz VCO vs Offset Frequency and f_{OUT} at 110°C

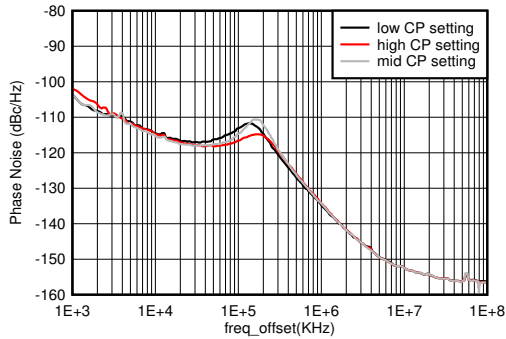

PLL enabled, $f_{VCO} = 11796.48$ MHz, $f_{REF} = 491.52$ MSPS, measured at 2TXOUT

图 5-574. Phase Noise for 12-GHz VCO vs Offset Frequency and CP Setting at $f_{OUT} = 2.6$ GHz

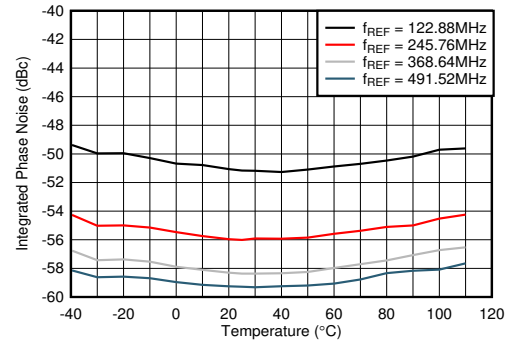

PLL enabled, $f_{VCO} = 11796.48$ MHz, 1-kHz to 100-MHz, single-sided integration bandwidth, measured at 2TXOUT

图 5-575. Integrated Phase Noise for 12-GHz VCO vs Temperature and f_{REF} at $f_{OUT} = 2.6$ GHz

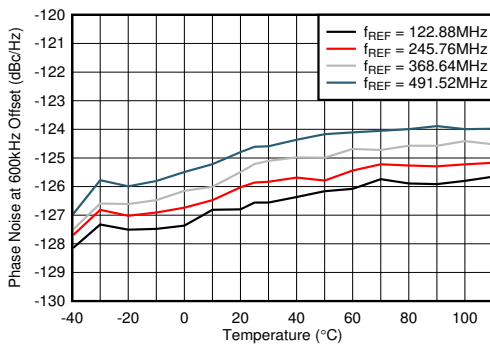

PLL enabled, $f_{VCO} = 11796.48$ MHz, measured at 2TXOUT

图 5-576. Phase Noise for 12-GHz VCO at 600kHz Offset vs Temperature and f_{REF} at $f_{OUT} = 2.6$ GHz

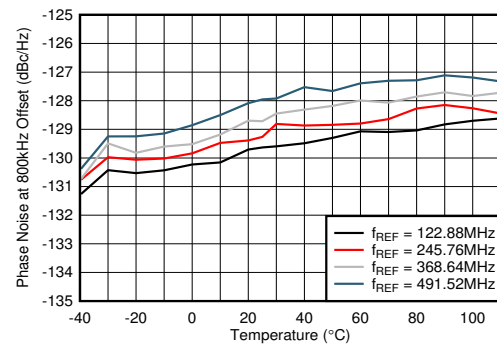

A. PLL enabled, $f_{VCO} = 11796.48$ MHz, measured at 2TXOUT

图 5-577. Phase Noise for 12-GHz VCO at 800-kHz Offset vs Temperature and f_{REF} at $f_{OUT} = 2.6$ GHz

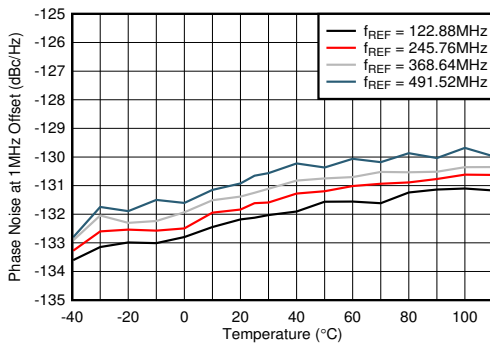

PLL enabled, $f_{VCO} = 11796.48$ MHz, measured at 2TXOUT

图 5-578. Phase Noise for 12-GHz VCO at 1-MHz Offset vs Temperature and f_{REF} at $f_{OUT} = 2.6$ GHz

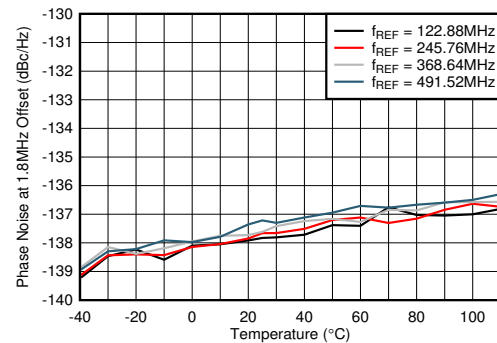

PLL enabled, $f_{VCO} = 11796.48$ MHz, measured at 2TXOUT

图 5-579. Phase Noise for 12-GHz VCO at 1.8-MHz Offset vs Temperature and f_{REF} at $f_{OUT} = 2.6$ GHz

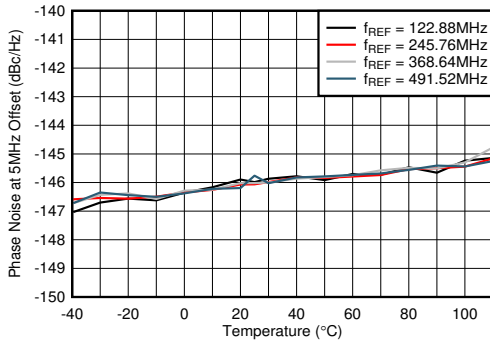

PLL enabled, $f_{VCO} = 11796.48$ MHz, measured at 2TXOUT

图 5-580. Phase Noise for 12-GHz VCO at 5-MHz Offset vs Temperature and f_{REF} at $f_{OUT} = 2.6$ GHz

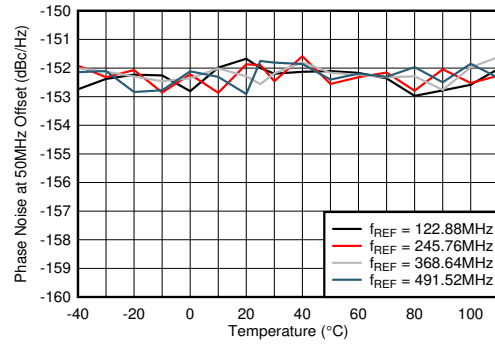

PLL enabled, $f_{VCO} = 11796.48$ MHz, measured at 2TXOUT

图 5-581. Phase Noise for 12-GHz VCO at 50-MHz Offset vs Temperature and f_{REF} at $f_{OUT} = 2.6$ GHz

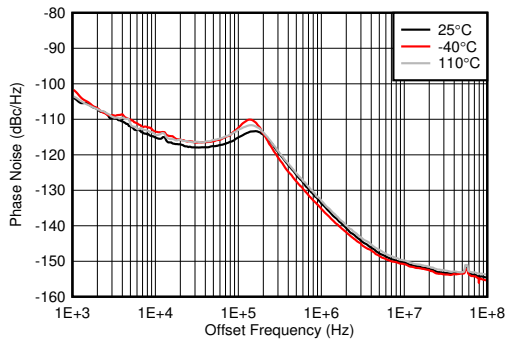

PLL enabled, $f_{VCO} = 9830.4$ MHz, $f_{REF} = 491.52$ MSPS, measured at 2TXOUT

图 5-582. Phase Noise for 10-GHz VCO vs Offset Frequency and Temperature at $f_{OUT} = 1910$ MHz

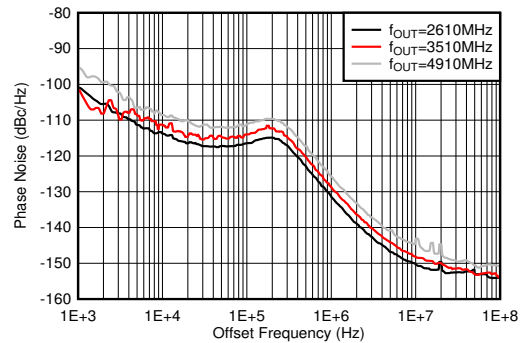

PLL enabled, $f_{VCO} = 9830.4$ MHz, $f_{REF} = 491.52$ MSPS, measured at 2TXOUT

图 5-583. Phase Noise for 10-GHz VCO vs Offset Frequency and f_{OUT} at 25°C

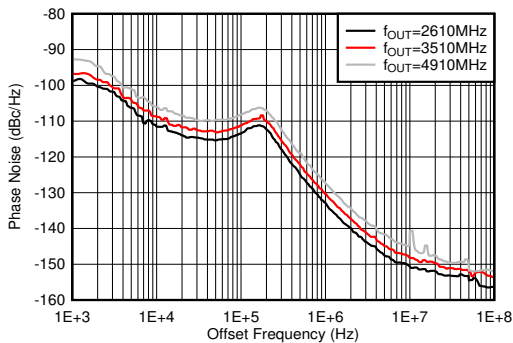

PLL enabled, $f_{VCO} = 9830.4$ MHz, $f_{REF} = 491.52$ MSPS, measured at 2TXOUT

图 5-584. Phase Noise for 10-GHz VCO vs Offset Frequency and f_{OUT} at -40°C

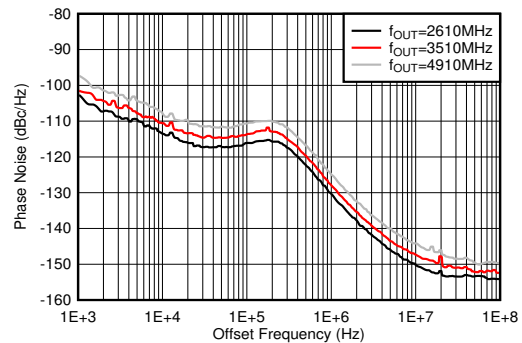

PLL enabled, $f_{VCO} = 9830.4$ MHz, $f_{REF} = 491.52$ MSPS, measured at 2TXOUT

图 5-585. Phase Noise for 10-GHz VCO vs Offset Frequency and f_{OUT} at 110°C

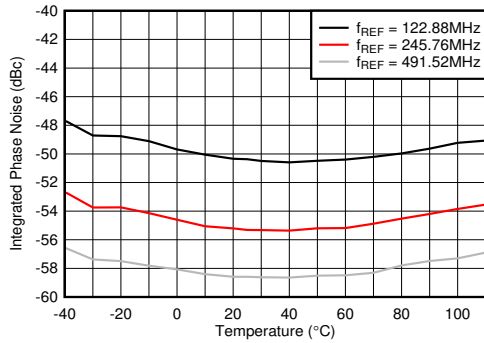

PLL enabled, $f_{VCO} = 9830.4$ MHz, 1-kHz to 100-MHz, single-sided integration bandwidth, measured at 2TXOUT

图 5-586. Integrated Phase Noise for 10-GHz VCO vs Temperature and f_{REF} at $f_{OUT} = 2.6$ GHz

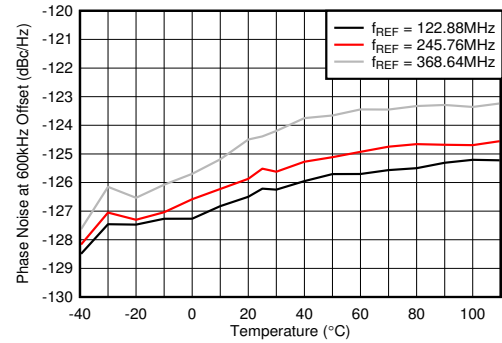

PLL enabled, $f_{VCO} = 9830.4$ MHz, measured at 2TXOUT

图 5-587. Phase Noise for 10-GHz VCO at 600 kHz vs Temperature and f_{REF} at $f_{OUT} = 2.6$ GHz

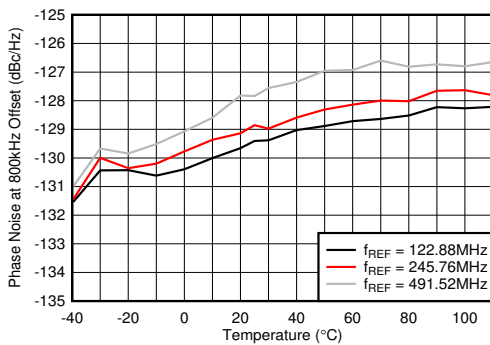

PLL enabled, $f_{VCO} = 9830.4$ MHz, measured at 2TXOUT

图 5-588. Phase Noise for 10-GHz VCO at 800 kHz vs Temperature and f_{REF} at $f_{OUT} = 2.6$ GHz

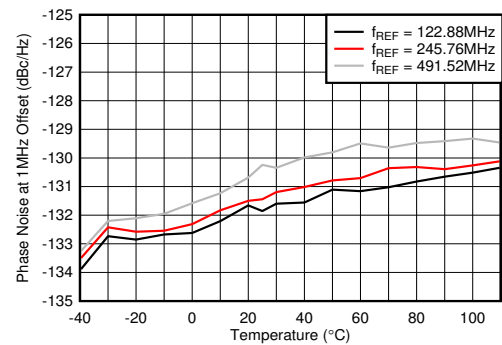

PLL enabled, $f_{VCO} = 9830.4$ MHz, measured at 2TXOUT

图 5-589. Phase Noise for 10-GHz VCO at 1 MHz vs Temperature and f_{REF} at $f_{OUT} = 2.6$ GHz

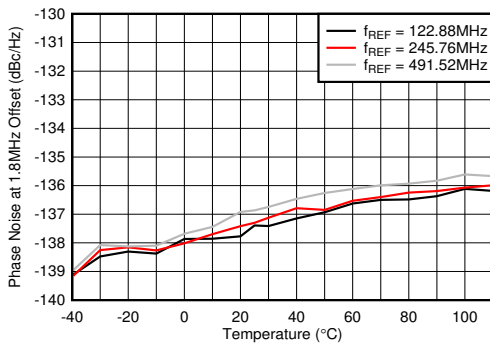

PLL enabled, $f_{VCO} = 9830.4$ MHz, measured at 2TXOUT

图 5-590. Phase Noise for 10-GHz VCO at 1.8 MHz vs Temperature and f_{REF} at $f_{OUT} = 2.6$ GHz

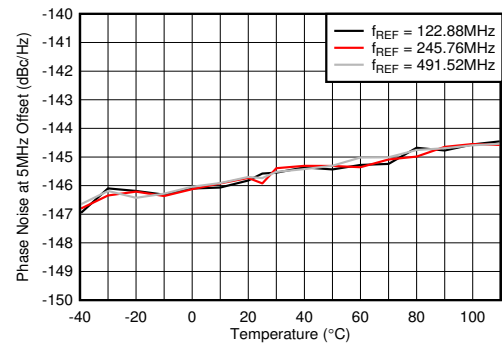

PLL enabled, $f_{VCO} = 9830.4$ MHz, measured at 2TXOUT

图 5-591. Phase Noise for 10-GHz VCO at 5 MHz vs Temperature and f_{REF} at $f_{OUT} = 2.6$ GHz

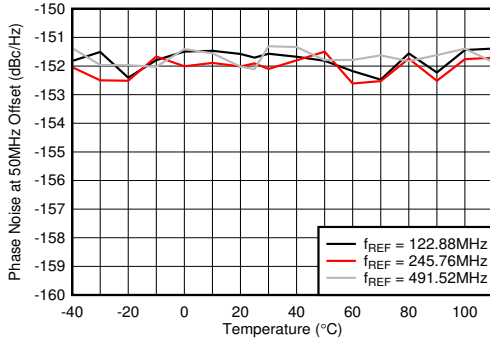

PLL enabled, $f_{VCO} = 9830.4$ MHz, measured at 2TXOUT

图 5-592. Phase Noise for 10-GHz VCO at 50 MHz vs Temperature and f_{REF} at $f_{OUT} = 2.6$ GHz

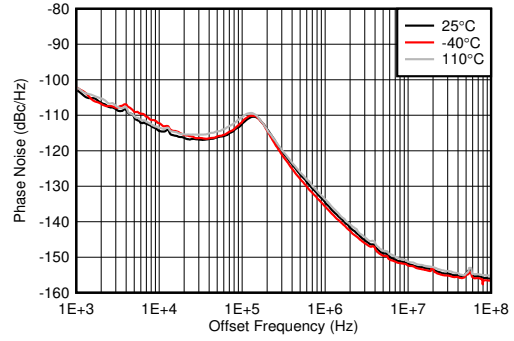

PLL enabled, $f_{VCO} = 8847.36$ MHz, $f_{REF} = 491.52$ MSPS, measured at 2TXOUT

图 5-593. Phase Noise for 9-GHz VCO vs Offset Frequency and Temperature at $f_{OUT} = 1910$ MHz

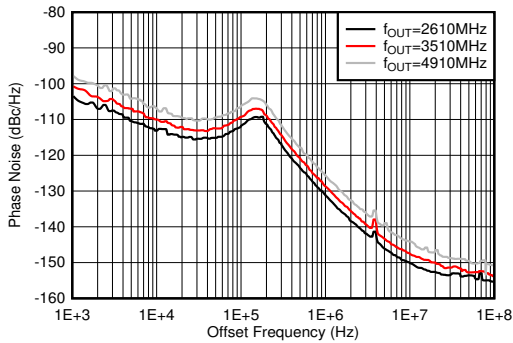

PLL enabled, $f_{VCO} = 8847.36$ MHz, $f_{REF} = 491.52$ MSPS, measured at 2TXOUT

图 5-594. Phase Noise for 9-GHz VCO vs Offset Frequency and f_{OUT} at 25°C

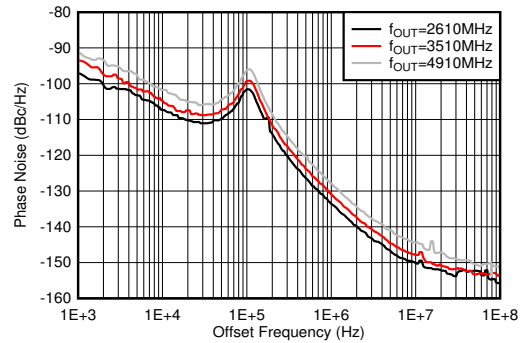

PLL enabled, $f_{VCO} = 8847.36$ MHz, $f_{REF} = 491.52$ MSPS, measured at 2TXOUT

图 5-595. Phase Noise for 9-GHz VCO vs Offset Frequency and f_{OUT} at -40°C

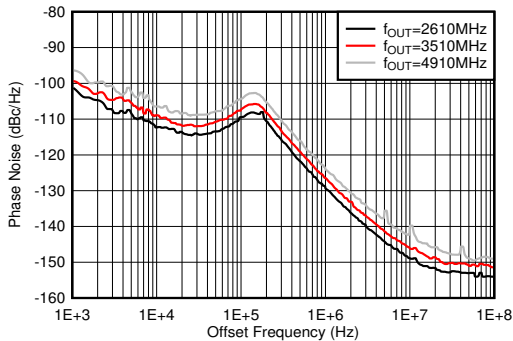

PLL enabled, $f_{VCO} = 8847.36$ MHz, $f_{REF} = 491.52$ MSPS, measured at 2TXOUT

图 5-596. Phase Noise for 9-GHz VCO vs Offset Frequency and f_{OUT} at 110°C

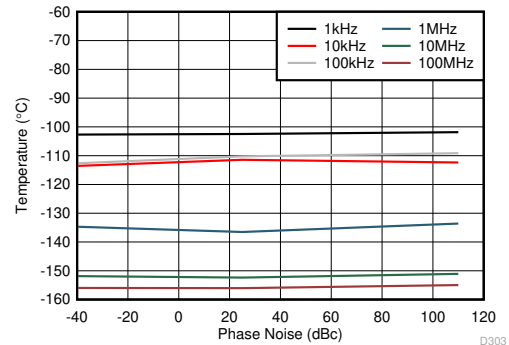

PLL enabled, $f_{VCO} = 8847.36$ MHz, $f_{REF} = 491.52$ MSPS, minimum LPF BW, measured at 2TXOUT

图 5-597. Phase Noise for 9-GHz VCO vs Temperature Over Offset Frequency at $f_{OUT} = 2.6$ GHz

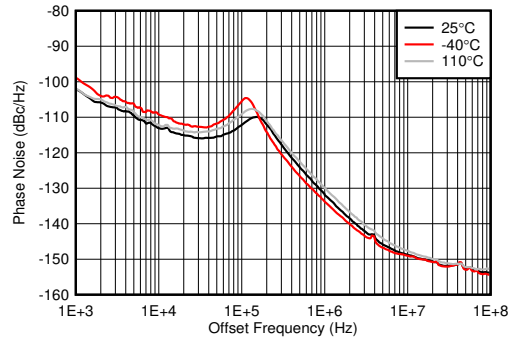

PLL enabled, $f_{VCO} = 7864.32$ MHz, $f_{REF} = 491.52$ MSPS, measured at 2TXOUT

图 5-598. Phase Noise for 8-GHz VCO vs Offset Frequency and Temperature at $f_{OUT} = 1910$ MHz

6 Device and Documentation Support

6.1 接收文档更新通知

要接收文档更新通知，请导航至 [ti.com](https://www.ti.com) 上的器件产品文件夹。点击 [订阅更新](#) 进行注册，即可每周接收产品信息更改摘要。有关更改的详细信息，请查看任何已修订文档中包含的修订历史记录。

6.2 支持资源

TI E2E™ 支持论坛是工程师的重要参考资料，可直接从专家获得快速、经过验证的解答和设计帮助。搜索现有解答或提出自己的问题可获得所需的快速设计帮助。

链接的内容由各个贡献者“按原样”提供。这些内容并不构成 TI 技术规范，并且不一定反映 TI 的观点；请参阅 TI 的《[使用条款](#)》。

6.3 商标

TI E2E™ is a trademark of Texas Instruments.

所有商标均为其各自所有者的财产。

6.4 静电放电警告



静电放电 (ESD) 会损坏这个集成电路。德州仪器 (TI) 建议通过适当的预防措施处理所有集成电路。如果不遵守正确的处理和安装程序，可能会损坏集成电路。

ESD 的损坏小至导致微小的性能降级，大至整个器件故障。精密的集成电路可能更容易受到损坏，这是因为非常细微的参数更改都可能会导致器件与其发布的规格不相符。

6.5 术语表

TI 术语表 本术语表列出并解释了术语、首字母缩略词和定义。

7 Mechanical, Packaging, and Orderable Information

The following pages include mechanical, packaging, and orderable information. This information is the most current data available for the designated devices. This data is subject to change without notice and revision of this document. For browser-based versions of this data sheet, refer to the left-hand navigation.

PACKAGING INFORMATION

Orderable Device	Status (1)	Package Type	Package Drawing	Pins	Package Qty	Eco Plan (2)	Lead finish/ Ball material (6)	MSL Peak Temp (3)	Op Temp (°C)	Device Marking (4/5)	Samples
AFE7900IABJ	ACTIVE	FCBGA	ABJ	400	90	RoHS & Green	SNAGCU	Level-3-260C-168 HR	-40 to 85	AFE7900I	Samples
AFE7900IALK	ACTIVE	FCBGA	ALK	400	90	Non-RoHS & Green	Call TI	Level-3-220C-168 HR	-40 to 85	AFE7900 SNPB	Samples

(1) The marketing status values are defined as follows:

ACTIVE: Product device recommended for new designs.

LIFEBUY: TI has announced that the device will be discontinued, and a lifetime-buy period is in effect.

NRND: Not recommended for new designs. Device is in production to support existing customers, but TI does not recommend using this part in a new design.

PREVIEW: Device has been announced but is not in production. Samples may or may not be available.

OBSOLETE: TI has discontinued the production of the device.

(2) **RoHS:** TI defines "RoHS" to mean semiconductor products that are compliant with the current EU RoHS requirements for all 10 RoHS substances, including the requirement that RoHS substance do not exceed 0.1% by weight in homogeneous materials. Where designed to be soldered at high temperatures, "RoHS" products are suitable for use in specified lead-free processes. TI may reference these types of products as "Pb-Free".

RoHS Exempt: TI defines "RoHS Exempt" to mean products that contain lead but are compliant with EU RoHS pursuant to a specific EU RoHS exemption.

Green: TI defines "Green" to mean the content of Chlorine (Cl) and Bromine (Br) based flame retardants meet JS709B low halogen requirements of <=1000ppm threshold. Antimony trioxide based flame retardants must also meet the <=1000ppm threshold requirement.

(3) MSL, Peak Temp. - The Moisture Sensitivity Level rating according to the JEDEC industry standard classifications, and peak solder temperature.

(4) There may be additional marking, which relates to the logo, the lot trace code information, or the environmental category on the device.

(5) Multiple Device Markings will be inside parentheses. Only one Device Marking contained in parentheses and separated by a "-" will appear on a device. If a line is indented then it is a continuation of the previous line and the two combined represent the entire Device Marking for that device.

(6) Lead finish/Ball material - Orderable Devices may have multiple material finish options. Finish options are separated by a vertical ruled line. Lead finish/Ball material values may wrap to two lines if the finish value exceeds the maximum column width.

Important Information and Disclaimer:The information provided on this page represents TI's knowledge and belief as of the date that it is provided. TI bases its knowledge and belief on information provided by third parties, and makes no representation or warranty as to the accuracy of such information. Efforts are underway to better integrate information from third parties. TI has taken and continues to take reasonable steps to provide representative and accurate information but may not have conducted destructive testing or chemical analysis on incoming materials and chemicals. TI and TI suppliers consider certain information to be proprietary, and thus CAS numbers and other limited information may not be available for release.

In no event shall TI's liability arising out of such information exceed the total purchase price of the TI part(s) at issue in this document sold by TI to Customer on an annual basis.

TRAY

Chamfer on Tray corner indicates Pin 1 orientation of packed units.

*All dimensions are nominal

Device	Package Name	Package Type	Pins	SPQ	Unit array matrix	Max temperature (°C)	L (mm)	W (mm)	K0 (µm)	P1 (mm)	CL (mm)	CW (mm)
AFE7900IABJ	ABJ	FCBGA	400	90	6 x 15	150	315	135.9	7620	19.5	21	19.2
AFE7900IABJ	ABJ	FCBGA	400	90	6 x 15	150	315	135.9	7620	19.5	21	19.2
AFE7900IALK	ALK	FCBGA	400	90	6 x 15	150	315	135.9	7620	19.5	21	19.2
AFE7900IALK	ALK	FCBGA	400	90	6 x 15	150	315	135.9	7620	19.5	21	19.2

ABJ0400A

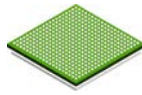

PACKAGE OUTLINE

FCBGA - 2.65 mm max height

BALL GRID ARRAY

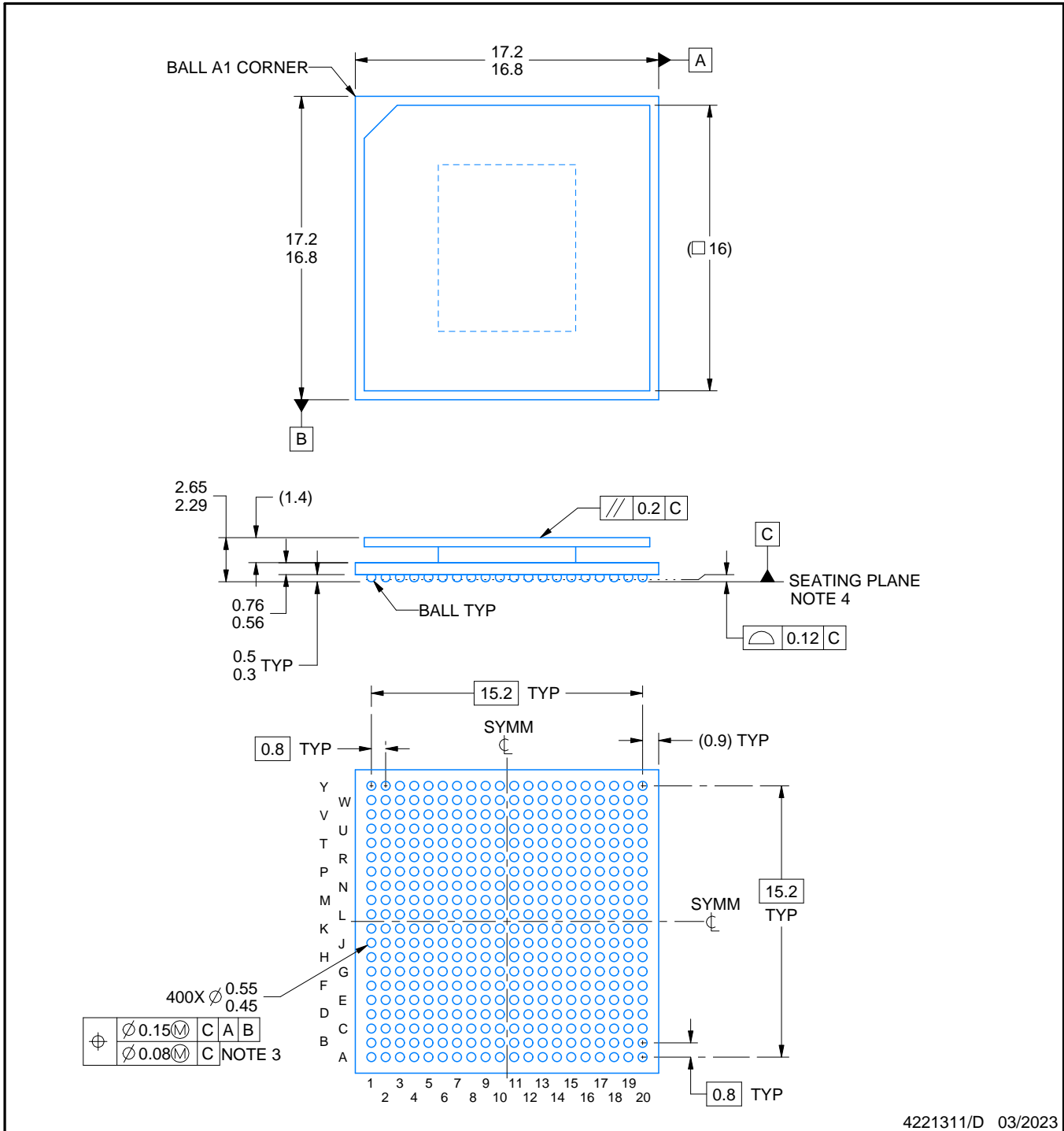

4221311/D 03/2023

NOTES:

1. All linear dimensions are in millimeters. Any dimensions in parenthesis are for reference only. Dimensioning and tolerancing per ASME Y14.5M.
2. This drawing is subject to change without notice.
3. Dimension is measured at the maximum solder ball diameter, parallel to primary datum C.
4. Primary datum C and seating plane are defined by the spherical crowns of the solder balls.
5. The lids are electrically floating (e.g. not tied to GND).

EXAMPLE BOARD LAYOUT

ABJ0400A

FCBGA - 2.65 mm max height

BALL GRID ARRAY

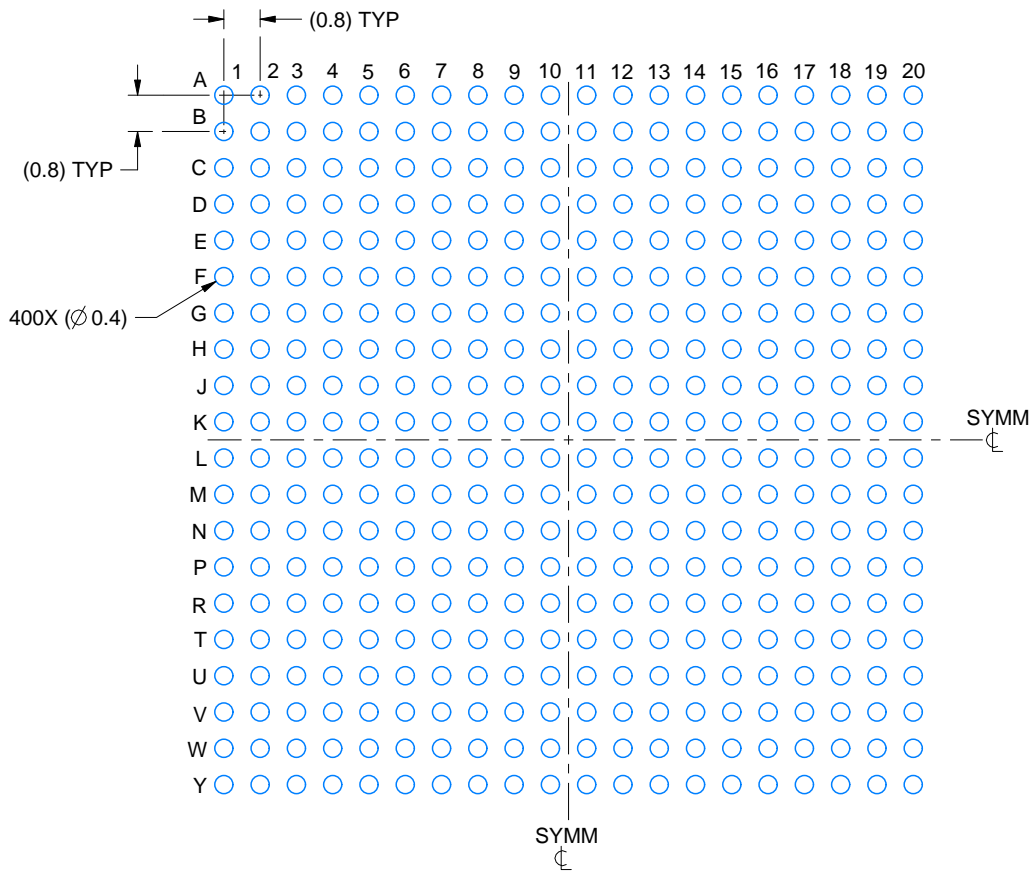

LAND PATTERN EXAMPLE
EXPOSED METAL SHOWN
SCALE:6X

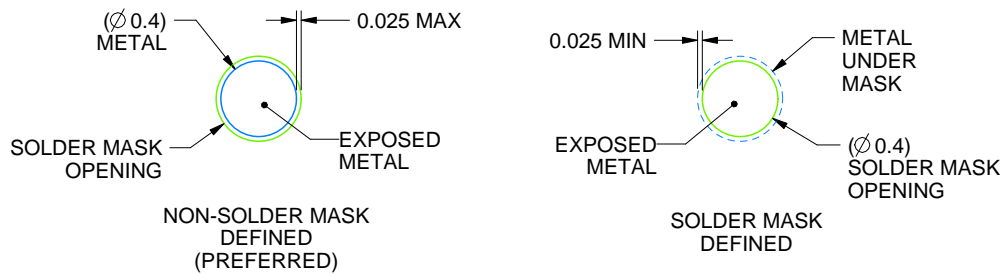

SOLDER MASK DETAILS
NOT TO SCALE

4221311/D 03/2023

NOTES: (continued)

- Final dimensions may vary due to manufacturing tolerance considerations and also routing constraints. For more information, see Texas Instruments literature number SPRU811 (www.ti.com/lit/spru811).

EXAMPLE STENCIL DESIGN

ABJ0400A

FCBGA - 2.65 mm max height

BALL GRID ARRAY

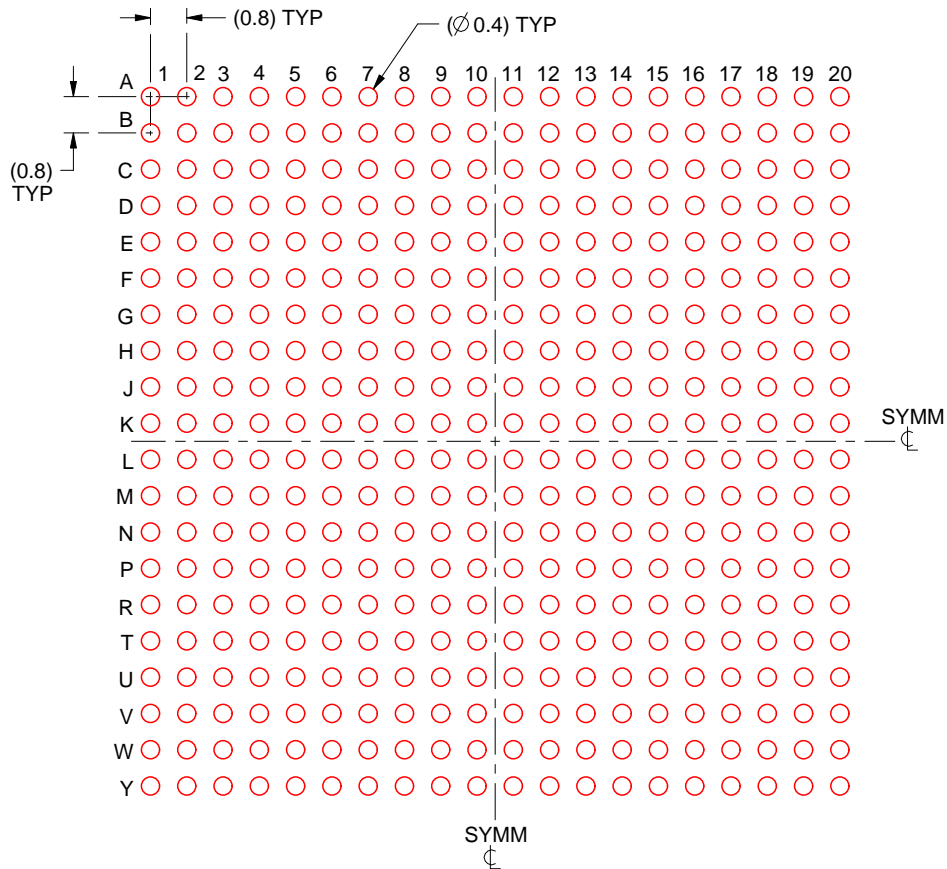

SOLDER PASTE EXAMPLE
BASED ON 0.15 mm THICK STENCIL
SCALE:6X

4221311/D 03/2023

NOTES: (continued)

7. Laser cutting apertures with trapezoidal walls and rounded corners may offer better paste release.

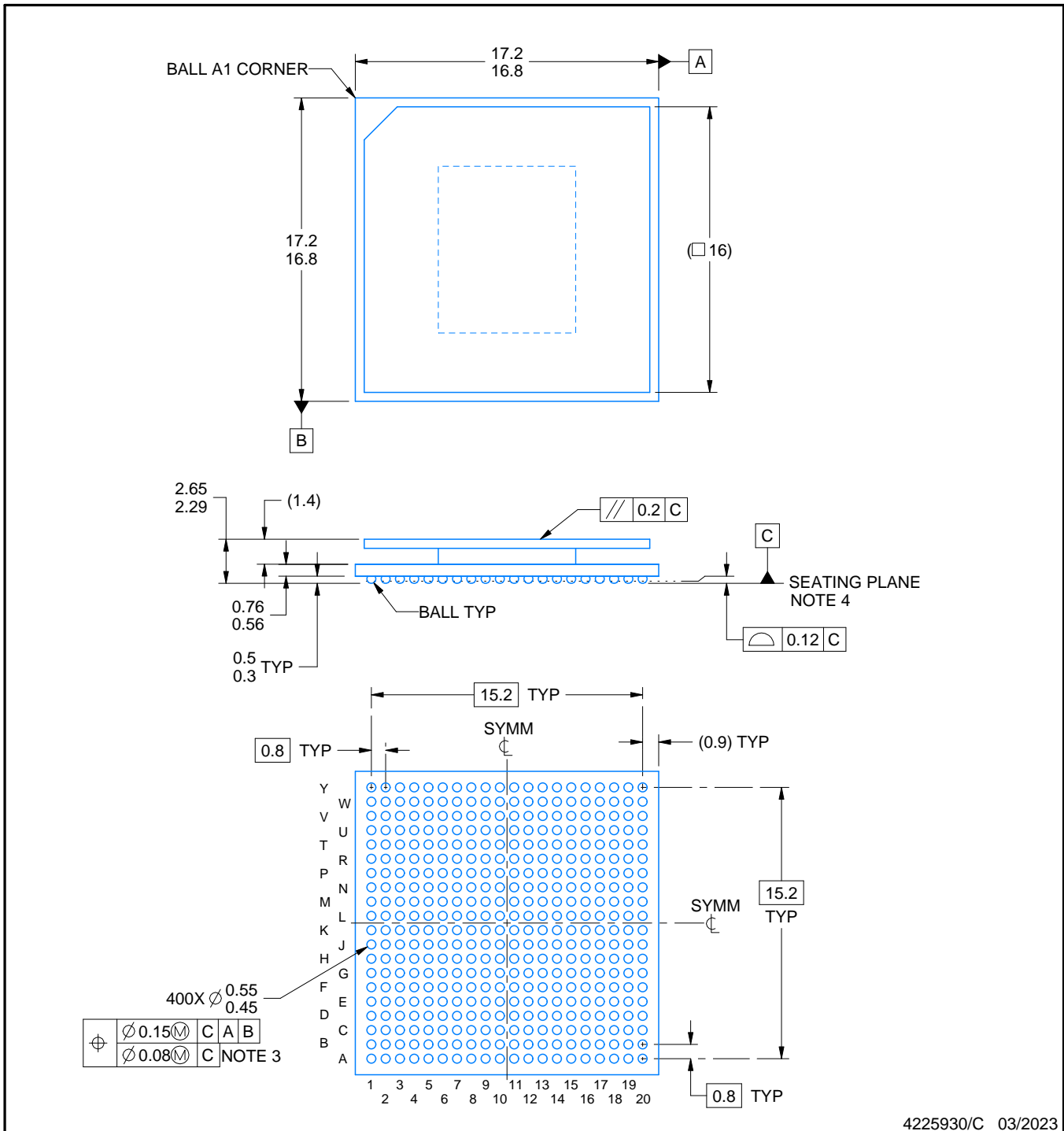
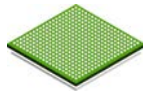

4225930/C 03/2023

NOTES:

1. All linear dimensions are in millimeters. Any dimensions in parenthesis are for reference only. Dimensioning and tolerancing per ASME Y14.5M.
2. This drawing is subject to change without notice.
3. Dimension is measured at the maximum solder ball diameter, parallel to primary datum C.
4. Primary datum C and seating plane are defined by the spherical crowns of the solder balls.
5. Pb-Free die bump and SnPb solder ball.
6. The lids are electrically floating (e.g. not tied to GND).

EXAMPLE BOARD LAYOUT

ALK0400A

FCBGA - 2.65 mm max height

BALL GRID ARRAY

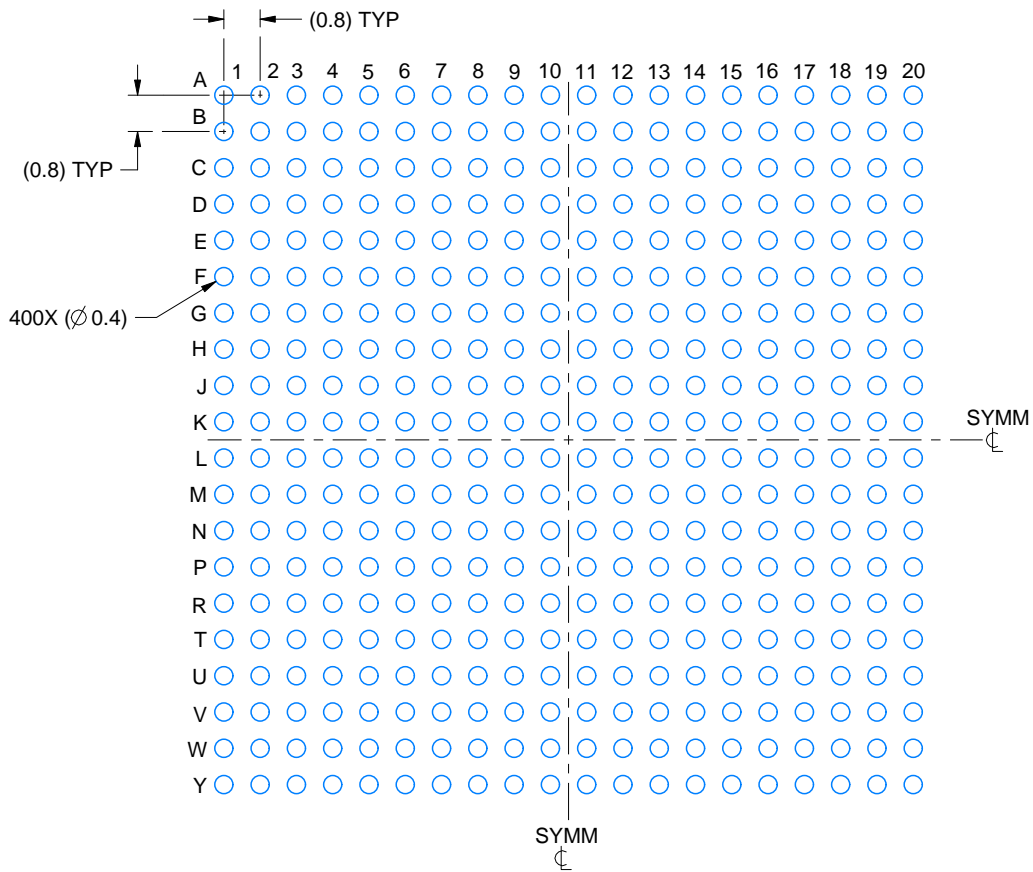

LAND PATTERN EXAMPLE
EXPOSED METAL SHOWN
SCALE:6X



SOLDER MASK DETAILS
NOT TO SCALE

4225930/C 03/2023

NOTES: (continued)

- Final dimensions may vary due to manufacturing tolerance considerations and also routing constraints. For more information, see Texas Instruments literature number SPRU811 (www.ti.com/lit/spru811).

EXAMPLE STENCIL DESIGN

ALK0400A

FCBGA - 2.65 mm max height

BALL GRID ARRAY

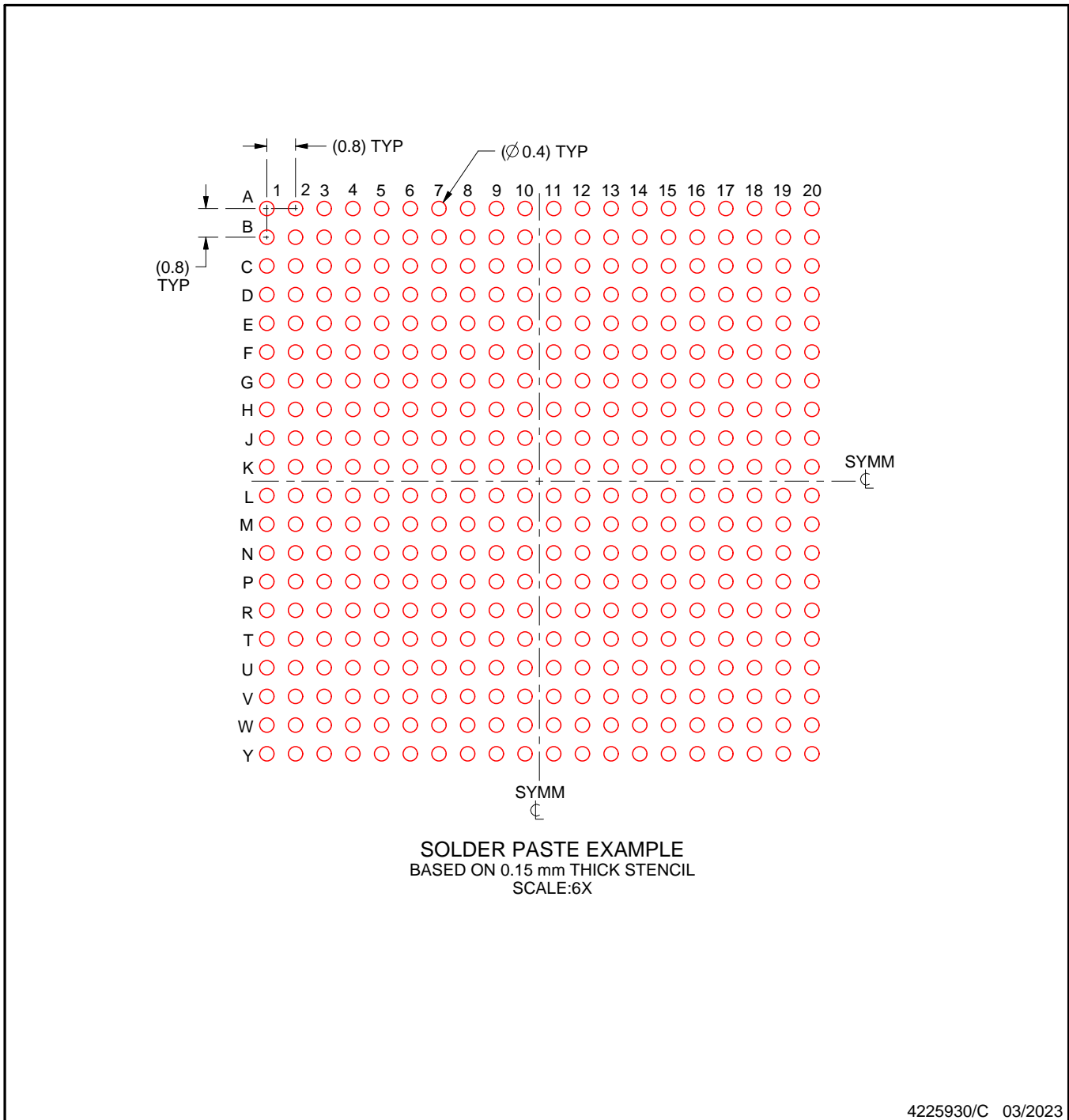

NOTES: (continued)

8. Laser cutting apertures with trapezoidal walls and rounded corners may offer better paste release.

重要声明和免责声明

TI“按原样”提供技术和可靠性数据（包括数据表）、设计资源（包括参考设计）、应用或其他设计建议、网络工具、安全信息和其他资源，不保证没有瑕疵且不做任何明示或暗示的担保，包括但不限于对适销性、某特定用途方面的适用性或不侵犯任何第三方知识产权的暗示担保。

这些资源可供使用 TI 产品进行设计的熟练开发人员使用。您将自行承担以下全部责任：(1) 针对您的应用选择合适的 TI 产品，(2) 设计、验证并测试您的应用，(3) 确保您的应用满足相应标准以及任何其他功能安全、信息安全、监管或其他要求。

这些资源如有变更，恕不另行通知。TI 授权您仅可将这些资源用于研发本资源所述的 TI 产品的应用。严禁对这些资源进行其他复制或展示。您无权使用任何其他 TI 知识产权或任何第三方知识产权。您应全额赔偿因在这些资源的使用中对 TI 及其代表造成的任何索赔、损害、成本、损失和债务，TI 对此概不负责。

TI 提供的产品受 [TI 的销售条款](#) 或 [ti.com](#) 上其他适用条款/TI 产品随附的其他适用条款的约束。TI 提供这些资源并不会扩展或以其他方式更改 TI 针对 TI 产品发布的适用的担保或担保免责声明。

TI 反对并拒绝您可能提出的任何其他或不同的条款。

邮寄地址：Texas Instruments, Post Office Box 655303, Dallas, Texas 75265

Copyright © 2024，德州仪器 (TI) 公司