

AMC1301 精密、±250mV 输入、增强型隔离放大器

1 特性

- ±250mV 输入电压范围，针对使用分流电阻器测量电流进行了优化
- 固定增益：8.2 V/V
- 低直流误差：
 - 失调电压误差：±0.2mV (最大值)
 - 温漂±3μV/°C (最大值)
 - 增益误差：±0.3% (最大值)
 - 增益漂移：±50ppm/°C (最大值)
 - 非线性度：0.03% (最大值)
- 高侧和低侧以 3.3V 电压运行
- 系统级诊断功能
- 安全相关认证：
 - 符合 DIN EN IEC 60747-17 (VDE 0884-17) 的 7070V_{PK} 增强型隔离
 - 符合 UL1577 标准且长达 1 分钟的 5000V_{RMS} 隔离
- 针对更大工业温度范围进行了全面优化：-40°C 至 +125°C

2 应用

- 基于分流电阻器的电流感应，可用于：
 - 电机驱动器
 - 变频器
 - 不间断电源

3 说明

AMC1301 是一款隔离式精密放大器，此放大器的输出与输入电路由抗电磁干扰性能极强的隔离栅隔开。该隔离栅经认证可提供高达 7070 V_{PEAK} 的增强型隔离，符合 DIN EN IEC 60747-17 (VDE 0884-17) 和 UL1577 标准，并且可支持高达 1 kV_{RMS} 的工作电压。

该隔离层可将系统中以不同共模电压电平运行的各器件隔开，防止高电压冲击导致低压侧器件电气损坏或对操作人员造成伤害。

AMC1301 的输入经过优化，可直接连接至分流电阻器或其他低电压电平信号源。具有出色的直流精度和低温漂，可支持精确的电流控制，适用于车载充电器 (OBC)、直流/直流转换器、变频器或其他高压应用。AMC1301 的集成式共模过压和无高侧电源电压检测功能可简化系统级设计和诊断。

AMC1301 可在 -40°C 至 +125°C 扩展工业温度范围内正常运行，并采用宽体 8 引脚 SOIC (DWV) 封装。AMC1301S 的额定工作温度范围为 -55°C 至 +125°C。

封装信息

器件型号	封装 ⁽¹⁾	封装尺寸 (标称值)
AMC1301	DWV (SOIC, 8)	5.85mm × 7.50mm

(1) 如需了解所有可用封装，请参阅数据表末尾的可订购产品附录。

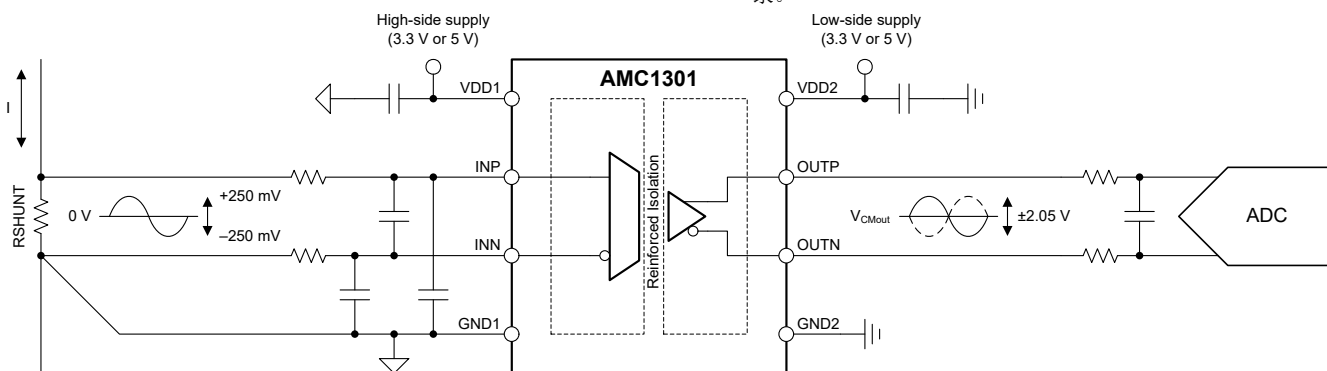

简化原理图



Table of Contents

1 特性	1	7.1 Overview.....	19
2 应用	1	7.2 Functional Block Diagram.....	19
3 说明	1	7.3 Feature Description.....	19
4 Revision History	2	7.4 Device Functional Modes.....	21
5 Pin Configuration and Functions	4	8 Application and Implementation	22
6 Specifications	5	8.1 Application Information.....	22
6.1 Absolute Maximum Ratings.....	5	8.2 Typical Application.....	22
6.2 ESD Ratings.....	5	8.3 Best Design Practices.....	25
6.3 Recommended Operating Conditions.....	5	8.4 Power Supply Recommendations.....	25
6.4 Thermal Information.....	6	8.5 Layout.....	26
6.5 Power Ratings.....	6	9 Device and Documentation Support	27
6.6 Insulation Specifications.....	7	9.1 Documentation Support.....	27
6.7 Safety-Related Certifications.....	8	9.2 接收文档更新通知.....	27
6.8 Safety Limiting Values.....	8	9.3 支持资源.....	27
6.9 Electrical Characteristics.....	9	9.4 Trademarks.....	27
6.10 Switching Characteristics.....	10	9.5 静电放电警告.....	27
6.11 Timing Diagram.....	10	9.6 术语表.....	27
6.12 Insulation Characteristics Curves.....	11	10 Mechanical, Packaging, and Orderable Information	27
6.13 Typical Characteristics.....	12		
7 Detailed Description	19		

4 Revision History

注：以前版本的页码可能与当前版本的页码不同

Changes from March 14, 2023 to April 24, 2023 (from Revision F (April 2020) to Revision G (April 2023))

	Page
• 更改了文档标题.....	1
• 更改了 <i>特性</i> 部分：更改、删除和重新编排了要点.....	1
• 将隔离标准从 DIN VDE V 0884-11 (VDE V 0884-10) 更改为 DIN EN IEC 60747-17 (VDE 0884-17)，并相应更新了 <i>绝缘规格</i> 和 <i>安全相关认证表</i>	1
• 删除了 <i>应用</i> 部分中的最后一个要点.....	1
• 更改了 <i>说明</i> 部分，以将共模去耦电容器作为已知的最佳实践.....	1
• Changed pin names VINP to INP, VINN to INN, VOUTP to OUTP, and VOUTN to OUTN throughout document.....	4
• Changed <i>Description</i> column and added footnotes to <i>Pin Functions</i> table.....	4
• Changed CDM ESD standard from JESD22-C101 to JEDEC JS-002	5
• Changed PD from 81.4 mW to 99 mW.....	6
• Changed PD1 (VDD1 = 3.3 V) from 24.85 mW to 31 mW.....	6
• Changed PD1 (VDD1 = 5.5 V) from 45.65 mW to 54 mW.....	6
• Changed PD2 (VDD2 = 3.3 V) from 20.16 mW to 26 mW.....	6
• Changed PD2 (VDD2 = 5.5 V) from 35.75 mW to 45 mW.....	6
• Changed DTI from ≥ 0.027 mm to ≥ 0.021 mm in <i>Insulation Specifications</i> table.....	7
• Changed IDD1 (3.0 V \leq VDD1 \leq 3.6 V) from 5.0 mA (typ) / 6.9 mA (max) to 6.3 mA (typ) / 8.5 mA (max)....	9
• Changed IDD1 (4.5 V \leq VDD1 \leq 5.5 V) from 5.9 mA (typ) / 8.3 mA (max) to 7.2 mA (typ) / 9.8 mA (max)....	9
• Changed IDD2 (3.0 V \leq VDD2 \leq 3.6 V) from 4.4 mA (typ) / 5.6 mA (max) to 5.3 mA (typ) / 7.2 mA (max)....	9
• Changed IDD2 (4.5 V \leq VDD2 \leq 5.5 V) from 4.8 mA (typ) / 6.5 mA (max) to 5.9 mA (typ) / 8.1 mA (max)....	9
• Changed <i>Timing Diagram</i> section.....	10
• Changed <i>Overview</i> section.....	19
• Changed <i>Functional Block Diagram</i> image.....	19
• Changed the <i>Analog Input</i> section.....	19

• Added the <i>Isolation Channel Signal Transmission</i> section.....	20
• Added <i>Analog Output</i> section, deleted <i>Fail-Safe Output</i> section.....	21
• Changed <i>Device Functional Modes</i> section.....	21
• Changed <i>Application Information</i> section.....	22
• Changed <i>Typical Application</i> section.....	22
• Changed <i>Best Design Practices</i> section.....	25
• Changed <i>Power Supply Recommendations</i> section.....	25
• Changed the <i>Recommended Layout of the AMC1301</i> figure.....	26
• Added a link to the <i>Isolated Voltage-Measurement Circuit</i> in the <i>Related Documentation</i> section.....	27

Changes from Revision E (March 2018) to Revision F (April 2020)	Page
• 根据 ISO 标准更改了安全相关认证详细信息.....	1
• 将 <i>IEC 60950-1</i> 和 <i>IEC60065</i> 更改为 <i>IEC 62368-1</i>	1
• 在 <i>说明</i> 部分中将 <i>VDE V 0884-10</i> 更改为 <i>VDE V 0884-11</i>	1
• Changed T_A parameter from <i>specified</i> to <i>operating</i> in <i>Device Comparison Table</i>	4
• Changed CLR and CPG values from 9 mm to 8.5 mm.....	7
• Changed <i>Insulation Specifications</i> table per ISO standard.....	7
• Changed <i>Safety-Related Certifications</i> table per ISO standard.....	8
• Changed <i>Safety Limiting Values</i> description as per ISO standard.....	8
• Changed <i>Rise and Fall Time Test Waveforms</i> figure.....	10
• Changed <i>Delay Time Test Waveforms</i> figure.....	10
• Changed <i>Functional Block Diagram</i> figure.....	19

Device Comparison Table

PARAMETER	AMC1301S	AMC1301
Operating ambient temperature, T_A	- 55°C to +125°C	- 40°C to +125°C
Input offset drift, TCV_{OS}	$\pm 4 \mu V/^\circ C$ (max)	$\pm 3 \mu V/^\circ C$ (max)
Gain error drift, TCE_G	$\pm 60 \text{ ppm}/^\circ C$ (max)	$\pm 50 \text{ ppm}/^\circ C$ (max)

5 Pin Configuration and Functions



图 5-1. DWV Package, 8-Pin SOIC (Top View)

表 5-1. Pin Functions

PIN		TYPE	DESCRIPTION
NO.	NAME		
1	VDD1	High-side power	High-side power supply. ⁽¹⁾
2	INP	Analog input	Noninverting analog input. Either INP or INN must have a DC current path to GND1 to define the common-mode input voltage. ⁽²⁾
3	INN	Analog input	Inverting analog input. Either INP or INN must have a DC current path to GND1 to define the common-mode input voltage. ⁽²⁾
4	GND1	High-side ground	High-side analog ground.
5	GND2	Low-side ground	Low-side analog ground.
6	OUTN	Analog output	Inverting analog output.
7	OUTP	Analog output	Noninverting analog output.
8	VDD2	Low-side power	Low-side power supply. ⁽¹⁾

(1) See the [Power Supply Recommendations](#) section for power-supply decoupling recommendations.

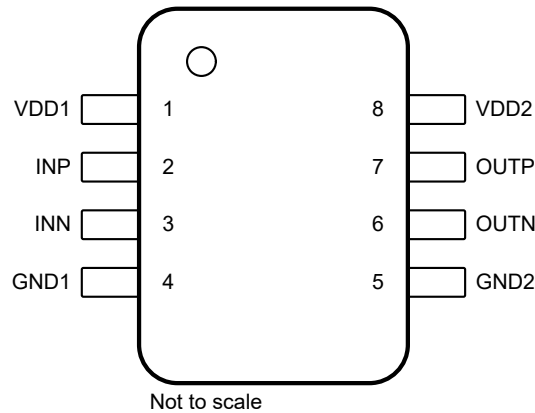
(2) See the [Layout](#) section for details.

6 Specifications

6.1 Absolute Maximum Ratings

see⁽¹⁾

		MIN	MAX	UNIT
Power-supply voltage	High-side VDD1 to GND1	- 0.3	7	V
	Low-side VDD2 to GND2	- 0.3	7	
Analog input voltage	INP, INN	GND1 - 6	VDD1 + 0.5	V
Input current	Continuous, any pin except power-supply pins	- 10	10	mA
Temperature	Junction, T _J		150	°C
	Storage, T _{stg}	- 65	150	

- (1) Operation outside the *Absolute Maximum Ratings* may cause permanent device damage. *Absolute Maximum Ratings* do not imply functional operation of the device at these or any other conditions beyond those listed under *Recommended Operating Conditions*. If used outside the Recommended Operating Conditions but within the Absolute Maximum Ratings, the device may not be fully functional, and this may affect device reliability, functionality, performance, and shorten the device lifetime

6.2 ESD Ratings

			VALUE	UNIT
V _(ESD)	Electrostatic discharge	Human-body model (HBM), per ANSI/ESDA/JEDEC JS-001 ⁽¹⁾	±2000	V
		Charged-device model (CDM), per ANSI/ESDA/JEDEC JS-002 ⁽²⁾	±1000	

- (1) JEDEC document JEP155 states that 500-V HBM allows safe manufacturing with a standard ESD control process.
(2) JEDEC document JEP157 states that 250-V CDM allows safe manufacturing with a standard ESD control process.

6.3 Recommended Operating Conditions

over operating ambient temperature range (unless otherwise noted)

			MIN	NOM	MAX	UNIT
POWER SUPPLY						
	High-side power supply	VDD1 to GND1	3	5	5.5	V
	Low-side power supply	VDD2 to GND2	3	3.3	5.5	V
ANALOG INPUT						
V _{Clipping}	Differential input voltage before clipping output	V _{IN} = V _{INP} - V _{INN}	±302.7			mV
V _{FSR}	Specified linear differential full-scale voltage	V _{IN} = V _{INP} - V _{INN}	- 250		250	mV
	Absolute common-mode input voltage ⁽¹⁾	(V _{INP} + V _{INN}) / 2 to GND1	- 2		VDD1	V
V _{CM}	Operating common-mode input voltage	(V _{INP} + V _{INN}) / 2 to GND1	- 0.16	VDD1 - 2.1		V
TEMPERATURE RANGE						
T _A	Specified ambient temperature	AMC1301	- 40		125	°C
		AMC1301S	- 55		125	

- (1) Steady-state voltage supported by the device in case of a system failure. See specified common-mode input voltage V_{CM} for normal operation. Observe analog input voltage range as specified in *Absolute Maximum Ratings* table.

6.4 Thermal Information

THERMAL METRIC ⁽¹⁾		DWV (SOIC)	UNIT
		8 PINS	
$R_{\theta JA}$	Junction-to-ambient thermal resistance	110.1	°C/W
$R_{\theta JC(top)}$	Junction-to-case (top) thermal resistance	51.7	°C/W
$R_{\theta JB}$	Junction-to-board thermal resistance	66.4	°C/W
Ψ_{JT}	Junction-to-top characterization parameter	16.0	°C/W
Ψ_{JB}	Junction-to-board characterization parameter	64.5	°C/W
$R_{\theta JC(bot)}$	Junction-to-case (bottom) thermal resistance	N/A	°C/W

(1) For more information about traditional and new thermal metrics, see the [Semiconductor and IC Package Thermal Metrics](#) application report.

6.5 Power Ratings

PARAMETER	TEST CONDITIONS	VALUE	UNIT
P_D	Maximum power dissipation (both sides) VDD1 = VDD2 = 5.5 V	99	mW
P_{D1}	Maximum power dissipation (high-side) VDD1 = 3.6 V	31	mW
		VDD1 = 5.5 V	
P_{D2}	Maximum power dissipation (low-side) VDD2 = 3.6 V	26	mW
		VDD2 = 5.5 V	

6.6 Insulation Specifications

over operating ambient temperature range (unless otherwise noted)

PARAMETER		TEST CONDITIONS	VALUE	UNIT
GENERAL				
CLR	External clearance ⁽¹⁾	Shortest pin-to-pin distance through air	≥ 8.5	mm
CPG	External creepage ⁽¹⁾	Shortest pin-to-pin distance across the package surface	≥ 8.5	mm
DTI	Distance through insulation	Minimum internal gap (internal clearance) of the double insulation	≥ 0.021	mm
CTI	Comparative tracking index	DIN EN 60112 (VDE 0303-11); IEC 60112	≥ 600	V
	Material group	According to IEC 60664-1	I	
	Overvoltage category per IEC 60664-1	Rated mains voltage $\leq 600 V_{RMS}$	I-IV	
		Rated mains voltage $\leq 1000 V_{RMS}$	I-III	
DIN EN IEC 60747-17 (VDE 0884-17)⁽²⁾				
V_{IORM}	Maximum repetitive peak isolation voltage	At AC voltage	1500	V_{PK}
V_{IOWM}	Maximum-rated isolation working voltage	At AC voltage (sine wave)	1000	V_{RMS}
		At DC voltage	1500	V_{DC}
V_{IOTM}	Maximum transient isolation voltage	$V_{TEST} = V_{IOTM}$, $t = 60$ s (qualification test), $V_{TEST} = 1.2 \times V_{IOTM}$, $t = 1$ s (100% production test)	7000	V_{PK}
V_{IMP}	Maximum impulse voltage ⁽²⁾	Tested in air, 1.2/50- μ s waveform per IEC 62368-1	7700	V_{PK}
V_{IOSM}	Maximum surge isolation voltage ⁽³⁾	Tested in oil (qualification test), 1.2/50- μ s waveform per IEC 62368-1	10000	V_{PK}
q_{pd}	Apparent charge ⁽⁵⁾	Method a, after input/output safety test subgroups 2 and 3, $V_{pd(ini)} = V_{IOTM}$, $t_{ini} = 60$ s, $V_{pd(m)} = 1.2 \times V_{IORM}$, $t_m = 10$ s	≤ 5	pC
		Method a, after environmental tests subgroup 1, $V_{pd(ini)} = V_{IOTM}$, $t_{ini} = 60$ s, $V_{pd(m)} = 1.6 \times V_{IORM}$, $t_m = 10$ s	≤ 5	
		Method b1, at preconditioning (type test) and routine test, $V_{pd(ini)} = 1.2 \times V_{IOTM}$, $t_{ini} = 1$ s, $V_{pd(m)} = 1.875 \times V_{IORM}$, $t_m = 1$ s	≤ 5	
		Method b2, at routine test (100% production) ⁽⁷⁾ , $V_{pd(ini)} = V_{pd(m)} = 1.2 \times V_{IOTM}$, $t_{ini} = t_m = 1$ s	≤ 5	
C_{IO}	Barrier capacitance, input to output ⁽⁵⁾	$V_{IO} = 0.5 V_{PP}$ at 1 MHz	~ 1.2	pF
R_{IO}	Insulation resistance, input to output ⁽⁵⁾	$V_{IO} = 500$ V at $T_A = 25^\circ\text{C}$	$> 10^{12}$	Ω
		$V_{IO} = 500$ V at $100^\circ\text{C} \leq T_A \leq 125^\circ\text{C}$	$> 10^{11}$	
		$V_{IO} = 500$ V at $T_S = 150^\circ\text{C}$	$> 10^9$	
	Pollution degree		2	
	Climatic category	AMC1301	40/125/21	
		AMC1301S	55/125/21	
UL1577				
V_{ISO}	Withstand isolation voltage	$V_{TEST} = V_{ISO}$, $t = 60$ s (qualification test), $V_{TEST} = 1.2 \times V_{ISO}$, $t = 1$ s (100% production test)	5000	V_{RMS}

- (1) Apply creepage and clearance requirements according to the specific equipment isolation standards of an application. Care must be taken to maintain the creepage and clearance distance of a board design to ensure that the mounting pads of the isolator on the printed circuit board (PCB) do not reduce this distance. Creepage and clearance on a PCB become equal in certain cases. Techniques such as inserting grooves, ribs, or both on a PCB are used to help increase these specifications.
- (2) Testing is carried out in air to determine the surge immunity of the package.
- (3) Testing is carried in oil to determine the intrinsic surge immunity of the isolation barrier.
- (4) Apparent charge is electrical discharge caused by a partial discharge (pd).
- (5) All pins on each side of the barrier are tied together, creating a two-pin device.
- (6) Either method b1 or b2 is used in production.

6.7 Safety-Related Certifications

VDE	UL
DIN EN IEC 60747-17 (VDE 0884-17), EN IEC 60747-17, DIN EN IEC 62368-1 (VDE 0868-1), EN IEC 62368-1, IEC 62368-1 Clause : 5.4.3 ; 5.4.4.4 ; 5.4.9	Recognized under 1577 component recognition program
Reinforced insulation	Single protection
Certificate number: 40040142	File number: E181974

6.8 Safety Limiting Values

Safety limiting⁽¹⁾ intends to minimize potential damage to the isolation barrier upon failure of input or output circuitry. A failure of the I/O can allow low resistance to ground or the supply and, without current limiting, dissipate sufficient power to over-heat the die and damage the isolation barrier potentially leading to secondary system failures.

PARAMETER		TEST CONDITIONS	MIN	TYP	MAX	UNIT
I _S	Safety input, output, or supply current	R _{θJA} = 110.1°C/W, VDDx = 5.5 V, T _J = 150°C, T _A = 25°C			206	mA
I _S	Safety input, output, or supply current	R _{θJA} = 110.1°C/W, VDDx = 3.6 V, T _J = 150°C, T _A = 25°C			315	mA
P _S	Safety input, output, or total power	R _{θJA} = 110.1°C/W, T _J = 150°C, T _A = 25°C			1135	mW
T _S	Maximum safety temperature				150	°C

- (1) The maximum safety temperature, T_S, has the same value as the maximum junction temperature, T_J, specified for the device. The I_S and P_S parameters represent the safety current and safety power, respectively. Do not exceed the maximum limits of I_S and P_S. These limits vary with the ambient temperature, T_A.

The junction-to-air thermal resistance, R_{θJA}, in the Thermal Information table is that of a device installed on a high-K test board for leaded surface-mount packages. Use these equations to calculate the value for each parameter:

$T_J = T_A + R_{\theta JA} \times P$, where P is the power dissipated in the device.

$T_{J(max)} = T_S = T_A + R_{\theta JA} \times P_S$, where T_{J(max)} is the maximum junction temperature.

$P_S = I_S \times VDD_{max}$, where VDD_{max} is the maximum supply voltage for high-side and low-side.

6.9 Electrical Characteristics

minimum and maximum specifications apply from $T_A = -40^\circ\text{C}$ to $+125^\circ\text{C}$ (for AMC1301S: $T_A = -55^\circ\text{C}$ to $+125^\circ\text{C}$), $V_{DD1} = 3.0\text{ V}$ to 5.5 V , $V_{DD2} = 3.0\text{ V}$ to 5.5 V , $I_{NP} = -250\text{ mV}$ to $+250\text{ mV}$, and $I_{NN} = \text{GND1}$; typical specifications are at $T_A = 25^\circ\text{C}$, $V_{DD1} = 5\text{ V}$, and $V_{DD2} = 3.3\text{ V}$ (unless otherwise noted)

PARAMETER		TEST CONDITIONS	MIN	TYP	MAX	UNIT
ANALOG INPUT						
V_{CMov}	Common-mode overvoltage detection level	$(V_{INP} + V_{INN}) / 2$ to GND1	$V_{DD1} - 2$			V
	Hysteresis of common-mode overvoltage detection level		60			mV
V_{OS}	Input offset voltage ⁽¹⁾	Initial, at $T_A = 25^\circ\text{C}$, $I_{NP} = I_{NN} = \text{GND1}$	-0.2	± 0.05	0.2	mV
TCV_{OS}	Input offset drift ^{(1) (4)}	AMC1301	-3	± 1	3	$\mu\text{V}/^\circ\text{C}$
		AMC1301S	-4	± 1	4	
CMRR	Common-mode rejection ratio	$f_{IN} = 0\text{ Hz}$, $V_{CM\ min} \leq V_{CM} \leq V_{CM\ max}$	-93			dB
		$f_{IN} = 10\text{ kHz}$, $V_{CM\ min} \leq V_{CM} \leq V_{CM\ max}$	-93			
R_{IN}	Single-ended input resistance	$I_{NN} = \text{GND1}$	18			$\text{k}\Omega$
R_{IND}	Differential input resistance		22			$\text{k}\Omega$
I_{IB}	Input bias current	$I_{NP} = I_{NN} = \text{GND1}$; $I_{IB} = (I_{IBP} + I_{IBN}) / 2$	-41	-30	-24	μA
TCI_{IB}	Input bias current drift		1			$\text{nA}/^\circ\text{C}$
C_{IND}	Differential input capacitance		1			pF
ANALOG OUTPUT						
	Nominal gain		8.2			V/V
E_G	Gain error ⁽¹⁾	at $T_A = 25^\circ\text{C}$	-0.3%	$\pm 0.05\%$	0.3%	
TCE_G	Gain drift ^{(1) (5)}	AMC1301	-50	± 15	50	ppm/ $^\circ\text{C}$
		AMC1301S	-60	± 15	60	
	Nonlinearity ⁽¹⁾		-0.03%	$\pm 0.01\%$	0.03%	
	Nonlinearity drift		± 1			ppm/ $^\circ\text{C}$
THD	Total harmonic distortion ⁽³⁾	$f_{IN} = 10\text{ kHz}$	-87			dB
	Output noise	$I_{NP} = I_{NN} = \text{GND1}$, $f_{IN} = 0\text{ Hz}$, BW = 100 kHz brickwall filter	220			μV_{RMS}
SNR	Signal-to-noise ratio	$f_{IN} = 1\text{ kHz}$, BW = 10 kHz	80	84		dB
		$f_{IN} = 10\text{ kHz}$, BW = 100 kHz	71			
PSRR	Power-supply rejection ratio ⁽²⁾	PSRR vs V_{DD1} , at DC	-94			dB
		PSRR vs V_{DD1} , 100-mV and 10-kHz ripple	-90			
		PSRR vs V_{DD2} , at DC	-100			
		PSRR vs V_{DD2} , 100-mV and 10-kHz ripple	-94			
V_{CMout}	Common-mode output voltage		1.39	1.44	1.49	V
$V_{CLIPout}$	Clipping differential output voltage	$V_{OUT} = (V_{OUTP} - V_{OUTN})$; $ V_{IN} = V_{INP} - V_{INN} > V_{Clipping} $	-2.52	± 2.49	2.52	V
$V_{Failsafe}$	Failsafe differential output voltage	$V_{CM} \geq V_{CMov}$, or V_{DD1} missing	-2.563 - 2.545			V
BW	Output bandwidth		190	210		kHz
R_{OUT}	Output resistance	On OUTP or OUTN	< 0.2			Ω
	Output short-circuit current	On OUTP or OUTN, sourcing or sinking, $I_{NN} = I_{NP} = \text{GND1}$, outputs shorted to either GND2 or V_{DD2}	13			mA
CMTI	Common-mode transient immunity	$ GND1 - GND2 = 1\text{ kV}$	15			$\text{kV}/\mu\text{s}$

6.9 Electrical Characteristics (continued)

minimum and maximum specifications apply from $T_A = -40^\circ\text{C}$ to $+125^\circ\text{C}$ (for AMC1301S: $T_A = -55^\circ\text{C}$ to $+125^\circ\text{C}$), $V_{DD1} = 3.0\text{ V}$ to 5.5 V , $V_{DD2} = 3.0\text{ V}$ to 5.5 V , $\text{INP} = -250\text{ mV}$ to $+250\text{ mV}$, and $\text{INN} = \text{GND1}$; typical specifications are at $T_A = 25^\circ\text{C}$, $V_{DD1} = 5\text{ V}$, and $V_{DD2} = 3.3\text{ V}$ (unless otherwise noted)

PARAMETER		TEST CONDITIONS	MIN	TYP	MAX	UNIT
POWER SUPPLY						
IDD1	High-side supply current	$3.0\text{ V} \leq V_{DD1} \leq 3.6\text{ V}$		6.3	8.5	mA
		$4.5\text{ V} \leq V_{DD1} \leq 5.5\text{ V}$		7.2	9.8	
IDD2	Low-side supply current	$3.0\text{ V} \leq V_{DD2} \leq 3.6\text{ V}$		5.3	7.2	mA
		$4.5\text{ V} \leq V_{DD2} \leq 5.5\text{ V}$		5.9	8.1	

- (1) The typical value includes one standard deviation (σ) at nominal operating conditions.
- (2) This parameter is input referred.
- (3) THD is the ratio of the rms sum of the amplitudes of first five higher harmonics to the amplitude of the fundamental.
- (4) Offset error temperature drift is calculated using the box method, as described by the following equation:

$$TCV_{OS} = (V_{OS,MAX} - V_{OS,MIN}) / \text{TempRange}$$
 where $V_{OS,MAX}$ and $V_{OS,MIN}$ refer to the maximum and minimum V_{OS} values measured within the temperature range (-40 to 125°C).
- (5) Gain error temperature drift is calculated using the box method, as described by the following equation:

$$TCE_G (\text{ppm}) = ((E_{G,MAX} - E_{G,MIN}) / \text{TempRange}) \times 10^4$$
 where $E_{G,MAX}$ and $E_{G,MIN}$ refer to the maximum and minimum E_G values (in %) measured within the temperature range (-40 to 125°C).

6.10 Switching Characteristics

over operating ambient temperature range (unless otherwise noted)

PARAMETER		TEST CONDITIONS	MIN	TYP	MAX	UNIT
t_r	Output signal rise time			2.0		μs
t_f	Output signal fall time			2.0		μs
	V_{INx} to V_{OUTx} signal delay (50% - 10%)	Unfiltered output		0.7	2.0	μs
	V_{INx} to V_{OUTx} signal delay (50% - 50%)	Unfiltered output		1.6	2.6	μs
	V_{INx} to V_{OUTx} signal delay (50% - 90%)	Unfiltered output		2.5	3	μs

6.11 Timing Diagram



图 6-1. Rise, Fall, and Delay Time Definition

6.12 Insulation Characteristics Curves



图 6-2. Thermal Derating Curve for Safety-Limiting Current per VDE

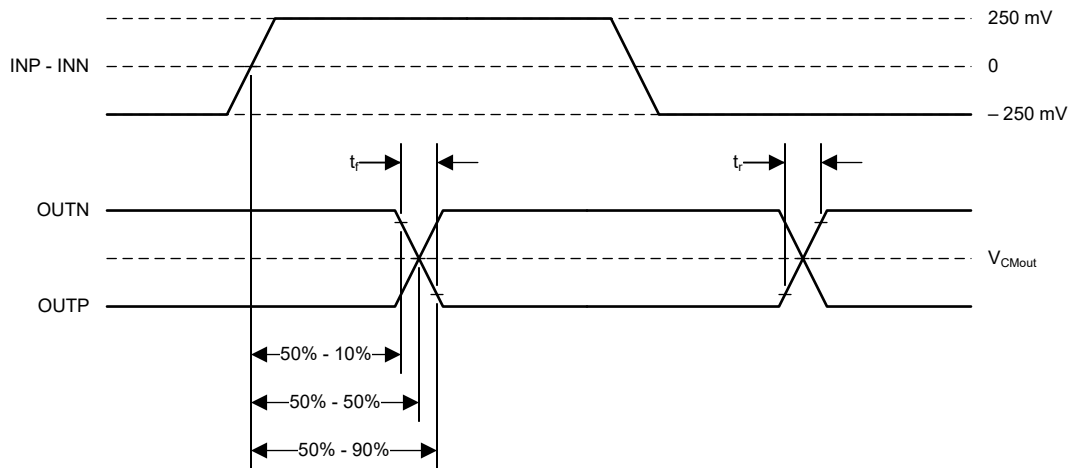

图 6-3. Thermal Derating Curve for Safety-Limiting Power per VDE

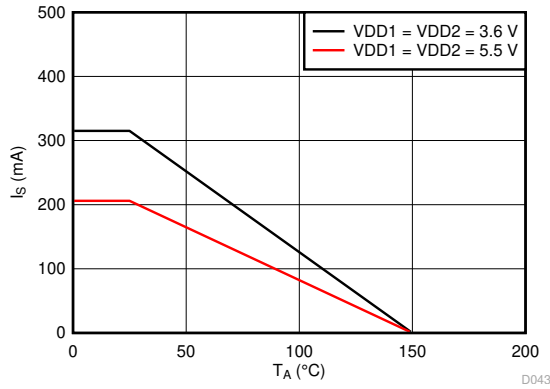

T_A up to 150°C, stress voltage frequency = 60 Hz

图 6-4. Reinforced Isolation Capacitor Lifetime Projection

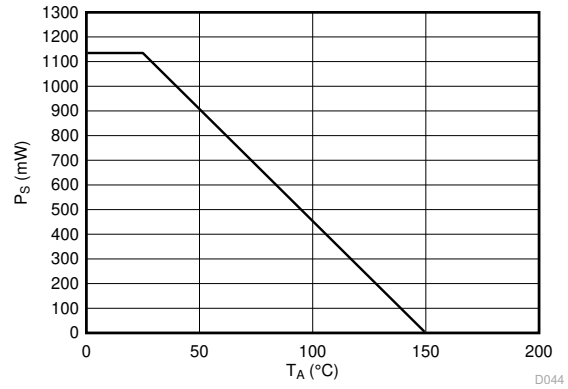
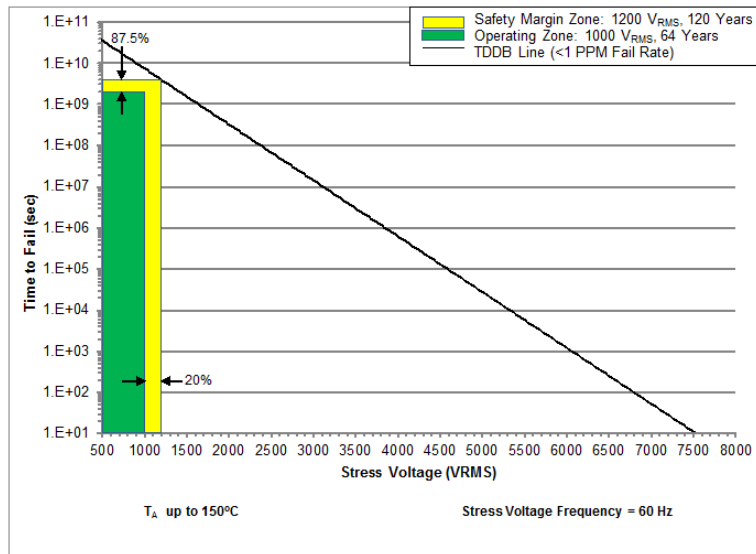
6.13 Typical Characteristics

at VDD1 = 5 V, VDD2 = 3.3 V, INP = - 250 mV to 250 mV, INN = 0 V, and $f_{IN} = 10$ kHz (unless otherwise noted)



图 6-5. Common-Mode Overvoltage Detection Level vs High-Side Supply Voltage



- 55°C ≤ T_A < 40°C valid for the AMC1301S only

图 6-6. Common-Mode Overvoltage Detection Level vs Temperature

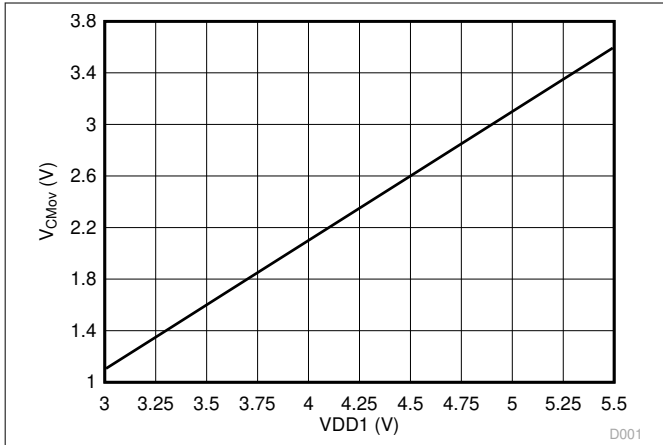
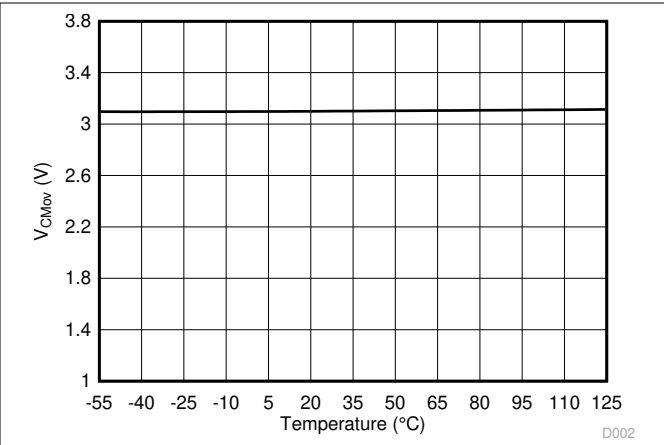

图 6-7. Input Offset Voltage Histogram



图 6-8. Input Offset Voltage Histogram

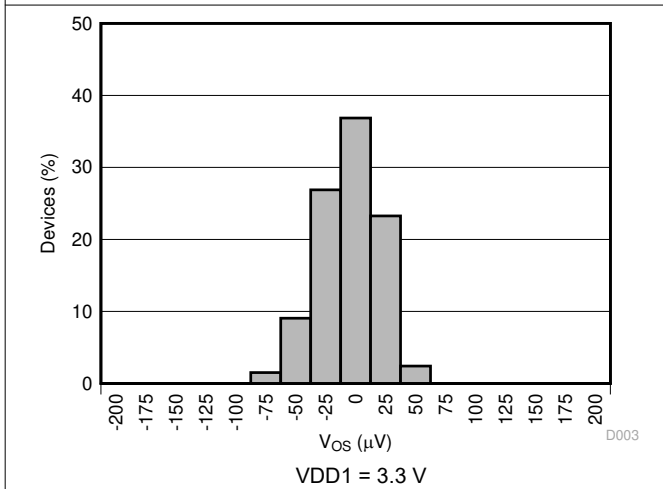

图 6-9. Input Offset Voltage vs Supply Voltage

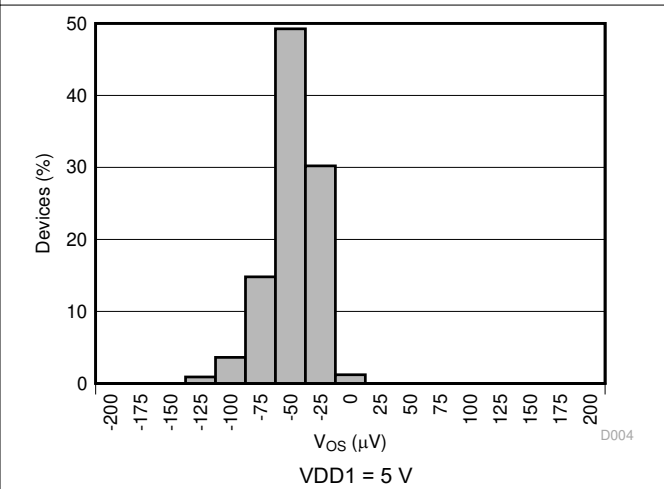

- 55°C ≤ T_A < 40°C valid for the AMC1301S only

图 6-10. Input Offset Voltage vs Temperature

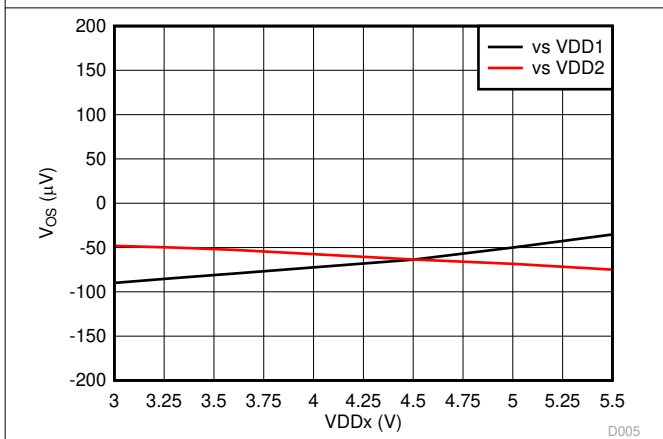
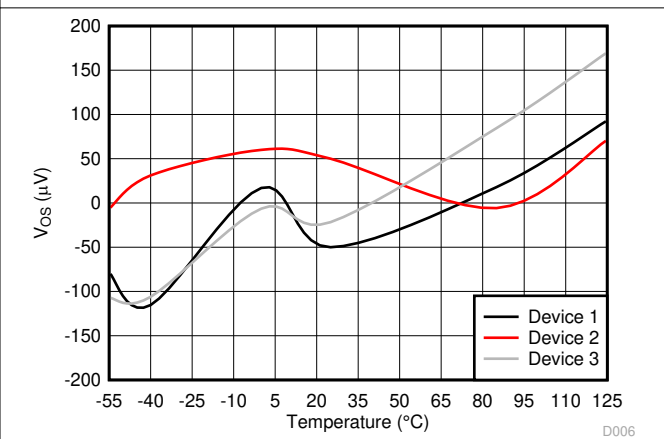
6.13 Typical Characteristics (continued)

at VDD1 = 5 V, VDD2 = 3.3 V, INP = -250 mV to 250 mV, INN = 0 V, and $f_{IN} = 10$ kHz (unless otherwise noted)



图 6-11. Input Offset Drift Histogram



图 6-12. Input Offset Drift Histogram

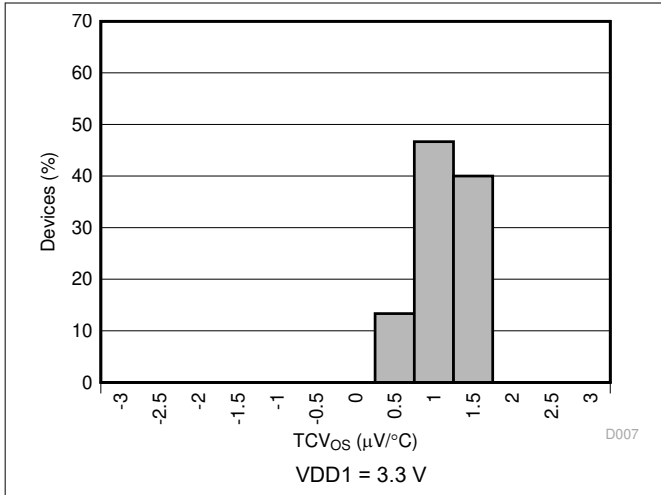

图 6-13. Common-Mode Rejection Ratio vs Input Frequency

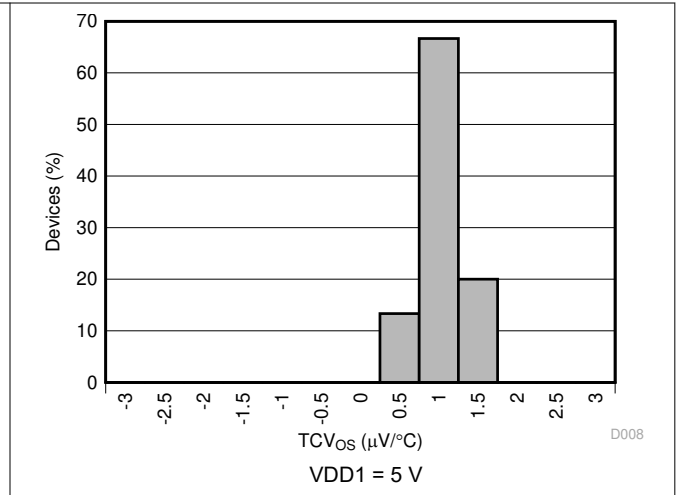

图 6-14. Common-Mode Rejection Ratio vs Temperature

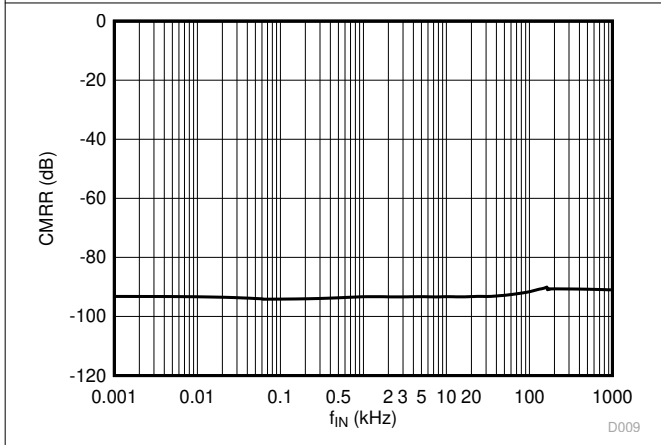

图 6-15. Input Bias Current vs Common-Mode Input Voltage

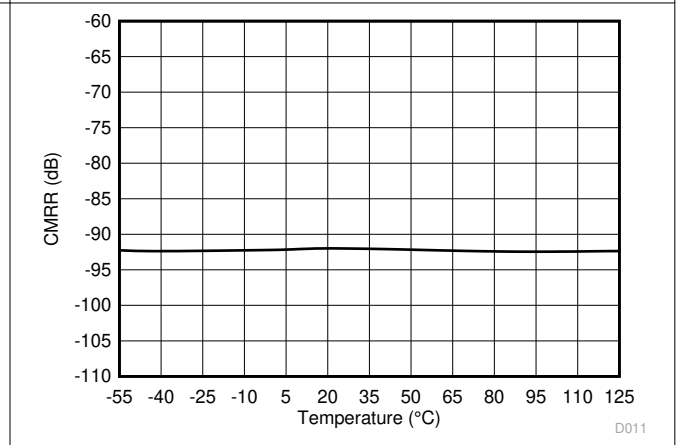

图 6-16. Input Bias Current vs High-Side Supply Voltage

6.13 Typical Characteristics (continued)

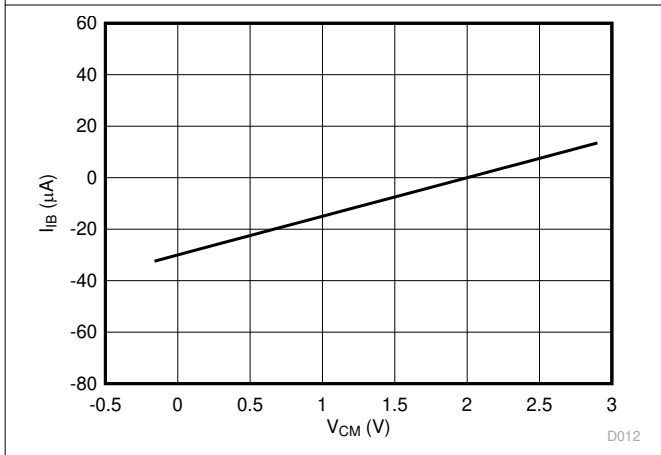
at VDD1 = 5 V, VDD2 = 3.3 V, INP = - 250 mV to 250 mV, INN = 0 V, and $f_{IN} = 10$ kHz (unless otherwise noted)

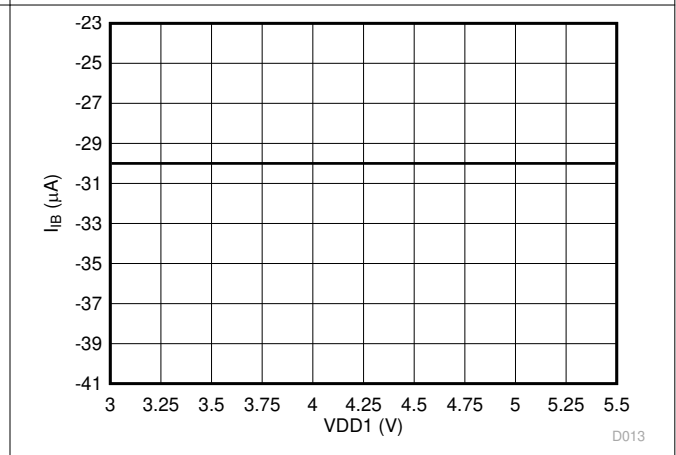
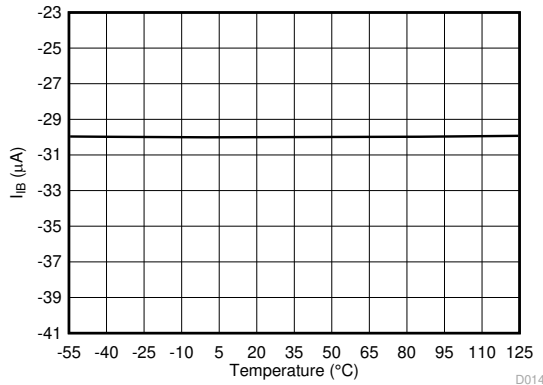

- 55°C ≤ T_A < 40°C valid for the AMC1301S only

图 6-17. Input Bias Current vs Temperature



图 6-18. Normalized Gain vs Input Frequency



图 6-19. Gain Error Histogram

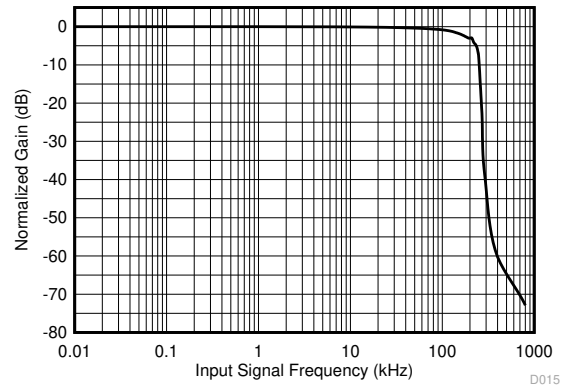

图 6-20. Gain Error Histogram

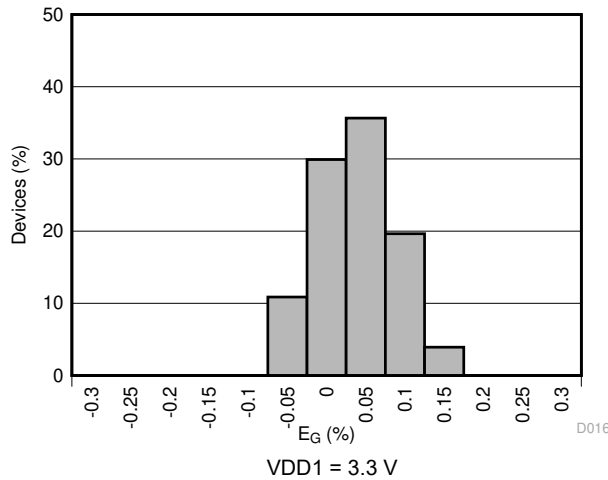

图 6-21. Gain Error vs Supply Voltage

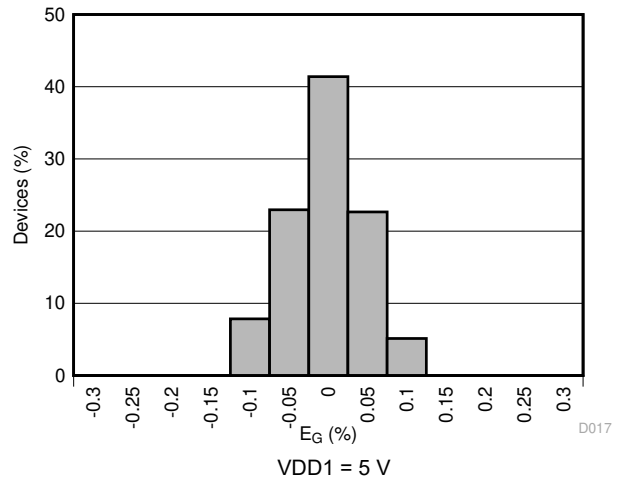

- 55°C ≤ T_A < 40°C valid for the AMC1301S only

图 6-22. Gain Error vs Temperature

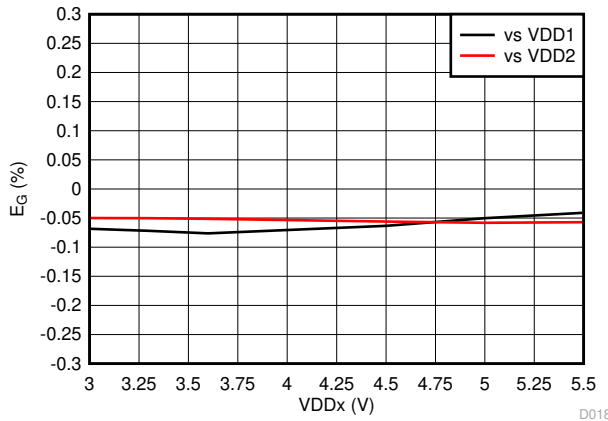
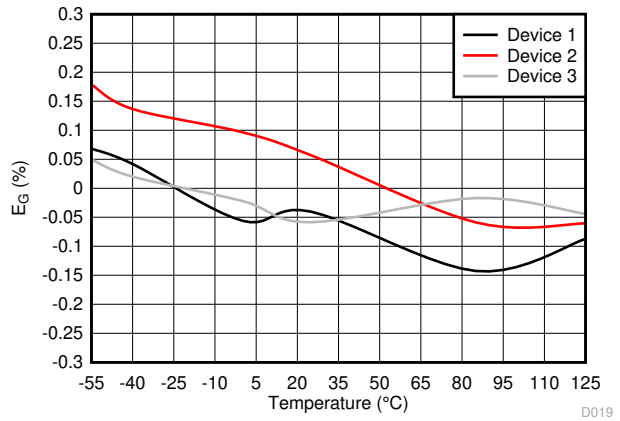
6.13 Typical Characteristics (continued)

at VDD1 = 5 V, VDD2 = 3.3 V, INP = - 250 mV to 250 mV, INN = 0 V, and f_{IN} = 10 kHz (unless otherwise noted)

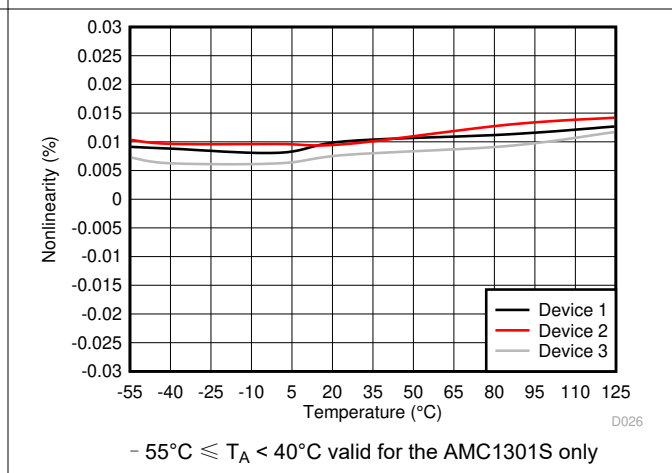
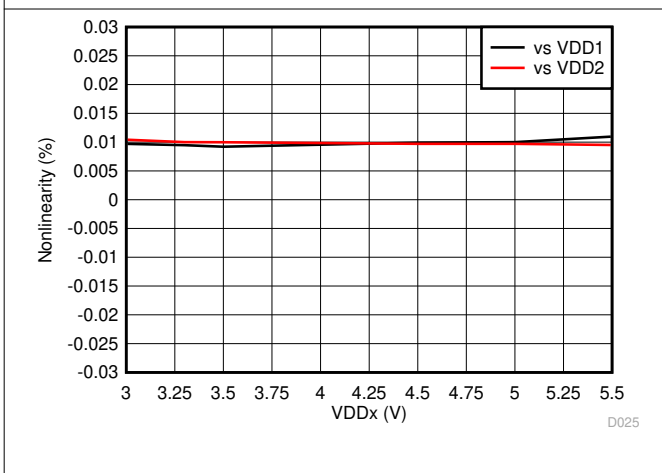
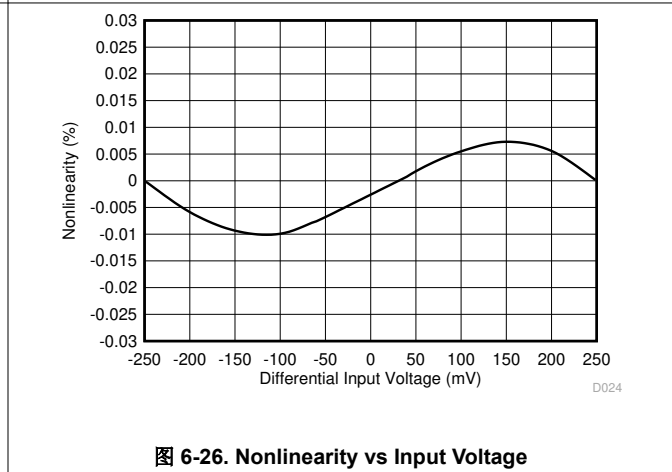
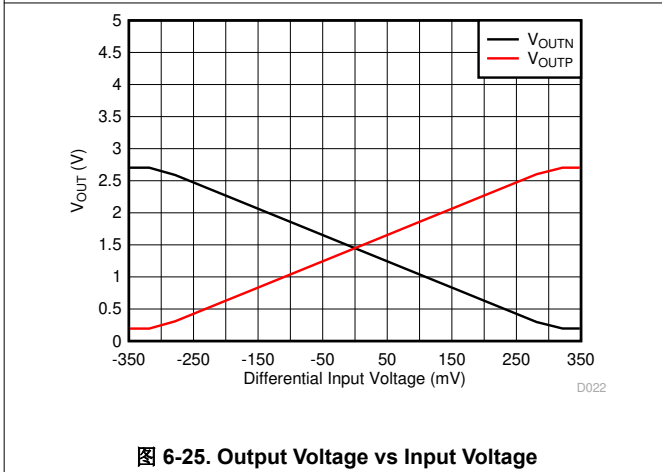
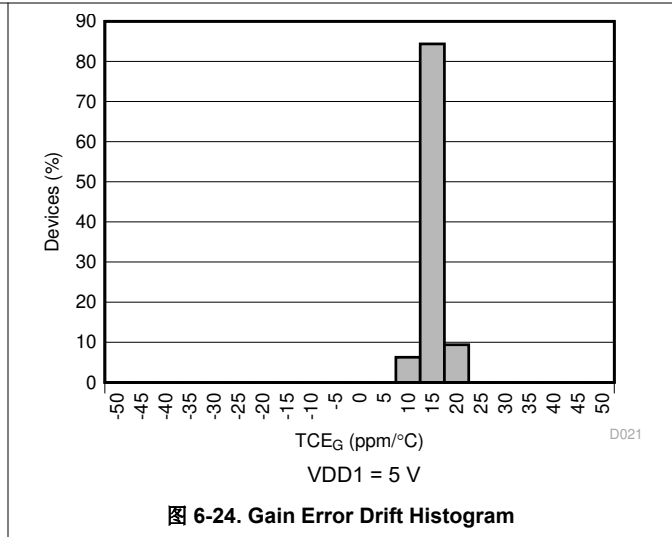
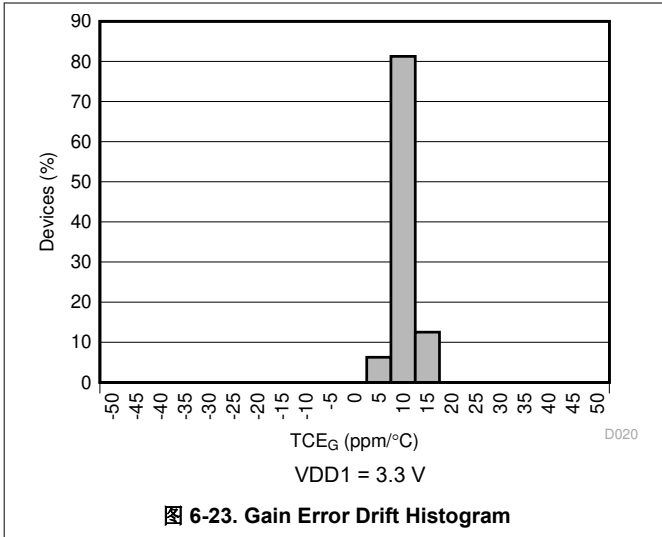

6.13 Typical Characteristics (continued)

at VDD1 = 5 V, VDD2 = 3.3 V, INP = - 250 mV to 250 mV, INN = 0 V, and $f_{IN} = 10$ kHz (unless otherwise noted)



图 6-29. Total Harmonic Distortion vs Supply Voltage



图 6-30. Total Harmonic Distortion vs Temperature

- 55°C ≤ T_A < 40°C valid for the AMC1301S only

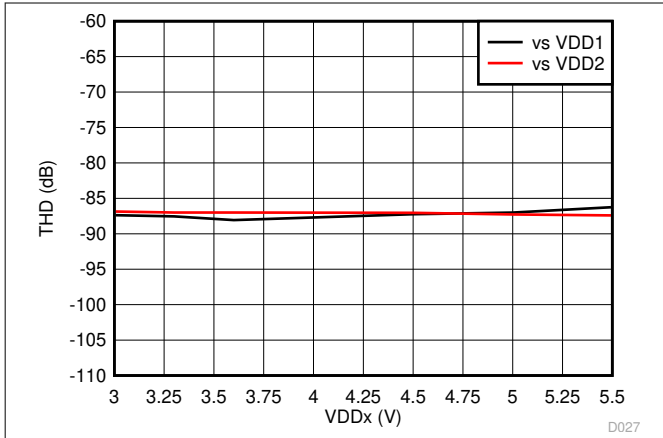

图 6-31. Signal-to-Noise Ratio vs Input Voltage

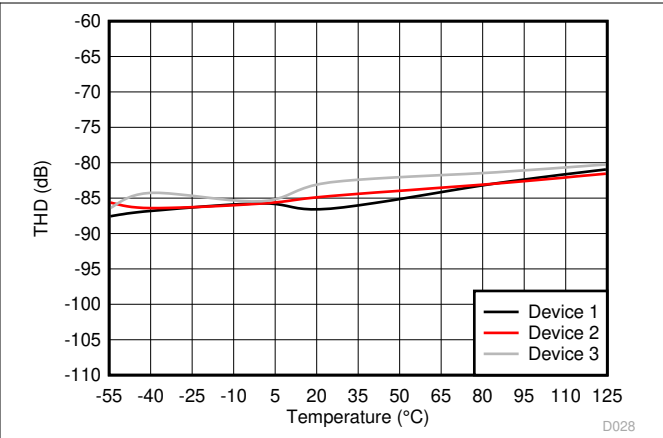

图 6-32. Signal-to-Noise Ratio vs Supply Voltage

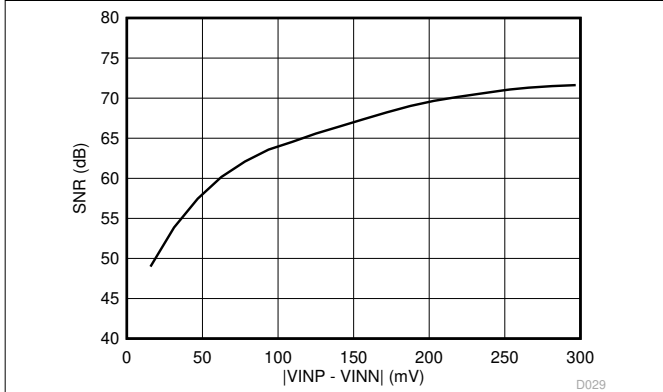

图 6-33. Signal-to-Noise Ratio vs Temperature

- 55°C ≤ T_A < 40°C valid for the AMC1301S only

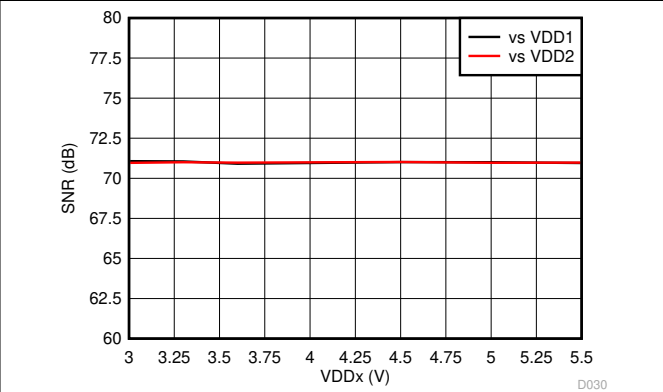

图 6-34. Input-Referred Noise Density vs Frequency

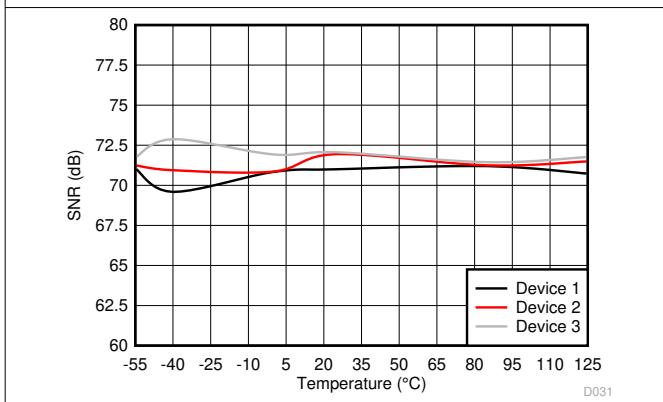
6.13 Typical Characteristics (continued)

at VDD1 = 5 V, VDD2 = 3.3 V, INP = -250 mV to 250 mV, INN = 0 V, and $f_{IN} = 10$ kHz (unless otherwise noted)

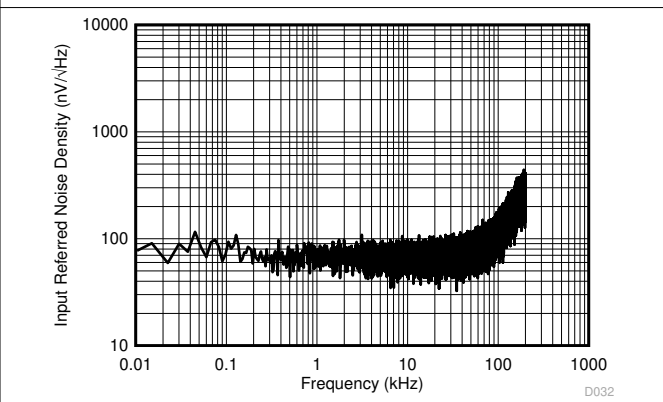

图 6-35. Power-Supply Rejection Ratio vs Ripple Frequency



图 6-36. Power-Supply Rejection Ratio vs Ripple Frequency

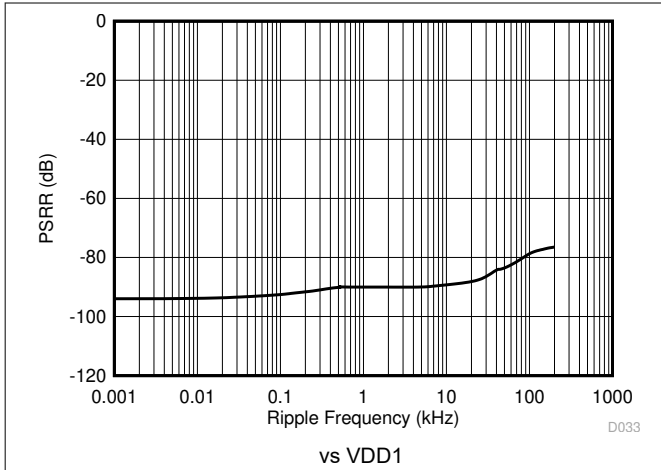

图 6-37. Output Rise and Fall Time vs Temperature

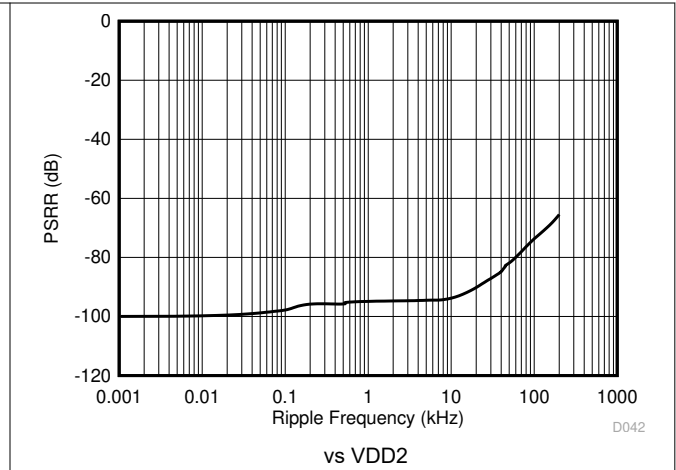

图 6-38. V_{IN} to V_{OUT} Signal Delay vs Low-Side Supply Voltage

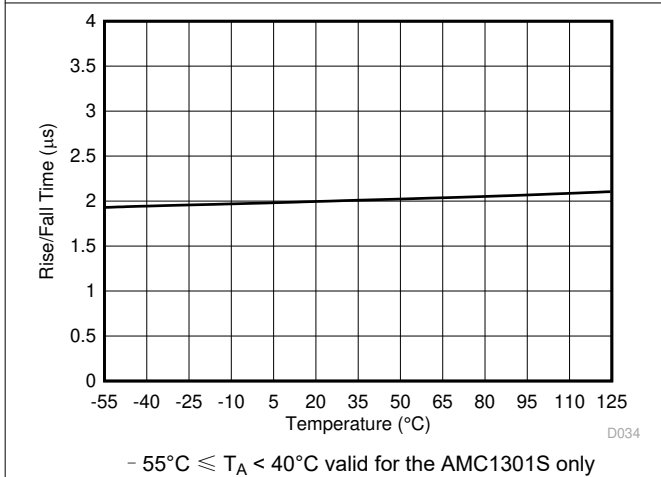

图 6-39. V_{IN} to V_{OUT} Signal Delay vs Temperature

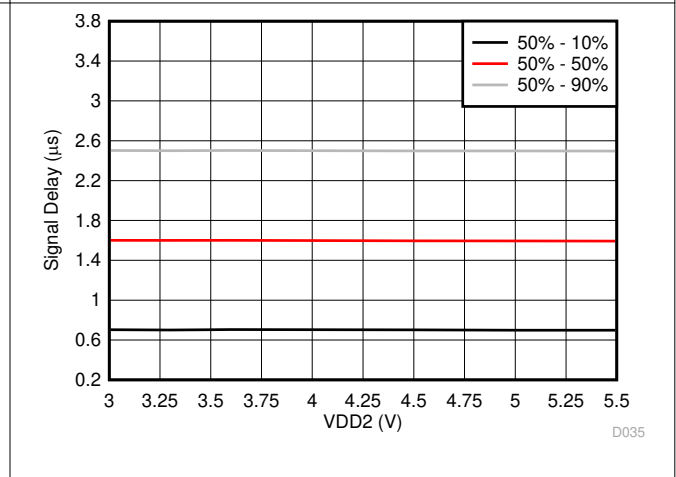

图 6-40. Output Common-Mode Voltage vs Low-Side Supply Voltage

6.13 Typical Characteristics (continued)

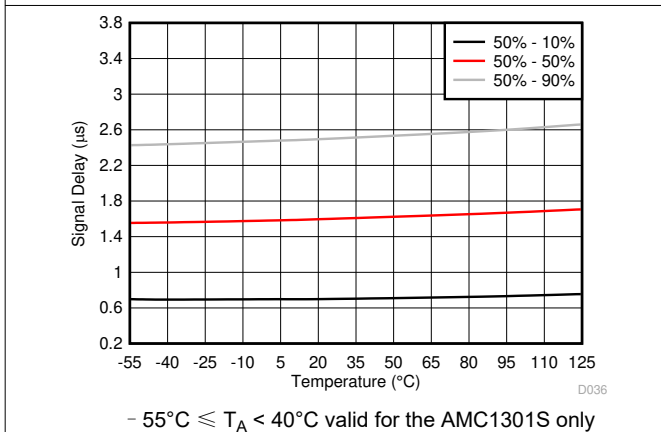
at VDD1 = 5 V, VDD2 = 3.3 V, INP = - 250 mV to 250 mV, INN = 0 V, and $f_{IN} = 10$ kHz (unless otherwise noted)

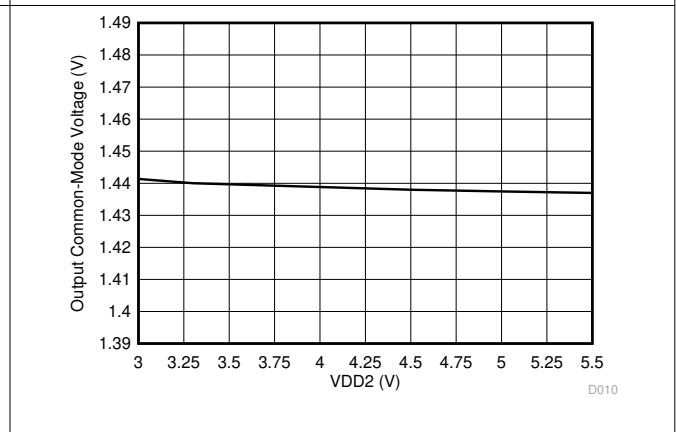
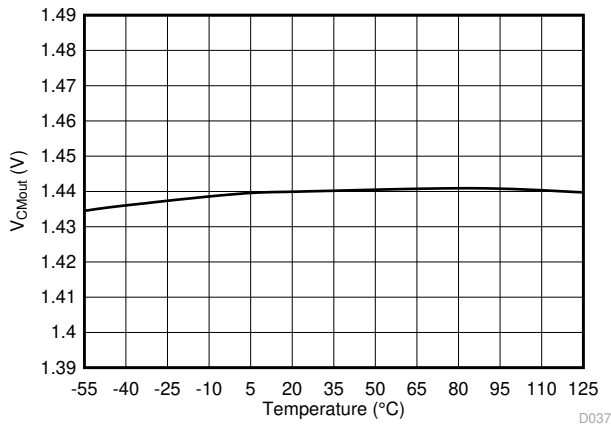

- 55°C ≤ T_A < 40°C valid for the AMC1301S only

图 6-41. Output Common-Mode Voltage vs Temperature



图 6-42. Output Bandwidth vs Low-Side Supply Voltage



- 55°C ≤ T_A < 40°C valid for the AMC1301S only

图 6-43. Output Bandwidth vs Temperature

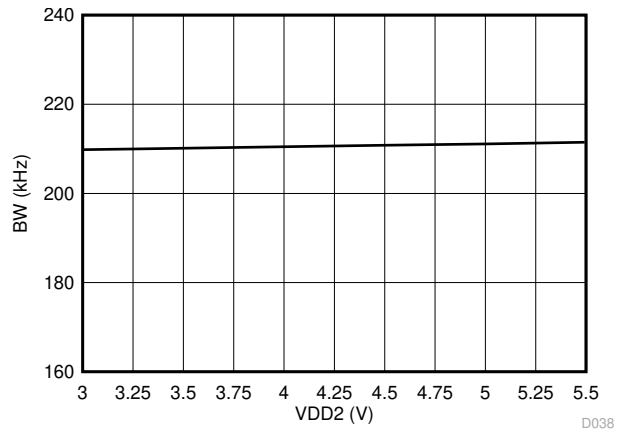
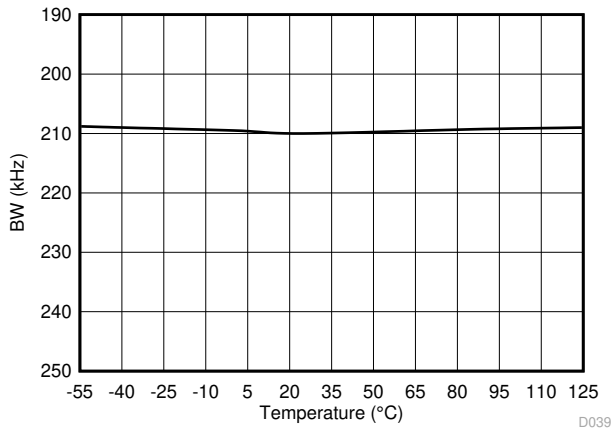

图 6-44. Supply Current vs Supply Voltage



- 55°C ≤ T_A < 40°C valid for the AMC1301S only

图 6-45. Supply Current vs Temperature

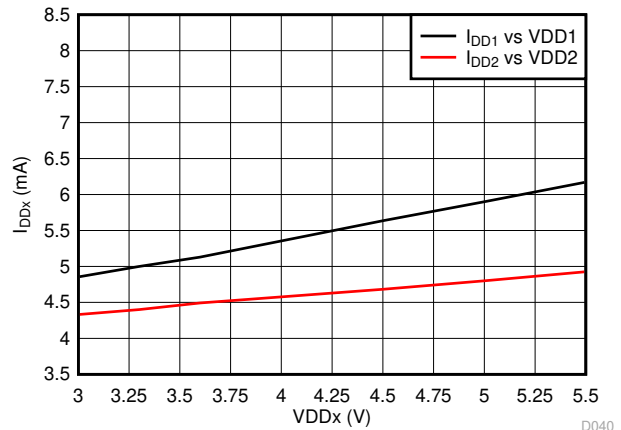
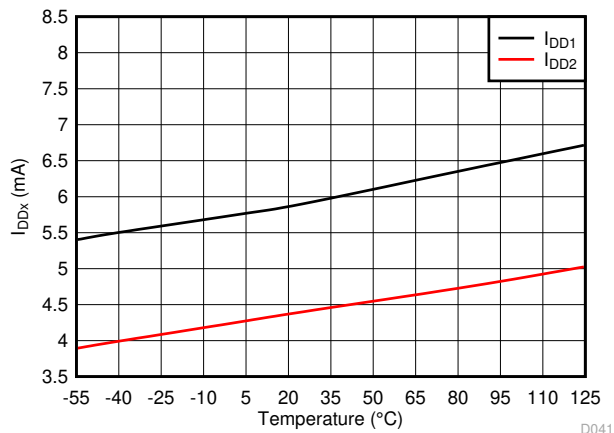
7 Detailed Description

7.1 Overview

The AMC1301 is a fully differential, precision, isolated amplifier. The input stage of the device consists of a fully differential amplifier that drives a second-order, delta-sigma ($\Delta \Sigma$) modulator. The modulator converts the analog input signal into a digital bitstream that is transferred across the isolation barrier that separates the high-side from the low-side. On the low-side, the received bitstream is processed by a fourth-order analog filter that outputs a differential signal at the OUTP and OUTN pins that is proportional to the input signal.

The SiO₂-based, capacitive isolation barrier supports a high level of magnetic field immunity, as described in the [ISO72x Digital Isolator Magnetic-Field Immunity application note](#). The digital modulation used in the AMC1301 to transmit data across the isolation barrier, and the isolation barrier characteristics, result in high reliability and common-mode transient immunity.

7.2 Functional Block Diagram

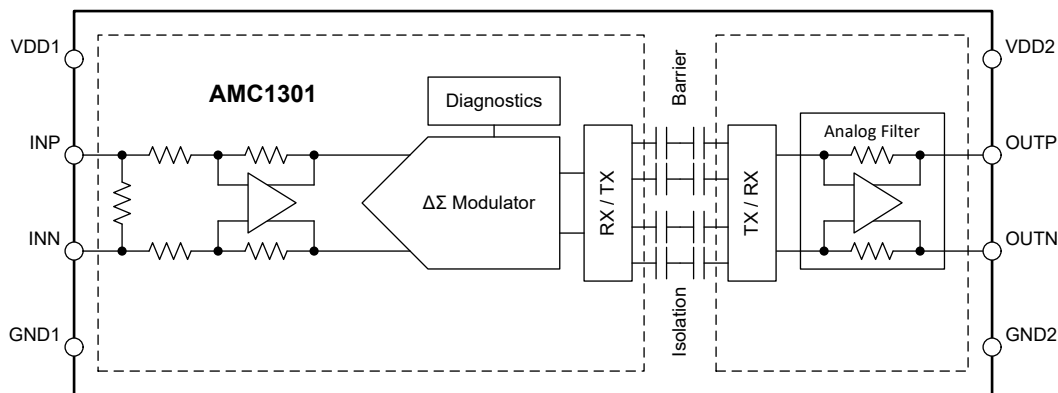

7.3 Feature Description

7.3.1 Analog Input

The differential amplifier input stage of the AMC1301 feeds a second-order, switched-capacitor, feed-forward $\Delta \Sigma$ modulator. The gain of the differential amplifier is set by internal precision resistors with a differential input impedance of R_{IND} . The modulator converts the analog input signal into a bitstream that is transferred across the isolation barrier, as described in the [Isolation Channel Signal Transmission](#) section.

There are two restrictions on the analog input signals (INP and INN). First, if the input voltages V_{INP} or V_{INN} exceed the range specified in the [Absolute Maximum Ratings](#) table, the input currents must be limited to the absolute maximum value, because the electrostatic discharge (ESD) protection turns on. In addition, the linearity and parametric performance of the device are ensured only when the analog input voltage remains within the linear full-scale range (V_{FSR}) and within the common-mode input voltage range (V_{CM}), as specified in the [Recommended Operating Conditions](#) table.

7.3.2 Isolation Channel Signal Transmission

The AMC1301 uses an on-off keying (OOK) modulation scheme, as shown in [图 7-1](#), to transmit the modulator output bitstream across the SiO₂-based isolation barrier. The transmit driver (TX) shown in the [Functional Block Diagram](#) transmits an internally generated, high-frequency carrier across the isolation barrier to represent a digital *one* and does not send a signal to represent a digital *zero*. The nominal frequency of the carrier used inside the AMC1301 is 480 MHz.

The receiver (RX) on the other side of the isolation barrier recovers and demodulates the signal and provides the input to the fourth-order analog filter. The AMC1301 transmission channel is optimized to achieve the highest level of common-mode transient immunity (CMTI) and lowest level of radiated emissions caused by the high-frequency carrier and RX/TX buffer switching.



图 7-1. OOK-Based Modulation Scheme

7.3.3 Analog Output

The AMC1301 offers a differential analog output comprised of the OOUTP and OOUTN pins. For differential input voltages ($V_{INP} - V_{INN}$) in the range from -250 mV to 250 mV , the device provides a linear response with a nominal gain of 8.2. For example, for a differential input voltage of 250 mV , the differential output voltage ($V_{OOUTP} - V_{OOUTN}$) is 2.05 V . At zero input (INP shorted to INN), both pins output the same common-mode output voltage V_{CMOut} , as specified in the [Electrical Characteristics](#) table. For absolute differential input voltages greater than 250 mV but less than 320 mV , the differential output voltage continues to increase in magnitude but with reduced linearity performance. The outputs saturate at a differential output voltage of $V_{CLIPout}$, as shown in [Figure 7-2](#), if the differential input voltage exceeds the $V_{Clipping}$ value.

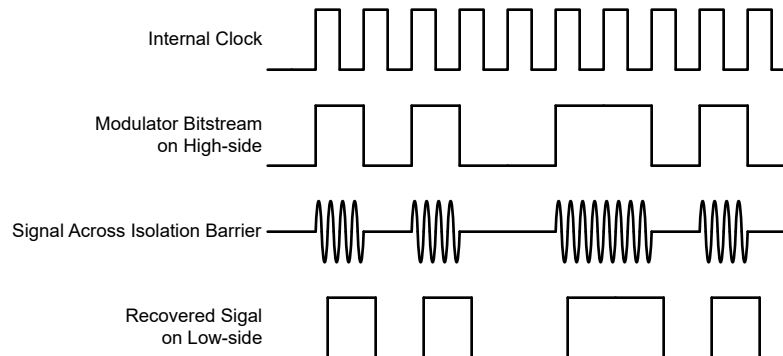

图 7-2. Output Behavior of the AMC1301

The AMC1301 offers a fail-safe feature that simplifies diagnostics on a system level. [Figure 7-2](#) shows the fail-safe mode, in which the AMC1301 outputs a negative differential output voltage that does not occur under normal operating conditions. The fail-safe output is active in two cases:

- When the high-side supply is missing or below the V_{DD1UV} threshold
- When the common-mode input voltage, that is $V_{CM} = (V_{INP} + V_{INN}) / 2$, exceeds the common-mode overvoltage detection level V_{CMov}

Use the maximum $V_{FAILSAFE}$ voltage specified in the [Electrical Characteristics](#) table as a reference value for fail-safe detection on a system level.

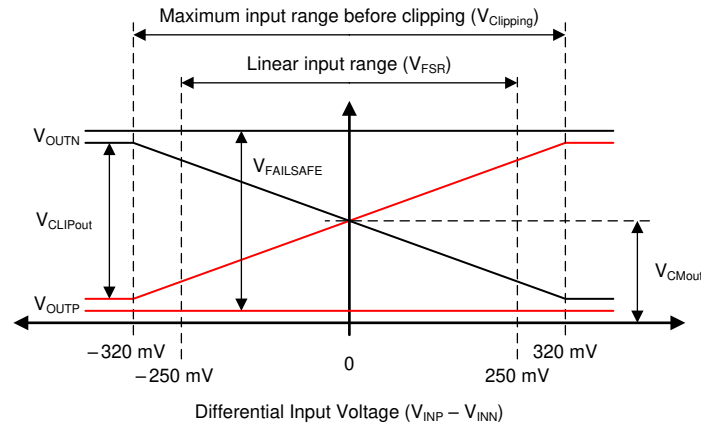
7.4 Device Functional Modes

The AMC1301 assumes normal operation as soon as V_{DD1} , V_{DD2} , and the input common-mode voltage (V_{CM}) are within the operational ranges, as specified in [Electrical Characteristics](#) table. In this mode, the output voltage is proportional to the input voltage.

The AMC1301 enters fail-safe mode whenever the high-side supply (V_{DD1}) is missing or the input common-mode voltage (V_{CM}) exceeds the specified input-overvoltage detection level V_{CMov} . In this mode, the differential output voltage is a fixed, negative value ($V_{FAILSAFE}$). See the [Analog Output](#) section for details.

8.2.1 Design Requirements

表 8-1 lists the parameters for this typical application.

表 8-1. Design Requirements

PARAMETER	VALUE
High-side supply voltage	3.3 V or 5 V
Low-side supply voltage	3.3 V or 5 V
Voltage drop across RSHUNT for a linear response	±250 mV (maximum)
Signal delay (50% V _{IN} to 90% OUTP, OUTN)	3 μs (maximum)

8.2.2 Detailed Design Procedure

In 图 8-1, the high-side power supply (VDD1) for the AMC1301 is derived from the floating power supply of the upper gate driver.

The floating ground reference (GND1) is derived from the end of the shunt resistor that is connected to the negative input of the AMC1301 (INN). If a four-pin shunt is used, the inputs of the AMC1301 are connected to the inner leads and GND1 is connected to the outer lead on the INN-side of the shunt. To minimize offset and improve accuracy, route the ground connection as a separate trace that connects directly to the shunt resistor rather than shorting GND1 to INN directly at the input to the device. See the [Layout](#) section for more details.

8.2.2.1 Shunt Resistor Sizing

Use Ohm's Law to calculate the voltage drop across the shunt resistor (V_{SHUNT}) for the desired measured current: V_{SHUNT} = I × RSHUNT.

Consider the following two restrictions when selecting the value of the shunt resistor, RSHUNT:

- The voltage drop caused by the nominal current range must not exceed the recommended differential input voltage range for a linear response: |V_{SHUNT}| ≤ |V_{FSR}|
- The voltage drop caused by the maximum allowed overcurrent must not exceed the input voltage that causes a clipping output: |V_{SHUNT}| ≤ |V_{Clipping}|

8.2.2.2 Input Filter Design

Place a differential RC filter (R1, R2, C5) in front of the isolated amplifier to improve signal-to-noise performance of the signal path. Design the input filter such that:

- The cutoff frequency of the filter is at least one order of magnitude lower than the sampling frequency of the ΔΣ modulator (20 MHz)
- The input bias current does not generate significant voltage drop across the DC impedances (R1, R2) of the input filter
- The impedances measured from the analog inputs are equal (R1 equals R2)

Capacitors C6 and C7 are optional and improve common-mode rejection at high frequencies (>1 MHz). For best performance, C6 must match the value of C7 and both capacitors must be 10 to 20 times lower in value than C5. For most applications, the structure shown in 图 8-2 achieves excellent performance.



图 8-2. Differential Input Filter

8.2.2.3 Differential to Single-Ended Output Conversion

图 8-3 shows an example of a TLV900x-based signal conversion and filter circuit for systems using single-ended input ADCs to convert the analog output voltage into digital. For $R1 = R3$ and $R2 = R4$, the output voltage equals $(R2 / R1) \times (V_{OUTP} - V_{OUTN}) + V_{REF}$. Tailor the bandwidth of this filter stage to the bandwidth requirement of the system and use NP0-type capacitors for best performance. For most applications, $R1 = R2 = R3 = R4 = 3.3 \text{ k}\Omega$ and $C1 = C2 = 330 \text{ pF}$ yields good performance.

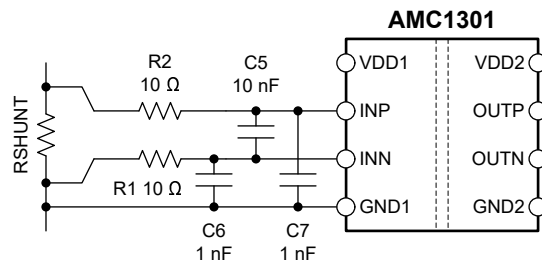

图 8-3. Connecting the AMC1301 Output to a Single-Ended Input ADC

For more information on the general procedure to design the filtering and driving stages of SAR ADCs, see the [18-Bit, 1MSPS Data Acquisition Block \(DAQ\) Optimized for Lowest Distortion and Noise](#) and [18-Bit Data Acquisition Block \(DAQ\) Optimized for Lowest Power](#) reference guides, available for download at www.ti.com.

8.2.3 Application Curve

One important aspect of power-stage design is the effective detection of an overcurrent condition to protect the switching devices and passive components from damage. To power off the system quickly in the event of an overcurrent condition, a low delay caused by the isolated amplifier is required. 图 8-4 shows the typical full-scale step response of the AMC1301.

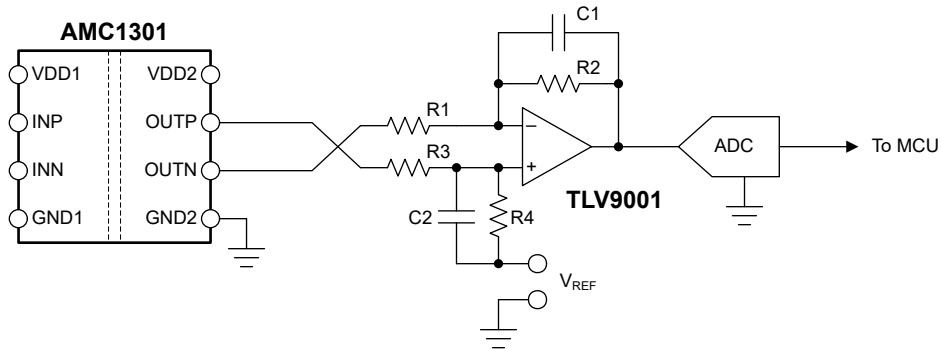

图 8-4. Step Response of the AMC1301

8.3 Best Design Practices

Do not leave the inputs of the AMC1301 unconnected (floating) when the device is powered up. If the device inputs are left floating, the input bias current can possibly drive the inputs to a positive value that exceeds the operating common-mode input voltage, thus causing the device to output the fail-safe voltage as described in the [Analog Output](#) section.

Connect the high-side ground (GND1) to INN, either by a hard short or through a resistive path. A DC current path between INN and GND1 is required to define the input common-mode voltage. Take care not to exceed the input common-mode range as specified in the [Recommended Operating Conditions](#) table. For best accuracy, route the ground connection as a separate trace that connects directly to the shunt resistor rather than shorting GND1 to INN directly at the input to the device. See the [Layout](#) section for more details.

8.4 Power Supply Recommendations

The AMC1301 does not require any specific power-up sequencing. The high-side power supply (AVDD) is decoupled with a low-ESR, 100-nF capacitor (C1) parallel to a low-ESR, 1- μ F capacitor (C2). The low-side power supply (DVDD) is equally decoupled with a low-ESR, 100-nF capacitor (C3) parallel to a low-ESR, 1- μ F capacitor (C4). Place all four capacitors (C1, C2, C3, and C4) as close to the device as possible.

The ground reference for the high-side (AGND) is derived from the end of the shunt resistor that is connected to the negative input (INN) of the device. For best DC accuracy, use a separate trace to make this connection instead of shorting AGND to INN directly at the device input. If a four-terminal shunt is used, the device inputs are connected to the inner leads and AGND is connected to the outer lead on the INN side of the shunt. [图 8-5](#) shows a decoupling diagram of the AMC1301.



图 8-5. Decoupling of the AMC1301

8.5 Layout

8.5.1 Layout Guidelines

图 8-6 shows a layout recommendation with the critical placement of the decoupling capacitors (as close as possible to the AMC1301 supply pins) and placement of the other components required by the device. For best performance, place the shunt resistor close to the INP and INN inputs of the AMC1301 and keep the layout of both connections symmetrical.

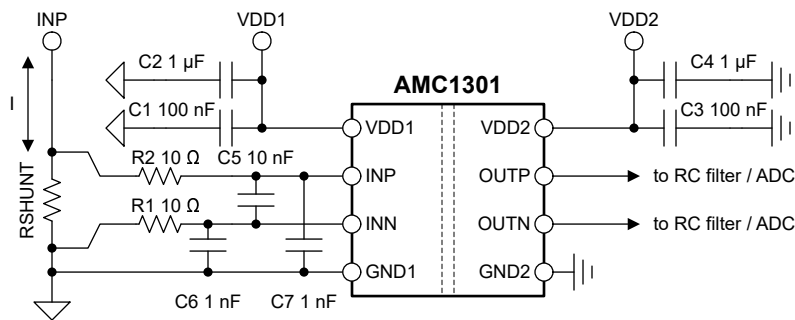
8.5.2 Layout Example



图 8-6. Recommended Layout of the AMC1301

9 Device and Documentation Support

9.1 Documentation Support

9.1.1 Related Documentation

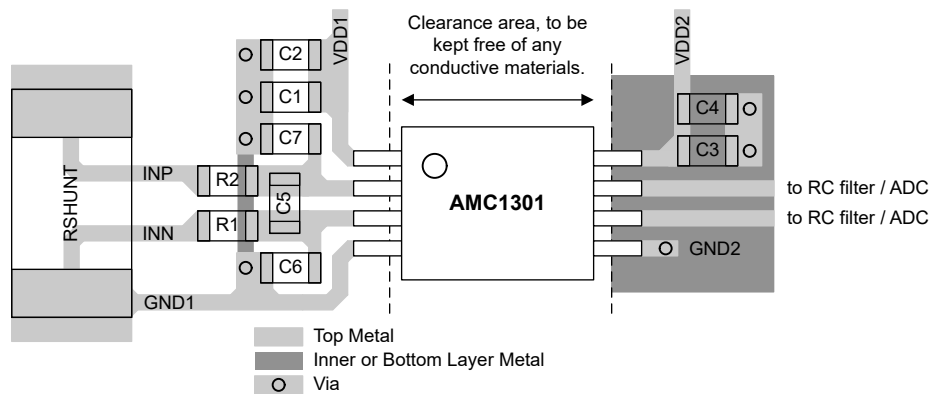
For related documentation, see the following:

- Texas Instruments, [Isolation Glossary application note](#)
- Texas Instruments, [Semiconductor and IC Package Thermal Metrics application note](#)
- Texas Instruments, [ISO72x Digital Isolator Magnetic-Field Immunity application note](#)
- Texas Instruments, [TLV900x Low-Power, RRIO, 1-MHz Operational Amplifier for Cost-Sensitive Systems data sheet](#)
- Texas Instruments, [18-Bit, 1-MSPS Data Acquisition Block \(DAQ\) Optimized for Lowest Distortion and Noise reference guide](#)
- Texas Instruments, [18-Bit, 1-MSPS Data Acquisition Block \(DAQ\) Optimized for Lowest Power reference guide](#)
- Texas Instruments, [Isolated Amplifier Voltage Sensing Excel Calculator design tool](#)
- Texas Instruments, [Best in Class Radiated Emissions EMI Performance with the AMC1300B-Q1 Isolated Amplifier technical white paper](#)
- Texas Instruments, [Isolated Voltage-Measurement Circuit With \$\pm 250\$ -mV Input and Differential Output application note](#)

9.2 接收文档更新通知

要接收文档更新通知，请导航至 ti.com 上的器件产品文件夹。点击 [订阅更新](#) 进行注册，即可每周接收产品信息更改摘要。有关更改的详细信息，请查看任何已修订文档中包含的修订历史记录。

9.3 支持资源

TI E2E™ 支持论坛是工程师的重要参考资料，可直接从专家获得快速、经过验证的解答和设计帮助。搜索现有解答或提出自己的问题可获得所需的快速设计帮助。

链接的内容由各个贡献者“按原样”提供。这些内容并不构成 TI 技术规范，并且不一定反映 TI 的观点；请参阅 TI 的《使用条款》。

9.4 Trademarks

TI E2E™ is a trademark of Texas Instruments.

所有商标均为其各自所有者的财产。

9.5 静电放电警告



静电放电 (ESD) 会损坏这个集成电路。德州仪器 (TI) 建议通过适当的预防措施处理所有集成电路。如果不遵守正确的处理和安装程序，可能会损坏集成电路。

ESD 的损坏小至导致微小的性能降级，大至整个器件故障。精密的集成电路可能更容易受到损坏，这是因为非常细微的参数更改都可能会导致器件与其发布的规格不相符。

9.6 术语表

TI 术语表 本术语表列出并解释了术语、首字母缩略词和定义。

10 Mechanical, Packaging, and Orderable Information

The following pages include mechanical, packaging, and orderable information. This information is the most current data available for the designated devices. This data is subject to change without notice and revision of this document. For browser-based versions of this data sheet, refer to the left-hand navigation.

PACKAGING INFORMATION

Orderable Device	Status (1)	Package Type	Package Drawing	Pins	Package Qty	Eco Plan (2)	Lead finish/ Ball material (6)	MSL Peak Temp (3)	Op Temp (°C)	Device Marking (4/5)	Samples
AMC1301DWV	ACTIVE	SOIC	DWV	8	64	RoHS & Green	NIPDAU	Level-3-260C-168 HR	-40 to 125	AMC1301	Samples
AMC1301DWVR	ACTIVE	SOIC	DWV	8	1000	RoHS & Green	NIPDAU	Level-3-260C-168 HR	-40 to 125	AMC1301	Samples
AMC1301SDWV	ACTIVE	SOIC	DWV	8	64	RoHS & Green	NIPDAU	Level-3-260C-168 HR	-55 to 125	AMC1301S	Samples
AMC1301SDWVR	ACTIVE	SOIC	DWV	8	1000	RoHS & Green	NIPDAU	Level-3-260C-168 HR	-55 to 125	AMC1301S	Samples

(1) The marketing status values are defined as follows:

ACTIVE: Product device recommended for new designs.

LIFEBUY: TI has announced that the device will be discontinued, and a lifetime-buy period is in effect.

NRND: Not recommended for new designs. Device is in production to support existing customers, but TI does not recommend using this part in a new design.

PREVIEW: Device has been announced but is not in production. Samples may or may not be available.

OBSOLETE: TI has discontinued the production of the device.

(2) **RoHS:** TI defines "RoHS" to mean semiconductor products that are compliant with the current EU RoHS requirements for all 10 RoHS substances, including the requirement that RoHS substance do not exceed 0.1% by weight in homogeneous materials. Where designed to be soldered at high temperatures, "RoHS" products are suitable for use in specified lead-free processes. TI may reference these types of products as "Pb-Free".

RoHS Exempt: TI defines "RoHS Exempt" to mean products that contain lead but are compliant with EU RoHS pursuant to a specific EU RoHS exemption.

Green: TI defines "Green" to mean the content of Chlorine (Cl) and Bromine (Br) based flame retardants meet JS709B low halogen requirements of <=1000ppm threshold. Antimony trioxide based flame retardants must also meet the <=1000ppm threshold requirement.

(3) MSL, Peak Temp. - The Moisture Sensitivity Level rating according to the JEDEC industry standard classifications, and peak solder temperature.

(4) There may be additional marking, which relates to the logo, the lot trace code information, or the environmental category on the device.

(5) Multiple Device Markings will be inside parentheses. Only one Device Marking contained in parentheses and separated by a "~" will appear on a device. If a line is indented then it is a continuation of the previous line and the two combined represent the entire Device Marking for that device.

(6) Lead finish/Ball material - Orderable Devices may have multiple material finish options. Finish options are separated by a vertical ruled line. Lead finish/Ball material values may wrap to two lines if the finish value exceeds the maximum column width.

Important Information and Disclaimer:The information provided on this page represents TI's knowledge and belief as of the date that it is provided. TI bases its knowledge and belief on information provided by third parties, and makes no representation or warranty as to the accuracy of such information. Efforts are underway to better integrate information from third parties. TI has taken and

continues to take reasonable steps to provide representative and accurate information but may not have conducted destructive testing or chemical analysis on incoming materials and chemicals. TI and TI suppliers consider certain information to be proprietary, and thus CAS numbers and other limited information may not be available for release.

In no event shall TI's liability arising out of such information exceed the total purchase price of the TI part(s) at issue in this document sold by TI to Customer on an annual basis.

OTHER QUALIFIED VERSIONS OF AMC1301 :

- Automotive : [AMC1301-Q1](#)

NOTE: Qualified Version Definitions:

- Automotive - Q100 devices qualified for high-reliability automotive applications targeting zero defects

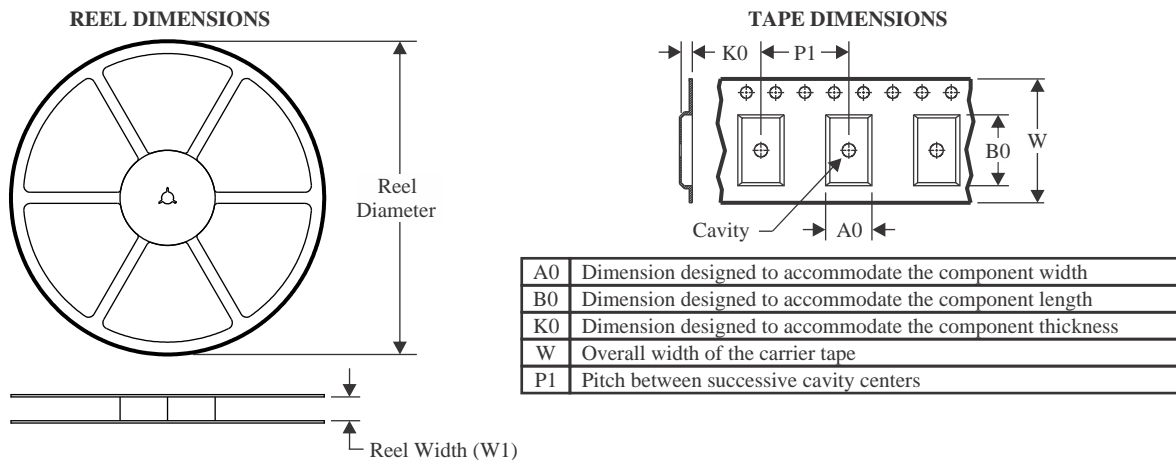
TAPE AND REEL INFORMATION

QUADRANT ASSIGNMENTS FOR PIN 1 ORIENTATION IN TAPE



*All dimensions are nominal

Device	Package Type	Package Drawing	Pins	SPQ	Reel Diameter (mm)	Reel Width W1 (mm)	A0 (mm)	B0 (mm)	K0 (mm)	P1 (mm)	W (mm)	Pin1 Quadrant
AMC1301DWVR	SOIC	DWV	8	1000	330.0	16.4	12.05	6.15	3.3	16.0	16.0	Q1
AMC1301DWVR	SOIC	DWV	8	1000	330.0	16.4	12.05	6.15	3.3	16.0	16.0	Q1
AMC1301DWVR	SOIC	DWV	8	1000	330.0	16.4	12.15	6.2	3.05	16.0	16.0	Q1
AMC1301SDWVR	SOIC	DWV	8	1000	330.0	16.4	12.05	6.15	3.3	16.0	16.0	Q1
AMC1301SDWVR	SOIC	DWV	8	1000	330.0	16.4	12.05	6.15	3.3	16.0	16.0	Q1
AMC1301SDWVR	SOIC	DWV	8	1000	330.0	16.4	12.15	6.2	3.05	16.0	16.0	Q1

TAPE AND REEL BOX DIMENSIONS

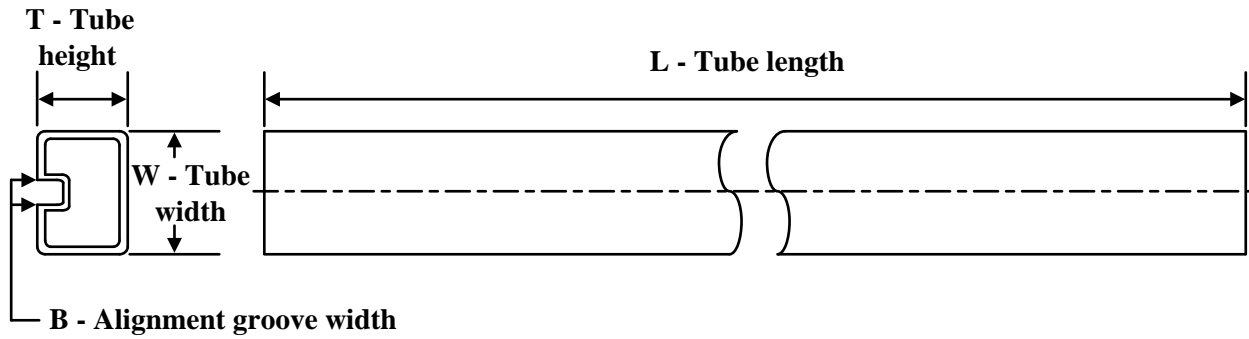

*All dimensions are nominal

Device	Package Type	Package Drawing	Pins	SPQ	Length (mm)	Width (mm)	Height (mm)
AMC1301DWVR	SOIC	DWV	8	1000	350.0	350.0	43.0
AMC1301DWVR	SOIC	DWV	8	1000	350.0	350.0	43.0
AMC1301DWVR	SOIC	DWV	8	1000	356.0	356.0	35.0
AMC1301SDWVR	SOIC	DWV	8	1000	350.0	350.0	43.0
AMC1301SDWVR	SOIC	DWV	8	1000	350.0	350.0	43.0
AMC1301SDWVR	SOIC	DWV	8	1000	356.0	356.0	35.0

TUBE

*All dimensions are nominal

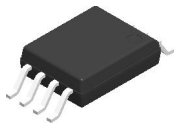
Device	Package Name	Package Type	Pins	SPQ	L (mm)	W (mm)	T (μm)	B (mm)
AMC1301DWV	DWV	SOIC	8	64	505.46	13.94	4826	6.6
AMC1301SDWV	DWV	SOIC	8	64	505.46	13.94	4826	6.6



DWV0008A

SOIC - 2.8 mm max height

SOIC

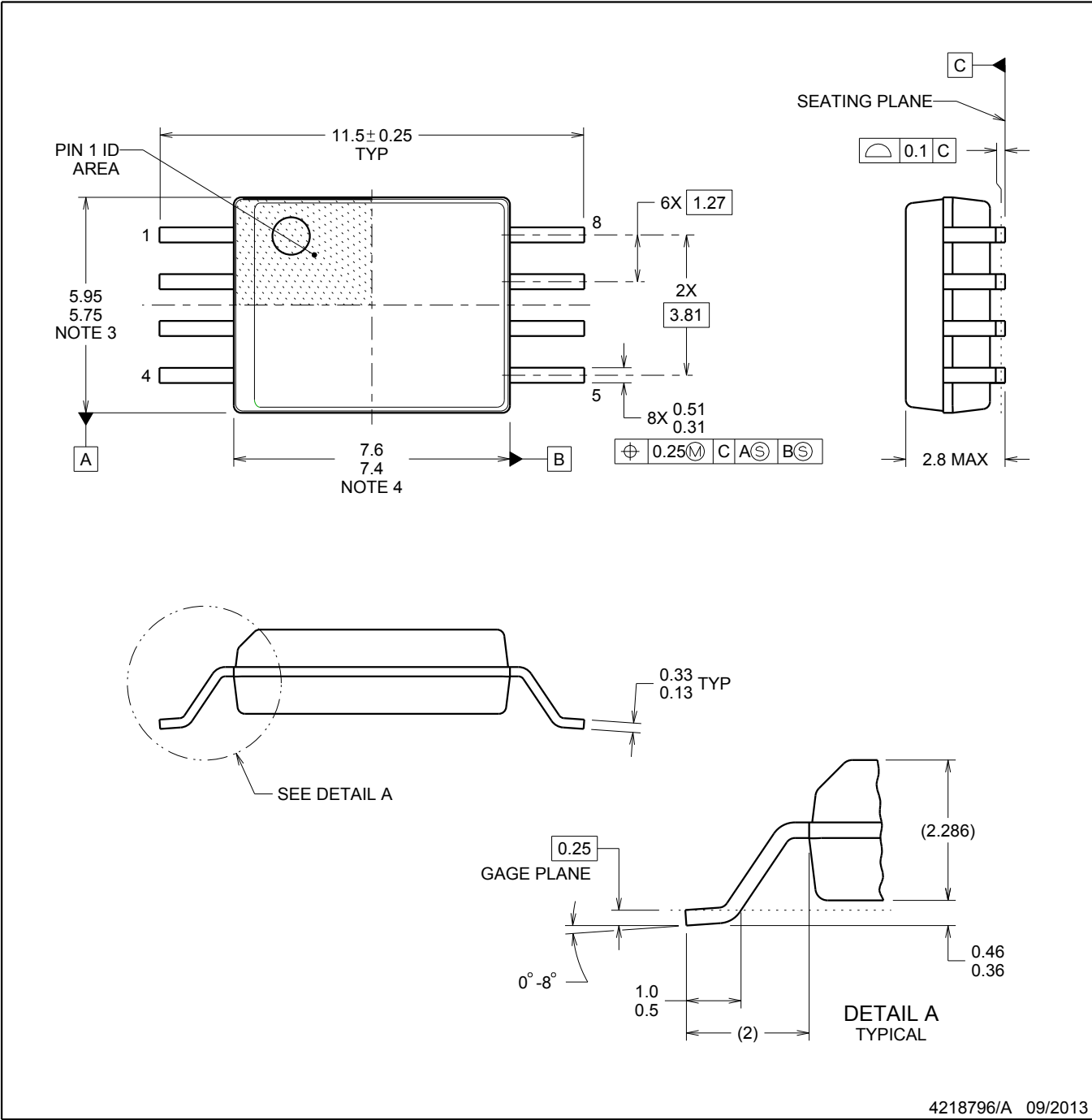

4218796/A 09/2013

NOTES:

1. All linear dimensions are in millimeters. Dimensions in parenthesis are for reference only. Dimensioning and tolerancing per ASME Y14.5M.
2. This drawing is subject to change without notice.
3. This dimension does not include mold flash, protrusions, or gate burrs. Mold flash, protrusions, or gate burrs shall not exceed 0.15 mm, per side.
4. This dimension does not include interlead flash. Interlead flash shall not exceed 0.25 mm, per side.

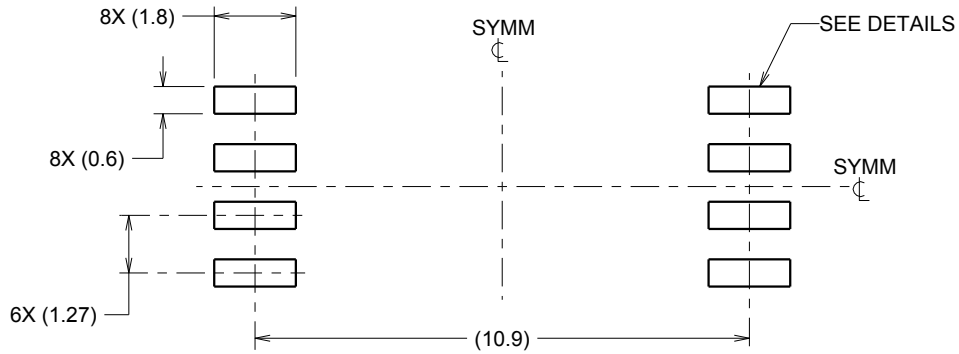

LAND PATTERN EXAMPLE
9.1 mm NOMINAL CLEARANCE/CREEPAGE
SCALE:6X

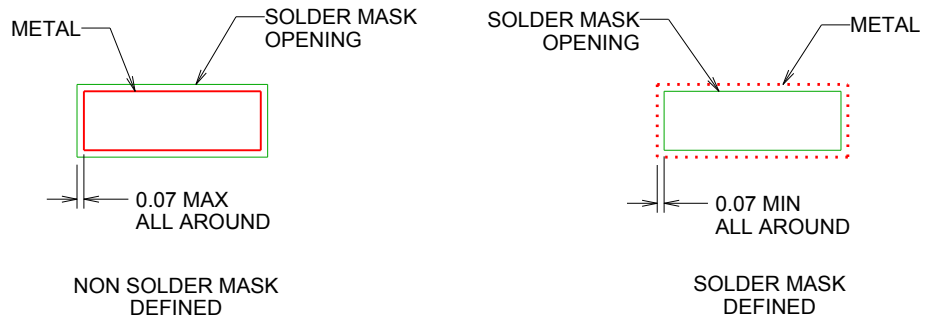

SOLDER MASK DETAILS

4218796/A 09/2013

NOTES: (continued)

- 5. Publication IPC-7351 may have alternate designs.
- 6. Solder mask tolerances between and around signal pads can vary based on board fabrication site.

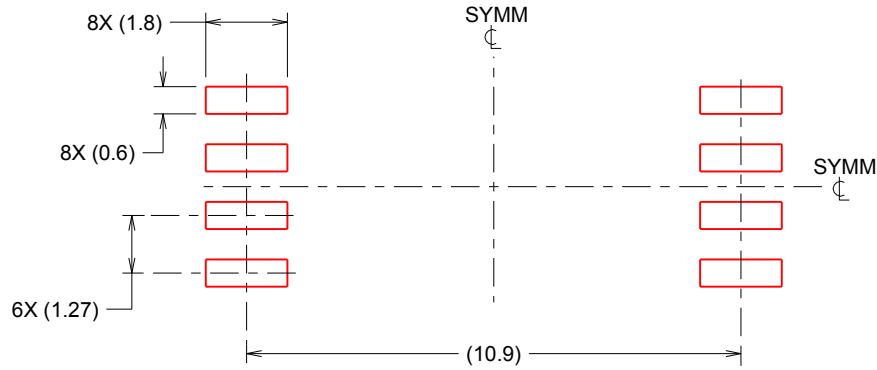

SOLDER PASTE EXAMPLE
 BASED ON 0.125 mm THICK STENCIL
 SCALE:6X

4218796/A 09/2013

NOTES: (continued)

- 7. Laser cutting apertures with trapezoidal walls and rounded corners may offer better paste release. IPC-7525 may have alternate design recommendations.
- 8. Board assembly site may have different recommendations for stencil design.

重要声明和免责声明

TI“按原样”提供技术和可靠性数据（包括数据表）、设计资源（包括参考设计）、应用或其他设计建议、网络工具、安全信息和其他资源，不保证没有瑕疵且不做任何明示或暗示的担保，包括但不限于对适销性、某特定用途方面的适用性或不侵犯任何第三方知识产权的暗示担保。

这些资源可供使用 TI 产品进行设计的熟练开发人员使用。您将自行承担以下全部责任：(1) 针对您的应用选择合适的 TI 产品，(2) 设计、验证并测试您的应用，(3) 确保您的应用满足相应标准以及任何其他功能安全、信息安全、监管或其他要求。

这些资源如有变更，恕不另行通知。TI 授权您仅可将这些资源用于研发本资源所述的 TI 产品的应用。严禁对这些资源进行其他复制或展示。您无权使用任何其他 TI 知识产权或任何第三方知识产权。您应全额赔偿因在这些资源的使用中对 TI 及其代表造成的任何索赔、损害、成本、损失和债务，TI 对此概不负责。

TI 提供的产品受 [TI 的销售条款](#) 或 [ti.com](#) 上其他适用条款/TI 产品随附的其他适用条款的约束。TI 提供这些资源并不会扩展或以其他方式更改 TI 针对 TI 产品发布的适用的担保或担保免责声明。

TI 反对并拒绝您可能提出的任何其他或不同的条款。

邮寄地址：Texas Instruments, Post Office Box 655303, Dallas, Texas 75265
Copyright © 2024，德州仪器 (TI) 公司