

bq24259 具有窄范围 VDC 电源路径管理和可调节电压 USB OTG 的 I²C 控制的 2A 单节 USB 充电器

1 特性

- 90% 高效开关模式 2A 充电器
- 3.9V 至 6.2V 单输入 USB 标准充电器，提供 6.4V 过压保护
 - 输入电压和电流限制支持 USB 2.0 和 USB 3.0
 - 输入电流限值：100mA、150mA、500mA、900mA、1A、1.5A 和 2A
- USB OTG 在电流为 1A 或 1.5A 时的可调输出电压范围为 4.55V 至 5.5V
 - 快速 OTG 启动（典型值为 22ms）
 - 5V 升压模式效率为 90%
 - 精确的 $\pm 15\%$ 断续模式过流保护
- 窄范围 VDC (NVDC) 电源路径管理
 - 在无电池或深度电池放电时的即时系统启动
 - 电池充电模式中的理想二极管运行
- 薄型 1.2mm 电感 1.5MHz 开关频率
- I²C 端口用于实现最优系统性能和状态报告
- 具有或不具有主机管理的自主电池充电
 - 电池充电启用
 - 电池充电预调节
 - 充电终止和再充电
- 高精度
 - $\pm 0.5\%$ 充电电压调节
 - 充电电流调节范围为 $\pm 7\%$
 - 输入电流调节范围为 $\pm 7.5\%$
 - USB OTG 升压模式下 $\pm 3\%$ 输出电压调节范围
- 高集成
 - 电源路径管理
 - 同步开关 MOSFET
 - 集成电流感测
 - 阴极负载二极管
 - 内部环路补偿
- 安全性
 - 针对 OTG 模式中充电和放电的电池温度感测
 - 电池充电安全定时器
 - 热调节和热关断
 - 输入和系统过压保护
 - MOSFET 过流保护

- 针对 LED 或主机处理器的充电状态输出
- 通过输入电压稳压实现的最大功率跟踪功能
- 20 μ A 低电池泄漏电流，支持运输模式
- 4mm x 4mm 紧凑型超薄四方扁平无引线 (VQFN)-24 封装

2 应用

- 平板电脑，智能手机，网络设备
- 便携式音频扬声器

3 说明

bq24259 是一款高度集成的开关模式电池充电管理和系统电源路径管理器件，适用于各种智能手机和平板电脑应用中的单节锂离子和锂聚合物电池的续航。它的低阻抗电源路径对开关模式运行效率进行了优化、减少了电池充电时间并延长了放电阶段的电池寿命。具有充电和系统设置的 I²C 串行接口使得此器件成为一个真正地灵活解决方案。

器件信息(1)

器件型号	封装	封装尺寸 (标称值)
bq24259	VQFN (24)	4.00mm x 4.00mm

(1) 如需了解所有可用封装，请见数据表末尾的可订购产品附录。

PSEL 连接 PHY，通过 SDP/DCP 充电并带有可选 BATFET 使能接口

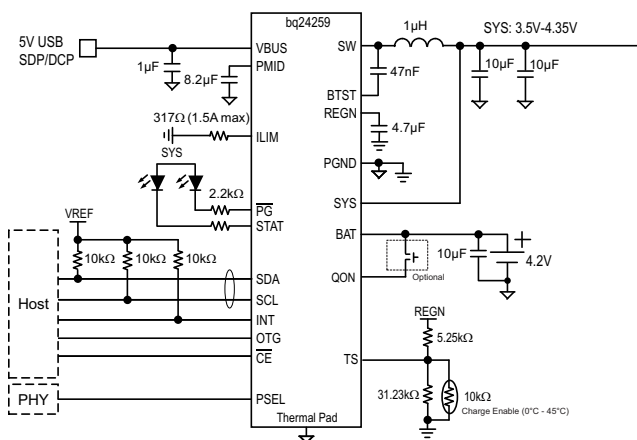

目录

1	特性	1	8.4	Device Functional Modes	25
2	应用	1	8.5	Programming	26
3	说明	1	8.6	Register Map	29
4	修订历史记录	2	9	Application and Implementation	36
5	说明 (续)	3	9.1	Application Information	36
6	Pin Configuration and Functions	4	9.2	Typical Application	36
7	Specifications	5	10	Power Supply Recommendations	40
7.1	Absolute Maximum Ratings	5	11	Layout	40
7.2	ESD Ratings	5	11.1	Layout Guidelines	40
7.3	Recommended Operating Conditions	6	11.2	Layout Example	41
7.4	Thermal Information	6	12	器件和文档支持	42
7.5	Electrical Characteristics	6	12.1	器件支持	42
7.6	Timing Requirements	10	12.2	社区资源	42
7.7	Typical Characteristics	10	12.3	商标	42
8	Detailed Description	13	12.4	静电放电警告	42
8.1	Overview	13	12.5	Glossary	42
8.2	Functional Block Diagram	13	13	机械、封装和可订购信息	42
8.3	Feature Description	14			

4 修订历史记录

Changes from Original (November 2015) to Revision A	Page
• 已将电路原理图中的引脚“BOOT”更改为“BTST”	1
• Changed pin "BOOT" To: "BTST" in 图 39	36

5 说明（续）

该器件支持 3.9V 至 6.2V USB 输入电源，包括具有 6.4V 过压保护功能的标准 USB 主机端口和 USB 充电端口。该器件支持 USB 2.0 和 USB 3.0 电源规范，具有输入电流和电压调节功能。为了设定默认输入电流限值，bq24259 获取系统检测电路（如 USB PHY 器件）中的结果。该器件还具有快速启动功能和高达 1.5A 的精确限流能力，能够为 VBUS 提供 4.55V 至 5.5V（默认为 5V）的可调电压，支持 USB On-the-Go 运行。

电源路径管理将系统电压调节至稍高于电池电压的水平，但是不会下降至 3.5V 最小系统电压（可编程）以下。借助于这个特性，即使在电池电量完全耗尽或者电池被拆除时，系统也能保持运行。当达到输入源电流或电压限值时，电源路径管理自动将充电电流减少为零，然后开始对电池放电，直到满足系统的电源需求。这个充电模式操作可保证输入源不会过载。

此器件在主机控制不可用时开始且完成一个充电周期。它分三个阶段对电池进行自动充电：预调节、恒定电流和恒定电压。在充电周期的末尾，当充电电流低于在恒定电压阶段中预设定的限值时，充电器自动终止。之后，当电池电压下降到低于再充电阈值时，充电器将自动启动另外一个充电周期。

该充电器针对电池充电和系统运行提供多种安全功能，其中包括负温度系数热敏电阻监控、充电安全定时器和过压/过流保护。当结温超过 120°C（可设定）时，热调节减少充电电流。

STAT 输出报告充电状态和任何故障条件。当故障发生时，INT 立即通知主机。

bq24259 采用 24 引脚 4 x 4mm² 超薄 VQFN 封装。

6 Pin Configuration and Functions

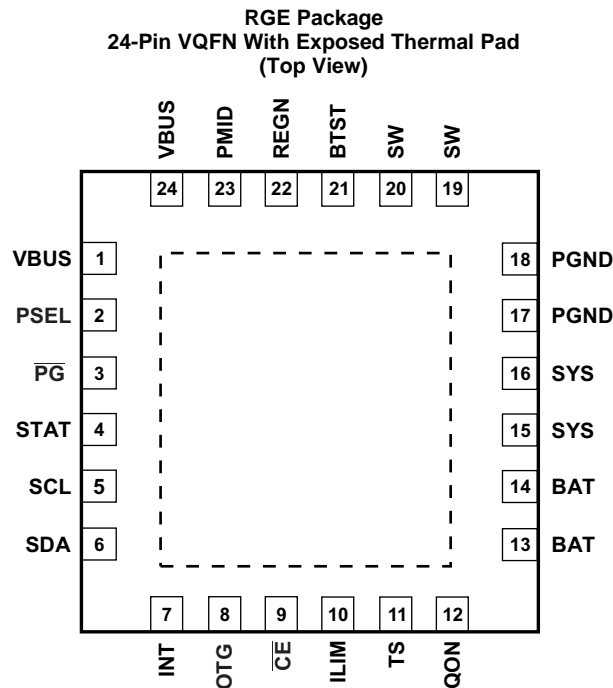

Pin Functions

PIN		TYPE	DESCRIPTION
NAME	NUMBER		
VBUS	1, 24	P	Charger Input Voltage. The internal n-channel reverse block MOSFET (RBFET) is connected between VBUS and PMID with VBUS on source. Place a 1- μ F ceramic capacitor from VBUS to PGND and place it as close as possible to IC.
PSEL	2	I	Power source selection input. High indicates a USB host source and Low indicates an adapter source.
$\overline{\text{PG}}$	3	O	Open drain active low power good indicator. Connect to the pull up rail via 10-k Ω resistor. LOW indicates a good input source if the input voltage is between UVLO and ACOV, above SLEEP mode threshold, and current limit is above 30 mA.
STAT	4	O	Open drain charge status output to indicate various charger operation. Connect to the pull up rail via 10-k Ω resistor. LOW indicates charge in progress. HIGH indicates charge complete or charge disabled. When any fault condition occurs, STAT pin in the charge blinks at 1 Hz.
SCL	5	I	I ² C Interface clock. Connect SCL to the logic rail through a 10-k Ω resistor.
SDA	6	I/O	I ² C Interface data. Connect SDA to the logic rail through a 10-k Ω resistor.
INT	7	O	Open-drain Interrupt Output. Connect the INT to a logic rail via 10-k Ω resistor. The INT pin sends active low, 256- μ s pulse to host to report charger device status and fault.
OTG	8	I Digital	USB current limit selection pin during buck mode, and active high enable pin during boost mode. For bq24259, when in buck mode with USB host (PSEL = High), when OTG = High, I _N limit = 500 mA and when OTG = Low, I _N limit = 100 mA. The boost mode is activated when the REG01[5] = 1 and OTG pin is High.
$\overline{\text{CE}}$	9	I	Active low Charge Enable pin. Battery charging is enabled when REG01[5:4] = 01 and $\overline{\text{CE}}$ pin = Low. $\overline{\text{CE}}$ pin must be pulled high or low.
ILIM	10	I	ILIM pin sets the maximum input current limit by regulating the ILIM voltage at 1 V. A resistor is connected from ILIM pin to ground to set the maximum limit as $I_{\text{INMAX}} = (1V/R_{\text{ILIM}}) \times K_{\text{ILIM}}$. The actual input current limit is the lower one set by ILIM and by I ² C REG00[2:0]. The minimum input current programmed on ILIM pin is 500 mA.
TS	11	I Analog	Temperature qualification voltage input. Connect a negative temperature coefficient thermistor. Program temperature window with a resistor divider from REGN to TS to GND. Charge suspends or Boost disable when TS pin is out of range. A 103AT-2 thermistor is recommended.
QON	12	I	BATFET enable control in shipping mode. A logic low to high transition on this pin with minimum 2ms high level turns on BATFET to exit shipping mode. It has internal 1M Ω (Typ) pull down. For backward compatibility, when BATFET enable control function is not used, the pin can be a no connect or tied to TS pin (10k NTC thermistor only). (Refer to Shipping Mode for detail description).
BAT	13,14	P	Battery connection point to the positive pin of the battery pack. The internal BATFET is connected between BAT and SYS. Connect a 10 μ F closely to the BAT pin.

Pin Functions (continued)

PIN		TYPE	DESCRIPTION
NAME	NUMBER		
SYS	15,16	I	System connection point. The internal BATFET is connected between BAT and SYS. When the battery falls below the minimum system voltage, switch-mode converter keeps SYS above the minimum system voltage.
PGND	17,18	P	Power ground connection for high-current power converter node. Internally, PGND is connected to the source of the n-channel LSFET. On PCB layout, connect directly to ground connection of input and output capacitors of the charger. A single point connection is recommended between power PGND and the analog GND near the IC PGND pin.
SW	19,20	O	Switching node connecting to output inductor. Internally SW is connected to the source of the n-channel HSFET and the drain of the n-channel LSFET. Connect the 0.047- μ F bootstrap capacitor from SW to BTST.
BTST	21	P	PWM high side driver positive supply. Internally, the BTST is connected to the anode of the boost-strap diode. Connect the 0.047- μ F bootstrap capacitor from SW to BTST.
REGN	22	P	PWM low side driver positive supply output. Internally, REGN is connected to the cathode of the boost-strap diode. Connect a 4.7- μ F (10-V rating) ceramic capacitor from REGN to analog GND. The capacitor should be placed close to the IC. REGN also serves as bias rail of TS pin.
PMID	23	O	Connected to the drain of the reverse blocking MOSFET and the drain of HSFET. Given the total input capacitance, connect a 1- μ F capacitor on VBUS to PGND, and the recommended 8.2 μ F or more on PMID to PGND.
Thermal Pad		P	Exposed pad beneath the IC for heat dissipation. Always solder thermal pad to the board, and have vias on the thermal pad plane star-connecting to PGND and ground plane for high-current power converter.

7 Specifications

7.1 Absolute Maximum Ratings⁽¹⁾

		MIN	MAX	UNIT	
Voltage (with respect to GND)	VBUS (converter not switching)	-2	15 ⁽²⁾	V	
	PMID (converter not switching)	-0.3	15 ⁽²⁾	V	
	STAT	-0.3	12	V	
	BTST	-0.3	12	V	
	SW	-2	7 8 (Peak for 20ns duration)	V	
	BAT, SYS (converter not switching)	-0.3	6	V	
	SDA, SCL, INT, OTG, ILIM, REGN, TS, QON, CE PSEL	-0.3	7	V	
	BTST TO SW	-0.3	7	V	
	PGND to GND	-0.3	0.3	V	
Output sink current	INT, STAT, \overline{PG}		6	mA	
Junction temperature			-40	150	°C
Storage temperature range, T _{stg}			-65	150	°C

- (1) Stresses beyond those listed under absolute maximum ratings may cause permanent damage to the device. These are stress ratings only, and functional operation of the device at these or any other conditions beyond those indicated under recommended operating conditions is not implied. Exposure to absolute-maximum-rated conditions for extended periods may affect device reliability. All voltage values are with respect to the network ground pin unless otherwise noted.
- (2) VBUS is specified up to 16 V for a maximum of 24 hours under no load conditions.

7.2 ESD Ratings

			VALUE	UNIT
V _(ESD)	Electrostatic discharge	Human body model (HBM), per ANSI/ESDA/JEDEC JS-001 ⁽¹⁾	±1000	V
		Charged device model (CDM), per JEDEC specification JESD22-C101 ⁽²⁾	±250	V

- (1) JEDEC document JEP155 states that 500-V HBM allows safe manufacturing with a standard ESD control process.
- (2) JEDEC document JEP157 states that 250-V CDM allows safe manufacturing with a standard ESD control process.

7.3 Recommended Operating Conditions

		MIN	MAX	UNIT
V_{IN}	Input voltage	3.9	6.2 ⁽¹⁾	V
I_{SYS}	Output current (SYS)		3.5	A
V_{BAT}	Battery voltage		4.4	V
I_{BAT}	Fast charging current		2	A
	Discharging current with internal MOSFET		5.5	A
T_A	Operating free-air temperature range	-40	85	°C

(1) The inherent switching noise voltage spikes should not exceed the absolute maximum rating on either the BTST or SW pins. A tight layout minimizes switching noise.

7.4 Thermal Information

THERMAL METRIC ⁽¹⁾		bq24259		UNIT
		RGE (VQFN)		
		24 PIN		
$R_{\theta JA}$	Junction-to-ambient thermal resistance	32.2		°C/W
$R_{\theta Jctop}$	Junction-to-case (top) thermal resistance	29.8		
$R_{\theta JB}$	Junction-to-board thermal resistance	9.1		
Ψ_{JT}	Junction-to-top characterization parameter	0.3		
Ψ_{JB}	Junction-to-board characterization parameter	9.1		
$R_{\theta Jcbot}$	Junction-to-case (bottom) thermal resistance	2.2		

(1) For more information about traditional and new thermal metrics, see the *Semiconductor and IC Package Thermal Metrics* application report ([SPRA953](#)).

7.5 Electrical Characteristics

$V_{(VBUS_UVLOZ)} < V_{(VBUS)} < V_{(ACOV)}$ and $V_{(VBUS)} > V_{(BAT)} + V_{(SLEEP)}$, $T_J = -40^\circ\text{C}$ to 125°C and $T_J = 25^\circ\text{C}$ for typical values (unless otherwise noted)

PARAMETER		TEST CONDITIONS	MIN	TYP	MAX	UNIT
QUIESCENT CURRENTS						
$I_{(BAT)}$	Battery discharge current (BAT, SW, SYS)	$V_{(VBUS)} < V_{(UVLO)}$, $V_{(BAT)} = 4.2\text{ V}$, leakage between BAT and VBUS		5		μA
		High-Z Mode, or no VBUS, BATFET disabled (REG07[5] = 1), $-40^\circ\text{C} - 85^\circ\text{C}$		16	20	μA
		High-Z Mode, or no VBUS, BATFET enabled (REG07[5] = 0), $-40^\circ\text{C} - 85^\circ\text{C}$		32	55	μA
$I_{(VBUS)}$	Input supply current (VBUS)	$V_{(VBUS)} = 5\text{ V}$, High-Z mode, No battery		15	30	μA
		$V_{(VBUS)} > V_{(UVLO)}$, $V_{(VBUS)} > V_{(BAT)}$, converter not switching		1.5	3	mA
		$V_{(VBUS)} > V_{(UVLO)}$, $V_{(VBUS)} > V_{(BAT)}$, converter switching, $V_{(BAT)} = 3.2\text{ V}$, $I_{SYS} = 0\text{ A}$		4		mA
		$V_{(VBUS)} > V_{(UVLO)}$, $V_{(VBUS)} > V_{(BAT)}$, converter switching, charge disable, $V_{(BAT)} = 3.8\text{ V}$, $I_{SYS} = 100\text{ μA}$		3.5		mA
$I_{(BOOST)}$	Battery discharge current in boost mode	$V_{(BAT)} = 4.2\text{ V}$, Boost mode, $I_{(VBUS)} = 0\text{ A}$, converter switching		3.5		mA
VBUS/BAT POWER UP						
$V_{(VBUS_OP)}$	VBUS operating voltage		3.9		6.2	V
$V_{(VBUS_UVLOZ)}$	VBUS for active I ² C, no battery	$V_{(VBUS)}$ rising	3.6			V
$V_{(SLEEP)}$	Sleep mode falling threshold	$V_{(VBUS)}$ falling, $V_{(VBUS-VBAT)}$	35	80	120	mV
$V_{(SLEEPZ)}$	Sleep mode rising threshold	$V_{(VBUS)}$ rising, $V_{(VBUS-VBAT)}$	170	250	350	mV
$V_{(ACOV)}$	VBUS over-voltage rising threshold	$V_{(VBUS)}$ rising	6.2		6.6	V
$V_{(ACOV_HYST)}$	VBUS over-voltage falling hysteresis	$V_{(VBUS)}$ falling		250		mV
$V_{(BAT_UVLOZ)}$	Battery for active I ² C, no VBUS	$V_{(BAT)}$ rising	2.3			V
$V_{(BAT_DPL)}$	Battery depletion threshold	$V_{(BAT)}$ falling		2.4	2.6	V
$V_{(BAT_DPL_HY)}$	Battery depletion rising hysteresis	$V_{(BAT)}$ rising		200		mV

Electrical Characteristics (接下页)

$V_{(VBUS_UVLOZ)} < V_{(VBUS)} < V_{(ACOV)}$ and $V_{(VBUS)} > V_{(BAT)} + V_{(SLEEP)}$, $T_J = -40^{\circ}\text{C}$ to 125°C and $T_J = 25^{\circ}\text{C}$ for typical values (unless otherwise noted)

PARAMETER		TEST CONDITIONS	MIN	TYP	MAX	UNIT
$V_{(VBUSMIN)}$	Bad adapter detection threshold	$V_{(VBUS)}$ falling		3.8		V
$I_{(BADSRC)}$	Bad adapter detection current source			30		mA
POWER PATH MANAGEMENT						
$V_{(SYS_MAX)}$	Maximum DC system voltage output	BATFET (Q4) off, $V_{(BAT)}$ up to 4.35 V			4.43	V
$V_{(SYS_MIN)}$	Minimum DC system voltage output	REG01[3:1] = 101, $V_{(SYS_MIN)} = 3.5$ V	3.5	3.65		V
$R_{ON(RBFET)}$	Top reverse blocking MOSFET on-resistance between VBUS and PMIID			35	48	mΩ
$R_{ON(HSFET)}$	Internal top switching MOSFET on-resistance between PMID and SW	$T_J = -40^{\circ}\text{C} - 85^{\circ}\text{C}$		45	57	mΩ
		$T_J = -40^{\circ}\text{C} - 125^{\circ}\text{C}$		45	65	
$R_{ON(LSFET)}$	Internal bottom switching MOSFET on-resistance between SW and PGND	$T_J = -40^{\circ}\text{C} - 85^{\circ}\text{C}$		67	88	mΩ
		$T_J = -40^{\circ}\text{C} - 125^{\circ}\text{C}$		67	98	
$V_{(FWD)}$	BATFET forward voltage in supplement mode	BAT discharge current 10 mA		30		mV
$V_{(SYS_BAT)}$	SYS/BAT comparator	$V_{(BAT)} < V_{(SYS_MIN)}$, $V_{(SYS)}$ falling		80		mV
		$V_{(BAT)} > V_{(SYS_MIN)}$, $V_{(SYS)}$ falling		180		mV
$V_{(BATGD)}$	Battery good comparator rising threshold	$V_{(BAT)}$ rising		3.55		V
$V_{(BATGD_HYST)}$	Battery good comparator falling threshold	$V_{(BAT)}$ falling		100		mV
BATTERY CHARGER						
$V_{(BAT_REG_ACC)}$	Charge voltage regulation accuracy	$V_{(BAT)} = 4.112$ V and 4.208 V	-0.5%		0.5%	
$I_{(ICHG_REG_ACC)}$	Fast charge current regulation accuracy	$V_{(BAT)} = 3.8$ V, $I_{(CHG)} = 1024$ mA, $T_J = 25^{\circ}\text{C}$	-4%		4%	
		$V_{(BAT)} = 3.8$ V, $I_{(CHG)} = 1024$ mA, $T_J = -20^{\circ}\text{C} - 125^{\circ}\text{C}$	-7%		7%	
		$V_{(BAT)} = 3.8$ V, $I_{(CHG)} = 1792$ mA, $T_J = -20^{\circ}\text{C} - 125^{\circ}\text{C}$	-10%		10%	
$I_{(CHG)}$	Charge current with 20% option on	$V_{(BAT)} = 3.1$ V, $I_{(CHG)} = 104$ mA, REG02 = 03 and REG02[0] = 1		75	175	mA
$V_{(BATLOWV)}$	Battery LOWV falling threshold	Fast charge to precharge, REG04[1] = 1	2.6	2.8	2.9	V
$V_{(BATLOWV_HYST)}$	Battery LOWV rising threshold	Precharge to fast charge, REG04[1] = 1 (Typical 200-mV hysteresis)	2.8	3	3.1	V
$I_{(PRECHG_ACC)}$	Precharge current regulation accuracy	$V_{(BAT)} = 2.6$ V, $I_{(CHG)} = 256$ mA	-20%		20%	
$I_{(TYP_TERM_ACC)}$	Typical termination current	$I_{(TERM)} = 256$ mA, $I_{(CHG)} = 2048$ mA		265		mA
$I_{(TERM_ACC)}$	Termination current accuracy	$I_{(TERM)} = 256$ mA, $I_{(CHG)} = 2048$ mA	-22.5%		22.5%	
$V_{(SHORT)}$	Battery short voltage	$V_{(BAT)}$ falling		2.0		V
$V_{(SHORT_HYST)}$	Battery Short Voltage hysteresis	$V_{(BAT)}$ rising		200		mV
$I_{(SHORT)}$	Battery short current	$V_{(BAT)} < 2.2$ V		100		mA
$V_{(RECHG)}$	Recharge threshold below VBAT_REG	$V_{(BAT)}$ falling, REG04[0] = 0		100		mV
$t_{(RECHG)}$	Recharge deglitch time	$V_{(BAT)}$ falling, REG04[0] = 0		20		ms
$R_{ON(BATFET)}$	SYS-BAT MOSFET on-resistance	$T_J = 25^{\circ}\text{C}$		24	28	mΩ
		$T_J = -40^{\circ}\text{C} - 125^{\circ}\text{C}$		24	35	
INPUT VOLTAGE/CURRENT REGULATION						
$V_{(INDPM_REG_ACC)}$	Input voltage regulation accuracy		-2%		2%	
$I_{(USB_DPM)}$	USB Input current regulation limit, $V_{(BUS)} = 5$ V, current pulled from SW	USB100		85	100	mA
		USB150		125	150	mA
		USB500		440	500	mA
		USB900		750	900	mA
$I_{(ADPT_DPM)}$	Input current regulation accuracy	$I_{(ADP)} = 1.5$ A, REG00[2:0] = 101	1.3		1.5	A
$I_{(INSTART)}$	Input current limit during system start up	$V_{(SYS)} < 2.2$ V		100		mA
K_{ILIM}	$I_{IN} = K_{ILIM}/R_{ILIM}$	$I_{IN(DPM)} = 1.5$ A	395	435	475	A x Ω
BAT OVERVOLTAGE PROTECTION						
$V_{(BATOVP)}$	Battery overvoltage threshold	$V_{(BAT)}$ rising, as percentage of $V_{(BAT_REG)}$		104%		
$V_{(BATOVP_HYST)}$	Battery overvoltage hysteresis	$V_{(BAT)}$ falling, as percentage of $V_{(BAT_REG)}$		2%		
t_{BATOVP}	Battery overvoltage deglitch time to disable charge			1		μs

Electrical Characteristics (接下页)

$V_{(VBUS_UVLOZ)} < V_{(VBUS)} < V_{(ACOV)}$ and $V_{(VBUS)} > V_{(BAT)} + V_{(SLEEP)}$, $T_J = -40^{\circ}\text{C}$ to 125°C and $T_J = 25^{\circ}\text{C}$ for typical values (unless otherwise noted)

PARAMETER		TEST CONDITIONS	MIN	TYP	MAX	UNIT
THERMAL REGULATION AND THERMAL SHUTDOWN						
T_J	Junction temperature regulation accuracy	REG06[1:0] = 11		120		$^{\circ}\text{C}$
$T_{(SHUT)}$	Thermal shutdown rising temperature	Temperature increasing		160		$^{\circ}\text{C}$
$T_{(SHUT_HYS)}$	Thermal shutdown hysteresis			30		$^{\circ}\text{C}$
	Thermal shutdown rising deglitch	Temperature increasing delay		1		ms
	Thermal shutdown falling deglitch	Temperature decreasing delay		1		ms
COLD/HOT THERMISTOR COMPARATOR						
$V_{(LTF)}$	Cold temperature threshold, TS pin voltage rising threshold	Charger suspends charge. as percentage to $V_{(REGN)}$	73%	73.5%	74%	
$V_{(LTF_HYS)}$	Cold temperature hysteresis, TS pin voltage falling	As percentage to $V_{(REGN)}$		0.4%		
$V_{(HTF)}$	Hot temperature TS pin voltage rising threshold	As percentage to $V_{(REGN)}$	46.6%	47.2%	48.8%	
$V_{(TCO)}$	Cut-off temperature TS pin voltage falling threshold	As percentage to $V_{(REGN)}$	44.2%	44.7%	45.2%	
	Deglitch time for temperature out of range detection	$V_{(TS)} > V_{(LTF)}$, or $V_{(TS)} < V_{(TCO)}$, or $V_{(TS)} < V_{(HTF)}$		10		ms
$V_{(BCOLD0)}$	Cold temperature threshold, TS pin voltage rising threshold	As percentage to $V_{(REGN)}$ REG02[1] = 0 (Approx. -10°C w/ 103AT)	75.5%	76%	76.5%	
$V_{(BCOLD0_HYS)}$		As percentage to $V_{(REGN)}$ REG02[1] = 0 (Approx. 1°C w/ 103AT)		1%		
$V_{(BCOLD1)}$	Cold temperature threshold 1, TS pin voltage rising threshold	As percentage to $V_{(REGN)}$ REG02[1] = 1 (Approx. -20°C w/ 103AT)	78.5%	79%	79.5%	
$V_{(BCOLD1_HYS)}$		As percentage to $V_{(REGN)}$ REG02[1] = 1 (Approx. 1°C w/ 103AT)		1%		
$V_{(BHOTO)}$	Hot temperature threshold, TS pin voltage falling threshold	As percentage to $V_{(REGN)}$ REG06[3:2] = 01 (Approx. 55°C w/ 103AT)	35.5%	36%	36.5%	
$V_{(BHOTO_HYS)}$		As percentage to $V_{(REGN)}$ REG06[3:2] = 01 (Approx. 3°C w/ 103AT)		3%		
$V_{(BHOT1)}$	Hot temperature threshold 1, TS pin voltage falling threshold	As percentage to $V_{(REGN)}$ REG06[3:2] = 00 (Approx. 60°C w/ 103AT)	32.5%	33%	33.5%	
$V_{(BHOT1_HYS)}$		As percentage to $V_{(REGN)}$ REG06[3:2] = 00 (Approx. 3°C w/ 103AT)		3%		
$V_{(BHOT2)}$	Hot temperature threshold 2, TS pin voltage falling threshold	As percentage to $V_{(REGN)}$ REG06[3:2] = 10 (Approx. 65°C w/ 103AT)	29.5%	30%	30.5%	
$V_{(BHOT2_HYS)}$		As percentage to $V_{(REGN)}$ REG06[3:2] = 10 (Approx. 3°C w/ 103AT)		3%		
CHARGE OVERCURRENT COMPARATOR						
$I_{(HSFET_OCP)}$	HSFET cycle by cycle over-current threshold		4	7.5		A
$V_{(LSFET_UCP)}$	LSFET charge under-current falling threshold	From sync mode to non-sync mode		100		mA
F_{SW}	PWM Switching frequency, and digital clock		1300	1500	1700	kHz
$D_{(MAX)}$	Maximum PWM duty cycle			97%		
$V_{(BTST_REFRESH)}$	Bootstrap refresh comparator threshold	$V_{(BTST)} - V_{(SW)}$ when LSFET refresh pulse is requested, $V_{(BUS)} = 5\text{V}$		3.6		V
BOOST MODE OPERATION						
$V_{(OTG_REG_ACC)}$	OTG output voltage	$I_{(VBUS)} = 0$, REG06[7:4] = 0111 (4.998 V)		5		V
	OTG output voltage accuracy	$I_{(VBUS)} = 0$, REG06[7:4] = 0111 (4.998 V)	-3%		3%	
$V_{(OTG_BAT)}$	Battery voltage exiting OTG mode	BAT falling, REG04[1] = 1	2.9			V
$I_{(OTG)}$	OTG mode output current	REG01[0] = 0	1			A
		REG01[0] = 1	1.5			A
$V_{(OTG_OVP)}$	OTG over-voltage threshold	Rising threshold	5.8	6		V
$V_{(OTG_OVP_HYS)}$	OTG over-voltage threshold hysteresis	Falling threshold		300		mV

Electrical Characteristics (接下页)

$V_{(VBUS_UVLOZ)} < V_{(VBUS)} < V_{(ACOV)}$ and $V_{(VBUS)} > V_{(BAT)} + V_{(SLEEP)}$, $T_J = -40^{\circ}\text{C}$ to 125°C and $T_J = 25^{\circ}\text{C}$ for typical values (unless otherwise noted)

PARAMETER		TEST CONDITIONS	MIN	TYP	MAX	UNIT
$I_{(OTG_LSOCP)}$	LSFET cycle by cycle current limit		5			A
$I_{(OTG_HSZCP)}$	HSFET under current falling threshold			100		mA
$I_{(RBFET_OCP)}$	RBFET overcurrent threshold	REG01[0] = 0	1.00	1.15	1.30	A
		REG01[0] = 1	1.50	1.70	1.90	
REGN LDO						
$V_{(REGN)}$	REGN LDO output voltage	$V_{(VBUS)} = 6\text{ V}$, $I_{(REGN)} = 40\text{ mA}$	4.8	5	5.5	V
		$V_{(VBUS)} = 5\text{ V}$, $I_{(REGN)} = 20\text{ mA}$	4.7	4.8		V
$I_{(REGN)}$	REGN LDO current limit	$V_{(VBUS)} = 5\text{ V}$, $V_{(REGN)} = 3.8\text{ V}$	50			mA
LOGIC I/O PIN CHARACTERISTICS (OTG, $\overline{\text{CE}}$, STAT, QON, PSEL, $\overline{\text{PG}}$)						
$V_{(ILO)}$	Input low threshold				0.4	V
$V_{(IH)}$	Input high threshold ($\overline{\text{CE}}$, STAT, QON, PSEL, $\overline{\text{PG}}$)		1.3			V
$V_{(IH(OTG))}$	Input high threshold (OTG)		1.1			V
$V_{(OUT(LO))}$	Output low saturation voltage	Sink current = 5 mA			0.4	V
$I_{(BIAS)}$	High level leakage current (OTG, $\overline{\text{CE}}$, STAT, PSEL, $\overline{\text{PG}}$)	Pull-up rail 1.8 V			1	μA
$I_{(BIAS)}$	High level leakage current (QON)	Pull-up rail 3.6 V			8	μA
I²C INTERFACE (SDA, SCL, INT)						
$V_{(IH)}$	Input high threshold level	VPULL-UP = 1.8 V, SDA and SCL	1.3			V
$V_{(IL)}$	Input low threshold level	VPULL-UP = 1.8 V, SDA and SCL			0.4	V
$V_{(OL)}$	Output low threshold level	Sink current = 5 mA			0.4	V
$I_{(BIAS)}$	High-level leakage current	VPULL-UP = 1.8 V, SDA and SCL			1	μA
$f_{(SCL)}$	SCL clock frequency				400	kHz
DIGITAL CLOCK AND WATCHDOG TIMER						
$f_{(HIZ)}$	Digital crude clock	REGN LDO disabled	15	35	50	kHz
$f_{(DIG)}$	Digital clock	REGN LDO enabled	1300	1500	1700	kHz

7.6 Timing Requirements

		MIN	TYP	MAX	UNIT
VBUS/BAT POWER UP					
t_{BADSRC}	Bad source detection duration		30		ms
BOOST MODE OPERATION					
$t_{OTG_OCP_OFF}$	OTG mode over-current protection off cycle time		32		ms
$t_{OTG_OCP_ON}$	OTG mode over-current protection on cycle time		260		μ s
QON TIMING					
t_{QON}	QON pin high time to turn on BATFET	2			ms
DIGITAL CLOCK AND WATCHDOG TIMER					
t_{WDT}	REG05[5:4] = 11	REGN LDO disabled	112	160	s
		REGN LDO enabled	136	160	



图 1. I²C-Compatible Interface Timing Diagram

7.7 Typical Characteristics

表 1. Table of Figures

	FIGURE
Charging Efficiency vs Charging Current (DCR = 10 mΩ)	图 2
System Efficiency vs System Load Current (DCR = 10 mΩ)	图 3
Boost Mode Efficiency vs $V_{(BUS)}$ Load Current (DCR = 10 mΩ)	图 4
SYS Voltage Regulation vs System Load Current	图 5
Boost Mode VBUS Voltage Regulation (Typical Output = 4.998 V, REG06[7:4] = 0111) vs VBUS Load Current	图 6
SYS Voltage vs Temperature	图 7
BAT Voltage vs Temperature	图 8
Input Current Limit vs Temperature	图 9
Charge Current vs Package Temperature	图 10

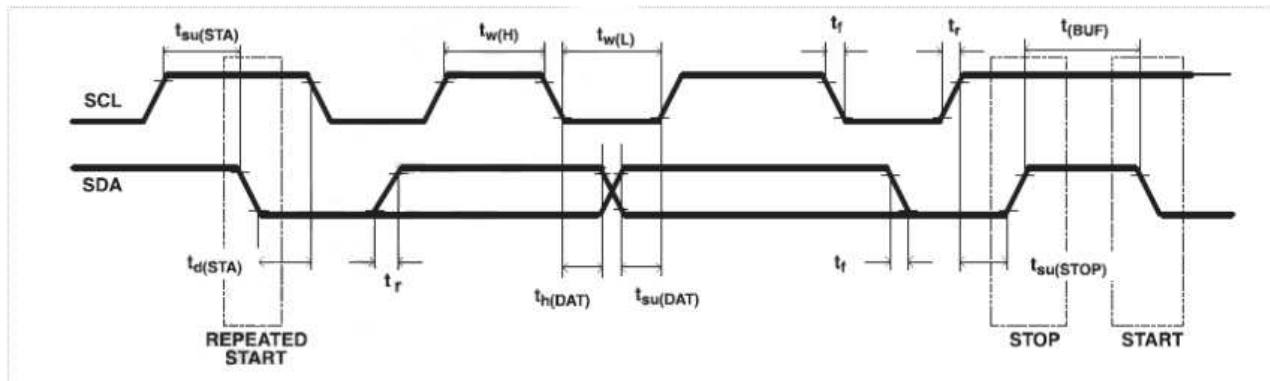

图 2. Charge Efficiency vs Charge Current



图 3. System Efficiency vs System Load Current

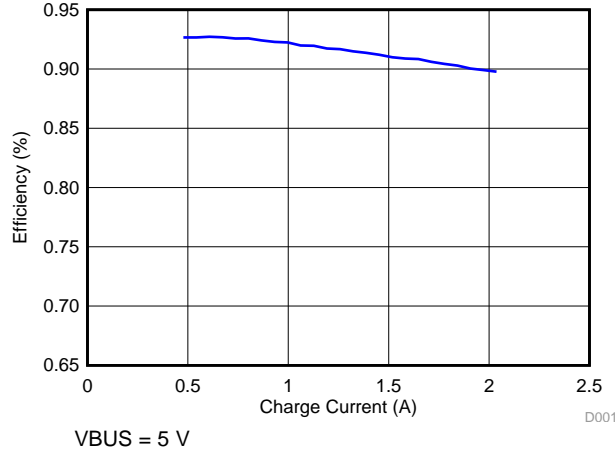

图 4. Boost Mode Efficiency vs VBUS Load Current

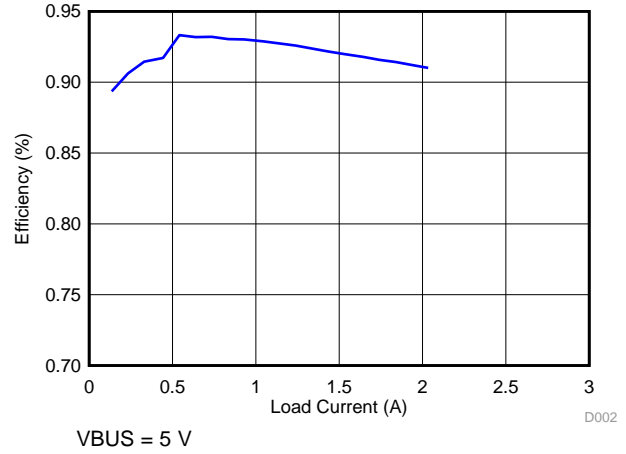

图 5. SYS Voltage Regulation vs System Load Current

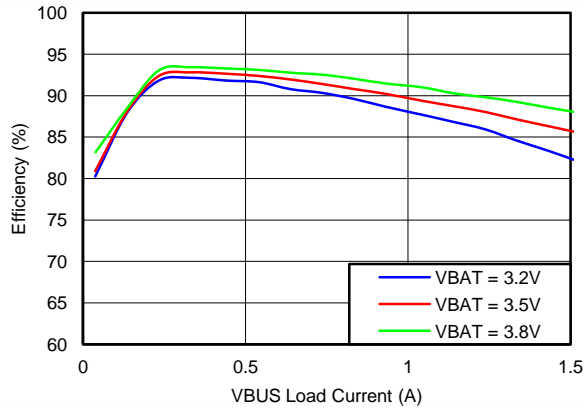

Typical Output = 4.998 V, REG06[7:4] = 0111

图 6. Boost Mode VBUS Voltage Regulation vs VBUS Load Current

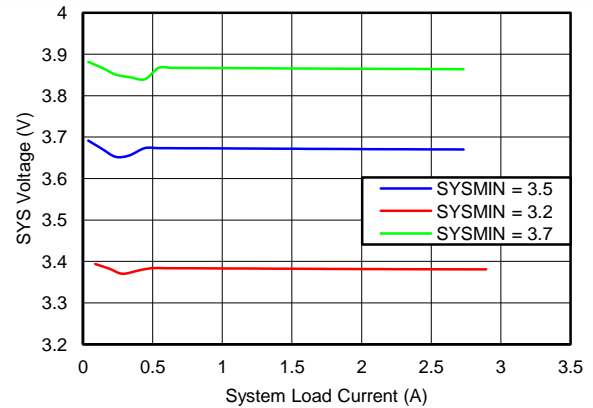
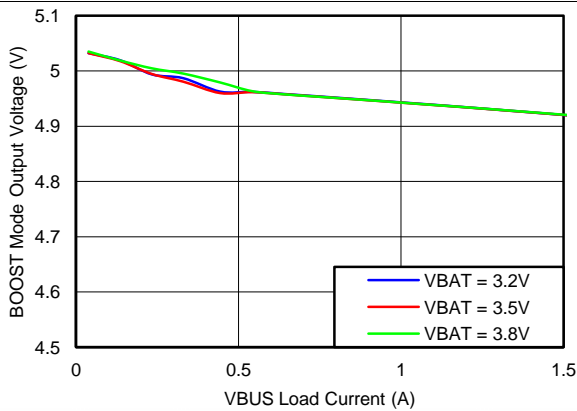

图 7. SYS Voltage vs Temperature



图 8. BAT Voltage vs Temperature

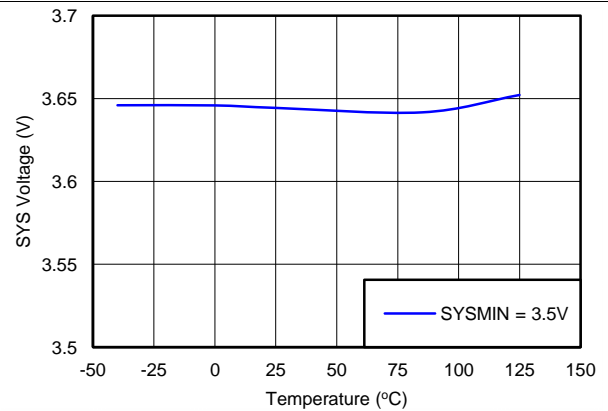

图 9. Input Current Limit vs Temperature

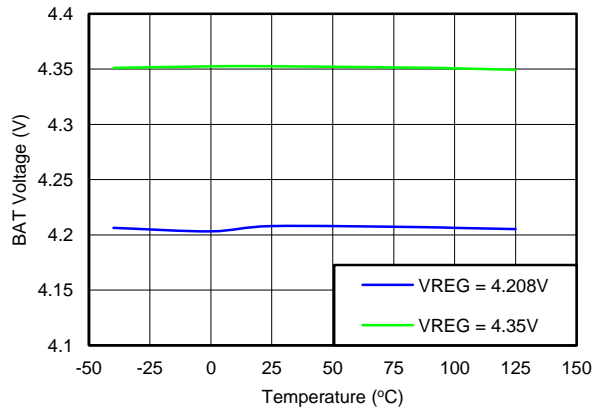

图 10. Charge Current vs Package Temperature

8.3 Feature Description

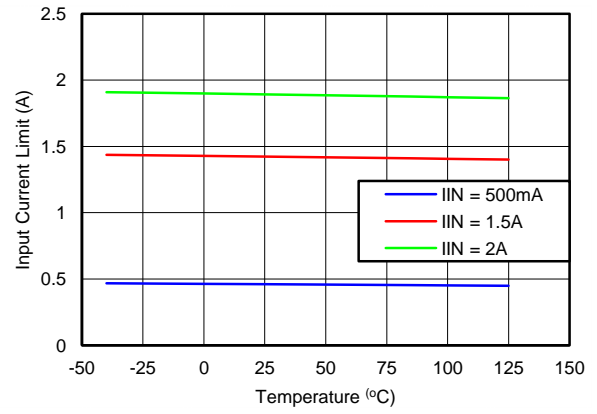
8.3.1 Device Power Up

8.3.1.1 Power-On-Reset (POR)

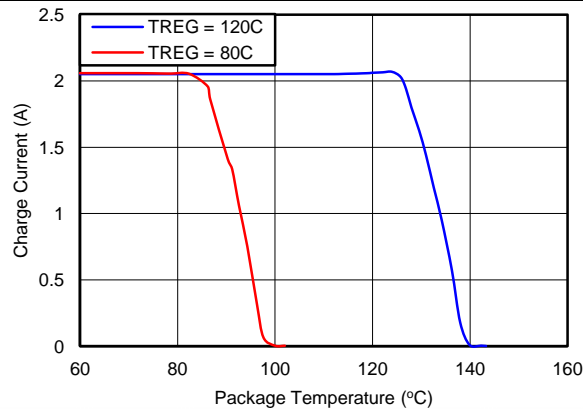
The internal bias circuits are powered from the higher voltage of VBUS and BAT. When VBUS or VBAT rises above UVLOZ, the sleep comparator, battery depletion comparator and BATFET driver are active. I²C interface is ready for communication and all the registers are reset to default value. The host can access all the registers after POR.

8.3.1.2 Power Up from Battery without DC Source

If only battery is present and the voltage is above depletion threshold (V_{BAT_DEPL}), the BATFET turns on and connects battery to system. The REGN LDO stays off to minimize the quiescent current. The low $R_{DS(ON)}$ in BATFET and the low quiescent current on BAT minimize the conduction loss and maximize the battery run time.

8.3.1.2.1 BATFET Turn Off

The BATFET can be forced off by the host through I²C REG07[5]. This bit allows the user to independently turn off the BATFET when the battery condition becomes abnormal during charging. When BATFET is off, there is no path to charge or discharge the battery. When battery is not attached, the BATFET should be turned off by setting REG07[5] to 1 to disable charging and supplement mode.

8.3.1.2.2 Shipping Mode

To extend battery life and minimize power when system is powered off during system idle, shipping, or storage, the device can turn off BATFET so that the system voltage is zero to minimize the leakage. The BATFET can be turned off by setting REG07[5] (BATFET_DISABLE) bit.

In order to keep BATFET off during shipping mode, the host has to disable the watchdog timer (REG05[5:4] = 00) and disable BATFET (REG07[5] = 1) at the same time. Once the BATFET is disabled, one of the following events can turn on BATFET and clear REG07[5] (BATFET_DISABLE) bit.

1. Plug in adapter
2. Write REG07[5] = 0
3. watchdog timer expiration
4. Register reset (REG01[7] = 1)
5. A logic low to high transition on QON pin (refer to [图 11](#) for detail timing)



图 11. QON Timing

8.3.1.3 Power Up from DC Source

When the DC source plugs in, the charger device checks the input source voltage to turn on REGN LDO and all the bias circuits. It also checks the input current limit before starts the buck converter.

Feature Description (接下页)

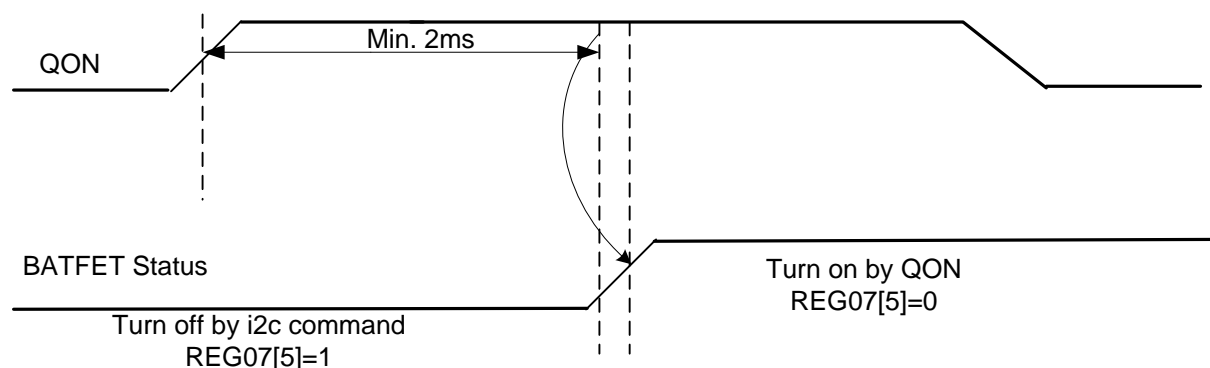
8.3.1.3.1 REGN LDO

The REGN LDO supplies internal bias circuits as well as the HSFET and LSFET gate drive. The LDO also provides bias rail to TS external resistors. The pull-up rail of STAT and PG (bq24259) can be connected to REGN as well.

The REGN is enabled when all the conditions are valid.

1. VBUS above V_{VBUS_UVLOZ}
2. VBUS above $V_{BAT} + V_{SLEEPZ}$ in buck mode or VBUS below $V_{BAT} + V_{SLEEP}$ in boost mode
3. After typical 220-ms delay (100 ms minimum) is complete

If one of the above conditions is not valid, the device is in high impedance mode (HIZ) with REGN LDO off. The device draws less than $I_{(VBUS)}$ (15 μ A typical) from VBUS during HIZ state. The battery powers up the system when the device is in HIZ.

8.3.1.3.2 Input Source Qualification

After REGN LDO powers up, the device checks the current capability of the input source. The input source has to meet the following requirements to start the buck converter.

1. VBUS voltage below $V_{(ACOV)}$ (not in VBUS overvoltage)
2. VBUS voltage above $V_{(BADSRC)}$ (3.8 V typical) when pulling $I_{(BADSRC)}$ (30 mA typical) (poor source detection)

Once the input source passes all the conditions above, the status register REG08[2] goes high and the \overline{PG} pin (bq24259) goes low. An INT is asserted to the host.

If the device fails the poor source detection, it will repeat the detection every 2 seconds.

8.3.1.3.3 Input Current Limit Detection

After the \overline{PG} is LOW (bq24259) or REG08[2] goes HIGH, the charger device always runs input current limit detection when a DC source plugs in unless the charger is in HIZ during host mode.

The bq24259 sets input current limit through PSEL and OTG pins. After the input current limit detection is done, the detection result is reported in VBUS_STAT registers (REG08[7:6]) and input current limit is updated in IINLIM register (REG00[2:0]). In addition, host can write to REG00[2:0] to change the input current limit.

8.3.1.3.4 PSEL/OTG Pins Set Input Current Limit

The bq24259 has PSEL pin which directly takes the USB PHY device output to decide whether the input is USB host or charging port.

表 2. Input Current Limit Detection

PSEL	OTG	INPUT CURRENT LIMIT	REG08[7:6]
HIGH	LOW	100 mA	01
HIGH	HIGH	500 mA	01
LOW	—	3 A	10

8.3.1.3.5 HIZ State with 100 mA USB Host

In battery charging spec, the good battery threshold is the minimum charge level of a battery to power up the portable device successfully. When the input source is 100-mA USB host, and the battery is above bat-good threshold (V_{BATGD}), the device follows battery charging spec and enters high impedance state (HIZ). In HIZ state, the device is in the lowest quiescent state with REGN LDO and the bias circuits off. The charger device sets REG00[7] to 1, and the VBUS current during HIZ state will be less than 30 μ A. The system is supplied by the battery.

Once the charger device enters HIZ state in host mode, it stays in HIZ until the host writes REG00[7] = 0. When the processor host wakes up, it is recommended to first check if the charger is in HIZ state.

In default mode, the charger IC will reset REG00[7] back to 0 when input source is removed. When another source plugs in, the charger IC will run detection again, and update the input current limit.

8.3.1.3.6 Force Input Current Limit Detection

While adapter is plugged-in, the host can force the charger device to run input current limit detection by setting REG07[7] = 1 or when watchdog timeout. During the forced detection, the input current limit is set to 100 mA. After the detection is completed, REG07[7] will return to 0 by itself and new input current limit is set based on PSEL/OTG (bq24259).

8.3.1.4 Converter Power-Up

After the input current limit is set, the converter is enabled and the HSFET and LSFET start switching. If battery charging is disabled, BATFET turns off. Otherwise, BATFET stays on to charge the battery.

The device provides soft-start when ramp up the system rail. When the system rail is below 2.2 V, the input current limit is forced to 100mA. After the system rises above 2.2 V, the charger device sets the input current limit set by the lower value between register and ILIM pin.

As a battery charger, the charger deploys a 1.5-MHz step-down switching regulator. The fixed frequency oscillator keeps tight control of the switching frequency under all conditions of input voltage, battery voltage, charge current and temperature, simplifying output filter design.

A type III compensation network allows using ceramic capacitors at the output of the converter. An internal saw-tooth ramp is compared to the internal error control signal to vary the duty cycle of the converter. The ramp height is proportional to the PMID voltage to cancel out any loop gain variation due to a change in input voltage.

In order to improve light-load efficiency, the device switches to PFM control at light load when battery is below minimum system voltage setting or charging is disabled. During the PFM operation, the switching duty cycle is set by the ratio of SYS and VBUS.

8.3.1.5 Boost Mode Operation from Battery

The device supports boost converter operation to deliver power from the battery to other portable devices through USB port. The boost mode output current rating meets the USB On-The-Go 1-A output requirement. The maximum output current is 1.5 A. The boost operation can be enabled if the following conditions are valid:

1. BAT above BATLOWV threshold (V_{BATLOWV} set by REG04[1])
2. VBUS less than $V_{\text{BAT}} + V_{\text{SLEEP}}$ (in sleep mode)
3. Boost mode operation is enabled (OTG pin HIGH and REG01[5:4] = 10)
4. Thermistor Temperature is within boost mode temperature monitor threshold unless BHOT[1:0] is set to 11 (REG06[1:0]) to disable this monitor function
5. After 30 ms delay from boost mode enable

In boost mode, the device employs a 1.5-MHz step-up switching regulator. Similar to buck operation, the device switches from PWM operation to PFM operation at light load to improve efficiency.

During boost mode, the status register REG08[7:6] is set to 11, the VBUS output is 5 V and the output current can reach up to 1 A or 1.5 A, selected via I²C (REG01[0]). In addition, the device provides adjustable boost voltage from 4.55 V to 5.5 V by changing BOOSTV bits in REG06[7:4]

Any fault during boost operation, including VBUS over-voltage or over-current, sets the fault register REG09[6] to 1 and an INT is asserted.

8.3.2 Power Path Management

The device accommodates a wide range of input sources from USB, wall adapter, to car battery. The device provides automatic power path selection to supply the system (SYS) from input source (VBUS), battery (BAT), or both.

8.3.2.1 Narrow VDC Architecture

The device deploys Narrow VDC architecture (NVDC) with BATFET separating system from battery. The minimum system voltage is set by REG01[3:1]. Even with a fully depleted battery, the system is regulated above the minimum system voltage (default 3.5 V).

When the battery is below minimum system voltage setting, the BATFET operates in linear mode (LDO mode), and the system is 150 mV above the minimum system voltage setting. As the battery voltage rises above the minimum system voltage, BATFET is fully on and the voltage difference between the system and battery is the V_{DS} of BATFET. The status register REG08[0] goes high when the system is in minimum system voltage regulation.

When the battery charging is disabled or terminated, and the battery voltage is above the minimum system voltage setting, the system is always regulated at 70 mV above the battery voltage.



图 12. $V_{(SYS)}$ vs $V_{(BAT)}$

8.3.2.2 Dynamic Power Management

To meet maximum current limit in USB spec and avoid over loading the adapter, the device features Dynamic Power Management (DPM), which continuously monitors the input current and input voltage.

When input source is over-loaded, either the current exceeds the input current limit (REG00[2:0]) or the voltage falls below the input voltage limit (REG00[6:3]). The device then reduces the charge current until the input current falls below the input current limit and the input voltage rises above the input voltage limit.

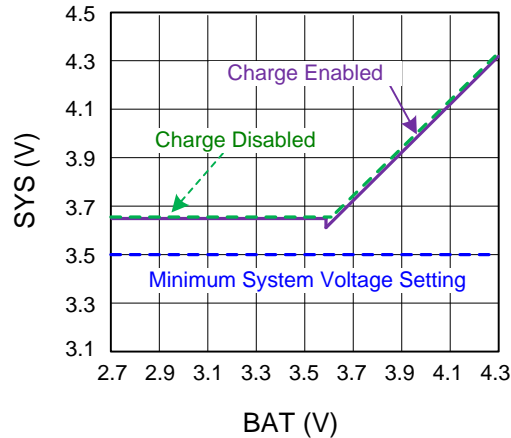
When the charge current is reduced to zero, but the input source is still overloaded, the system voltage starts to drop. Once the system voltage falls below the battery voltage, the device automatically enters the supplement mode where the BATFET turns on and battery starts discharging so that the system is supported from both the input source and battery.

During DPM mode (either $V_{IN(DPM)}$ or $I_{IN(DPM)}$), the status register REG08[3] will go high.

图 13 shows the DPM response with 5-V/1.2-A adapter, 3.2-V battery, 2-A charge current and 3.4-V minimum system voltage setting.



图 13. DPM Response

8.3.2.3 Supplement Mode

When the system voltage falls below the battery voltage, the BATFET turns on and the BATFET gate is regulated the gate drive of BATFET so that the minimum BATFET V_{DS} stays at 30 mV when the current is low. This prevents oscillation from entering and exiting the supplement mode. As the discharge current increases, the BATFET gate is regulated with a higher voltage to reduce $R_{DS(ON)}$ until the BATFET is in full conduction. At this point onwards, the BATFET V_{DS} linearly increases with discharge current. 图 14 shows the V-I curve of the BATFET gate regulation operation. BATFET turns off to exit supplement mode when the battery is below battery depletion threshold.

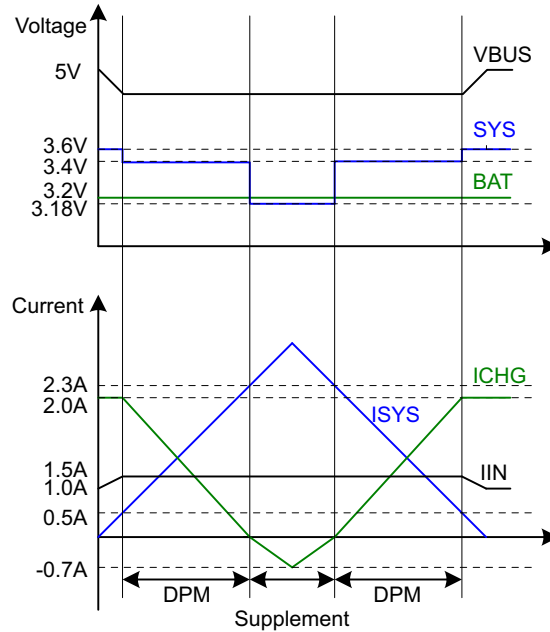

图 14. BATFET V-I Curve

8.3.3 Battery Charging Management

The device charges 1-cell Li-Ion battery with up to 2-A charge current for high capacity tablet battery. The 24-mΩ BATFET improves charging efficiency and minimizes the voltage drop during discharging.

8.3.3.1 Autonomous Charging Cycle

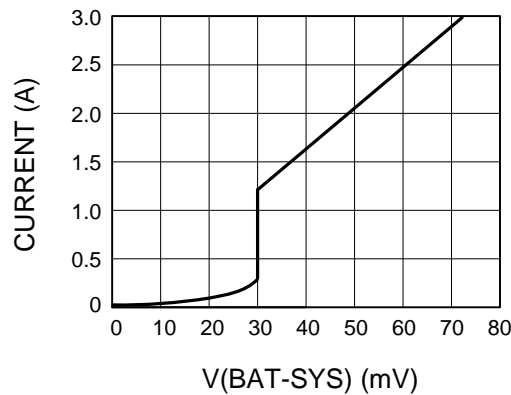
With battery charging enabled at POR (REG01[5:4] = 01), the charger device complete a charging cycle without host involvement. The device default charging parameters are listed in 表 3.

表 3. Charging Parameter Default Setting

DEFAULT MODE	bq24259
Charging voltage	4.208 V
Charging current	2.048 A
Pre-charge current	128 mA
Termination current	256 mA
Temperature profile	Hot/Cold
Safety timer	12 hours ⁽¹⁾

(1) See [Charging Safety Timer](#) for more information.

A new charge cycle starts when the following conditions are valid:

- Converter starts
- Battery charging is enabled by I²C register bit (REG01[5:4]) = 01 and \overline{CE} is low
- No thermistor fault on TS
- No safety timer fault
- BATFET is not forced to turn off (REG07[5])

The charger device automatically terminates the charging cycle when the charging current is below termination threshold and charge voltage is above recharge threshold. When a full battery voltage is discharged below recharge threshold (REG04[0]), the device automatically starts another charging cycle. After the charge done, either toggle \overline{CE} pin or REG01[5:4] will initiate a new charging cycle.

The STAT output indicates the charging status of charging (LOW), charging complete or charge disable (HIGH) or charging fault (Blinking). The status register REG08[5:4] indicates the different charging phases: 00-charging disable, 01-precharge, 10-fast charge (constant current) and constant voltage mode, 11-charging done. Once a charging cycle is complete, an INT is asserted to notify the host.

The host can always control the charging operation and optimize the charging parameters by writing to the registers through I²C.

8.3.3.2 Battery Charging Profile

The device charges the battery in three phases: preconditioning, constant current and constant voltage. At the beginning of a charging cycle, the device checks the battery voltage and applies current.

表 4. Charging Current Setting

VBAT	CHARGING CURRENT	REG DEFAULT SETTING	REG08[5:4]
$V_{(BAT)} < V_{(SHORT)}$ (Typical 2 V)	100 mA	–	01
$V_{SHORT} \leq V_{BAT} < V_{(BATLOWV)}$ (Typical 2 V $\leq V_{(BAT)} < 3$ V)	REG03[7:4]	128 mA	01
$V_{(BAT)} \geq V_{(BATLOWV)}$ (Typical $V_{(BAT)} \geq 3$ V)	REG02[7:2]	2048 mA	10

If the charger device is in DPM regulation or thermal regulation during charging, the actual charging current will be less than the programmed value. In this case, termination is temporarily disabled and the charging safety timer is counted at half the clock rate.



图 15. Battery Charging Profile

8.3.3.3 Thermistor Qualification

The charger device provides a single thermistor input for battery temperature monitor.

8.3.3.3.1 Cold/Hot Temperature Window

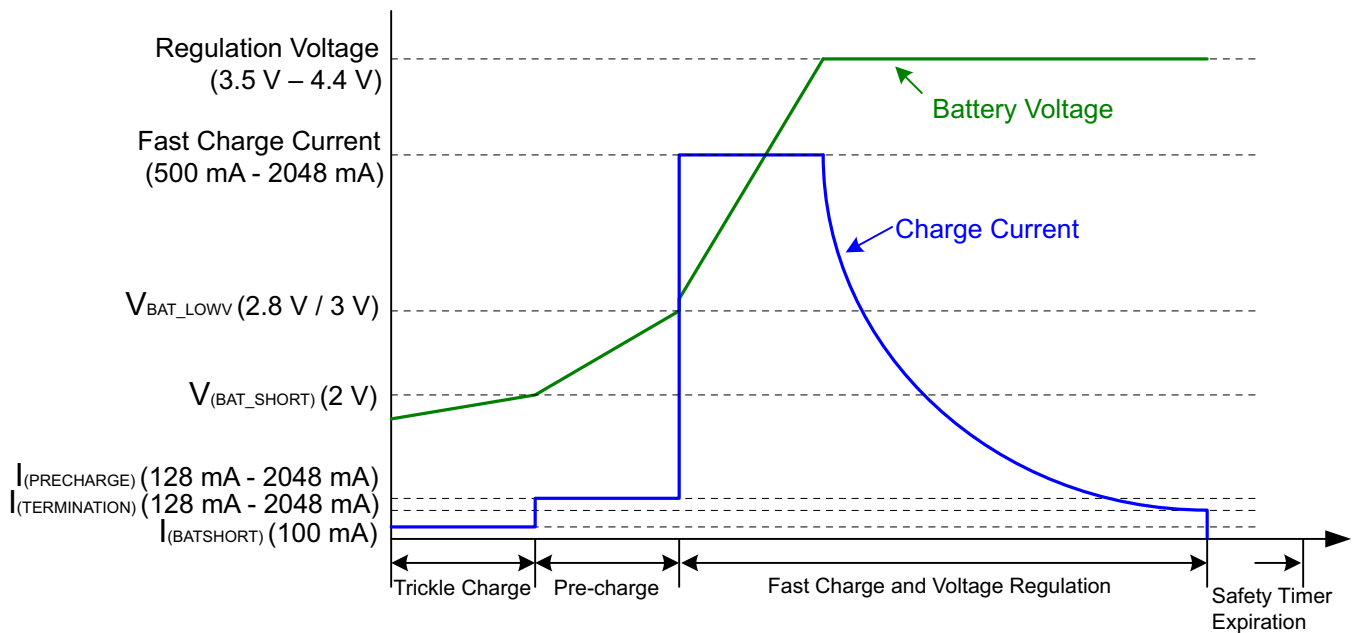
The device continuously monitors battery temperature by measuring the voltage between the TS pin and ground, typically determined by a negative temperature coefficient thermistor and an external voltage divider. The device compares this voltage against its internal thresholds to determine if charge or boost is allowed.

To initiate a charge cycle, the battery temperature must be within the $V_{(LTF)}$ to $V_{(HTF)}$ thresholds. During the charge cycle the battery temperature must be within the $V_{(LTF)}$ to $V_{(TCO)}$ thresholds, else the device suspends charging and waits until the battery temperature is within the $V_{(LTF)}$ to $V_{(HTF)}$ range.

For battery protection during boost mode, the device monitors the battery temperature to be within the $V_{(BCOLDX)}$ to $V_{(HOTX)}$ thresholds unless boost mode temperature is disabled by setting BHOT bits (REG06[3:2]) to 11. When temperature is outside of the temperature thresholds, the boost mode is suspended and REG08[7:6] bits (VBUS_STAT) are set to 00. Once temperature returns within thresholds, the boost mode is recovered.



图 16. TS Resistor Network

When the TS fault occurs, the fault register REG09[2:0] indicates the actual condition on each TS pin and an INT is asserted to the host. The STAT pin indicates the fault when charging is suspended.



图 17. TS Pin Thermistor Sense Thresholds in Charge Mode

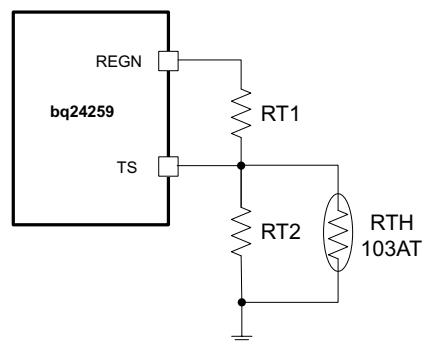

图 18. TS Pin Thermistor Sense Thresholds in Boost Mode

Assuming a 103AT NTC thermistor is used on the battery pack 图 17, the value RT1 and RT2 can be determined by using the following equation:

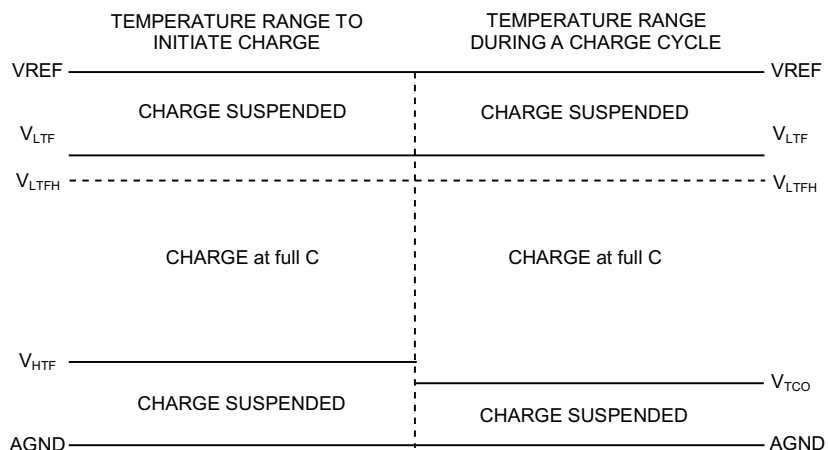
$$RT2 = \frac{V_{VREF} \times RTH_{COLD} \times RTH_{HOT} \times \left(\frac{1}{V_{LTF}} - \frac{1}{V_{TCO}} \right)}{RTH_{HOT} \times \left(\frac{V_{VREF}}{V_{TCO}} - 1 \right) - RTH_{COLD} \times \left(\frac{V_{VREF}}{V_{LTF}} - 1 \right)}$$

$$RT1 = \frac{\frac{V_{VREF}}{V_{LTF}} - 1}{\frac{1}{RT2} + \frac{1}{RTH_{COLD}}}$$

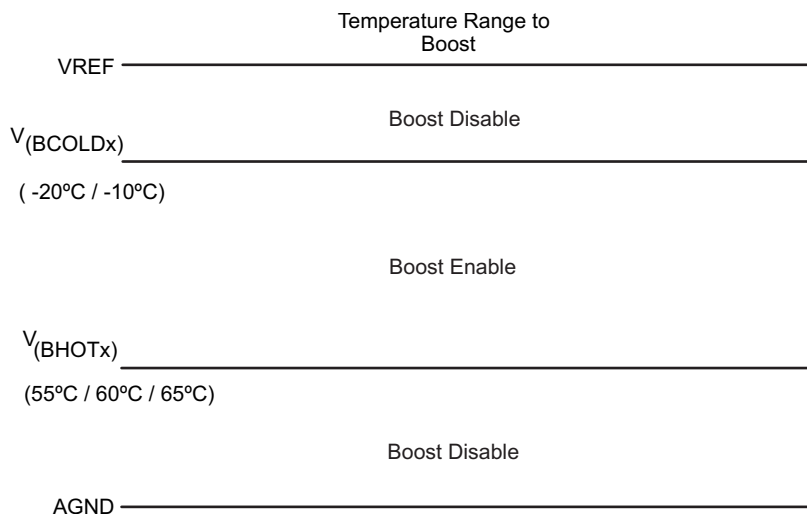
(1)

Select 0°C to 45°C range for Li-ion or Li-polymer battery,

$RTH_{COLD} = 27.28 \text{ k}\Omega$

$RTH_{HOT} = 4.911 \text{ k}\Omega$

RT1 = 5.25 kΩ

RT2 = 31.23 kΩ

8.3.3.4 Charging Termination

The device terminates a charge cycle when the battery voltage is above recharge threshold, and the current is below termination current. After the charging cycle is complete, the BATFET turns off. The converter keeps running to power the system, and BATFET can turn back on to engage supplement mode.

When termination occurs, the status register REG08[5:4] is 11, and an INT is asserted to the host. Termination is temporarily disabled if the charger device is in input current/voltage regulation or thermal regulation. Termination can be disabled by writing 0 to REG05[7].

8.3.3.4.1 Termination When REG02[0] = 1

When REG02[0] is HIGH to reduce the charging current by 80%, the charging current could be less than the termination current. The charger device termination function should be disabled. When the battery is charged to fully capacity, the host disables charging through CE pin or REG01[5:4].

8.3.3.5 Charging Safety Timer

The device has safety timer to prevent extended charging cycle due to abnormal battery conditions. The safety timer is 4 hours when the battery is below batlowv threshold. The user can program fast charge safety timer (default 12 hours) through I²C (REG05[2:1]). When safety timer expires, the fault register REG09[5:4] goes 11 and an INT is asserted to the host. The safety timer feature can be disabled via I²C (REG05[3]).

The following actions restart the safety timer after safety timer expires:

- Toggle the CE pin HIGH to LOW to HIGH (charge enable)
- Write REG01[5:4] from 00 to 01 (charge enable)
- Write REG05[3] from 0 to 1 (safety timer enable)

During input voltage/current regulation, thermal regulation, or FORCE_20PCT bit (REG02[0]) is set, the safety timer counting at half clock rate since the actual charge current is likely to be below the register setting. For example, if the charger is in input current regulation (IINDPM) throughout the whole charging cycle, and the safety time is set to 5 hours, the safety timer will expire in 10 hours. This feature can be disabled by writing 0 to REG07[6].

8.3.3.5.1 Safety Timer Configuration Change

When safety timer value needs to be changed, it is recommended that the timer is disabled first before new configuration is written to REG05[2:1]. The safety timer can be disabled by writing 1 to REG05[3]. This ensures the safety timer restart counting after new value is configured.

8.3.3.6 USB Timer When Charging from USB100 mA Source

The total charging time in default mode from USB100 mA source is limited by a 45-min max timer. At the end of the timer, the device stops the converter and goes to HIZ.

8.3.4 Status Outputs ($\overline{\text{PG}}$, STAT, and INT)

8.3.4.1 Power Good Indicator ($\overline{\text{PG}}$)

In bq24259, $\overline{\text{PG}}$ goes LOW to indicate a good input source when:

1. VBUS above $V_{(\text{BUS_UVLO})}$
2. VBUS above battery (not in sleep)
3. VBUS below $V_{(\text{ACOV})}$ threshold
4. VBUS above $V_{(\text{BUS_MIN})}$ when I_{BADSRC} current is applied (not a poor source)

8.3.4.2 Charging Status Indicator (STAT)

The device indicates charging state on the open drain STAT pin. The STAT pin can drive LED as the application diagram shows.

表 5. STAT Pin State

CHARGING STATE	STAT
Charging in progress (including recharge)	LOW
Charging complete	HIGH
Sleep mode, charge disable	HIGH

8.3.4.3 Interrupt to Host (INT)

In some applications, the host does not always monitor the charger operation. The INT notifies the system on the device operation. The following events will generate a 256- μ s INT pulse.

1. USB/adaptor source identified (through PSEL detection and OTG pin)
2. Good input source detected
 - not in sleep
 - VBUS below V_{ACOV} threshold
 - current limit above I_{BADSRC}
3. Input removed or VBUS above V_{ACOV} threshold
4. Charge Complete
5. Any FAULT event in REG09

For the first four events, INT pulse is always generated. For the last event, when a fault occurs, the charger device sends out INT and latches the fault state in REG09 until the host reads the fault register. If a prior fault exists, the charger device would not send any INT upon new faults except NTC fault (REG09[2:0]). The NTC fault is not latched and always reports the current thermistor conditions. In order to read the current fault status, the host has to read REG09 two times consecutively. The 1st reads fault register status from the last read and the 2nd reads the current fault register status.

8.3.5 Protections

8.3.5.1 Input Current Limit on ILIM

For safe operation, the device has an additional hardware pin on ILIM to limit maximum input current on ILIM pin. The input maximum current is set by a resistor from ILIM pin to ground as:

$$I_{INMAX} = \frac{1V}{R_{ILIM}} \times K_{LIM} \quad (2)$$

The actual input current limit is the lower value between ILIM setting and register setting (REG00[2:0]). For example, if the register setting is 111 for 2 A, and ILIM has a 316- Ω resistor to ground for 1.5 A, the input current limit is 1.5 A. ILIM pin can be used to set the input current limit rather than the register settings.

The device regulates ILIM pin at 1 V. If ILIM voltage exceeds 1 V, the device enters input current regulation (Refer to the [Dynamic Power Management](#) section).

The voltage on ILIM pin is proportional to the input current. ILIM pin can be used to monitor the input current following [公式 3](#):

$$I_{IN} = \frac{V_{ILIM}}{1V} \times I_{INMAX} \quad (3)$$

For example, if ILIM pin sets 2 A, and the ILIM voltage is 0.75 V, the actual input current 1.5 A. If ILIM pin is open, the input current is limited to zero since ILIM voltage floats above 1 V. If ILIM pin is short, the input current limit is set by the register.

8.3.5.2 Thermal Regulation and Thermal Shutdown

During charge operation, the device monitors the internal junction temperature T_J to avoid overheat the chip and limits the IC surface temperature. When the internal junction temperature exceeds the preset limit (REG06[1:0]), the device lowers down the charge current. The wide thermal regulation range from 60°C to 120°C allows the user to optimize the system thermal performance.

During thermal regulation, the actual charging current is usually below the programmed battery charging current. Therefore, termination is disabled, the safety timer runs at half the clock rate, and the status register REG08[1] goes high.

Additionally, the device has thermal shutdown to turn off the converter. The fault register REG09[5:4] is 10 and an INT is asserted to the host.

8.3.5.3 Voltage and Current Monitoring in Buck Mode

The device closely monitors the input and system voltage, as well as HSFET current for safe buck mode operation.

8.3.5.3.1 Input Over Voltage (ACOV)

The maximum input voltage for buck mode operation is $V_{(VBUS_OP)}$. If VBUS voltage exceeds $V_{(ACOV)}$, the device stops switching immediately. During input over voltage (ACOV), the fault register REG09[5:4] will be set to 01. An INT is asserted to the host.

8.3.5.3.2 System Over Voltage Protection (SYSOVP)

The charger device clamps the system voltage during load transient so that the components connect to system would not be damaged due to high voltage. When SYSOVP is detected, the converter stops immediately to clamp the overshoot.

8.3.5.4 Voltage and Current Monitoring in Boost Mode

The charger device closely monitors the VBUS voltage, as well as LSFET current to ensure safe boost mode operation.

8.3.5.4.1 Over Current Protection

The charger device closely monitors the RBFET (Q1) and LSFET (Q3) current to ensure safe boost mode operation. During over-current condition, the device will operate in hiccup mode for protection. While in hiccup mode cycle, the device turns off RBFET for $t_{OTG_OCP_OFF}$ (32 ms typical) and turns on RBFET for $t_{OTG_OCP_ON}$ (260 us typical) in an attempt to restart. If the over-current condition is removed, the boost converter will maintain the RBFET on state and the VBUS OTG output will operate normally. When over-current condition continues to exist, the device will repeat the hiccup cycle until overcurrent condition is removed. When overcurrent condition is detected, the fault register bit BOOST_FAULT (REG09[6]) is set high to indicate fault in boost operation. An INT is asserted to the host.

8.3.5.4.2 VBUS Over Voltage Protection

When an adapter plugs in during boost mode, the VBUS voltage will rise above regulation target. Once the VBUS voltage exceeds V_{OTG_OVP} , the device stops switching and the device exits boost mode. During the over-voltage, the fault register bit BOOST_FAULT (REG09[6]) is set high to indicate fault in boost operation. An INT is asserted to the host.

8.3.5.5 Battery Protection

8.3.5.5.1 Battery Over-Voltage Protection (BATOVP)

The battery over-voltage limit is clamped at $V_{(BAT_OVP)}$ (4% nominal) above the battery regulation voltage. When battery over voltage occurs, the charger device immediately disables charge. The fault register REG09[3] goes high and an INT is asserted to the host.

8.3.5.5.2 Battery Short Protection

If the battery voltage falls below $V_{(SHORT)}$ (2 V typical), the device immediately turns off BATFET to disable the battery charging or supplement mode. 1 ms later, the BATFET turns on and charge the battery with 100-mA current. The device does not turn on BATFET to discharge a battery that is below 2.5 V.

8.4 Device Functional Modes

8.4.1 Host Mode and Default Mode

The device is a host controlled device, but it can operate in default mode without host management. In default mode, the device can be used as an autonomous charger with no host or with host in sleep.

When the charger is in default mode, REG09[7] is HIGH. When the charger is in host mode, REG09[7] is LOW. After power-on-reset, the device starts in watchdog timer expiration state, or default mode. All the registers are in the default settings. The device keeps charging the battery by default with 12-hour fast charging safety timer. At the end of the 12 hours, the charging is stopped and the buck converter continues to operate to supply system load.

Any write command to device transitions the device from default mode to host mode. All the device parameters can be programmed by the host. To keep the device in host mode, the host has to reset the watchdog timer by writing 1 to REG01[6] before the watchdog timer expires (REG05[5:4]), or disable watchdog timer by setting REG05[5:4] = 00.

When the host changes watchdog timer configuration (REG05[5:4]), it is recommended to first disable watchdog by writing 00 to REG05[5:4] and then change the watchdog to new timer values. This ensures the watchdog timer is restarted after new value is written.



图 19. Watchdog Timer Flow Chart

8.4.1.1 Plug in USB100 mA Source with Good Battery

When the input source is detected as 100 mA USB host, and the battery voltage is above batgood threshold ($V_{(BATGD)}$), the charger device enters HIZ state to meet the battery charging spec requirement.

If the charger device is in host mode, it will stay in HIZ state even after the USB100 mA source is removed, and the adapter plugs in. During the HIZ state, REG00[7] is set HIGH and the system load is supplied from battery. It is recommended that the processor host always checks if the charger IC is in HIZ state when it wakes up. The host can write REG00[7] to 0 to exit HIZ state.

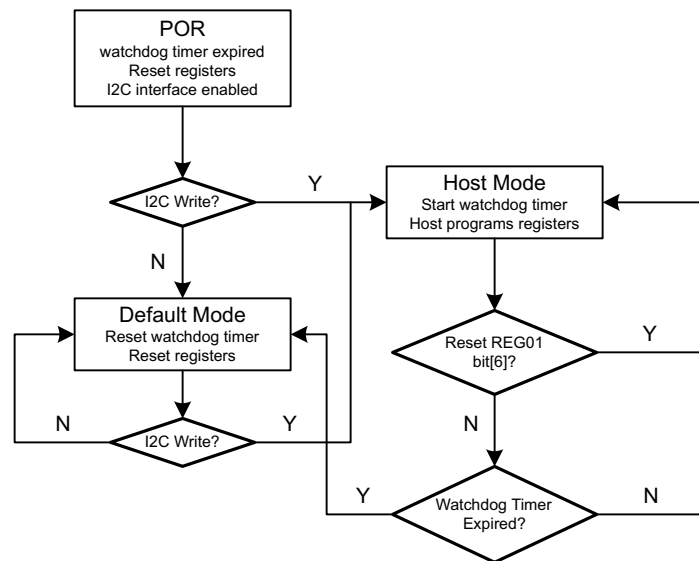
If the charger is in default mode, when the DC source is removed, the charger device will get out of HIZ state automatically. When the input source plugs in again, the charger IC runs detection on the input source and update the input current limit.

8.4.1.2 USB Timer When Charging from USB100 mA Source

The total charging time in default mode from USB100 mA source is limited by a 45-min max timer. At the end of the timer, the device stops the converter and goes to HIZ.

8.5 Programming

8.5.1 Serial Interface

The device uses I²C compatible interface for flexible charging parameter programming and instantaneous device status reporting. I²C is a bi-directional 2-wire serial interface. Only two bus lines are required: a serial data line (SDA) and a serial clock line (SCL). Devices can be considered as masters or slaves when performing data transfers. A master is the device which initiates a data transfer on the bus and generates the clock signals to permit that transfer. At that time, any device addressed is considered a slave.

The device operates as a slave device with address 6BH, receiving control inputs from the master device like micro controller or a digital signal processor. The I²C interface supports both standard mode (up to 100 kbits), and fast mode (up to 400 kbits).

Both SDA and SCL are bi-directional lines, connecting to the positive supply voltage via a current source or pull-up resistor. When the bus is free, both lines are HIGH. The SDA and SCL pins are open drain.

8.5.1.1 Data Validity

The data on the SDA line must be stable during the HIGH period of the clock. The HIGH or LOW state of the data line can only change when the clock signal on the SCL line is LOW. One clock pulse is generated for each data bit transferred.



图 20. Bit Transfer on the I²C Bus

8.5.1.2 START and STOP Conditions

All transactions begin with a START (S) and can be terminated by a STOP (P). A HIGH to LOW transition on the SDA line while SCL is HIGH defines a START condition. A LOW to HIGH transition on the SDA line when the SCL is HIGH defines a STOP condition.

START and STOP conditions are always generated by the master. The bus is considered busy after the START condition, and free after the STOP condition.

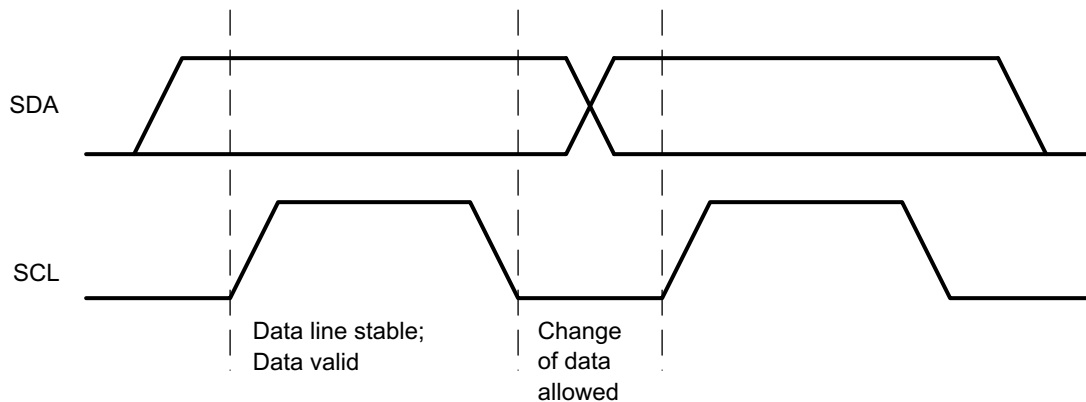

图 21. START and STOP Conditions

Programming (接下页)

8.5.1.3 Byte Format

Every byte on the SDA line must be 8 bits long. The number of bytes to be transmitted per transfer is unrestricted. Each byte has to be followed by an Acknowledge bit. Data is transferred with the Most Significant Bit (MSB) first. If a slave cannot receive or transmit another complete byte of data until it has performed some other function, it can hold the clock line SCL low to force the master into a wait state (clock stretching). Data transfer then continues when the slave is ready for another byte of data and release the clock line SCL.

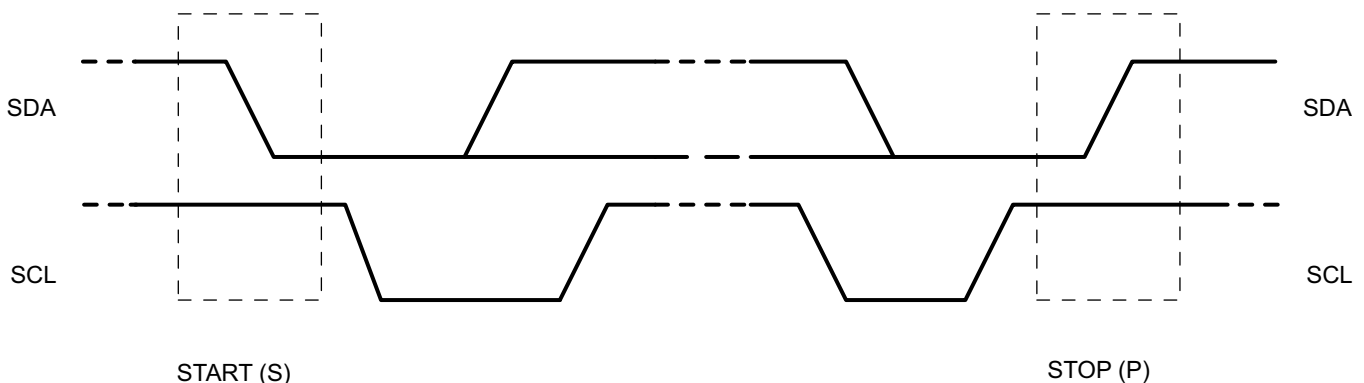

图 22. Data Transfer on the I²C Bus

8.5.1.4 Acknowledge (ACK) and Not Acknowledge (NACK)

The acknowledge takes place after every byte. The acknowledge bit allows the receiver to signal the transmitter that the byte was successfully received and another byte may be sent. All clock pulses, including the acknowledge 9th clock pulse, are generated by the master.

The transmitter releases the SDA line during the acknowledge clock pulse so the receiver can pull the SDA line LOW and it remains stable LOW during the HIGH period of this clock pulse.

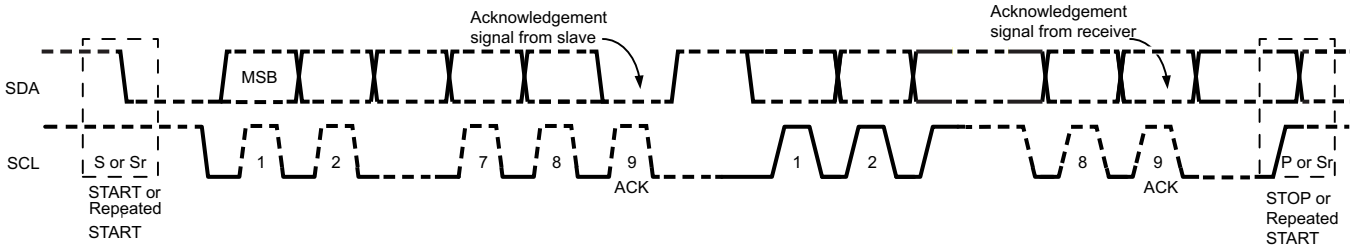
When SDA remains HIGH during the 9th clock pulse, this is the Not Acknowledge signal. The master can then generate either a STOP to abort the transfer or a repeated START to start a new transfer.

8.5.1.5 Slave Address and Data Direction Bit

After the START, a slave address is sent. This address is 7 bits long followed by the eighth bit as a data direction bit (bit R/W). A zero indicates a transmission (WRITE) and a one indicates a request for data (READ).



图 23. Complete Data Transfer

8.5.1.5.1 Single Read and Write

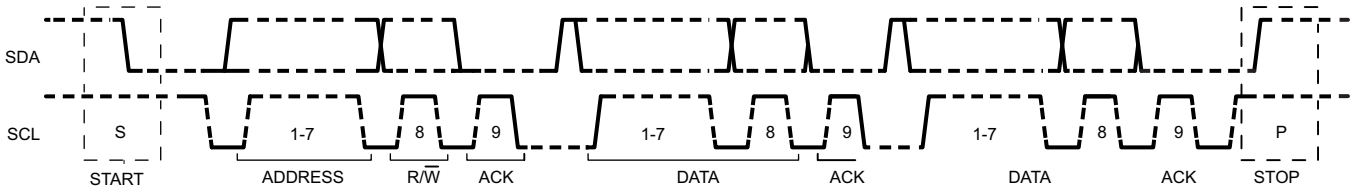

图 24. Single Write

Programming (接下页)

图 25. Single Read

If the register address is not defined, the charger IC send back NACK and go back to the idle state.

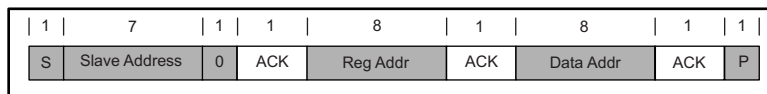
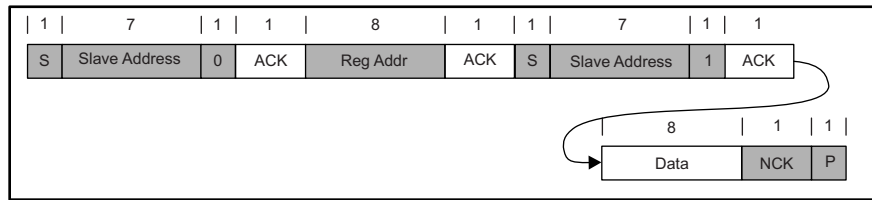
8.5.1.5.2 Multi-Read and Multi-Write

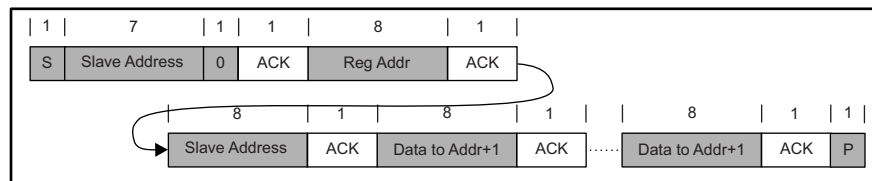
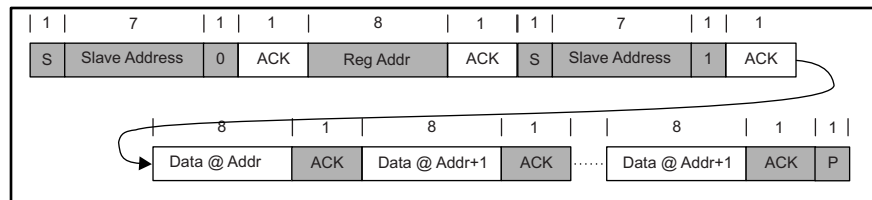
The charger device supports multi-read and multi-write on REG00 through REG08.

图 26. Multi-Write

图 27. Multi-Read

The fault register REG09 locks the previous fault and only clears it after the register is read. For example, if Charge Safety Timer Expiration fault occurs but recovers later, the fault register REG09 reports the fault when it is read the first time, but returns to normal when it is read the second time. To verify real time fault, the fault register REG09 should be read twice to get the real condition. In addition, the fault register REG09 does not support multi-read or multi-write.

REG09 is a fault register. It keeps all the fault information from last read until the host issues a new read. For example, if there is a TS fault but gets recovered immediately, the host still sees TS fault during the first read. In order to get the fault information at present, the host has to read REG09 for the second time. REG09 does not support multi-read and multi-write.

8.6 Register Map

8.6.1 I²C Registers

Address: 6BH. REG00-07 support Read and Write. REG08-0A are Read only.

8.6.1.1 Input Source Control Register REG00 [reset = 00110xxx, or 3x]

图 28. Input Source Control Register REG00 Format

7	6	5	4	3	2	1	0
EN_HIZ	VINDPM[3]	VINDPM[2]	VINDPM[1]	VINDPM[0]	IINLIM[2]	IINLIM[1]	IINLIM[0]
R/W	R/W	R/W	R/W	R/W	R/W	R/W	R/W

LEGEND: R/W = Read/Write

表 6. Input Source Control Register REG00 Field Description

BIT	FIELD	TYPE	RESET	DESCRIPTION	NOTE
Bit 7	EN_HIZ	R/W	0	0 – Disable, 1 – Enable	Default: Disable (0)
Input Voltage Limit					
Bit 6	VINDPM[3]	R/W	0	640 mV	Offset 3.88 V, Range: 3.88 V – 5.08 V Default: 4.36 V (0110)
Bit 5	VINDPM[2]	R/W	1	320 mV	
Bit 4	VINDPM[1]	R/W	1	160 mV	
Bit 3	VINDPM[0]	R/W	0	80 mV	
Input Current Limit (Actual input current limit is the lower of I ² C and ILIM)					
Bit 2	IINLIM[2]	R/W	x	000 – 100 mA,	PSEL = Lo : 3 A (111) PSEL = Hi : 100 mA (000) (OTG pin = Lo) or 500 mA (OTG pin = Hi)
Bit 1	IINLIM[1]	R/W	x	001 – 150 mA,	
Bit 0	IINLIM[0]	R/W	x	010 – 500 mA,	
				011 – 900 mA, 100 – 1 A, 101 – 1.5 A, 110 – 2 A, 111 – 3 A	

8.6.1.2 Power-On Configuration Register REG01 [reset = 00011011, or 0x1B]
图 29. Power-On Configuration Register REG01 Format

7	6	5	4	3	2	1	0
Register Reset	I ² C Watchdog Timer Reset	OTG_CONFIG	CHG_CONFIG	SYS_MIN[2]	SYS_MIN[1]	SYS_MIN[0]	BOOST_LIM
R/W	R/W	R/W	R/W	R/W	R/W	R/W	R/W

LEGEND: R/W = Read/Write

表 7. Power-On Configuration Register REG01 Field Description

BIT	FIELD	TYPE	RESET	DESCRIPTION	NOTE
Bit 7	Register Reset	R/W	0	0 – Keep current register setting, 1 – Reset to default	Default: Keep current register setting (0) Note: Register Reset bit does not reset device to default mode
Bit 6	I ² C Watchdog Timer Reset	R/W	0	0 – Normal ; 1 – Reset	Default: Normal (0) Note: Consecutive I ² C watchdog timer reset requires minimum 20-μs delay
Charger Configuration					
Bit 5	OTG_CONFIG	R/W	0	0 – OTG Disable; 1 – OTG Enable	Default: OTG disable (0) Note: OTG_CONFIG would over-ride Charge Enable Function in CHG_CONFIG
Bit 4	CHG_CONFIG	R/W	1	0- Charge Disable; 1- Charge Enable	Default: Charge Battery (1)
Minimum System Voltage Limit					
Bit 3	SYS_MIN[2]	R/W	1	0.4 V	Offset: 3.0 V, Range 3.0 V – 3.7 V Default: 3.5 V (101)
Bit 2	SYS_MIN[1]	R/W	0	0.2 V	
Bit 1	SYS_MIN[0]	R/W	1	0.1 V	
Bit 0	BOOST_LIM	R/W	1	0 – 1 A, 1 – 1.5 A	Default: 1.5 A (1)

8.6.1.3 Charge Current Control Register REG02 [reset = 01100000, or 60]

图 30. Charge Current Control Register REG02 Format

7	6	5	4	3	2	1	0
Reserved	ICHG[4]	ICHG[3]	ICHG[2]	ICHG[1]	ICHG[0]	BCOLD	FORCE_20PCT
R/W	R/W	R/W	R/W	R/W	R/W	R/W	R/W

LEGEND: R/W = Read/Write

表 8. Charge Current Control Register REG02 Field Description

BIT	FIELD	TYPE	RESET	DESCRIPTION	NOTE
Fast Charge Current Limit					
Bit 7	Reserved	R/W	0	Reserved. Always read/write 0	Offset: 512 mA Range: 512 – 2048 mA (000000 – 0110000) Default: 2048 mA (011000) Note: ICHG higher than 2048 mA is not supported
Bit 6	ICHG[4]	R/W	1	1024 mA	
Bit 5	ICHG[3]	R/W	1	512 mA	
Bit 4	ICHG[2]	R/W	0	256 mA	
Bit 3	ICHG[1]	R/W	0	128 mA	
Bit 2	ICHG[0]	R/W	0	64 mA	
Bit 1	BCOLD	R/W	0	Set Boost Mode temperature monitor threshold voltage to disable boost mode 0 – V_{bcold0} (Typ. 76% of REGN or -10°C w/ 103AT thermistor) 1 – V_{bcold1} (Typ. 79% of REGN or -20°C w/ 103AT thermistor)	Default: V_{bcold0} (0)
Bit 0	FORCE_20PCT	R/W	0	0 – ICHG as Fast Charge Current (REG02[6:2]) and IPRECH as Pre-Charge Current (REG03[7:4]) programmed 1 – ICHG as 20% Fast Charge Current (REG02[6:2]) and IPRECH as 50% Pre-Charge Current (REG03[7:4]) programmed	Default: ICHG as Fast Charge Current (REG02[6:2]) and IPRECH as Pre-Charge Current (REG03[7:4]) programmed (0)

8.6.1.4 Pre-Charge/Termination Current Control Register REG03 [reset = 00010001, or 0x11]

图 31. Pre-Charge/Termination Current Control Register REG03 Format

7	6	5	4	3	2	1	0
IPRECHG[3]	IPRECHG[2]	IPRECHG[1]	IPRECHG[0]	Reserved	ITERM[2]	ITERM[1]	ITERM[0]
R/W	R/W	R/W	R/W	R/W	R/W	R/W	R/W

LEGEND: R/W = Read/Write

表 9. Pre-Charge/Termination Current Control Register REG03 Field Description

BIT	FIELD	TYPE	RESET	DESCRIPTION	NOTE
Pre-Charge Current Limit					
Bit 7	IPRECHG[3]	R/W	0	0000: 128 mA; 0001: 128 mA; 0010: 256 mA; 0011: 384 mA 0100: 512 mA; 0101: 768 mA; 0110: 896 mA; 0111: 1024 mA 1000: 1152 mA; 1001: 1280 mA; 1010: 1408 mA; 1011: 1536 mA 1100: 1664 mA; 1101: 1792 mA; 1110: 1920 mA; 1111: 2048 mA	Offset: 128 mA, Range: 128 mA – 2048 mA Default: 128 mA (0001)
Bit 6	IPRECHG[2]	R/W	0		
Bit 5	IPRECHG[1]	R/W	0		
Bit 4	IPRECHG[0]	R/W	1		
Bit 3	Reserved	R/W	0	0 - Reserved	
Termination Current Limit					
Bit 2	ITERM[2]	R/W	0	512 mA	Offset: 128 mA Range: 128 mA – 1024 mA Default: 256 mA (001)
Bit 1	ITERM[1]	R/W	0	256 mA	
Bit 0	ITERM[0]	R/W	1	128 mA	

8.6.1.5 Charge Voltage Control Register REG04 [reset = 10110010, or 0xB2]
图 32. Charge Voltage Control Register REG04 Format

7	6	5	4	3	2	1	0
VREG[5]	VREG[4]	VREG[3]	VREG[2]	VREG[1]	VREG[0]	BATLOWV	VRECHG
R/W	R/W	R/W	R/W	R/W	R/W	R/W	R/W

LEGEND: R/W = Read/Write

表 10. Charge Voltage Control Register REG04 Field Description

BIT	FIELD	TYPE	RESET	DESCRIPTION	NOTE
Charge Voltage Limit					
Bit 7	VREG[5]	R/W	1	512 mV	Offset: 3.504 V Range: 3.504 V – 4.400 V Default: 4.208 V
Bit 6	VREG[4]	R/W	0	256 mV	
Bit 5	VREG[3]	R/W	1	128 mV	
Bit 4	VREG[2]	R/W	1	64 mV	
Bit 3	VREG[1]	R/W	1	32 mV	
Bit 2	VREG[0]	R/W	1	16 mV	
Bit 1	BATLOWV	R/W	1	0 – 2.8 V, 1 – 3 V	Default: 3.0 V (1) (pre-charge to fast charge)
Battery Recharge Threshold (below battery regulation voltage)					
Bit 0	VRECHG	R/W	0	0 – 100 mV, 1 – 300 mV	Default: 100 mV (0)

8.6.1.6 Charge Termination/Timer Control Register REG05 [reset = 10011100, or 0x9C]
图 33. Charge Termination/Timer Control Register REG05 Format

7	6	5	4	3	2	1	0
EN_TERM	Reserved	WATCHDOG[1]	WATCHDOG[0]	EN_TIMER	CHG_TIMER[1]	CHG_TIMER[0]	Reserved
R/W	R/W	R/W	R/W	R/W	R/W	R/W	R/W

LEGEND: R/W = Read/Write

表 11. Charge Termination/Timer Control Register REG05 Field Description

BIT	FIELD	TYPE	RESET	DESCRIPTION	NOTE
Charging Termination Enable					
Bit 7	EN_TERM	R/W	1	0 – Disable, 1 – Enable	Default: Enable termination (1)
Bit 6	Reserved	R/W	0	0 - Reserved	
I2C Watchdog Timer Setting					
Bit 5	WATCHDOG[1]	R/W	0	00 – Disable timer, 01 – 40 s, 10 – 80 s, 11 – 160 s	Default: 40 s (01)
Bit 4	WATCHDOG[0]	R/W	1		
Charging Safety Timer Enable					
Bit 3	EN_TIMER	R/W	1	0 – Disable, 1 – Enable	Default: Enable (1)
Fast Charge Timer Setting					
Bit 2	CHG_TIMER[1]	R/W	0	00 – 5 hrs, 01 – 8 hrs, 10 – 12 hrs, 11 – 20 hrs	Default: 12 hrs (10) (See <i>Charging Safety Timer</i> for details)
Bit 1	CHG_TIMER[0]	R/W	1		
Bit 0	Reserved	R/W	0	0 - Reserved	

8.6.1.7 Boost Voltage/Thermal Regulation Control Register REG06 [reset = 01110011, or 0x73]
图 34. Boost Voltage/Thermal Regulation Control Register REG06 Format

7	6	5	4	3	2	1	0
BOOSTV[3]	BOOSTV[2]	BOOSTV[1]	BOOSTV[0]	BHOT[1]	BHOT[0]	TREG[1]	TREG[0]
R/W	R/W	R/W	R/W	R/W	R/W	R/W	R/W

LEGEND: R/W = Read/Write

表 12. Boost Voltage/Thermal Regulation Control Register REG06 Field Description

BIT	FIELD	TYPE	RESET	DESCRIPTION	NOTE
Bit 7	BOOSTV[3]	R/W	0	512 mV	Offset: 4.55 V Range: 4.55 V – 5.51 V Default: 4.998 V (0111) Default: 4.998 V (0111)
Bit 6	BOOSTV[2]	R/W	1	256 mV	
Bit 5	BOOSTV[1]	R/W	1	128 mV	
Bit 4	BOOSTV[0]	R/W	1	64 mV	
Bit 3	BHOT[1]	R/W	0	Set Boost Mode temperature monitor threshold voltage to disable boost mode Voltage to disable boost mode 00 – V_{bhot1} (33% of REGN or 55°C w/ 103AT thermistor) 01 – V_{bhot0} (36% of REGN or 60°C w/ 103AT thermistor) 10 – V_{bhot2} (30% of REGN or 65°C w/ 103AT thermistor) 11 – Disable boost mode thermal protection.	Default: V_{bhot1} (00) Note: For BHOT[1:0] = 11, boost mode operates without temperature monitor and the NTC_FAULT is generated based on V_{bhot1} threshold
Bit 2	BHOT[0]	R/W	0		
Thermal Regulation Threshold					
Bit 1	TREG[1]	R/W	1	00 – 60°C, 01 – 80°C, 10 – 100°C, 11 – 120°C	Default: 120°C (11)
Bit 0	TREG[0]	R/W	1		

8.6.1.8 Misc Operation Control Register REG07 [reset = 01001011, or 4B]
图 35. Misc Operation Control Register REG07 Format

7	6	5	4	3	2	1	0
DPDM_EN	TMR2X_EN	BATFET_Disable	Reserved	Reserved	Reserved	INT_MASK[1]	INT_MASK[0]
R/W	R/W	R/W	R/W	R/W	R/W	R/W	R/W

LEGEND: R/W = Read/Write

表 13. Misc Operation Control Register REG07 Field Description

BIT	FIELD	TYPE	RESET	DESCRIPTION	NOTE
Force DPDM detection					
Bit 7	DPDM_EN	R/W	0	0 – Not in Force detection; 1 – Force detection when VBUS power is presence	Default: Not in Force detection (0), Back to 0 after detection complete
Safety Timer Setting during Input DPM and Thermal Regulation					
Bit 6	TMR2X_EN	R/W	1	0 – Safety timer not slowed by 2X during input DPM or thermal regulation, 1 – Safety timer slowed by 2X during input DPM or thermal regulation	Default: Safety timer slowed by 2X (1)
Force BATFET Off					
Bit 5	BATFET_Disable	R/W	0	0 – Allow BATFET (Q4) turn on, 1 – Turn off BATFET (Q4)	Default: Allow BATFET (Q4) turn on(0)
Bit 4	Reserved	R/W	0	0 - Reserved	
Bit 3	Reserved	R/W	1	1 - Reserved	
Bit 2	Reserved	R/W	0	0 - Reserved	
Bit 1	INT_MASK[1]	R/W	1	0 – No INT during CHRG_FAULT, 1 – INT on CHRG_FAULT	Default: INT on CHRG_FAULT (1)
Bit 0	INT_MASK[0]	R/W	1	0 – No INT during BAT_FAULT, 1 – INT on BAT_FAULT	Default: INT on BAT_FAULT (1)

8.6.1.9 System Status Register REG08
图 36. System Status Register REG08 Format

7	6	5	4	3	2	1	0
VBUS_STAT[1]	VBUS_STAT[0]	CHRG_STAT[1]	CHRG_STAT[0]	DPM_STAT	PG_STAT	THERM_STAT	VSYS_STAT
R	R	R	R	R	R	R	R

LEGEND: R = Read only

表 14. System Status Register REG08 Field Description

BIT	FIELD	TYPE	DESCRIPTION
Bit 7	VBUS_STAT[1]	R	00 – Unknown (no input, or DPDM detection incomplete), 01 – USB host, 10 – Adapter port, 11 – OTG
Bit 6	VBUS_STAT[0]	R	
Bit 5	CHRG_STAT[1]	R	00 – Not Charging, 01 – Pre-charge ($<V_{BATLOWV}$), 10 – Fast Charging, 11 – Charge Termination Done
Bit 4	CHRG_STAT[0]	R	
Bit 3	DPM_STAT	R	0 – Not DPM, 1 – VINDPM or IINDPM
Bit 2	PG_STAT	R	0 – Not Power Good, 1 – Power Good
Bit 1	THERM_STAT	R	0 – Normal, 1 – In Thermal Regulation
Bit 0	VSYS_STAT	R	0 – Not in VSYSMIN regulation (BAT > VSYSMIN), 1 – In VSYSMIN regulation (BAT < VSYSMIN)

8.6.1.10 New Fault Register REG09

图 37. New Fault Register REG09 Format

7	6	5	4	3	2	1	0
WATCHDOG_FAULT	OTG_FAULT	CHRG_FAULT[1]	CHRG_FAULT[0]	BAT_FAULT	Reserved	NTC_FAULT[1]	NTC_FAULT[0]
R	R	R	R	R	R	R	R

LEGEND: R = Read only

表 15. New Fault Register REG09 Field Description⁽¹⁾⁽²⁾⁽³⁾

BIT	FIELD	TYPE	DESCRIPTION
Bit 7	WATCHDOG_FAULT	R	0 – Normal, 1- Watchdog timer expiration
Bit 6	OTG_FAULT	R	0 – Normal, 1 – VBUS overloaded in OTG, or VBUS OVP, or battery is too low (any conditions that cannot start boost function)
Bit 5	CHRG_FAULT[1]	R	00 – Normal, 01 – Input fault (OVP or bad source), 10 - Thermal shutdown, 11 – Charge Timer Expiration
Bit 4	CHRG_FAULT[0]	R	
Bit 3	BAT_FAULT	R	0 – Normal, 1 – Battery OVP
Bit 2	Reserved	R	Reserved – 0
Bit 1	NTC_FAULT[1]	R	0-Normal 1–Cold Note: Cold temperature threshold is different based on device operates in buck or boost mode
Bit 0	NTC_FAULT[0]	R	0-Normal 1–Hot Note: Hot temperature threshold is different based on device operates in buck or boost mode

(1) REG09 only supports single byte I²C read.

(2) All register bits in REG09 are latched fault. First time read of REG09 clears the previous fault and second read updates fault register to any fault that still presents.

(3) When adapter is unplugged, input fault (bad source) in CHRG_FAULT bits[5:4] is set to 01 once.

8.6.1.11 Vender / Part / Revision Status Register REG0A

图 38. Vender / Part / Revision Status Register REG0A Format

7	6	5	4	3	2	1	0
PN[2]	PN[1]	PN[0]	Reserved	Reserved	Rev[2]	Rev[1]	Rev[0]
R	R	R	R	R	R	R	R

LEGEND: R = Read only

表 16. Vender / Part / Revision Status Register REG0A Field Description

BIT	FIELD	TYPE	DESCRIPTION
Bit 7	PN[2]	R	001
Bit 6	PN[1]	R	
Bit 5	PN[0]	R	
Bit 4	Reserved	R	0 – Reserved
Bit 3	Reserved	R	0 – Reserved
Bit 2	Rev[2]	R	000
Bit 1	Rev[1]	R	
Bit 0	Rev[0]	R	

9 Application and Implementation

注

Information in the following applications sections is not part of the TI component specification, and TI does not warrant its accuracy or completeness. TI's customers are responsible for determining suitability of components for their purposes. Customers should validate and test their design implementation to confirm system functionality.

9.1 Application Information

A typical application consists of the device configured as an I²C controlled power path management device and a single cell Li-Ion battery charger for single cell Li-Ion and Li-polymer batteries used in a wide range of tablets and other portable devices. It integrates an input reverse-blocking FET (RBFET, Q1), high-side switching FET (HSFET, Q2), low-side switching FET (LSFET, Q3), and BATFET (Q4) between the system and battery. The device also integrates a bootstrap diode for the high-side gate drive.

9.2 Typical Application



图 39. bq24259 with PSEL from PHY, Charging from SDP/DCP, and Optional BATFET Enable Interface

9.2.1 Design Requirements

表 17. Design Requirements

DESIGN PARAMATER	EXAMPLE VALUE
Input voltage range	3.9 V to 6.2 V
Input current limit	1500 mA
Fast charge current	2000 mA
Boost mode output current	1 A

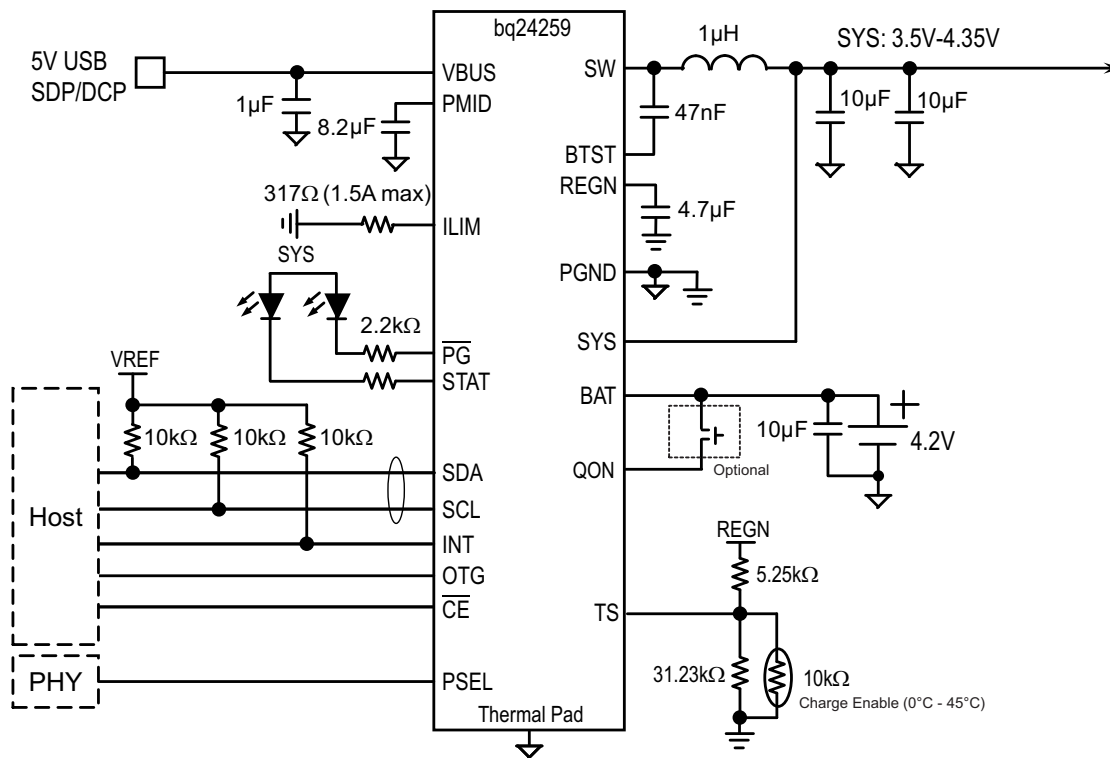
9.2.2 Detailed Design Procedure

9.2.2.1 Inductor Selection

The device has 1.5-MHz switching frequency to allow the use of small inductor and capacitor values. The Inductor saturation current should be higher than the charging current (I_{CHG}) plus half the ripple current (I_{RIPPLE}):

$$I_{SAT} \geq I_{CHG} + (1/2) I_{RIPPLE} \quad (4)$$

The inductor ripple current depends on input voltage (V_{BUS}), duty cycle ($D = V_{BAT}/V_{VBUS}$), switching frequency (f_s) and inductance (L):

$$I_{RIPPLE} = \frac{V_{IN} \times D \times (1-D)}{f_s \times L} \quad (5)$$

The maximum inductor ripple current happens with $D = 0.5$ or close to 0.5. Usually inductor ripple is designed in the range of (20 – 40%) maximum charging current as a trade-off between inductor size and efficiency for a practical design.

9.2.2.2 Input Capacitor

Input capacitor should have enough ripple current rating to absorb input switching ripple current. The worst case RMS ripple current is half of the charging current when duty cycle is 0.5. If the converter does not operate at 50% duty cycle, then the worst case capacitor RMS current I_{CIN} occurs where the duty cycle is closest to 50% and can be estimated by the following equation:

$$I_{CIN} = I_{CHG} \times \sqrt{D \times (1-D)} \quad (6)$$

For best performance, V_{BUS} should be decouple to PGND with 1- μ F capacitance. The remaining input capacitor should be place on PMID.

Low ESR ceramic capacitor such as X7R or X5R is preferred for input decoupling capacitor and should be placed to the drain of the high side MOSFET and source of the low side MOSFET as close as possible. Voltage rating of the capacitor must be higher than normal input voltage level. 25-V rating or higher capacitor is preferred for 15-V input voltage. 22- μ F capacitance is suggested for typical charging current.

9.2.2.3 Output Capacitor

Output capacitor also should have enough ripple current rating to absorb output switching ripple current. The output capacitor RMS current I_{COUT} is given:

$$I_{COUT} = \frac{I_{RIPPLE}}{2 \times \sqrt{3}} \approx 0.29 \times I_{RIPPLE} \quad (7)$$

The output capacitor voltage ripple can be calculated as follows:

$$\Delta V_O = \frac{V_{OUT}}{8LCf_s^2} \left(1 - \frac{V_{OUT}}{V_{IN}} \right) \quad (8)$$

At certain input/output voltage and switching frequency, the voltage ripple can be reduced by increasing the output filter LC.

The charger device has internal loop compensator. To get good loop stability, the resonant frequency of the output inductor and output capacitor should be designed between 15 kHz and 25 kHz. The preferred ceramic capacitor is 6 V or higher rating, X7R or X5R.

9.2.3 Application Performance Plots



图 40. bq24259 Power Up with Charge Enabled



图 41. Charge Enable

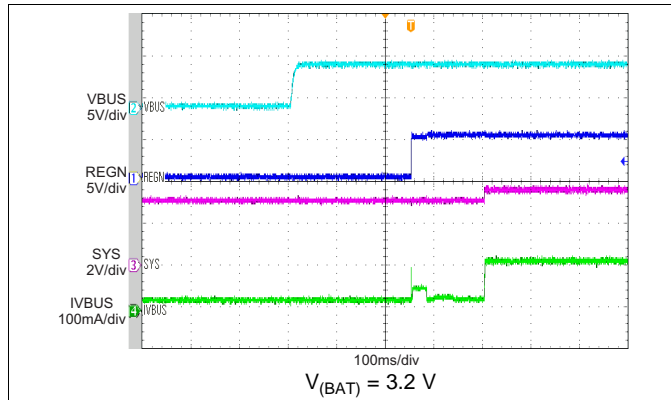

图 42. Charge Disable

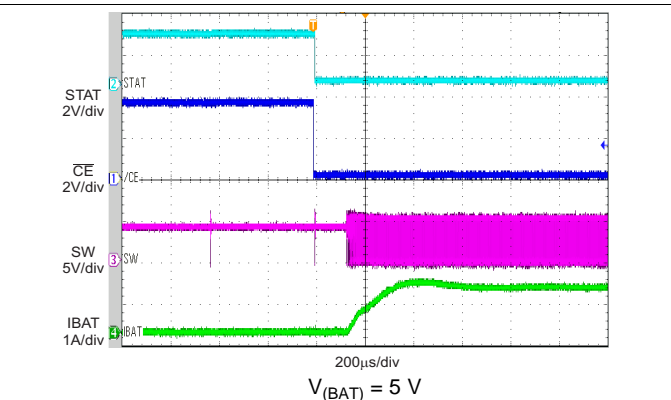

VBUS = 5 V, No Battery, $I_{(SYS)} = 40\text{ mA}$, Charge Disable

图 43. PWM Switching in Buck Mode

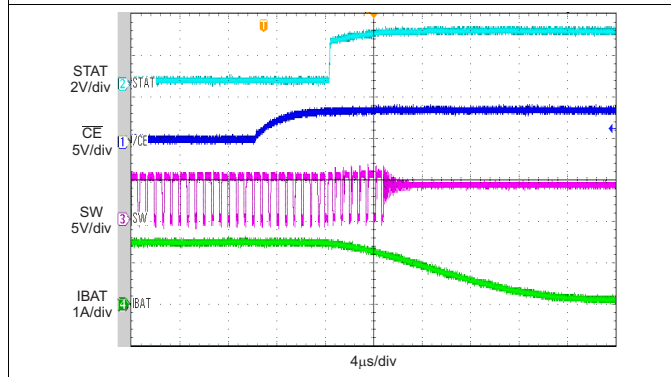
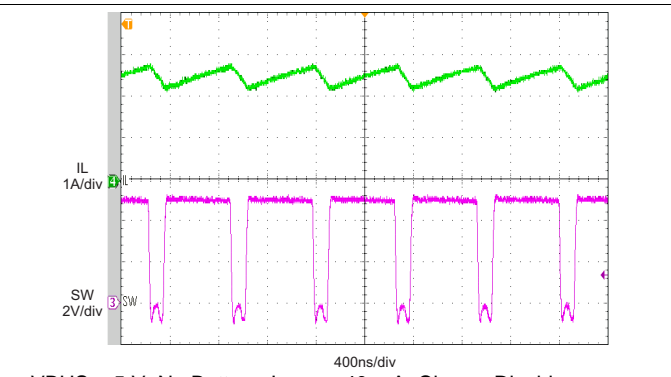

图 44. PFM Switching in Buck Mode



图 45. Input Current DPM Response without Battery

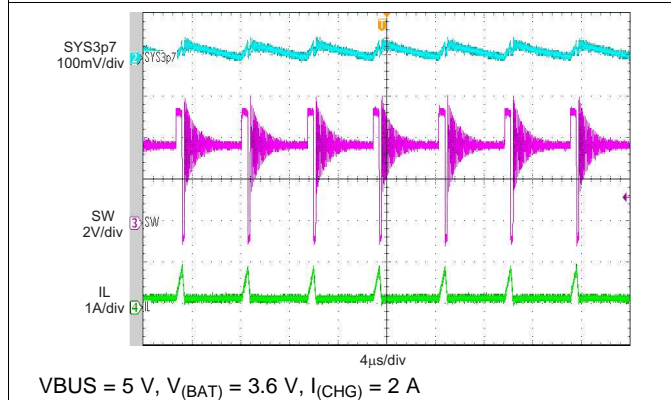

10 Power Supply Recommendations

In order to provide an output voltage on SYS, the bq24259 require a power supply between 3.9 V and 6.2 V input with at least 100-mA current rating connected to V_{BUS} ; or, a single-cell Li-Ion battery with voltage $> V_{(BATUVLO)}$ connected to BAT. The source current rating needs to be at least 2 A in order for the buck converter of the charger to provide maximum output power to SYS.

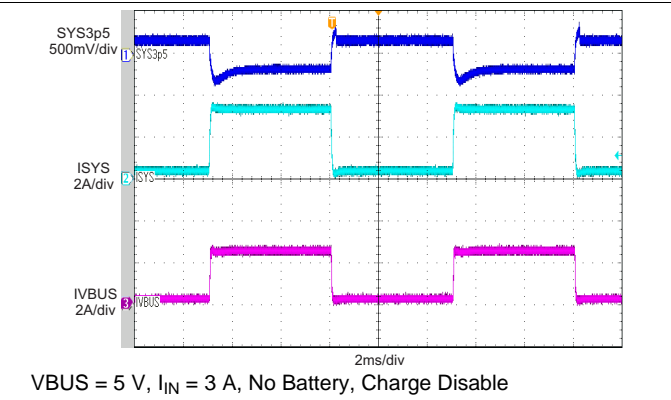
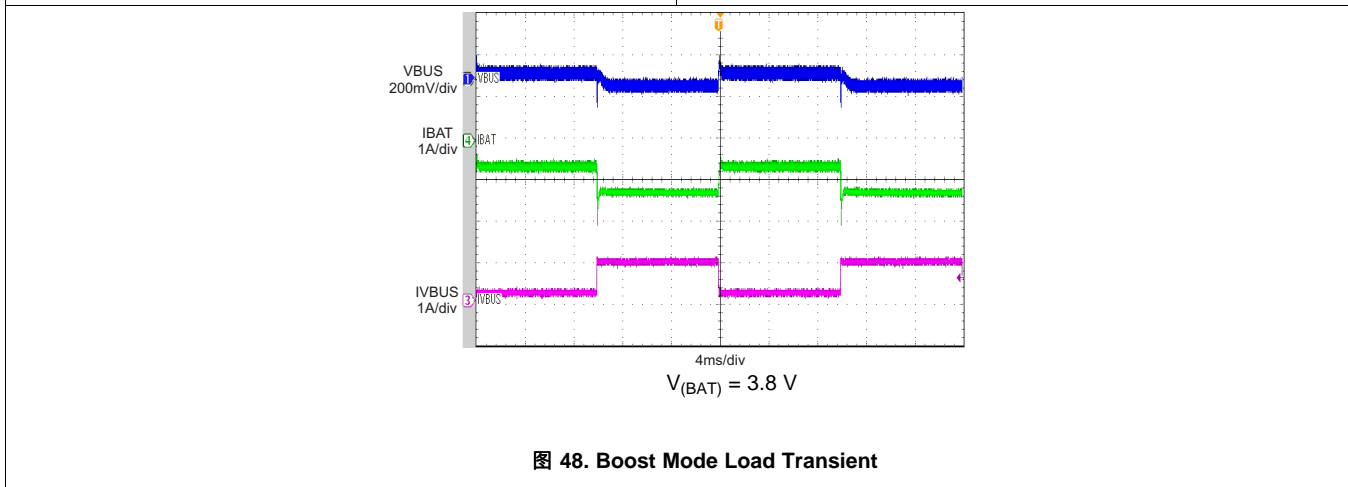
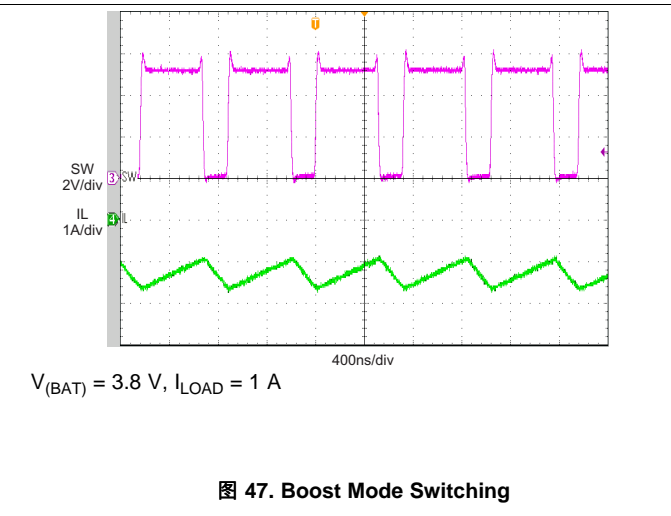
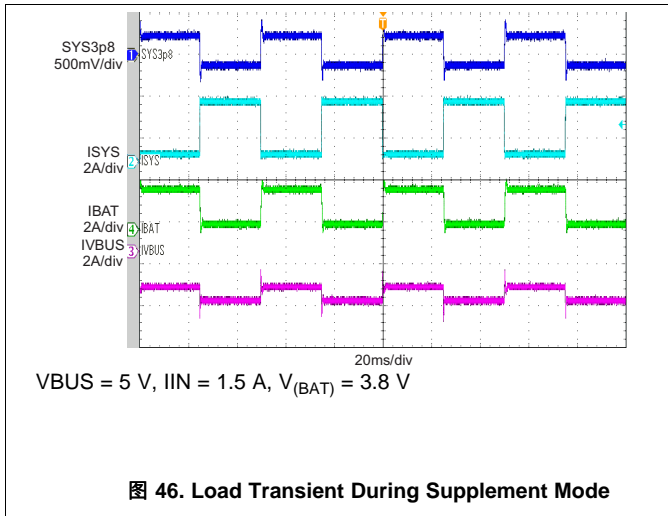
11 Layout

11.1 Layout Guidelines

The switching node rise and fall times should be minimized for minimum switching loss. Proper layout of the components to minimize high frequency current path loop (see [图 49](#)) is important to prevent electrical and magnetic field radiation and high frequency resonant problems. Here is a PCB layout priority list for proper layout. Layout PCB according to this specific order is essential.

1. Place input capacitor as close as possible to PMID pin and GND pin connections and use shortest copper trace connection or GND plane.
2. Place inductor input pin to SW pin as close as possible. Minimize the copper area of this trace to lower electrical and magnetic field radiation but make the trace wide enough to carry the charging current. Do not use multiple layers in parallel for this connection. Minimize parasitic capacitance from this area to any other trace or plane.
3. Put output capacitor near to the inductor and the IC. Ground connections need to be tied to the IC ground with a short copper trace connection or GND plane.
4. Route analog ground separately from power ground. Connect analog ground and connect power ground separately. Connect analog ground and power ground together using thermal pad as the single ground connection point. Or using a 0Ω resistor to tie analog ground to power ground.
5. Use single ground connection to tie charger power ground to charger analog ground. Just beneath the IC. Use ground copper pour but avoid power pins to reduce inductive and capacitive noise coupling.
6. Decoupling capacitors should be placed next to the IC pins and make trace connection as short as possible.
7. It is critical that the exposed thermal pad on the backside of the IC package be soldered to the PCB ground. Ensure that there are sufficient thermal vias directly under the IC, connecting to the ground plane on the other layers.
8. The via size and number should be enough for a given current path.

See the EVM design for the recommended component placement with trace and via locations. For the VQFN information, refer to [SCBA017](#) and [SLUA271](#).



图 49. High Frequency Current Path

11.2 Layout Example

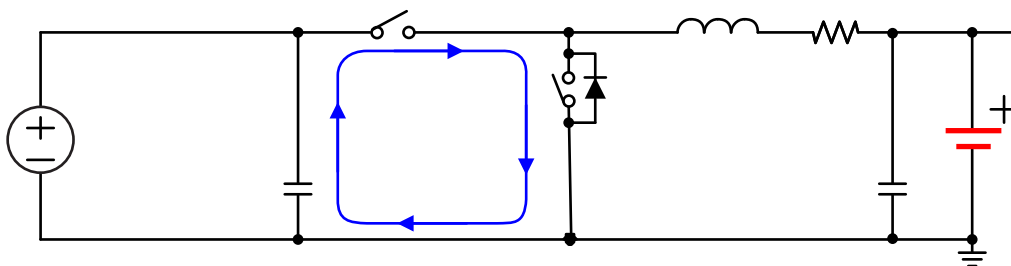

图 50. Layout Example

12 器件和文档支持

12.1 器件支持

12.1.1 相关文档

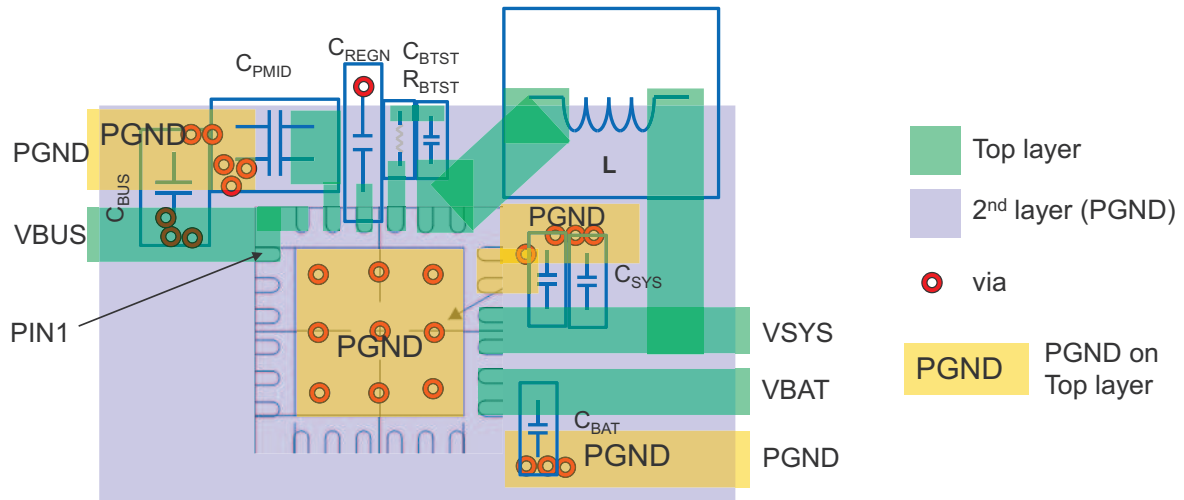
《四方扁平无引线逻辑器件封装应用报告》(SCBA017)

《QFN/SON PCB 连接应用报告》(SLUA271)

12.2 社区资源

The following links connect to TI community resources. Linked contents are provided "AS IS" by the respective contributors. They do not constitute TI specifications and do not necessarily reflect TI's views; see TI's [Terms of Use](#).

TI E2E™ Online Community *TI's Engineer-to-Engineer (E2E) Community*. Created to foster collaboration among engineers. At e2e.ti.com, you can ask questions, share knowledge, explore ideas and help solve problems with fellow engineers.

Design Support *TI's Design Support* Quickly find helpful E2E forums along with design support tools and contact information for technical support.

12.3 商标

E2E is a trademark of Texas Instruments.

All other trademarks are the property of their respective owners.

12.4 静电放电警告



这些装置包含有限的内置 ESD 保护。存储或装卸时，应将导线一起截短或将装置放置于导电泡棉中，以防止 MOS 门极遭受静电损伤。

12.5 Glossary

SLYZ022 — *TI Glossary*.

This glossary lists and explains terms, acronyms, and definitions.

13 机械、封装和可订购信息

以下页中包括机械、封装和可订购信息。这些信息是针对指定器件可提供的最新数据。这些数据会在无通知且不对本文档进行修订的情况下发生改变。欲获得该数据表的浏览器版本，请查阅左侧的导航栏。

重要声明

德州仪器(TI)及其下属子公司有权根据 JESD46 最新标准,对所提供的产品和服务进行更正、修改、增强、改进或其它更改,并有权根据 JESD48 最新标准中止提供任何产品和服务。客户在下订单前应获取最新的相关信息,并验证这些信息是否完整且是最新的。所有产品的销售都遵循在订单确认时所提供的TI 销售条款与条件。

TI 保证其所销售的组件的性能符合产品销售时 TI 半导体产品销售条件与条款的适用规范。仅在 TI 保证的范围内,且 TI 认为有必要时才会使用测试或其它质量控制技术。除非适用法律做出了硬性规定,否则没有必要对每种组件的所有参数进行测试。

TI 对应用帮助或客户产品设计不承担任何义务。客户应对其使用 TI 组件的产品和应用自行负责。为尽量减小与客户产品和应用相关的风险,客户应提供充分的设计与操作安全措施。

TI 不对任何 TI 专利权、版权、屏蔽作品权或其它与使用了 TI 组件或服务的组合设备、机器或流程相关的 TI 知识产权中授予的直接或隐含权限作出任何保证或解释。TI 所发布的与第三方产品或服务有关的信息,不能构成从 TI 获得使用这些产品或服务的许可、授权、或认可。使用此类信息可能需要获得第三方的专利权或其它知识产权方面的许可,或是 TI 的专利权或其它知识产权方面的许可。

对于 TI 的产品手册或数据表中 TI 信息的重要部分,仅在没有对内容进行任何篡改且带有相关授权、条件、限制和声明的情况下才允许进行复制。TI 对此类篡改过的文件不承担任何责任或义务。复制第三方的信息可能需要服从额外的限制条件。

在转售 TI 组件或服务时,如果对该组件或服务参数的陈述与 TI 标明的参数相比存在差异或虚假成分,则会失去相关 TI 组件或服务的所有明示或暗示授权,且这是不正当的、欺诈性商业行为。TI 对任何此类虚假陈述均不承担任何责任或义务。

客户认可并同意,尽管任何应用相关信息或支持仍可能由 TI 提供,但他们将独立负责满足与其产品及其在应用中使用的 TI 产品相关的所有法律、法规和安全相关要求。客户声明并同意,他们具备制定与实施安全措施所需的全部专业技术和知识,可预见故障的危险后果、监测故障及其后果、降低有可能造成人身伤害的故障的发生机率并采取适当的补救措施。客户将全额赔偿因在此类安全关键应用中使用任何 TI 组件而对 TI 及其代理造成的任何损失。

在某些场合中,为了推进安全相关应用有可能对 TI 组件进行特别的促销。TI 的目标是利用此类组件帮助客户设计和创立其特有的可满足适用的功能安全性标准和要求的终端产品解决方案。尽管如此,此类组件仍然服从这些条款。

TI 组件未获得用于 FDA Class III (或类似的生命攸关医疗设备)的授权许可,除非各方授权官员已经达成了专门管控此类使用的特别协议。

只有那些 TI 特别注明属于军用等级或“增强型塑料”的 TI 组件才是设计或专门用于军事/航空应用或环境的。购买者认可并同意,对并非指定面向军事或航空航天用途的 TI 组件进行军事或航空航天方面的应用,其风险由客户单独承担,并且由客户独立负责满足与此类使用相关的所有法律和法规要求。

TI 已明确指定符合 ISO/TS16949 要求的产品,这些产品主要用于汽车。在任何情况下,因使用非指定产品而无法达到 ISO/TS16949 要求, TI 不承担任何责任。

	产品		应用
数字音频	www.ti.com.cn/audio	通信与电信	www.ti.com.cn/telecom
放大器和线性器件	www.ti.com.cn/amplifiers	计算机及周边	www.ti.com.cn/computer
数据转换器	www.ti.com.cn/dataconverters	消费电子	www.ti.com.cn/consumer-apps
DLP® 产品	www.dlp.com	能源	www.ti.com.cn/energy
DSP - 数字信号处理器	www.ti.com.cn/dsp	工业应用	www.ti.com.cn/industrial
时钟和计时器	www.ti.com.cn/clockandtimers	医疗电子	www.ti.com.cn/medical
接口	www.ti.com.cn/interface	安防应用	www.ti.com.cn/security
逻辑	www.ti.com.cn/logic	汽车电子	www.ti.com.cn/automotive
电源管理	www.ti.com.cn/power	视频和影像	www.ti.com.cn/video
微控制器 (MCU)	www.ti.com.cn/microcontrollers		
RFID 系统	www.ti.com.cn/rfidsys		
OMAP应用处理器	www.ti.com.cn/omap		
无线连通性	www.ti.com.cn/wirelessconnectivity	德州仪器在线技术支持社区	www.deyisupport.com

邮寄地址: 上海市浦东新区世纪大道1568号, 中建大厦32楼邮政编码: 200122
Copyright © 2016, 德州仪器半导体技术(上海)有限公司

PACKAGING INFORMATION

Orderable Device	Status (1)	Package Type	Package Drawing	Pins	Package Qty	Eco Plan (2)	Lead finish/ Ball material (6)	MSL Peak Temp (3)	Op Temp (°C)	Device Marking (4/5)	Samples
BQ24259RGER	ACTIVE	VQFN	RGE	24	3000	RoHS & Green	NIPDAU	Level-2-260C-1 YEAR	-40 to 85	BQ24259	Samples
BQ24259RGET	ACTIVE	VQFN	RGE	24	250	RoHS & Green	NIPDAU	Level-2-260C-1 YEAR	-40 to 85	BQ24259	Samples

(1) The marketing status values are defined as follows:

ACTIVE: Product device recommended for new designs.

LIFEBUY: TI has announced that the device will be discontinued, and a lifetime-buy period is in effect.

NRND: Not recommended for new designs. Device is in production to support existing customers, but TI does not recommend using this part in a new design.

PREVIEW: Device has been announced but is not in production. Samples may or may not be available.

OBSOLETE: TI has discontinued the production of the device.

(2) **RoHS:** TI defines "RoHS" to mean semiconductor products that are compliant with the current EU RoHS requirements for all 10 RoHS substances, including the requirement that RoHS substance do not exceed 0.1% by weight in homogeneous materials. Where designed to be soldered at high temperatures, "RoHS" products are suitable for use in specified lead-free processes. TI may reference these types of products as "Pb-Free".

RoHS Exempt: TI defines "RoHS Exempt" to mean products that contain lead but are compliant with EU RoHS pursuant to a specific EU RoHS exemption.

Green: TI defines "Green" to mean the content of Chlorine (Cl) and Bromine (Br) based flame retardants meet JS709B low halogen requirements of <=1000ppm threshold. Antimony trioxide based flame retardants must also meet the <=1000ppm threshold requirement.

(3) MSL, Peak Temp. - The Moisture Sensitivity Level rating according to the JEDEC industry standard classifications, and peak solder temperature.

(4) There may be additional marking, which relates to the logo, the lot trace code information, or the environmental category on the device.

(5) Multiple Device Markings will be inside parentheses. Only one Device Marking contained in parentheses and separated by a "~" will appear on a device. If a line is indented then it is a continuation of the previous line and the two combined represent the entire Device Marking for that device.

(6) Lead finish/Ball material - Orderable Devices may have multiple material finish options. Finish options are separated by a vertical ruled line. Lead finish/Ball material values may wrap to two lines if the finish value exceeds the maximum column width.

Important Information and Disclaimer:The information provided on this page represents TI's knowledge and belief as of the date that it is provided. TI bases its knowledge and belief on information provided by third parties, and makes no representation or warranty as to the accuracy of such information. Efforts are underway to better integrate information from third parties. TI has taken and continues to take reasonable steps to provide representative and accurate information but may not have conducted destructive testing or chemical analysis on incoming materials and chemicals. TI and TI suppliers consider certain information to be proprietary, and thus CAS numbers and other limited information may not be available for release.

In no event shall TI's liability arising out of such information exceed the total purchase price of the TI part(s) at issue in this document sold by TI to Customer on an annual basis.

GENERIC PACKAGE VIEW

RGE 24

VQFN - 1 mm max height

PLASTIC QUAD FLATPACK - NO LEAD



Images above are just a representation of the package family, actual package may vary.
Refer to the product data sheet for package details.

4204104/H

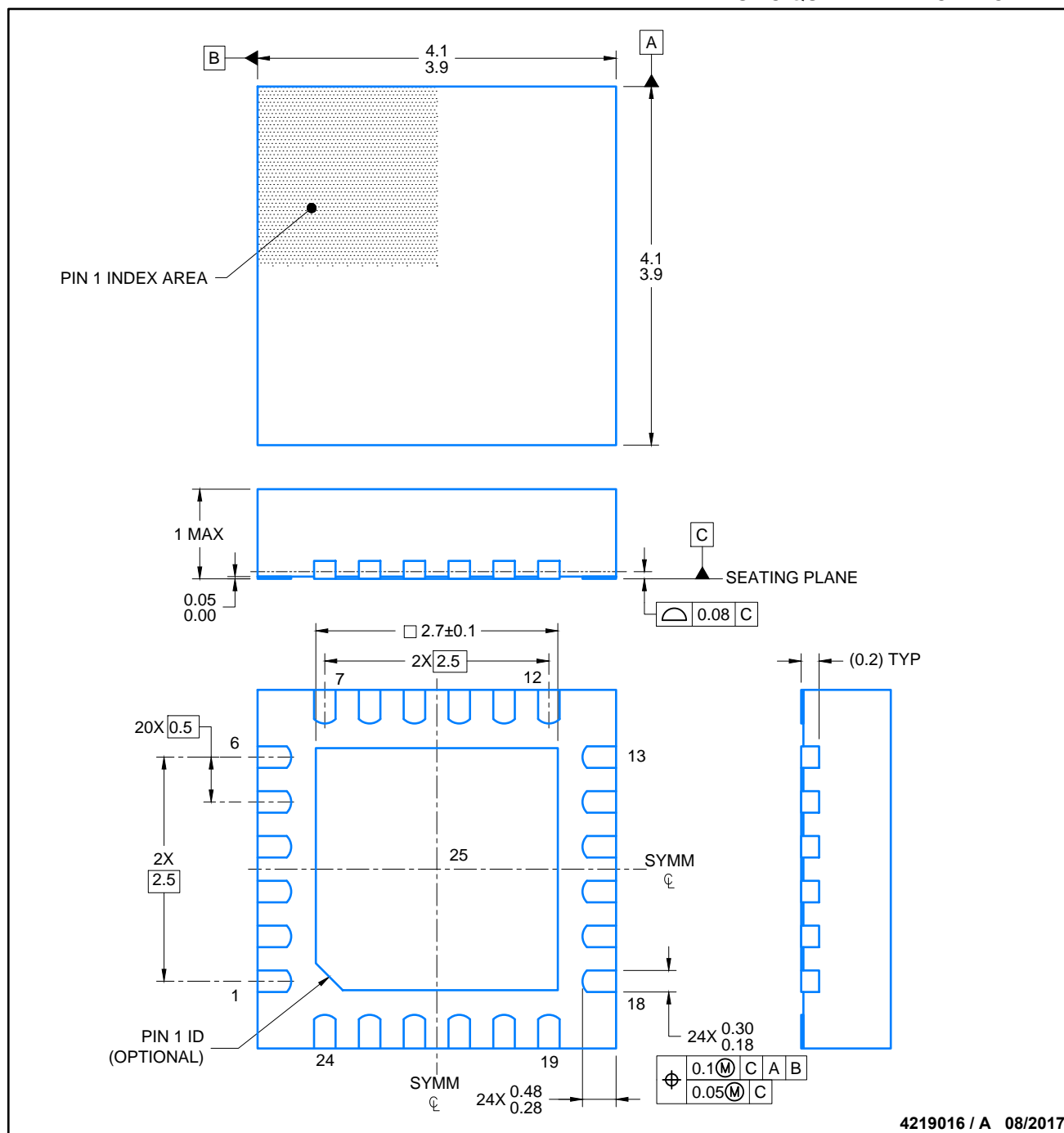

NOTES:

1. All linear dimensions are in millimeters. Any dimensions in parenthesis are for reference only. Dimensioning and tolerancing per ASME Y14.5M.
2. This drawing is subject to change without notice.
3. The package thermal pad must be soldered to the printed circuit board for thermal and mechanical performance.

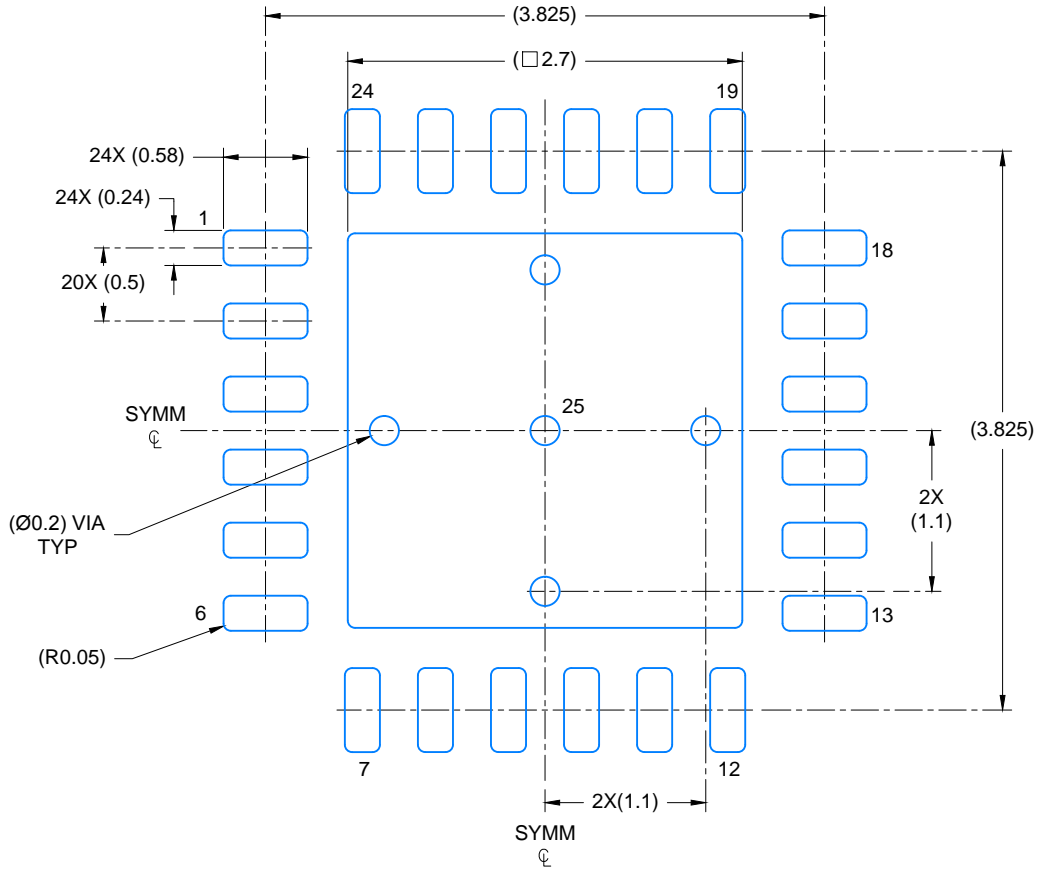

LAND PATTERN EXAMPLE
SCALE: 20X

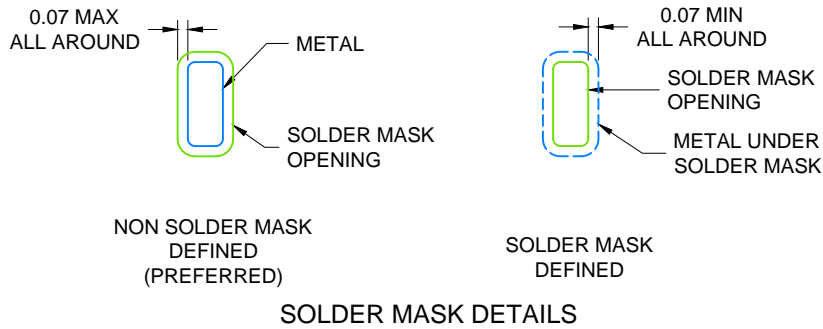

4219016 / A 08/2017

NOTES: (continued)

4. This package is designed to be soldered to a thermal pad on the board. For more information, see Texas Instruments literature number SLUA271 (www.ti.com/lit/slua271).
5. Solder mask tolerances between and around signal pads can vary based on board fabrication site.

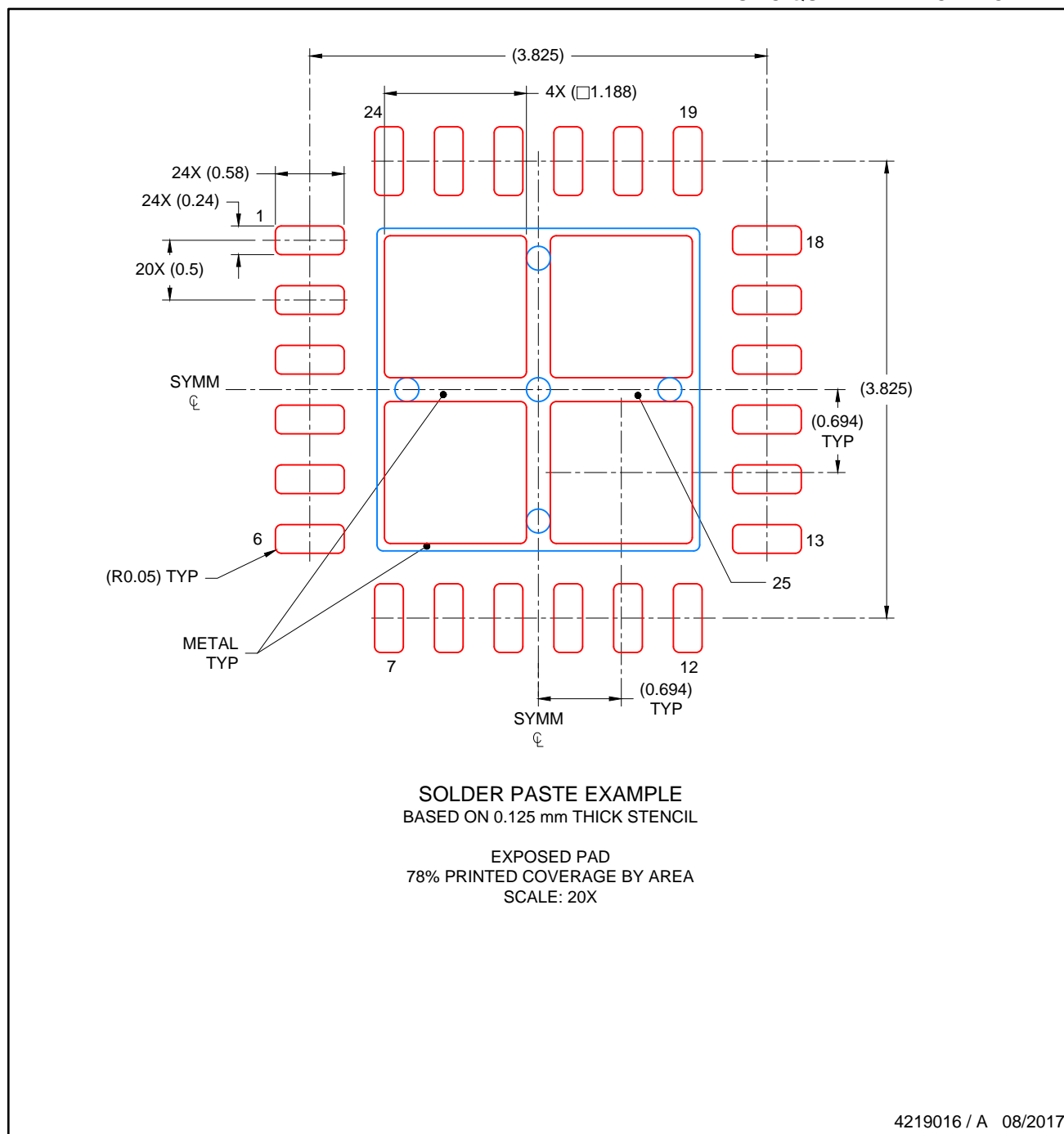

NOTES: (continued)

- 6. Laser cutting apertures with trapezoidal walls and rounded corners may offer better paste release. IPC-7525 may have alternate design recommendations..

重要声明和免责声明

TI 均以“原样”提供技术性及其可靠性数据（包括数据表）、设计资源（包括参考设计）、应用或其他设计建议、网络工具、安全信息和其他资源，不保证其中不含任何瑕疵，且不做任何明示或暗示的担保，包括但不限于对适销性、适合某特定用途或不侵犯任何第三方知识产权的暗示担保。

所述资源可供专业开发人员应用TI 产品进行设计使用。您将对以下行为独自承担全部责任：(1) 针对您的应用选择合适的TI 产品；(2) 设计、验证并测试您的应用；(3) 确保您的应用满足相应标准以及任何其他安全、安保或其他要求。所述资源如有变更，恕不另行通知。TI 对您使用所述资源的授权仅限于开发资源所涉及TI 产品的相关应用。除此之外不得复制或展示所述资源，也不提供其它TI 或任何第三方的知识产权授权许可。如因使用所述资源而产生任何索赔、赔偿、成本、损失及债务等，TI 对此概不负责，并且您须赔偿由此对TI 及其代表造成的损害。

TI 所提供产品均受TI 的销售条款 (<http://www.ti.com.cn/zh-cn/legal/termsofsale.html>) 以及ti.com.cn 上或随附TI 产品提供的其他可适用条款的约束。TI 提供所述资源并不扩展或以其他方式更改TI 针对TI 产品所发布的可适用的担保范围或担保免责声明。

邮寄地址：上海市浦东新区世纪大道 1568 号中建大厦 32 楼，邮政编码：200122

Copyright © 2020 德州仪器半导体技术（上海）有限公司