

# CSD19502Q5B 80V N 通道 NexFET™ 功率金属氧化物半导体场效应晶体管 (MOSFET)

## 1 特性

- 超低  $Q_g$  和  $Q_{gd}$
- 低热阻
- 雪崩额定值
- 逻辑电平
- 无铅引脚镀层
- 符合 RoHS 环保标准
- 无卤素
- SON 5mm x 6mm 塑料封装

## 2 应用范围

- 次级侧同步整流器
- 电机控制

## 3 说明

这款 3.4mΩ, 80V, SON 5mm x 6mm NexFET™ 功率 MOSFET 被设计成在功率转换应用中大大降低损耗。

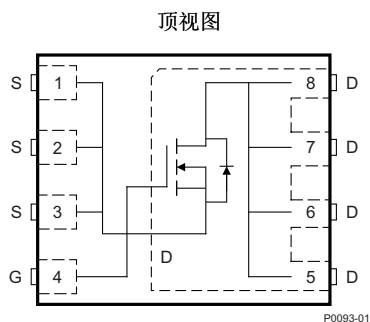

### 产品概要

| $T_A = 25^\circ\text{C}$ |              | 典型值                   |     | 单位 |
|--------------------------|--------------|-----------------------|-----|----|
| $V_{DS}$                 | 漏源电压         | 80                    |     | V  |
| $Q_g$                    | 栅极电荷总量 (10V) | 48                    |     | nC |
| $Q_{gd}$                 | 栅极电荷 栅极到漏极   | 8.6                   |     | nC |
| $R_{DS(on)}$             | 漏源导通电阻       | $V_{GS} = 6\text{V}$  | 3.8 | mΩ |
|                          |              | $V_{GS} = 10\text{V}$ | 3.4 | mΩ |
| $V_{GS(th)}$             | 阈值电压         | 2.7                   |     | V  |

### 订购信息<sup>(1)</sup>

| 器件           | 介质      | 数量   | 封装                 | 出货   |
|--------------|---------|------|--------------------|------|
| CSD19502Q5B  | 13 英寸卷带 | 2500 | SON 5mm x 6mm 塑料封装 | 卷带封装 |
| CSD19502Q5BT | 13 英寸卷带 | 250  |                    |      |

(1) 要了解所有可用封装, 请参见数据表末尾的可订购产品附录。

### 绝对最大额定值

| $T_A = 25^\circ\text{C}$ |   | 值         | 单位               |
|--------------------------|---|-----------|------------------|
| $V_{DS}$                 | 漏源电压  | 80        | V                |
| $V_{GS}$                 | 栅源电压  | $\pm 20$  | V                |
| $I_D$                    | 持续漏极电流 (受封装限制)  | 100       | A                |
|                          | 持续漏极电流 (受芯片限制), $T_C = 25^\circ\text{C}$ 时测得                      | 157       |                  |
|                          | 持续漏极电流 <sup>(1)</sup>   | 17        |                  |
| $I_{DM}$                 | 脉冲漏极电流 <sup>(2)</sup>   | 400       | A                |
| $P_D$                    | 功率耗散 <sup>(1)</sup>   | 3.1       | W                |
|                          | 功率耗散, $T_C = 25^\circ\text{C}$                                    | 195       |                  |
| $T_J, T_{stg}$           | 运行结温和 储存温度范围  | -55 至 150 | $^\circ\text{C}$ |
| $E_{AS}$                 | 雪崩能量, 单脉冲<br>$I_D = 74\text{A}, L = 0.1\text{mH}, R_G = 25\Omega$ | 274       | mJ               |

(1)  $R_{\theta JA} = 40^\circ\text{C}/\text{W}$ , 这是在一个厚度 0.06 英寸环氧树脂 (FR4) 印刷电路板 (PCB) 上的 1 英寸<sup>2</sup>, 2 盎司的铜过渡垫片上测得的典型值。

(2) 最大  $R_{\theta JC} = 0.8^\circ\text{C}/\text{W}$ , 脉冲持续时间  $\leq 100\mu\text{s}$ , 占空比  $\leq 1\%$



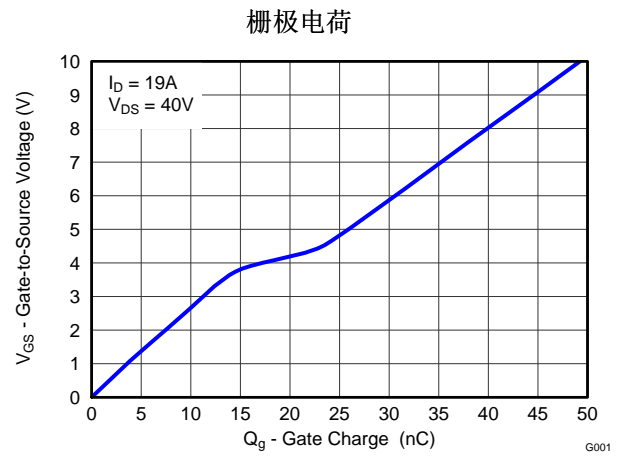
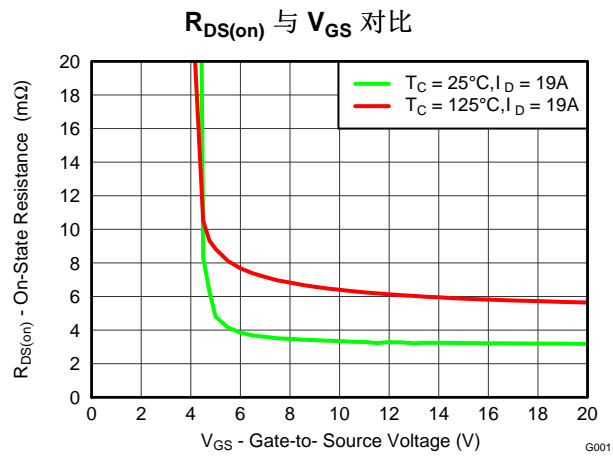

## 目录

|          |  |          |            |                          |           |
|----------|--|----------|------------|--------------------------|-----------|
| <b>1</b> | 特性 .....                                 | <b>1</b> | <b>6.1</b> | 接收文档更新通知 .....           | <b>8</b>  |
| <b>2</b> | 应用范围 .....                               | <b>1</b> | <b>6.2</b> | 社区资源 .....               | <b>8</b>  |
| <b>3</b> | 说明 .....                                 | <b>1</b> | <b>6.3</b> | 商标 .....                 | <b>8</b>  |
| <b>4</b> | 修订历史记录 .....                             | <b>3</b> | <b>6.4</b> | 静电放电警告 .....             | <b>8</b>  |
| <b>5</b> | <b>Specifications</b> .....              | <b>4</b> | <b>6.5</b> | Glossary .....           | <b>8</b>  |
|          | 5.1 Electrical Characteristics .....     | <b>4</b> | <b>7</b>   | <b>机械、封装和可订购信息</b> ..... | <b>9</b>  |
|          | 5.2 Thermal Information .....            | <b>4</b> | <b>7.1</b> | Q5B 封装尺寸 .....           | <b>9</b>  |
|          | 5.3 Typical MOSFET Characteristics ..... | <b>5</b> | <b>7.2</b> | 建议 PCB 布局 .....          | <b>10</b> |
| <b>6</b> | 器件和文档支持 .....                            | <b>8</b> | <b>7.3</b> | 建议模板布局 .....             | <b>10</b> |
|          |  |          | <b>7.4</b> | Q5B 卷带信息 .....           | <b>11</b> |

## 4 修订历史记录

### Changes from Revision A (June 2014) to Revision B

**Page**

|  |           |
|--|-----------|
| • 已添加 接收文档更新通知 和社区资源 部分添加到了器件和文档支持。 .....                          | <b>8</b>  |
| • 已更改 在建议 PCB 布局 部分方框图中将焊盘 3 和 4 之间的尺寸从 0.028 英寸更改为 0.050 英寸 ..... | <b>10</b> |

### Changes from Original (December 2013) to Revision A

**Page**

|   |          |
|---|----------|
| • 在订购信息表中添加了小卷带选项。 .....  | <b>1</b> |
| • 将芯片对持续漏极电流的限值增加至 157A。 .....  | <b>1</b> |
| • 将最大脉冲电流增加至 400A。 .....  | <b>1</b> |
| • 添加了外壳温度保持在 25°C 时的最大额定功率。 .....   | <b>1</b> |
| • 更新了脉冲电流条件, 规定占空比 $\leq 1\%$ , 脉冲持续时间 $\leq 100\mu\text{s}$ , 并且最大 $R_{\theta\text{JC}} = 0.8^\circ\text{C/W}$ 。 ..... | <b>1</b> |
| • Updated <b>Figure 10</b> . .....  | <b>7</b> |
| • 更新了机械图纸。 .....  | <b>9</b> |

## 5 Specifications

### 5.1 Electrical Characteristics

 (T<sub>A</sub> = 25°C unless otherwise stated)

| PARAMETER                      |                                  | TEST CONDITIONS   | MIN | TYP  | MAX  | UNIT |
|--------------------------------|----------------------------------|---|-----|------|------|------|
| <b>STATIC CHARACTERISTICS</b>  |                                  |   |     |      |      |      |
| B <sub>V</sub> DSS             | Drain-to-Source Voltage          | V <sub>GS</sub> = 0 V, I <sub>D</sub> = 250 μA  | 80  |      |      | V    |
| I <sub>DSS</sub>               | Drain-to-Source Leakage Current  | V <sub>GS</sub> = 0 V, V <sub>DS</sub> = 64 V   |     |      | 1    | μA   |
| I <sub>GSS</sub>               | Gate-to-Source Leakage Current   | V <sub>DS</sub> = 0 V, V <sub>GS</sub> = 20 V   |     |      | 100  | nA   |
| V <sub>GS(th)</sub>            | Gate-to-Source Threshold Voltage | V <sub>DS</sub> = V <sub>GS</sub> , I <sub>D</sub> = 250 μA                                     | 2.2 | 2.7  | 3.3  | V    |
| R <sub>DS(on)</sub>            | Drain-to-Source On Resistance    | V <sub>GS</sub> = 6 V, I <sub>D</sub> = 19 A  |     | 3.8  | 4.8  | mΩ   |
|                                |                                  | V <sub>GS</sub> = 10 V, I <sub>D</sub> = 19 A   |     | 3.4  | 4.1  | mΩ   |
| g <sub>fs</sub>                | Transconductance                 | V <sub>DS</sub> = 8 V, I <sub>D</sub> = 19 A  |     | 88   |      | S    |
| <b>DYNAMIC CHARACTERISTICS</b> |                                  |   |     |      |      |      |
| C <sub>iss</sub>               | Input Capacitance                | V <sub>GS</sub> = 0 V, V <sub>DS</sub> = 40 V, f = 1 MHz  |     | 3750 | 4870 | pF   |
| C <sub>oss</sub>               | Output Capacitance               |   |     | 925  | 1202 | pF   |
| C <sub>rss</sub>               | Reverse Transfer Capacitance     |   |     | 17   | 22   | pF   |
| R <sub>G</sub>                 | Series Gate Resistance           |   |     | 1.2  | 2.4  | Ω    |
| Q <sub>g</sub>                 | Gate Charge Total (10 V)         | V <sub>DS</sub> = 40 V, I <sub>D</sub> = 19 A   |     | 48   | 62   | nC   |
| Q <sub>gd</sub>                | Gate Charge Gate to Drain        |   |     | 8.6  |      | nC   |
| Q <sub>gs</sub>                | Gate Charge Gate to Source       |   |     | 14   |      | nC   |
| Q <sub>g(th)</sub>             | Gate Charge at V <sub>th</sub>   |   |     | 10   |      | nC   |
| Q <sub>oss</sub>               | Output Charge                    | V <sub>DS</sub> = 40 V, V <sub>GS</sub> = 0 V   |     | 130  |      | nC   |
| t <sub>d(on)</sub>             | Turn On Delay Time               | V <sub>DS</sub> = 40 V, V <sub>GS</sub> = 10 V,<br>I <sub>DS</sub> = 19 A, R <sub>G</sub> = 0 Ω |     | 8    |      | ns   |
| t <sub>r</sub>                 | Rise Time                        |   |     | 6    |      | ns   |
| t <sub>d(off)</sub>            | Turn Off Delay Time              |   |     | 22   |      | ns   |
| t <sub>f</sub>                 | Fall Time                        |   |     | 7    |      | ns   |
| <b>DIODE CHARACTERISTICS</b>   |                                  |   |     |      |      |      |
| V <sub>SD</sub>                | Diode Forward Voltage            | I <sub>SD</sub> = 19 A, V <sub>GS</sub> = 0 V   |     | 0.8  | 1    | V    |
| Q <sub>rr</sub>                | Reverse Recovery Charge          | V <sub>DS</sub> = 40 V, I <sub>F</sub> = 19 A,<br>di/dt = 300 A/μs                              |     | 275  |      | nC   |
| t <sub>rr</sub>                | Reverse Recovery Time            |   |     | 72   |      | ns   |

### 5.2 Thermal Information

 (T<sub>A</sub> = 25°C unless otherwise stated)

| THERMAL METRIC   |  | MIN | TYP | MAX | UNIT |
|------------------|--|-----|-----|-----|------|
| R <sub>θJC</sub> | Junction-to-Case Thermal Resistance <sup>(1)</sup>       |     |     | 0.8 | °C/W |
| R <sub>θJA</sub> | Junction-to-Ambient Thermal Resistance <sup>(1)(2)</sup> |     |     | 50  |      |

- (1) R<sub>θJC</sub> is determined with the device mounted on a 1-inch<sup>2</sup> (6.45-cm<sup>2</sup>), 2-oz. (0.071-mm thick) Cu pad on a 1.5-inches × 1.5-inches (3.81-cm × 3.81-cm), 0.06-inch (1.52-mm) thick FR4 PCB. R<sub>θJC</sub> is specified by design, whereas R<sub>θJA</sub> is determined by the user's board design.
- (2) Device mounted on FR4 material with 1-inch<sup>2</sup> (6.45-cm<sup>2</sup>), 2-oz. (0.071-mm thick) Cu.

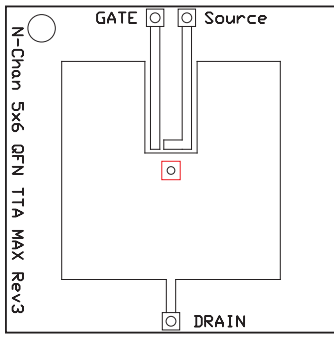

M0137-01

Max  $R_{\theta JA} = 50^{\circ}\text{C/W}$   
when mounted on  
1 inch<sup>2</sup> (6.45 cm<sup>2</sup>) of  
2-oz. (0.071-mm thick)  
Cu.

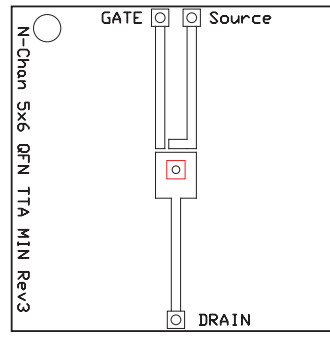

M0137-02

Max  $R_{\theta JA} = 125^{\circ}\text{C/W}$   
when mounted on a  
minimum pad area of  
2-oz. (0.071-mm thick)  
Cu.

### 5.3 Typical MOSFET Characteristics

( $T_A = 25^{\circ}\text{C}$  unless otherwise stated)

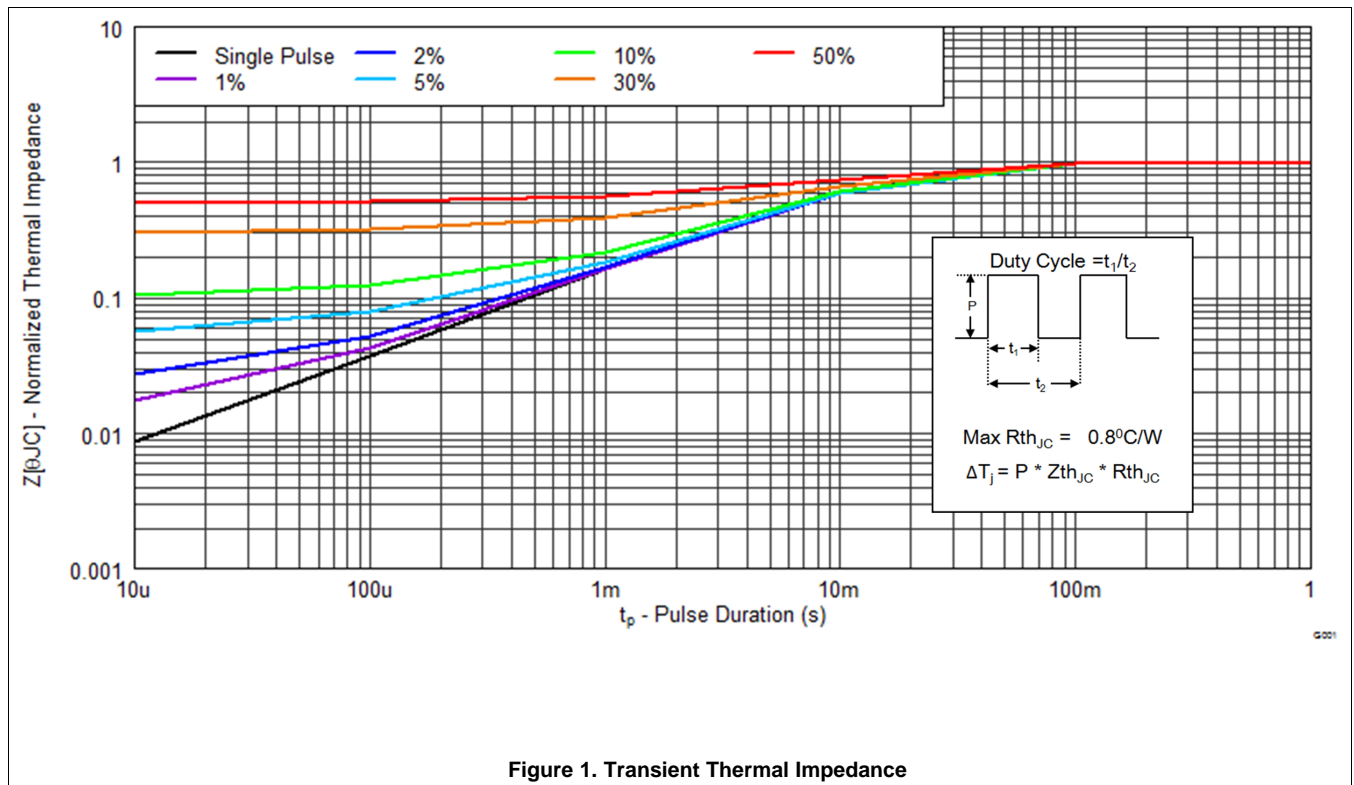

Typical MOSFET Characteristics (continued)

( $T_A = 25^\circ\text{C}$  unless otherwise stated)

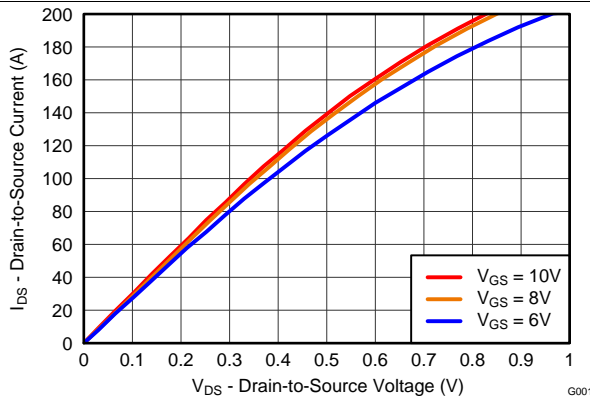

Figure 2. Saturation Characteristics

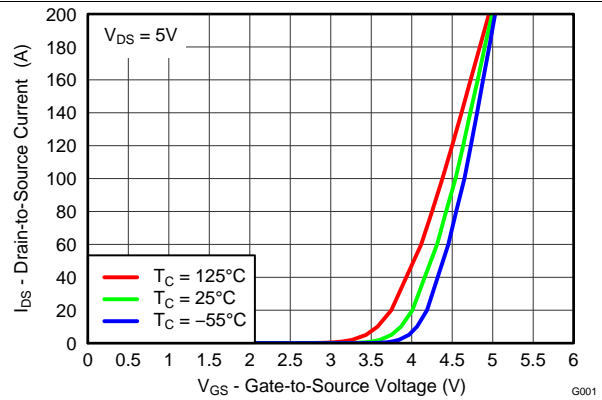

Figure 3. Transfer Characteristics

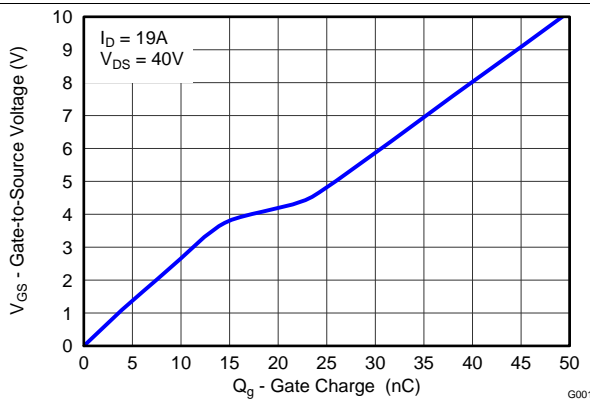

Figure 4. Gate Charge

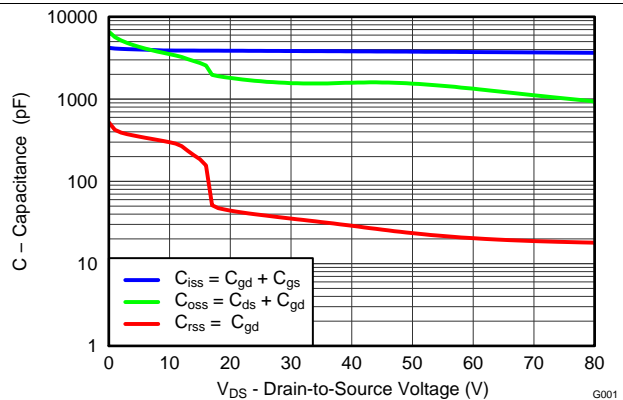

Figure 5. Capacitance

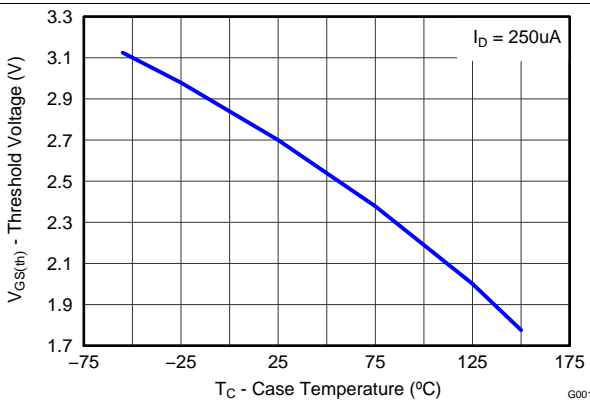

Figure 6. Threshold Voltage vs Temperature

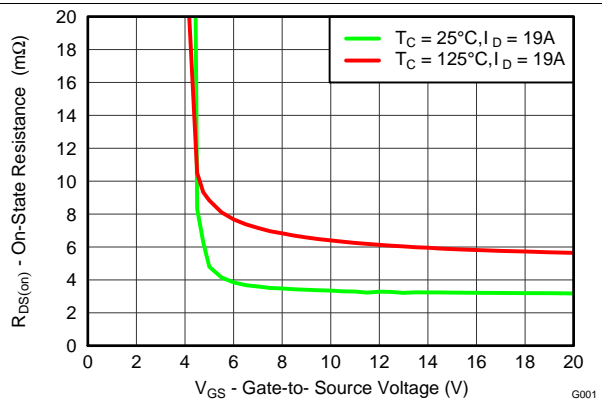

Figure 7. On-State Resistance vs Gate-to-Source Voltage

Typical MOSFET Characteristics (continued)

( $T_A = 25^\circ\text{C}$  unless otherwise stated)

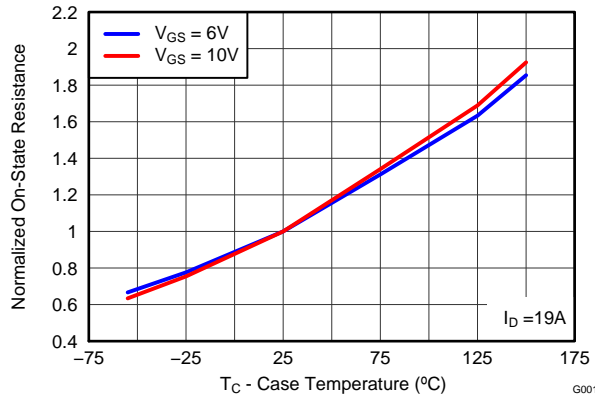

Figure 8. Normalized On-State Resistance vs Temperature

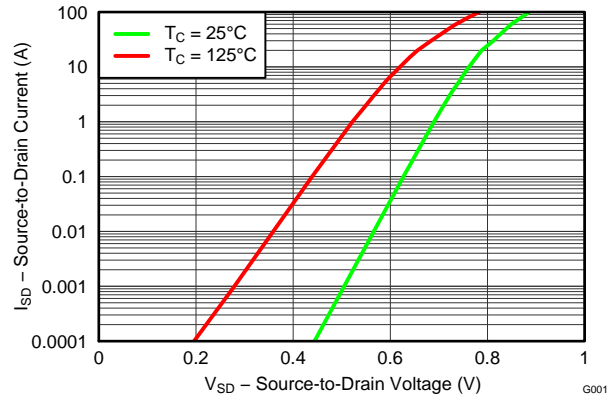

Figure 9. Typical Diode Forward Voltage

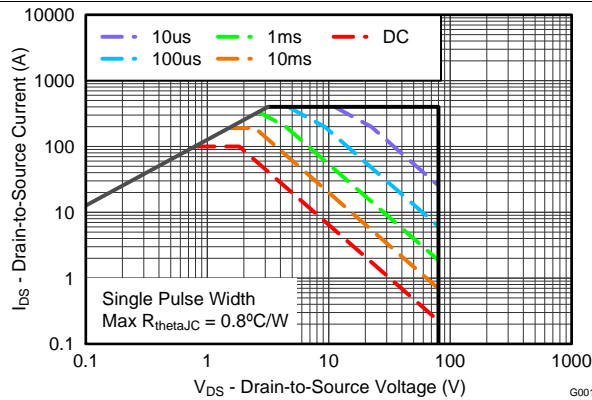

Figure 10. Maximum Safe Operating Area

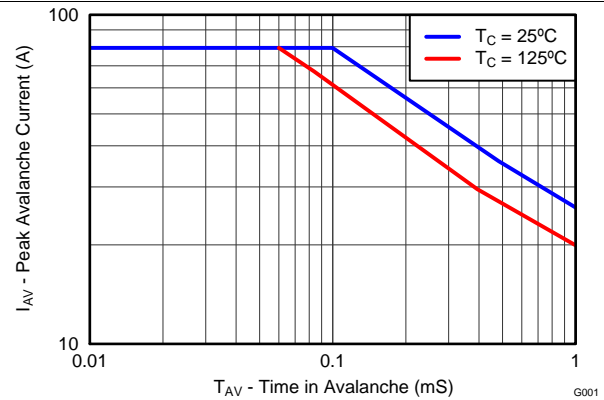

Figure 11. Single Pulse Unclamped Inductive Switching

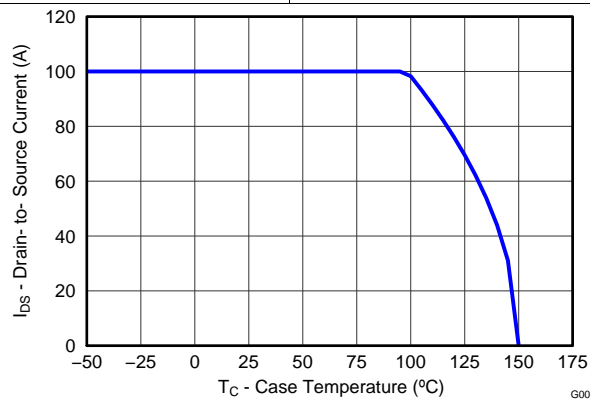

Figure 12. Maximum Drain Current vs Temperature

## 6 器件和文档支持

### 6.1 接收文档更新通知

如需接收文档更新通知，请访问 [www.ti.com.cn](http://www.ti.com.cn) 网站上的器件产品文件夹。点击右上角的提醒我 (Alert me) 注册后，即可每周定期收到已更改的产品信息。有关更改的详细信息，请查阅已修订文档中包含的修订历史记录。

### 6.2 社区资源

The following links connect to TI community resources. Linked contents are provided "AS IS" by the respective contributors. They do not constitute TI specifications and do not necessarily reflect TI's views; see TI's [Terms of Use](#).

**TI E2E™ Online Community** *TI's Engineer-to-Engineer (E2E) Community*. Created to foster collaboration among engineers. At [e2e.ti.com](http://e2e.ti.com), you can ask questions, share knowledge, explore ideas and help solve problems with fellow engineers.

**Design Support** *TI's Design Support* Quickly find helpful E2E forums along with design support tools and contact information for technical support.

### 6.3 商标

NexFET, E2E are trademarks of Texas Instruments.

### 6.4 静电放电警告



这些装置包含有限的内置 ESD 保护。存储或装卸时，应将导线一起截短或将装置放置于导电泡棉中，以防止 MOS 门极遭受静电损伤。

### 6.5 Glossary

**SLYZ022** — *TI Glossary*.

This glossary lists and explains terms, acronyms, and definitions.



## 7 机械、封装和可订购信息

以下页中包括机械封装、封装和可订购信息。这些信息是针对指定器件可提供的最新数据。这些数据会在无通知且不对本文档进行修订的情况下发生改变。要获得这份数据表的浏览器版本，请查阅左侧的导航栏。

### 7.1 Q5B 封装尺寸

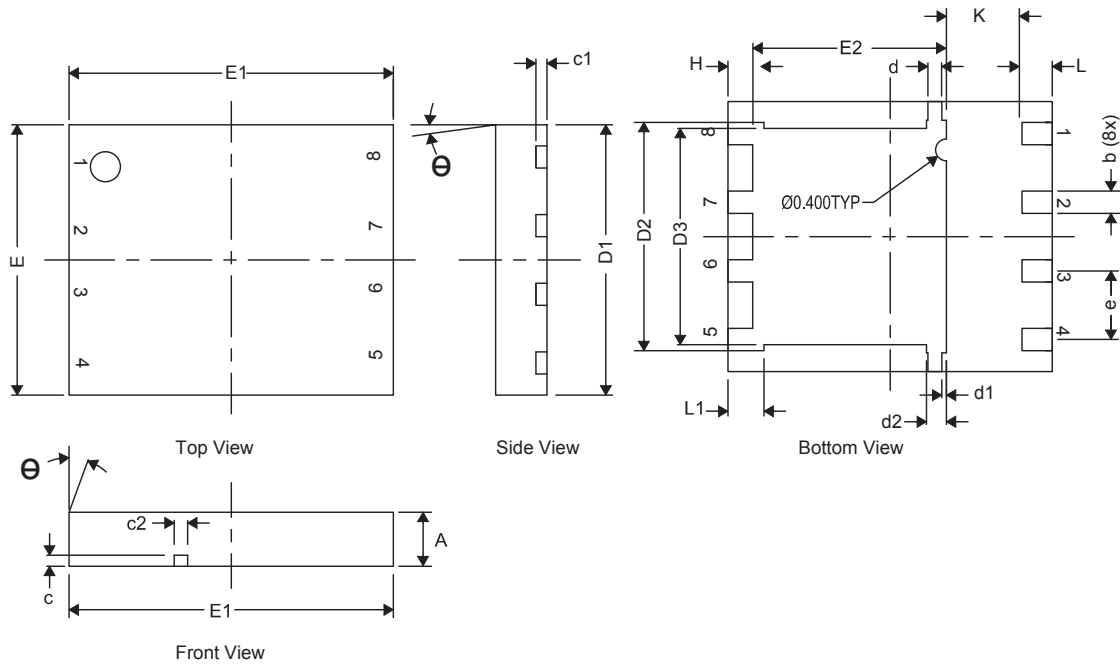

| DIM | 毫米        |       |       |
|-----|-----------|-------|-------|
|     | 最小值       | 标称值   | 最大值   |
| A   | 0.80      | 1.00  | 1.05  |
| b   | 0.36      | 0.41  | 0.46  |
| c   | 0.15      | 0.20  | 0.25  |
| c1  | 0.15      | 0.20  | 0.25  |
| c2  | 0.20      | 0.25  | 0.30  |
| D1  | 4.90      | 5.00  | 5.10  |
| D2  | 4.12      | 4.22  | 4.32  |
| D3  | 3.90      | 4.00  | 4.10  |
| d   | 0.20      | 0.25  | 0.30  |
| d1  | 0.085 典型值 |       |       |
| d2  | 0.319     | 0.369 | 0.419 |
| E   | 4.90      | 5.00  | 5.10  |
| E1  | 5.90      | 6.00  | 6.10  |
| E2  | 3.48      | 3.58  | 3.68  |
| e   | 1.27 典型值  |       |       |
| H   | 0.36      | 0.46  | 0.56  |
| L   | 0.46      | 0.56  | 0.66  |
| L1  | 0.57      | 0.67  | 0.77  |
| θ   | 0°        | —     | —     |
| K   | 1.40 典型值  |       |       |

## 7.2 建议 PCB 布局

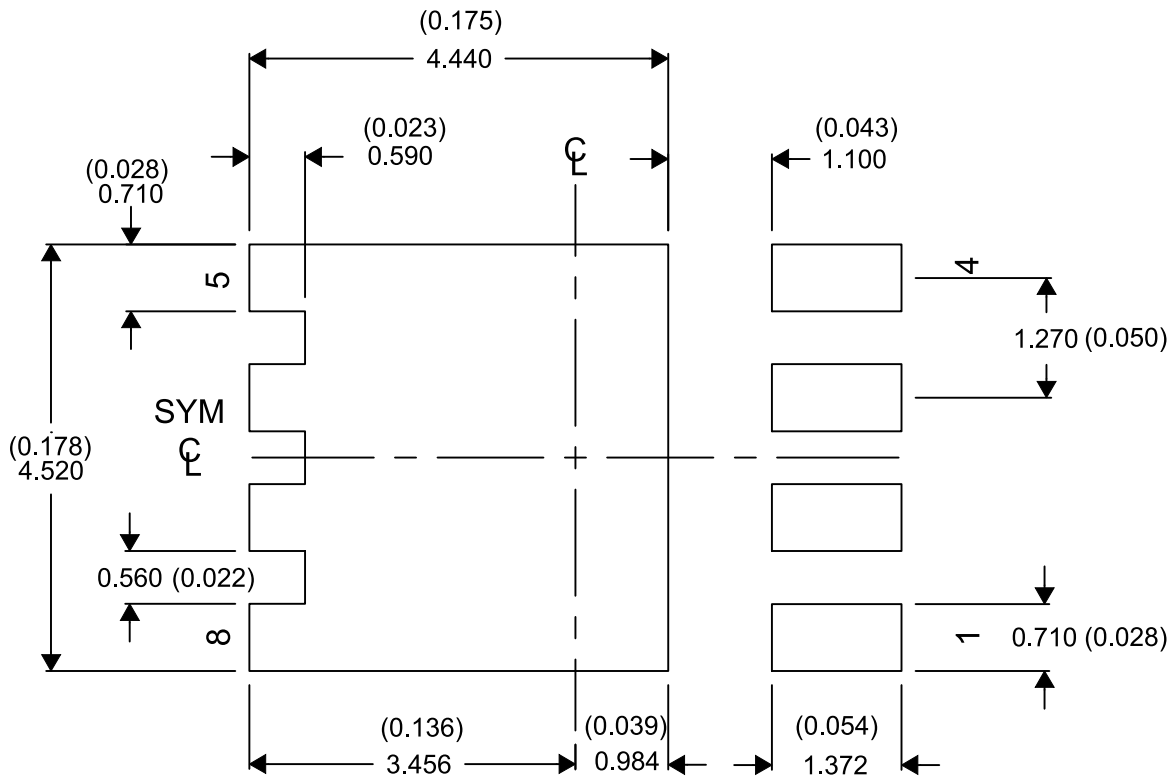

要获得与印刷电路板 (PCB) 设计相关的建议电路布局布线, 请参见《应用说明》[SLPA005 - 通过 PCB 布局布线技巧来减少振铃](#)。

## 7.3 建议模板布局

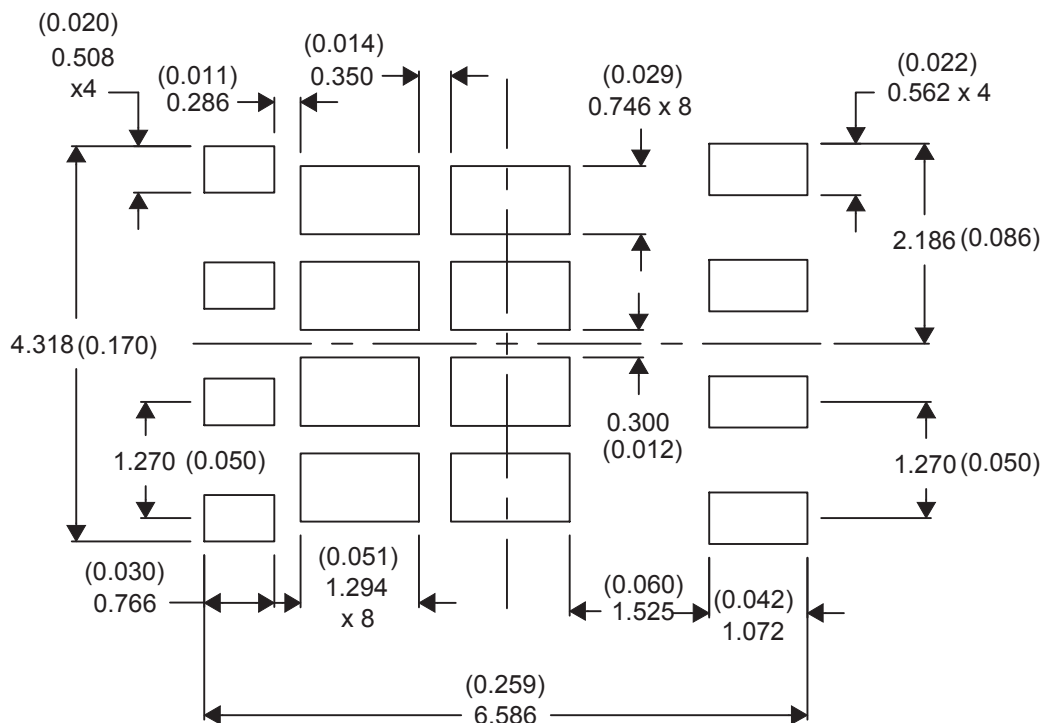

## 7.4 Q5B 卷带信息

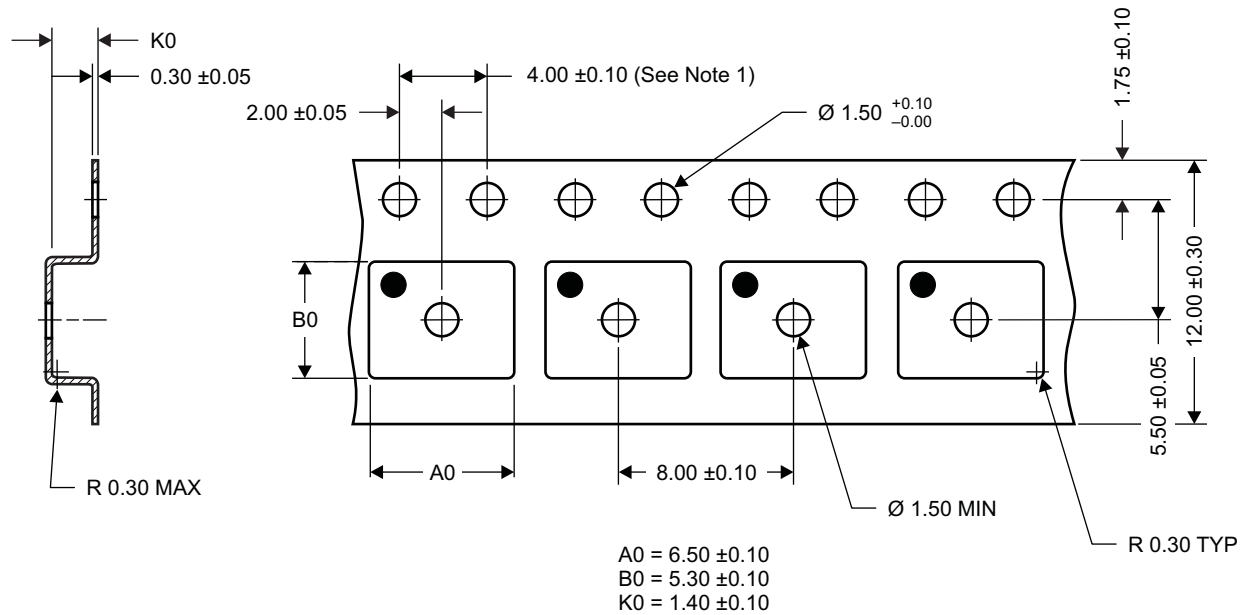

M0138-01

### 注释:

1. 10 个链齿孔的累积容差为  $\pm 0.2$
2. 每 100mm 长度的翘曲不能超过 1mm，在 250mm 长度上不累积
3. 材料：黑色抗静电聚苯乙烯
4. 全部尺寸单位为 mm（除非另外注明）。
5. 高于孔眼底部 0.3mm 的平面上测量得到 A0 和 B0 值。

## PACKAGING INFORMATION

| Orderable Device | Status<br>(1) | Package Type | Package<br>Drawing | Pins | Package<br>Qty | Eco Plan<br>(2)        | Lead finish/<br>Ball material<br>(6) | MSL Peak Temp<br>(3) | Op Temp (°C) | Device Marking<br>(4/5) | Samples                 |
|------------------|---------------|--------------|--------------------|------|----------------|------------------------|--------------------------------------|----------------------|--------------|-------------------------|-------------------------|
| CSD19502Q5B      | ACTIVE        | VSON-CLIP    | DNK                | 8    | 2500           | RoHS-Exempt<br>& Green | SN                                   | Level-1-260C-UNLIM   | -55 to 150   | CSD19502                | <a href="#">Samples</a> |
| CSD19502Q5BT     | ACTIVE        | VSON-CLIP    | DNK                | 8    | 250            | RoHS-Exempt<br>& Green | SN                                   | Level-1-260C-UNLIM   | -55 to 150   | CSD19502                | <a href="#">Samples</a> |

(1) The marketing status values are defined as follows:

**ACTIVE:** Product device recommended for new designs.

**LIFEBUY:** TI has announced that the device will be discontinued, and a lifetime-buy period is in effect.

**NRND:** Not recommended for new designs. Device is in production to support existing customers, but TI does not recommend using this part in a new design.

**PREVIEW:** Device has been announced but is not in production. Samples may or may not be available.

**OBSOLETE:** TI has discontinued the production of the device.

(2) **RoHS:** TI defines "RoHS" to mean semiconductor products that are compliant with the current EU RoHS requirements for all 10 RoHS substances, including the requirement that RoHS substance do not exceed 0.1% by weight in homogeneous materials. Where designed to be soldered at high temperatures, "RoHS" products are suitable for use in specified lead-free processes. TI may reference these types of products as "Pb-Free".

**RoHS Exempt:** TI defines "RoHS Exempt" to mean products that contain lead but are compliant with EU RoHS pursuant to a specific EU RoHS exemption.

**Green:** TI defines "Green" to mean the content of Chlorine (Cl) and Bromine (Br) based flame retardants meet JS709B low halogen requirements of <=1000ppm threshold. Antimony trioxide based flame retardants must also meet the <=1000ppm threshold requirement.

(3) MSL, Peak Temp. - The Moisture Sensitivity Level rating according to the JEDEC industry standard classifications, and peak solder temperature.

(4) There may be additional marking, which relates to the logo, the lot trace code information, or the environmental category on the device.

(5) Multiple Device Markings will be inside parentheses. Only one Device Marking contained in parentheses and separated by a "~" will appear on a device. If a line is indented then it is a continuation of the previous line and the two combined represent the entire Device Marking for that device.

(6) Lead finish/Ball material - Orderable Devices may have multiple material finish options. Finish options are separated by a vertical ruled line. Lead finish/Ball material values may wrap to two lines if the finish value exceeds the maximum column width.

**Important Information and Disclaimer:** The information provided on this page represents TI's knowledge and belief as of the date that it is provided. TI bases its knowledge and belief on information provided by third parties, and makes no representation or warranty as to the accuracy of such information. Efforts are underway to better integrate information from third parties. TI has taken and continues to take reasonable steps to provide representative and accurate information but may not have conducted destructive testing or chemical analysis on incoming materials and chemicals. TI and TI suppliers consider certain information to be proprietary, and thus CAS numbers and other limited information may not be available for release.

In no event shall TI's liability arising out of such information exceed the total purchase price of the TI part(s) at issue in this document sold by TI to Customer on an annual basis.



## 重要声明和免责声明

TI 均以“原样”提供技术性及其可靠性数据（包括数据表）、设计资源（包括参考设计）、应用或其他设计建议、网络工具、安全信息和其他资源，不保证其中不含任何瑕疵，且不做任何明示或暗示的担保，包括但不限于对适销性、适合某特定用途或不侵犯任何第三方知识产权的暗示担保。

所述资源可供专业开发人员应用TI 产品进行设计使用。您将对以下行为独自承担全部责任：(1) 针对您的应用选择合适的TI 产品；(2) 设计、验证并测试您的应用；(3) 确保您的应用满足相应标准以及任何其他安全、安保或其他要求。所述资源如有变更，恕不另行通知。TI 对您使用所述资源的授权仅限于开发资源所涉及TI 产品的相关应用。除此之外不得复制或展示所述资源，也不提供其它TI 或任何第三方的知识产权授权许可。如因使用所述资源而产生任何索赔、赔偿、成本、损失及债务等，TI 对此概不负责，并且您须赔偿由此对TI 及其代表造成的损害。

TI 所提供产品均受TI 的销售条款 (<http://www.ti.com.cn/zh-cn/legal/termsofsale.html>) 以及ti.com.cn上或随附TI产品提供的其他可适用条款的约束。TI提供所述资源并不扩展或以其他方式更改TI 针对TI 产品所发布的可适用的担保范围或担保免责声明。

邮寄地址：上海市浦东新区世纪大道 1568 号中建大厦 32 楼，邮政编码：200122  
Copyright © 2020 德州仪器半导体技术（上海）有限公司