

CSD88599Q5DC 60V 半桥 NexFET™电源块

1 特性

- 半桥电源块
- 高密度 5mm × 6mm SON 封装
- 低 $R_{DS(ON)}$, 可实现最小的传导损耗
 - 电流为 30A 时, P_{Loss} 为 3.0W
- DualCool™热增强型封装
- 超低电感封装
- 符合 RoHS 标准
- 无卤素
- 无铅引脚镀层

2 应用

- 用于无刷直流电机控制的三相桥
- 多达 12s 电池的电动工具
- 其他半桥和全桥拓扑

电源块原理图

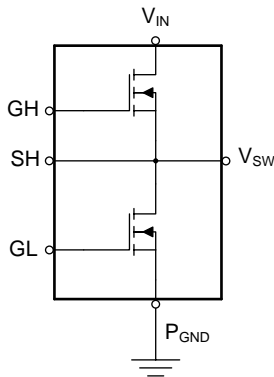

Copyright © 2017, Texas Instruments Incorporated

典型电路

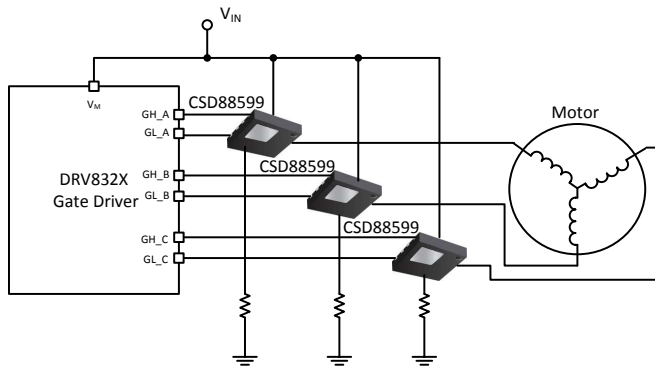

Copyright © 2017, Texas Instruments Incorporated

3 说明

CSD88599Q5DC 60V 电源块是用于高电流电机控制应用的经优化设计, 这些应用包括手持无线园艺和电动工具等。该器件利用 TI 的堆叠裸片技术, 以最大限度地减小寄生电感, 同时在节省空间的热增强型 DualCool™5mm × 6mm 封装中提供完整的半桥。利用外露的金属顶部, 该电源块器件允许简单散热应用将热量从封装顶部吸收并将其从 PCB 带走, 从而在许多电机控制应用所要求的较高电流下, 实现出色的热性能。

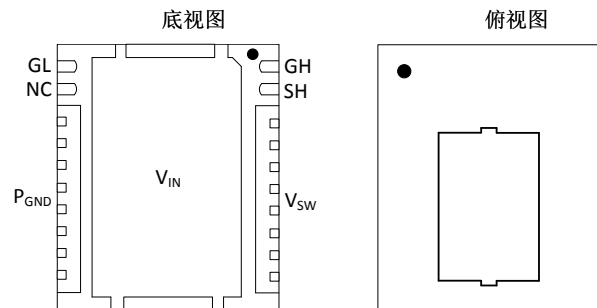

器件信息

器件	数量	包装介质	封装	发货
CSD88599Q5DC	2500	13 英寸卷带	SON	卷带封装
CSD88599Q5DCT	250	7 英寸卷带	5.00mm × 6.00mm 塑料封装	

功率损耗与输出电流

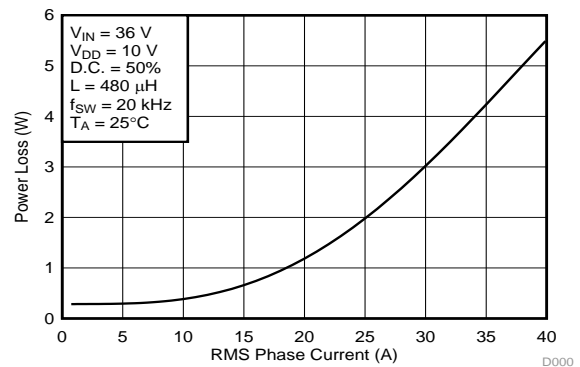

D000



目录

1	特性	1	6.5	Normalized Power Loss Curves.....	13
2	应用	1	6.6	Design Example – Regulate Current to Maintain Safe Operation	13
3	说明	1	6.7	Design Example – Regulate Board and Case Temperature to Maintain Safe Operation	14
4	修订历史记录	2	7	Layout	16
5	Specifications	3	7.1	Layout Guidelines	16
	5.1 Absolute Maximum Ratings	3	7.2	Layout Example	18
	5.2 Recommended Operating Conditions.....	3	8	器件和文档支持	19
	5.3 Power Block Performance	3	8.1	接收文档更新通知	19
	5.4 Thermal Information	4	8.2	社区资源.....	19
	5.5 Electrical Characteristics.....	4	8.3	商标	19
	5.6 Typical Power Block Device Characteristics.....	6	8.4	静电放电警告.....	19
	5.7 Typical Power Block MOSFET Characteristics.....	7	8.5	Glossary	19
6	Application and Implementation	9	9	机械、封装和可订购信息	20
	6.1 Application Information.....	9	9.1	Q5DC 封装尺寸.....	20
	6.2 Brushless DC Motor With Trapezoidal Control	10	9.2	焊盘图案建议.....	21
	6.3 Power Loss Curves	12	9.3	模版建议.....	22
	6.4 Safe Operating Area (SOA) Curve.....	13			

4 修订历史记录

Changes from Revision B (January 2018) to Revision C	Page
• Corrected Figure 20 to show 40-A maximum.....	13
• Corrected Figure 21 to show 40-A maximum.....	14

Changes from Revision A (May 2017) to Revision B	Page
• 更新了机械制图.....	20

Changes from Original (April 2017) to Revision A	Page
• 更新了典型电路制图	1
• Changed the copper thickness to 2-oz in <i>Typical Power Block Device Characteristics</i> conditions	6
• Changed the copper thickness to 2-oz in <i>Safe Operating Area (SOA) Curve</i> paragraph.....	13

5 Specifications

5.1 Absolute Maximum Ratings⁽¹⁾

 $T_J = 25^\circ\text{C}$ (unless otherwise noted)

PARAMETER	CONDITIONS	MIN	MAX	UNIT
Voltage	V_{IN} to P_{GND}	-0.8	60	V
	V_{SW} to P_{GND}	-0.3	60	
	GH to SH	-20	20	
	GL to P_{GND}	-20	20	
Pulsed current rating, $I_{DM}^{(2)}$			400	A
Power dissipation, P_D			12	W
Avalanche energy, E_{AS}	High-side FET, $I_D = 95\text{ A}$, $L = 0.1\text{ mH}$		448	mJ
	Low-side FET, $I_D = 95\text{ A}$, $L = 0.1\text{ mH}$		448	
Operating junction temperature, T_J		-55	150	$^\circ\text{C}$
Storage temperature, T_{stg}		-55	150	$^\circ\text{C}$

- (1) Stresses beyond those listed under *Absolute Maximum Ratings* may cause permanent damage to the device. These are stress ratings only, and functional operation of the device at these or any other conditions beyond those indicated in the *Recommended Operating Conditions* is not implied. Exposure to absolute-maximum-rated conditions for extended periods may affect device reliability.
- (2) Single FET conduction, max $R_{\theta JC} = 1.1^\circ\text{C/W}$, pulse duration $\leq 100\ \mu\text{s}$, single pulse.

5.2 Recommended Operating Conditions

 $T_J = 25^\circ\text{C}$ (unless otherwise noted)

PARAMETER	CONDITIONS	MIN	MAX	UNIT
V_{DD} Gate drive voltage		4.5	16	V
V_{IN} Input supply voltage ⁽¹⁾			54	V
f_{SW} Switching frequency	$C_{BST} = 0.1\ \mu\text{F}$ (min)	5	50	kHz
I_{OUT} RMS motor winding current			40	A
T_J Operating temperature			125	$^\circ\text{C}$

- (1) Up to 42-V input use one capacitor per phase, MLCC 10 nF, 100 V, X7S, 0402, PN: C1005X7S2A103K050BB from V_{IN} to GND return. Between 42-V to 54-V input operation, add RC switch-node snubber as described in the [Electrical Performance](#) section of this data sheet.

5.3 Power Block Performance

 $T_J = 25^\circ\text{C}$ (unless otherwise noted)

PARAMETER	CONDITIONS	MIN	TYP	MAX	UNIT
P_{LOSS} Power loss ⁽¹⁾	$V_{IN} = 36\text{ V}$, $V_{DD} = 10\text{ V}$, $I_{OUT} = 30\text{ A}$, $f_{SW} = 20\text{ kHz}$, $T_J = 25^\circ\text{C}$, duty cycle = 50%, $L = 480\ \mu\text{H}$		3.0		W
P_{LOSS} Power loss	$V_{IN} = 36\text{ V}$, $V_{DD} = 10\text{ V}$, $I_{OUT} = 30\text{ A}$, $f_{SW} = 20\text{ kHz}$, $T_J = 125^\circ\text{C}$, duty cycle = 50%, $L = 480\ \mu\text{H}$		3.4		W

- (1) Measurement made with eight 10- μF 50-V $\pm 10\%$ X5R (TDK C3225X5R1H106K250AB or equivalent) ceramic capacitors placed across V_{IN} to P_{GND} pins and using UCC27210DDAR 100-V, 4-A driver IC.

5.4 Thermal Information

 $T_J = 25^\circ\text{C}$ (unless otherwise stated)

THERMAL METRIC		MIN	TYP	MAX	UNIT
$R_{\theta JA}$	Junction-to-ambient thermal resistance (min Cu) ⁽¹⁾			125	°C/W
	Junction-to-ambient thermal resistance (max Cu) ⁽¹⁾⁽²⁾			50	
$R_{\theta JC}$	Junction-to-case thermal resistance (top of package) ⁽¹⁾			2.1	°C/W
	Junction-to-case thermal resistance (V_{IN} pin) ⁽¹⁾			1.1	

(1) $R_{\theta JC}$ is determined with the device mounted on a 1-in² (6.45-cm²), 2-oz (0.071-mm) thick Cu pad on a 1.5-in × 1.5-in (3.81-cm × 3.81-cm), 0.06-in (1.52-mm) thick FR4 board. $R_{\theta JC}$ is specified by design while $R_{\theta JA}$ is determined by the user's board design.

(2) Device mounted on FR4 material with 1-in² (6.45-cm²) Cu.

5.5 Electrical Characteristics

 $T_J = 25^\circ\text{C}$ (unless otherwise stated)

PARAMETER		TEST CONDITIONS	MIN	TYP	MAX	UNIT
STATIC CHARACTERISTICS						
BV_{DSS}	Drain-to-source voltage	$V_{GS} = 0\text{ V}, I_{DS} = 250\ \mu\text{A}$	60			V
I_{DSS}	Drain-to-source leakage current	$V_{GS} = 0\text{ V}, V_{DS} = 48\text{ V}$			1	μA
I_{GSS}	Gate-to-source leakage current	$V_{DS} = 0\text{ V}, V_{GS} = 20\text{ V}$			100	nA
$V_{GS(th)}$	Gate-to-source threshold voltage	$V_{DS} = V_{GS}, I_{DS} = 250\ \mu\text{A}$	1.4	2.0	2.5	V
$R_{DS(on)}$	Drain-to-source on-resistance	$V_{GS} = 4.5\text{ V}, I_{DS} = 30\text{ A}$		2.5	3.3	mΩ
		$V_{GS} = 10\text{ V}, I_{DS} = 30\text{ A}$		1.7	2.1	
g_{fs}	Transconductance	$V_{DS} = 6\text{ V}, I_{DS} = 30\text{ A}$		130		S
DYNAMIC CHARACTERISTICS						
C_{ISS}	Input capacitance	$V_{GS} = 0\text{ V}, V_{DS} = 30\text{ V}, f = 1\text{ MHz}$		3720	4840	pF
C_{OSS}	Output capacitance			670	870	pF
C_{RSS}	Reverse transfer capacitance			12	16	pF
R_G	Series gate resistance			0.9	1.8	Ω
Q_g	Gate charge total (4.5 V)	$V_{DS} = 30\text{ V}, I_{DS} = 30\text{ A}$		21	27	nC
Q_g	Gate charge total (10 V)			43	56	nC
Q_{gd}	Gate charge gate-to-drain			7.0		nC
Q_{gs}	Gate charge gate-to-source			10.1		nC
$Q_{g(th)}$	Gate charge at V_{th}			6.3		nC
Q_{OSS}	Output charge	$V_{DS} = 30\text{ V}, V_{GS} = 0\text{ V}$		100		nC
$t_{d(on)}$	Turnon delay time	$V_{DS} = 30\text{ V}, V_{GS} = 10\text{ V}, I_{DS} = 30\text{ A}, R_G = 0\ \Omega$		9		ns
t_r	Rise time			20		ns
$t_{d(off)}$	Turnoff delay time			23		ns
t_f	Fall time			3		ns
DIODE CHARACTERISTICS						
V_{SD}	Diode forward voltage	$I_{DS} = 30\text{ A}, V_{GS} = 0\text{ V}$		0.8	1.0	V
Q_{rr}	Reverse recovery charge	$V_{DS} = 30\text{ V}, I_F = 30\text{ A}, di/dt = 300\text{ A}/\mu\text{s}$		172		nC
t_{rr}	Reverse recovery time			36		ns

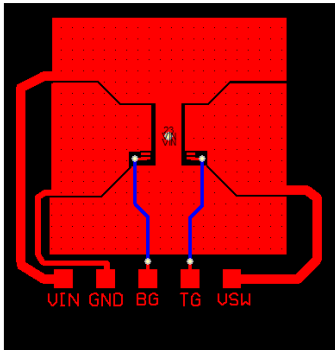

Max $R_{\theta JA} = 50^{\circ}\text{C/W}$
when mounted on 1 in²
(6.45 cm²) of 2-oz
(0.071-mm) thick Cu.

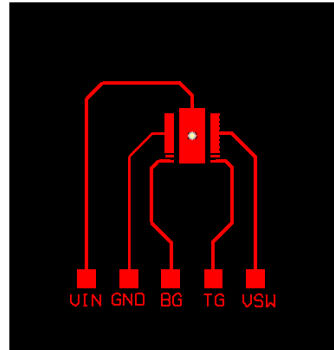

Max $R_{\theta JA} = 125^{\circ}\text{C/W}$
when mounted on
minimum pad area of
2-oz (0.071-mm) thick
Cu.

5.6 Typical Power Block Device Characteristics

The typical power block system characteristic curves (Figure 1 through Figure 6) are based on measurements made on a PCB design with dimensions of 4 in (W) × 3.5 in (L) × 0.062 in (H) and 6 copper layers of 2-oz copper thickness. See *Application and Implementation* section for detailed explanation. $T_J = 125^\circ\text{C}$, unless stated otherwise.

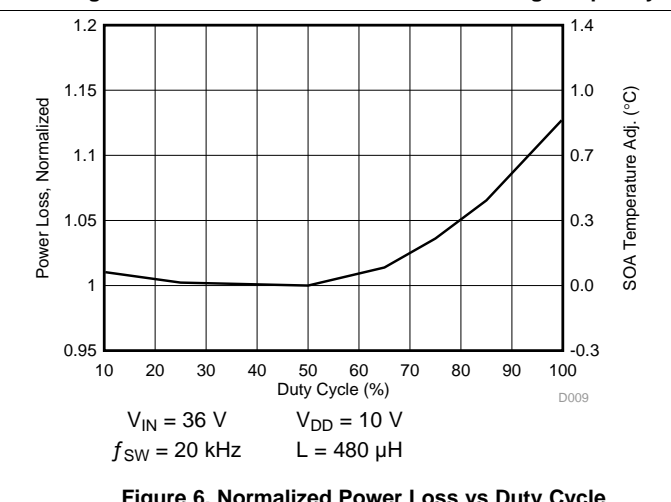
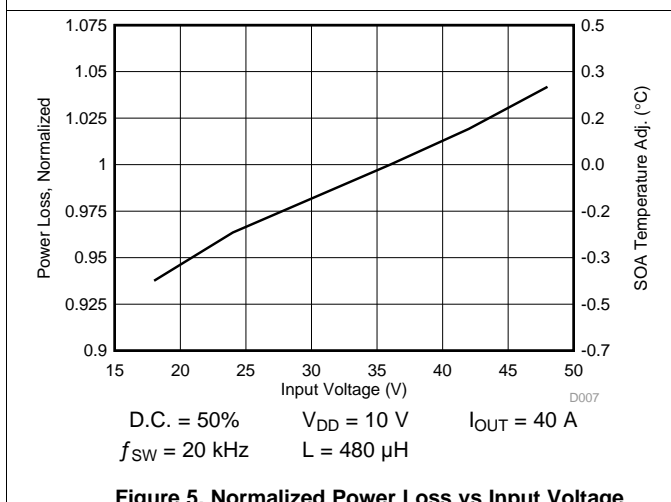
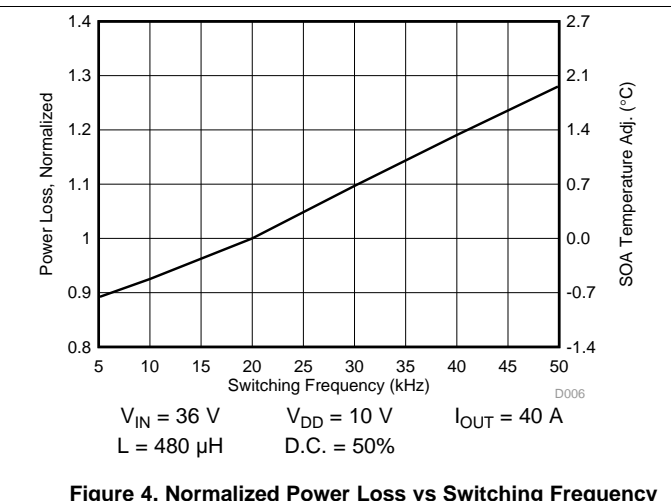
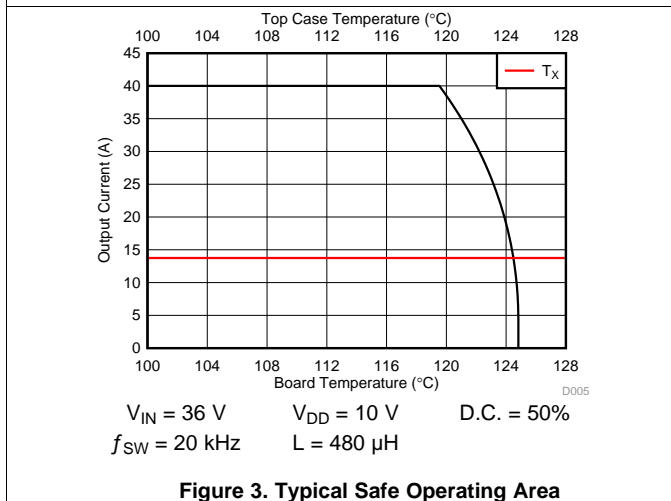
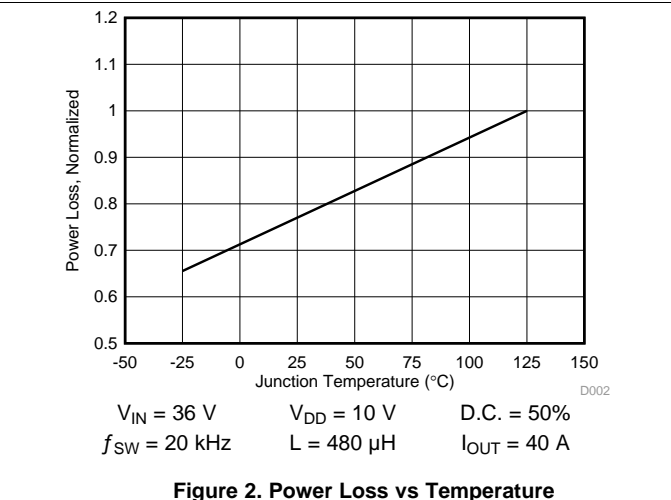
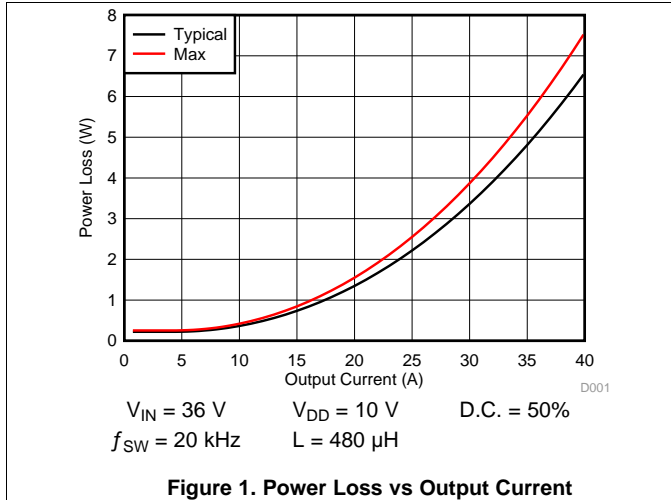

5.7 Typical Power Block MOSFET Characteristics

$T_J = 25^\circ\text{C}$, unless stated otherwise.

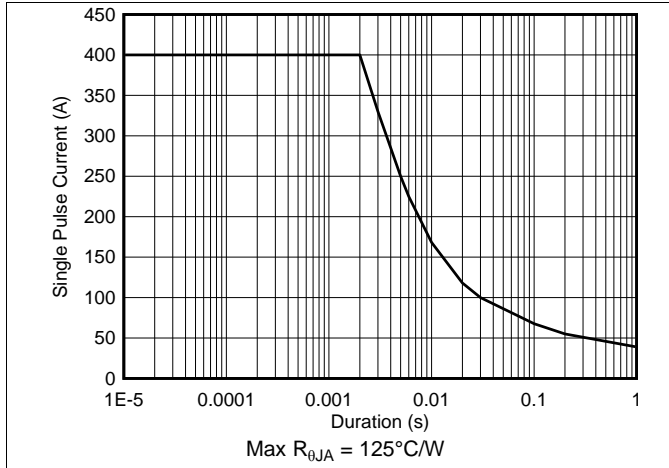

Figure 7. Single Pulse Current vs Pulse Duration

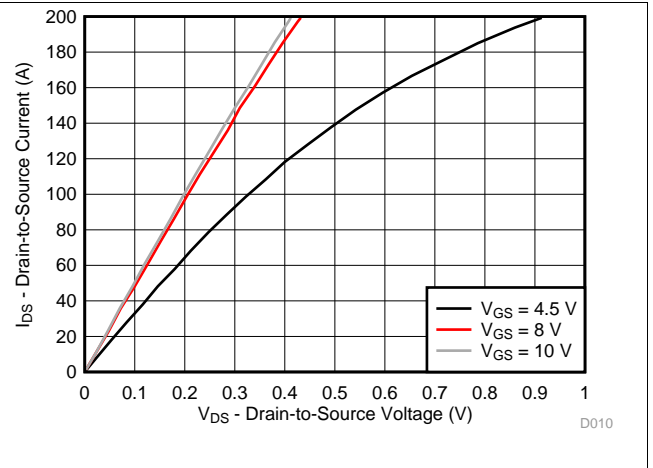

Figure 8. MOSFET Saturation Characteristics

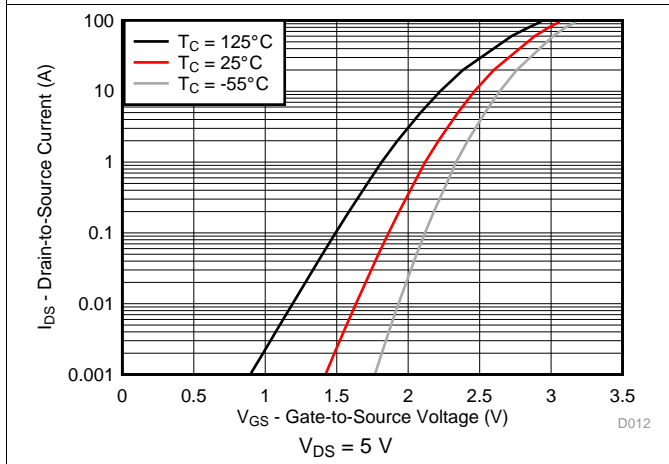

Figure 9. MOSFET Transfer Characteristics

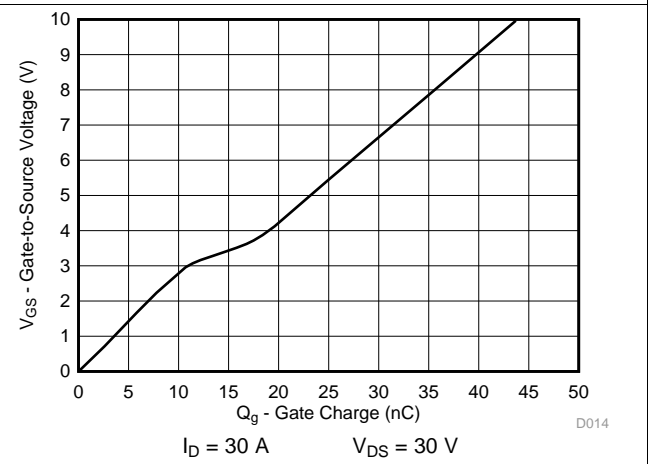

Figure 10. MOSFET Gate Charge

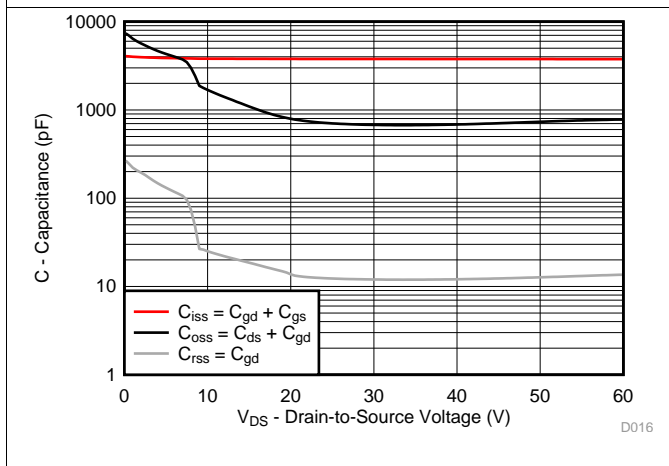

Figure 11. MOSFET Capacitance

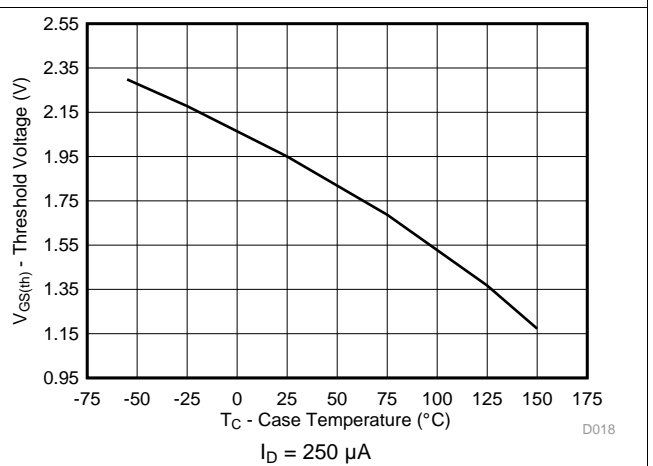
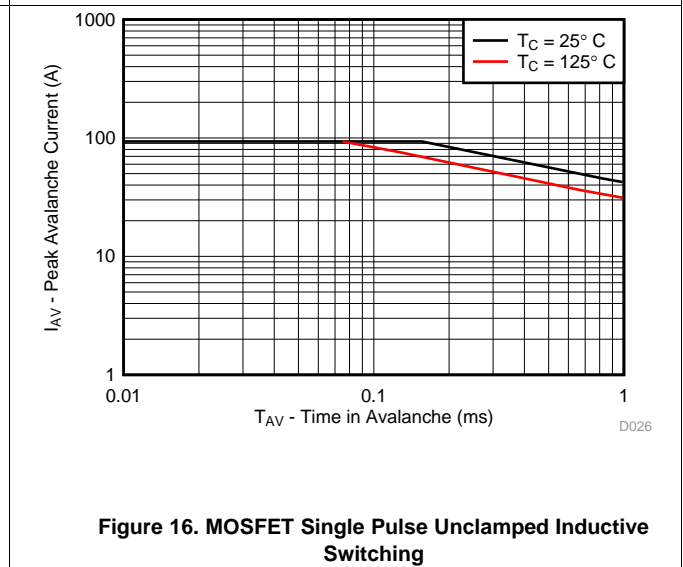
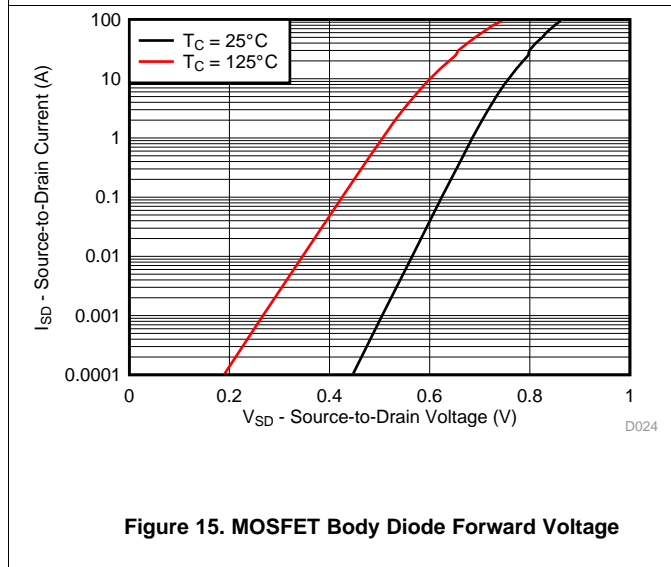
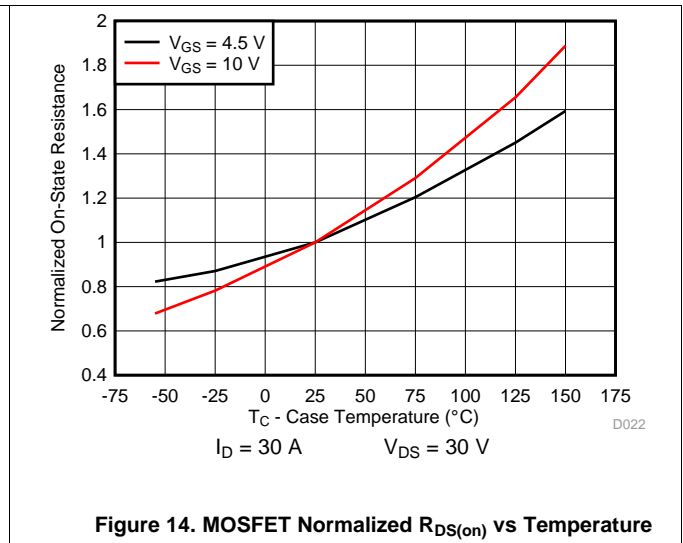
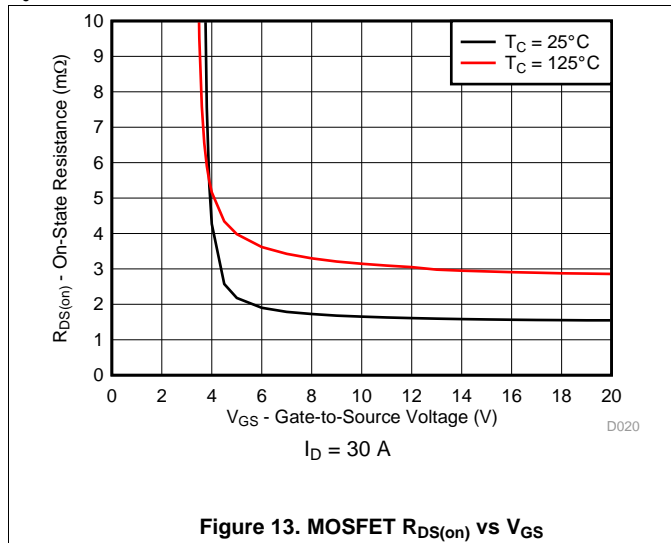

Figure 12. Threshold Voltage vs Temperature

Typical Power Block MOSFET Characteristics (continued)

$T_J = 25^\circ\text{C}$, unless stated otherwise.



6 Application and Implementation

NOTE

Information in the following Application section is not part of the TI component specification, and TI does not warrant its accuracy or completeness. TI customers are responsible for determining suitability of components selection for their designs. Customers should validate and test their design implementation to confirm system functionality.

6.1 Application Information

Historically, battery powered tools have favored brushed DC configurations to spin their primary motors, but more recently, the advantages offered by brushless DC operation (BLDC) operation have brought about the advent of popular designs that favor the latter. Those advantages include, but are not limited to higher efficiency and therefore longer battery life, superior reliability, greater peak torque capability, and smooth operation over a wider range of speeds. However, BLDC designs put increased demand for higher power density and current handling capabilities on the power stage responsible for driving the motor.

The CSD88599Q5DC is part of TI's power block product family and is a highly optimized product designed explicitly for the purpose driving higher current DC motors in power and gardening tools. It incorporates TI's latest generation silicon which has been optimized for low resistance to minimize conduction losses and offer excellent thermal performance. The power block utilizes TI's stacked die technology to offer one complete half bridge vertically integrated into a single 5-mm x 6-mm package with a DualCool exposed metal case. This feature allows the designer to apply a heatsink to the top of the package and pull heat away from the PCB, thus maximizing the power density while reducing the power stage footprint by up to 50%.

6.2 Brushless DC Motor With Trapezoidal Control

The trapezoidal commutation control is simple and has fewer switching losses compared to sinusoidal control.

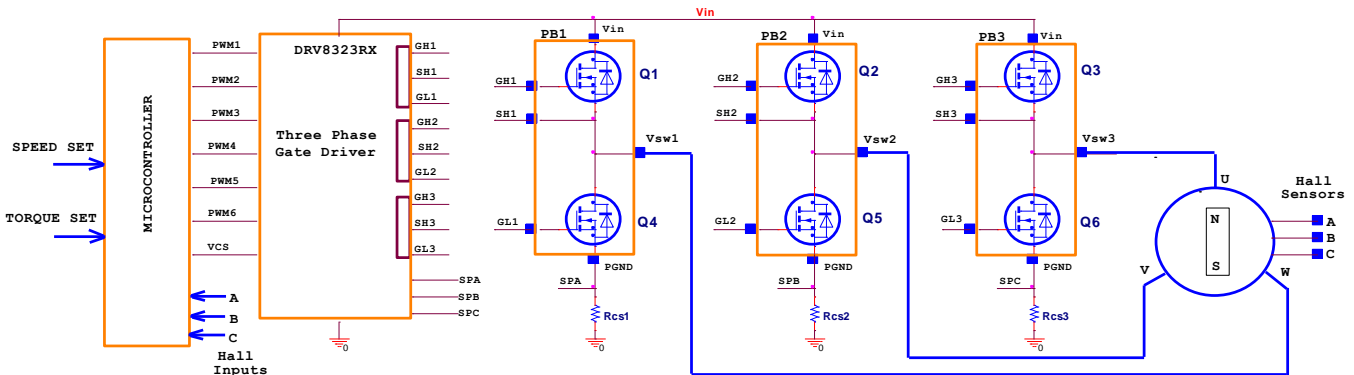

Copyright © 2017, Texas Instruments Incorporated

Figure 17. Functional Block Diagram

The block diagram shown in [Figure 17](#) offers a simple instruction of what is required to drive a BLDC motor: one microcontroller, one three-phase driver IC, three power blocks (historically six power MOSFETs) and three Hall effect sensors. The microcontroller responsible for block commutation must always know the rotor orientation or its position relative to the stator coils. This is easily achieved with a brushed DC motor due to the fixed geometry and position of the rotor windings, shaft and commutator.

A three-phase BLDC motor requires three Hall effect sensors or a rotary encoder to detect the rotor position in relation to stator armature windings. With input from these three Hall effect sensors' output signals, the microcontroller can determine the proper commutation sequence. The three Hall sensors named A, B, and C are mounted on the stator core at 120° intervals and the stator phase windings are implemented in a star configuration. For every 60° of motor rotation, one Hall sensor changes its state. Based on the Hall sensors' output code, at the end of each block commutation interval the ampere conductors are commutated to the next position. There are 6 steps required to complete a full electrical cycle. The number of block commutation cycles to complete a full mechanical rotation is determined by the number of rotor pole pairs.

Brushless DC Motor With Trapezoidal Control (continued)

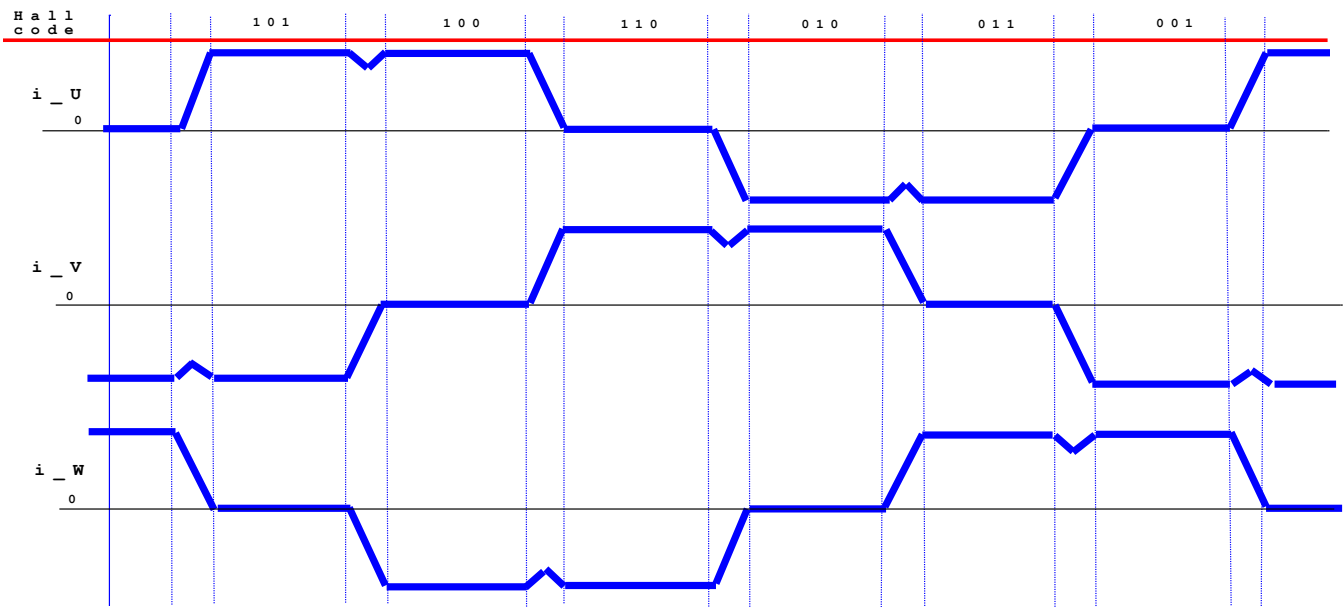

Figure 18. Winding Current Waveforms on a BLDC Motor

Figure 18 above shows the three phase motor winding currents i_U , i_V , and i_W when running at 100% duty cycle.

Trapezoidal commutation control offers the following advantages:

- Only two windings in series carry the phase winding current at any time while the third winding is open.
- Only one current sensor is necessary for all three windings U, V, and W.
- The position of the current sensor allows the use of low-cost shunt resistors.

However, trapezoidal commutation control has the disadvantage of commutation torque ripple. The current sense on a three-phase inverter can be configured to use a single-shunt or three different sense resistors. For cost sensitive applications targeting sensorless control, the three Hall effect sensors can be replaced with BEMF voltage feedback dividers.

To obtain faster motor rotations and higher revolutions per minute (RPM), shorter periods and higher V_{IN} voltage are necessary. Contrarily, to reduce the rotational speed of the motor, it is necessary to lower the RMS voltage applied across stator windings. This can easily be achieved by modulating the duty cycle, while maintain a constant switching frequency. Frequency for the three-phase inverter chosen is usually low between 10 kHz to 50 kHz to reduce winding losses and to avoid audible noise.

6.3 Power Loss Curves

CSD88599Q5DC was designed to operate up to 10-cell Li-Ion battery voltage applications ranging from 30 V to 42 V, typical 36 V. For 11 and 12s, input voltages between 42 V to 54 V, RC snubbers are required for each switch-node U, V, and W. To reduce ringing, refer to the [Electrical Performance](#) section. In an effort to simplify the design process, Texas Instruments has provided measured power loss performance curves over a variety of typical conditions.

Figure 1 plots the CSD88599Q5DC power loss as a function of load current. The measured power loss includes both input conversion loss and gate drive loss.

Equation 1 is used to generate the power loss curve:

$$\text{Power loss (W)} = (V_{IN} \times I_{IN_SHUNT}) + (V_{DD} \times I_{DD_SHUNT}) - (V_{SW_AVG} \times I_{OUT}) \tag{1}$$

The power loss measurements were made on the circuit shown in Figure 19. Power block devices for legs U and V, PB1 and PB2 were disabled by shorting the CSD88599Q5DC high-side and low-side FETs' gate-to-source terminals. Current shunt I_{in_SHUNT} provides input current and I_{dd_SHUNT} provides driver supply current measurements. The winding current is measured from the DC load. An averaging circuit provides switch node W equivalent RMS voltage.

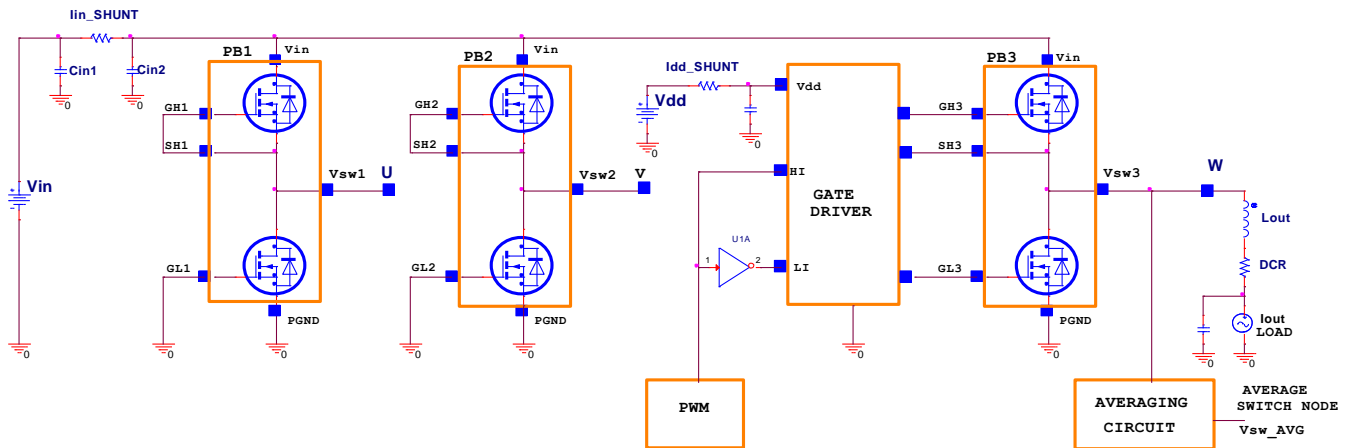

Copyright © 2017, Texas Instruments Incorporated

Figure 19. Power Loss Test Circuit

The RMS current on the CSD88599Q5DC device depends on the motor winding current. For trapezoidal control, the MOSFET RMS current is calculated using Equation 2.

$$I_{RMS} = I_{OUT} \times \sqrt{2} \tag{2}$$

Taking into consideration system tolerances with the current measurement scheme, the inverter design needs to withstand a 20% overload current.

Table 1. RMS and Overload Current Calculations

Winding RMS Current (A)	CSD88599Q5DC I_{RMS} (A)	Overload 20% $\times I_{RMS}$ (A)
20	28	34
30	42	51
40	56	68

6.4 Safe Operating Area (SOA) Curve

The SOA curve in [Figure 3](#) provides guidance on the temperature boundaries within an operating system by incorporating the thermal resistance and system power loss. This curve outlines the board and case temperatures required for a given load current. The area under the curve dictates the safe operating area. This curve is based on measurements made on a PCB design with dimensions of 4 in (W) × 3.5 in (L) × 0.062 in (H) and 6 copper layers of 2-oz copper thickness.

6.5 Normalized Power Loss Curves

The normalized curves in the CSD88599Q5DC data sheet provide guidance on the power loss and SOA adjustments based on application specific needs. These curves show how the power loss and SOA temperature boundaries will adjust for different operation conditions. The primary Y-axis is the normalized change in power loss while the secondary Y-axis is the change in system temperature required in order to comply with the SOA curve. The change in power loss is a multiplier for the typical power loss. The change in SOA temperature is subtracted from the SOA curve.

6.6 Design Example – Regulate Current to Maintain Safe Operation

If the case and board temperature of the power block are known, the SOA can be used to determine the maximum allowed current that will maintain operation within the safe operating area of the device. The following procedure outlines how to determine the RMS current limit while maintaining operation within the confines of the SOA, assuming the temperatures of the top of the package and PCB directly underneath the part are known.

1. Start at the maximum current of the device on the Y-axis and draw a line from this point at the known top case temperature to the known PCB temperature.
2. Observe where this point intersects the T_x line.
3. At this intersection with the T_x line, draw vertical line until you hit the SOA current limit. This intercept is the maximum allowed current at the corresponding power block PCB and case temperatures.

In the example below, we show how to achieve this for the temperatures $T_C = 124^\circ\text{C}$ and $T_B = 120^\circ\text{C}$. First we draw from 40 A on the Y-axis at 124°C to 120°C on the X-axis. Then, we draw a line up from where this line crosses the T_x line to see that this line intercepts the SOA at 34 A. Thus we can assume if we are measuring a PCB temperature of 124°C , and a top case temperature of 120°C , the power block can handle 34-A RMS, at the normalized conditions. At conditions that differ from those in [Figure 1](#), the user may be required to make an SOA temperature adjustment on the T_x line, as shown in the next section.

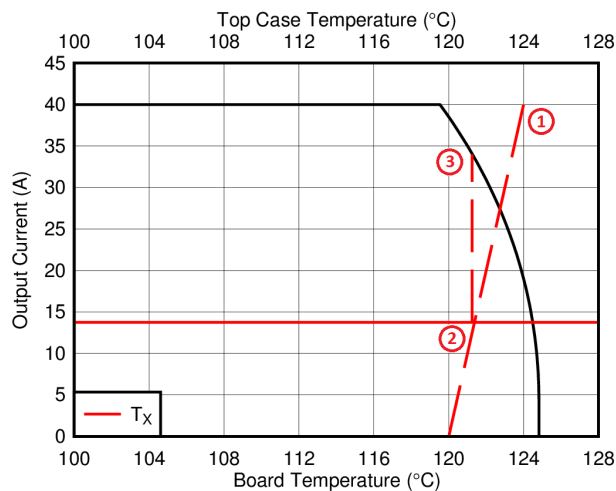

Figure 20. Regulating Current to Maintain Safe Operation

6.7 Design Example – Regulate Board and Case Temperature to Maintain Safe Operation

In the previous example we showed how given the PCB and case temperature, the current of the power block could be limited to ensure operation within the SOA. Conversely, if the current and other application conditions are known, one can determine from the SOA what board or case temperature the user will need to limit their design to. The user can estimate product loss and SOA boundaries by arithmetic means (see [Operating Conditions](#) section). Though the power loss and SOA curves in this data sheet are taken for a specific set of test conditions, the following procedure outlines the steps the user should take to predict product performance for any set of system conditions.

6.7.1 Operating Conditions

- Winding output current (I_{OUT}) = 30 A
- Input voltage (V_{IN}) = 42 V
- Switching frequency (F_{SW}) = 40 kHz
- Duty cycle (D.C.) = 95%

6.7.2 Calculating Power Loss

- Power loss at 30 A \approx 3.4 W ([Figure 1](#))
- Normalized power loss for switching frequency \approx 1.19 ([Figure 4](#))
- Normalized power loss for input voltage \approx 1.03 ([Figure 5](#))
- Normalized power loss for duty cycle \approx 1.12 ([Figure 6](#))
- **Final calculated power loss = 3.4 W \times 1.19 \times 1.03 \times 1.12 \approx 4.7 W**

6.7.3 Calculating SOA Adjustments

- SOA adjustment for switching frequency \approx 1.3°C ([Figure 4](#))
- SOA adjustment for input voltage \approx 0.1°C ([Figure 5](#))
- SOA adjustment for duty cycle \approx 0.7°C ([Figure 6](#))
- **Final calculated SOA adjustment = 1.3 + 0.1 + 0.7 \approx 2.1°C**

In the [Design Example – Regulate Current to Maintain Safe Operation](#) section above, the estimated power loss of the CSD88599Q5DC would increase to 4.7 W. In addition, the maximum allowable board temperature would have to increase by 2.1°C. In [Figure 21](#), the SOA graph was adjusted accordingly.

1. Start by drawing a horizontal line from the application current (30 A) to the SOA curve.
2. Draw a vertical line from the SOA curve intercept down to the T_X line.
3. Adjust the intersection point by subtracting the temperature adjustment value.

In this design example, the SOA board/ambient temperature adjustment yields a decrease of allowed junction temperature of 2.1°C from 122.2°C to 120.1°C. Now it is known that the intersection of the case and PCB temperatures on the T_X line must stay below this point. For instance, if the power block case is observed operating at 124°C, the PCB temperature must in turn be kept under 118°C to maintain this crossover point.

Design Example – Regulate Board and Case Temperature to Maintain Safe Operation (continued)

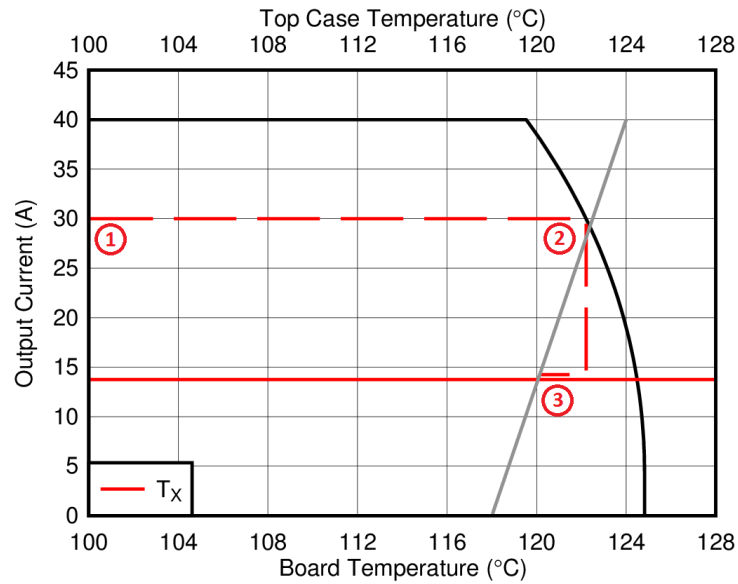

Figure 21. Regulate Temperature to Maintain Safe Operation

7 Layout

The two key system-level parameters that can be optimized with proper PCB design are electrical and thermal performance. A proper PCB layout will yield maximum performance in both areas. Below are some tips for how to address each.

7.1 Layout Guidelines

7.1.1 Electrical Performance

The CSD88599Q5DC power block has the ability to switch at voltage rates greater than 1 kV/ μ s. Special care must be then taken with the PCB layout design and placement of the input capacitors; high-current, high di/dT switching path; current shunt resistors; and GND return planes. As with any high-power inverter operated in hard switching mode, there will be voltage ringing present on the switch nodes U, V, and W. Switch-node ringing appears mainly at the HS FET turn-on commutation with positive winding current direction. The U, V, and W phase connections to the BLDC motor can be usually excluded from the ringing behavior since they are subjected to high-peak currents but low di/dT slew-rates. However, a compact PCB design with short and low-parasitic loop inductances is critical to achieve low ringing and compliance with EMI specifications.

For safe and reliable operation of the three-phase inverter, motor phase currents have to be accurately monitored and reported to the system microcontroller. One current sensor needs to be connected on each motor phase winding U, V, and W. This sensing method is best for current sensing as it provides good accuracy over a wide range of duty cycles, motor torque, and winding currents. Using current sensors is recommended because it is less intrusive to the V_{IN} and GND connections.

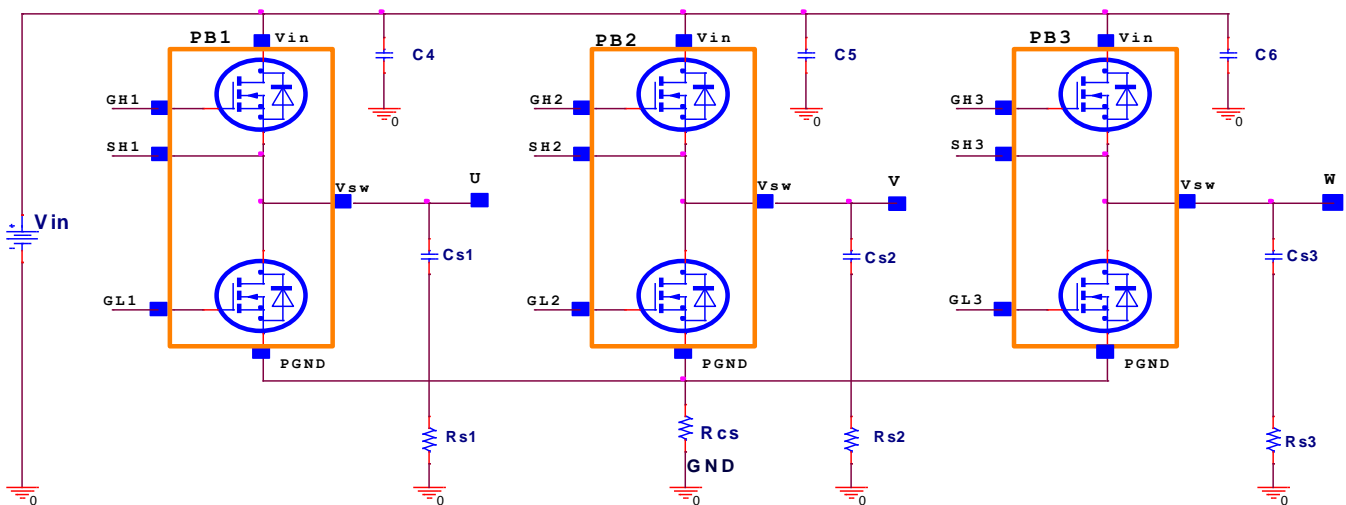

Copyright © 2017, Texas Instruments Incorporated

Figure 22. Recommended Ringing Reduction Components

However, for cost sensitive applications, current sensors are generally replaced with current sense resistors.

- For designs using the 60-V three-phase smart gate driver DRV8320SRHBR, only one current sense resistor R_{CS} can be placed between common source terminals for all three power block devices CSD88599Q5DC to PGND as depicted in Figure 22 above.
- For designs using the 60-V three-phase gate driver DRV8323RSRGZT, three current sense resistors R_{CS1} , R_{CS2} , and R_{CS3} can be used between each CSD88599Q5DC source terminals to GND. The three-phase driver IC should be placed as close as possible to the power block gate GL and GH terminals.

Layout Guidelines (continued)

Breaking the high-current flow path from the source terminals of the power block to GND by introducing the R_{CS} current shunt resistors introduces parasitic PCB inductance. In the event the switch node waveforms exhibits peak ringing that reaches undesirable levels, the ringing can be reduced by using the following ringing reduction components:

- The use of a high-side gate resistor in series with the GH pin is one effective way to reduce peak ringing. The recommended HS FET gate resistor value will range between $4.7\ \Omega$ to $10\ \Omega$ depending on the driver IC output characteristics used in conjunction with the power block device. The low-side FET gate pin GL should connect directly to the driver IC output to avoid any parasitic cdV/dT turnon effect.
- Low-inductance MLCC caps C4, C5, and C6 can be used across each power block device from V_{IN} to the source terminal P_{GND} . MLCC 10 nF, 100 V, $\pm 10\%$, X7S, 0402, PN: C1005X7S2A103K050BB are recommended.
- Ringing can be reduced via the implementation of RC snubbers from each switch node U, V, and W to GND. Recommended snubber component values are as follows:
 - Snubber resistors Rs1, Rs2, Rs3: $2.21\ \Omega$, 1%, 0.125 W, 0805, PN: CRCW08052R21FKEA
 - Snubber caps Cs1, Cs2, and Cs3: MLCC 4.7 nF, 100 V, X7S, 0402, PN: C1005X7S2A472M050BB

With a switching frequency of 20 kHz on the three-phase inverter, the power dissipation on the RC snubber resistor is 80 mW per channel. As a result, 0805 package size for resistors Rs1, Rs2, and Rs3 is sufficient.

7.1.2 Thermal Considerations

The CSD88599Q5DC power block device has the ability to utilize the PCB copper planes as the primary thermal path. As such, the use of thermal vias included in the footprint is an effective way to pull away heat from the device and into the system board. Concerns regarding solder voids and manufacturability issues can be addressed through the use of three basic tactics to minimize the amount of solder attach that will wick down the via barrel.

- Intentionally space out the vias from one another to avoid a cluster of holes in a given area.
- Use the smallest drill size allowed by the design. The example in [Figure 23](#) uses vias with a 10-mil drill hole and a 16-mil solder pad.
- Tent the opposite side of the via with solder-mask. Ultimately the number and drill size of the thermal vias should align with the end user's PCB design rules and manufacturing capabilities.

To take advantage of the DualCool thermally enhanced package, an external heatsink can be applied on top of the power block devices. For low EMI, the heatsink is usually connected to GND through the mounting screws to the PCB. Gap pad insulators with good thermal conductivity should be used between the top of the package and the heatsink. The Bergquist Sil-Pad 980 is recommended which provides excellent thermal impedance of 1.07°C/W @ 50 psi.

7.2 Layout Example

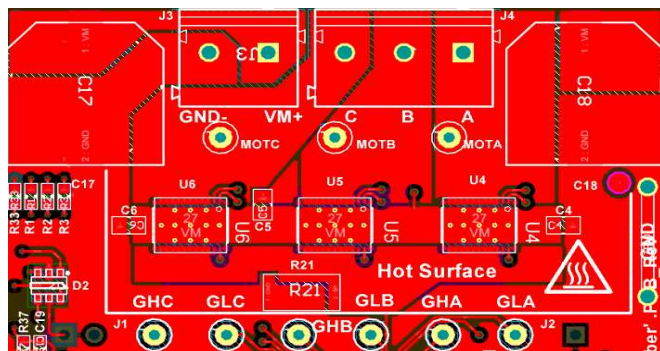

Figure 23. Top Layer

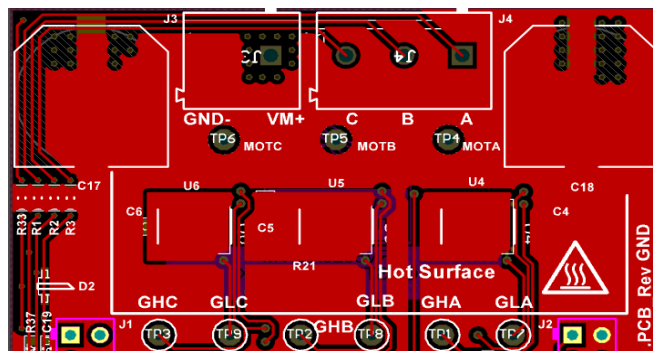

Figure 24. Bottom Layer

The placement of the input capacitors C4, C5, and C6 relative to V_{IN} and P_{GND} pins of CSD88599Q5DC device should have the highest priority during the component placement routine. It is critical to minimize the V_{IN} to GND parasitic loop inductance. A shunt resistor R21 is used between all three U4, U5, and U6 power block source terminals to the input supply GND return pin.

Input RMS current filtering is achieved via two bulk caps C17 and C18. Based on the RMS current ratings, the recommended part number for input bulk is CAP AL, 330 μF , 63 V, $\pm 20\%$, PN: EMVA630ADA331MKG5S.

8 器件和文档支持

8.1 接收文档更新通知

要接收文档更新通知，请导航至 TI.com.cn 上的器件产品文件夹。单击右上角的 [通知我](#) 进行注册，即可每周接收产品信息更改摘要。有关更改的详细信息，请查看任何已修订文档中包含的修订历史记录。

8.2 社区资源

下列链接提供到 TI 社区资源的连接。链接的内容由各个分销商“按照原样”提供。这些内容并不构成 TI 技术规范，并且不一定反映 TI 的观点；请参阅 TI 的 [《使用条款》](#)。

TI E2E™ 在线社区 [TI 的工程师对工程师 \(E2E\) 社区](#)。此社区的创建目的在于促进工程师之间的协作。在 e2e.ti.com 中，您可以咨询问题、分享知识、拓展思路并与同行工程师一道帮助解决问题。

设计支持 [TI 参考设计支持](#) 可帮助您快速查找有帮助的 E2E 论坛、设计支持工具以及技术支持的联系信息。

8.3 商标

NexFET, DualCool, E2E are trademarks of Texas Instruments.
All other trademarks are the property of their respective owners.

8.4 静电放电警告



这些装置包含有限的内置 ESD 保护。存储或装卸时，应将导线一起截短或将装置放置于导电泡棉中，以防止 MOS 门极遭受静电损伤。

8.5 Glossary

[SLYZ022](#) — *TI Glossary*.

This glossary lists and explains terms, acronyms, and definitions.

9 机械、封装和可订购信息

以下页面包含机械、封装和可订购信息。这些信息是指定器件的最新可用数据。数据如有变更，恕不另行通知，且不会对此文档进行修订。如欲获取此数据表的浏览器版本，请参阅左侧的导航。

9.1 Q5DC 封装尺寸

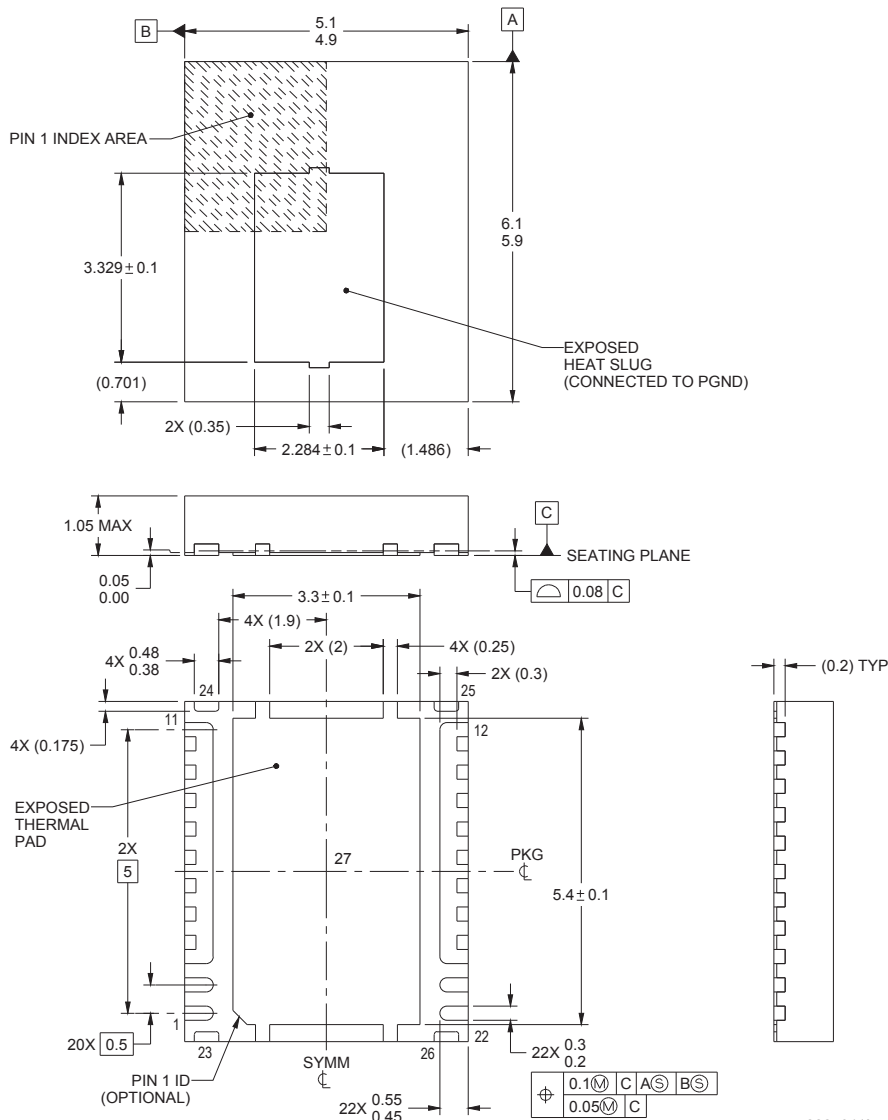

4222731/A 02/2016

- 所有线性尺寸的单位均为毫米。括号中的任何尺寸仅供参考。尺寸和公差值符合 ASME Y14.5M 标准。
- 本图如有变更，恕不另行通知。
- 必须在印刷电路板上焊接封装散热焊盘，以获得良好的散热和机械性能。

表 2. 引脚配置表

位置	引脚名称	说明
1	GH	高侧栅极
2	SH	高侧栅极回路
3-11	V _{SW}	开关节点
12-20	P _{GND}	电源接地
21	NC	无连接
22	GL	低侧栅极
23-26	NC	无连接
27	输入电压	输入电压间

9.2 焊盘图案建议

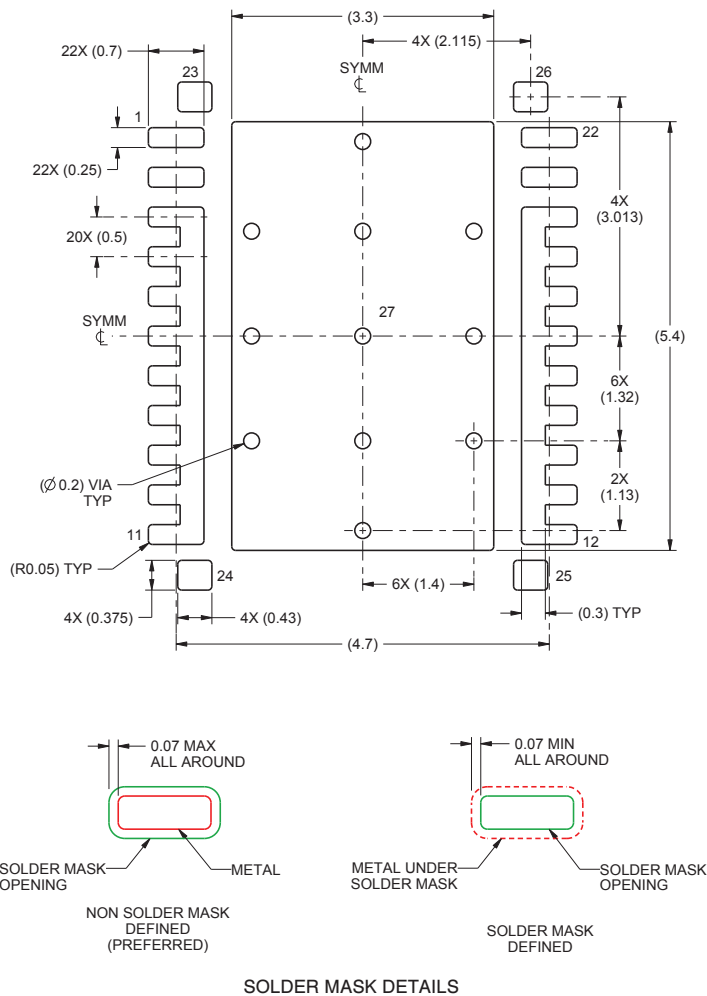

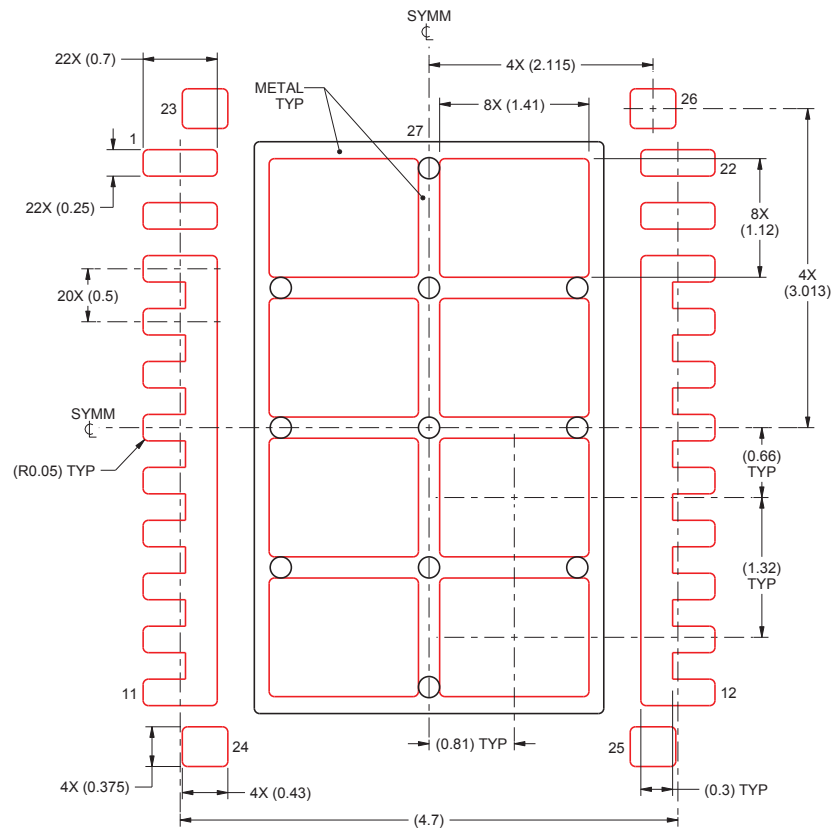

- 所有线性尺寸的单位均为毫米。括号中的任何尺寸仅供参考。尺寸和公差值符合 ASME Y14.5M 标准。
- 此封装设计用于焊接到电路板的散热焊盘上。有关更多信息，请参阅《QFN/SON PCB 连接》(SLUA271)。
- 根据应用决定是否选用过孔，详情请参见器件数据表。如果实现了部分或全部过孔，则会显示建议的过孔位置。

9.3 模版建议



- 所有线性尺寸的单位均为毫米。括号中的任何尺寸仅供参考。尺寸和公差值符合 ASME Y14.5M 标准。
 - 具有漏斗形壁和圆角的激光切割孔可提供更佳的锡膏脱离。IPC-7525 可能提供替代设计建议。
- 如需了解针对 PCB 设计的建议电路布局，请参阅《[通过 PCB 布局技巧来减少振铃](#)》(SLPA005)。

PACKAGING INFORMATION

Orderable Device	Status (1)	Package Type	Package Drawing	Pins	Package Qty	Eco Plan (2)	Lead finish/ Ball material (6)	MSL Peak Temp (3)	Op Temp (°C)	Device Marking (4/5)	Samples
CSD88599Q5DC	ACTIVE	VSON-CLIP	DMM	22	2500	RoHS-Exempt & Green	SN	Level-1-260C-UNLIM	-55 to 150	88599	
CSD88599Q5DCT	ACTIVE	VSON-CLIP	DMM	22	250	RoHS-Exempt & Green	SN	Level-1-260C-UNLIM	-55 to 150	88599	

(1) The marketing status values are defined as follows:

ACTIVE: Product device recommended for new designs.

LIFEBUY: TI has announced that the device will be discontinued, and a lifetime-buy period is in effect.

NRND: Not recommended for new designs. Device is in production to support existing customers, but TI does not recommend using this part in a new design.

PREVIEW: Device has been announced but is not in production. Samples may or may not be available.

OBSOLETE: TI has discontinued the production of the device.

(2) **RoHS:** TI defines "RoHS" to mean semiconductor products that are compliant with the current EU RoHS requirements for all 10 RoHS substances, including the requirement that RoHS substance do not exceed 0.1% by weight in homogeneous materials. Where designed to be soldered at high temperatures, "RoHS" products are suitable for use in specified lead-free processes. TI may reference these types of products as "Pb-Free".

RoHS Exempt: TI defines "RoHS Exempt" to mean products that contain lead but are compliant with EU RoHS pursuant to a specific EU RoHS exemption.

Green: TI defines "Green" to mean the content of Chlorine (Cl) and Bromine (Br) based flame retardants meet JS709B low halogen requirements of <=1000ppm threshold. Antimony trioxide based flame retardants must also meet the <=1000ppm threshold requirement.

(3) MSL, Peak Temp. - The Moisture Sensitivity Level rating according to the JEDEC industry standard classifications, and peak solder temperature.

(4) There may be additional marking, which relates to the logo, the lot trace code information, or the environmental category on the device.

(5) Multiple Device Markings will be inside parentheses. Only one Device Marking contained in parentheses and separated by a "~" will appear on a device. If a line is indented then it is a continuation of the previous line and the two combined represent the entire Device Marking for that device.

(6) Lead finish/Ball material - Orderable Devices may have multiple material finish options. Finish options are separated by a vertical ruled line. Lead finish/Ball material values may wrap to two lines if the finish value exceeds the maximum column width.

Important Information and Disclaimer:The information provided on this page represents TI's knowledge and belief as of the date that it is provided. TI bases its knowledge and belief on information provided by third parties, and makes no representation or warranty as to the accuracy of such information. Efforts are underway to better integrate information from third parties. TI has taken and continues to take reasonable steps to provide representative and accurate information but may not have conducted destructive testing or chemical analysis on incoming materials and chemicals. TI and TI suppliers consider certain information to be proprietary, and thus CAS numbers and other limited information may not be available for release.

In no event shall TI's liability arising out of such information exceed the total purchase price of the TI part(s) at issue in this document sold by TI to Customer on an annual basis.

重要声明和免责声明

TI 均以“原样”提供技术性及其可靠性数据（包括数据表）、设计资源（包括参考设计）、应用或其他设计建议、网络工具、安全信息和其他资源，不保证其中不含任何瑕疵，且不做任何明示或暗示的担保，包括但不限于对适销性、适合某特定用途或不侵犯任何第三方知识产权的暗示担保。

所述资源可供专业开发人员应用TI 产品进行设计使用。您将对以下行为独自承担全部责任：(1) 针对您的应用选择合适的TI 产品；(2) 设计、验证并测试您的应用；(3) 确保您的应用满足相应标准以及任何其他安全、安保或其他要求。所述资源如有变更，恕不另行通知。TI 对您使用所述资源的授权仅限于开发资源所涉及TI 产品的相关应用。除此之外不得复制或展示所述资源，也不提供其它TI 或任何第三方的知识产权授权许可。如因使用所述资源而产生任何索赔、赔偿、成本、损失及债务等，TI 对此概不负责，并且您须赔偿由此对TI 及其代表造成的损害。

TI 所提供产品均受TI 的销售条款 (<http://www.ti.com.cn/zh-cn/legal/termsofsale.html>) 以及ti.com.cn上或随附TI产品提供的其他可适用条款的约束。TI提供所述资源并不扩展或以其他方式更改TI 针对TI 产品所发布的可适用的担保范围或担保免责声明。

邮寄地址：上海市浦东新区世纪大道 1568 号中建大厦 32 楼，邮政编码：200122

Copyright © 2020 德州仪器半导体技术（上海）有限公司