

LM3555 Synchronous Boost Converter With 500-mA High-Side LED Driver and Dual-Mode Control Interface

1 Features

- High-Voltage High-Side Current Source Allows for Grounded Cathode LED Operation
- Synchronous Boost Converter
- Peak Converter Efficiency > 90%
- Accurate and Programmable LED Current Ranging From 60 mA to 500 mA
- Adaptive LED Current Range Based on LED Configuration
- Dedicated Indicator Current Source
- Dedicated Torch and Strobe Pins
- Dual Mode Control (General Purpose or I²C)
- Broken Inductor Detection
- Output Overvoltage Protection
- Output and LED Short-Circuit Protection
- 400-kHz I²C-Compatible Interface

2 Applications

Camera Phone LED Flash

3 Description

The LM3555 is a 2-MHz fixed-frequency, current-mode synchronous boost converter designed to drive either a single flash LED at 500 mA or two series flash LEDs at 400 mA. A high-voltage current source allows the LEDs to be terminated to the GND plane eliminating the need for an additional return trace back to the device.

A dual-mode control interface allows the user to configure the LM3555 with a general-purpose interface using two enable pins for control or an I²C allowing a higher level of control. Both interfaces allow access to the indicator, assist light, and flash modes. A dedicated STROBE pin provides a direct interface to trigger the flash event, while an external TORCH pin provides an additional method for enabling the LEDs in a constant current mode.

The LM3555 can adaptively scale the maximum flash level delivered to the LEDs based upon the flash configuration, whether it be a single LED or two LEDs in series.

Eight protection features are available on the LM3555 ranging from overvoltage protection to broken inductor detection. The LM3555 has four selectable inductor current limits to help the user select an inductor that is appropriate for the design.

Device Information⁽¹⁾

PART NUMBER	PACKAGE	BODY SIZE (MAX)
LM3555	DSBGA (12)	2.09 mm x 1.565 mm

(1) For all available packages, see the orderable addendum at the end of the data sheet.

Typical Application

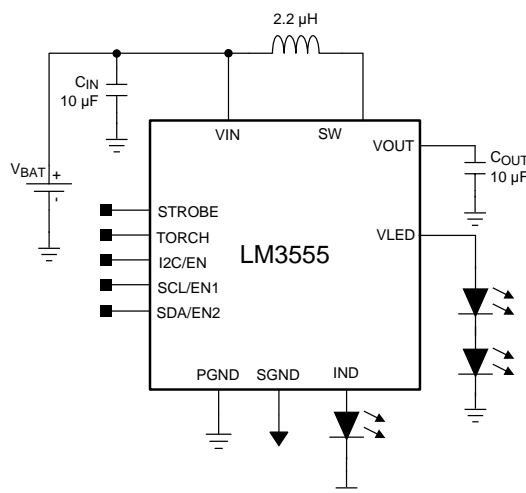

Copyright © 2016, Texas Instruments Incorporated



Table of Contents

1 Features 1 2 Applications 1 3 Description 1 4 Revision History 2 5 Pin Configuration and Functions 3 6 Specifications 4 6.1 Absolute Maximum Ratings 4 6.2 ESD Ratings 4 6.3 Recommended Operating Conditions 4 6.4 Thermal Information 5 6.5 Electrical Characteristics 5 6.6 Control Interface Timing Requirements 7 6.7 Typical Characteristics 8 7 Detailed Description 15 7.1 Overview 15 7.2 Functional Block Diagram 15 7.3 Feature Description 16 7.4 Device Functional Modes 19	7.5 Programming 22 7.6 Register Maps 24 8 Application and Implementation 27 8.1 Application Information 27 8.2 Typical Application 27 9 Power Supply Recommendations 30 10 Layout 31 10.1 Layout Guidelines 31 10.2 Layout Example 31 11 Device and Documentation Support 32 11.1 Device Support 32 11.2 Documentation Support 32 11.3 Community Resources 32 11.4 Trademarks 32 11.5 Electrostatic Discharge Caution 32 11.6 Glossary 32 12 Mechanical, Packaging, and Orderable Information 32
--	---

4 Revision History

NOTE: Page numbers for previous revisions may differ from page numbers in the current version.

Changes from Revision F (November 2013) to Revision G	Page
<ul style="list-style-type: none"> • Added <i>Device Information</i> and <i>Pin Configuration and Functions</i> sections, <i>ESD Ratings Thermal Information</i> tables, <i>Feature Description</i>, <i>Device Functional Modes</i>, <i>Application and Implementation</i>, <i>Power Supply Recommendations</i>, <i>Layout</i>, <i>Device and Documentation Support</i>, and <i>Mechanical, Packaging, and Orderable Information</i> sections 1 • Changed $R_{\theta JA}$ value; add rest of <i>Thermal Information</i> 5 	

Changes from Revision E (November 2011) to Revision F	Page
<ul style="list-style-type: none"> • Changed layout of National Data Sheet to TI format 31 	

5 Pin Configuration and Functions

**YZR Package
12-Pin DSBGA
Top View**

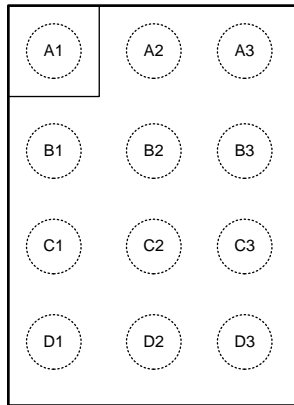

**YZR Package
12-Pin DSBGA
Bottom View**

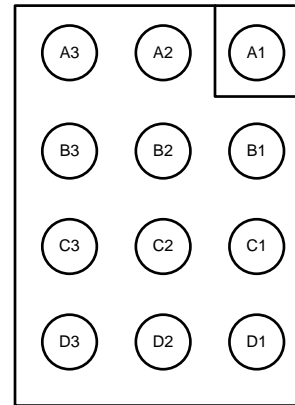

Pin Functions

PIN		I/O	DESCRIPTION
NUMBER	NAME		
A1	PGND	—	Power ground
A2	SGND	—	Signal ground
A3	VIN	I	Input voltage pin of the device. Connect input bypass capacitor very close to this pin.
B1	SW	—	Inductor connection
B2	TORCH	I	Torch pin. Driving this pin high enables torch mode.
B3	IND	O	Red indicator LED current source. Connect to RED LED anode
C1	VOUT	O	Boost output. Connect output bypass capacitor very close to this pin
C2	STROBE	I/O	Strobe signal input pin to synchronize flash pulse in I ² C mode. This signal usually comes from the camera processor. In simple logic mode this pin, when tied to a voltage rail through a pullup resistor indicates the number of LEDs in the system.
C3	I2C / EN	I	I2C / EN-logic selection. High = I ² C mode, Low = simple logic mode.
D1	VLED	O	LED current source. Connect to the anode of the flash LED. One or two LEDs can be connected in series.
D2	SDA / EN2	I/O	EN2 signal pin in simple logic mode. I ² C data signal in I ² C mode.
D3	SCL / EN1	I	EN1 signal pin in simple logic mode. I ² C clock signal in I ² C mode.

6 Specifications

6.1 Absolute Maximum Ratings

over operating free-air temperature range (unless otherwise noted)⁽¹⁾⁽²⁾⁽³⁾

	MIN	MAX	UNIT
V _{IN}	-0.3	6	V
TORCH, IND, STROBE, I ² C/EN, SDA/EN2, SCL/EN1	-0.3	(V _{IN} + 0.3 V) w/ 6 V maximum	V
SW		12	V
V _{OUT} , V _{LED}		10	V
Continuous power dissipation ⁽⁴⁾	Internally limited		
Junction temperature, T _{J-MAX}		150	°C
Maximum lead temperature (soldering)	See ⁽⁵⁾		
Storage temperature, T _{stg}	-55	150	°C

- (1) Stresses beyond those listed under *Absolute Maximum Ratings* may cause permanent damage to the device. These are stress ratings only, which do not imply functional operation of the device at these or any other conditions beyond those indicated under *Recommended Operating Conditions*. Exposure to absolute-maximum-rated conditions for extended periods may affect device reliability.
- (2) All voltages are with respect to the potential at the GND pin.
- (3) If Military/Aerospace specified devices are required, contact the Texas Instruments Sales Office/ Distributors for availability and specifications.
- (4) Internal thermal shutdown circuitry protects the device from permanent damage. Thermal shutdown engages at T_J=150°C (typical) and disengages at T_J=135°C (typical). Thermal shutdown is specified by design.
- (5) For detailed soldering specifications and information, please refer to *AN-1112 DSBGA Wafer Level Chip Scale Package (SNVA009)*.

6.2 ESD Ratings

	VALUE	UNIT
V _(ESD) Electrostatic discharge Human-body model (HBM), per ANSI/ESDA/JEDEC JS-001 ⁽¹⁾	±2500	V

- (1) JEDEC document JEP155 states that 500-V HBM allows safe manufacturing with a standard ESD control process.

6.3 Recommended Operating Conditions

over operating free-air temperature range (unless otherwise noted)⁽¹⁾⁽²⁾

	MIN	MAX	UNIT
Input voltage	2.5	5.5	V
Junction temperature, T _J	-30	125	°C
Ambient temperature, T _A ⁽³⁾	-30	85	°C

- (1) *Absolute Maximum Ratings* indicate limits beyond which damage to the device may occur. *Recommended Operating Ratings* are conditions under which operation of the device is specified. Operating Ratings do not imply specified performance limits. For specified performance limits and associated test conditions, see the *Electrical Characteristics* tables.
- (2) All voltages are with respect to the potential at the GND pin.
- (3) In applications where high power dissipation and/or poor package thermal resistance is present, the maximum ambient temperature may have to be de-rated. Maximum ambient temperature (T_{A-MAX}) is dependent on the maximum operating junction temperature (T_{J-MAX-OP} = 125°C), the maximum power dissipation of the device in the application (P_{D-MAX}), and the junction-to-ambient thermal resistance of the part/package in the application (R_{θJA}), as given by the following equation: T_{A-MAX} = T_{J-MAX-OP} - (R_{θJA} × P_{D-MAX}).

6.4 Thermal Information

THERMAL METRIC ⁽¹⁾		LM3555	
		YZR (DSBGA)	UNIT
		12 PINS	
R _{θJA}	Junction-to-ambient thermal resistance	92.9	°C/W
R _{θJC(top)}	Junction-to-case (top) thermal resistance	0.6	°C/W
R _{θJB}	Junction-to-board thermal resistance	16.1	°C/W
ψ _{JT}	Junction-to-top characterization parameter	2.8	°C/W
ψ _{JB}	Junction-to-board characterization parameter	16.1	°C/W

(1) For more information about traditional and new thermal metrics, see the *Semiconductor and IC Package Thermal Metrics* application report, [SPRA953](#).

6.5 Electrical Characteristics

Unless otherwise specified: typical limits are for T_A = 25°C; minimum and maximum limits apply over the full operating ambient temperature range (–30°C ≤ T_A ≤ +85°C); V_{IN} = 3.6 V.⁽¹⁾⁽²⁾

PARAMETER		TEST CONDITIONS		MIN	TYP	MAX	UNIT
CURRENT AND VOLTAGE SPECIFICATIONS							
I _{LED-OUT}	Flash LED accuracy	2.7 V ≤ V _{IN} ≤ 5.5 V V _{OUT} = 6.5 V, V _{LED} = 6.2 V		50.7 (–15.5%)	60	67.2 (12%)	mA (%)
				69.8 (–12.8%)	80	86.4 (8%)	
				304 (–5%)	320	336 (5%)	
				475 (–5%)	500	535 (7%)	
I _{IND-OUT}	Indicator LED current accuracy	2.7 V ≤ V _{IN} ≤ 5.5 V, V _{IND} = 2 V (indicator mode)		–20.4%	2.5 mA	33.6%	
				–20.4%	5 mA	33.8%	
				–20.3%	7.5 mA	33.7%	
				–20.2%	10 mA	33.4%	
V _{CSSH}	Current source headroom voltage	2.7 V ≤ V _{IN} ≤ 5.5 V		300	350	mV	
V _{OVP}	Overvoltage Protection Range	2.7 V ≤ V _{IN} ≤ 5.5 V	Trip point (rising)	9.22	9.5	9.96	V
			Hysteresis		0.4		
V _{OUT}	Output voltage range	(V _{LED} × N _{LED}) + V _{CSSH}	Upper range		8.5		V
			Lower range		2.8		
I _{SD}	Shutdown current	2.7 V ≤ V _{IN} ≤ 5.5 V			0.75	μA	
I _{SB}	Standby current	2.7 V ≤ V _{IN} ≤ 5.5 V		1.1	4.3	μA	
I _Q	Operating quiescent current	2.7 V ≤ V _{IN} ≤ 5.5 V, device switching		3.5		mA	
V _{REF}	Reference Voltage for LED Detection	V _{IN} = 3.6 V (No Offset)		4.35		V	
V _{IND}	Indicator Fault Voltages	IND OVP		2.571		V	
		IND Short			0.842		
UVLO	Undervoltage lockout	Falling V _{IN}	2.35	2.4	2.43	V	
UVLO _{HYST}	UVLO hysteresis	Rising V _{IN}	60	70	85	mV	

(1) Minimum (MIN) and maximum (MAX) limits are specified by design, test, or statistical analysis. Typical (TYP) numbers are not specified, but do represent the most likely norm. Unless otherwise specified, conditions for typical specifications are: V_{IN} = 3.6 V and T_A = 25°C.

(2) Switching disabled.

Electrical Characteristics (continued)

Unless otherwise specified: typical limits are for $T_A = 25^\circ\text{C}$; minimum and maximum limits apply over the full operating ambient temperature range ($-30^\circ\text{C} \leq T_A \leq +85^\circ\text{C}$); $V_{IN} = 3.6\text{ V}$.⁽¹⁾⁽²⁾

PARAMETER	TEST CONDITIONS	MIN	TYP	MAX	UNIT	
I_{LIM} Peak current limit	$2.7\text{ V} \leq V_{IN} \leq 5.5\text{ V}$ ⁽³⁾	Current limit register value = 00	1.183	1.250	1.55	A
		Current limit register value = 01	1.417	1.500	1.781	
		Current limit register value = 10	1.512	1.750	2.025	
		Current limit register value = 11	1.805	2	2.267	
OSCILLATOR AND TIMING SPECIFICATIONS (NON-I²C INTERFACE TIMING)						
f_{SW} Switching frequency	$2.7\text{ V} \leq V_{IN} \leq 5.5\text{ V}$	1.91 (-4.5%)	2	2.15 (7.5%)	MHz	
t_{HW} Hardware flash timeout	Default timer		850		msec	
t_{RU} Current ramp-up time	$I_{LED} = 0\text{ mA}$ to $I_{LED} = \text{fullscale}$, $V_{OUT} = 6.5\text{ V}$, $V_{LED} = 6.2\text{ V}$	0.6		1	msec	
t_{RD} Current ramp down time	$I_{LED} = \text{fullscale}$ to $I_{LED} = 0\text{ mA}$ $V_{OUT} = 6.5\text{ V}$, $V_{LED} = 6.2\text{ V}$	0.2		0.5	msec	
$t_{TORCH-DG}$ Torch deglitching time		6.3	9	11.7	msec	
CONTROL INTERFACE VOLTAGE SPECIFICATIONS						
$V_{I2C/EN}$ I ² C/EN pin voltage threshold	$2.7\text{ V} \leq V_{IN} \leq 5.5\text{ V}$	Simple mode		0.54	V	
		I ² C mode	1.26			
V_{IL} Low-level threshold voltage (SCL/EN1 and SDA/EN2)	$2.7\text{ V} \leq V_{IN} \leq 5.5\text{ V}$			0.54	V	
V_{IH} High-level threshold voltage (SCL/EN1 and SDA/EN2)	$2.7\text{ V} \leq V_{IN} \leq 5.5\text{ V}$	1.26			V	
V_{OL} Low-level output threshold limit (SDA/EN2)	$I_{LOAD} = 3\text{ mA}$			0.4	V	

(3) T_A (minimum) = 0°C to account for self-heating. Current Limit specification uses V_{IN} (maximum) = 4 V to account for the input voltage range where current limit could be reached based upon the maximum application specifications for output voltage and diode current. Operation above 4 V and up to 5.5 V is allowed and must not reach current limit.

6.6 Control Interface Timing Requirements

		MIN	NOM	MAX	UNIT
$T_{I2C-Start}$	I ² C logic start-up time (I ² C/EN going high)		250	500	μsec
f_{SCL}	SCL clock frequency			400	kHz
t_{I2C}	I ² C hang-up time		35		msec
t_{LOW}	Low Period of SCL clock	1.3			μsec
t_{HIGH}	High Period of SCL clock	0.6			μsec
t_{HD-STA}	Hold Time (repeated) START condition	0.6			μsec
t_{SU-STA}	Setup time for a repeated START condition	0.6			μsec
t_{HD-DAT}	Data hold time	0			μsec
t_{SU-DAT}	Data setup time	100			nsec
t_R	Rise time for SCL and SDA			300	nsec
t_F	Fall time for SCL and SDA			300	nsec
t_{SU-STO}	Setup time for stop condition	0.6			μsec
t_{BUF}	Bus free time between stop and start condition	1.3			μsec
t_{VD-DAT}	Data valid time			0.9	μsec
t_{VD-ACK}	Data valid acknowledge time			0.9	μsec
C_B	Capacitive load for each bus line		$20 + 0.1 \times C_B$	400	pF

6.7 Typical Characteristics

Unless otherwise specified: $T_A = 25^\circ\text{C}$; $V_{IN} = 3.6\text{ V}$; $C_{IN1} = 10\ \mu\text{F}$, $C_{IN2} = 0.1\ \mu\text{F}$, $C_{OUT} = 11\ \mu\text{F}$; $L = 2.2\ \mu\text{H}$.

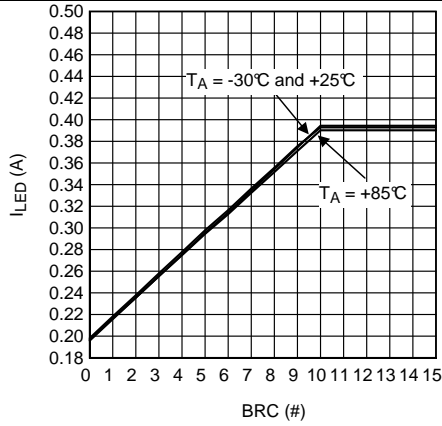

Two Series LEDs Flash

Figure 1. LED Current vs Brightness Code

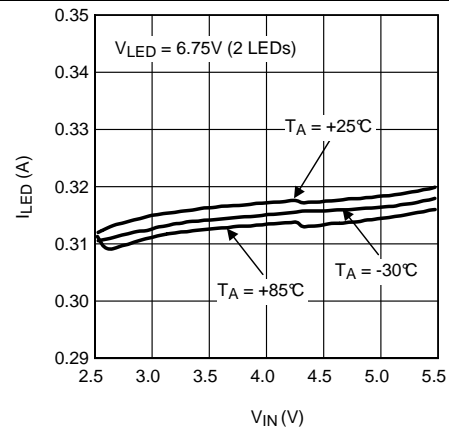

Two Series LEDs at 320 mA

Figure 2. LED Current vs Input Voltage

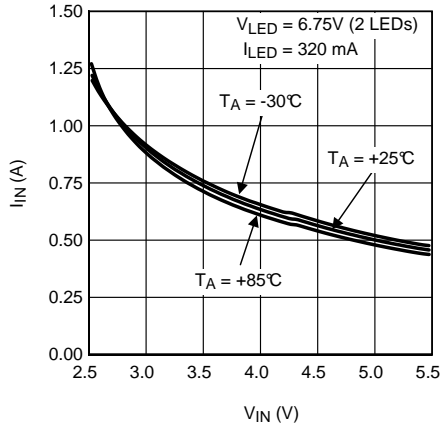

Two series LEDs at 320 mA

Figure 3. Input Current vs Input Voltage

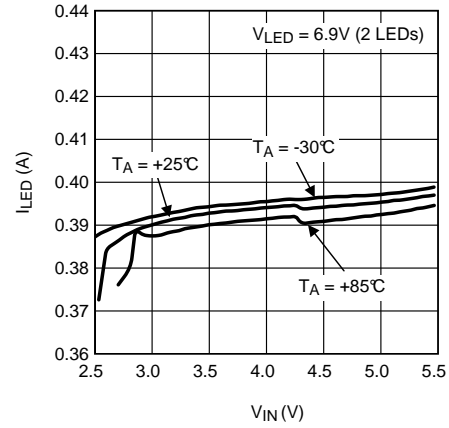

Two series LEDs at 400 mA

Figure 4. LED Current vs Input Voltage

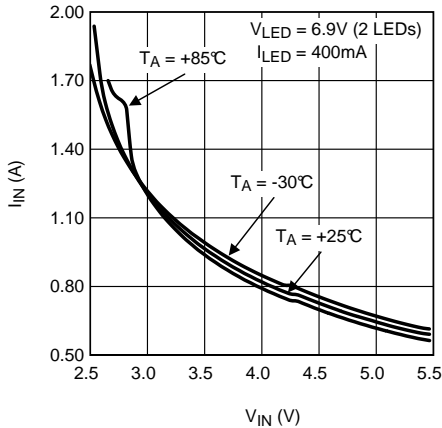

Two Series LEDs at 400 mA

Figure 5. Input Current vs Input Voltage

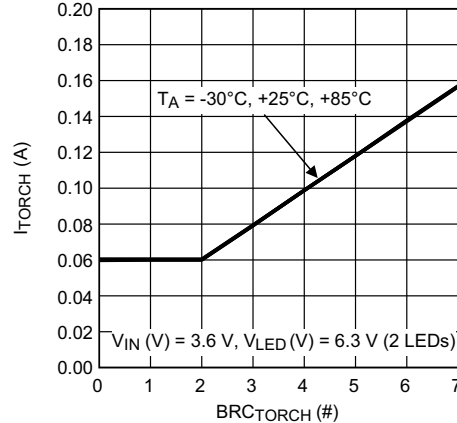

2 LEDs

Figure 6. Torch Current vs Brightness Code

Typical Characteristics (continued)

Unless otherwise specified: $T_A = 25^\circ\text{C}$; $V_{IN} = 3.6\text{ V}$; $C_{IN1} = 10\ \mu\text{F}$, $C_{IN2} = 0.1\ \mu\text{F}$, $C_{OUT} = 11\ \mu\text{F}$; $L = 2.2\ \mu\text{H}$.

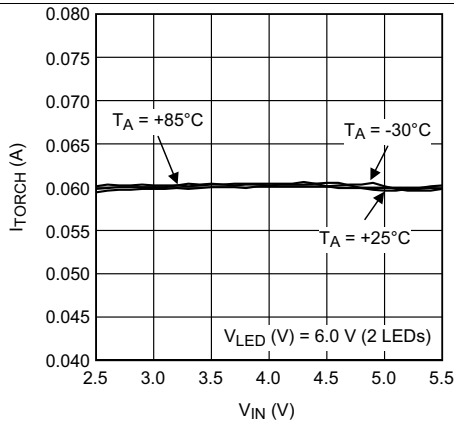

Two LEDs at 60 mA

Figure 7. Torch Current vs Input Voltage

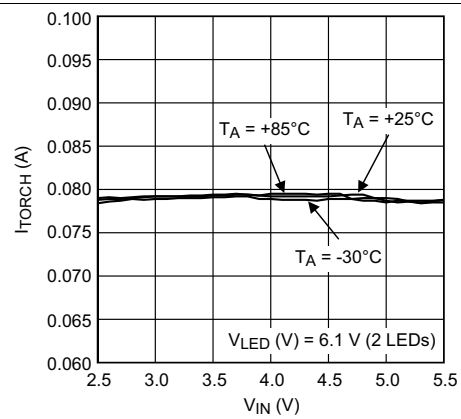

Two LEDs at 80 mA

Figure 8. Torch Current vs Input Voltage

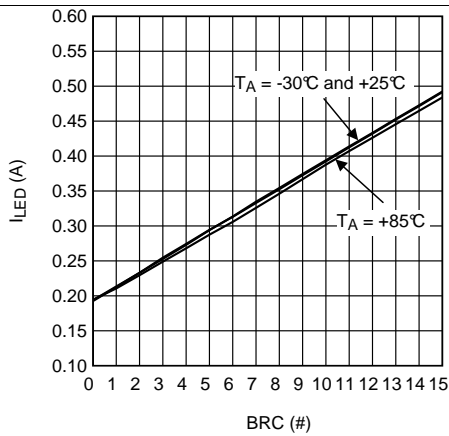
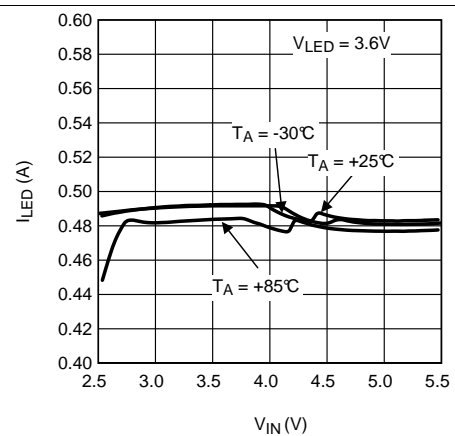
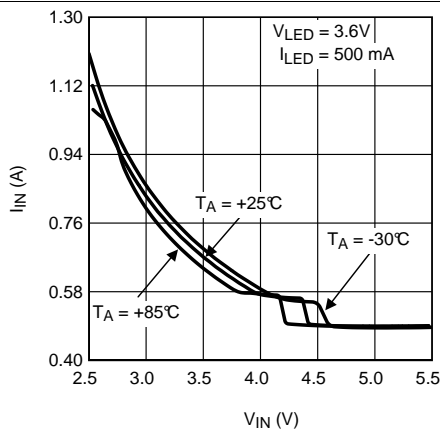

Figure 9. Single LED Flash Current vs Brightness Code



One LED at 500 mA

Figure 10. LED Current vs Input Voltage



One LED at 500 mA

Figure 11. Input Current vs Input Voltage

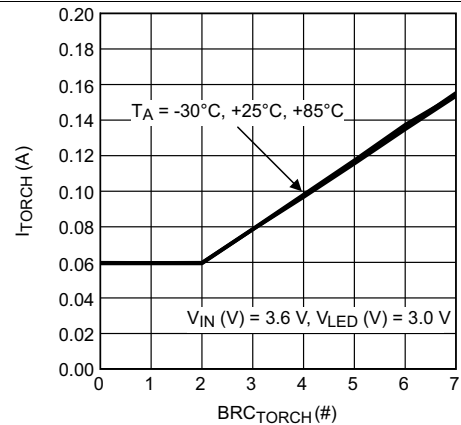

One LED

Figure 12. Torch Current vs Brightness Code

Typical Characteristics (continued)

Unless otherwise specified: $T_A = 25^\circ\text{C}$; $V_{IN} = 3.6\text{ V}$; $C_{IN1} = 10\ \mu\text{F}$, $C_{IN2} = 0.1\ \mu\text{F}$, $C_{OUT} = 11\ \mu\text{F}$; $L = 2.2\ \mu\text{H}$.

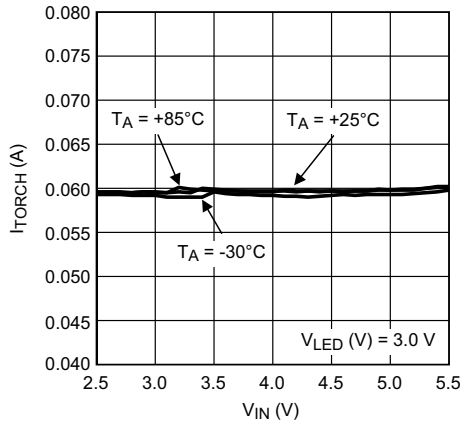

One LED at 60 mA

Figure 13. Torch Current vs Input Voltage

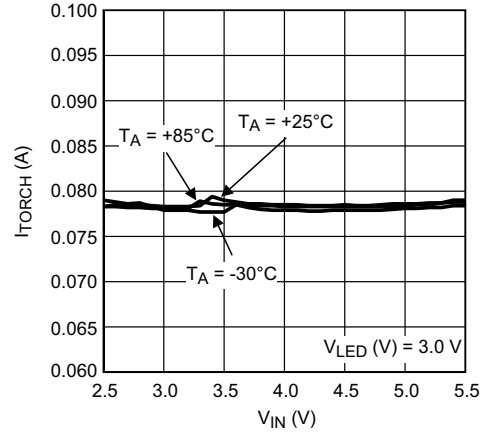

One LED at 80 mA

Figure 14. Torch Current vs Input Voltage

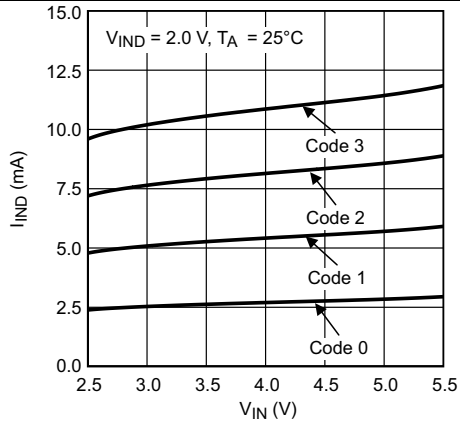

Figure 15. Indicator Current vs Input Voltage Brightness Codes

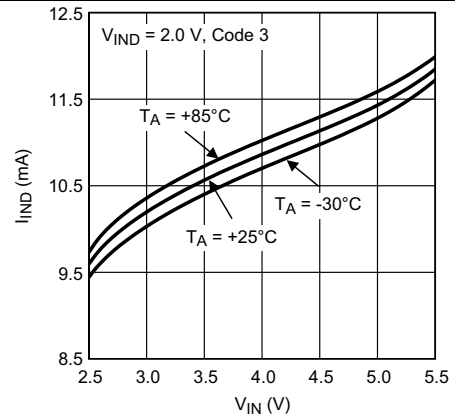

Figure 16. Indicator Current vs Input Voltage Tri-Temp

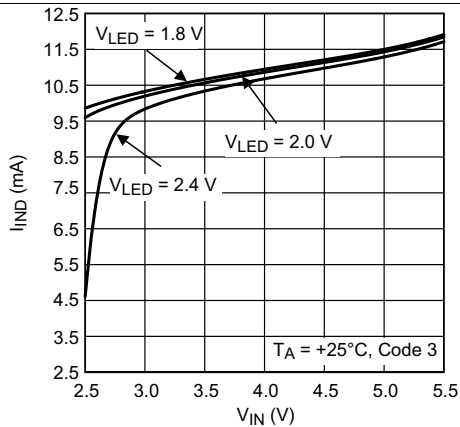

Figure 17. Indicator Current vs Input Voltage VLED

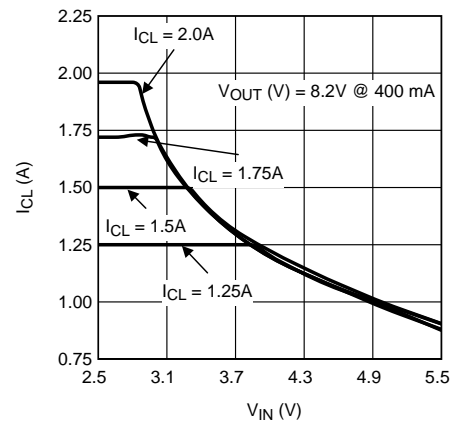

Figure 18. Inductor Current Limit vs Input Voltage

Typical Characteristics (continued)

Unless otherwise specified: $T_A = 25^\circ\text{C}$; $V_{IN} = 3.6\text{ V}$; $C_{IN1} = 10\ \mu\text{F}$, $C_{IN2} = 0.1\ \mu\text{F}$, $C_{OUT} = 11\ \mu\text{F}$; $L = 2.2\ \mu\text{H}$.

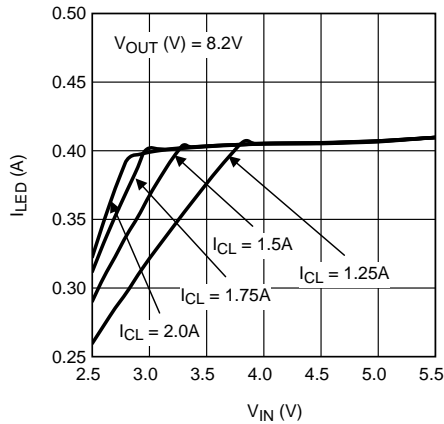

Figure 19. LED Current vs Input Voltage in Current Limit

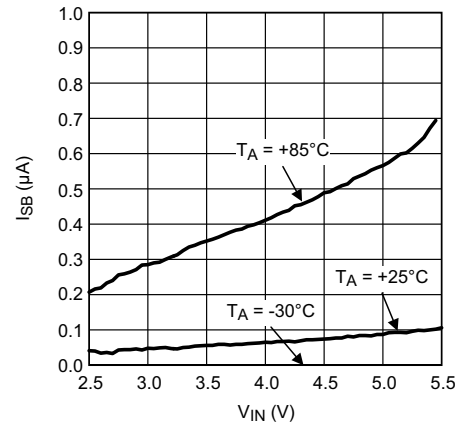

Figure 20. Shutdown Current vs Input Voltage

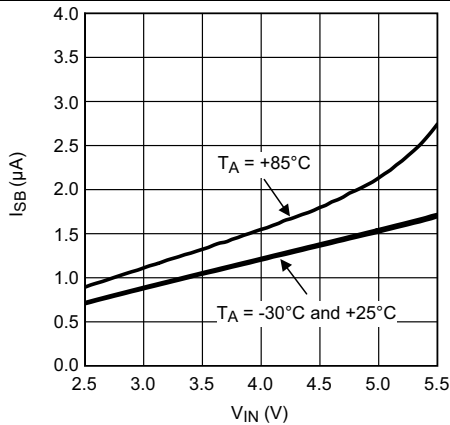

Figure 21. Standby Current vs Input Voltage

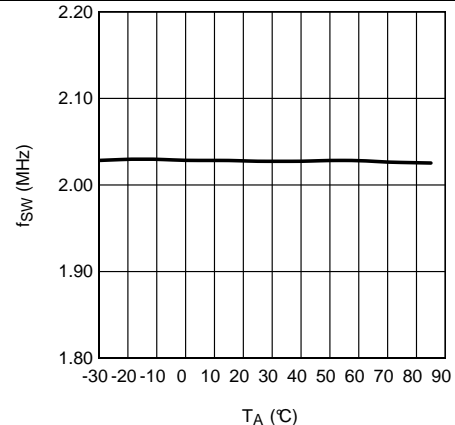

Figure 22. Frequency vs Temperature

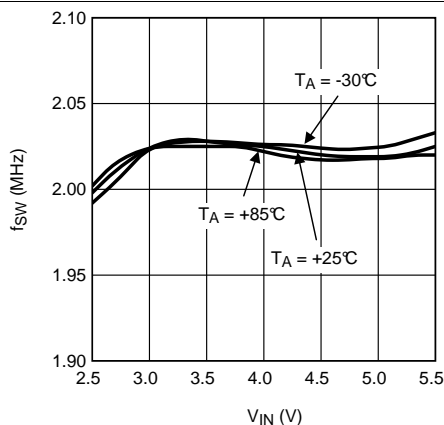

Figure 23. Frequency vs Input Voltage

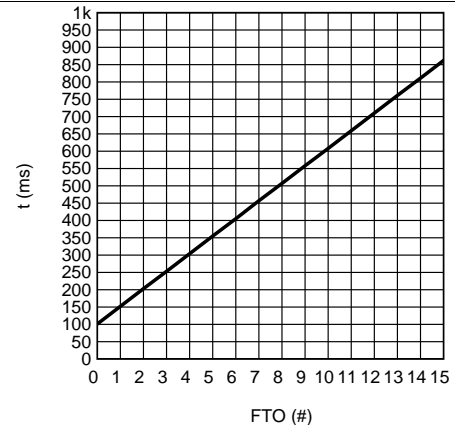

Figure 24. Flash Timeout Time vs Flash Timeout Code

Typical Characteristics (continued)

Unless otherwise specified: $T_A = 25^\circ\text{C}$; $V_{IN} = 3.6\text{ V}$; $C_{IN1} = 10\ \mu\text{F}$, $C_{IN2} = 0.1\ \mu\text{F}$, $C_{OUT} = 11\ \mu\text{F}$; $L = 2.2\ \mu\text{H}$.

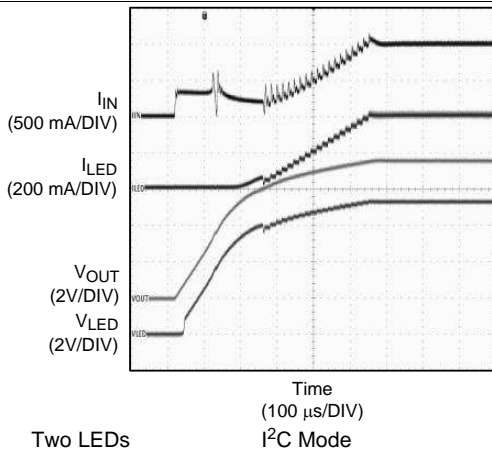

Figure 25. Start-Up

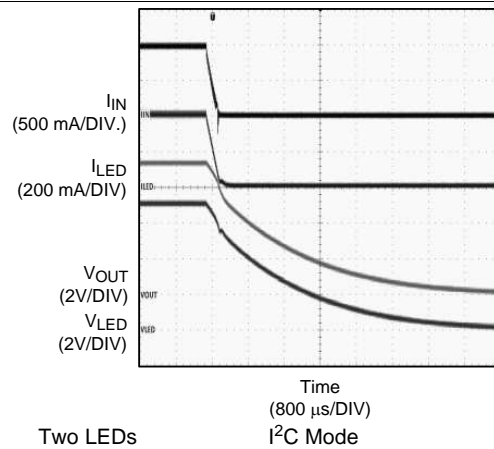

Figure 26. Ramp-Down

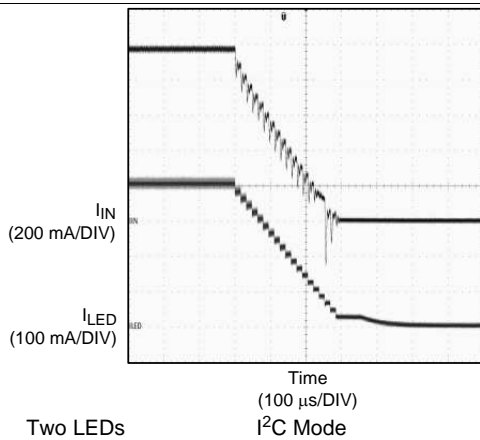

Figure 27. Ramp-Down (Zoom)

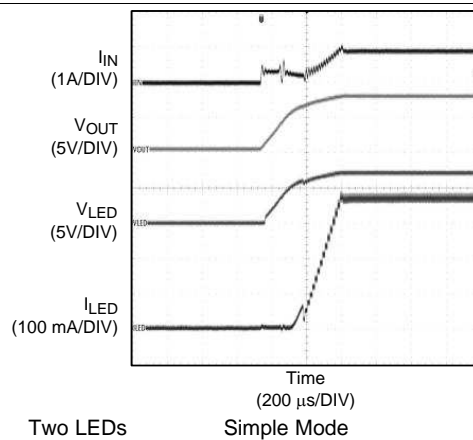

Figure 28. Start-Up

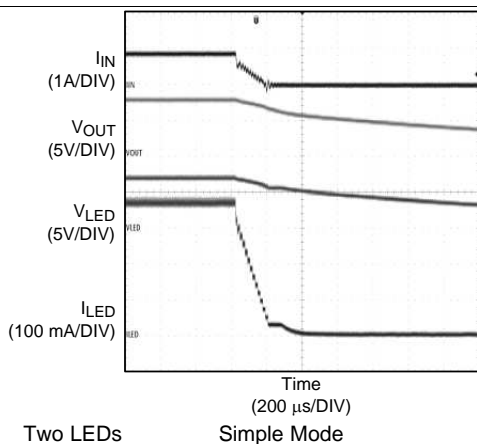

Figure 29. Ramp-Down

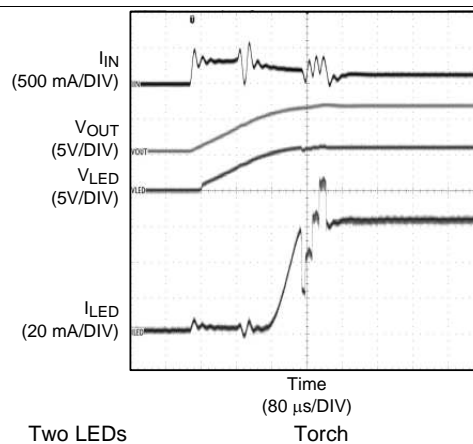

Figure 30. Diode Detect

Typical Characteristics (continued)

Unless otherwise specified: $T_A = 25^\circ\text{C}$; $V_{IN} = 3.6\text{ V}$; $C_{IN1} = 10\ \mu\text{F}$, $C_{IN2} = 0.1\ \mu\text{F}$, $C_{OUT} = 11\ \mu\text{F}$; $L = 2.2\ \mu\text{H}$.

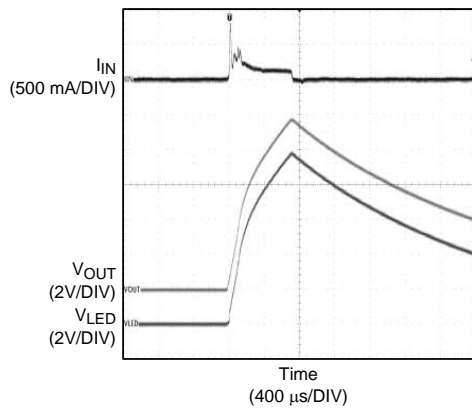

Figure 31. Overvoltage Protection Fault (OVP)

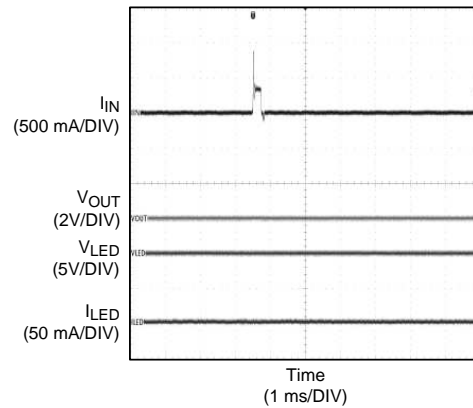

Figure 32. V_{OUT} Short to GND Fault

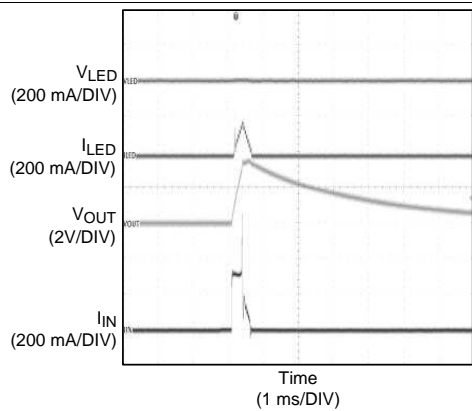

Figure 33. V_{LED} Short to GND Fault

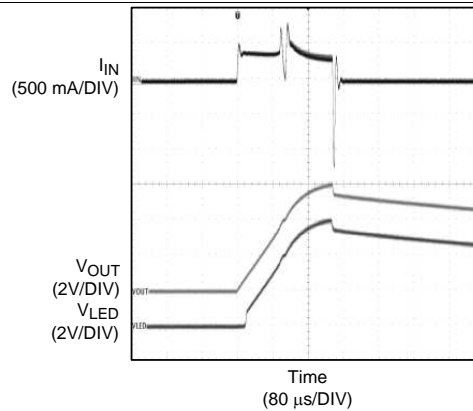

Figure 34. Broken Inductor Fault

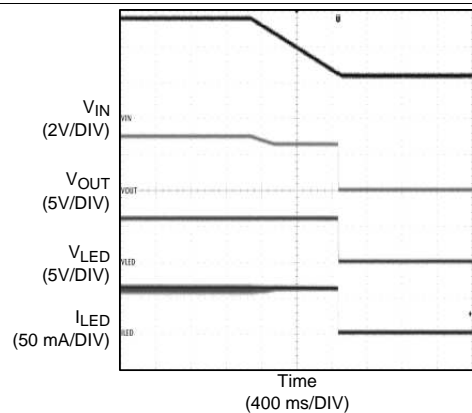

Figure 35. Undervoltage Lockout (UVLO)

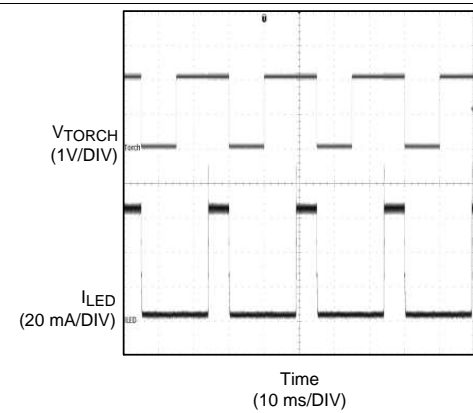
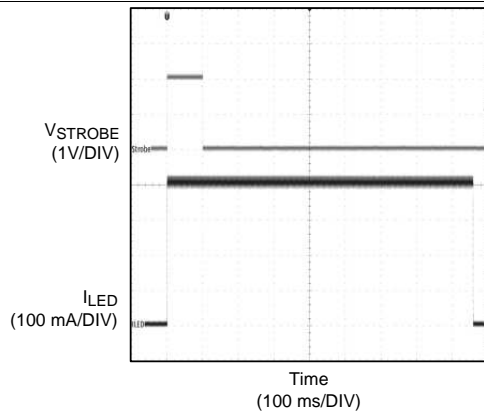
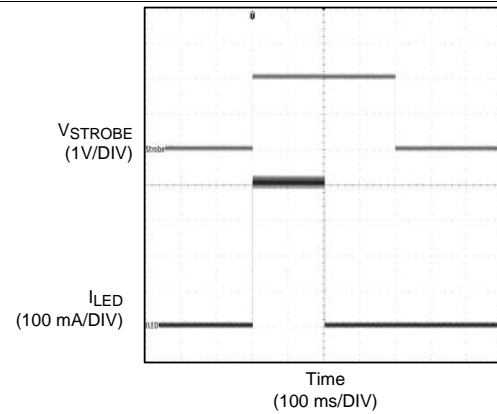
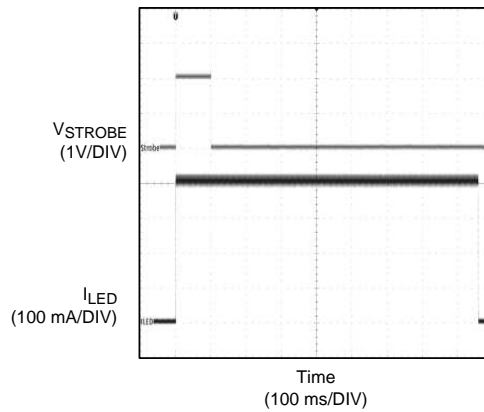

Figure 36. Torch Deglitching Time

Typical Characteristics (continued)

 Unless otherwise specified: $T_A = 25^\circ\text{C}$; $V_{IN} = 3.6\text{ V}$; $C_{IN1} = 10\ \mu\text{F}$, $C_{IN2} = 0.1\ \mu\text{F}$, $C_{OUT} = 11\ \mu\text{F}$; $L = 2.2\ \mu\text{H}$.

Figure 37. Edge Sensitive Strobe

Figure 38. Level Sensitive Strobe With Timeout

Figure 39. Level Sensitive Strobe Without Timeout

7 Detailed Description

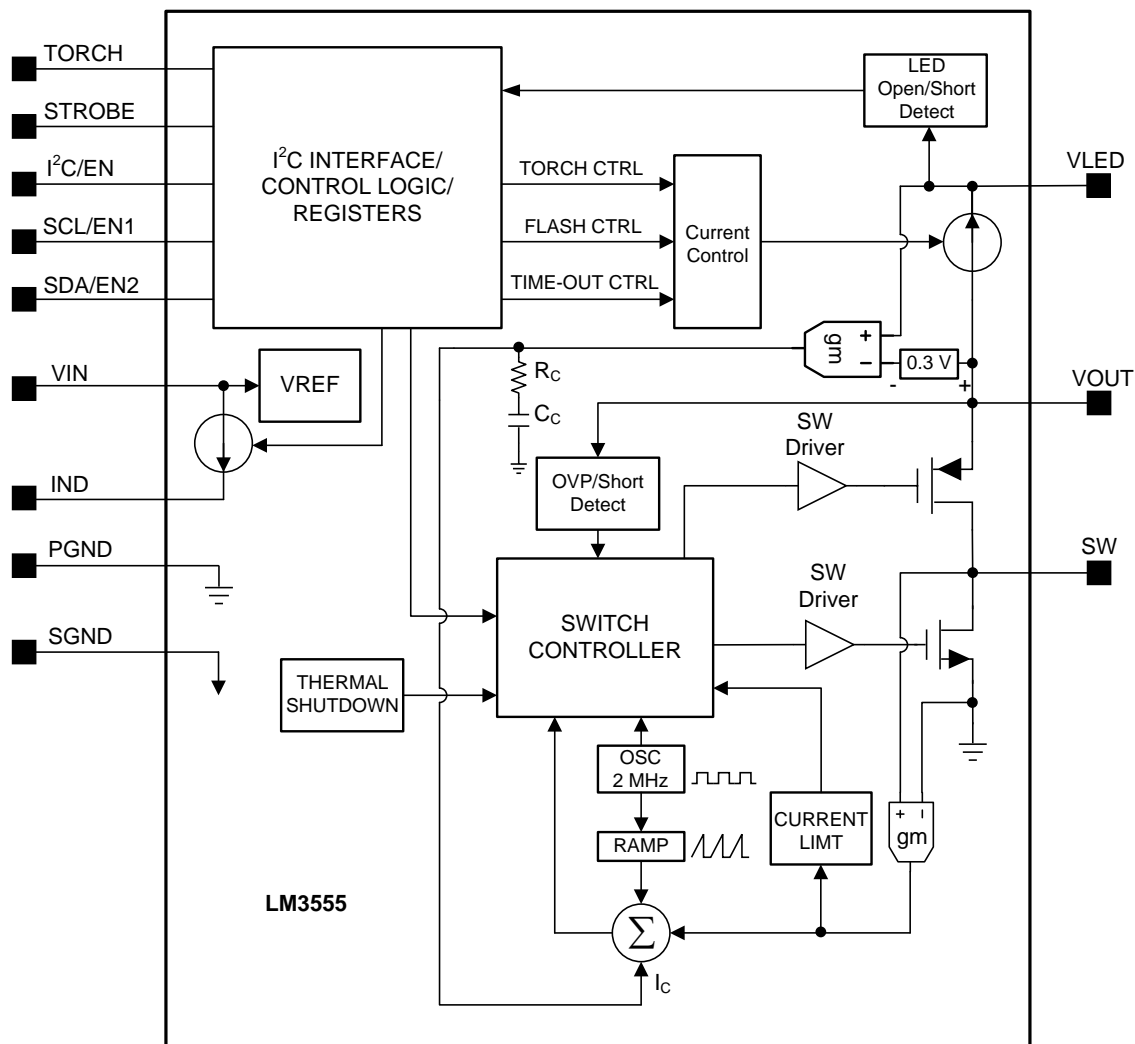
7.1 Overview

The LM3555 is a high-power white-LED flash driver capable of delivering up to 500 mA of LED current into a single LED, or up to 400 mA into two series LEDs. The device incorporates a 2-MHz constant frequency, synchronous, current mode PWM boost converter, and a single high-side current source to regulate the LED current over the 2.5 V to 5.5 V input voltage range. Dual control interfaces (simple ENABLE control or I²C) and diode detection (single LED or two LEDs in series) make the LM3555 highly adaptable to a large variety of designs.

7.2 Functional Block Diagram



Copyright © 2016, Texas Instruments Incorporated

7.3 Feature Description

7.3.1 Synchronous Boost Converter

The LM3555 operates in two modes: LED boost mode or LED pass mode. When the input voltage is above the LED voltage plus current source headroom voltage the device turns the PFET on continuously (pass mode). In pass mode the difference between $(V_{IN} - I_{LED} \times R_{ON_P})$ and the voltage across the LEDs is dropped across the current source. When the output voltage (V_{OUT}) is greater than the input voltage (V_{IN}) minus approximately 200 mV, the PWM converter switches and maintains at least 300 mV across the current source (LED boost mode). This minimum headroom voltage ensures that the current sinks remain in regulation.

Once the LM3555 transitions from pass mode to boost mode, the device does not return to pass mode until the device is disabled and re-enabled. At this point, the converter re-evaluates the conditions and enter the appropriate mode.

7.3.2 High-Side Current Source

The high-side current source of the LM3555 is capable of driving one or two LEDs in series. Depending on the configuration, the LM3555 automatically sets default diode current levels and diode current limits. For a single LED, the flash current range is 200 mA to 500 mA in 20-mA steps with a default current equal to 500 mA. For two LEDs in series, the flash current range is 200 mA to 400 mA in 20-mA steps with a default current equal to 320 mA.

Additionally, the high-side current source is capable of supporting assist/torch current levels (continuous current) between 60 mA and 160 mA in 20-mA levels.

7.3.3 I²C/EN Pin

The I²C/EN pin on the LM3555 changes the control interface depending on its state. To use the LM3555 in the simple control mode, the I²C/EN pin must be tied low. To use the LM3555 in I²C control mode, the I²C/EN pin must be tied high. Toggling this pin between simple control mode and I²C control mode is not recommended.

7.3.4 SDA/EN2 and SCL/EN1 Pins

Depending on the state of the I²C/EN pin, the SDA/EN2 and SCL/EN1 pins function in different ways. If the I²C/EN pin is equal to a 1, the SDA/EN2 pin functions as an I²C SDA (data) pin, and the SCL/EN1 pin functions as an I²C SCL (clock) pin. If the I²C/EN pin is equal to a 0, the SDA/EN2 pin functions as the simple control pin EN2, and the SCL/EN1 pin functions as the simple control pin EN1.

When using the simple control mode, the flash, torch, and indicator modes can be enabled. In simple control mode, internal pulldown resistors on the SDA/EN2 and SCL/EN1 pins become active. In I²C control mode, these pulldowns become disabled.

7.3.5 STROBE Pin

The STROBE pin of the LM3555 provides an external method for initiating a flash event. In most cases, the STROBE pin is connected to an imaging module so that the image capture and flash event are synchronized. The STROBE pin is only functional when the LM3555 is placed into I²C control mode (I²C/EN = 1) and the output on (OEN in 0x04) and strobe signal Mode (SEN in 0x04) bits are set (1). The STROBE pin can be configured to be an edge sensitive or level sensitive input by setting the strobe signal usage bit (SSU in 0x04. 1 = Level, 0 = Edge). In edge sensitive mode, a rising edge transition (0 to 1) starts the flash event, and the internal flash timer terminates the event. In level sensitive mode, a rising edge transition (0 to 1) starts the flash event and a falling edge transition (1 to 0) or the internal flash timer, whichever occurs first, terminates the event. In I²C mode, there is an internal pulldown resistor that becomes enabled on the STROBE pin.

In simple control mode, the STROBE pin functions as a output when a pullup resistor is connected, alerting the user to the number of flash LEDs present in the system. If the STROBE pin is outputting a 1, two LEDs are present, whereas a 0 indicates a single LED is present.

Feature Description (continued)

7.3.6 TORCH Pin

The TORCH pin of the LM3555, depending on the state and configuration, allows the user to enable torch/assist mode without having to write the command through the I²C bus or through toggling the EN1 and EN2 pins. In simple mode, the LM3555 drives 60 mA of LED current if two series LEDs are present and 80 mA if one LED is present. In I²C mode, the external torch mode bit (TEN in register 0x04) must be set to a 1 to allow an external torch (default value = 1). In I²C mode, the torch mode current is equal to the Assist mode current level stored in register 0x03. The TORCH pin has an internal pulldown resistor enabled in both simple mode and I²C mode.

7.3.7 Indicator LED Pin (IND)

The indicator LED current source pin (IND) is able to drive a single red indicator LED when the anode is connected to the LM3555 and the cathode is connected to ground. In simple logic mode, the default indicator current is 2.5 mA, and in I²C mode, the indicator LED current can be adjusted to 2.5 mA, 5 mA, 7.5 mA, or 10 mA.

7.3.8 Internal Diode Detection

During the start-up sequence of the LM3555 an internal voltage comparator on the VLED pin monitors the forward voltage of the LED or LEDs. This measurement occurs when the ramp-up current reaches 80 mA. If, at this time, the diode voltage exceeds the user-selectable diode detect threshold (Register 0x02 bits VO1 and VO0), the LM3555 assumes two series LEDs are present and limits the maximum flash current to 400 mA. The four adjustable levels are; 00 = 4.35 V, 01 = 4.65 V, 10 = 4.05 V and 11 = 4.95 V. This detection feature can be disabled by setting the diode detect enable bit (DEN) in the Current Set Register (address 0x03) to a 0. The DEN bit is set to a 1 (enabled) by default.

In all cases during start-up, the diode current first ramps to 80 mA and then proceeds to the target current. If the torch/assist current is set to 60 mA, the LM3555 first reaches 80 mA and then drops to 60 mA.

The number of LEDs present in the system is recorded in a read-only diode number (DN) bit of the fault register (address 0x05). In simple mode, the number of LEDs present are output on the STROBE pin (0 = 1 LED, 1 = 2 LEDs).

Feature Description (continued)

7.3.9 Fault Protections

The LM3555 has a number of fault protection mechanisms designed to not only protect the LM3555 device itself, but also the rest of the system. Active faults protections include:

- Overvoltage protection (VO_{UT})
- Short-Circuit protection (VO_{UT} and VLED)
- Overtemperature protection
- Flash timeout
- Indicator LED protection (open and short)
- Broken inductor protection

In the event that any of these faults occur, the LM3555 sets a flag in the Fault Register (Address 0x05) and places the device into standby or shutdown. In simple control mode, normal operation cannot resume until the fault has been fixed and until EN1 and EN2 are driven low 0. In I²C control mode, normal operation cannot resume until the fault has been fixed and until an I²C read of the faults register (0x05) has completed. The act of reading the fault register clears the fault bits.

7.3.9.1 Output Overvoltage Protection (OVP)

An OVP fault is triggered when the output voltage of the LM3555 reaches a value greater than 9.5 V (typical). The OVP condition is cleared when the output voltage (V_{OUT}) is able to operate below 9.5 V. An output capacitor or an LED that has become an open circuit can cause an OVP event to occur. This fault is reported to the OVP fault bit in the Fault Register (bit7 in address 0x05).

7.3.9.2 Output and LED Short-Circuit Protection (SCP)

An SCP fault is triggered when the output voltage (V_{OUT}) and/or the VLED pin does not reach 0.8 V in 0.5 ms. The short circuit condition is cleared when the output (VO_{UT}) is allowed to reach its steady state target and when the LED voltage rises above 0.8 V. A shorted output capacitor or a shorted LED could cause this fault to occur. This fault is reported to the SC fault bit in the Fault Register (bit6 in address 0x05).

7.3.9.3 Overtemperature Protection (OTP)

An OTP fault is triggered when the diode junction temperature of the LM3555 reaches an internal temperature of around 150°C. The OTP condition is cleared when the junction temperature falls below 140°C. A printed circuit board (PCB) with poor thermal dissipation properties and very high ambient temperatures (greater than 85°C) could cause this fault to occur. Refer to *AN-1112 DSBGA Wafer Level Chip Scale Package (SNVA009)* for more information regarding proper PCB layout. This fault is reported to the OTP fault bit in the Fault Register (bit5 in address 0x05).

7.3.9.4 Flash Timeout (FTP)

An FTP fault is triggered any time the flash pulse duration reaches the flash timeout duration. In I²C control mode, the FTP fault is triggered whenever a flash is initiated through the Control Register (OEN and OM1/OM0 bits) or through an edge-sensitive strobe event. A FTP fault could occur in simple control Mode if the controller tied to EN1 and EN2 pins cannot toggle the pins low at the desired pulse rate. This same condition could occur with a level-sensitive strobe event controlled by a camera module. This fault is reported to the TO fault bit in the Fault Register (bit4 in address 0x05). A FTP fault is the only reported *fault* that does not need to be cleared before any additional LED event can occur.

7.3.9.5 Indicator Fault (IF)

An IF fault is triggered when the voltage on the IND pin is greater than 2.571 V or less than 0.842 V. This fault indicates that there is either an open or a short present on the IND pin. The short-circuit condition is cleared when the IND pin is allowed to operate between 0.842 V and 2.571 V. A shorted or open indicator LED could cause this fault to occur. This fault is reported to the IF fault bit in the Fault Register (bit2 in address 0x05).

Feature Description (continued)

7.3.9.6 Broken Inductor Fault (IP)

An IP fault is triggered when the LM3555 detects that the inductance of the inductor has dropped below an acceptable value. This fault indicates that the inductor has been damaged. An inductor that has had its ferrite material damaged could cause this fault to occur. This fault is reported to the IP fault bit in the Fault Register (bit1 in address 0x05).

7.3.10 Undervoltage Lockout (UVLO)

The LM3555 has a UVLO feature that disables the operation of the device in the event that the input voltage falls below 2.4 V (typical). In simple control mode, the input voltage must increase to at least 2.47 V (typical), and the EN1 and EN2 pins must be toggled low (0) before normal operation can resume.

In I²C control mode, the output enable bit in the Control Register (Address 0x04) is set to a 0 in the event of a UVLO occurrence. The input voltage must rise to at least 2.47 V before the LM3555 becomes fully functional again.

A UVLO event does not disturb the state of the other registers of the LM3555.

7.3.11 Power-On Reset (POR)

A POR circuit is present on the LM3555 for use in I²C control mode. The POR circuit ensures that the device starts in a known OFF state and that the registers used in the I²C control interface are initialized to the proper start-up values once the input voltage reaches a voltage greater than 1.8 V (typical). An input voltage lower than 1.8 V not only places the device into UVLO, but also clears all of the LM3555 registers.

7.4 Device Functional Modes

7.4.1 Single LED Operation

In single LED operation, the LED flash current is allowed to reach the maximum level of 500 mA. By default, the assist/torch current is set to 80 mA, and the flash current is set to 500 mA.

For input voltages that are higher than the LED forward voltage, the LM3555 operates in a pass mode. As V_{IN} drops, the LM3555 first transitions from pass mode to the minimum duty-cycle boost mode. In this mode, the output voltage (V_{OUT}) increases to a level higher than needed to maintain current regulation through the current source. If V_{IN} continues to decrease, the LM3555 transitions again, this time from minimum duty-cycle boost mode to standard boost mode. Standard boost mode adjusts the converters duty cycle to maintain 300 mV across the current source of the device.

Once the LM3555 transitions from pass mode to either boost mode, the device stays in one of those boost modes until the device is disabled or timed-out and then restarted.

7.4.2 Dual LED Operation

In dual LED operation, the LED flash current is allowed to reach a maximum level of 400 mA. By default, the assist/torch current is set to 60 mA, and the flash current is set to 320 mA.

During dual LED operation, the output voltage is always greater than the input voltage (assuming standard white flash LEDs are used), forcing the LM3555 to be in boost mode over the entire input voltage range.

7.4.3 Torch or Assist (Continuous Current) Operation

There are two different continuous current modes on the LM3555: torch and assist.

Torch mode is enabled through the use of the dedicated TORCH pin using both simple and I²C modes (1 = Torch, 0 = Standby (I²C mode) or shutdown (simple mode)). In I²C control mode, the TORCH pin functionality can be enabled and disabled through by setting the value of the TEN bit in the Control Register (Address 0x04). TEN = 1 allows an external torch while TEN = 0 does not.

Assist mode is enabled in simple control mode by driving EN1 low (0) and by driving EN2 high (1). In I²C control mode, assist mode is enabled by setting the output mode bits (OM1 and OM0) to 10 and setting the output enable bit (OEN) to a 1 in the Control Register (0x04). Assist mode remains active in I²C mode until the OEM bit is set to 0 or until a flash event occurs.

Device Functional Modes (continued)

The LM3555 can drive one or two LEDs at continuous current levels ranging from 60 mA to 160 mA in 20-mA steps. In simple control mode, the torch and assist current levels are equal to 60 mA for two LEDs or 80 mA for a single LED. In I²C mode, the current is set in the Current Set Register (Address 0x30, AC2-AC0 bits).

7.4.4 Flash (Pulsed Current) Operation

A flash event using the LM3555 can be initiated through the dedicated control interface in both simple and I²C modes, and through the use of the STROBE pin in I²C mode.

By driving both EN1 and EN2 high (1) in simple mode, the device enters flash mode and remains there until the control pins are driven low (0), or a timeout event occurs. In simple mode, the flash current is equal to 500 mA when driving a single LED and 320 mA when two LEDs are present. The default time-out duration is 850 ms.

When placed into I²C Control mode, a flash event is initiated when the output mode bits (OM1 and OM0) are set to 11, and the output enable bit (OEN) is set to a 1 in the Control Register (0x04). In I²C mode, the flash event remains active as long as the OEN bit is set to a 1 and terminates upon a timeout event. The safety timer duration can be set in 50 ms intervals ranging from 100 ms to 850 ms by writing the desired value to the FT3-FT0 bits in the Indicator and Timer Register (Address 0x02).

The STROBE pin provides added system flexibility because it allows an additional external device (camera module, GPU, and so forth) to trigger a flash event. To initiate a strobe event in I²C control mode, the strobe signal mode (SEN) bit and the output enable (OEN) bits in the Control Register (Address 0x04) must first be set to 1's.

Following the setting of the SEN and OEN bits, the user must choose to have an edge-sensitive or level-sensitive strobe event. Writing a 1 to the strobe signal usage (SSU) bit in the Control Register (Address 0x04), the LM3555 is configured to be level sensitive, while writing a 0 configures the device to be edge sensitive. In both cases, the strobe flash event is started upon the STROBE pin being driven high.

In an edge-sensitive event, the flash duration stays active until the flash duration timer lapses regardless of the state of the STROBE pin. If a level-sensitive strobe is used, the flash event remains active as long as the STROBE pin is held high and as long as the flash duration time has not lapsed.

In I²C control mode, the end of a flash event, whether initiated through the Control Register or STROBE pin, forces the OEN bit to a 0 and places the LM3555 back into the standby state.

7.4.5 Indicator Operation

Indicator mode is enabled in simple control mode by driving EN1 high (1) and by driving EN2 high (0). In I²C control mode, Indicator mode is enabled by setting the output mode bits (OM1 and OM0) to 01 and setting the Output Enable bit (OEN) to a 1 in the Control Register (0x04). Indicator mode remains active in I²C mode until the OEM bit is set to 0 or until a torch or flash event occurs.

In simple control mode, the indicator LED current is fixed to 2.5 mA, while in I²C control mode, the indicator current is adjustable to 2.5 mA, 5 mA, 7.5 mA, or 10 mA by changing the values of the IC1 and IC0 bits in the Indicator and Timer Register (Address 0x02).

7.4.6 Simple Control State Diagram

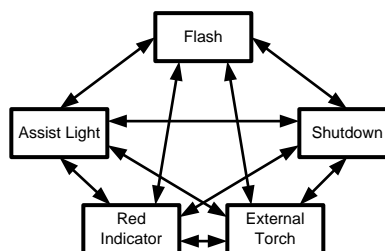

Device Functional Modes (continued)

Table 1. Simple Mode Truth Table⁽¹⁾

EN1	EN2	TORCH	MODE
0	0	0	shutdown
0	0	1	external torch
0	1	X	assist light
1	0	X	indicator
1	1	X	flash

(1) I²C/EN = 0

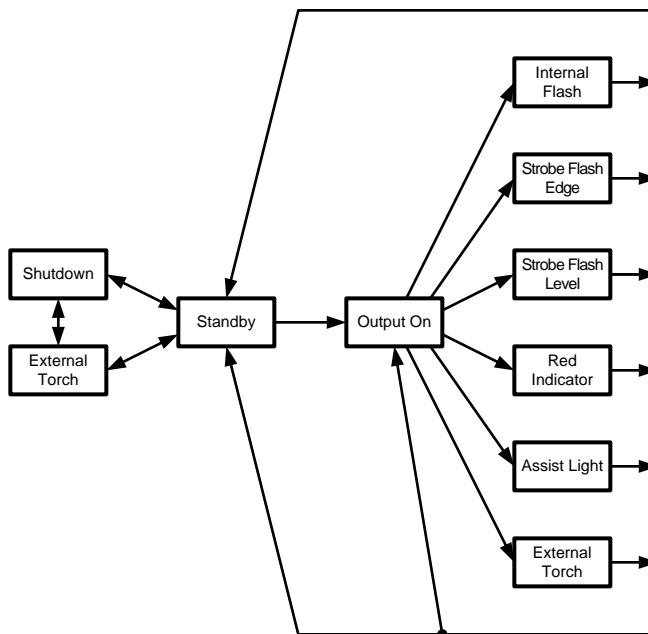

Figure 40. I²C Control State Diagram

Table 2. I²C Mode Truth Table⁽¹⁾

OEN	OM1	OM0	TEN	SEN	TORCH	STROBE	MODE
0	0	0	0	X	X	X	standby
0	0	0	1	X	0	X	standby
0	0	0	1	X	1	X	external torch
0	0	1	X	X	X	X	atandby
0	1	0	X	X	X	X	atandby
0	1	1	X	X	X	X	atandby
1	0	0	X	X	0	X	atandby
1	0	0	X	X	1	X	external torch
1	0	1	X	X	X	X	indicator
1	1	0	X	X	X	X	assist
1	1	1	X	0	X	X	internal flash
1	1	1	X	1	X	0	atandby
1	1	1	X	1	X	1	strobe flash

(1) I²C/EN = 1, SCL and SDA = X

7.5 Programming

7.5.1 I²C-Compatible Interface

7.5.1.1 Data Validity

The data on SDA line must be stable during the HIGH period of the clock signal (SCL). In other words, the state of the data line can only be changed when CLK is LOW.

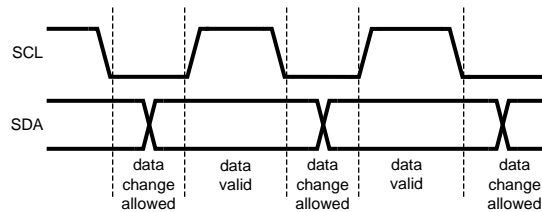

Figure 41. Data Validity Diagram

A pullup resistor between V_{IO} and SDA must be greater than $(V_{IO} - V_{OL}) / 3 \text{ mA}$ to meet the V_{OL} requirement on SDA. Using a larger pullup resistor results in lower switching current with slower edges, while using a smaller pullup results in higher switching currents with faster edges.

7.5.1.2 Start and Stop Conditions

START and STOP conditions classify the beginning and the end of the I²C session. A START condition is defined as SDA signal transitioning from HIGH to LOW while SCL line is HIGH. A STOP condition is defined as the SDA transitioning from LOW to HIGH while SCL is HIGH. The I²C master always generates START and STOP conditions. The I²C bus is considered to be busy after a START condition and free after a STOP condition. During data transmission, the I²C master can generate repeated START conditions. First START and repeated START conditions are equivalent, function-wise. The data on SDA line must be stable during the HIGH period of the clock signal (SCL). In other words, the state of the data line can only be changed when CLK is LOW.

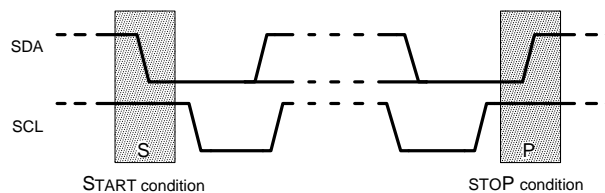

Figure 42. Start and Stop Conditions

7.5.1.3 Transferring Data

Every byte put on the SDA line must be eight bits long, with the most significant bit (MSB) being transferred first. Each byte of data has to be followed by an acknowledge bit. The acknowledge related clock pulse is generated by the master. The master releases the SDA line (HIGH) during the acknowledge clock pulse. The LM3555 pulls down the SDA line during the 9th clock pulse, signifying an acknowledge. The LM3555 generates an acknowledge after each byte has been received.

After the START condition, the I²C master sends a chip address. This address is seven bits long followed by an eighth bit which is a data direction bit (R/W). The LM3555 address is 30h. For the eighth bit, a 0 indicates a WRITE and a 1 indicates a READ. The second byte selects the register to which the data is written. The third byte contains data to write to the selected register.

Programming (continued)

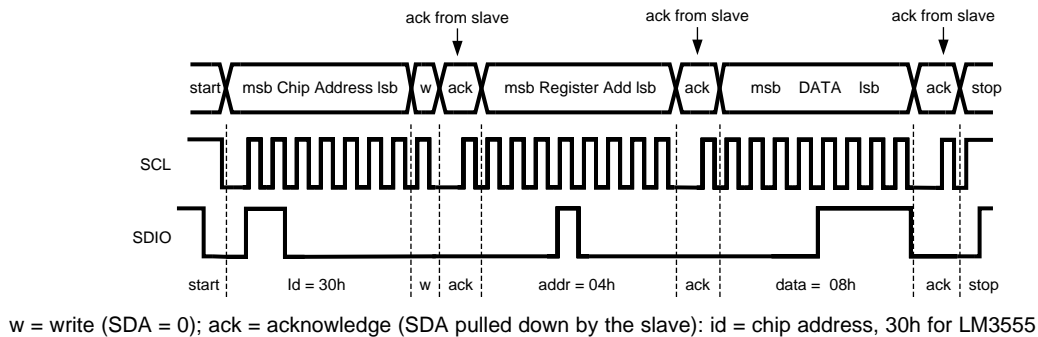

Figure 43. Write Cycle

7.5.1.4 I²C-Compatible Chip Address

The chip address for LM3555 is 0110000, or 30hex.



Figure 44. Device Address

7.6 Register Maps

7.6.1 Internal Registers of LM3555

REGISTER	INTERNAL HEX ADDRESS	POWER ON VALUE
Version Control Register	0x01	0000 1100
Indicator and Timer Register	0x02	0000 1111
Current Set Register	0x03	0110 1001
Control Register	0x04	1011 0100
Fault Register	0x05	0000 1000

7.6.2 Register Definitions

Definition:	RF3	RF2	RF1	RF0	DR3	DR2	DR1	DR0
Default:	0	0	0	0	0110	0110	0110	0110

ARF3–RF0: unused
DR3–DR0: design revision = 1100

Figure 45. Version Control Register, Address: 0x01

Definition:	IC1	IC0	VO1	VO0	FT3	FT2	FT1	FT0
Default:	0	0	0	0	1	1	1	1

IC1–IC0: indicator LED current control bits
VO1–VO0: V_{REF} offset adjustment bits. used for diode detection.
FT3–FT0: software flash timer duration control bits

Figure 46. Indicator and Timer Register, Address: 0x02

Table 3. Indicator Currents

IC1	IC0	INDICATOR LED CURRENT
0	0	2.5 mA
0	1	5 mA
1	0	7.5 mA
1	1	10.0 mA

Table 4. Offset Voltages

VO1	VO0	V_{REF} VOLTAGE (OFFSET FROM 4.35 V)
0	0	4.35 V (+0 V)
0	1	4.65 V (+0.3 V)
1	0	4.05 V (–0.3 V)
1	1	4.95 V (+0.6 V)

Table 5. Flash Timeout Duration

FT3	FT2	FT1	FT0	FLASH TIMEOUT DURATION
0	0	0	0	100 ms
0	0	0	1	150 ms
0	0	1	0	200 ms
0	0	1	1	250 ms

Table 5. Flash Timeout Duration (continued)

FT3	FT2	FT1	FT0	FLASH TIMEOUT DURATION
0	1	0	0	300 ms
0	1	0	1	350 ms
0	1	1	0	400 ms
0	1	1	1	450 ms
1	0	0	0	500 ms
1	0	0	1	550 ms
1	0	1	0	600 ms
1	0	1	1	650 ms
1	1	0	0	700 ms
1	1	0	1	750 ms
1	1	1	0	800 ms
1	1	1	1	850 ms

Definition:

FC3	FC2	FC1	FC0	DEN	AC2	AC1	AC0
-----	-----	-----	-----	-----	-----	-----	-----

Default:

0	1	1	0	1	0	0	1
---	---	---	---	---	---	---	---

FC3-FC0: flash current control bits

DEN: diode detection enable bit. 1 = en, 0 = disabled. default = 1 (enabled)

AC2-AC0: assist light current control bits

Figure 47. Current Set Register, Address: 0x03
Table 6. Flash Current Levels

FC3	FC2	FC1	FC0	FLASH CURRENT LEVEL
0	0	0	0	200 mA
0	0	0	1	220 mA
0	0	1	0	240 mA
0	0	1	1	260 mA
0	1	0	0	280 mA
0	1	0	1	300 mA
0	1	1	0	320 mA (2 LEDs)
0	1	1	1	340 mA
1	0	0	0	360 mA
1	0	0	1	380 mA
1	0	1	0	400 mA (2 LED maximum)
1	0	1	1	420 mA
1	1	0	0	440 mA
1	1	0	1	460 mA
1	1	1	0	480 mA
1	1	1	1	500 mA (1LED)

Table 7. Assist Light Current Levels

AC2	AC1	AC0	ASSIST CURRENT LEVEL
0	0	0	60 mA
0	0	1	60 mA (2 LEDs)
0	1	0	60 mA
0	1	1	80 mA (1 LED)

Table 7. Assist Light Current Levels (continued)

AC2	AC1	AC0	ASSIST CURRENT LEVEL
1	0	0	100 mA
1	0	1	120 mA
1	1	0	140 mA
1	1	1	160 mA

Definition:

IL1	IL0	SSU	TEN	OEN	SEN	OM1	OM0
-----	-----	-----	-----	-----	-----	-----	-----

Default:

1	0	1	1	0	1	0	0
---	---	---	---	---	---	---	---

IL1-IL0: peak inductor current limit bits
 SSU: strobe signal usage. 0 = edge sensitive, 1 = level sensitive. 1 = default
 TEN: external torch mode enable. 0 = not allowed, 1 = allowed. 1 = default
 OEN: output enable. 0 = output disabled, 1 = output enabled. 0 = default
 SEN: strobe signal mode. 0 = disabled, 1 = enabled. 1 = default
 OM1-OM0: output mode select bits

Figure 48. Control Register, Address: 0x04

Table 8. Peak Inductor Current Limit Levels

IL1	IL0	PEAK INDUCTOR CURRENT LIMIT
0	0	1.25 A
0	1	1.5 A
1	0	1.75 A
1	1	2 A

Table 9. Output Modes

OM1	OM0	OUTPUT MODE
0	0	external torch
0	1	indicator
1	0	assist light
1	1	flash

Definition:

OVP	SC	OTP	TO	DN	IF	IP	RFU
-----	----	-----	----	----	----	----	-----

Default:

0	0	0	0	X	0	0	0
---	---	---	---	---	---	---	---

OVP: overvoltage protection fault. 1 = fault, 0 = no fault
 SC: short-circuit fault: 1 = Fault, 0 = no fault
 OTP: overtemperature protection fault. 1 = fault, 0 = no fault
 TO: flash timeout fault. 1 = fault, 0 = no fault
 DN: number of LEDs. 1 = 2 LEDs, 0 = 1 LED. (This bit is R/W). 1 = fault, 0 = no fault
 IF: indicator LED fault. 1 = fault, 0 = no fault
 IP: inductor peak current limit fault (broken inductor fault). 1 = fault, 0 = no fault
 RFU: not used

Figure 49. Fault and Info Register, Address: 0x05

8 Application and Implementation

NOTE

Information in the following applications sections is not part of the TI component specification, and TI does not warrant its accuracy or completeness. TI's customers are responsible for determining suitability of components for their purposes. Customers should validate and test their design implementation to confirm system functionality.

8.1 Application Information

The LM3555 is a white-LED driver for LED camera flash applications. The dual high-side current sources allow for grounded cathode LEDs. The LM3555 can adaptively scale the maximum flash level delivered to the LEDs based upon the flash configuration, whether it be a single LED or two LEDs in series.

8.2 Typical Application

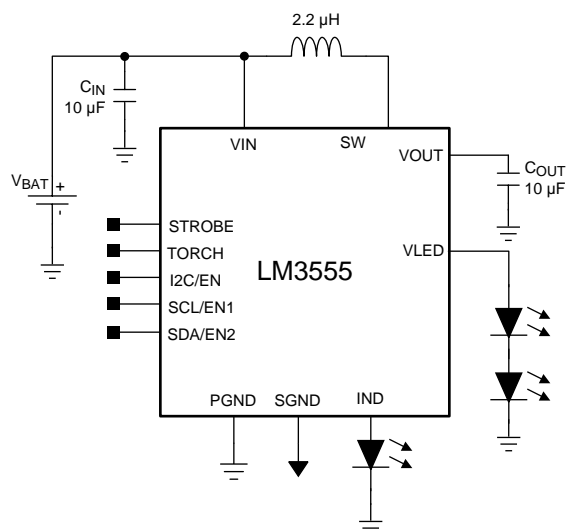

Copyright © 2016, Texas Instruments Incorporated

Figure 50. LM3555 Typical Application

8.2.1 Design Requirements

For typical white-LED driver applications, use the parameters listed in [Table 10](#).

Table 10. Design Parameters

DESIGN PARAMETER	EXAMPLE VALUE
Input voltage range	2.5 V to 5.5 V
Number of LEDs	1 or 2 LEDs in Series
Output current range	60 mA to 500mA

8.2.2 Detailed Design Procedure

8.2.2.1 Inductor Current Limit

To prevent damage to the inductor of the LM3555 and to limit the power drawn by the LM3555 during a flash event, an inductor current limit circuit is present. The LM3555 monitors the current through the inductor during the charge phase of the boost cycle. In the event that the inductor current reaches the current limit, the NFET of the converter terminates the charge phase for that cycle. The process repeats itself until the flash event has ended or until the input voltage increases to the point where the peak current is no longer reached. Hitting the peak inductor current limit does not disable the part. It does, however, limit the output power delivery to the LEDs.

In simple control mode, the peak inductor current limit is set to 1.75 A. In I²C control mode, the inductor current limit can be set to 1.25 A, 1.5 A, 1.75 A, and 2 A depending on the values of the IL1 and IL0 bits in the Control Register (address 0x04). The peak inductor current limit value can be used to help size the inductor to the appropriate saturation current level. For more information on inductor sizing, please refer to the [Inductor Selection](#).

8.2.2.2 Inductor Selection

The LM3555 is designed to use a 2.2-μH inductor. When the device is boosting ($V_{OUT} > V_{IN}$) the inductor is one of the biggest sources of efficiency loss in the circuit. Therefore, choosing an inductor with the lowest possible series resistance is important. Additionally, the saturation rating of the inductor must be greater than the maximum operating peak current of the LM3555. This prevents excess efficiency loss that can occur with inductors that operate in saturation and prevents over heating of the inductor and possible damage. For proper inductor operation and circuit performance ensure that the inductor saturation and the peak current limit setting of the LM3555 (1.25 A, 1.5 A, 1.75 A, or 2 A) is greater than I_{PEAK} . I_{PEAK} can be calculated by:

$$I_{PEAK} = \frac{I_{LOAD}}{\eta} \times \frac{V_{OUT}}{V_{IN}} + \Delta I_L \quad \text{where} \quad \Delta I_L = \frac{V_{IN} \times (V_{OUT} - V_{IN})}{2 \times f_{SW} \times L \times V_{OUT}} \quad (1)$$

Table 11. Recommended Inductors

MANUFACTURER	PART NUMBER	L / I _{SAT}
Toko	FDSE312-2R2M	2.2 μH / 2.3 A
Coilcraft	LPS4012-222ML	2.2 μH / 2.3 A
TDK	VL4014ST-2R2M1R9	2.2 μH / 2 A

8.2.2.3 Capacitor Selection

The LM3555 requires 2 external capacitors for proper operation (TI recommends $C_{IN} = 10 \mu\text{F}$ (4.7 μF minimum) and $C_{OUT} = 10 \mu\text{F}$). TI also recommends placing an additional 0.1-μF input capacitor placed right next to the VIN pin. Surface-mount multi-layer ceramic capacitors are recommended. These capacitors are small, inexpensive and have very low equivalent series resistance (ESR < 20 mΩ typical). Tantalum capacitors, OS-CON capacitors, and aluminum electrolytic capacitors are not recommended for use with the LM3555 due to their high ESR, as compared to ceramic capacitors.

For most applications, ceramic capacitors with X7R or X5R temperature characteristic are preferred for use with the LM3555. These capacitors have tight capacitance tolerance (as good as ±10%) and hold their value over temperature (X7R: ±15% over -55°C to +125°C; X5R: ±15% over -55°C to 85°C).

Capacitors with Y5V or Z5U temperature characteristic are generally not recommended for use with the LM3555. Capacitors with these temperature characteristics typically have wide capacitance tolerance (80%, -20%) and vary significantly over temperature (Y5V: 22%, -82% over -30°C to +85°C range; Z5U: 22%, -56% over 10°C to 85°C range). Under some conditions, a nominal 1-μF Y5V or Z5U capacitor could have a capacitance of only 0.1 μF. Such detrimental deviation is likely to cause Y5V and Z5U capacitors to fail to meet the minimum capacitance requirements of the LM3555.

The recommended voltage rating for the input capacitor is 10 V (minimum = 6.3 V). The recommended output capacitor voltage rating is 16 V (minimum = 10 V). The recommended value takes into account the DC bias capacitance losses, while the minimum rating takes into account the OVP trip levels.

8.2.3 Application Curves

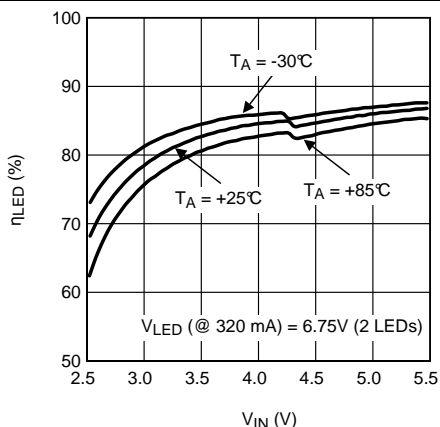

Two Series LEDs at 320 mA

Figure 51. LED Efficiency vs Input Voltage

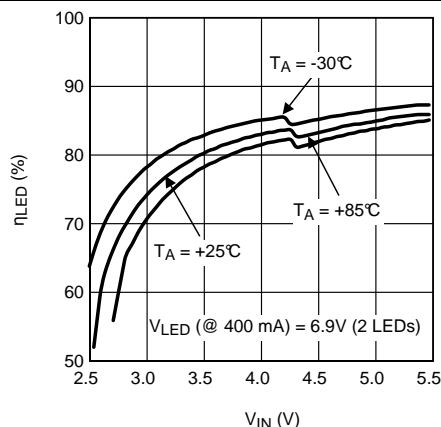

Two Series LEDs at 400 mA

Figure 52. LED Efficiency vs Input Voltage

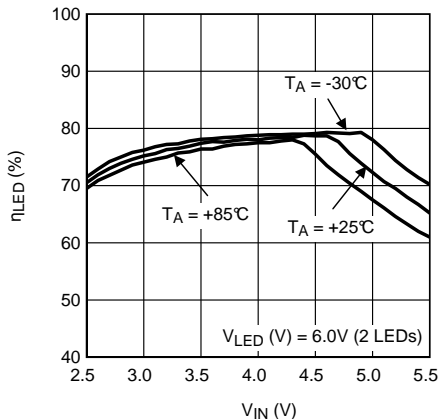

Two LEDs at 60 mA

Figure 53. LED Efficiency vs Input Voltage

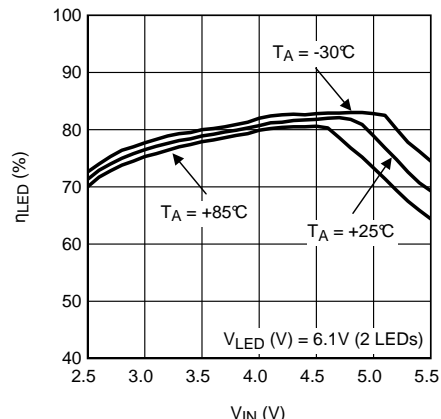

Two LEDs at 80 mA

Figure 54. LED Efficiency vs Input Voltage

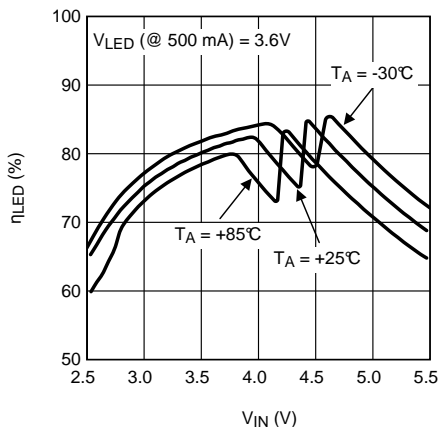

One LED at 500 mA

Figure 55. LED Efficiency vs Input Voltage

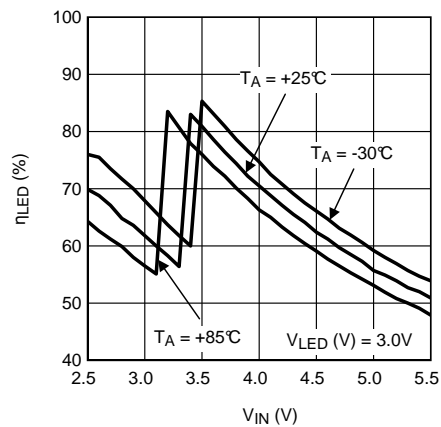

One LED at 60 mA

Figure 56. LED Efficiency vs Input Voltage

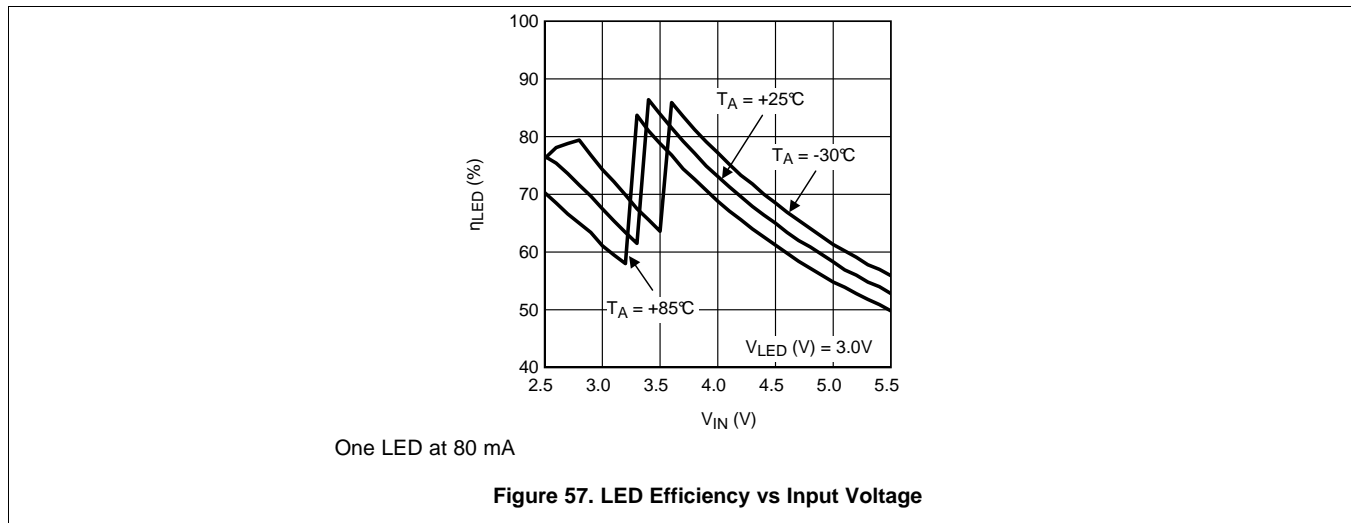

9 Power Supply Recommendations

The LM3555 is designed to operate from an input supply range of 2.5 V to 5.5 V. This input supply must be well regulated and provide the peak current required by the LED configuration and inductor selected.

10 Layout

10.1 Layout Guidelines

The DSBGA is a chip-scale package with good thermal properties. For more detailed instructions on handling and mounting DSBGA packages, refer to *AN-1112 DSBGA Wafer Level Chip Scale Package (SNVA009)*.

The high switching frequencies and large peak currents make the PCB layout a critical part of the design. The proceeding steps must be followed to ensure stable operation and proper current source regulation.

1. Connect the inductor as close to the SW pin as possible. This reduces the inductance and resistance of the switching node which minimizes ringing and excess voltage drops.
2. Connect the return terminals of the input capacitor and the output capacitor as close to the two ground pins (PGND and SGND) as possible and through low impedance traces.
3. Bypass V_{IN} with a 10- μ F ceramic capacitor and an additional 0.1- μ F ceramic capacitor. Connect the positive terminal of this capacitor as close to V_{IN} as possible.
4. Connect C_{OUT} as close to the V_{OUT} pin as possible. This reduces the inductance and resistance of the output bypass node which minimizes ringing and voltage drops. This improves efficiency and decreases the noise injected into the current sources.

10.2 Layout Example

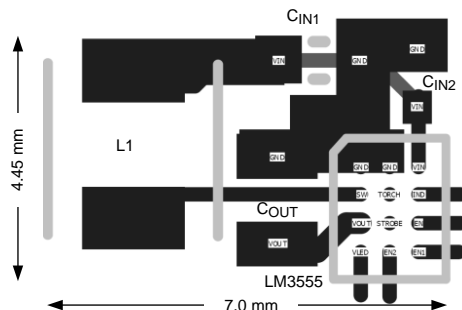

Figure 58. LM3555 Layout

11 Device and Documentation Support

11.1 Device Support

11.1.1 Third-Party Products Disclaimer

TI'S PUBLICATION OF INFORMATION REGARDING THIRD-PARTY PRODUCTS OR SERVICES DOES NOT CONSTITUTE AN ENDORSEMENT REGARDING THE SUITABILITY OF SUCH PRODUCTS OR SERVICES OR A WARRANTY, REPRESENTATION OR ENDORSEMENT OF SUCH PRODUCTS OR SERVICES, EITHER ALONE OR IN COMBINATION WITH ANY TI PRODUCT OR SERVICE.

11.2 Documentation Support

11.2.1 Related Documentation

For additional information, see the following:

AN-1112 DSBGA Wafer Level Chip Scale Package ([SNVA009](#))

11.3 Community Resources

The following links connect to TI community resources. Linked contents are provided "AS IS" by the respective contributors. They do not constitute TI specifications and do not necessarily reflect TI's views; see TI's [Terms of Use](#).

TI E2E™ Online Community *TI's Engineer-to-Engineer (E2E) Community*. Created to foster collaboration among engineers. At [e2e.ti.com](#), you can ask questions, share knowledge, explore ideas and help solve problems with fellow engineers.

Design Support *TI's Design Support* Quickly find helpful E2E forums along with design support tools and contact information for technical support.

11.4 Trademarks

E2E is a trademark of Texas Instruments.
All other trademarks are the property of their respective owners.

11.5 Electrostatic Discharge Caution



This integrated circuit can be damaged by ESD. Texas Instruments recommends that all integrated circuits be handled with appropriate precautions. Failure to observe proper handling and installation procedures can cause damage.

ESD damage can range from subtle performance degradation to complete device failure. Precision integrated circuits may be more susceptible to damage because very small parametric changes could cause the device not to meet its published specifications.

11.6 Glossary

[SLYZ022](#) — *TI Glossary*.

This glossary lists and explains terms, acronyms, and definitions.

12 Mechanical, Packaging, and Orderable Information

The following pages include mechanical, packaging, and orderable information. This information is the most current data available for the designated devices. This data is subject to change without notice and revision of this document. For browser-based versions of this data sheet, refer to the left-hand navigation.

PACKAGING INFORMATION

Orderable Device	Status (1)	Package Type	Package Drawing	Pins	Package Qty	Eco Plan (2)	Lead finish/ Ball material (6)	MSL Peak Temp (3)	Op Temp (°C)	Device Marking (4/5)	Samples
LM3555TLE/NOPB	ACTIVE	DSBGA	YZR	12	250	RoHS & Green	SNAGCU	Level-1-260C-UNLIM	-30 to 85	3555	Samples
LM3555TLX/NOPB	ACTIVE	DSBGA	YZR	12	3000	RoHS & Green	SNAGCU	Level-1-260C-UNLIM	-30 to 85	3555	Samples

(1) The marketing status values are defined as follows:

ACTIVE: Product device recommended for new designs.

LIFEBUY: TI has announced that the device will be discontinued, and a lifetime-buy period is in effect.

NRND: Not recommended for new designs. Device is in production to support existing customers, but TI does not recommend using this part in a new design.

PREVIEW: Device has been announced but is not in production. Samples may or may not be available.

OBSOLETE: TI has discontinued the production of the device.

(2) **RoHS:** TI defines "RoHS" to mean semiconductor products that are compliant with the current EU RoHS requirements for all 10 RoHS substances, including the requirement that RoHS substance do not exceed 0.1% by weight in homogeneous materials. Where designed to be soldered at high temperatures, "RoHS" products are suitable for use in specified lead-free processes. TI may reference these types of products as "Pb-Free".

RoHS Exempt: TI defines "RoHS Exempt" to mean products that contain lead but are compliant with EU RoHS pursuant to a specific EU RoHS exemption.

Green: TI defines "Green" to mean the content of Chlorine (Cl) and Bromine (Br) based flame retardants meet JS709B low halogen requirements of <=1000ppm threshold. Antimony trioxide based flame retardants must also meet the <=1000ppm threshold requirement.

(3) MSL, Peak Temp. - The Moisture Sensitivity Level rating according to the JEDEC industry standard classifications, and peak solder temperature.

(4) There may be additional marking, which relates to the logo, the lot trace code information, or the environmental category on the device.

(5) Multiple Device Markings will be inside parentheses. Only one Device Marking contained in parentheses and separated by a "~" will appear on a device. If a line is indented then it is a continuation of the previous line and the two combined represent the entire Device Marking for that device.

(6) Lead finish/Ball material - Orderable Devices may have multiple material finish options. Finish options are separated by a vertical ruled line. Lead finish/Ball material values may wrap to two lines if the finish value exceeds the maximum column width.

Important Information and Disclaimer:The information provided on this page represents TI's knowledge and belief as of the date that it is provided. TI bases its knowledge and belief on information provided by third parties, and makes no representation or warranty as to the accuracy of such information. Efforts are underway to better integrate information from third parties. TI has taken and continues to take reasonable steps to provide representative and accurate information but may not have conducted destructive testing or chemical analysis on incoming materials and chemicals. TI and TI suppliers consider certain information to be proprietary, and thus CAS numbers and other limited information may not be available for release.

In no event shall TI's liability arising out of such information exceed the total purchase price of the TI part(s) at issue in this document sold by TI to Customer on an annual basis.

TAPE AND REEL INFORMATION

QUADRANT ASSIGNMENTS FOR PIN 1 ORIENTATION IN TAPE

*All dimensions are nominal

Device	Package Type	Package Drawing	Pins	SPQ	Reel Diameter (mm)	Reel Width W1 (mm)	A0 (mm)	B0 (mm)	K0 (mm)	P1 (mm)	W (mm)	Pin1 Quadrant
LM3555TLE/NOPB	DSBGA	YZR	12	250	178.0	8.4	1.68	2.13	0.76	4.0	8.0	Q1
LM3555TLX/NOPB	DSBGA	YZR	12	3000	178.0	8.4	1.68	2.13	0.76	4.0	8.0	Q1

TAPE AND REEL BOX DIMENSIONS

*All dimensions are nominal

Device	Package Type	Package Drawing	Pins	SPQ	Length (mm)	Width (mm)	Height (mm)
LM3555TLE/NOPB	DSBGA	YZR	12	250	208.0	191.0	35.0
LM3555TLX/NOPB	DSBGA	YZR	12	3000	208.0	191.0	35.0

YZR0012

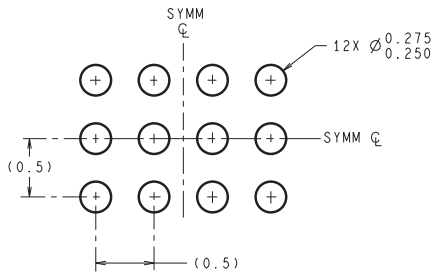

DIMENSIONS ARE IN MILLIMETERS
DIMENSIONS IN () FOR REFERENCE ONLY

LAND PATTERN RECOMMENDATION

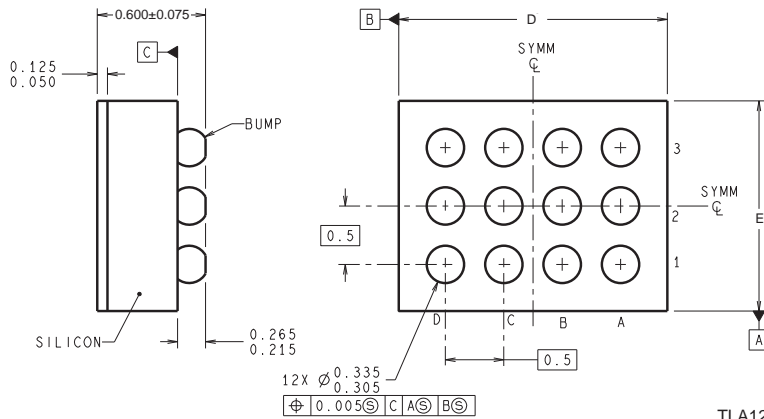
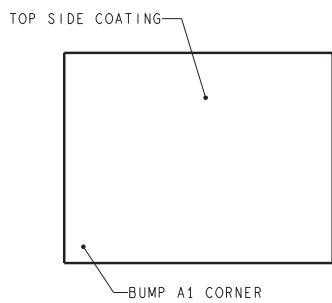

D: Max = 2.09 mm, Min = 2.03 mm

E: Max = 1.565 mm, Min = 1.505 mm

4215049/A 12/12

NOTES: A. All linear dimensions are in millimeters. Dimensioning and tolerancing per ASME Y14.5M-1994.
B. This drawing is subject to change without notice.

IMPORTANT NOTICE AND DISCLAIMER

TI PROVIDES TECHNICAL AND RELIABILITY DATA (INCLUDING DATA SHEETS), DESIGN RESOURCES (INCLUDING REFERENCE DESIGNS), APPLICATION OR OTHER DESIGN ADVICE, WEB TOOLS, SAFETY INFORMATION, AND OTHER RESOURCES "AS IS" AND WITH ALL FAULTS, AND DISCLAIMS ALL WARRANTIES, EXPRESS AND IMPLIED, INCLUDING WITHOUT LIMITATION ANY IMPLIED WARRANTIES OF MERCHANTABILITY, FITNESS FOR A PARTICULAR PURPOSE OR NON-INFRINGEMENT OF THIRD PARTY INTELLECTUAL PROPERTY RIGHTS.

These resources are intended for skilled developers designing with TI products. You are solely responsible for (1) selecting the appropriate TI products for your application, (2) designing, validating and testing your application, and (3) ensuring your application meets applicable standards, and any other safety, security, regulatory or other requirements.

These resources are subject to change without notice. TI grants you permission to use these resources only for development of an application that uses the TI products described in the resource. Other reproduction and display of these resources is prohibited. No license is granted to any other TI intellectual property right or to any third party intellectual property right. TI disclaims responsibility for, and you will fully indemnify TI and its representatives against, any claims, damages, costs, losses, and liabilities arising out of your use of these resources.

TI's products are provided subject to [TI's Terms of Sale](#) or other applicable terms available either on [ti.com](https://www.ti.com) or provided in conjunction with such TI products. TI's provision of these resources does not expand or otherwise alter TI's applicable warranties or warranty disclaimers for TI products.

TI objects to and rejects any additional or different terms you may have proposed.

Mailing Address: Texas Instruments, Post Office Box 655303, Dallas, Texas 75265
Copyright © 2023, Texas Instruments Incorporated