

LP5866 6 x 18 LED 矩阵驱动器，8 位模拟和 8 位/16 位 PWM 调光

1 特性

- LED 矩阵拓扑：
 - 18 个恒定电流阱，具有 6 个扫描开关，可实现 108 个 LED 点
 - 可针对 1 至 6 个扫描开关进行配置
- 工作电压范围：
 - V_{CC}/V_{LED} 范围：2.7V 至 5.5V
 - 逻辑引脚兼容 1.8V、3.3V 和 5V 电压
- 18 个高精度恒定电流阱：
 - 当 $V_{CC} \geq 3.3V$ 时，每个电流阱的电流为 0.1mA - 50mA
 - 器件间误差：当通道电流 = 50mA 时为 $\pm 3\%$
 - 通道间误差：当通道电流 = 50mA 时为 $\pm 3\%$
 - 相移可平衡瞬态功耗
- 超低功耗：
 - 关断模式：当 EN 为低电平时 $I_{CC} \leq 1\mu A$
 - 待机模式：当 EN 为高电平且 CHIP_EN 为 0 (保留数据) 时 $I_{CC} \leq 10\mu A$
 - 有源模式：当通道电流为 5mA 时 $I_{CC} = 4.3\text{ mA}$ (典型值)
- 灵活的调光选项：
 - 对每个 LED 点进行单独的开关控制
 - 模拟调光 (电流增益控制)
 - 为所有 LED 点提供全局 3 位最大电流 (MC) 设置
 - 为红色、绿色和蓝色提供 3 组 7 位颜色电流 (CC) 设置
 - 为每个 LED 点提供单独的 8 位点电流 (DC) 设置
 - 以无可闻噪声的频率进行 PWM 调光
 - 为所有 LED 点实现全局 8 位 PWM 调光
 - 为 LED 点任意映射实现 3 组可编程 8 位 PWM 调光
 - 为每个 LED 点实现单独的 8 位或 16 位 PWM 调光
- 完整的可寻址 SRAM，可更大限度地减少数据流量
- 针对各个 LED 点进行开路和短路检测
- 提供重影消除和低亮度补偿功能
- 接口选项：
 - 当 IFS 为低电平时采用 1MHz (最大值) I²C 接口
 - 当 IFS 为高电平时采用 12MHz (最大值) SPI 接口

2 应用

- 用于以下设备的 LED 动画和指示：
 - 键盘、鼠标和游戏附件

- 大型和智能家用电器
 - 智能音箱、有线和无线音箱
 - 混音器、DJ 设备和广播
 - 接入设备、交换机和服务器
- 用于光学模块的恒定电流阱

3 说明

电子设备变得越来越智能，而且需要使用更多的 LED 提供动画效果和指示功能，因此需要使用高性能 LED 矩阵驱动器以小尺寸解决方案改善用户体验。

LP586x 器件是高性能 LED 矩阵驱动器系列。该系列器件集成了 18 个具有 N (N = 1/2/4/6/8/11) 个开关 MOSFET 的恒定电流阱，以支持 $N \times 18$ 个 LED 点或 $N \times 6$ 个 RGB LED。LP5866 集成了 6 个 MOSFET，从而支持多达 108 个 LED 点或 36 个 RGB LED。

LP5866 同时支持模拟调光和 PWM 调光方法。对于模拟调光，能够以 256 个阶跃来调节每个 LED 点。对于 PWM 调光，集成式 8 位或 16 位可配置 PWM 发生器可实现平滑且无可闻噪声的调光控制。也可以将每个 LED 点任意映射到 8 位组 PWM，以实现共同调光控制。

LP5866 器件实现了完整的可寻址 SRAM，可尽可能减少数据流量。集成了重影消除电路以消除上下重影。LP5866 还支持 LED 开路和短路检测功能。LP5866 同时支持 1MHz (最大值) I²C 和 12MHz (最大值) SPI。

器件信息

器件型号	封装 ⁽¹⁾	封装尺寸 (标称值)
LP5866	VQFN (40)	5mm × 5mm
	TSSOP (38)	9.7mm × 4.4mm

- (1) 如需了解所有可用封装，请参阅数据表末尾的可订购产品附录。

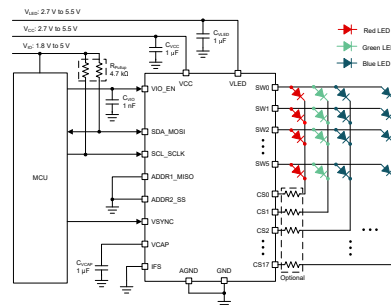

简化版原理图



Table of Contents

1 特性	1	8.4 Device Functional Modes.....	23
2 应用	1	8.5 Programming.....	24
3 说明	1	8.6 Register Maps.....	27
4 Revision History	2	9 Application and Implementation	39
5 Device Comparison	3	9.1 Application Information.....	39
6 Pin Configuration and Functions	4	9.2 Typical Application.....	39
7 Specifications	7	10 Power Supply Recommendations	43
7.1 Absolute Maximum Ratings.....	7	11 Layout	44
7.2 ESD Ratings.....	7	11.1 Layout Guidelines.....	44
7.3 Recommended Operating Conditions.....	7	11.2 Layout Example.....	45
7.4 Thermal Information.....	7	12 Device and Documentation Support	46
7.5 Electrical Characteristics.....	8	12.1 接收文档更新通知.....	46
7.6 Timing Requirements.....	9	12.2 支持资源.....	46
7.7 Typical Characteristics.....	11	12.3 Trademarks.....	46
8 Detailed Description	13	12.4 Electrostatic Discharge Caution.....	46
8.1 Overview.....	13	12.5 术语表.....	46
8.2 Functional Block Diagram.....	13	13 Mechanical, Packaging, and Orderable Information	47
8.3 Feature Description.....	14		

4 Revision History

DATE	REVISION	NOTES
December 2021	*	Initial Release

5 Device Comparison

PART NUMBER	MATERIAL	LED DOT NUMBER	PACKAGE ⁽²⁾	SOFTWARE COMPATIBLE
LP5861	LP5861RSMR	18 × 1 = 18	VQFN-32	Yes
LP5862	LP5862RSMR	18 × 2 = 36	VQFN-32	
	LP5862DBTR		TSSOP-38	
LP5864	LP5864RSMR	18 × 4 = 72	VQFN-32	
	LP5864MRSMR ⁽¹⁾			
LP5866	LP5866RKPR	18 × 6 = 108	VQFN-40	
	LP5866DBTR		TSSOP-38	
	LP5866MDBTR ⁽¹⁾			
LP5868	LP5868RKPR	18 × 8 = 144	VQFN-40	
LP5860	LP5860RKPR	18 × 11 = 198	VQFN-40	
	LP5860MRKPR ⁽¹⁾			

- (1) Extended temperature devices, supporting - 55°C to approximately 125°C operating ambient temperature.
 (2) The same packages are hardware compatible.

6 Pin Configuration and Functions



图 6-1. LP5866 RKP Package 40-Pin VQFN With Exposed Thermal Pad Top View



图 6-2. LP5866 VQFN Package 38-Pin VQFN Top View

表 6-1. Pin Functions

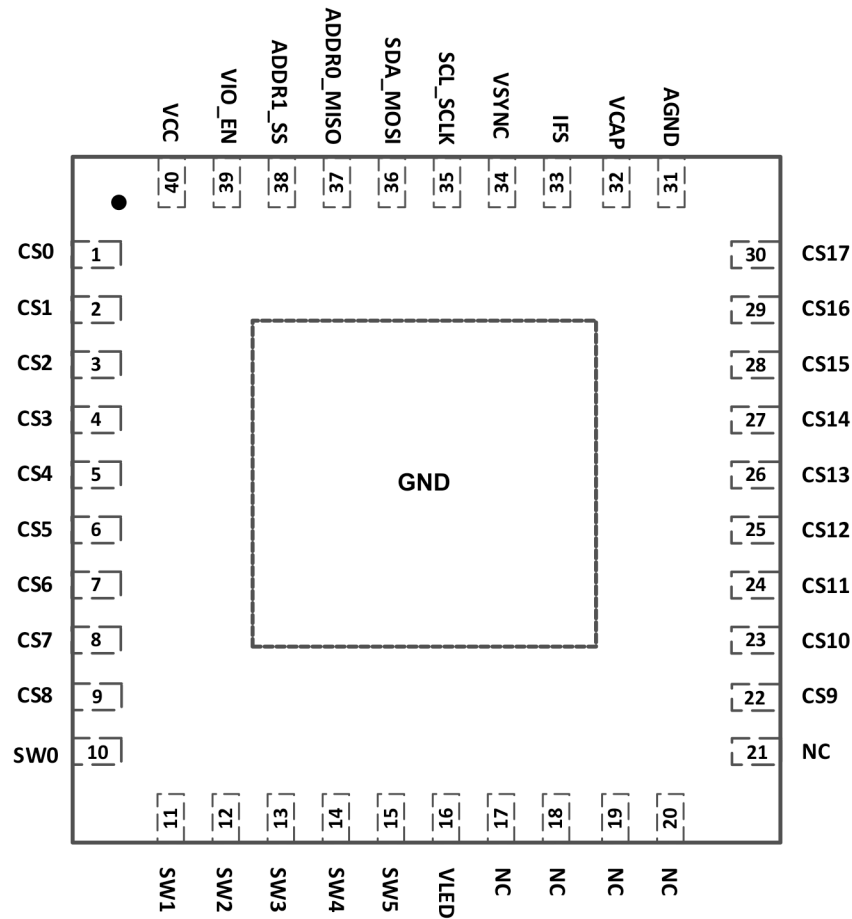
PIN			I/O	DESCRIPTION
NAME	VQFN NO.	TSSOP NO.		
CS0	1	15	O	Current sink 0. If not used, this pin must be left floating.
CS1	2	16	O	Current sink 1. If not used, this pin must be left floating.
CS2	3	17	O	Current sink 2. If not used, this pin must be left floating.
CS3	4	18	O	Current sink 3. If not used, this pin must be left floating.
CS4	5	19	O	Current sink 4. If not used, this pin must be left floating.
CS5	6	20	O	Current sink 5. If not used, this pin must be left floating.
CS6	7	21	O	Current sink 6. If not used, this pin must be left floating.
CS7	8	22	O	Current sink 7. If not used, this pin must be left floating.
CS8	9	23	O	Current sink 8. If not used, this pin must be left floating.
SW0	10	24	O	High-side PMOS switch output for scan line 0. If not used, this pin must be left floating.
SW1	11	25	O	High-side PMOS switch output for scan line 1. If not used, this pin must be left floating.
SW2	12	26	O	High-side PMOS switch output for scan line 2. If not used, this pin must be left floating.
SW3	13	31	O	High-side PMOS switch output for scan line 3. If not used, this pin must be left floating.
SW4	14	32	O	High-side PMOS switch output for scan line 4. If not used, this pin must be left floating.
SW5	15	33	O	High-side PMOS switch output for scan line 5. If not used, this pin must be left floating.

表 6-1. Pin Functions (continued)

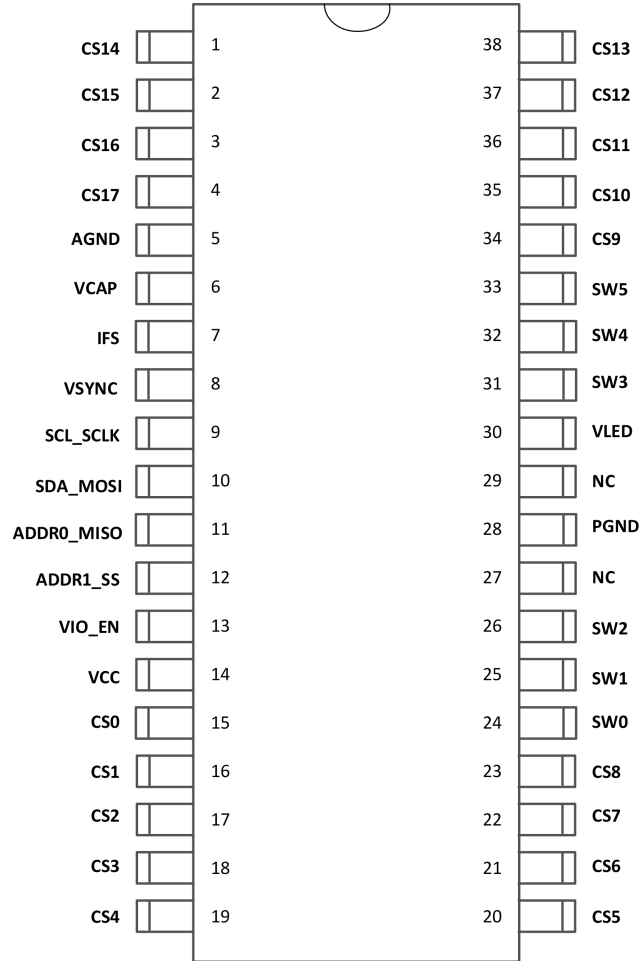
PIN			I/O	DESCRIPTION
NAME	VQFN NO.	TSSOP NO.		
VLED	16	30	Power	Power input for high-side switches
NC	17, 18, 19, 20, 21	27, 29	-	No internal connection
CS9	22	34	O	Current sink 9. If not used, this pin must be left floating.
CS10	23	35	O	Current sink 10. If not used, this pin must be left floating.
CS11	24	36	O	Current sink 11. If not used, this pin must be left floating.
CS12	25	37	O	Current sink 12. If not used, this pin must be left floating.
CS13	26	38	O	Current sink 13. If not used, this pin must be left floating.
CS14	27	1	O	Current sink 14. If not used, this pin must be left floating.
CS15	28	2	O	Current sink 15. If not used, this pin must be left floating.
CS16	29	3	O	Current sink 16. If not used, this pin must be left floating.
CS17	30	4	O	Current sink 17. If not used, this pin must be left floating.
AGND	31	5	Ground	Analog ground. Must be connected to exposed thermal pad and common ground plane.
VCAP	32	6	O	Internal LDO output. A 1- μ F capacitor must be connected between this pin with GND. Place the capacitor as close to the device as possible.
IFS	33	7	I	Interface type select. I ² C is selected when IFS is low. SPI is selected when IFS is high. A resistor must be connected between VIO and this pin.
VSYNC	34	8	I	External synchronize signal for display mode 2 and mode 3
SCL_SCLK	35	9	I	I ² C clock input or SPI clock input. Pull up to VIO when configured as I ² C.
SDA_MOSI	36	10	I/O	I ² C data input or SPI leader output follower input. Pull up to VIO when configured as I ² C.
ADDR0_MISO	37	11	I/O	I ² C address select 0 or SPI leader input follower output
ADDR1_SS	38	12	I	I ² C address select 1 or SPI follower select
VIO_EN	39	13	Power,I	Power supply for digital circuits and chip enable. A 1-nF capacitor must be connected between this pin with GND and be placed as close to the device as possible.
VCC	40	14	Power	Power supply for device. A 1- μ F capacitor must be connected between this pin with GND and be placed as close to the device as possible.
GND	Exposed Thermal Pad	/	Ground	Must be connected to AGND and common ground plane

7 Specifications

7.1 Absolute Maximum Ratings

over operating free-air temperature range (unless otherwise noted)⁽¹⁾

		MIN	MAX	UNIT
Voltage on V _{CC} / V _{LED} / VIO / EN / CS / SW / SDA / SCL / SCLK / MOSI / MISO / SS / ADDR0 / ADDR1 / VSYNC / IFS		- 0.3	6	V
Voltage on VCAP		- 0.3	2	V
T _J	Junction temperature	- 55	150	°C
T _{stg}	Storage temperature	- 65	150	°C

- (1) Operation outside the Absolute Maximum Ratings may cause permanent device damage. Absolute Maximum Ratings do not imply functional operation of the device at these or any other conditions beyond those listed under Recommended Operating Conditions. If used outside the Recommended Operating Conditions but within the Absolute Maximum Ratings, the device may not be fully functional, and this may affect device reliability, functionality, performance, and shorten the device lifetime.

7.2 ESD Ratings

			VALUE	UNIT
V _(ESD)	Electrostatic discharge	Human body model (HBM), per ANSI/ESDA/ JEDEC JS-001, all pins ⁽¹⁾	±3000	V
		Charged device model (CDM), per ANSI/ESDA/ JEDEC JS-002, all pins ⁽²⁾	±1000	

- (1) JEDEC document JEP155 states that 500-V HBM allows safe manufacturing with a standard ESD control process.
(2) JEDEC document JEP157 states that 250-V CDM allows safe manufacturing with a standard ESD control process.

7.3 Recommended Operating Conditions

over operating free-air temperature range (unless otherwise noted)

		MIN	NOM	MAX	UNIT
Input voltage on V _{CC}	Supply voltage	2.7		5.5	V
Input voltage on V _{LED}	LED supply voltage	2.7		5.5	V
Input voltage on VIO_EN		1.65		5.5	V
Voltage on SDA / SCL / SCLK / MOSI / MISO / SS / ADDR _x / VSYNC / IFS				VIO	V
T _A	Operating ambient temperature	- 40		85	°C
T _A	Operating ambient temperature - LP5860MRKPR, LP5864MRSMR, and LP5866MDBTR only	- 55		125	°C

7.4 Thermal Information

THERMAL METRIC		LP5860, LP5868, LP5866	UNIT
		RKP (VQFN)	
		40 PINS	
R _{θJA}	Junction-to-ambient thermal resistance	31.4	°C/W
R _{θJC(top)}	Junction-to-case (top) thermal resistance	22.9	°C/W
R _{θJB}	Junction-to-board thermal resistance	12.0	°C/W
Ψ _{JT}	Junction-to-top characterization parameter	0.3	°C/W
Ψ _{JB}	Junction-to-board characterization parameter	12.0	°C/W
R _{θJC(bot)}	Junction-to-case (bottom) thermal resistance	3.5	°C/W

7.5 Electrical Characteristics

$V_{CC} = 3.3V$, $V_{LED} = 3.8V$, $V_{IO} = 1.8V$ and $T_A = -40^{\circ}C$ to $+85^{\circ}C$ ($T_A = -55^{\circ}C$ to $+125^{\circ}C$ for LP5860MRKPR, LP5864MRKPR, and LP5866MDBTR); Typical values are at $T_A = 25^{\circ}C$ (unless otherwise specified)

PARAMETER		TEST CONDITIONS	MIN	TYP	MAX	UNIT
Power supplies						
V_{CC}	Device supply voltage		2.7		5.5	V
V_{UVR}	Undervoltage restart	V_{CC} rising, Test mode			2.5	V
V_{UVF}	Undervoltage shutdown	V_{CC} falling, Test mode	1.9			V
V_{UV_HYS}	Undervoltage shutdown hysteresis			0.3		V
V_{CAP}	Internal LDO output	$V_{CC} = 2.7V$ to $5.5V$		1.78		V
I_{CC}	Shutdown supply current $I_{SHUTDOWN}$	$V_{EN} = 0V$, $CHIP_EN = 0$ (bit), measure the total current from V_{CC} and V_{LED}		0.1	1	μA
	Standby supply current $I_{STANDBY}$	$V_{EN} = 3.3V$, $CHIP_EN = 0$ (bit), measure the total current from V_{CC} and V_{LED}		5.5	10	μA
	Active mode supply current I_{NORMAL}	$V_{EN} = 3.3V$, $CHIP_EN = 1$ (bit), all channels $I_{OUT} = 5$ mA (MC = 1, CC = 127, DC = 256), measure the current from V_{CC}		4.3	6	mA
V_{LED}	LED supply voltage		2.7		5.5	V
V_{VIO}	VIO supply voltage		1.65		5.5	V
I_{VIO}	VIO supply current	Interface idle			5	μA
Output Stages						
I_{CS}	Constant current sink output range (CS0 - CS17)	$2.7 \leq V_{CC} < 3.3V$, PWM = 100%	0.1		40	mA
		$V_{CC} \geq 3.3V$ PWM = 100%	0.1		50	mA
I_{LKG}	Leakage current (CS0 - CS17)	channels off, up_degghost = 0, $V_{CS} = 5V$		0.1	1	μA
I_{ERR_DD}	Device to device current error, $I_{ERR_DD} = (I_{AVE} - I_{SET}) / I_{SET} \times 100\%$	All channels ON. Current set to 0.1 mA. MC = 0 CC = 42 DC = 25 PWM = 100%	-7		7	%
		All channels ON. Current set to 1 mA. MC = 2 CC = 127 DC = 25 PWM = 100%	-5		5	%
		All channels ON. Current set to 10 mA. MC = 2 CC = 127 DC = 255 PWM = 100%	-3.5		3.5	%
		All channels ON. Current set to 25 mA. MC = 7 CC = 64 DC = 255 PWM = 100%	-3.5		3.5	%
		All channels ON. Current set to 50 mA. MC = 7 CC = 127 DC = 255 PWM = 100%	-3		3	%
I_{ERR_CC}	Channel to channel current error, $I_{ERR_CC} = (I_{OUTX} - I_{AVE}) / I_{AVE} \times 100\%$	All channels ON. Current set to 0.1 mA. MC = 0 CC = 42 DC = 25 PWM = 100%	-5.5		5.5	%
		All channels ON. Current set to 1 mA. MC = 2 CC = 127 DC = 25 PWM = 100%	-5		5	%
		All channels ON. Current set to 10 mA. MC = 2 CC = 127 DC = 255 PWM = 100%	-4		4	%
		All channels ON. Current set to 25 mA. MC = 7 CC = 64 DC = 255 PWM = 100%	-3.5		3.5	%
		All channels ON. Current set to 50 mA. MC = 7 CC = 127 DC = 255 PWM = 100%	-3		3	%
f_{PWM}	LED PWM frequency	PWM_Fre = 1, PWM = 100%		62.5		KHz
		PWM_Fre = 0, PWM = 100%		125		KHz

7.5 Electrical Characteristics (continued)

$V_{CC} = 3.3V$, $V_{LED} = 3.8V$, $V_{IO} = 1.8V$ and $T_A = -40^{\circ}C$ to $+85^{\circ}C$ ($T_A = -55^{\circ}C$ to $+125^{\circ}C$ for LP5860MRKPR, LP5864MRKPR, and LP5866MDBTR); Typical values are at $T_A = 25^{\circ}C$ (unless otherwise specified)

PARAMETER		TEST CONDITIONS	MIN	TYP	MAX	UNIT
V_{SAT}	Output saturation voltage	$I_{OUT} = 50mA$, decreasing output voltage, when the LED current has dropped 5%			0.45	V
		$I_{OUT} = 30mA$, decreasing output voltage, when the LED current has dropped 5%			0.4	V
		$I_{OUT} = 10mA$, decreasing output voltage, when the LED current has dropped 5%			0.35	V
R_{SW}	High-side PMOS ON resistance	$V_{LED} = 2.7V$, $I_{SW} = 200mA$		450	550	$m\Omega$
		$V_{LED} = 2.7V$, $I_{SW} = 200mA$, LP5860MRKPR and LP5864MRSMR		450	570	$m\Omega$
		$V_{LED} = 3.8V$, $I_{SW} = 200mA$		380	500	$m\Omega$
		$V_{LED} = 3.8V$, $I_{SW} = 200mA$, LP5860MRKPR and LP5864MRSMR		380	520	$m\Omega$
		$V_{LED} = 5V$, $I_{SW} = 200mA$		310	450	$m\Omega$
		$V_{LED} = 5V$, $I_{SW} = 200mA$, LP5860MRKPR and LP5864MRSMR		310	490	$m\Omega$
Logic Interfaces						
V_{LOGIC_IL}	Low-level input voltage, SDA, SCL, SCLK, MOSI, SS, ADDR _x , VSYNC, IFS			$0.3 \times V_{IO}$		V
V_{LOGIC_IH}	High-level input voltage, SDA, SCL, SCLK, MOSI, SS, ADDR _x , VSYNC, IFS		$0.7 \times V_{IO}$			V
V_{EN_IL}	Low-level input voltage of EN			0.4		V
V_{EN_IH}	High-level input voltage of EN	When V_{CAP} powered up	1.4			V
I_{LOGIC_I}	Input current, SDA, SCL, SCLK, MOSI, SS, ADDR _x		-1		1	μA
V_{LOGIC_OL}	Low-level output voltage, SDA, MISO	$I_{PULLUP} = 3mA$			0.4	V
V_{LOGIC_OH}	High-level output voltage, MISO	$I_{PULLUP} = -3mA$	$0.7 \times V_{IO}$			V
Protection Circuits						
V_{LOD_TH}	Thershold for channel open detection			0.25		V
V_{LSD_TH}	Thershold for channel short detection			$V_{LED} - 1$		V
T_{TSD}	Thermal-shutdown junction temperature			150		$^{\circ}C$
T_{HYS}	Thermal shutdown temperature hysteresis			15		$^{\circ}C$

7.6 Timing Requirements

		MIN	NOM	MAX	UNIT
MISC. Timing Requirements					
f_{OSC}	Internal oscillator frequency		31.2		MHz
f_{OSC_ERR}	Device to device oscillator frequency error	-3%		3%	
t_{POR_H}	Wait time from UVLO disactive to device NORMAL			500	μs
t_{CHIP_EN}	Wait time from setting Chip_EN (Register) =1 to device NORMAL			100	μs
t_{RISE}	LED output rise time		10		ns
t_{FALL}	LED output fall time		15		ns
t_{VSYNC_H}	The minimum high-level pulse width of VSYNC	200			μs
SPI timing requirements					

7.6 Timing Requirements (continued)

		MIN	NOM	MAX	UNIT
f _{SCLK}	SPI Clock frequency			12	MHz
1	Cycle time	83.3			ns
2	SS active lead-time	50			ns
3	SS active leg time	50			ns
4	SS inactive time	50			ns
5	SCLK low time	36			ns
6	SCLK high time	36			ns
7	MOSI set-up time	20			ns
8	MOSI hold time	20			ns
9	MISO disable time			30	ns
10	MISO data valid time			35	ns
C _b	Bus capacitance	5		40	pF
I²C fast mode timing requirements					
f _{SCL}	I ² C clock frequency	0		400	KHz
1	Hold time (repeated) START condition	600			ns
2	Clock low time	1300			ns
3	Clock high time	600			ns
4	Setup time for a repeated START condition	600			ns
5	Data hold time	0			ns
6	Data setup time	100			ns
7	Rise time of SDA and SCL			300	ns
8	Fall time of SDA and SCL			300	ns
9	Setup time for STOP condition	600			ns
10	Bus free time between a STOP and a START condition	1.3			μs
I²C fast mode plus timing requirements					
f _{SCL}	I ² C clock frequency	0		400	KHz
1	Hold time (repeated) START condition	600			ns
2	Clock low time	1300			ns
3	Clock high time	600			ns
4	Setup time for a repeated START condition	600			ns
5	Data hold time	0			ns
6	Data setup time	100			ns
7	Rise time of SDA and SCL			300	ns
8	Fall time of SDA and SCL			300	ns
9	Setup time for STOP condition	600			ns
10	Bus free time between a STOP and a START condition	1.3			μs

7.7 Typical Characteristics

Unless specified otherwise, typical characteristics apply over the full ambient temperature range ($-55^{\circ}\text{C} < T_A < +125^{\circ}\text{C}$ for LP5866MDBTR while $-40^{\circ}\text{C} < T_A < +85^{\circ}\text{C}$ for the other devices), $V_{CC} = 3.3\text{ V}$, $V_{IO} = 3.3\text{ V}$, $V_{LED} = 5\text{ V}$, $I_{LED_Peak} = 50\text{ mA}$, $C_{VLED} = 1\ \mu\text{F}$, $C_{VCC} = 1\ \mu\text{F}$.



图 7-1. V_{CC} UVLO Rising and Falling Thresholds



图 7-2. V_{CC} UVLO Hysteresis

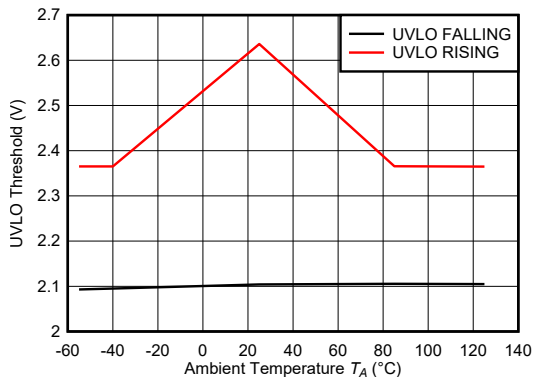

图 7-3. V_{SAT} vs Temperature

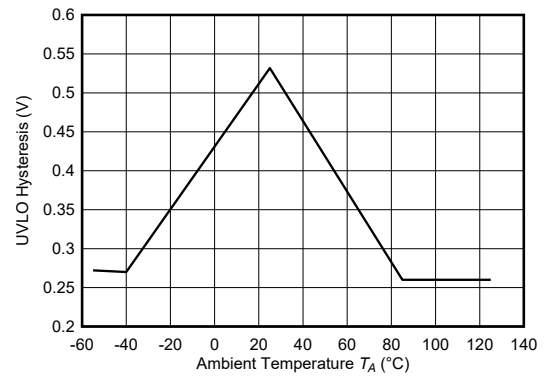

图 7-4. V_{SAT} vs. Current Sinks (50mA)

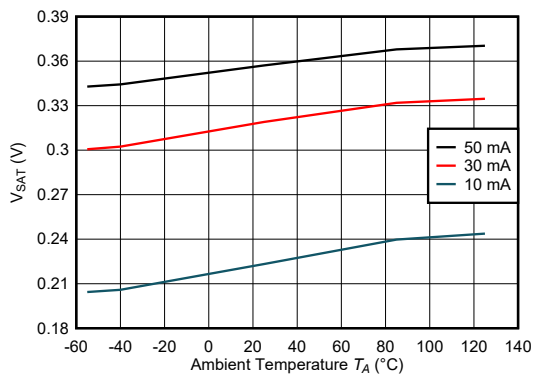

图 7-5. V_{SAT} vs Current Sinks (30 mA)

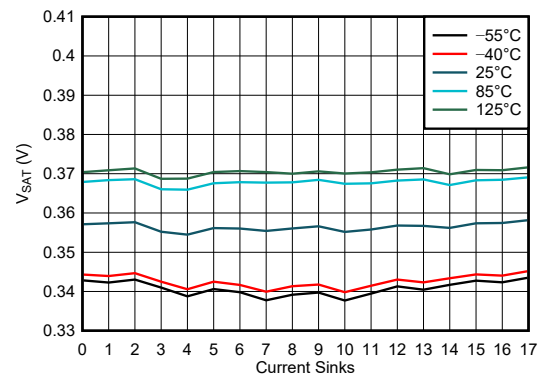

图 7-6. V_{SAT} vs Current Sinks (10 mA)

7.7 Typical Characteristics (continued)

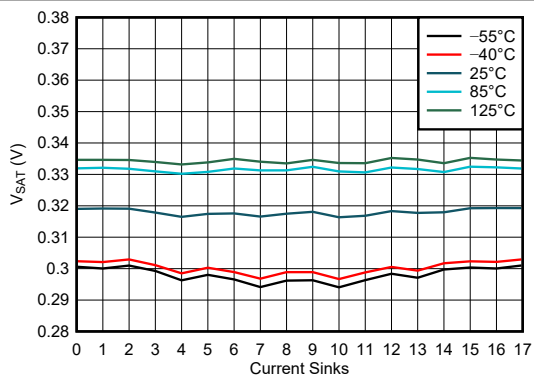
Unless specified otherwise, typical characteristics apply over the full ambient temperature range ($-55^{\circ}\text{C} < T_A < +125^{\circ}\text{C}$ for LP5866MDBTR while $-40^{\circ}\text{C} < T_A < +85^{\circ}\text{C}$ for the other devices), $V_{CC} = 3.3\text{ V}$, $V_{IO} = 3.3\text{ V}$, $V_{LED} = 5\text{ V}$, $I_{LED_Peak} = 50\text{ mA}$, $C_{VLED} = 1\ \mu\text{F}$, $C_{VCC} = 1\ \mu\text{F}$.

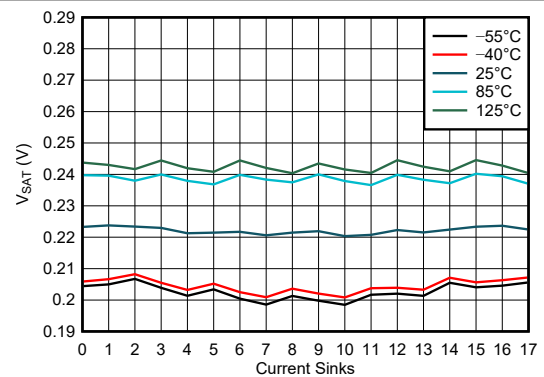
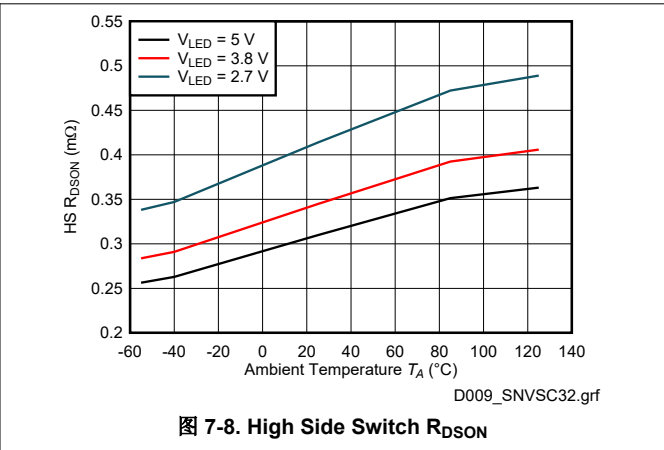
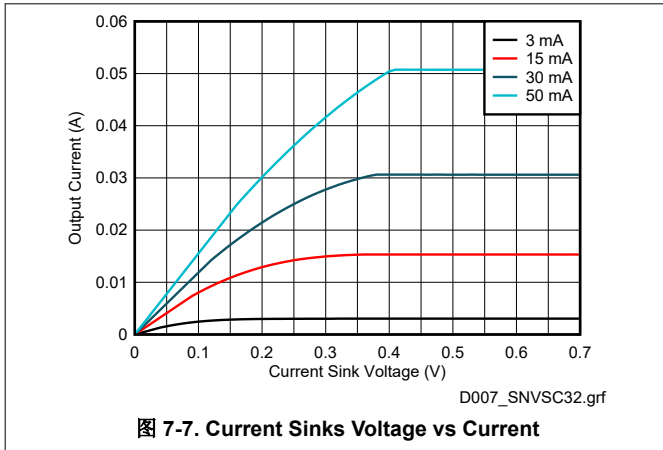

8 Detailed Description

8.1 Overview

The LP5866 is an 6 × 18 LED matrix driver. The device integrates 6 switching FETs with 18 constant current sinks. One LP5866 device can drive up to 108 LED dots or 36 RGB pixels by using time-multiplexing matrix scheme.

The LP5866 supports both analog dimming and PWM dimming methods. For analog dimming, the current gain of each individual LED dot can be adjusted with 256 steps through 8-bits dot correction. For PWM dimming, the integrated 8-bits or 16-bits configurable, > 20-KHz PWM generators for each LED dot enable smooth, vivid animation effects without audible noise. Each LED can also be mapped into a 8-bits group PWM to achieve the group control with minimum data traffic.

The LP5866 device implements full addressable SRAM. The device supports entire SRAM data refresh and partial SRAM data update on demand to minimize the data traffic. The LP5866 implements the ghost cancellation circuit to eliminate both upside and downside ghosting. The LP5866 also uses low brightness compensation technology to support high density LED pixels. Both 1-MHz (maximum) I²C and 12-MHz (maximum) SPI interfaces are available in the LP5866.

8.2 Functional Block Diagram

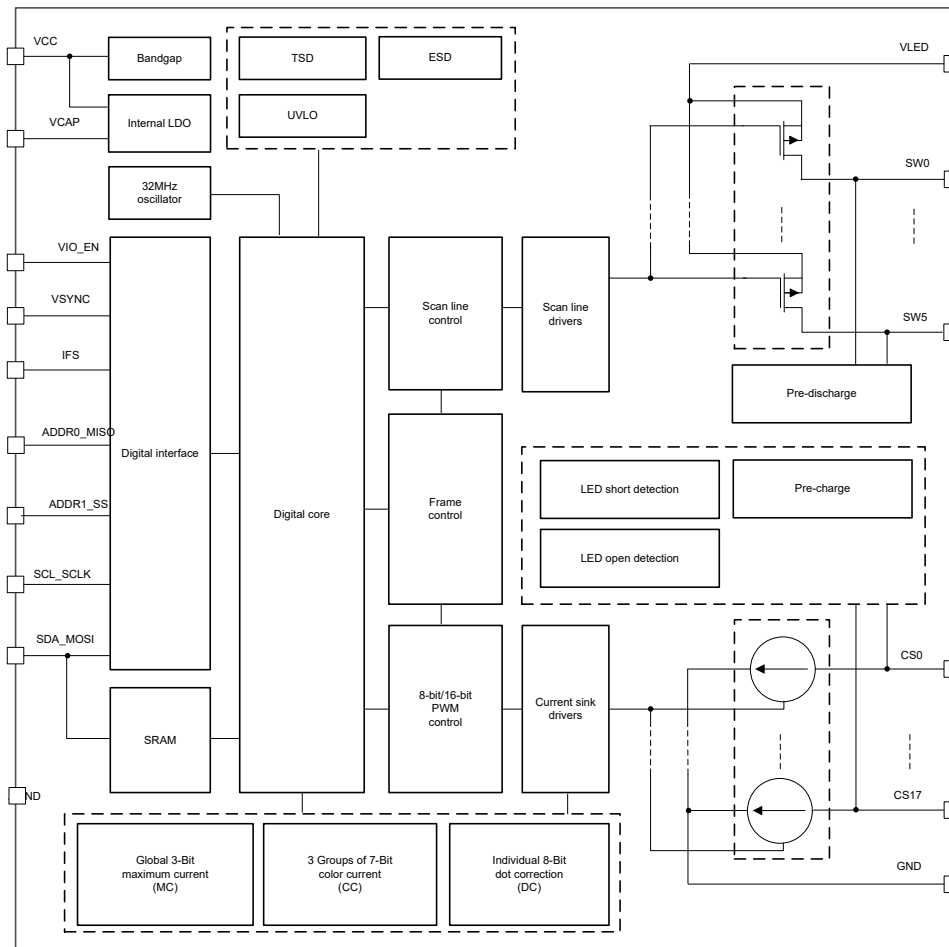

8.3 Feature Description

8.3.1 Time-Multiplexing Matrix

The LP5866 device uses time-multiplexing matrix scheme to support up to 108 LED dots with a single chip. The device integrates 18 current sinks with 6 scan lines to drive 18 × 6 = 108 LED dots or 6 × 6 = 36 RGB pixels. In matrix control scheme, the device scans from Line 0 to Line 5 sequentially as shown in 图 8-1. Current gain and PWM duty registers are programmable for each LED dot to support individual analog and PWM dimming.



图 8-1. Scan Line Control Scheme

There are 6 high-side p-channel MOSFETs (PMOS) integrated in LP5866 device. Users can flexibly set the active scan numbers from 1 to 6 by configuring the 'Max_Line_Num' in Dev_initial register. The time-multiplexing matrix timing sequence follows the 图 8-2.

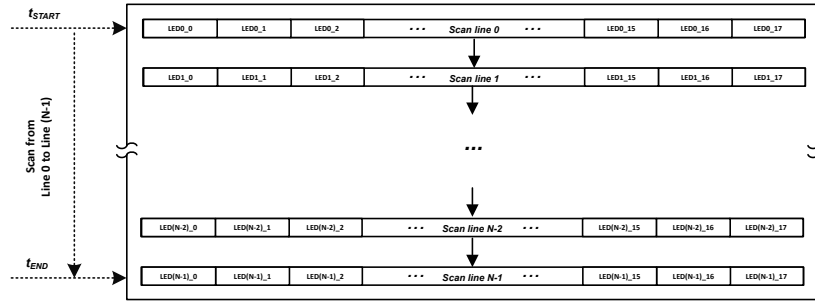

图 8-2. Time-Multiplexing Matrix Timing Sequence

One cycle time of the line switching can be calculated as below:

$$t_{line_switch} = t_{PWM} + t_{SW_BLK} + 2 \times t_{phase_shift} \tag{1}$$

- t_{PWM} is the current sink active time, which equals to 8 us (PWM frequency set at 125 kHz) or 16 us (PWM frequency set at 62.5 kHz) by configuring 'PWM_Fre' in Dev_initial register.
- t_{SW_BLK} is the switch blank time, which equals to 1 us or 0.5 us by configuring 'SW_BLK' in Dev_config1 register.
- t_{phase_shift} is the PWM phase shift time, which equal to 0 or 125 ns by configuring 'PWM_Phase_Shift' in Dev_config1 register.

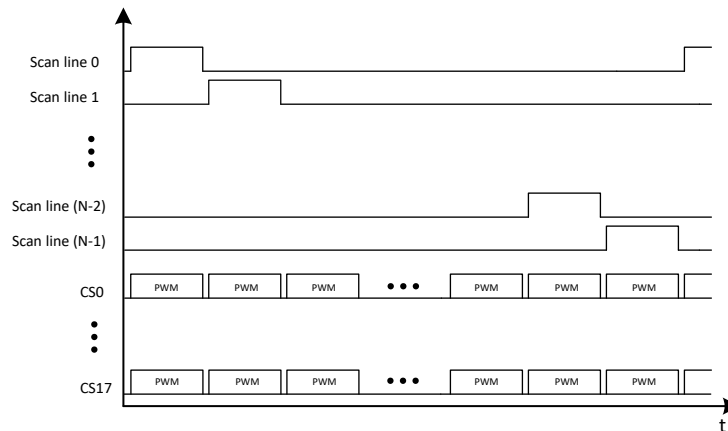
Total display time for one complete sub-period is t_{sub_period} and it can be calculated by the following equation:

$$t_{sub_period} = t_{line_switch} \times Scan_line\# \tag{2}$$

- Scan_line# is the scan line number determined by 'Max_Line_Num' in Dev_initial register.

The time-multiplexing matrix scheme time diagram is shown in 图 8-3. The $t_{CS_ON_Shift}$ is the current sink turning on shift by configuring 'CS_ON_Shift' bit in Dev_config1 register.



图 8-3. Time-Multiplexing Matrix Timing Diagram

The LP5866 device implements deghosting and low brightness compensation to remove the side effects of matrix topology:

- **Deghosting:** Both upside deghosting and downside deghosting are implemented to eliminate the LED's unexpected weak turn-on.
 - Upside_deghosting: discharge each scan line during its off state. By configuring the 'Up_Deghost' in Dev_config3 register, the LP5866 discharges and clamps the scan line switch to a certain voltage.
 - Downside_deghosting: pre-charge each current sink voltage during its OFF state. The deghosting capability can be adjusted through the 'Down_Deghost' in Dev_config3 register.
- **Low Brightness Compensation:** three groups compensation are implemented to overcome the color-shift and non-uniformity in low brightness conditions. The compensation capability can be through 'Comp_Group1', 'Comp_Group2', and 'Comp_Group3' in Dev_config2 register.
 - Compensation_group 1: CS0, CS3, CS6, CS9, CS12, CS15.
 - Compensation_group 2: CS1, CS4, CS7, CS10, CS13, CS16.
 - Compensation_group 3: CS2, CS5, CS8, CS11, CS14, CS17.

8.3.2 Analog Dimming (Current Gain Control)

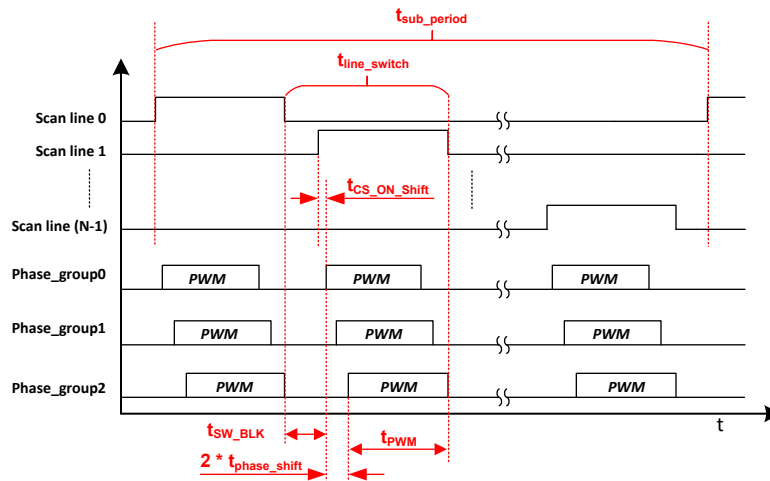
Analog dimming of LP5866 is achieved by configuring the current gain control. There are several methods to control the current gain of each LED.

- Global 3-bits Maximum Current (MC) setting without external resistor
- 3 groups of 7-bits Color Current (CC) setting
- Individual 8-bit Dot Current (DC) setting

Global 3-Bits Maximum Current (MC) Setting

The MC is used to set the maximum current I_{OUT_MAX} for each current sink and this current is the maximum peak current for each LED dot. The MC can be set with 3 bits (8 steps) from 3 mA to 50 mA. When the device is powered on, the MC data is set to default value, which is 15 mA.

For data refresh **Mode 1**, MC data is effective immediately after new data is updated. For **Mode 2** and **Mode 3**, to avoid unexpected MC data change during high speed data refreshing, MC data must be changed when all channels are off and new MC data is only be updated when the 'Chip_EN' bit in Chip_en register is set to 0, and after the 'Chip_EN' returns to 1, the new MC data is effective. 'Down_Deghost' and 'Up_Deghost' in Dev_config3 work in the similar way with MC.

表 8-1. Maximum Current (MC) Register Setting

3-BITS MAXIMUM_CURRENT REGISTER		I _{OUT_MAX}
Binary	Decimal	mA
000	0	3
001	1	5
010	2	10
011 (Default)	3 (Default)	15 (Default)
100	4	20
101	5	30
110	6	40
111	7	50

3 Groups of 7-Bits Color Current (CC) Setting

The LP5866 device is able to adjust the output current of three color groups separately. For each color, the device has 7-bits data in 'CC_Group1', 'CC_Group2', and 'CC_Group3'. Thus, all color group currents can be adjusted in 128 steps from 0% to 100% of the maximum output current, I_{OUT_MAX}.

The 18 current sinks have fixed mapping to the three color groups:

- CC-Group 1: CS0, CS3, CS6, CS9, CS12, CS15.
- CC-Group 2: CS1, CS4, CS7, CS10, CS13, CS16.
- CC-Group 3: CS2, CS5, CS8, CS11, CS14, CS17.

表 8-2. 3 Groups of 7-bits Color Current (CC) Setting

7-BITS CC_GROUP1/CC_GROUP2/CC_GROUP3 REGISTER		RATIO OF OUTPUT CURRENT TO I _{OUT_MAX}
Binary	Decimal	%
000 0000	0	0
000 0001	1	0.79
000 0010	2	1.57
---	---	---
100 0000 (default)	64 (default)	50.4 (default)
---	---	---
111 1101	125	98.4
111 1110	126	99.2
111 1111	127	100

Individual 8-bit Dot Current (DC) Setting

The LP5866 can individually adjust the output current of each LED by using dot current function through DC setting. The device allows the brightness deviations of the LEDs to adjusted be individually. Each output DC is programmed with a 8-bit depth, so the value can be adjusted with 256 steps within the range from 0% to 100% of (I_{OUT_MAX} × CC/127).

表 8-3. Individual 8-bit Dot Current (DC) Setting

8-BIT DC REGISTER		RATIO OF OUTPUT CURRENT TO I _{OUT_MAX} × CC/127
Binary	Decimal	%
0000 0000	0	0
0000 0001	1	0.39
0000 0010	2	0.78
---	---	---
1000 0000 (Default)	128 (Default)	50.2 (Default)

表 8-3. Individual 8-bit Dot Current (DC) Setting (continued)

8-BIT DC REGISTER		RATIO OF OUTPUT CURRENT TO $I_{OUT_MAX} \times CC/127$	
Binary	Decimal	%	
---	---	---	
1111 1101	253	99.2	
1111 1110	254	99.6	
1111 1111	255	100	

In summary, the current gain of each current sink can be calculated as below:

$$I_{OUT} \text{ (mA)} = I_{OUT_MAX} \times (CC/127) \times (DC/255) \quad (3)$$

For time-multiplexing scan scheme, if the scan number is N, each LED dot's average current I_{AVG} is shown as below:

$$I_{AVG} \text{ (mA)} = I_{OUT}/N = I_{OUT_MAX} \times (CC/127) \times (DC/255)/N \quad (4)$$

8.3.3 PWM Dimming

There are several methods to control the PWM duty cycle of each LED dot.

- **Individual 8-bit / 16-bit PWM for Each LED Dot**

Every LED has an individual 8-bit or 16-bit PWM register that is used to change the LED brightness by PWM duty. The LP5866 uses an enhanced spectrum PWM (ES-PWM) algorithm to achieve 16-bit depth with high refresh rate and this can avoid flicker under high speed camera. Comparing with conventional 8-bit PWM, 16-bit PWM can help to achieve ultimate high dimming resolution in LED animation applications.

- **3 Programmable Groups of 8-bit PWM Dimming**

The group PWM Control is used to select LEDs into 1 to 3 groups where each group has a separate register for duty cycle control. Every LED has 2-bit selection in LED_DOT_GROUP Registers (x = 0, 1, ..., 54.) to select whether it belongs to one of the three groups or not:

- 00: not a member of any group
- 01: member of group 1
- 10: member of group 2
- 11: member of group 3

- **8-bit PWM for Global Dimming**

The Global PWM Control function affects all LEDs simultaneously.

The final PWM duty cycle can be calculated as below:

$$PWM_Final(8\text{-bit}) = PWM_Individual(8\text{-bit}) \times PWM_Group(8\text{-bit}) \times PWM_Global(8\text{-bit}) \quad (5)$$

$$PWM_Final(16\text{-bit}) = PWM_Individual(16\text{-bit}) \times PWM_Group(8\text{-bit}) \times PWM_Global(8\text{-bit}) \quad (6)$$

The LP5866 supports 125-kHz or 62.5-kHz PWM output frequency. The PWM frequency is selected by configuring the 'PWM_Fre' in Dev_initial register. An internal 31.2-MHz oscillator is used for generating PWM outputs. The oscillator's high accuracy design ($f_{OSC_ERR} \leq \pm 2\%$) enables a better synchronization if multiple LP5866 devices are connected together.

A PWM phase-shifting scheme is implemented in each current sink to avoid the current overshoot when turning on simultaneously. As the LED drivers are not activated simultaneously, the peak load current from the pre-stage power supply is significantly decreased. This scheme also reduces input-current ripple and ceramic-capacitor audible ringing. LED drivers are grouped into three different phases. By configuring the 'PWM_Phase_Shift' in Dev_config1 register, which is default off, the LP5866 supports $t_{phase_shift} = 125\text{-ns}$ shifting time shown in 图 8-4.

- Phase 1: CS0, CS3, CS6, CS9, CS12, CS15.
- Phase 2: CS1, CS4, CS7, CS10, CS13, CS16.
- Phase 3: CS2, CS5, CS8, CS11, CS14, CS17.



图 8-4. Phase Shift

To avoid high current sinks output ripple during line switching, current sinks can be configured to turn on with 1 clock delay (62.5 ns or 31.25 ns according to the PWM frequency) after lines turn on, as shown in 图 8-3. This function can be configured by 'CS_ON_Shift' in Dev_config1 register.

The LP5866 allows users to configure the dimming scale either exponentially (Gamma Correction) or linearly through the 'PWM_Scale_Mode' in Dev_config1 register. If a human-eye-friendly dimming curve is desired, using the internal fixed exponential scale is an easy approach. If a special dimming curve is desired, TI recommends using the linear scale with software correction. The LP5866 supports both linear and exponential dimming curves under 8-bit and 16-bit PWM depth. 图 8-5 is an example of 8-bit PWM depth.

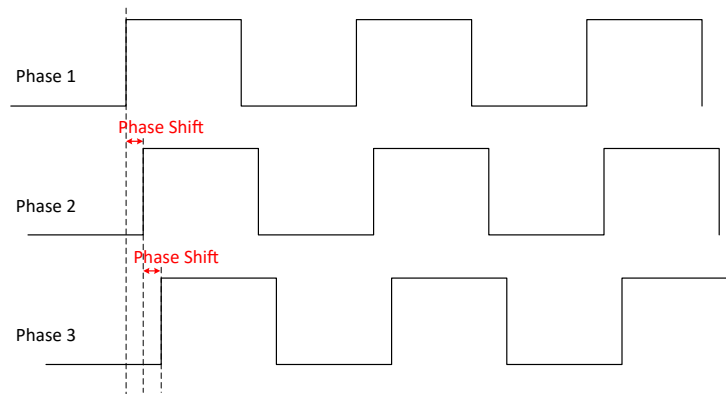

图 8-5. Linear and Exponential Dimming Curves

In summary, the PWM control method is illustrated as 图 8-6:

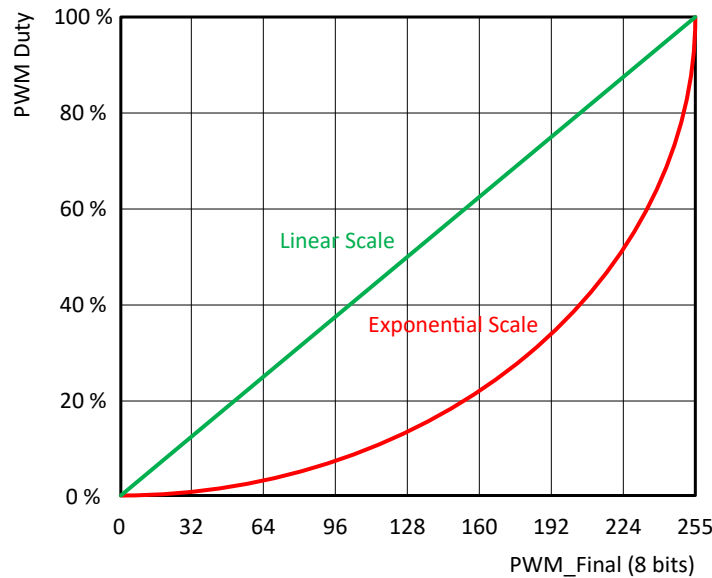

图 8-6. PWM Control Scheme

8.3.4 ON and OFF Control

The LP5866 device supports the individual ON and OFF control of each LED. For indication purpose, users can turn on and off the LED directly by writing 1-bit ON and OFF data to the corresponding Dot_onoffx (x = 0, 1, ..., 32) register.

8.3.5 Data Refresh Mode

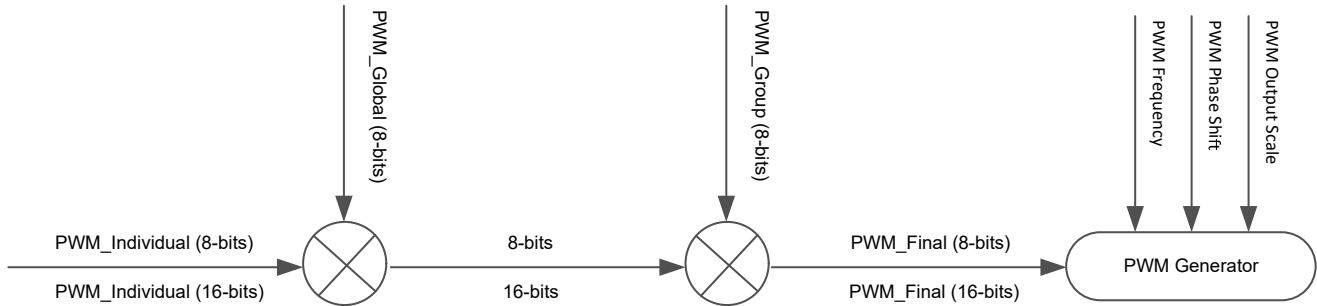
The LP5866 supports three data refresh modes: Mode 1, Mode 2, and Mode 3, by configuring 'Data_Ref_Mode' in Dev_initial register.

Mode 1: 8-bit PWM data without VSYNC command. Data is sent out for display instantly after received. With Mode 1, users can refresh the corresponding dots' data only instead of updating the whole SRAM. It is called 'on demand data refresh', which can save the total data volume effectively. As shown in 图 8-7, the red LED dots can be refreshed after sending the corresponding data while the others kept the same with last frame.



图 8-7. On Demand Data Refresh - Mode 1

Mode 2: 8-bit PWM data with VSYNC command. Data is held and sent out simultaneously by frame after receiving the VSYNC command.

Mode 3: 16-bit PWM data with VSYNC command. Data is held and sent out simultaneously by frame after receiving the VSYNC command.

Frame control is implemented in Mode 2 and Mode 3. Instead of refreshing the output instantly after data is received (Mode 1), the device holds the data and refreshes the whole frame data by a fixed frame rate, f_{VSYNC} . Usually, 24 Hz, 50 Hz, 60 Hz, 120Hz or even higher frame rate is selected to achieve vivid animation effects. Whole SRAM Data Refresh is shown in 图 8-8, a new frame is updated after receiving the VSYNC command.

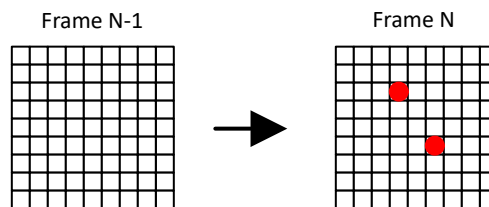

图 8-8. Whole SRAM Data Refresh

Comparing with Mode 1, Mode 2 and Mode 3 provide a better synchronization when multiple LP5866 devices used together. A high-level pulse width longer than $t_{\text{SYNC_H}}$ is required at the beginning of each VSYNC frame.   shows the VSYNC connections and  shows the timing requirements.



图 8-9. Multiple Devices Sync

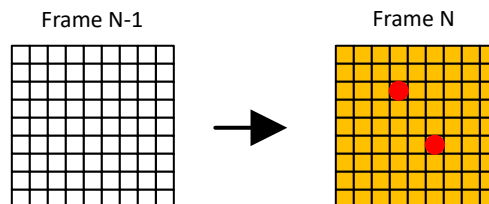
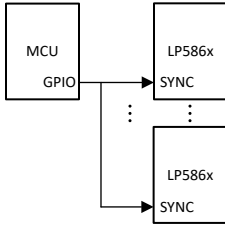
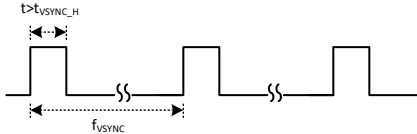
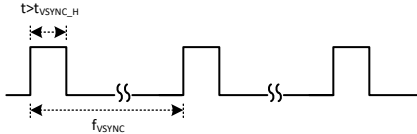

图 8-10. VSYNC Timing

Table 8-4 is the summary of the three data refresh modes.

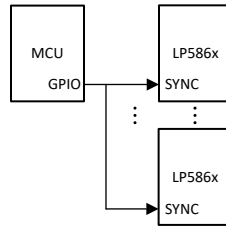
表 8-4. Data Refresh Mode

MODE TYPE	PWM RESOLUTION	PWM OUTPUT	EXTERNAL VSYNC
Mode 1	8 Bits	Data update instantly	No
Mode 2	8 Bits	Data update by frame	Yes
Mode 3	16 Bits		

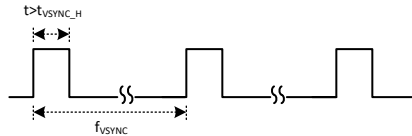
8.3.6 Full Addressable SRAM

SRAM is implemented inside the LP5866 device to support data writing and reading at the same time.

Although data refresh mechanisms are not the same for Mode 1 and Mode 2, and Mode 3, the data writing and reading follow the same method. Users can update partial of the SRAM data only or the whole SRAM page simultaneously. The LP5866 supports auto-increment function to minimize data traffic and increase data transfer efficiency.

Please note that 16-bit PWM (Mode 3) and 8-bit PWM (Mode 1 and Mode 2) are assigned with different SRAM addresses.

8.3.7 Protections and Diagnostics

LED Open Detection

The LP5866 includes LED open detection (LOD) for the fault caused by any opened LED dot. The threshold for LED open is 0.25-V typical. LED open detection is only performed when $\text{PWM} \geq 25$ (Mode 1 and Mode 2) or $\text{PWM} \geq 6400$ (Mode 3) and voltage on CS_n is detected lower than open threshold for continuously 4 sub-periods.

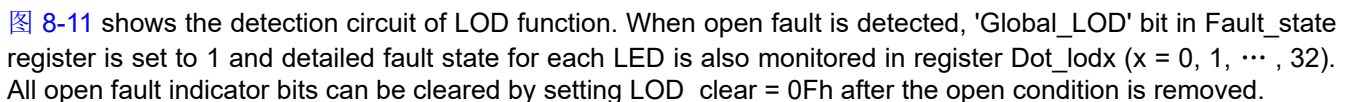
 shows the detection circuit of LOD function. When open fault is detected, 'Global_LOD' bit in Fault_state register is set to 1 and detailed fault state for each LED is also monitored in register Dot_lodx (x = 0, 1, ..., 32). All open fault indicator bits can be cleared by setting LOD_clear = 0Fh after the open condition is removed.

LOD removal function can be enabled by setting 'LOD_removal' bit in Dev_config2 register to 1. This function turns off the current sink of the open channel when scanning to the line where the opened LED is included.



图 8-11. LOD Circuits

LED Short Detection

The LP5866 includes LED short detection (LSD) for the fault caused by any shorted LED. Threshold for channel short is $(V_{LED} - 1) V$ typical. LED short detection only performed when $PWM \geq 25$ (Mode 1 and Mode 2) or $PWM \geq 6400$ (Mode 3) and voltage on CSn is detected higher than short threshold for continuously 4 sub-periods. As there is parasitic capacitance for the current sink, to make sure the LSD result is correct, TI recommends to set the LED current higher than 0.5 mA.

图 8-12 shows the detection circuit of LSD function. When short fault is detected, 'Global_LSD bit' in Fault_state register is set to 1 and detailed fault state for every channel can also be monitored in register Dot_Isdx ($x = 0, 1, \dots, 32$). All short fault indicator bits can be cleared by setting LSD_clear = 0Fh after the short condition is removed.

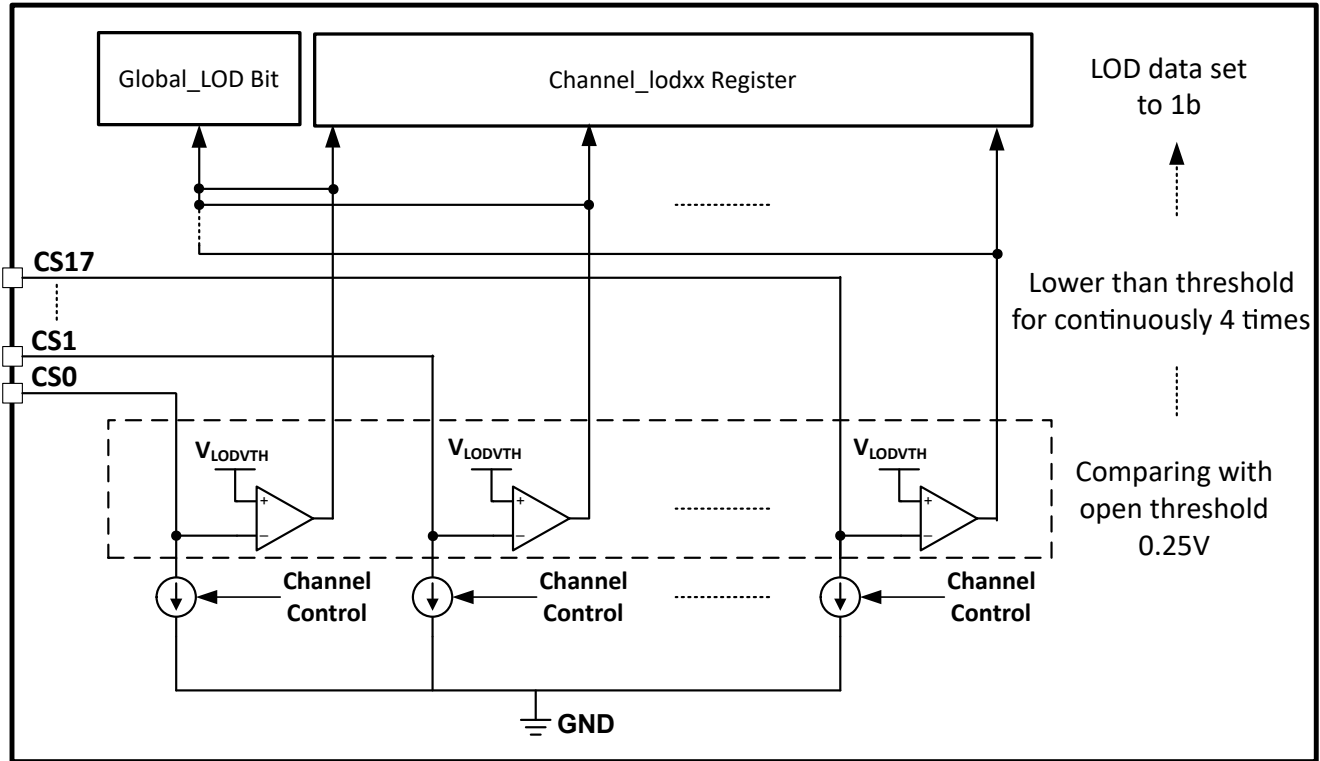
LSD removal function can be enabled by setting 'LSD_removal' bit in Dev_config2 register to 1. This function turns off the upside deghosting function of the scan line where short LED is included.



图 8-12. LSD Circuit

Thermal Shutdown

The LP5866 device implements thermal shutdown mechanism to protect the device from damage due to overheating. When the junction temperature rises to 160°C (typical) and above, the device switches into shutdown mode. The LP5866 exits thermal shutdown when the junction temperature of the device drops to 145°C (typical) and below.

UVLO (Undervoltage Lockout)

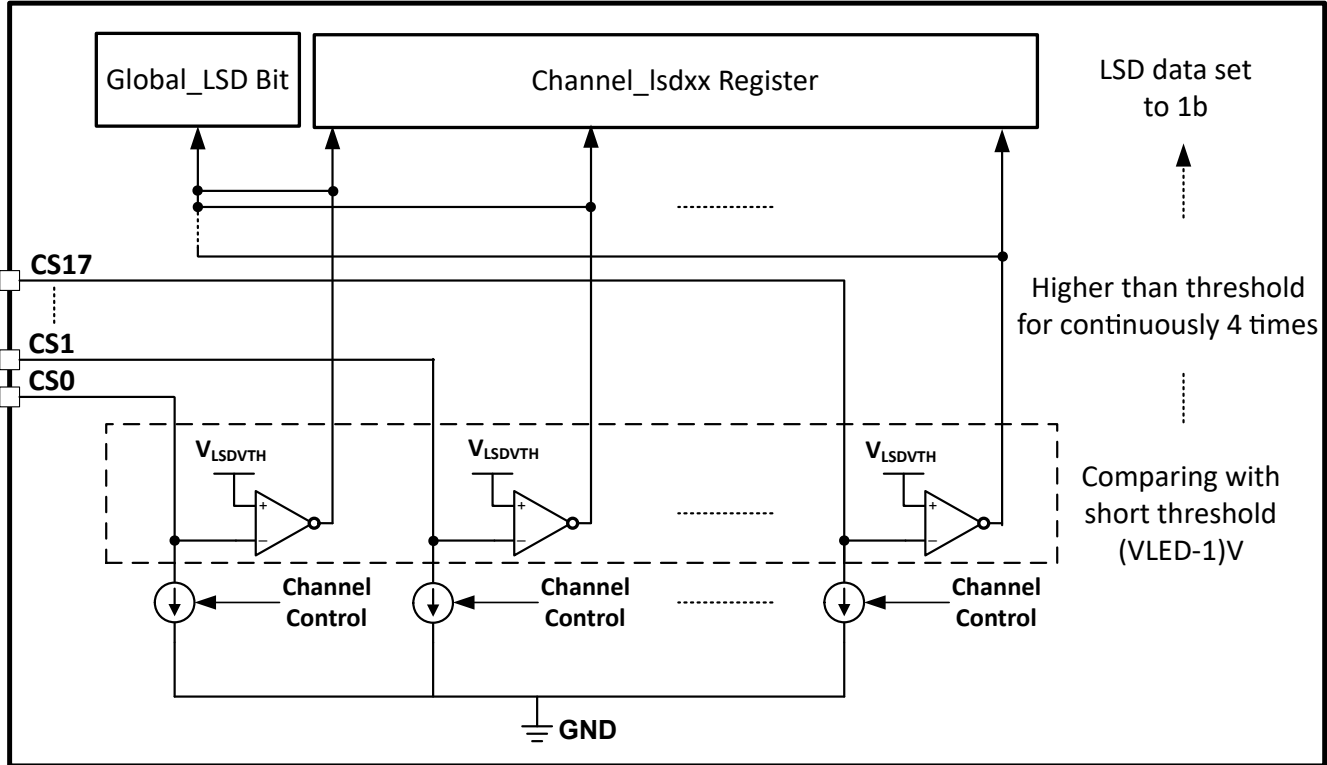
The LP5866 has an internal comparator that monitors the voltage at VCC. When VCC is below V_{UVF} , reset is active and the LP5866 enters INITIALIZATION state.

8.4 Device Functional Modes



图 8-13. Device Functional Modes

- Shutdown: The device enters into shutdown mode from all states on VCC power up or EN pin is low.
- Hardware POR: The device enters into hardware POR when Enable pin is high or VCC fall under V_{UVF} causing UVLO = H from all states.
- Software reset: The device enters into software reset mode when VCC rise higher than V_{UVR} with the time $t > t_{POR_H}$. In this mode, all the registers are reset. Entry can also be from any state when the RESET (register) = FFh or UVLO is low.
- Standby: The device enters the standby mode when Chip_EN (register) = 0. In this mode, the device enters into low power mode, but the I²C/SPI are still available for Chip_EN only and the registers' data are retained.
- Normal: The device enters the normal mode when 'Chip_EN' = 1 with the time $t > t_{CHIP_EN}$.
- Thermal shutdown: The device automatically enters the thermal shutdown mode when the junction temperature exceeds 160°C (typical). If the junction temperature decreases below 145°C (typical), the device returns to the normal mode.

8.5 Programming

Interface Selection

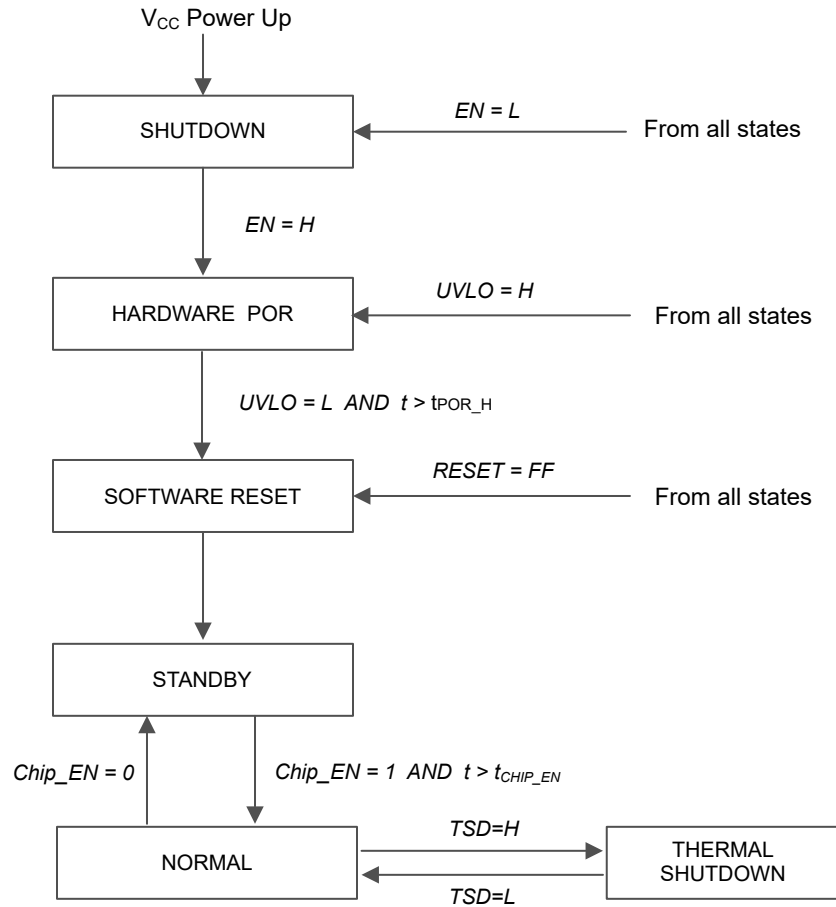
The LP5866 supports two communication interfaces: I²C and SPI. If IFS is high, it enters into SPI mode. If IFS is low, it enters into I²C mode.

表 8-5. Interface Selection

INTERFACE TYPE	ENTRY CONDITION
I ² C	IFS = Low
SPI	IFS = High

I²C Interface

The LP5866 is compatible with I²C standard specification. the device supports both fast mode (400-KHz maximum) and fast plus mode (1-MHz maximum).

I²C Data Transactions

The data on SDA line must be stable during the HIGH period of the clock signal (SCL). In other words, state of the data line can only be changed when clock signal is LOW. START and STOP conditions classify the beginning and the end of the data transfer session. A START condition is defined as the SDA signal transitioning from HIGH to LOW while SCL line is HIGH. A STOP condition is defined as the SDA transitioning from LOW to HIGH while SCL is HIGH. The bus leader always generates START and STOP conditions. The bus is considered to be busy after a START condition and free after a STOP condition. During data transmission, the bus leader can generate repeated START conditions. First START and repeated START conditions are functionally equivalent.

Each byte of data has to be followed by an acknowledge bit. The acknowledge related clock pulse is generated by the leader. The leader releases the SDA line (HIGH) during the acknowledge clock pulse. The device pulls down the SDA line during the 9th clock pulse, signifying an acknowledge. The device generates an acknowledge after each byte has been received.

There is one exception to the acknowledge after every byte rule. When the leader is the receiver, it must indicate to the transmitter an end of data by not acknowledging (*negative acknowledge*) the last byte clocked out of the follower. This negative acknowledge still includes the acknowledge clock pulse (generated by the leader), but the SDA line is not pulled down.

I²C Data Format

The address and data bits are transmitted MSB first with 8-bits length format in each cycle. Each transmission is started with Address Byte 1, which are divided into 5-bits of the chip address, 2 higher bits of the register address, and 1 read and write bit. The other 8 lower bits of register address are put in Address Byte 2. The device supports both independent mode and broadcast mode. The auto-increment feature allows writing and reading several consecutive registers within one transmission. If not consecutive, a new transmission must be started.

表 8-6. I²C Data Format

Address Byte 1	Chip Address					Register Address		R/W
	Bit 7	Bit 6	Bit 5	Bit 4	Bit 3	Bit 2	Bit 1	Bit 0
Independent	1	0	0	ADDR1	ADDR0	9 th bit	8 th bit	R: 1 W: 0
Broadcast	1	0	1	0	1			
Address Byte 2	Register Address							
	Bit 7	Bit 6	Bit 5	Bit 4	Bit 3	Bit 2	Bit 1	Bit 0
	7 th bit	6 th bit	5 th bit	4 th bit	3 th bit	2 th bit	1 th bit	0 th bit



图 8-14. I²C Write Timing



图 8-15. I²C Read Timing

Multiple Devices Connection

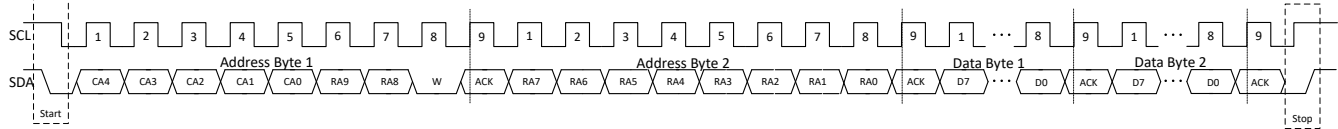
The LP5866 enters into I²C mode if IFS is connected to GND. The ADDR0/1 pin is used to select the unique I²C follower address for each device. The SCL and SDA lines must each have a pullup resistor (4.7 K Ω for 400 KHz, 2 K Ω for 1 MHz) placed somewhere on the line and remain HIGH even when the bus is idle. VIO_EN can either be connected with VIO power supply or GPIO. TI suggests to put one 1-nF cap as closer to VIO_EN pin as possible. Up to four LP5866 follower devices can share the same I²C bus by the different ADDR configurations.

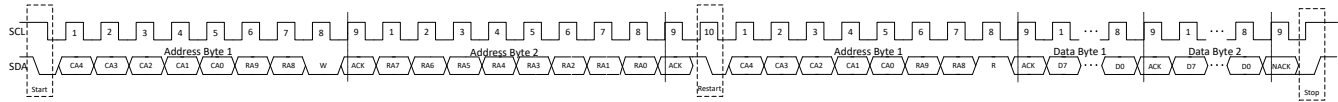

图 8-16. I²C Multiple Devices Connection

SPI Interface

The LP5866 is compatible with SPI serial-bus specification, and it operates as a follower. The maximum frequency supported by LP5866 is 12 MHz.

SPI Data Transactions

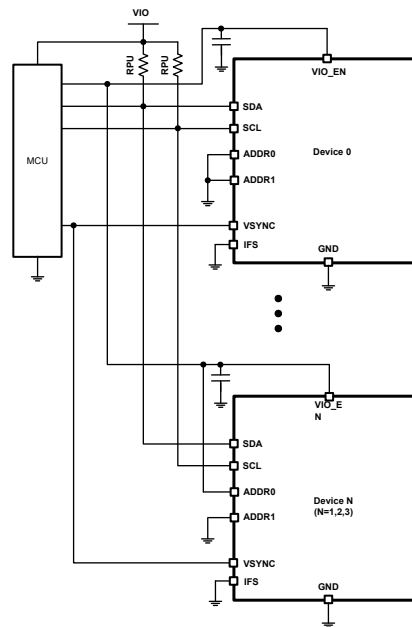
MISO output is normally in a high impedance state. When the follower-select pin SS for the device is active (low) the MISO output is pulled low for read only. During write cycle MISO stays in high-impedance state. The follower-select signal SS must be low during the cycle transmission. SS resets the interface when high. Data is clocked in on the rising edge of the SCLK clock signal, while data is clocked out on the falling edge of SCLK.

SPI Data Format

The address and data bits are transmitted MSB first with 8-bits length format in each cycle. Each transmission is started with Address Byte 1, which contains 8 higher bits of the register address. The Address Byte 2 is started with 2 lower bits of the register address and 1 read and write bit. The auto-increment feature allows writing and reading several consecutive registers within one transmission. If not consecutive, a new transmission must be started.

表 8-7. SPI Data Format

Address Byte 1	Register Address								
	Bit 7	Bit 6	Bit 5	Bit 4	Bit 3	Bit 2	Bit 1	Bit 0	
	9 th bit	8 th bit	7 th bit	6 th bit	5 th bit	4 th bit	3 th bit	2 th bit	
Address Byte 2	Register Address								
	Bit 7	Bit 6	Bit 5	Bit 4	Bit 3	Bit 2	Bit 1	Bit 0	
	1 th bit	0 th bit	R: 0 W: 1	Don't Care					



图 8-17. SPI Write Timing



图 8-18. SPI Read Timing

Multiple Devices Connection

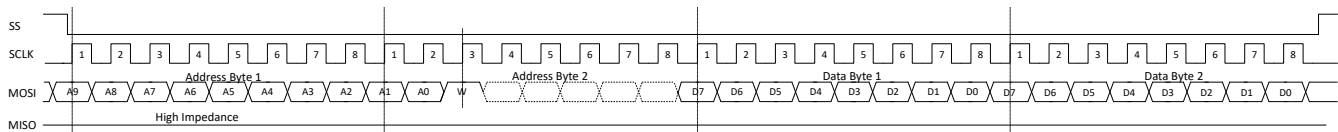
The device enters into SPI mode if IFS is pulled high to VIO through a pullup resistor (4.7 KΩ recommended). VIO_EN can either be connected with VIO power supply or GPIO. TI suggests to put one 1-nF cap as close to VIO_EN pin as possible. In SPI mode host can address as many devices as there are follower select pins on host.

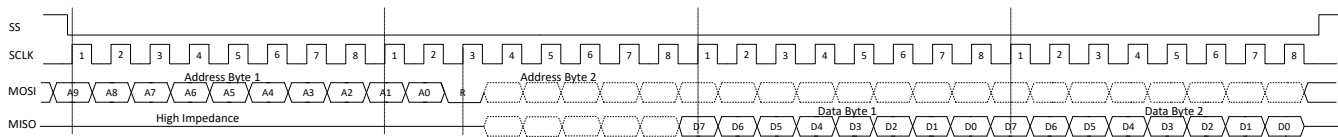

图 8-19. SPI Multiple Devices Connection

8.6 Register Maps

This section provides a summary of the register maps. For detailed register functions and descriptions, please refer to [LP5866 11x18 LED Matrix Driver Register Maps](#).

表 8-8. Register Section/Block Access Type Codes

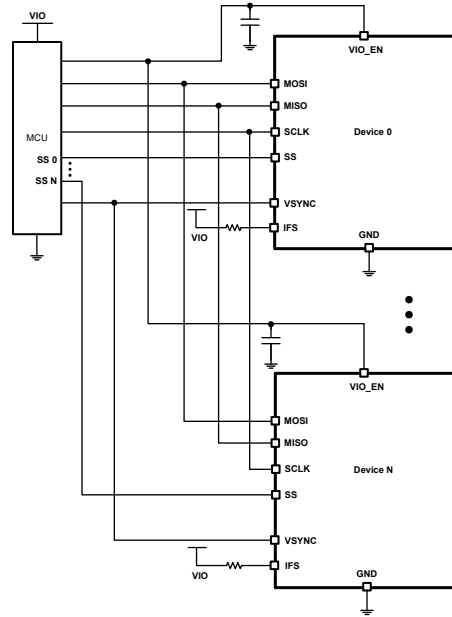
Access Type	Code	Description
Read Type		
R	R	Read
RC	R C	Read to Clear
R-0	R -0	Read Returns 0s
Write Type		
W	W	Write
W0CP	W 0C P	W 0 to clear Requires privileged access
Reset or Default Value		
-n		Value after reset or the default value

Register Acronym	Address	Type	D7	D6	D5	D4	D3	D2	D1	D0	Default
Chip_en	000h	R/W	Reserved							Chip_EN	00h
Dev_initial	001h	R/W	Reserved	Max_Line_Num				Data_Ref_Mode		PWM_Fre	5Eh
Dev_config1	002h	R/W	Reserved	Reserved	Reserved	Reserved	SW_BLK	PWM_Sc ale_Mode	PWM_Ph ase_Shift	CS_ON_ Shift	00h
Dev_config2	003h	R/W	Comp_Group3		Comp_Group2		Comp_Group1		LOD_rem oval	LSD_rem oval	00h
Dev_config3	004h	R/W	Down_Deghost		Up_Deghost		Maximum_Current			Up_Degh ost_enabl e	47h

Global_bri	005h	R/W	PWM_Global							FFh	
Group0_bri	006h	R/W	PWM_Group1							FFh	
Group1_bri	007h	R/W	PWM_Group2							FFh	
Group2_bri	008h	R/W	PWM_Group3							FFh	
R_current_set	009h	R/W	Reserved	CC_Group1						40h	
G_current_set	00Ah	R/W	Reserved	CC_Group2						40h	
B_current_set	00Bh	R/W	Reserved	CC_Group3						40h	
Dot_grp_sel0	00Ch	R/W	Dot L0-CS3 group		Dot L0-CS2 group		Dot L0-CS1 group		Dot L0-CS0 group		00h
Dot_grp_sel1	00Dh	R/W	Dot L0-CS7 group		Dot L0-CS6 group		Dot L0-CS5 group		Dot L0-CS4 group		00h
Dot_grp_sel2	00Eh	R/W	Dot L0-CS11 group		Dot L0-CS10 group		Dot L0-CS9 group		Dot L0-CS8 group		00h
Dot_grp_sel3	00Fh	R/W	Dot L0-CS15 group		Dot L0-CS14 group		Dot L0-CS13 group		Dot L0-CS12 group		00h
Dot_grp_sel4	010h	R/W	Reserved				Dot L0-CS17 group		Dot L0-CS16 group		00h
Dot_grp_sel5	011h	R/W	Dot L1-CS3 group		Dot L1-CS2 group		Dot L1-CS1 group		Dot L1-CS0 group		00h
Dot_grp_sel6	012h	R/W	Dot L1-CS7 group		Dot L1-CS6 group		Dot L1-CS5 group		Dot L1-CS4 group		00h
Dot_grp_sel7	013h	R/W	Dot L1-CS11 group		Dot L1-CS10 group		Dot L1-CS9 group		Dot L1-CS8 group		00h
Dot_grp_sel8	014h	R/W	Dot L1-CS15 group		Dot L1-CS14 group		Dot L1-CS13 group		Dot L1-CS12 group		00h
Dot_grp_sel9	015h	R/W	Reserved				Dot L1-CS17 group		Dot L1-CS16 group		00h
Dot_grp_sel10	016h	R/W	Dot L2-CS3 group		Dot L2-CS2 group		Dot L2-CS1 group		Dot L2-CS0 group		00h
Dot_grp_sel11	017h	R/W	Dot L2-CS7 group		Dot L2-CS6 group		Dot L2-CS5 group		Dot L2-CS4 group		00h
Dot_grp_sel12	018h	R/W	Dot L2-CS11 group		Dot L2-CS10 group		Dot L2-CS9 group		Dot L2-CS8 group		00h
Dot_grp_sel13	019h	R/W	Dot L2-CS15 group		Dot L2-CS14 group		Dot L2-CS13 group		Dot L2-CS12 group		00h
Dot_grp_sel14	01Ah	R/W	Reserved				Dot L2-CS17 group		Dot L2-CS16 group		00h
Dot_grp_sel15	01Bh	R/W	Dot L3-CS3 group		Dot L3-CS2 group		Dot L3-CS1 group		Dot L3-CS0 group		00h
Dot_grp_sel16	01Ch	R/W	Dot L3-CS7 group		Dot L3-CS6 group		Dot L3-CS5 group		Dot L3-CS4 group		00h
Dot_grp_sel17	01Dh	R/W	Dot L3-CS11 group		Dot L3-CS10 group		Dot L3-CS9 group		Dot L3-CS8 group		00h
Dot_grp_sel18	01Eh	R/W	Dot L3-CS15 group		Dot L3-CS14 group		Dot L3-CS13 group		Dot L3-CS12 group		00h
Dot_grp_sel19	01Fh	R/W	Reserved				Dot L3-CS17 group		Dot L3-CS16 group		00h
Dot_grp_sel20	020h	R/W	Dot L4-CS3 group		Dot L4-CS2 group		Dot L4-CS1 group		Dot L4-CS0 group		00h
Dot_grp_sel21	021h	R/W	Dot L4-CS7 group		Dot L4-CS6 group		Dot L4-CS5 group		Dot L4-CS4 group		00h
Dot_grp_sel22	022h	R/W	Dot L4-CS11 group		Dot L4-CS10 group		Dot L4-CS9 group		Dot L4-CS8 group		00h
Dot_grp_sel23	023h	R/W	Dot L4-CS15 group		Dot L4-CS14 group		Dot L4-CS13 group		Dot L4-CS12 group		00h
Dot_grp_sel24	024h	R/W	Reserved				Dot L4-CS17 group		Dot L4-CS16 group		00h
Dot_grp_sel25	025h	R/W	Dot L5-CS3 group		Dot L5-CS2 group		Dot L5-CS1 group		Dot L5-CS0 group		00h
Dot_grp_sel26	026h	R/W	Dot L5-CS7 group		Dot L5-CS6 group		Dot L5-CS5 group		Dot L5-CS4 group		00h
Dot_grp_sel27	027h	R/W	Dot L5-CS11 group		Dot L5-CS10 group		Dot L5-CS9 group		Dot L5-CS8 group		00h
Dot_grp_sel28	028h	R/W	Dot L5-CS15 group		Dot L5-CS14 group		Dot L5-CS13 group		Dot L5-CS12 group		00h
Dot_grp_sel29	029h	R/W	Reserved				Dot L5-CS17 group		Dot L5-CS16 group		00h
Dot_onoff0	043h	R/W	Dot L0-CS7 onoff	Dot L0-CS6 onoff	Dot L0-CS5 onoff	Dot L0-CS4 onoff	Dot L0-CS3 onoff	Dot L0-CS2 onoff	Dot L0-CS1 onoff	Dot L0-CS0 onoff	FFh
Dot_onoff1	044h	R/W	Dot L0-CS15 onoff	Dot L0-CS14 onoff	Dot L0-CS13 onoff	Dot L0-CS12 onoff	Dot L0-CS11 onoff	Dot L0-CS10 onoff	Dot L0-CS9 onoff	Dot L0-CS8 onoff	FFh
Dot_onoff2	045h	R/W	Reserved						Dot L0-CS17 onoff	Dot L0-CS16 onoff	03h
Dot_onoff3	046h	R/W	Dot L1-CS7 onoff	Dot L1-CS6 onoff	Dot L1-CS5 onoff	Dot L1-CS4 onoff	Dot L1-CS3 onoff	Dot L1-CS2 onoff	Dot L1-CS1 onoff	Dot L1-CS0 onoff	FFh
Dot_onoff4	047h	R/W	Dot L1-CS15 onoff	Dot L1-CS14 onoff	Dot L1-CS13 onoff	Dot L1-CS12 onoff	Dot L1-CS11 onoff	Dot L1-CS10 onoff	Dot L1-CS9 onoff	Dot L1-CS8 onoff	FFh

Dot_onoff5	048h	R/W	Reserved						Dot L1- CS17 onoff	Dot L1- CS16 onoff	03h
Dot_onoff6	049h	R/W	Dot L2- CS7 onoff	Dot L2- CS6 onoff	Dot L2- CS5 onoff	Dot L2- CS4 onoff	Dot L2- CS3 onoff	Dot L2- CS2 onoff	Dot L2- CS1 onoff	Dot L2- CS0 onoff	FFh
Dot_onoff7	04Ah	R/W	Dot L2- CS15 onoff	Dot L2- CS14 onoff	Dot L2- CS13 onoff	Dot L2- CS12 onoff	Dot L2- CS11 onoff	Dot L2- CS10 onoff	Dot L2- CS9 onoff	Dot L2- CS8 onoff	FFh
Dot_onoff8	04Bh	R/W	Reserved						Dot L2- CS17 onoff	Dot L2- CS16 onoff	03h
Dot_onoff9	04Ch	R/W	Dot L3- CS7 onoff	Dot L3- CS6 onoff	Dot L3- CS5 onoff	Dot L3- CS4 onoff	Dot L3- CS3 onoff	Dot L3- CS2 onoff	Dot L3- CS1 onoff	Dot L3- CS0 onoff	FFh
Dot_onoff10	04Dh	R/W	Dot L3- CS15 onoff	Dot L3- CS14 onoff	Dot L3- CS13 onoff	Dot L3- CS12 onoff	Dot L3- CS11 onoff	Dot L3- CS10 onoff	Dot L3- CS9 onoff	Dot L3- CS8 onoff	FFh
Dot_onoff11	04Eh	R/W	Reserved						Dot L3- CS17 onoff	Dot L3- CS16 onoff	03h
Dot_onoff12	04Fh	R/W	Dot L4- CS7 onoff	Dot L4- CS6 onoff	Dot L4- CS5 onoff	Dot L4- CS4 onoff	Dot L4- CS3 onoff	Dot L4- CS2 onoff	Dot L4- CS1 onoff	Dot L4- CS0 onoff	FFh
Dot_onoff13	050h	R/W	Dot L4- CS15 onoff	Dot L4- CS14 onoff	Dot L4- CS13 onoff	Dot L4- CS12 onoff	Dot L4- CS11 onoff	Dot L4- CS10 onoff	Dot L4- CS9 onoff	Dot L4- CS8 onoff	FFh
Dot_onoff14	051h	R/W	Reserved						Dot L4- CS17 onoff	Dot L4- CS16 onoff	03h
Dot_onoff15	052h	R/W	Dot L5- CS7 onoff	Dot L5- CS6 onoff	Dot L5- CS5 onoff	Dot L5- CS4 onoff	Dot L5- CS3 onoff	Dot L5- CS2 onoff	Dot L5- CS1 onoff	Dot L5- CS0 onoff	FFh
Dot_onoff16	053h	R/W	Dot L5- CS15 onoff	Dot L5- CS14 onoff	Dot L5- CS13 onoff	Dot L5- CS12 onoff	Dot L5- CS11 onoff	Dot L5- CS10 onoff	Dot L5- CS9 onoff	Dot L5- CS8 onoff	FFh
Dot_onoff17	054h	R/W	Reserved						Dot L5- CS17 onoff	Dot L5- CS16 onoff	03h
Fault_state	064h	R	Reserved						Global_L OD	Global_L SD	00h
Dot_lod0	065h	R	Dot L0- CS7 LOD	Dot L0- CS6 LOD	Dot L0- CS5 LOD	Dot L0- CS4 LOD	Dot L0- CS3 LOD	Dot L0- CS2 LOD	Dot L0- CS1 LOD	Dot L0- CS0 LOD	00h
Dot_lod1	066h	R	Dot L0- CS15 LOD	Dot L0- CS14 LOD	Dot L0- CS13 LOD	Dot L0- CS12 LOD	Dot L0- CS11 LOD	Dot L0- CS10 LOD	Dot L0- CS9 LOD	Dot L0- CS8 LOD	00h
Dot_lod2	067h	R	Reserved						Dot L0- CS17 LOD	Dot L0- CS16 LOD	00h
Dot_lod3	068h	R	Dot L1- CS7 LOD	Dot L1- CS6 LOD	Dot L1- CS5 LOD	Dot L1- CS4 LOD	Dot L1- CS3 LOD	Dot L1- CS2 LOD	Dot L1- CS1 LOD	Dot L1- CS0 LOD	00h
Dot_lod4	069h	R	Dot L1- CS15 LOD	Dot L1- CS14 LOD	Dot L1- CS13 LOD	Dot L1- CS12 LOD	Dot L1- CS11 LOD	Dot L1- CS10 LOD	Dot L1- CS9 LOD	Dot L1- CS8 LOD	00h
Dot_lod5	06Ah	R	Reserved						Dot L1- CS17 LOD	Dot L1- CS16 LOD	00h
Dot_lod6	06Bh	R	Dot L2- CS7 LOD	Dot L2- CS6 LOD	Dot L2- CS5 LOD	Dot L2- CS4 LOD	Dot L2- CS3 LOD	Dot L2- CS2 LOD	Dot L2- CS1 LOD	Dot L2- CS0 LOD	00h
Dot_lod7	06Ch	R	Dot L2- CS15 LOD	Dot L2- CS14 LOD	Dot L2- CS13 LOD	Dot L2- CS12 LOD	Dot L2- CS11 LOD	Dot L2- CS10 LOD	Dot L2- CS9 LOD	Dot L2- CS8 LOD	00h

Dot_lod8	06Dh	R	Reserved							Dot L2- CS17 LOD	Dot L2- CS16 LOD	00h
Dot_lod9	06Eh	R	Dot L3- CS7 LOD	Dot L3- CS6 LOD	Dot L3- CS5 LOD	Dot L3- CS4 LOD	Dot L3- CS3 LOD	Dot L3- CS2 LOD	Dot L3- CS1 LOD	Dot L3- CS0 LOD	00h	
Dot_lod10	06Fh	R	Dot L3- CS15 LOD	Dot L3- CS14 LOD	Dot L3- CS13 LOD	Dot L3- CS12 LOD	Dot L3- CS11 LOD	Dot L3- CS10 LOD	Dot L3- CS9 LOD	Dot L3- CS8 LOD	00h	
Dot_lod11	070h	R	Reserved							Dot L3- CS17 LOD	Dot L3- CS16 LOD	00h
Dot_lod12	071h	R	Dot L4- CS7 LOD	Dot L4- CS6 LOD	Dot L4- CS5 LOD	Dot L4- CS4 LOD	Dot L4- CS3 LOD	Dot L4- CS2 LOD	Dot L4- CS1 LOD	Dot L4- CS0 LOD	00h	
Dot_lod13	072h	R	Dot L4- CS15 LOD	Dot L4- CS14 LOD	Dot L4- CS13 LOD	Dot L4- CS12 LOD	Dot L4- CS11 LOD	Dot L4- CS10 LOD	Dot L4- CS9 LOD	Dot L4- CS8 LOD	00h	
Dot_lod14	073h	R	Reserved							Dot L4- CS17 LOD	Dot L4- CS16 LOD	00h
Dot_lod15	074h	R	Dot L5- CS7 LOD	Dot L5- CS6 LOD	Dot L5- CS5 LOD	Dot L5- CS4 LOD	Dot L5- CS3 LOD	Dot L5- CS2 LOD	Dot L5- CS1 LOD	Dot L5- CS0 LOD	00h	
Dot_lod16	075h	R	Dot L5- CS15 LOD	Dot L5- CS14 LOD	Dot L5- CS13 LOD	Dot L5- CS12 LOD	Dot L5- CS11 LOD	Dot L5- CS10 LOD	Dot L5- CS9 LOD	Dot L5- CS8 LOD	00h	
Dot_lsd0	086h	R	Dot L0- CS7 LSD	Dot L0- CS6 LSD	Dot L0- CS5 LSD	Dot L0- CS4 LSD	Dot L0- CS3 LSD	Dot L0- CS2 LSD	Dot L0- CS1 LSD	Dot L0- CS0 LSD	00h	
Dot_lsd1	087h	R	Dot L0- CS15 LSD	Dot L0- CS14 LSD	Dot L0- CS13 LSD	Dot L0- CS12 LSD	Dot L0- CS11 LSD	Dot L0- CS10 LSD	Dot L0- CS9 LSD	Dot L0- CS8 LSD	00h	
Dot_lsd2	088h	R	Reserved							Dot L0- CS17 LSD	Dot L0- CS16 LSD	00h
Dot_lsd3	089h	R	Dot L1- CS7 LSD	Dot L1- CS6 LSD	Dot L1- CS5 LSD	Dot L1- CS4 LSD	Dot L1- CS3 LSD	Dot L1- CS2 LSD	Dot L1- CS1 LSD	Dot L1- CS0 LSD	00h	
Dot_lsd4	08Ah	R	Dot L1- CS15 LSD	Dot L1- CS14 LSD	Dot L1- CS13 LSD	Dot L1- CS12 LSD	Dot L1- CS11 LSD	Dot L1- CS10 LSD	Dot L1- CS9 LSD	Dot L1- CS8 LSD	00h	
Dot_lsd5	08Bh	R	Reserved							Dot L1- CS17 LSD	Dot L1- CS16 LSD	00h
Dot_lsd6	08Ch	R	Dot L2- CS7 LSD	Dot L2- CS6 LSD	Dot L2- CS5 LSD	Dot L2- CS4 LSD	Dot L2- CS3 LSD	Dot L2- CS2 LSD	Dot L2- CS1 LSD	Dot L2- CS0 LSD	00h	
Dot_lsd7	08Dh	R	Dot L2- CS15 LSD	Dot L2- CS14 LSD	Dot L2- CS13 LSD	Dot L2- CS12 LSD	Dot L2- CS11 LSD	Dot L2- CS10 LSD	Dot L2- CS9 LSD	Dot L2- CS8 LSD	00h	
Dot_lsd8	08Eh	R	Reserved							Dot L2- CS17 LSD	Dot L2- CS16 LSD	00h
Dot_lsd9	08Fh	R	Dot L3- CS7 LSD	Dot L3- CS6 LSD	Dot L3- CS5 LSD	Dot L3- CS4 LSD	Dot L3- CS3 LSD	Dot L3- CS2 LSD	Dot L3- CS1 LSD	Dot L3- CS0 LSD	00h	
Dot_lsd10	090h	R	Dot L3- CS15 LSD	Dot L3- CS14 LSD	Dot L3- CS13 LSD	Dot L3- CS12 LSD	Dot L3- CS11 LSD	Dot L3- CS10 LSD	Dot L3- CS9 LSD	Dot L3- CS8 LSD	00h	
Dot_lsd11	091h	R	Reserved							Dot L3- CS17 LSD	Dot L3- CS16 LSD	00h
Dot_lsd12	092h	R	Dot L4- CS7 LSD	Dot L4- CS6 LSD	Dot L4- CS5 LSD	Dot L4- CS4 LSD	Dot L4- CS3 LSD	Dot L4- CS2 LSD	Dot L4- CS1 LSD	Dot L4- CS0 LSD	00h	

Dot_Isd13	093h	R	Dot L4- CS15 LSD	Dot L4- CS14 LSD	Dot L4- CS13 LSD	Dot L4- CS12 LSD	Dot L4- CS11 LSD	Dot L4- CS10 LSD	Dot L4- CS9 LSD	Dot L4- CS8 LSD	00h
Dot_Isd14	094h	R	Reserved						Dot L4- CS17 LSD	Dot L4- CS16 LSD	00h
Dot_Isd15	095h	R	Dot L5- CS7 LSD	Dot L5- CS6 LSD	Dot L5- CS5 LSD	Dot L5- CS4 LSD	Dot L5- CS3 LSD	Dot L5- CS2 LSD	Dot L5- CS1 LSD	Dot L5- CS0 LSD	00h
Dot_Isd16	096h	R	Dot L5- CS15 LSD	Dot L5- CS14 LSD	Dot L5- CS13 LSD	Dot L5- CS12 LSD	Dot L5- CS11 LSD	Dot L5- CS10 LSD	Dot L5- CS9 LSD	Dot L5- CS8 LSD	00h
Dot_Isd17	097h	R	Reserved						Dot L5- CS17 LSD	Dot L5- CS16 LSD	00h
LOD_clear	0A7h	W	Reserved				LOD_Clear				00h
LSD_clear	0A8h	W	Reserved				LSD_Clear				00h
Reset	0A9h	W	Reset								00h
DC0	100h	R/W	LED dot current setting for Dot L0-CS0								80h
DC1	101h	R/W	LED dot current setting for Dot L0-CS1								80h
DC2	102h	R/W	LED dot current setting for Dot L0-CS2								80h
DC3	103h	R/W	LED dot current setting for Dot L0-CS3								80h
DC4	104h	R/W	LED dot current setting for Dot L0-CS4								80h
DC5	105h	R/W	LED dot current setting for Dot L0-CS5								80h
DC6	106h	R/W	LED dot current setting for Dot L0-CS6								80h
DC7	107h	R/W	LED dot current setting for Dot L0-CS7								80h
DC8	108h	R/W	LED dot current setting for Dot L0-CS8								80h
DC9	109h	R/W	LED dot current setting for Dot L0-CS9								80h
DC10	10Ah	R/W	LED dot current setting for Dot L0-CS10								80h
DC11	10Bh	R/W	LED dot current setting for Dot L0-CS11								80h
DC12	10Ch	R/W	LED dot current setting for Dot L0-CS12								80h
DC13	10Dh	R/W	LED dot current setting for Dot L0-CS13								80h
DC14	10Eh	R/W	LED dot current setting for Dot L0-CS14								80h
DC15	10Fh	R/W	LED dot current setting for Dot L0-CS15								80h
DC16	110h	R/W	LED dot current setting for Dot L0-CS16								80h
DC17	111h	R/W	LED dot current setting for Dot L0-CS17								80h
DC18	112h	R/W	LED dot current setting for Dot L1-CS0								80h
DC19	113h	R/W	LED dot current setting for Dot L1-CS1								80h
DC20	114h	R/W	LED dot current setting for Dot L1-CS2								80h
DC21	115h	R/W	LED dot current setting for Dot L1-CS3								80h
DC22	116h	R/W	LED dot current setting for Dot L1-CS4								80h
DC23	117h	R/W	LED dot current setting for Dot L1-CS5								80h
DC24	118h	R/W	LED dot current setting for Dot L1-CS6								80h
DC25	119h	R/W	LED dot current setting for Dot L1-CS7								80h
DC26	11Ah	R/W	LED dot current setting for Dot L1-CS8								80h
DC27	11Bh	R/W	LED dot current setting for Dot L1-CS9								80h
DC28	11Ch	R/W	LED dot current setting for Dot L1-CS10								80h
DC29	11Dh	R/W	LED dot current setting for Dot L1-CS11								80h
DC30	11Eh	R/W	LED dot current setting for Dot L1-CS12								80h
DC31	11Fh	R/W	LED dot current setting for Dot L1-CS13								80h
DC32	120h	R/W	LED dot current setting for Dot L1-CS14								80h

DC33	121h	R/W	LED dot current setting for Dot L1-CS15	80h
DC34	122h	R/W	LED dot current setting for Dot L1-CS16	80h
DC35	123h	R/W	LED dot current setting for Dot L1-CS17	80h
DC36	124h	R/W	LED dot current setting for Dot L2-CS0	80h
DC37	125h	R/W	LED dot current setting for Dot L2-CS1	80h
DC38	126h	R/W	LED dot current setting for Dot L2-CS2	80h
DC39	127h	R/W	LED dot current setting for Dot L2-CS3	80h
DC40	128h	R/W	LED dot current setting for Dot L2-CS4	80h
DC41	129h	R/W	LED dot current setting for Dot L2-CS5	80h
DC42	12Ah	R/W	LED dot current setting for Dot L2-CS6	80h
DC43	12Bh	R/W	LED dot current setting for Dot L2-CS7	80h
DC44	12Ch	R/W	LED dot current setting for Dot L2-CS8	80h
DC45	12Dh	R/W	LED dot current setting for Dot L2-CS9	80h
DC46	12Eh	R/W	LED dot current setting for Dot L2-CS10	80h
DC47	12Fh	R/W	LED dot current setting for Dot L2-CS11	80h
DC48	130h	R/W	LED dot current setting for Dot L2-CS12	80h
DC49	131h	R/W	LED dot current setting for Dot L2-CS13	80h
DC50	132h	R/W	LED dot current setting for Dot L2-CS14	80h
DC51	133h	R/W	LED dot current setting for Dot L2-CS15	80h
DC52	134h	R/W	LED dot current setting for Dot L2-CS16	80h
DC53	135h	R/W	LED dot current setting for Dot L2-CS17	80h
DC54	136h	R/W	LED dot current setting for Dot L3-CS0	80h
DC55	137h	R/W	LED dot current setting for Dot L3-CS1	80h
DC56	138h	R/W	LED dot current setting for Dot L3-CS2	80h
DC57	139h	R/W	LED dot current setting for Dot L3-CS3	80h
DC58	13Ah	R/W	LED dot current setting for Dot L3-CS4	80h
DC59	13Bh	R/W	LED dot current setting for Dot L3-CS5	80h
DC60	13Ch	R/W	LED dot current setting for Dot L3-CS6	80h
DC61	13Dh	R/W	LED dot current setting for Dot L3-CS7	80h
DC62	13Eh	R/W	LED dot current setting for Dot L3-CS8	80h
DC63	13Fh	R/W	LED dot current setting for Dot L3-CS9	80h
DC64	140h	R/W	LED dot current setting for Dot L3-CS10	80h
DC65	141h	R/W	LED dot current setting for Dot L3-CS11	80h
DC66	142h	R/W	LED dot current setting for Dot L3-CS12	80h
DC67	143h	R/W	LED dot current setting for Dot L3-CS13	80h
DC68	144h	R/W	LED dot current setting for Dot L3-CS14	80h
DC69	145h	R/W	LED dot current setting for Dot L3-CS15	80h
DC70	146h	R/W	LED dot current setting for Dot L3-CS16	80h
DC71	147h	R/W	LED dot current setting for Dot L3-CS17	80h
DC72	148h	R/W	LED dot current setting for Dot L4-CS0	80h
DC73	149h	R/W	LED dot current setting for Dot L4-CS1	80h
DC74	14Ah	R/W	LED dot current setting for Dot L4-CS2	80h
DC75	14Bh	R/W	LED dot current setting for Dot L4-CS3	80h
DC76	14Ch	R/W	LED dot current setting for Dot L4-CS4	80h
DC77	14Dh	R/W	LED dot current setting for Dot L4-CS5	80h
DC78	14Eh	R/W	LED dot current setting for Dot L4-CS6	80h
DC79	14Fh	R/W	LED dot current setting for Dot L4-CS7	80h

DC80	150h	R/W	LED dot current setting for Dot L4-CS8	80h
DC81	151h	R/W	LED dot current setting for Dot L4-CS9	80h
DC82	152h	R/W	LED dot current setting for Dot L4-CS10	80h
DC83	153h	R/W	LED dot current setting for Dot L4-CS11	80h
DC84	154h	R/W	LED dot current setting for Dot L4-CS12	80h
DC85	155h	R/W	LED dot current setting for Dot L4-CS13	80h
DC86	156h	R/W	LED dot current setting for Dot L4-CS14	80h
DC87	157h	R/W	LED dot current setting for Dot L4-CS15	80h
DC88	158h	R/W	LED dot current setting for Dot L4-CS16	80h
DC89	159h	R/W	LED dot current setting for Dot L4-CS17	80h
DC90	15Ah	R/W	LED dot current setting for Dot L5-CS0	80h
DC91	15Bh	R/W	LED dot current setting for Dot L5-CS1	80h
DC92	15Ch	R/W	LED dot current setting for Dot L5-CS2	80h
DC93	15Dh	R/W	LED dot current setting for Dot L5-CS3	80h
DC94	15Eh	R/W	LED dot current setting for Dot L5-CS4	80h
DC95	15Fh	R/W	LED dot current setting for Dot L5-CS5	80h
DC96	160h	R/W	LED dot current setting for Dot L5-CS6	80h
DC97	161h	R/W	LED dot current setting for Dot L5-CS7	80h
DC98	162h	R/W	LED dot current setting for Dot L5-CS8	80h
DC99	163h	R/W	LED dot current setting for Dot L5-CS9	80h
DC100	164h	R/W	LED dot current setting for Dot L5-CS10	80h
DC101	165h	R/W	LED dot current setting for Dot L5-CS11	80h
DC102	166h	R/W	LED dot current setting for Dot L5-CS12	80h
DC103	167h	R/W	LED dot current setting for Dot L5-CS13	80h
DC104	168h	R/W	LED dot current setting for Dot L5-CS14	80h
DC105	169h	R/W	LED dot current setting for Dot L5-CS15	80h
DC106	16Ah	R/W	LED dot current setting for Dot L5-CS16	80h
DC107	16Bh	R/W	LED dot current setting for Dot L5-CS17	80h
pwm_bri0	200h	R/W	8-bits PWM for Dot L0-CS0 OR 16-bits PWM lower 8 bits [7:0] for Dot L0-CS0	00h
pwm_bri1	201h	R/W	8-bits PWM for Dot L0-CS1 OR 16-bits PWM higher 8 bits [15:8] for Dot L0-CS0	00h
pwm_bri2	202h	R/W	8-bits PWM for Dot L0-CS2 OR 16-bits PWM lower 8 bits [7:0] for Dot L0-CS1	00h
pwm_bri3	203h	R/W	8-bits PWM for Dot L0-CS3 OR 16-bits PWM higher 8 bits [15:8] for Dot L0-CS1	00h
pwm_bri4	204h	R/W	8-bits PWM for Dot L0-CS4 OR 16-bits PWM lower 8 bits [7:0] for Dot L0-CS2	00h
pwm_bri5	205h	R/W	8-bits PWM for Dot L0-CS5 OR 16-bits PWM higher 8 bits [15:8] for Dot L0-CS2	00h
pwm_bri6	206h	R/W	8-bits PWM for Dot L0-CS6 OR 16-bits PWM lower 8 bits [7:0] for Dot L0-CS3	00h
pwm_bri7	207h	R/W	8-bits PWM for Dot L0-CS7 OR 16-bits PWM higher 8 bits [15:8] for Dot L0-CS3	00h
pwm_bri8	208h	R/W	8-bits PWM for Dot L0-CS8 OR 16-bits PWM lower 8 bits [7:0] for Dot L0-CS4	00h
pwm_bri9	209h	R/W	8-bits PWM for Dot L0-CS9 OR 16-bits PWM higher 8 bits [15:8] for Dot L0-CS4	00h
pwm_bri10	20Ah	R/W	8-bits PWM for Dot L0-CS10 OR 16-bits PWM lower 8 bits [7:0] for Dot L0-CS5	00h
pwm_bri11	20Bh	R/W	8-bits PWM for Dot L0-CS11 OR 16-bits PWM higher 8 bits [15:8] for Dot L0-CS5	00h
pwm_bri12	20Ch	R/W	8-bits PWM for Dot L0-CS12 OR 16-bits PWM lower 8 bits [7:0] for Dot L0-CS6	00h
pwm_bri13	20Dh	R/W	8-bits PWM for Dot L0-CS13 OR 16-bits PWM higher 8 bits [15:8] for Dot L0-CS6	00h
pwm_bri14	20Eh	R/W	8-bits PWM for Dot L0-CS14 OR 16-bits PWM lower 8 bits [7:0] for Dot L0-CS7	00h
pwm_bri15	20Fh	R/W	8-bits PWM for Dot L0-CS15 OR 16-bits PWM higher 8 bits [15:8] for Dot L0-CS7	00h
pwm_bri16	210h	R/W	8-bits PWM for Dot L0-CS16 OR 16-bits PWM lower 8 bits [7:0] for Dot L0-CS8	00h
pwm_bri17	211h	R/W	8-bits PWM for Dot L0-CS17 OR 16-bits PWM higher 8 bits [15:8] for Dot L0-CS8	00h
pwm_bri18	212h	R/W	8-bits PWM for Dot L1-CS0 OR 16-bits PWM lower 8 bits [7:0] for Dot L0-CS9	00h

pwm_bri19	213h	R/W	8-bits PWM for Dot L1-CS1 OR 16-bits PWM higher 8 bits [15:8] for Dot L0-CS9	00h
pwm_bri20	214h	R/W	8-bits PWM for Dot L1-CS2 OR 16-bits PWM lower 8 bits [7:0] for Dot L0-CS10	00h
pwm_bri21	215h	R/W	8-bits PWM for Dot L1-CS3 OR 16-bits PWM higher 8 bits [15:8] for Dot L0-CS10	00h
pwm_bri22	216h	R/W	8-bits PWM for Dot L1-CS4 OR 16-bits PWM lower 8 bits [7:0] for Dot L0-CS11	00h
pwm_bri23	217h	R/W	8-bits PWM for Dot L1-CS5 OR 16-bits PWM higher 8 bits [15:8] for Dot L0-CS11	00h
pwm_bri24	218h	R/W	8-bits PWM for Dot L1-CS6 OR 16-bits PWM lower 8 bits [7:0] for Dot L0-CS12	00h
pwm_bri25	219h	R/W	8-bits PWM for Dot L1-CS7 OR 16-bits PWM higher 8 bits [15:8] for Dot L0-CS12	00h
pwm_bri26	21Ah	R/W	8-bits PWM for Dot L1-CS8 OR 16-bits PWM lower 8 bits [7:0] for Dot L0-CS13	00h
pwm_bri27	21Bh	R/W	8-bits PWM for Dot L1-CS9 OR 16-bits PWM higher 8 bits [15:8] for Dot L0-CS13	00h
pwm_bri28	21Ch	R/W	8-bits PWM for Dot L1-CS10 OR 16-bits PWM lower 8 bits [7:0] for Dot L0-CS14	00h
pwm_bri29	21Dh	R/W	8-bits PWM for Dot L1-CS11 OR 16-bits PWM higher 8 bits [15:8] for Dot L0-CS14	00h
pwm_bri30	21Eh	R/W	8-bits PWM for Dot L1-CS12 OR 16-bits PWM lower 8 bits [7:0] for Dot L0-CS15	00h
pwm_bri31	21Fh	R/W	8-bits PWM for Dot L1-CS13 OR 16-bits PWM higher 8 bits [15:8] for Dot L0-CS15	00h
pwm_bri32	220h	R/W	8-bits PWM for Dot L1-CS14 OR 16-bits PWM lower 8 bits [7:0] for Dot L0-CS16	00h
pwm_bri33	221h	R/W	8-bits PWM for Dot L1-CS15 OR 16-bits PWM higher 8 bits [15:8] for Dot L0-CS16	00h
pwm_bri34	222h	R/W	8-bits PWM for Dot L1-CS16 OR 16-bits PWM lower 8 bits [7:0] for Dot L0-CS17	00h
pwm_bri35	223h	R/W	8-bits PWM for Dot L1-CS17 OR 16-bits PWM higher 8 bits [15:8] for Dot L0-CS17	00h
pwm_bri36	224h	R/W	8-bits PWM for Dot L2-CS0 OR 16-bits PWM lower 8 bits [7:0] for Dot L1-CS0	00h
pwm_bri37	225h	R/W	8-bits PWM for Dot L2-CS1 OR 16-bits PWM higher 8 bits [15:8] for Dot L1-CS0	00h
pwm_bri38	226h	R/W	8-bits PWM for Dot L2-CS2 OR 16-bits PWM lower 8 bits [7:0] for Dot L1-CS1	00h
pwm_bri39	227h	R/W	8-bits PWM for Dot L2-CS3 OR 16-bits PWM higher 8 bits [15:8] for Dot L1-CS1	00h
pwm_bri40	228h	R/W	8-bits PWM for Dot L2-CS4 OR 16-bits PWM lower 8 bits [7:0] for Dot L1-CS2	00h
pwm_bri41	229h	R/W	8-bits PWM for Dot L2-CS5 OR 16-bits PWM higher 8 bits [15:8] for Dot L1-CS2	00h
pwm_bri42	22Ah	R/W	8-bits PWM for Dot L2-CS6 OR 16-bits PWM lower 8 bits [7:0] for Dot L1-CS3	00h
pwm_bri43	22Bh	R/W	8-bits PWM for Dot L2-CS7 OR 16-bits PWM higher 8 bits [15:8] for Dot L1-CS3	00h
pwm_bri44	22Ch	R/W	8-bits PWM for Dot L2-CS8 OR 16-bits PWM lower 8 bits [7:0] for Dot L1-CS4	00h
pwm_bri45	22Dh	R/W	8-bits PWM for Dot L2-CS9 OR 16-bits PWM higher 8 bits [15:8] for Dot L1-CS4	00h
pwm_bri46	22Eh	R/W	8-bits PWM for Dot L2-CS10 OR 16-bits PWM lower 8 bits [7:0] for Dot L1-CS5	00h
pwm_bri47	22Fh	R/W	8-bits PWM for Dot L2-CS11 OR 16-bits PWM higher 8 bits [15:8] for Dot L1-CS5	00h
pwm_bri48	230h	R/W	8-bits PWM for Dot L2-CS12 OR 16-bits PWM lower 8 bits [7:0] for Dot L1-CS6	00h
pwm_bri49	231h	R/W	8-bits PWM for Dot L2-CS13 OR 16-bits PWM higher 8 bits [15:8] for Dot L1-CS6	00h
pwm_bri50	232h	R/W	8-bits PWM for Dot L2-CS14 OR 16-bits PWM lower 8 bits [7:0] for Dot L1-CS7	00h
pwm_bri51	233h	R/W	8-bits PWM for Dot L2-CS15 OR 16-bits PWM higher 8 bits [15:8] for Dot L1-CS7	00h
pwm_bri52	234h	R/W	8-bits PWM for Dot L2-CS16 OR 16-bits PWM lower 8 bits [7:0] for Dot L1-CS8	00h
pwm_bri53	235h	R/W	8-bits PWM for Dot L2-CS17 OR 16-bits PWM higher 8 bits [15:8] for Dot L1-CS8	00h
pwm_bri54	236h	R/W	8-bits PWM for Dot L3-CS0 OR 16-bits PWM lower 8 bits [7:0] for Dot L1-CS9	00h
pwm_bri55	237h	R/W	8-bits PWM for Dot L3-CS1 OR 16-bits PWM higher 8 bits [15:8] for Dot L1-CS9	00h
pwm_bri56	238h	R/W	8-bits PWM for Dot L3-CS2 OR 16-bits PWM lower 8 bits [7:0] for Dot L1-CS10	00h
pwm_bri57	239h	R/W	8-bits PWM for Dot L3-CS3 OR 16-bits PWM higher 8 bits [15:8] for Dot L1-CS10	00h
pwm_bri58	23Ah	R/W	8-bits PWM for Dot L3-CS4 OR 16-bits PWM lower 8 bits [7:0] for Dot L1-CS11	00h
pwm_bri59	23Bh	R/W	8-bits PWM for Dot L3-CS5 OR 16-bits PWM higher 8 bits [15:8] for Dot L1-CS11	00h
pwm_bri60	23Ch	R/W	8-bits PWM for Dot L3-CS6 OR 16-bits PWM lower 8 bits [7:0] for Dot L1-CS12	00h
pwm_bri61	23Dh	R/W	8-bits PWM for Dot L3-CS7 OR 16-bits PWM higher 8 bits [15:8] for Dot L1-CS12	00h
pwm_bri62	23Eh	R/W	8-bits PWM for Dot L3-CS8 OR 16-bits PWM lower 8 bits [7:0] for Dot L1-CS13	00h
pwm_bri63	23Fh	R/W	8-bits PWM for Dot L3-CS9 OR 16-bits PWM higher 8 bits [15:8] for Dot L1-CS13	00h
pwm_bri64	240h	R/W	8-bits PWM for Dot L3-CS10 OR 16-bits PWM lower 8 bits [7:0] for Dot L1-CS14	00h
pwm_bri65	241h	R/W	8-bits PWM for Dot L3-CS11 OR 16-bits PWM higher 8 bits [15:8] for Dot L1-CS14	00h

pwm_bri66	242h	R/W	8-bits PWM for Dot L3-CS12 OR 16-bits PWM lower 8 bits [7:0] for Dot L1-CS15	00h
pwm_bri67	243h	R/W	8-bits PWM for Dot L3-CS13 OR 16-bits PWM higher 8 bits [15:8] for Dot L1-CS15	00h
pwm_bri68	244h	R/W	8-bits PWM for Dot L3-CS14 OR 16-bits PWM lower 8 bits [7:0] for Dot L1-CS16	00h
pwm_bri69	245h	R/W	8-bits PWM for Dot L3-CS15 OR 16-bits PWM higher 8 bits [15:8] for Dot L1-CS16	00h
pwm_bri70	246h	R/W	8-bits PWM for Dot L3-CS16 OR 16-bits PWM lower 8 bits [7:0] for Dot L1-CS17	00h
pwm_bri71	247h	R/W	8-bits PWM for Dot L3-CS17 OR 16-bits PWM higher 8 bits [15:8] for Dot L1-CS17	00h
pwm_bri72	248h	R/W	8-bits PWM for Dot L4-CS0 OR 16-bits PWM lower 8 bits [7:0] for Dot L2-CS0	00h
pwm_bri73	249h	R/W	8-bits PWM for Dot L4-CS1 OR 16-bits PWM higher 8 bits [15:8] for Dot L2-CS0	00h
pwm_bri74	24Ah	R/W	8-bits PWM for Dot L4-CS2 OR 16-bits PWM lower 8 bits [7:0] for Dot L2-CS1	00h
pwm_bri75	24Bh	R/W	8-bits PWM for Dot L4-CS3 OR 16-bits PWM higher 8 bits [15:8] for Dot L2-CS1	00h
pwm_bri76	24Ch	R/W	8-bits PWM for Dot L4-CS4 OR 16-bits PWM lower 8 bits [7:0] for Dot L2-CS2	00h
pwm_bri77	24Dh	R/W	8-bits PWM for Dot L4-CS5 OR 16-bits PWM higher 8 bits [15:8] for Dot L2-CS2	00h
pwm_bri78	24Eh	R/W	8-bits PWM for Dot L4-CS6 OR 16-bits PWM lower 8 bits [7:0] for Dot L2-CS3	00h
pwm_bri79	24Fh	R/W	8-bits PWM for Dot L4-CS7 OR 16-bits PWM higher 8 bits [15:8] for Dot L2-CS3	00h
pwm_bri80	250h	R/W	8-bits PWM for Dot L4-CS8 OR 16-bits PWM lower 8 bits [7:0] for Dot L2-CS4	00h
pwm_bri81	251h	R/W	8-bits PWM for Dot L4-CS9 OR 16-bits PWM higher 8 bits [15:8] for Dot L2-CS4	00h
pwm_bri82	252h	R/W	8-bits PWM for Dot L4-CS10 OR 16-bits PWM lower 8 bits [7:0] for Dot L2-CS5	00h
pwm_bri83	253h	R/W	8-bits PWM for Dot L4-CS11 OR 16-bits PWM higher 8 bits [15:8] for Dot L2-CS5	00h
pwm_bri84	254h	R/W	8-bits PWM for Dot L4-CS12 OR 16-bits PWM lower 8 bits [7:0] for Dot L2-CS6	00h
pwm_bri85	255h	R/W	8-bits PWM for Dot L4-CS13 OR 16-bits PWM higher 8 bits [15:8] for Dot L2-CS6	00h
pwm_bri86	256h	R/W	8-bits PWM for Dot L4-CS14 OR 16-bits PWM lower 8 bits [7:0] for Dot L2-CS7	00h
pwm_bri87	257h	R/W	8-bits PWM for Dot L4-CS15 OR 16-bits PWM higher 8 bits [15:8] for Dot L2-CS7	00h
pwm_bri88	258h	R/W	8-bits PWM for Dot L4-CS16 OR 16-bits PWM lower 8 bits [7:0] for Dot L2-CS8	00h
pwm_bri89	259h	R/W	8-bits PWM for Dot L4-CS17 OR 16-bits PWM higher 8 bits [15:8] for Dot L2-CS8	00h
pwm_bri90	25Ah	R/W	8-bits PWM for Dot L5-CS0 OR 16-bits PWM lower 8 bits [7:0] for Dot L2-CS9	00h
pwm_bri91	25Bh	R/W	8-bits PWM for Dot L5-CS1 OR 16-bits PWM higher 8 bits [15:8] for Dot L2-CS9	00h
pwm_bri92	25Ch	R/W	8-bits PWM for Dot L5-CS2 OR 16-bits PWM lower 8 bits [7:0] for Dot L2-CS10	00h
pwm_bri93	25Dh	R/W	8-bits PWM for Dot L5-CS3 OR 16-bits PWM higher 8 bits [15:8] for Dot L2-CS10	00h
pwm_bri94	25Eh	R/W	8-bits PWM for Dot L5-CS4 OR 16-bits PWM lower 8 bits [7:0] for Dot L2-CS11	00h
pwm_bri95	25Fh	R/W	8-bits PWM for Dot L5-CS5 OR 16-bits PWM higher 8 bits [15:8] for Dot L2-CS11	00h
pwm_bri96	260h	R/W	8-bits PWM for Dot L5-CS6 OR 16-bits PWM lower 8 bits [7:0] for Dot L2-CS12	00h
pwm_bri97	261h	R/W	8-bits PWM for Dot L5-CS7 OR 16-bits PWM higher 8 bits [15:8] for Dot L2-CS12	00h
pwm_bri98	262h	R/W	8-bits PWM for Dot L5-CS8 OR 16-bits PWM lower 8 bits [7:0] for Dot L2-CS13	00h
pwm_bri99	263h	R/W	8-bits PWM for Dot L5-CS9 OR 16-bits PWM higher 8 bits [15:8] for Dot L2-CS13	00h
pwm_bri100	264h	R/W	8-bits PWM for Dot L5-CS10 OR 16-bits PWM lower 8 bits [7:0] for Dot L2-CS14	00h
pwm_bri101	265h	R/W	8-bits PWM for Dot L5-CS11 OR 16-bits PWM higher 8 bits [15:8] for Dot L2-CS14	00h
pwm_bri102	266h	R/W	8-bits PWM for Dot L5-CS12 OR 16-bits PWM lower 8 bits [7:0] for Dot L2-CS15	00h
pwm_bri103	267h	R/W	8-bits PWM for Dot L5-CS13 OR 16-bits PWM higher 8 bits [15:8] for Dot L2-CS15	00h
pwm_bri104	268h	R/W	8-bits PWM for Dot L5-CS14 OR 16-bits PWM lower 8 bits [7:0] for Dot L2-CS16	00h
pwm_bri105	269h	R/W	8-bits PWM for Dot L5-CS15 OR 16-bits PWM higher 8 bits [15:8] for Dot L2-CS16	00h
pwm_bri106	26Ah	R/W	8-bits PWM for Dot L5-CS16 OR 16-bits PWM lower 8 bits [7:0] for Dot L2-CS17	00h
pwm_bri107	26Bh	R/W	8-bits PWM for Dot L5-CS17 OR 16-bits PWM higher 8 bits [15:8] for Dot L2-CS17	00h
pwm_bri108	26Ch	R/W	16-bits PWM lower 8 bits [7:0] for Dot L3-CS0	00h
pwm_bri109	26Dh	R/W	16-bits PWM higher 8 bits [15:8] for Dot L3-CS0	00h
pwm_bri110	26Eh	R/W	16-bits PWM lower 8 bits [7:0] for Dot L3-CS1	00h
pwm_bri111	26Fh	R/W	16-bits PWM higher 8 bits [15:8] for Dot L3-CS1	00h
pwm_bri112	270h	R/W	16-bits PWM lower 8 bits [7:0] for Dot L3-CS2	00h

pwm_bri113	271h	R/W	16-bits PWM higher 8 bits [15:8] for Dot L3-CS2	00h
pwm_bri114	272h	R/W	16-bits PWM lower 8 bits [7:0] for Dot L3-CS3	00h
pwm_bri115	273h	R/W	16-bits PWM higher 8 bits [15:8] for Dot L3-CS3	00h
pwm_bri116	274h	R/W	16-bits PWM lower 8 bits [7:0] for Dot L3-CS4	00h
pwm_bri117	275h	R/W	16-bits PWM higher 8 bits [15:8] for Dot L3-CS4	00h
pwm_bri118	276h	R/W	16-bits PWM lower 8 bits [7:0] for Dot L3-CS5	00h
pwm_bri119	277h	R/W	16-bits PWM higher 8 bits [15:8] for Dot L3-CS5	00h
pwm_bri120	278h	R/W	16-bits PWM lower 8 bits [7:0] for Dot L3-CS6	00h
pwm_bri121	279h	R/W	16-bits PWM higher 8 bits [15:8] for Dot L3-CS6	00h
pwm_bri122	27Ah	R/W	16-bits PWM lower 8 bits [7:0] for Dot L3-CS7	00h
pwm_bri123	27Bh	R/W	16-bits PWM higher 8 bits [15:8] for Dot L3-CS7	00h
pwm_bri124	27Ch	R/W	16-bits PWM lower 8 bits [7:0] for Dot L3-CS8	00h
pwm_bri125	27Dh	R/W	16-bits PWM higher 8 bits [15:8] for Dot L3-CS8	00h
pwm_bri126	27Eh	R/W	16-bits PWM lower 8 bits [7:0] for Dot L3-CS9	00h
pwm_bri127	27Fh	R/W	16-bits PWM higher 8 bits [15:8] for Dot L3-CS9	00h
pwm_bri128	280h	R/W	16-bits PWM lower 8 bits [7:0] for Dot L3-CS10	00h
pwm_bri129	281h	R/W	16-bits PWM higher 8 bits [15:8] for Dot L3-CS10	00h
pwm_bri130	282h	R/W	16-bits PWM lower 8 bits [7:0] for Dot L3-CS11	00h
pwm_bri131	283h	R/W	16-bits PWM higher 8 bits [15:8] for Dot L3-CS11	00h
pwm_bri132	284h	R/W	16-bits PWM lower 8 bits [7:0] for Dot L3-CS12	00h
pwm_bri133	285h	R/W	16-bits PWM higher 8 bits [15:8] for Dot L3-CS12	00h
pwm_bri134	286h	R/W	16-bits PWM lower 8 bits [7:0] for Dot L3-CS13	00h
pwm_bri135	287h	R/W	16-bits PWM higher 8 bits [15:8] for Dot L3-CS13	00h
pwm_bri136	288h	R/W	16-bits PWM lower 8 bits [7:0] for Dot L3-CS14	00h
pwm_bri137	289h	R/W	16-bits PWM higher 8 bits [15:8] for Dot L3-CS14	00h
pwm_bri138	28Ah	R/W	16-bits PWM lower 8 bits [7:0] for Dot L3-CS15	00h
pwm_bri139	28Bh	R/W	16-bits PWM higher 8 bits [15:8] for Dot L3-CS15	00h
pwm_bri140	28Ch	R/W	16-bits PWM lower 8 bits [7:0] for Dot L3-CS16	00h
pwm_bri141	28Dh	R/W	16-bits PWM higher 8 bits [15:8] for Dot L3-CS16	00h
pwm_bri142	28Eh	R/W	16-bits PWM lower 8 bits [7:0] for Dot L3-CS17	00h
pwm_bri143	28Fh	R/W	16-bits PWM higher 8 bits [15:8] for Dot L3-CS17	00h
pwm_bri144	290h	R/W	16-bits PWM lower 8 bits [7:0] for Dot L4-CS0	00h
pwm_bri145	291h	R/W	16-bits PWM higher 8 bits [15:8] for Dot L4-CS0	00h
pwm_bri146	292h	R/W	16-bits PWM lower 8 bits [7:0] for Dot L4-CS1	00h
pwm_bri147	293h	R/W	16-bits PWM higher 8 bits [15:8] for Dot L4-CS1	00h
pwm_bri148	294h	R/W	16-bits PWM lower 8 bits [7:0] for Dot L4-CS2	00h
pwm_bri149	295h	R/W	16-bits PWM higher 8 bits [15:8] for Dot L4-CS2	00h
pwm_bri150	296h	R/W	16-bits PWM lower 8 bits [7:0] for Dot L4-CS3	00h
pwm_bri151	297h	R/W	16-bits PWM higher 8 bits [15:8] for Dot L4-CS3	00h
pwm_bri152	298h	R/W	16-bits PWM lower 8 bits [7:0] for Dot L4-CS4	00h
pwm_bri153	299h	R/W	16-bits PWM higher 8 bits [15:8] for Dot L4-CS4	00h
pwm_bri154	29Ah	R/W	16-bits PWM lower 8 bits [7:0] for Dot L4-CS5	00h
pwm_bri155	29Bh	R/W	16-bits PWM higher 8 bits [15:8] for Dot L4-CS5	00h
pwm_bri156	29Ch	R/W	16-bits PWM lower 8 bits [7:0] for Dot L4-CS6	00h
pwm_bri157	29Dh	R/W	16-bits PWM higher 8 bits [15:8] for Dot L4-CS6	00h
pwm_bri158	29Eh	R/W	16-bits PWM lower 8 bits [7:0] for Dot L4-CS7	00h
pwm_bri159	29Fh	R/W	16-bits PWM higher 8 bits [15:8] for Dot L4-CS7	00h

pwm_bri160	2A0h	R/W	16-bits PWM lower 8 bits [7:0] for Dot L4-CS8	00h
pwm_bri161	2A1h	R/W	16-bits PWM higher 8 bits [15:8] for Dot L4-CS8	00h
pwm_bri162	2A2h	R/W	16-bits PWM lower 8 bits [7:0] for Dot L4-CS9	00h
pwm_bri163	2A3h	R/W	16-bits PWM higher 8 bits [15:8] for Dot L4-CS9	00h
pwm_bri164	2A4h	R/W	16-bits PWM lower 8 bits [7:0] for Dot L4-CS10	00h
pwm_bri165	2A5h	R/W	16-bits PWM higher 8 bits [15:8] for Dot L4-CS10	00h
pwm_bri166	2A6h	R/W	16-bits PWM lower 8 bits [7:0] for Dot L4-CS11	00h
pwm_bri167	2A7h	R/W	16-bits PWM higher 8 bits [15:8] for Dot L4-CS11	00h
pwm_bri168	2A8h	R/W	16-bits PWM lower 8 bits [7:0] for Dot L4-CS12	00h
pwm_bri169	2A9h	R/W	16-bits PWM higher 8 bits [15:8] for Dot L4-CS12	00h
pwm_bri170	2AAh	R/W	16-bits PWM lower 8 bits [7:0] for Dot L4-CS13	00h
pwm_bri171	2ABh	R/W	16-bits PWM higher 8 bits [15:8] for Dot L4-CS13	00h
pwm_bri172	2ACh	R/W	16-bits PWM lower 8 bits [7:0] for Dot L4-CS14	00h
pwm_bri173	2ADh	R/W	16-bits PWM higher 8 bits [15:8] for Dot L4-CS14	00h
pwm_bri174	2AEh	R/W	16-bits PWM lower 8 bits [7:0] for Dot L4-CS15	00h
pwm_bri175	2AFh	R/W	16-bits PWM higher 8 bits [15:8] for Dot L4-CS15	00h
pwm_bri176	2B0h	R/W	16-bits PWM lower 8 bits [7:0] for Dot L4-CS16	00h
pwm_bri177	2B1h	R/W	16-bits PWM higher 8 bits [15:8] for Dot L4-CS16	00h
pwm_bri178	2B2h	R/W	16-bits PWM lower 8 bits [7:0] for Dot L4-CS17	00h
pwm_bri179	2B3h	R/W	16-bits PWM higher 8 bits [15:8] for Dot L4-CS17	00h
pwm_bri180	2B4h	R/W	16-bits PWM lower 8 bits [7:0] for Dot L5-CS0	00h
pwm_bri181	2B5h	R/W	16-bits PWM higher 8 bits [15:8] for Dot L5-CS0	00h
pwm_bri182	2B6h	R/W	16-bits PWM lower 8 bits [7:0] for Dot L5-CS1	00h
pwm_bri183	2B7h	R/W	16-bits PWM higher 8 bits [15:8] for Dot L5-CS1	00h
pwm_bri184	2B8h	R/W	16-bits PWM lower 8 bits [7:0] for Dot L5-CS2	00h
pwm_bri185	2B9h	R/W	16-bits PWM higher 8 bits [15:8] for Dot L5-CS2	00h
pwm_bri186	2BAh	R/W	16-bits PWM lower 8 bits [7:0] for Dot L5-CS3	00h
pwm_bri187	2BBh	R/W	16-bits PWM higher 8 bits [15:8] for Dot L5-CS3	00h
pwm_bri188	2BCh	R/W	16-bits PWM lower 8 bits [7:0] for Dot L5-CS4	00h
pwm_bri189	2BDh	R/W	16-bits PWM higher 8 bits [15:8] for Dot L5-CS4	00h
pwm_bri190	2BEh	R/W	16-bits PWM lower 8 bits [7:0] for Dot L5-CS5	00h
pwm_bri191	2BFh	R/W	16-bits PWM higher 8 bits [15:8] for Dot L5-CS5	00h
pwm_bri192	2C0h	R/W	16-bits PWM lower 8 bits [7:0] for Dot L5-CS6	00h
pwm_bri193	2C1h	R/W	16-bits PWM higher 8 bits [15:8] for Dot L5-CS6	00h
pwm_bri194	2C2h	R/W	16-bits PWM lower 8 bits [7:0] for Dot L5-CS7	00h
pwm_bri195	2C3h	R/W	16-bits PWM higher 8 bits [15:8] for Dot L5-CS7	00h
pwm_bri196	2C4h	R/W	16-bits PWM lower 8 bits [7:0] for Dot L5-CS8	00h
pwm_bri197	2C5h	R/W	16-bits PWM higher 8 bits [15:8] for Dot L5-CS8	00h
pwm_bri198	2C6h	R/W	16-bits PWM lower 8 bits [7:0] for Dot L5-CS9	00h
pwm_bri199	2C7h	R/W	16-bits PWM higher 8 bits [15:8] for Dot L5-CS9	00h
pwm_bri200	2C8h	R/W	16-bits PWM lower 8 bits [7:0] for Dot L5-CS10	00h
pwm_bri201	2C9h	R/W	16-bits PWM higher 8 bits [15:8] for Dot L5-CS10	00h
pwm_bri202	2CAh	R/W	16-bits PWM lower 8 bits [7:0] for Dot L5-CS11	00h
pwm_bri203	2CBh	R/W	16-bits PWM higher 8 bits [15:8] for Dot L5-CS11	00h
pwm_bri204	2CCh	R/W	16-bits PWM lower 8 bits [7:0] for Dot L5-CS12	00h
pwm_bri205	2CDh	R/W	16-bits PWM higher 8 bits [15:8] for Dot L5-CS12	00h
pwm_bri206	2CEh	R/W	16-bits PWM lower 8 bits [7:0] for Dot L5-CS13	00h

pwm_bri207	2CFh	R/W	16-bits PWM higher 8 bits [15:8] for Dot L5-CS13	00h
pwm_bri208	2D0h	R/W	16-bits PWM lower 8 bits [7:0] for Dot L5-CS14	00h
pwm_bri209	2D1h	R/W	16-bits PWM higher 8 bits [15:8] for Dot L5-CS14	00h
pwm_bri210	2D2h	R/W	16-bits PWM lower 8 bits [7:0] for Dot L5-CS15	00h
pwm_bri211	2D3h	R/W	16-bits PWM higher 8 bits [15:8] for Dot L5-CS15	00h
pwm_bri212	2D4h	R/W	16-bits PWM lower 8 bits [7:0] for Dot L5-CS16	00h
pwm_bri213	2D5h	R/W	16-bits PWM higher 8 bits [15:8] for Dot L5-CS16	00h
pwm_bri214	2D6h	R/W	16-bits PWM lower 8 bits [7:0] for Dot L5-CS17	00h
pwm_bri215	2D7h	R/W	16-bits PWM higher 8 bits [15:8] for Dot L5-CS17	00h

9 Application and Implementation

备注

Information in the following applications sections is not part of the TI component specification, and TI does not warrant its accuracy or completeness. TI's customers are responsible for determining suitability of components for their purposes, as well as validating and testing their design implementation to confirm system functionality.

9.1 Application Information

The LP5866 integrates 18 constant current sinks with 6 switching FETs and one LP5866 can drive up to 108 LED dots or 36 RGB pixels and achieve great dimming effect. In smart home, gaming keyboards, and other human-machine interaction applications, the device can greatly improve user experience with a small amount of components.

9.2 Typical Application

9.2.1 Application

图 9-1 shows an example of typical application, which uses one LP5866 to drive 36 common-anode RGB LEDs through I²C communication.



图 9-1. Typical Application - LP5866 Driving 36 RGB LEDs (108 LED Dots)

9.2.2 Design Requirements

表 9-1. Design Parameters

PARAMETER	VALUE
VCC / VIO	3.3 V
VLED	5 V
RGB LED count	66
Scan number	6
Interface	I ² C
LED maximum average current (red, green, blue)	4 mA, 3 mA, 2 mA
LED maximum peak current (red, green, blue)	44 mA, 33 mA, 22 mA

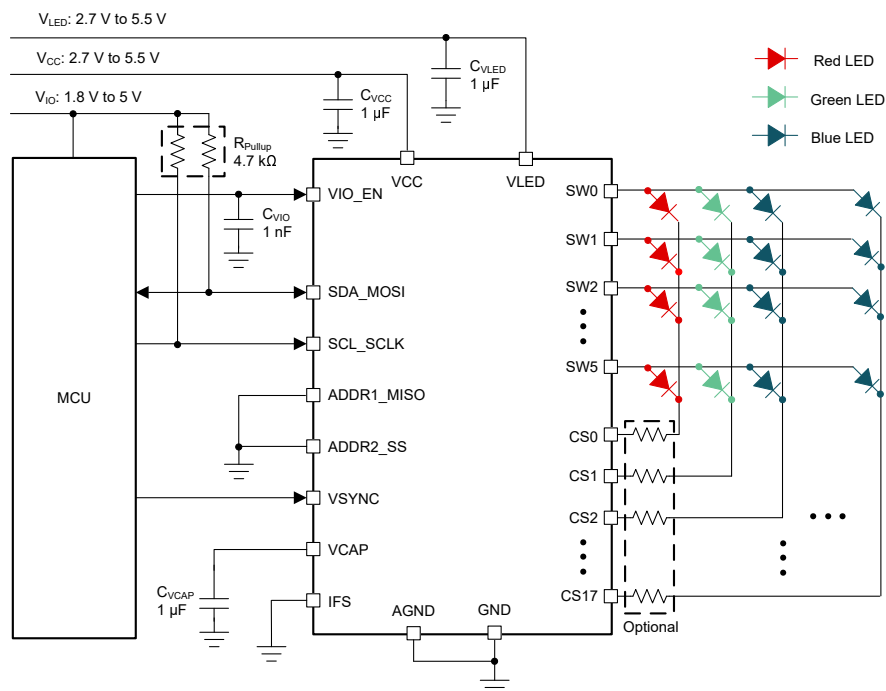
9.2.3 Detailed Design Procedure

LP5866 requires an external capacitor $C_{V_{CAP}}$, whose value is 1 μ F connected from V_{CAP} to GND for proper operation of internal LDO. The capacitor must be placed as close to the device as possible.

TI recommends 1- μ F capacitors be placed between VCC / VLED with GND, and a 1-nF capacitor placed between VIO with GND. Place the capacitors as close to the device as possible.

Pull-up resistors $R_{pull-up}$ are a requirement for SCL and SDA when using I²C as communication method. In typical applications, TI recommends 1.8-k Ω to 4.7-k Ω resistors.

To decrease thermal dissipation from device to ambient, resistors R_{CS} can optionally be placed in serial with the LED. Voltage drop on these resistors must left enough margins for VSAT to ensure the device works normally.

9.2.4 Program Procedure

When selecting data refresh Mode 1, outputs are refreshed instantly after data is received.

When selecting data refresh Mode 2/3, VSYNC signal is required for synchronized display. Programming flow is shown as 图 9-2. To display full pixel of last frame, VSYNC pulse must be sent to the device after the end of last PWM. Time between two pulses t_{VSYNC} must be larger than the whole PWM time of all Dots t_{frame} . Common selection like 60 Hz, 90 Hz, 120 Hz or even higher refresh frequency can be supported. High pulse width longer than t_{VSYNC_H} is required at the beginning of each VSYNC frame, and data must not be write to PWM registers during high pulse width.



图 9-2. Program Procedure

9.2.5 Application Performance Plots

The following figures show the application performance plots.

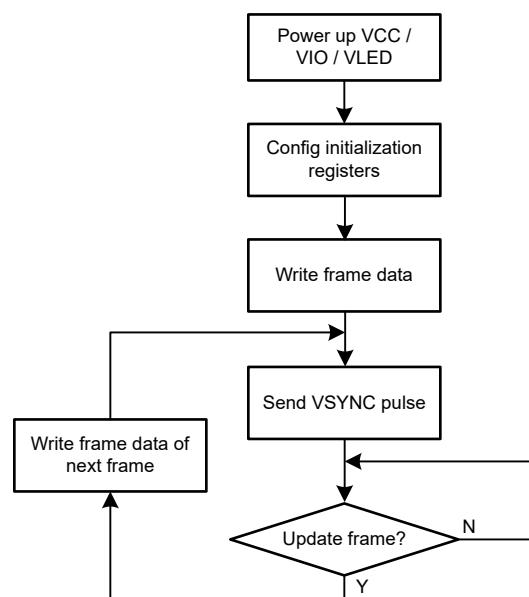

图 9-3. Scan Lines and Current Sinks Waveforms of SW0, SW1, CS0, CS1



PWM frequency = 62.5 kHz

图 9-4. Scan Lines and Current Sinks Waveforms of SW0, SW1, CS0, CS1

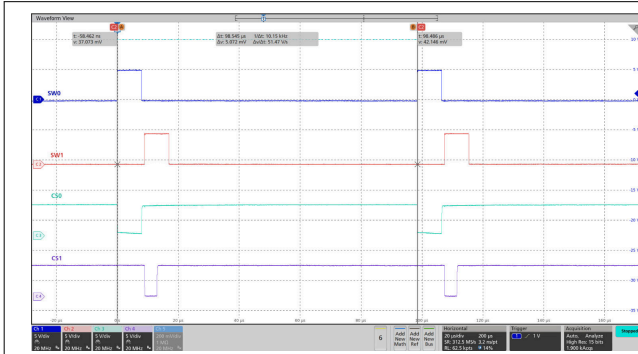
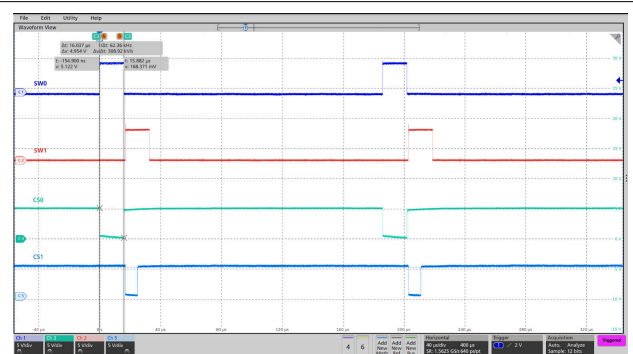
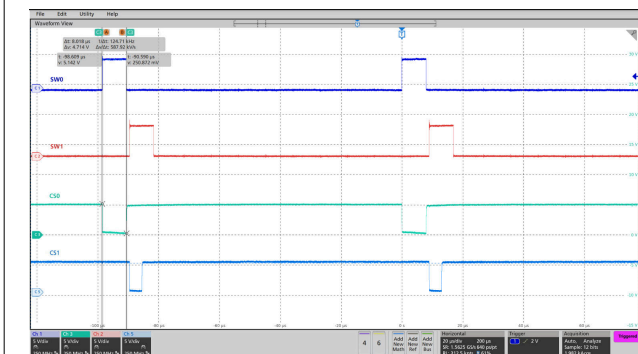

PWM frequency = 125 kHz

图 9-5. Scan Lines and Current Sinks Waveforms of SW0, SW1, CS0, CS1

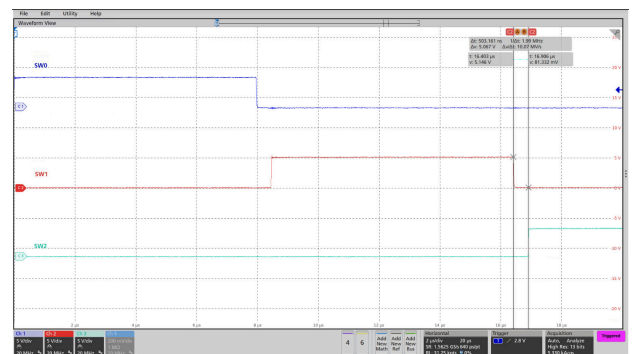

Switch blank time $t_{SW_BLK} = 0.5 \mu s$

图 9-6. Scan Lines Switching Waveforms of SW0, SW1, SW2

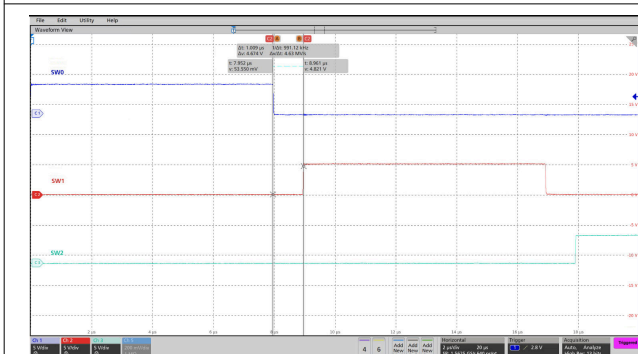

Switch blank time $t_{SW_BLK} = 1 \mu s$

图 9-7. Scan Lines Switching Waveforms of SW0, SW1, SW2

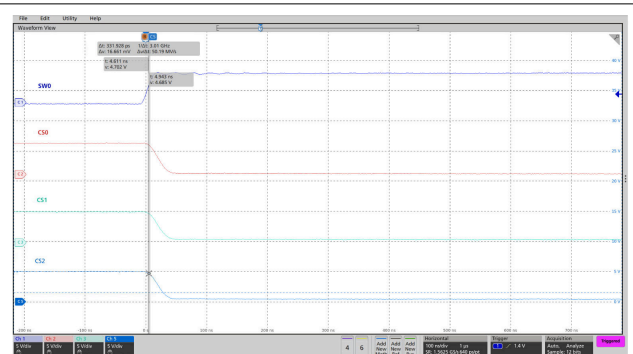

PWM_Phase_Shift = 0h

图 9-8. PWM Phase Shift Disabled

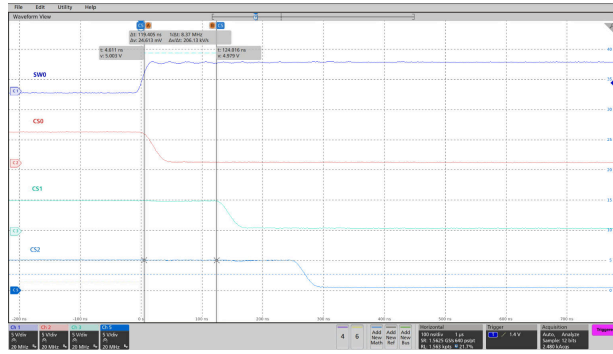

PWM_Phase_Shift = 1h

图 9-9. PWM Phase Shift Enabled

10 Power Supply Recommendations

VDD Input Supply Recommendations

LP5866 is designed to operate from a 2.7-V to 5.5-V VDD voltage supply. This input supply must be well regulated and be able to provide the peak current required by the LED matrix. The resistance of the VDD supply rail must be low enough such that the input current transient does not cause the LP5866 VDD supply voltage to drop below the maximum POR voltage.

VLED Input Supply Recommendations

LP5866 is designed to operate with a 2.7-V to 5.5-V VLED voltage supply. The VLED supply must be well regulated and able to provide the peak current required by the LED configuration without voltage drop, under load transients like start-up or rapid brightness change. The resistance of the input supply rail must be low enough so that the input current transient does not cause the VLED supply voltage to drop below LED $V_f + V_{SAT}$ voltage.

VIO Input Supply Recommendations

LP5866 is designed to operate with a 1.65-V to 5.5-V VIO_EN voltage supply. The VIO_EN supply must be well regulated and able to provide the peak current required by the LED configuration without voltage drop under load transients like start-up or rapid brightness change.

11 Layout

11.1 Layout Guidelines

the below guidelines for layout design can help to get a better on-board performance.

- The decoupling capacitors C_{VCC} and C_{VLED} for power supply must be close to the chip to have minimized the impact of high-frequency noise and ripple from power. C_{VCAP} for internal LDO must be put as close to chip as possible. GND plane connections to C_{VLED} and GND pins must be on TOP layer copper with multiple vias connecting to system ground plane. C_{VIO} for internal enable block also must be put as close to chip as possible.
- The exposed thermal pad must be well soldered to the board, which can have better mechanical reliability. The action can optimize heat transfer so that increasing thermal performance. AGND pin must be connected to thermal pad and system ground.
- The major heat flow path from the package to the ambient is through copper on the PCB. Several methods can help thermal performance. Below exposed thermal pad of IC, putting much vias through the PCB to other ground layer can dissipate more heat. Maximizing the copper coverage on the PCB can increase the thermal conductivity of the board.
- Low inductive and resistive path of switch load loop can help to provide a high slew rate. Therefore, path of VLED - SWx must be short and wide and avoid parallel wiring and narrow trace. Transient current in SWx pins is much larger than CSy pins, so that trace for SWx must be wider than CSy.

11.2 Layout Example

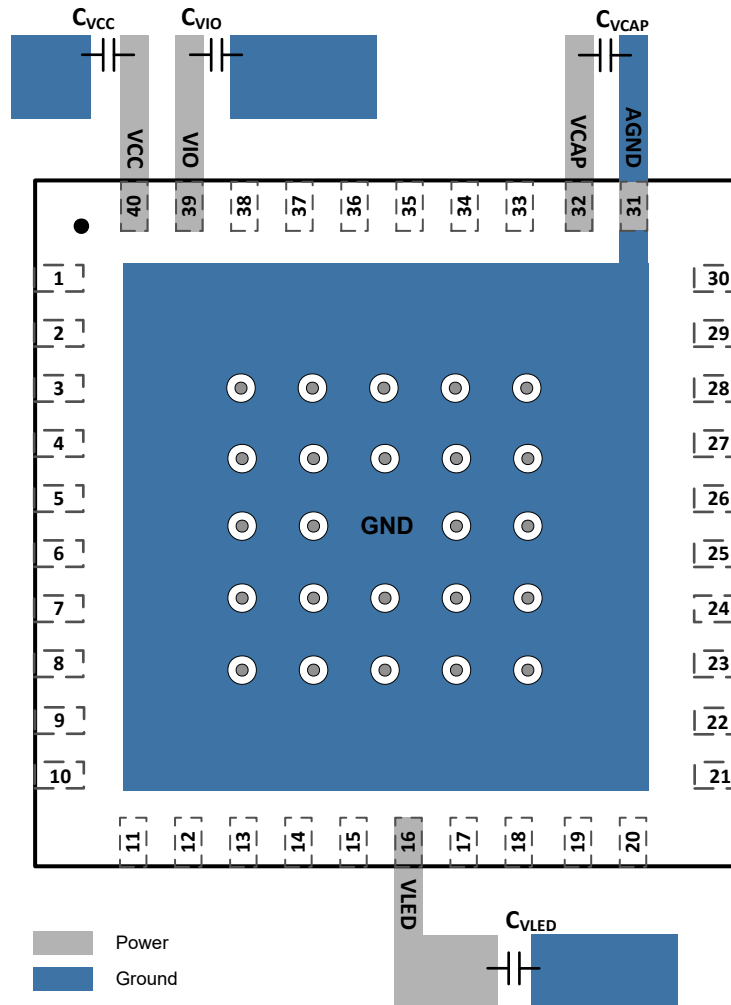

11-1. LP5866 Layout Example

12 Device and Documentation Support

TI offers an extensive line of development tools. Tools and software to evaluate the performance of the device, generate code, and develop solutions are listed below.

12.1 接收文档更新通知

要接收文档更新通知，请导航至 ti.com 上的器件产品文件夹。点击 [订阅更新](#) 进行注册，即可每周接收产品信息更改摘要。有关更改的详细信息，请查看任何已修订文档中包含的修订历史记录。

12.2 支持资源

[TI E2E™ 支持论坛](#) 是工程师的重要参考资料，可直接从专家获得快速、经过验证的解答和设计帮助。搜索现有解答或提出自己的问题可获得所需的快速设计帮助。

链接的内容由各个贡献者“按原样”提供。这些内容并不构成 TI 技术规范，并且不一定反映 TI 的观点；请参阅 TI 的 [《使用条款》](#)。

12.3 Trademarks

TI E2E™ is a trademark of Texas Instruments.

所有商标均为其各自所有者的财产。

12.4 Electrostatic Discharge Caution



This integrated circuit can be damaged by ESD. Texas Instruments recommends that all integrated circuits be handled with appropriate precautions. Failure to observe proper handling and installation procedures can cause damage.

ESD damage can range from subtle performance degradation to complete device failure. Precision integrated circuits may be more susceptible to damage because very small parametric changes could cause the device not to meet its published specifications.

12.5 术语表

[TI 术语表](#) 本术语表列出并解释了术语、首字母缩略词和定义。

13 Mechanical, Packaging, and Orderable Information

The following pages include mechanical, packaging, and orderable information. This information is the most current data available for the designated devices. This data is subject to change without notice and revision of this document. For browser-based versions of this data sheet, refer to the left-hand navigation.

PACKAGING INFORMATION

Orderable Device	Status (1)	Package Type	Package Drawing	Pins	Package Qty	Eco Plan (2)	Lead finish/ Ball material (6)	MSL Peak Temp (3)	Op Temp (°C)	Device Marking (4/5)	Samples
LP5866DBTR	ACTIVE	TSSOP	DBT	38	2000	RoHS & Green	NIPDAU	Level-2-260C-1 YEAR	-40 to 85	LP5866DBT	Samples
LP5866MDBTR	ACTIVE	TSSOP	DBT	38	2000	RoHS & Green	NIPDAU	Level-2-260C-1 YEAR	-55 to 125	5866MDBT	Samples
LP5866RKPR	ACTIVE	VQFN	RKP	40	3000	RoHS & Green	NIPDAU	Level-1-260C-UNLIM	-40 to 85	LP5866	Samples

(1) The marketing status values are defined as follows:

ACTIVE: Product device recommended for new designs.

LIFEBUY: TI has announced that the device will be discontinued, and a lifetime-buy period is in effect.

NRND: Not recommended for new designs. Device is in production to support existing customers, but TI does not recommend using this part in a new design.

PREVIEW: Device has been announced but is not in production. Samples may or may not be available.

OBSOLETE: TI has discontinued the production of the device.

(2) **RoHS:** TI defines "RoHS" to mean semiconductor products that are compliant with the current EU RoHS requirements for all 10 RoHS substances, including the requirement that RoHS substance do not exceed 0.1% by weight in homogeneous materials. Where designed to be soldered at high temperatures, "RoHS" products are suitable for use in specified lead-free processes. TI may reference these types of products as "Pb-Free".

RoHS Exempt: TI defines "RoHS Exempt" to mean products that contain lead but are compliant with EU RoHS pursuant to a specific EU RoHS exemption.

Green: TI defines "Green" to mean the content of Chlorine (Cl) and Bromine (Br) based flame retardants meet JS709B low halogen requirements of <=1000ppm threshold. Antimony trioxide based flame retardants must also meet the <=1000ppm threshold requirement.

(3) MSL, Peak Temp. - The Moisture Sensitivity Level rating according to the JEDEC industry standard classifications, and peak solder temperature.

(4) There may be additional marking, which relates to the logo, the lot trace code information, or the environmental category on the device.

(5) Multiple Device Markings will be inside parentheses. Only one Device Marking contained in parentheses and separated by a "~" will appear on a device. If a line is indented then it is a continuation of the previous line and the two combined represent the entire Device Marking for that device.

(6) Lead finish/Ball material - Orderable Devices may have multiple material finish options. Finish options are separated by a vertical ruled line. Lead finish/Ball material values may wrap to two lines if the finish value exceeds the maximum column width.

Important Information and Disclaimer:The information provided on this page represents TI's knowledge and belief as of the date that it is provided. TI bases its knowledge and belief on information provided by third parties, and makes no representation or warranty as to the accuracy of such information. Efforts are underway to better integrate information from third parties. TI has taken and continues to take reasonable steps to provide representative and accurate information but may not have conducted destructive testing or chemical analysis on incoming materials and chemicals. TI and TI suppliers consider certain information to be proprietary, and thus CAS numbers and other limited information may not be available for release.

In no event shall TI's liability arising out of such information exceed the total purchase price of the TI part(s) at issue in this document sold by TI to Customer on an annual basis.

PACKAGE OUTLINE

DBT0038A

TSSOP - 1.2 mm max height

SMALL OUTLINE PACKAGE

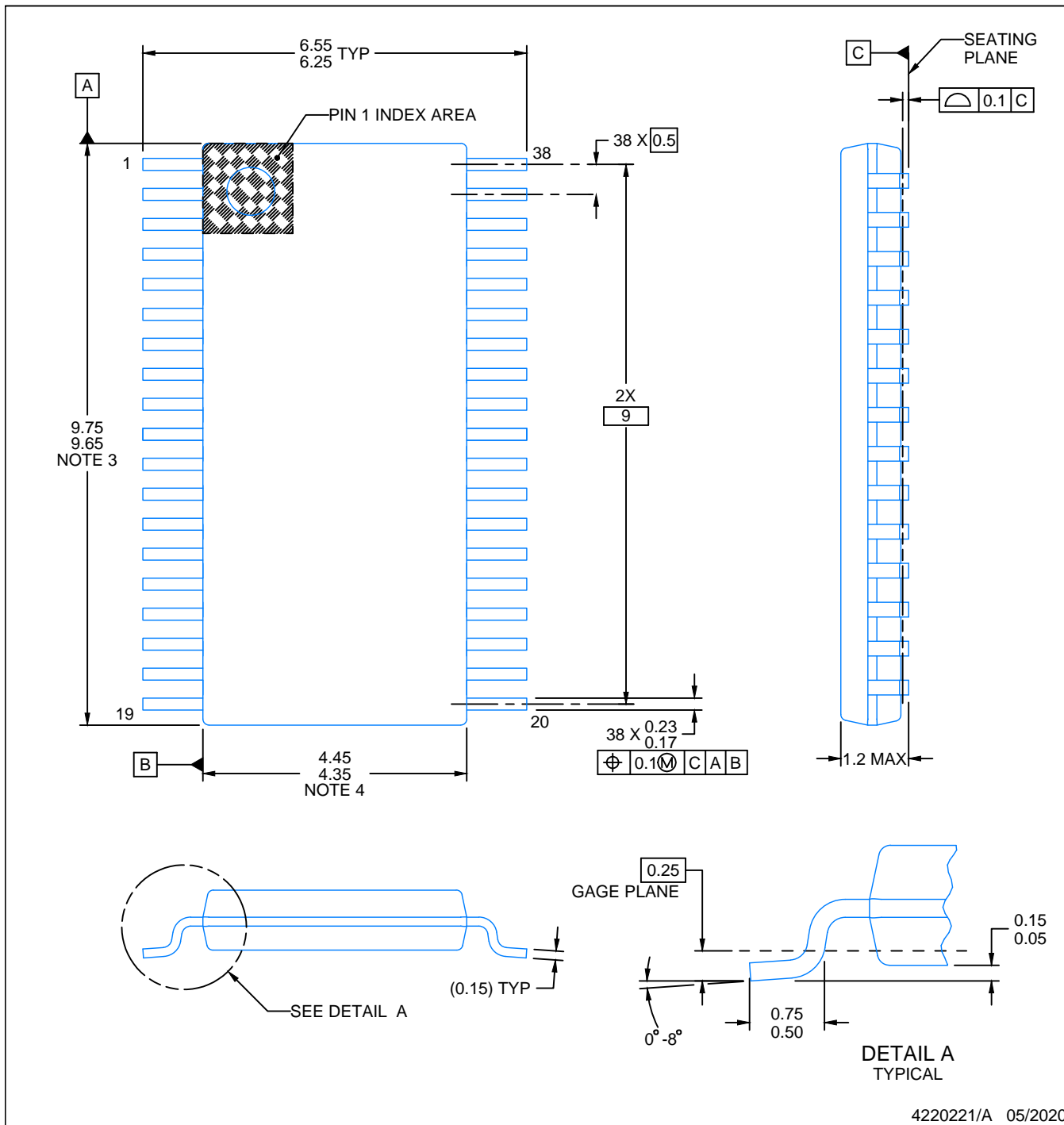

4220221/A 05/2020

NOTES:

1. All linear dimensions are in millimeters. Any dimensions in parenthesis are for reference only. Dimensioning and tolerancing per ASME Y14.5M.
2. This drawing is subject to change without notice.
3. This dimension does not include mold flash, protrusions, or gate burrs. Mold flash, protrusions, or gate burrs shall not exceed 0.15 mm per side.
4. This dimension does not include interlead flash. Interlead flash shall not exceed 0.25 mm per side.
5. Reference JEDEC registration MO-153.

EXAMPLE BOARD LAYOUT

DBT0038A

TSSOP - 1.2 mm max height

SMALL OUTLINE PACKAGE

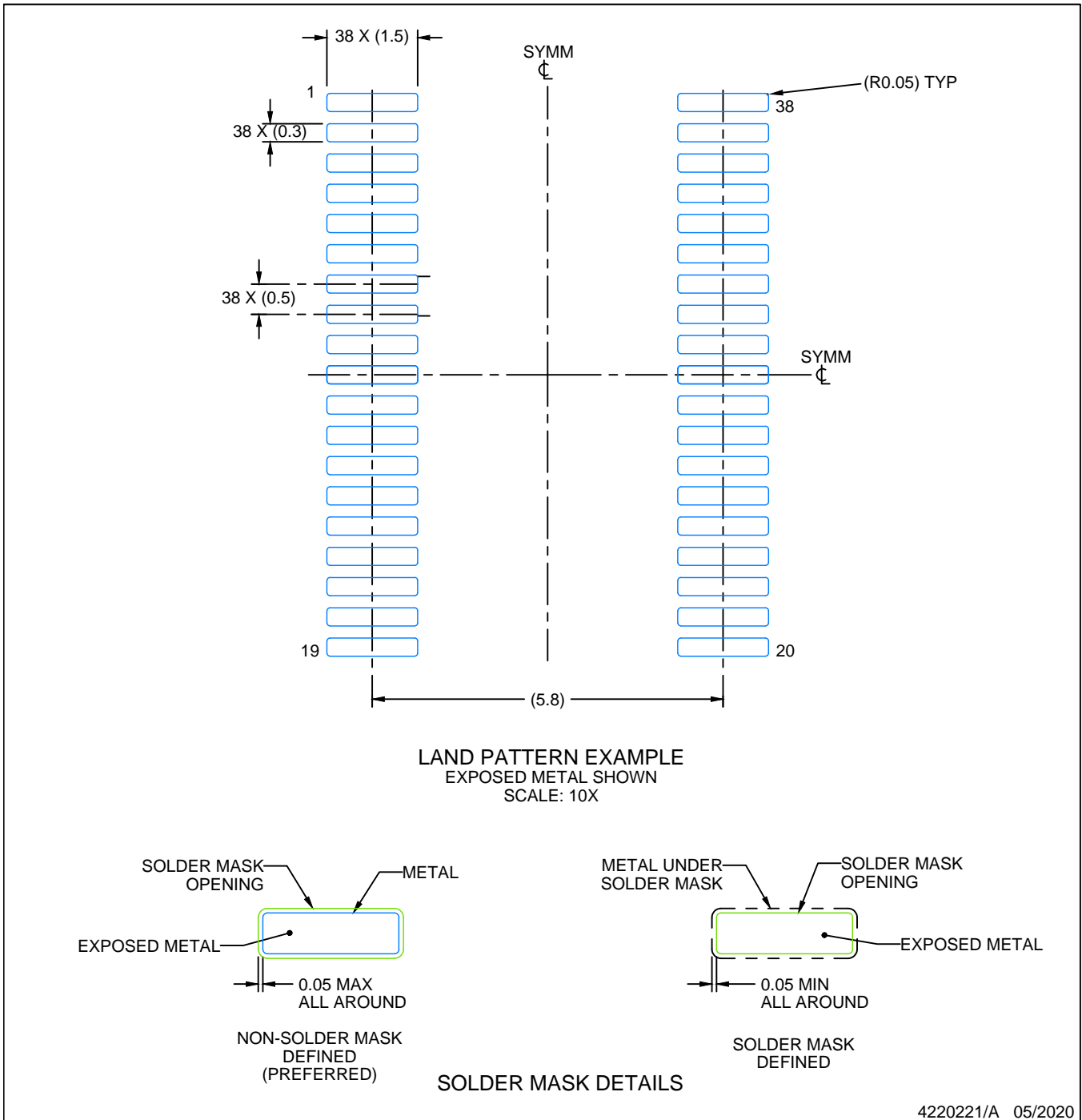

4220221/A 05/2020

NOTES: (continued)

6. Publication IPC-7351 may have alternate designs.

7. Solder mask tolerances between and around signal pads can vary based on board fabrication site.

EXAMPLE STENCIL DESIGN

DBT0038A

TSSOP - 1.2 mm max height

SMALL OUTLINE PACKAGE

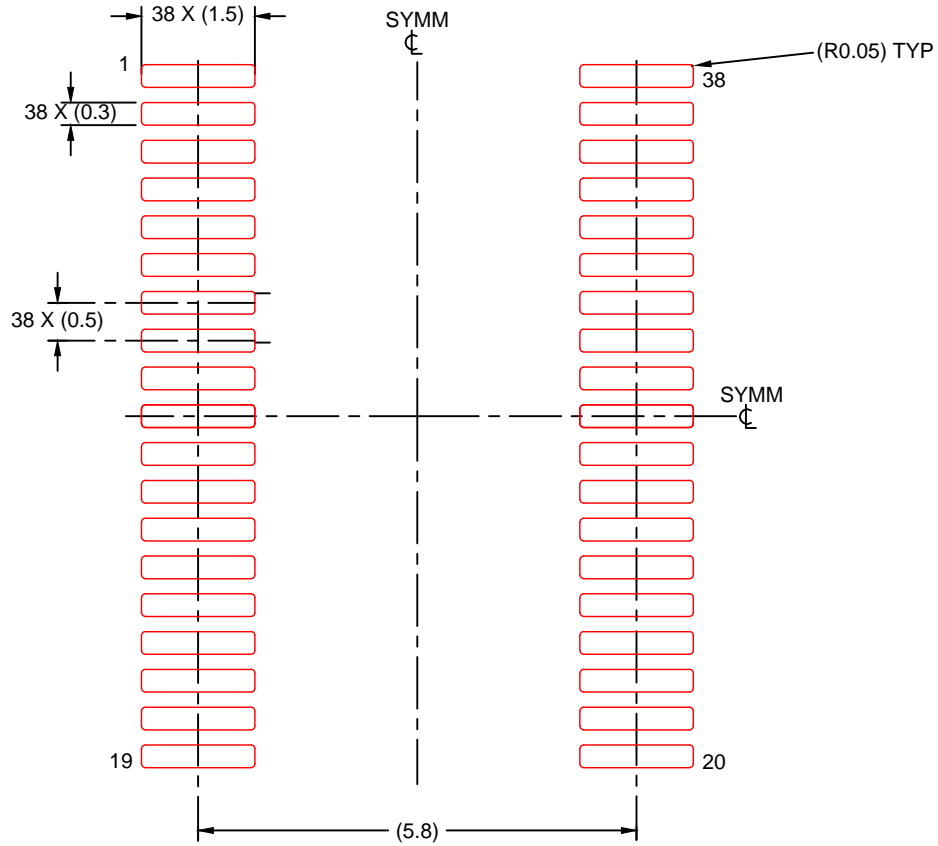

SOLDER PASTE EXAMPLE
BASED ON 0.125 mm THICK STENCIL
SCALE: 10X

4220221/A 05/2020

NOTES: (continued)

8. Laser cutting apertures with trapezoidal walls and rounded corners may offer better paste release. IPC-7525 may have alternate design recommendations.
9. Board assembly site may have different recommendations for stencil design.

GENERIC PACKAGE VIEW

RKP 40

VQFN - 1 mm max height

5 x 5, 0.4 mm pitch

PLASTIC QUAD FLATPACK - NO LEAD

This image is a representation of the package family, actual package may vary.
Refer to the product data sheet for package details.

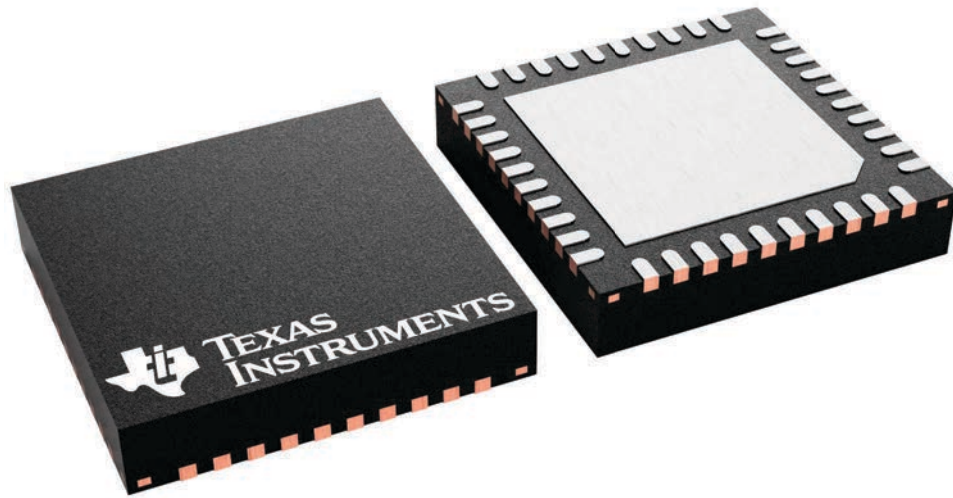

4229305/A

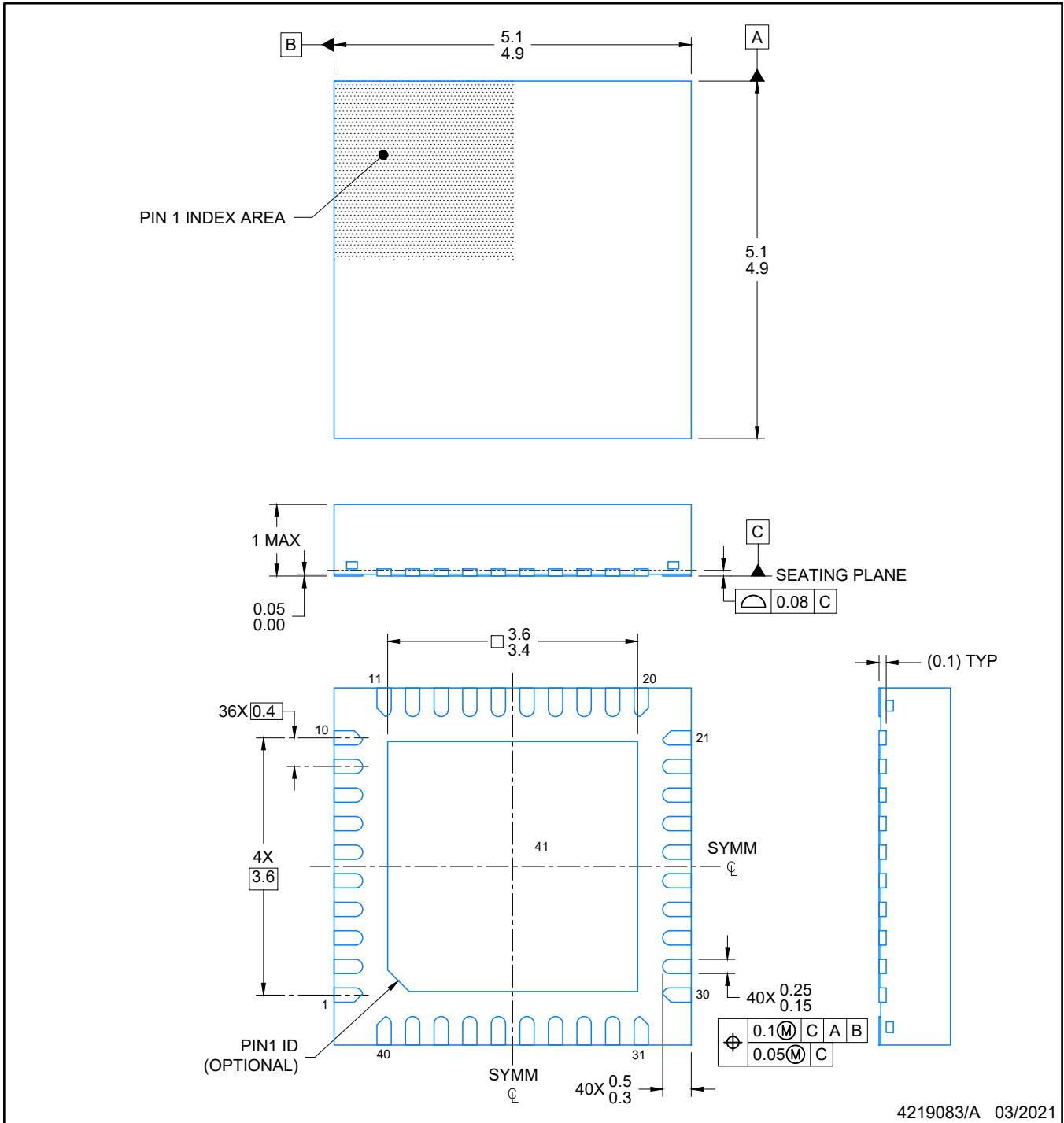

NOTES:

1. All linear dimensions are in millimeters. Any dimensions in parenthesis are for reference only. Dimensioning and tolerancing per ASME Y14.5M.
2. This drawing is subject to change without notice.
3. The package thermal pad must be soldered to the printed circuit board for optimal thermal and mechanical performance.

EXAMPLE BOARD LAYOUT

RKP0040B

VQFN - 1 mm max height

PLASTIC QUAD FLATPACK- NO LEAD

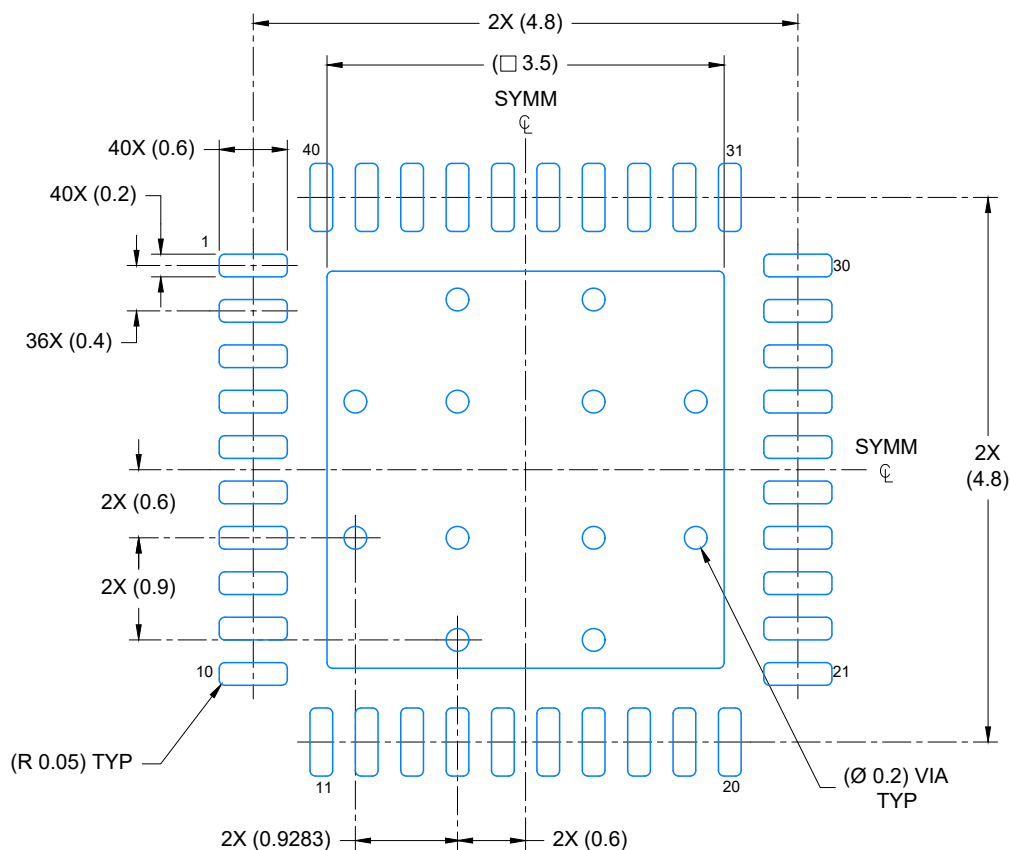

LAND PATTERN EXAMPLE

EXPOSED METAL SHOWN

SCALE: 15X

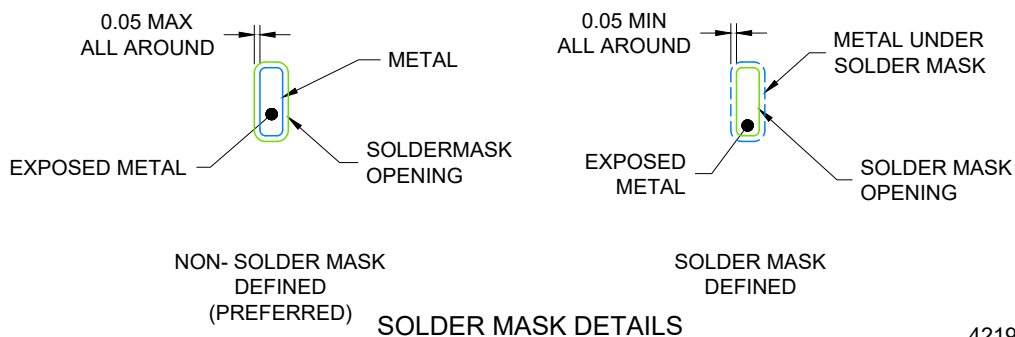

4219083/A 03/2021

NOTES: (continued)

- This package is designed to be soldered to a thermal pad on the board. For more information, see Texas Instruments literature number SLUA271 (www.ti.com/lit/slua271).
- Vias are optional depending on application, refer to device data sheet. If any vias are implemented, refer to their locations shown on this view. It is recommended that vias under paste be filled, plugged or tented.

EXAMPLE STENCIL DESIGN

VQFN - 1 mm max height

RKP0040B

PLASTIC QUAD FLATPACK- NO LEAD

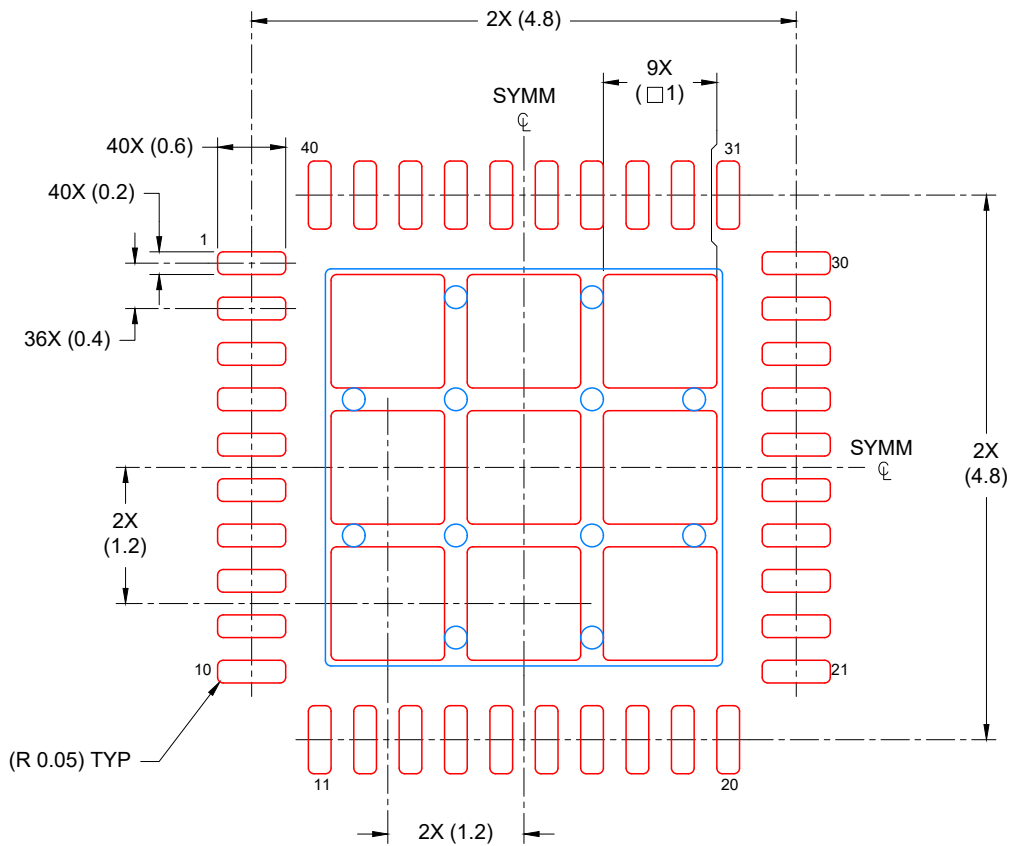

SOLDER PASTE EXAMPLE
BASED ON 0.125 mm THICK STENCIL

EXPOSED PAD
74% PRINTED COVERAGE BY AREA
SCALE: 15X

4219083/A 03/2021

NOTES: (continued)

6. Laser cutting apertures with trapezoidal walls and rounded corners may offer better paste release. IPC-7525 may have alternate design recommendations.

重要声明和免责声明

TI“按原样”提供技术和可靠性数据（包括数据表）、设计资源（包括参考设计）、应用或其他设计建议、网络工具、安全信息和其他资源，不保证没有瑕疵且不做任何明示或暗示的担保，包括但不限于对适销性、某特定用途方面的适用性或不侵犯任何第三方知识产权的暗示担保。

这些资源可供使用 TI 产品进行设计的熟练开发人员使用。您将自行承担以下全部责任：(1) 针对您的应用选择合适的 TI 产品，(2) 设计、验证并测试您的应用，(3) 确保您的应用满足相应标准以及任何其他功能安全、信息安全、监管或其他要求。

这些资源如有变更，恕不另行通知。TI 授权您仅可将这些资源用于研发本资源所述的 TI 产品的应用。严禁对这些资源进行其他复制或展示。您无权使用任何其他 TI 知识产权或任何第三方知识产权。您应全额赔偿因在这些资源的使用中对 TI 及其代表造成的任何索赔、损害、成本、损失和债务，TI 对此概不负责。

TI 提供的产品受 [TI 的销售条款](#) 或 [ti.com](#) 上其他适用条款/TI 产品随附的其他适用条款的约束。TI 提供这些资源并不会扩展或以其他方式更改 TI 针对 TI 产品发布的适用的担保或担保免责声明。

TI 反对并拒绝您可能提出的任何其他或不同的条款。

邮寄地址：Texas Instruments, Post Office Box 655303, Dallas, Texas 75265

Copyright © 2024，德州仪器 (TI) 公司