

具有缓冲电刷的 TPL1401 256 抽头高精度数字电位器

1 特性

- 适用于分压器应用的 256 抽头数字电位器
- 1 LSB INL 和 DNL
- 宽工作范围
 - 电源：1.8V 至 5.5V
 - 温度范围：-40°C 至 +125°C
- 用于改善负载调节的缓冲刷
- 用于精密电流吸收器应用的反馈引脚
- 电刷锁定功能可防止对数字电位器意外写入
- I²C 接口
 - 标准、快速和快速+ 模式
 - 1.62V V_{IH} (V_{DD} = 5.5V)
- 用户可编程的非易失性存储器 (NVM/EEPROM)
 - 保存和撤销所有寄存器设置
- 内部基准
- 功耗极低：在 1.8V 时为 0.2 mA
- 灵活启动：高阻抗或 10K-GND
- 微型封装：8 引脚 WSON (2mm × 2mm)

2 应用

- 出口和紧急照明
- 条形码扫描仪
- 条形码读取器
- 智能扬声器
- 可视门铃
- 无线真空吸尘器
- 割草机器人
- 激光测距仪

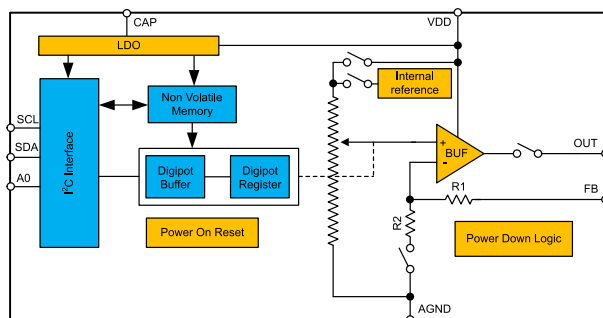

功能方框图

3 说明

TPL1401 是一款具有缓冲电刷的数字电位器。与标准数字电位器不同，该器件具有集成缓冲电刷，可帮助分压器应用实现较高负载调节。

TPL1401 集成了非易失性存储器 (NVM)，可以让工厂校准和修整变得更加轻松，另外还提供用于器件通信的简单 I²C 数字接口。该器件支持 I²C 标准模式 (100kbps)、快速模式 (400kbps) 和快速+ 模式 (1Mbps)。

TPL1401 在内部基准或电源基准下运行，提供 1.8V 至 5.5V 的满量程输出。该器件还具备电刷锁定特性，具有用于电流吸收器应用的反馈 (FB) 引脚，以及 2 字节的用户可编程 NVM 空间。TPL1401 具有上电复位 (POR) 电路，可确保所有寄存器以默认设置或使用 NVM 的用户编程设置启动。数字电位器输出在高阻抗模式下通电 (默认)；可以使用 NVM 将此设置编程为 10kΩ-GND。

TPL1401 是一款小巧型构建块器件，功能丰富，简单易用，可集成到许多应用中。

TPL1401 的工作温度范围为 -40°C 至 +125°C。

器件信息(1)

器件型号	封装	封装尺寸 (标称值)
TPL1401	WSON (8)	2.00mm × 2.00mm

(1) 如需了解所有可用封装，请参阅数据表末尾的封装选项附录。

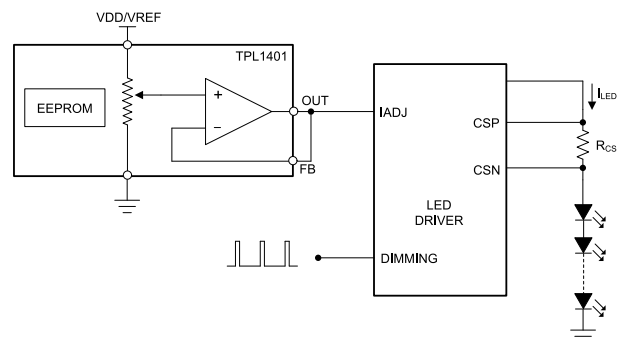

通过 TPL1401 实现可编程电流限制



Table of Contents

1 特性	1	7.2 Functional Block Diagram.....	17
2 应用	1	7.3 Feature Description.....	18
3 说明	1	7.4 Device Functional Modes.....	21
4 Revision History	2	7.5 Programming.....	22
5 Pin Configuration and Functions	3	7.6 Register Map.....	26
6 Specifications	4	8 Application and Implementation	30
6.1 Absolute Maximum Ratings	4	8.1 Application Information.....	30
6.2 ESD Ratings	4	8.2 Typical Application.....	30
6.3 Recommended Operating Conditions	4	9 Power Supply Recommendations	32
6.4 Thermal Information	4	10 Layout	32
6.5 Electrical Characteristics	5	10.1 Layout Guidelines.....	32
6.6 Timing Requirements: I ² C Standard Mode	7	10.2 Layout Example.....	32
6.7 Timing Requirements: I ² C Fast Mode	7	11 Device and Documentation Support	33
6.8 Timing Requirements: I ² C Fast Mode Plus	7	11.1 Documentation Support.....	33
6.9 Typical Characteristics: V _{DD} = 1.8 V (Reference = V _{DD}) or V _{DD} = 2 V (Internal Reference).....	8	11.2 接收文档更新通知.....	33
6.10 Typical Characteristics: V _{DD} = 5.5 V (Reference = V _{DD}) or V _{DD} = 5 V (Internal Reference).....	10	11.3 支持资源.....	33
6.11 Typical Characteristics.....	12	11.4 Trademarks.....	33
7 Detailed Description	17	11.5 静电放电警告.....	33
7.1 Overview.....	17	11.6 术语表.....	33
		12 Mechanical, Packaging, and Orderable Information	33

4 Revision History

DATE	REVISION	NOTES
September 2020	*	Initial release.

5 Pin Configuration and Functions



图 5-1. DSG Package, 8-Pin WSON, Top View

Pin Functions

PIN		TYPE	DESCRIPTION
NAME	NO.		
A0	1	Input	Four-state address input
AGND	5	Ground	Ground reference point for all circuitry on the device
CAP	4	Input	External capacitor for the internal LDO. Connect a capacitor (around 1.5 μ F) between CAP and AGND.
FB	7	Input	Voltage feedback pin
OUT	8	Output	Analog output voltage from digipot buffer
SCL	2	Input	Serial interface clock. This pin must be connected to the supply voltage with an external pullup resistor.
SDA	3	Input/output	Data are clocked into or out of the input register. This pin is a bidirectional, and must be connected to the supply voltage with an external pullup resistor.
VDD	6	Power or reference input	Analog supply voltage: 1.8 V to 5.5 V

6 Specifications

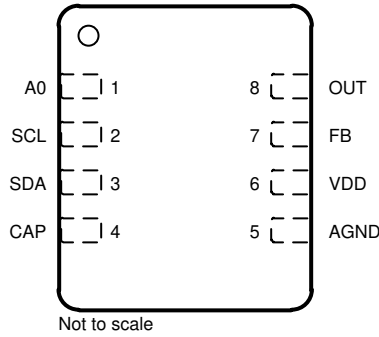
6.1 Absolute Maximum Ratings

over operating free-air temperature range (unless otherwise noted)⁽¹⁾

		MIN	MAX	UNIT
V _{DD}	Supply voltage / reference, V _{DD} to A _{GND}	- 0.3	6	V
	Digital input(s) to A _{GND}	- 0.3	V _{DD} + 0.3	V
	CAP to A _{GND}	- 0.3	1.65	V
	V _{FB} to A _{GND}	- 0.3	V _{DD} + 0.3	V
	V _{OUT} to A _{GND}	- 0.3	V _{DD} + 0.3	V
	Current into any pin	- 10	10	mA
T _J	Junction temperature	- 40	150	°C
T _{stg}	Storage temperature	- 65	150	°C

- (1) Stresses beyond those listed under *Absolute Maximum Rating* may cause permanent damage to the device. These are stress ratings only, which do not imply functional operation of the device at these or any other conditions beyond those indicated under *Recommended Operating Condition*. Exposure to absolute-maximum-rated conditions for extended periods may affect device reliability.

6.2 ESD Ratings

			VALUE	UNIT
V _(ESD)	Electrostatic discharge	Human body model (HBM), per ANSI/ESDA/JEDEC JS-001, all pins ⁽¹⁾	±2000	V
		Charged device model (CDM), per JEDEC specification JESD22-C101, pins 1, 4, 5, 8 ⁽²⁾	±750	
		Charged device model (CDM), per JEDEC specification JESD22-C101, pins 2, 3, 6, 7 ⁽²⁾	±500	

- (1) JEDEC document JEP155 states that 500-V HBM allows safe manufacturing with a standard ESD control process.
 (2) JEDEC document JEP157 states that 250-V CDM allows safe manufacturing with a standard ESD control process.

6.3 Recommended Operating Conditions

over operating free-air temperature range (unless otherwise noted)

		MIN	NOM	MAX	UNIT
V _{DD}	Positive supply voltage to ground (A _{GND})	1.71		5.5	V
V _{IH}	Digital input high voltage, 1.7 V < V _{DD} ≤ 5.5 V	1.62			V
V _{IL}	Digital input low voltage			0.4	V
T _A	Ambient temperature	- 40		125	°C

6.4 Thermal Information

THERMAL METRIC ⁽¹⁾		TPL1401	UNIT
		DSG (WSON)	
		8 PINS	
R _{θJA}	Junction-to-ambient thermal resistance	49	°C/W
R _{θJC(top)}	Junction-to-case (top) thermal resistance	50	°C/W
R _{θJB}	Junction-to-board thermal resistance	24.1	°C/W
Ψ _{JT}	Junction-to-top characterization parameter	1.1	°C/W
Ψ _{JB}	Junction-to-board characterization parameter	24.1	°C/W
R _{θJC(bot)}	Junction-to-case (bottom) thermal resistance	8.7	°C/W

- (1) For more information about traditional and new thermal metrics, see the [Semiconductor and IC Package Thermal Metrics application report](#).

6.5 Electrical Characteristics

all minimum/maximum specifications at $T_A = -40^\circ\text{C}$ to $+125^\circ\text{C}$ and typical specifications at $T_A = 25^\circ\text{C}$, $1.8\text{ V} \leq V_{DD} \leq 5.5\text{ V}$, reference tied to V_{DD} , gain = 1x, digipot output pin (OUT) loaded with resistive load ($R_L = 5\text{ k}\Omega$ to AGND) and capacitive load ($C_L = 200\text{ pF}$ to AGND), and digital inputs at V_{DD} or AGND (unless otherwise noted)

PARAMETER		TEST CONDITIONS	MIN	TYP	MAX	UNIT
STATIC PERFORMANCE						
	Resolution		8			Bits
INL	Relative accuracy ⁽¹⁾		- 1		1	LSB
DNL	Differential nonlinearity ⁽¹⁾		- 1		1	LSB
	Zero code error	Code 0d into digipot		6	12	mV
		Internal V_{REF} , gain = 4x, $V_{DD} = 5.5\text{ V}$		6	15	
	Zero code error temperature coefficient			± 10		$\mu\text{V}/^\circ\text{C}$
	Offset error	V_{REF} tied to V_{DD} , measured between end-point codes 2d and 254d, output unloaded	- 0.5	0.25	0.5	%FSR
	Offset error temperature coefficient	V_{REF} tied to V_{DD} , measured between end-point codes 2d and 254d, output unloaded		± 0.0003		%FSR/ $^\circ\text{C}$
	Gain error	V_{REF} tied to V_{DD} , measured between end-point codes 2d and 254d, output unloaded	- 0.5	0.25	0.5	%FSR
	Gain error temperature coefficient	V_{REF} tied to V_{DD} , measured between end-point codes 2d and 254d, output unloaded		± 0.0008		%FSR/ $^\circ\text{C}$
	Full scale error	$1.8\text{ V} \leq V_{DD} < 2.7\text{ V}$, code 511d into digipot, no headroom	- 1	0.5	1	%FSR
		$2.7\text{ V} \leq V_{DD} \leq 5.5\text{ V}$, code 511d into digipot, no headroom	- 0.5	0.25	0.5	
	Full scale error temperature coefficient			± 0.0008		%FSR/ $^\circ\text{C}$
OUTPUT CHARACTERISTICS						
	Output voltage	Reference tied to V_{DD}	0		5.5	V
C_L	Capacitive load ⁽²⁾	$R_L = \text{Infinite}$, phase margin = 30°			1	nF
		$R_L = 5\text{ k}\Omega$, phase margin = 30°			2	
	Load regulation	Digipot at midscale, $-10\text{ mA} \leq I_{OUT} \leq 10\text{ mA}$, $V_{DD} = 5.5\text{ V}$		0.4		mV/mA
	Short circuit current	$V_{DD} = 1.8\text{ V}$, full-scale output shorted to A_{GND} or zero-scale output shorted to V_{DD}		10		mA
		$V_{DD} = 2.7\text{ V}$, full-scale output shorted to A_{GND} or zero-scale output shorted to V_{DD}		25		
		$V_{DD} = 5.5\text{ V}$, full-scale output shorted to A_{GND} or zero-scale output shorted to V_{DD}		50		
	Output voltage headroom ⁽¹⁾	To V_{DD} (digipot output unloaded, internal reference = 1.21 V), $V_{DD} \geq 1.21 \times \text{gain} + 0.2\text{ V}$		0.2		V
		To V_{DD} (digipot output unloaded)		0.8		
		To V_{DD} ($I_{LOAD} = 10\text{ mA}$ at $V_{DD} = 5.5\text{ V}$, $I_{LOAD} = 3\text{ mA}$ at $V_{DD} = 2.7\text{ V}$, $I_{LOAD} = 1\text{ mA}$ at $V_{DD} = 1.8\text{ V}$), digipot code = full scale	10			
	V_{OUT} dc output impedance	Digipot output enabled and digipot code = midscale		0.25		Ω
		Digipot output enabled and digipot code = 2d		0.25		
		Digipot output enabled and digipot code = 254d		0.26		
Z_O	V_{FB} dc output impedance ⁽³⁾	Digipot output enabled	160	200	240	$\text{k}\Omega$
	$V_{OUT} + V_{FB}$ dc output leakage ⁽²⁾	At start up, measured when digipot output is disabled and held at $V_{DD} / 2$ for $V_{DD} = 5.5\text{ V}$			5	nA

all minimum/maximum specifications at $T_A = -40^\circ\text{C}$ to $+125^\circ\text{C}$ and typical specifications at $T_A = 25^\circ\text{C}$, $1.8\text{ V} \leq V_{DD} \leq 5.5\text{ V}$, reference tied to V_{DD} , gain = 1x, digipot output pin (OUT) loaded with resistive load ($R_L = 5\text{ k}\Omega$ to AGND) and capacitive load ($C_L = 200\text{ pF}$ to AGND), and digital inputs at V_{DD} or AGND (unless otherwise noted)

PARAMETER		TEST CONDITIONS	MIN	TYP	MAX	UNIT
	Power supply rejection ratio (dc)	Internal V_{REF} , gain = 2x, digipot at midscale; $V_{DD} = 5\text{ V} \pm 10\%$		0.25		mV/V
DYNAMIC PERFORMANCE						
t_{sett}	Output voltage settling time	1/4 to 3/4 scale and 3/4 to 1/4 scale settling to 10%FSR, $V_{DD} = 5.5\text{ V}$		8		μs
		1/4 to 3/4 scale and 3/4 to 1/4 scale settling to 10%FSR, $V_{DD} = 5.5\text{ V}$, internal V_{REF} , gain = 4x		12		
	Slew rate	$V_{DD} = 5.5\text{ V}$		1		V/ μs
	Power on glitch magnitude	At start up (buffer output disabled), $R_L = 5\text{ k}\Omega$, $C_L = 200\text{ pF}$		75		mV
		At start up (buffer output disabled), $R_L = 100\text{ k}\Omega$		200		
	Output enable glitch magnitude	Buffer output disabled to enabled (digipot registers at zero scale, $R_L = 100\text{ k}\Omega$)		250		mV
V_n	Output noise voltage (peak to peak)	0.1 Hz to 10 Hz, digipot at midscale, $V_{DD} = 5.5\text{ V}$		34		μV_{PP}
		Internal V_{REF} , gain = 4x, 0.1 Hz to 10 Hz, digipot at midscale, $V_{DD} = 5.5\text{ V}$		70		
	Output noise density	Measured at 1 kHz, digipot at midscale, $V_{DD} = 5.5\text{ V}$		0.2		$\mu\text{V}/\sqrt{\text{Hz}}$
		Internal V_{REF} , gain = 4x, measured at 1 kHz, digipot at midscale, $V_{DD} = 5.5\text{ V}$		0.7		
	Power supply rejection ratio (ac) ⁽³⁾	Internal V_{REF} , gain = 4x, 200-mV 50 or 60 Hz sine wave superimposed on power supply voltage, digipot at midscale		-71		dB
	Code change glitch impulse	± 1 LSB change around mid code (including feedthrough)		10		nV-s
	Code change glitch impulse magnitude	± 1 LSB change around mid code (including feedthrough)		15		mV
VOLTAGE REFERENCE						
	Initial accuracy	$T_A = 25^\circ\text{C}$		1.212		V
	Reference output temperature coefficient ⁽²⁾				50	ppm/ $^\circ\text{C}$
EEPROM						
	Endurance	$-40^\circ\text{C} \leq T_A \leq 85^\circ\text{C}$		20000		Cycles
		$T_A > 85^\circ\text{C}$		1000		
	Data retention ⁽²⁾	$T_A = 25^\circ\text{C}$		50		Years
	EEPROM programming write cycle time ⁽²⁾		10		20	ms
DIGITAL INPUTS						
	Digital feedthrough	Digipot output static at midscale, fast mode plus, SCL toggling		20		nV-s
	Pin capacitance	Per pin		10		pF
POWER						
	Load capacitor - CAP pin ⁽²⁾		0.5		15	μF
I_{DD}	Current flowing into VDD	Normal mode, digipot at full scale, digital pins static		0.5	0.8	mA
		Digipot power-down, internal reference power down		80		μA

(1) Measured with digipot output unloaded. For external reference between end-point codes 2d and 254d. For internal reference $V_{DD} \geq 1.21 \times \text{gain} + 0.2\text{ V}$, between end-point codes 2d and 254d.

(2) Specified by design and characterization, not production tested.

(3) Specified with 200-mV headroom with respect to reference value when internal reference is used.

6.6 Timing Requirements: I²C Standard Mode

all input signals are timed from V_{IL} to 70% of V_{DD}, 1.8 V ≤ V_{DD} ≤ 5.5 V, -40°C ≤ T_A ≤ +125°C, and 1.8 V ≤ V_{pull-up} ≤ V_{DD} (unless otherwise specified)

		MIN	NOM	MAX	UNIT
f _{SCLK}	SCL frequency			0.1	MHz
t _{BUF}	Bus free time between stop and start conditions	4.7			μs
t _{HDSTA}	Hold time after repeated start	4			μs
t _{SUSTA}	Repeated start setup time	4.7			μs
t _{SUSTO}	Stop condition setup time	4			μs
t _{HDDAT}	Data hold time	0			ns
t _{SUDAT}	Data setup time	250			ns
t _{LOW}	SCL clock low period	4700			ns
t _{HIGH}	SCL clock high period	4000			ns
t _F	Clock and data fall time			300	ns
t _R	Clock and data rise time			1000	ns

6.7 Timing Requirements: I²C Fast Mode

all input signals are timed from V_{IL} to 70% of V_{DD}, 1.8 V ≤ V_{DD} ≤ 5.5 V, -40°C ≤ T_A ≤ +125°C, and 1.8 V ≤ V_{pull-up} ≤ V_{DD} (unless otherwise specified)

		MIN	NOM	MAX	UNIT
f _{SCLK}	SCL frequency			0.4	MHz
t _{BUF}	Bus free time between stop and start conditions	1.3			μs
t _{HDSTA}	Hold time after repeated start	0.6			μs
t _{SUSTA}	Repeated start setup time	0.6			μs
t _{SUSTO}	Stop condition setup time	0.6			μs
t _{HDDAT}	Data hold time	0			ns
t _{SUDAT}	Data setup time	100			ns
t _{LOW}	SCL clock low period	1300			ns
t _{HIGH}	SCL clock high period	600			ns
t _F	Clock and data fall time			300	ns
t _R	Clock and data rise time			300	ns

6.8 Timing Requirements: I²C Fast Mode Plus

all input signals are timed from V_{IL} to 70% of V_{DD}, 1.8 V ≤ V_{DD} ≤ 5.5 V, -40°C ≤ T_A ≤ +125°C, and 1.8 V ≤ V_{pull-up} ≤ V_{DD} (unless otherwise specified)

		MIN	NOM	MAX	UNIT
f _{SCLK}	SCL frequency			1	MHz
t _{BUF}	Bus free time between stop and start conditions	0.5			μs
t _{HDSTA}	Hold time after repeated start	0.26			μs
t _{SUSTA}	Repeated start setup time	0.26			μs
t _{SUSTO}	Stop condition setup time	0.26			μs
t _{HDDAT}	Data hold time	0			ns
t _{SUDAT}	Data setup time	50			ns
t _{LOW}	SCL clock low period	0.5			μs
t _{HIGH}	SCL clock high period	0.26			μs
t _F	Clock and data fall time			120	ns
t _R	Clock and data rise time			120	ns

6.9 Typical Characteristics: $V_{DD} = 1.8\text{ V}$ (Reference = V_{DD}) or $V_{DD} = 2\text{ V}$ (Internal Reference)

at $T_A = 25^\circ\text{C}$ and digipot outputs unloaded (unless otherwise noted)



图 6-1. Integral Linearity Error vs Digital Input Code



图 6-2. Differential Linearity Error vs Digital Input Code

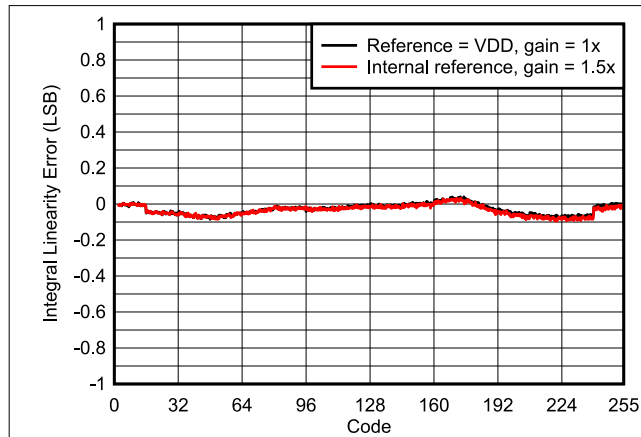

图 6-3. Total Unadjusted Error vs Digital Input Code

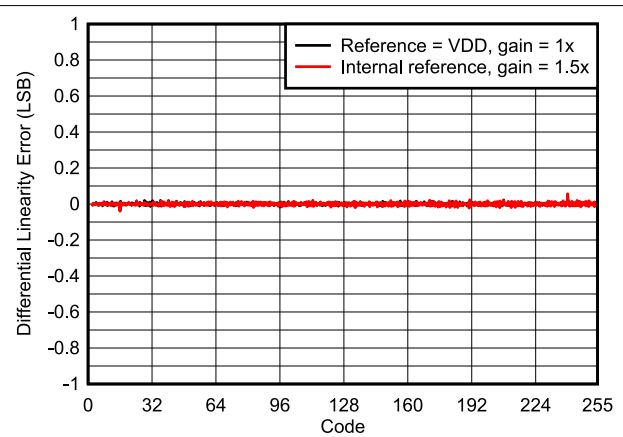

图 6-4. Integral Linearity Error vs Temperature

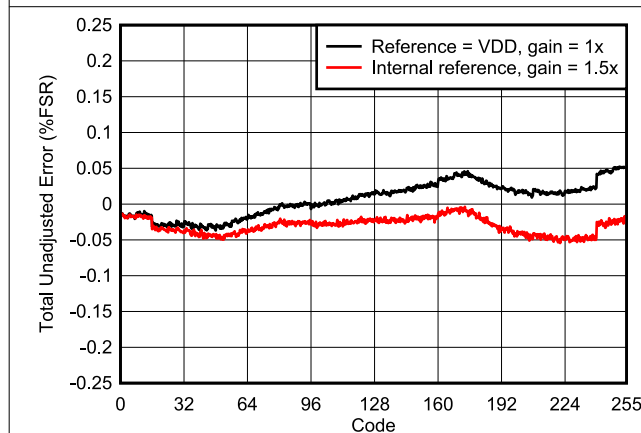

图 6-5. Differential Linearity Error vs Temperature

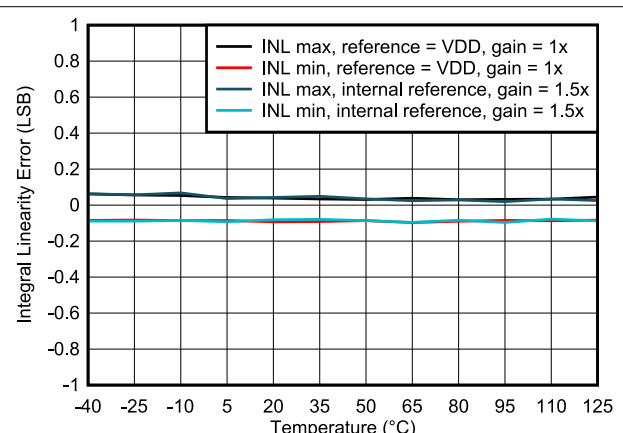

图 6-6. Total Unadjusted Error vs Temperature

6.9 Typical Characteristics: $V_{DD} = 1.8\text{ V}$ (Reference = V_{DD}) or $V_{DD} = 2\text{ V}$ (Internal Reference) (continued)

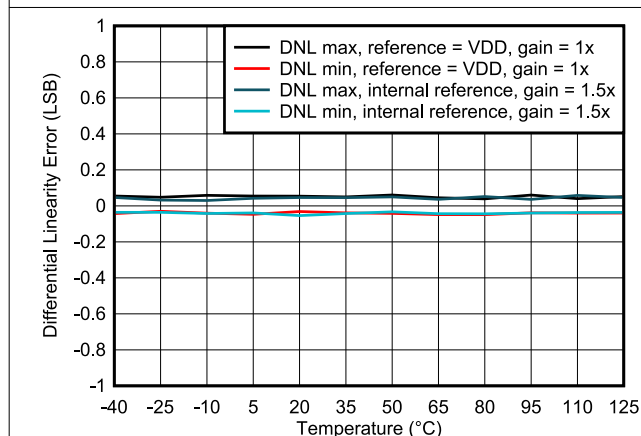
at $T_A = 25^\circ\text{C}$ and digipot outputs unloaded (unless otherwise noted)

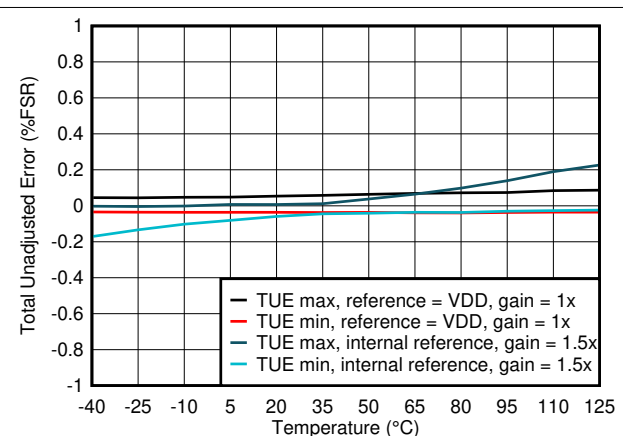
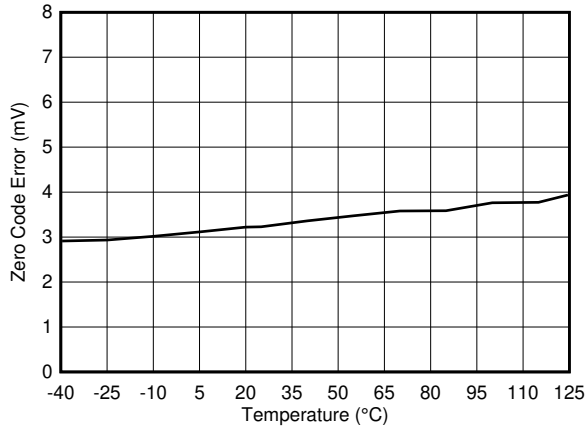

Reference = V_{DD}

图 6-7. Zero Code Error vs Temperature

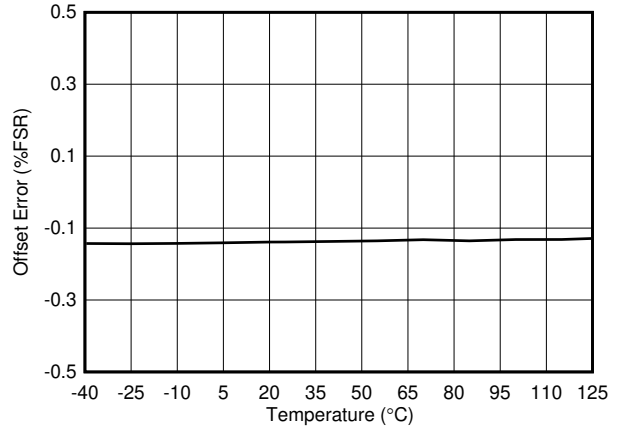

Reference = V_{DD}

图 6-8. Offset Error vs Temperature



图 6-9. Gain Error vs Temperature



图 6-10. Full-Scale Error vs Temperature

6.10 Typical Characteristics: $V_{DD} = 5.5\text{ V}$ (Reference = V_{DD}) or $V_{DD} = 5\text{ V}$ (Internal Reference)

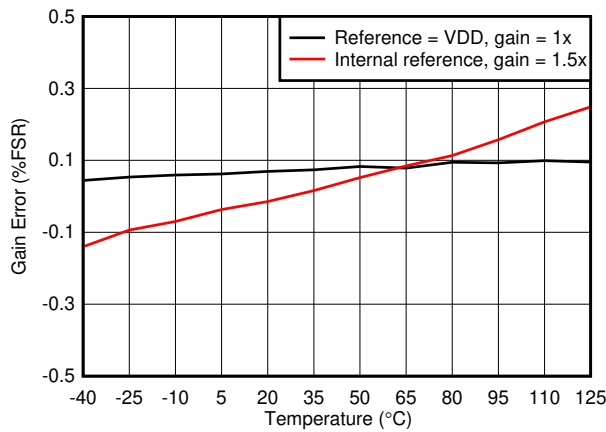
at $T_A = 25^\circ\text{C}$ and digipot outputs unloaded (unless otherwise noted)

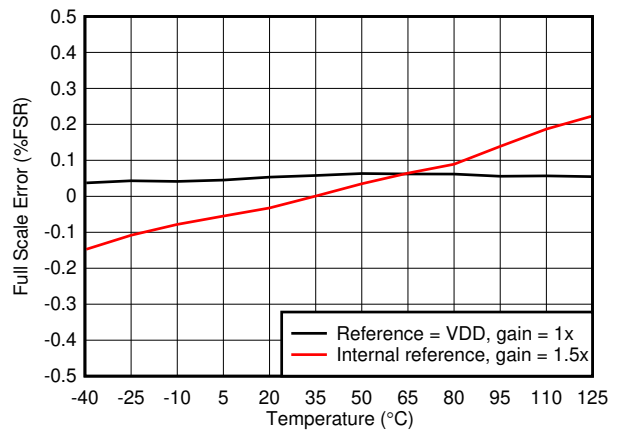

图 6-11. Integral Linearity Error vs Digital Input Code



图 6-12. Differential Linearity Error vs Digital Input Code

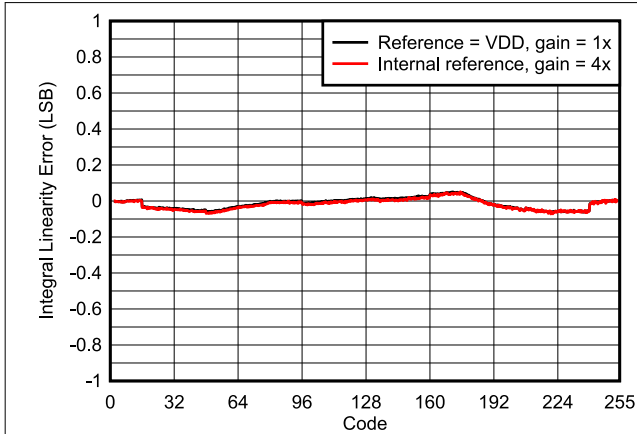

图 6-13. Total Unadjusted Error vs Digital Input Code

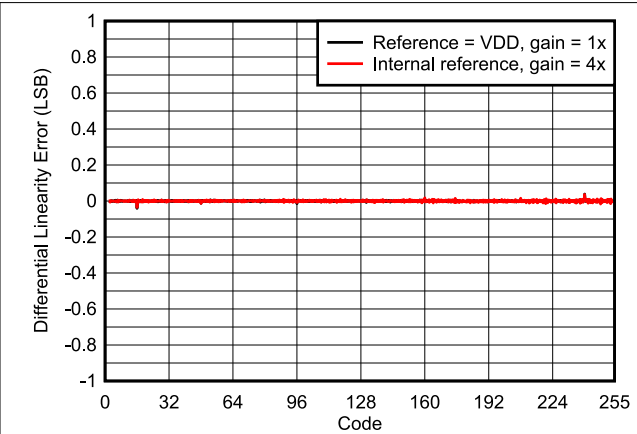

图 6-14. Integral Linearity Error vs Temperature

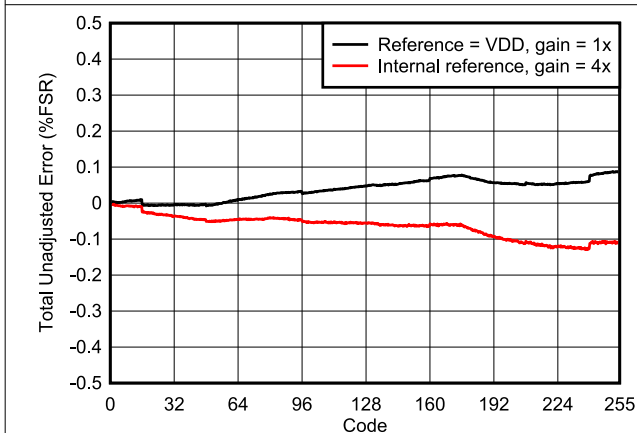

图 6-15. Differential Linearity Error vs Temperature

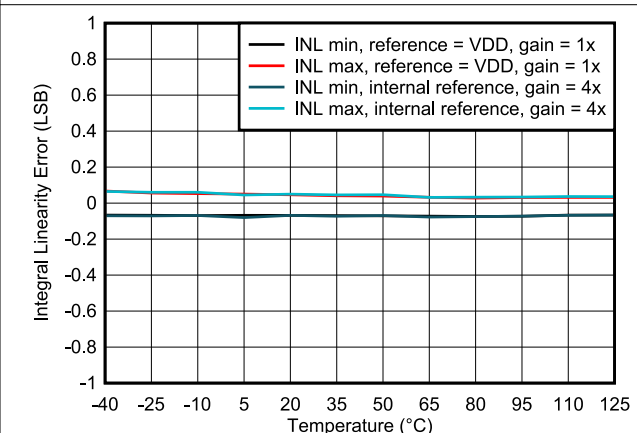

图 6-16. Total Unadjusted Error vs Temperature

6.10 Typical Characteristics: $V_{DD} = 5.5\text{ V}$ (Reference = V_{DD}) or $V_{DD} = 5\text{ V}$ (Internal Reference) (continued)

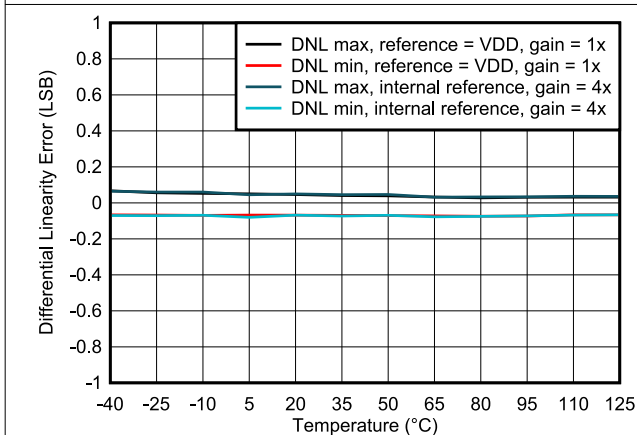
at $T_A = 25^\circ\text{C}$ and digipot outputs unloaded (unless otherwise noted)

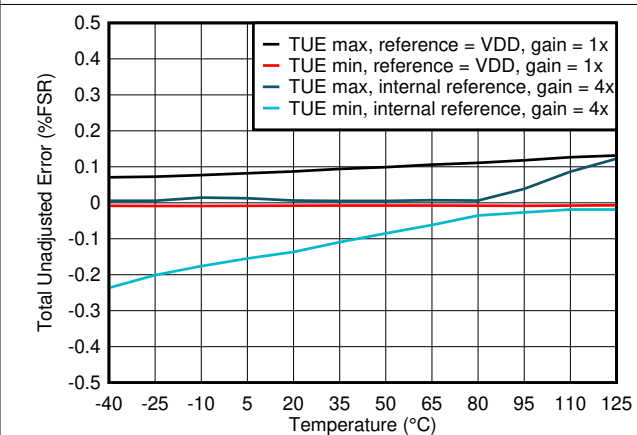

图 6-17. Zero Code Error vs Temperature



图 6-18. Offset Error vs Temperature

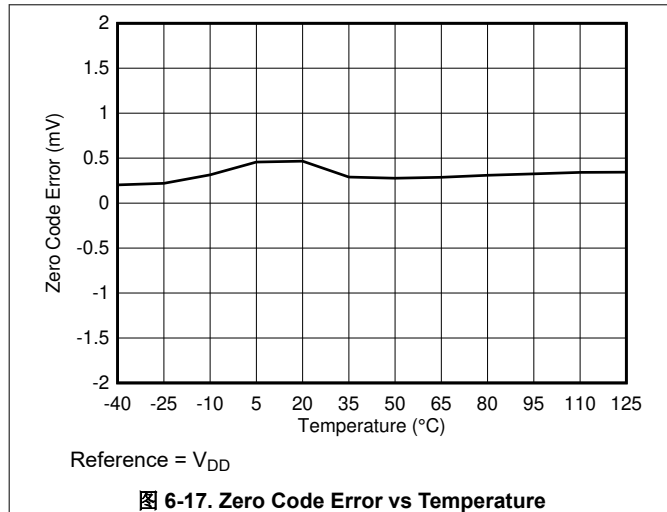

图 6-19. Gain Error vs Temperature

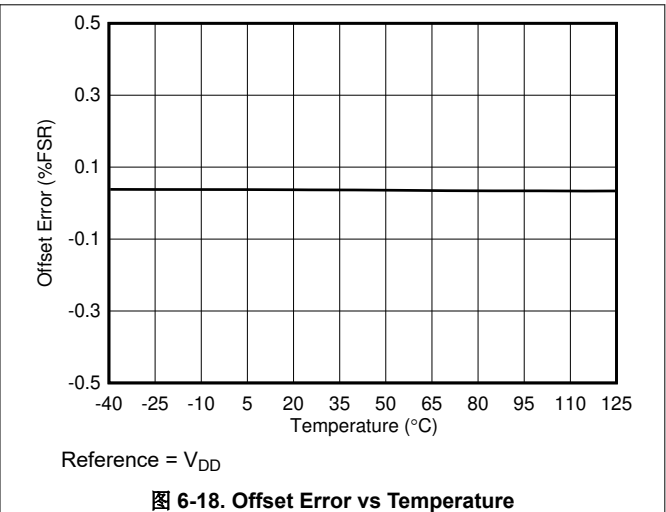

图 6-20. Full-Scale Error vs Temperature

6.11 Typical Characteristics

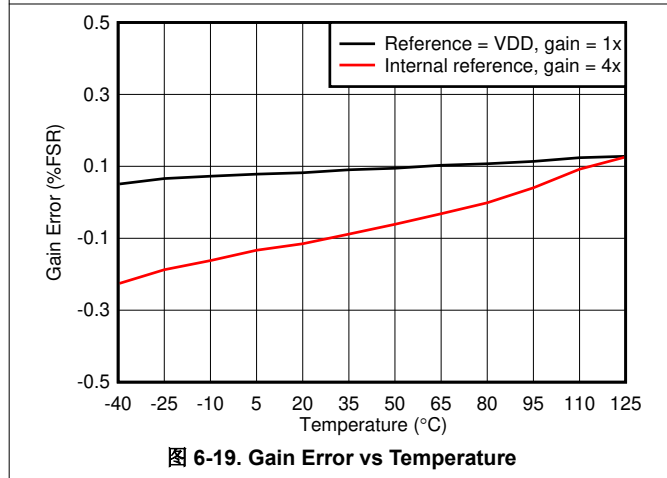
at $T_A = 25^\circ\text{C}$ and digipot outputs unloaded (unless otherwise noted)

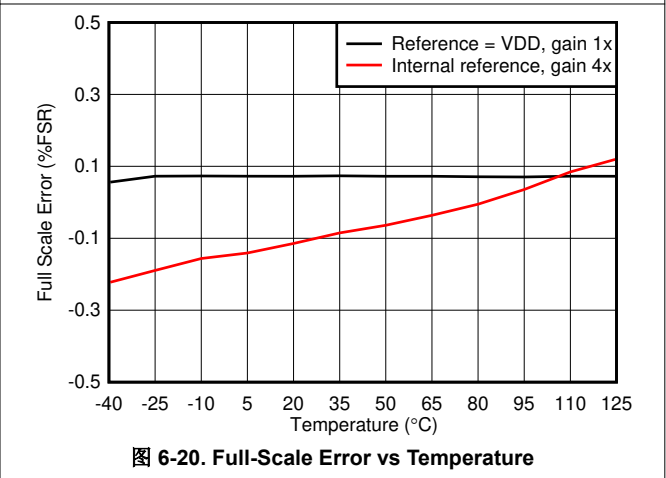
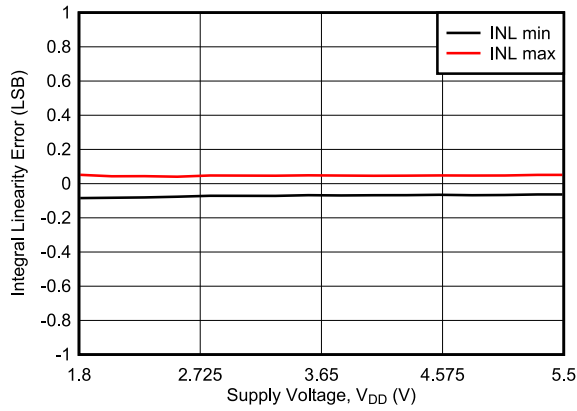

Reference = V_{DD}

图 6-21. Integral Linearity Error vs Supply Voltage

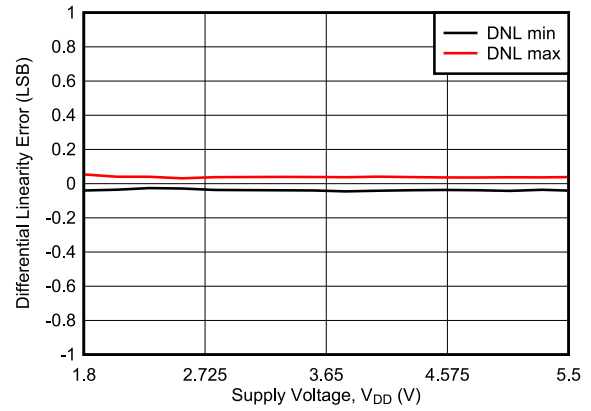

Reference = V_{DD}

图 6-22. Differential Linearity Error vs Supply Voltage

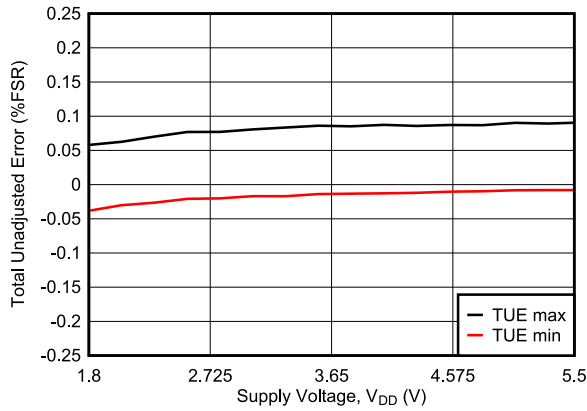

Reference = V_{DD}

图 6-23. Total Unadjusted Error vs Supply Voltage

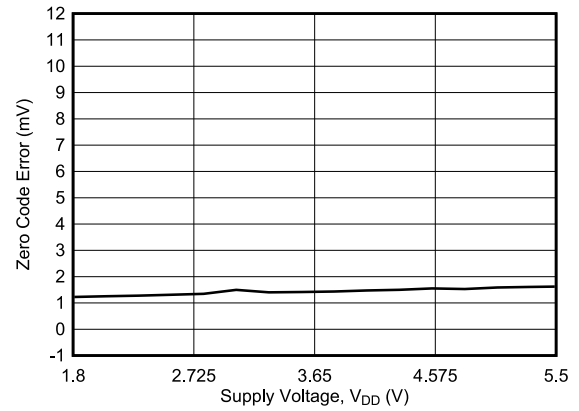

Reference = V_{DD}

图 6-24. Zero-Code Error vs Supply Voltage

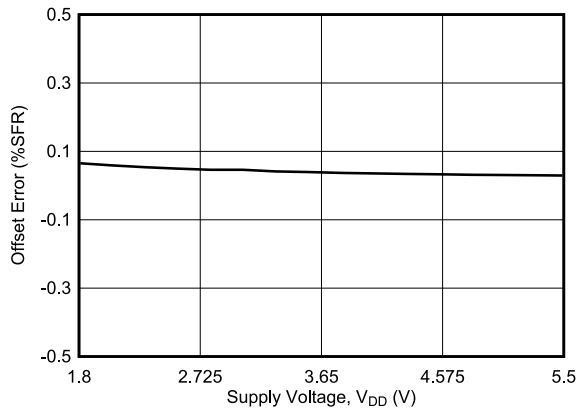

Reference = V_{DD}

图 6-25. Offset Error vs Supply Voltage

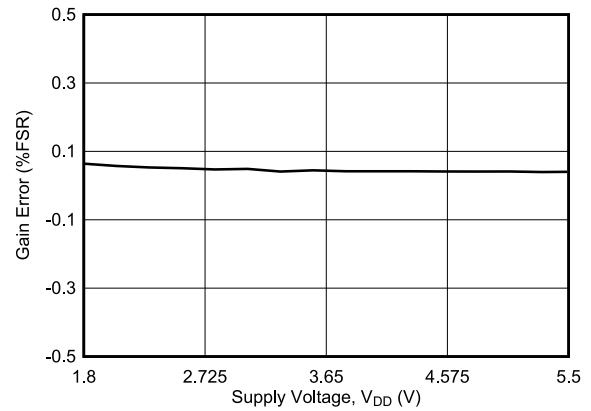

Reference = V_{DD}

图 6-26. Gain Error vs Supply Voltage

6.11 Typical Characteristics (continued)

at $T_A = 25^\circ\text{C}$ and digipot outputs unloaded (unless otherwise noted)

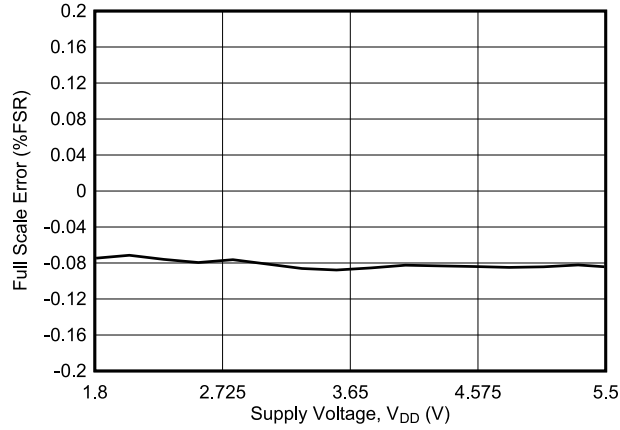

Reference = V_{DD}

图 6-27. Full-Scale Error vs Supply Voltage

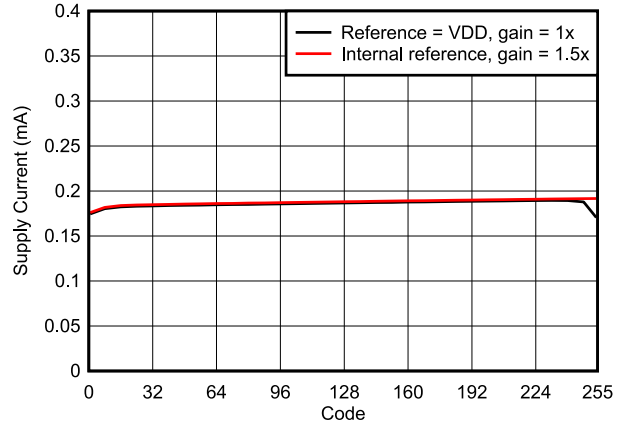

$V_{DD} = 1.8\text{ V}$

图 6-28. Supply Current vs Digital Input Code

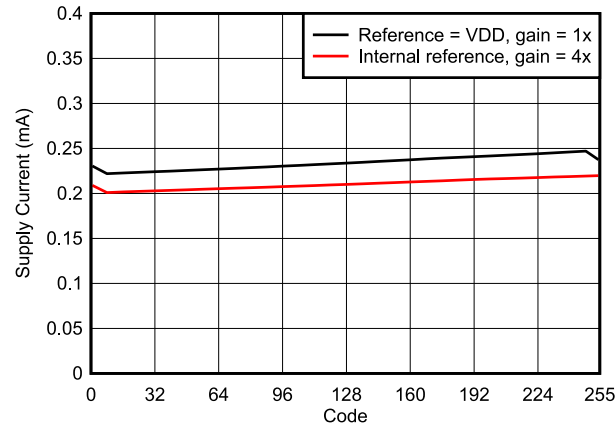

$V_{DD} = 5.5\text{ V}$

图 6-29. Supply Current vs Digital Input Code

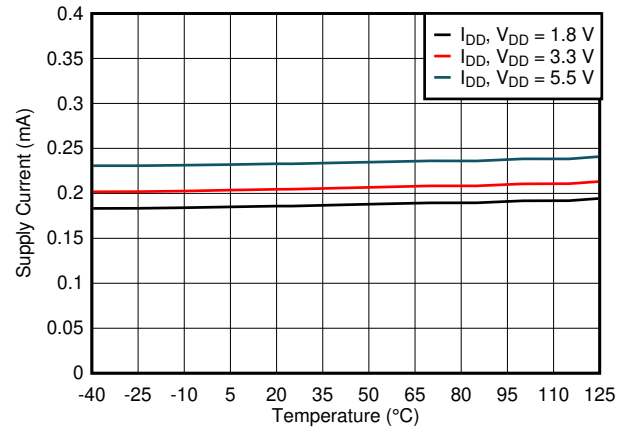

Reference = V_{DD} , digipot at midscale

图 6-30. Supply Current vs Temperature

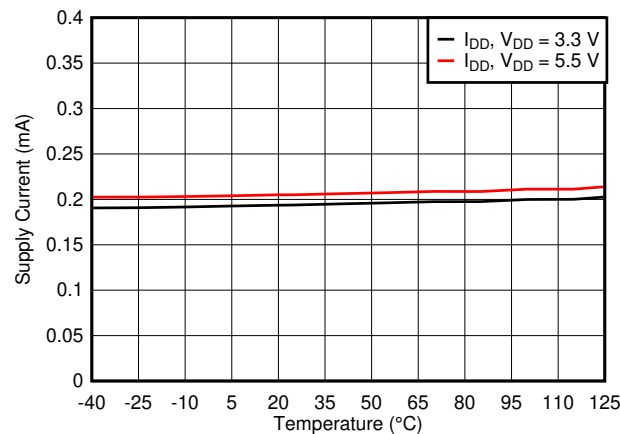

Internal reference (gain = 4x), digipot at midscale

图 6-31. Supply Current vs Temperature

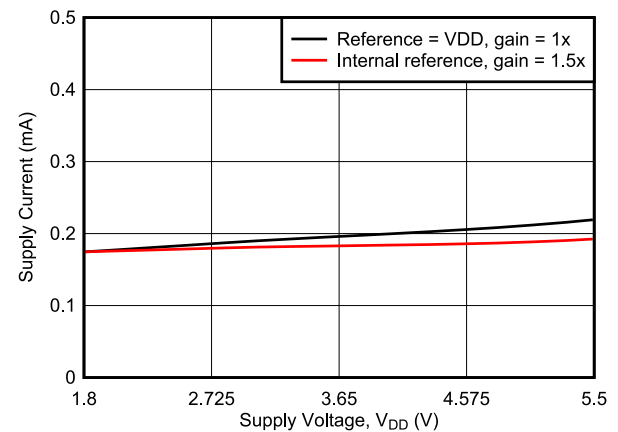

Digipot at midscale

图 6-32. Supply Current vs Supply Voltage

6.11 Typical Characteristics (continued)

at $T_A = 25^\circ\text{C}$ and digipot outputs unloaded (unless otherwise noted)

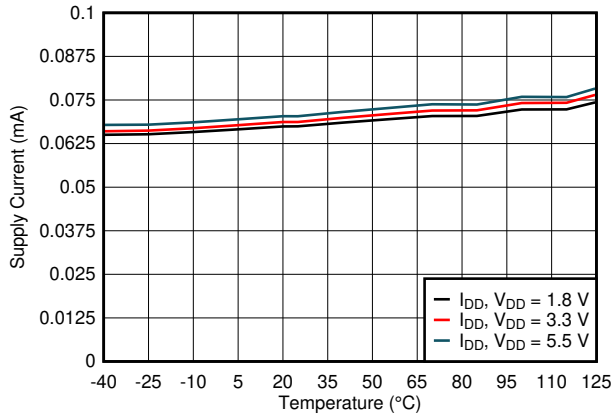

Reference = V_{DD} , digipot powered down

图 6-33. Power-Down Current vs Temperature



图 6-34. Source and Sink Capability



Reference = $V_{DD} = 5.5\text{ V}$, digipot code transition from midscale to midscale + 1 LSB, digipot load = $5\text{ k}\Omega \parallel 200\text{ pF}$

图 6-35. Glitch Impulse, Rising Edge, 1-LSB Step

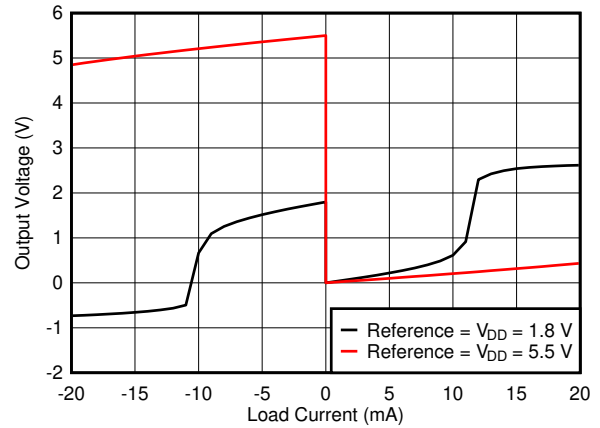
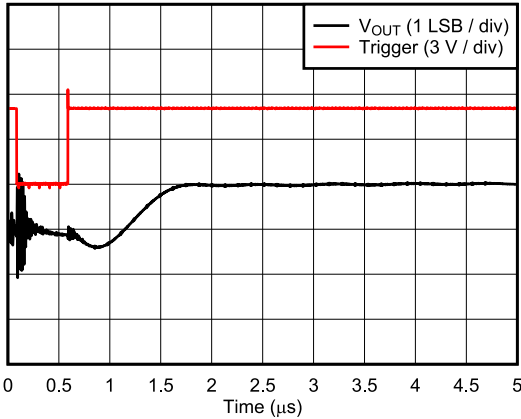
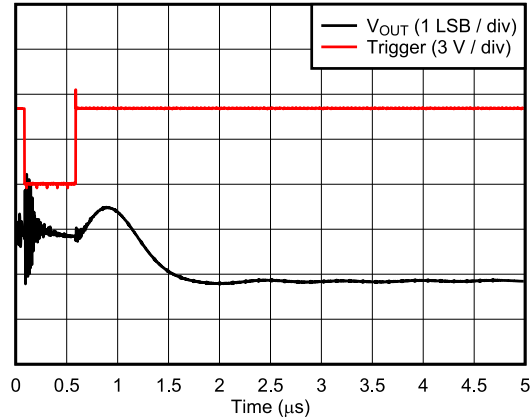

Reference = $V_{DD} = 5.5\text{ V}$, digipot code transition from midscale to midscale - 1 LSB, digipot load = $5\text{ k}\Omega \parallel 200\text{ pF}$

图 6-36. Glitch Impulse, Falling Edge, 1-LSB Step

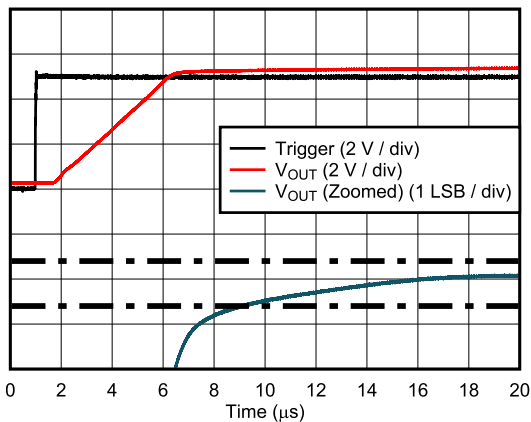

Reference = $V_{DD} = 5.5\text{ V}$, digipot load = $5\text{ k}\Omega \parallel 200\text{ pF}$

图 6-37. Full-Scale Settling Time, Rising Edge

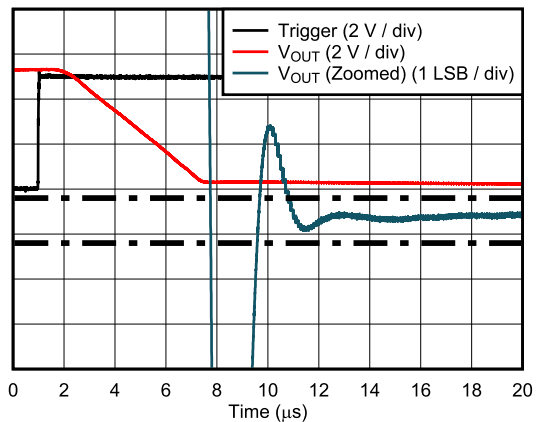

Reference = $V_{DD} = 5.5\text{ V}$, digipot load = $5\text{ k}\Omega \parallel 200\text{ pF}$

图 6-38. Full-Scale Settling Time, Falling Edge

6.11 Typical Characteristics (continued)

at $T_A = 25^\circ\text{C}$ and digipot outputs unloaded (unless otherwise noted)

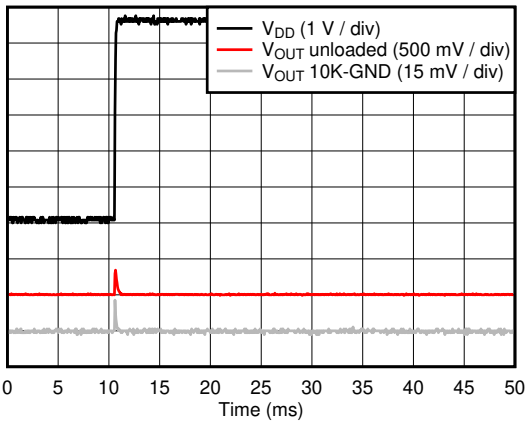

Reference = $V_{DD} = 5.5\text{ V}$

图 6-39. Power-on Glitch

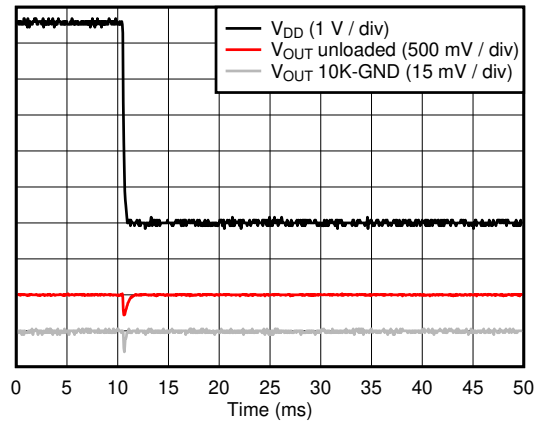

Reference = $V_{DD} = 5.5\text{ V}$

图 6-40. Power-off Glitch

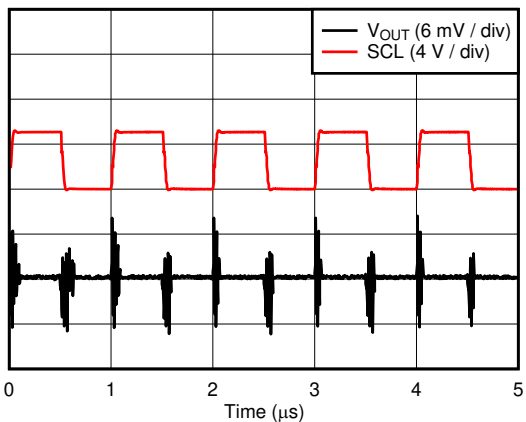

Reference = $V_{DD} = 5.5\text{ V}$, fast mode plus, digipot at midscale, digipot load = $5\text{ k}\Omega \parallel 200\text{ pF}$

图 6-41. Clock Feedthrough

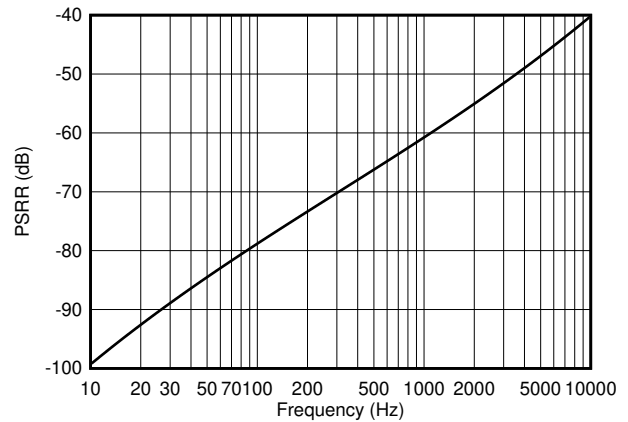

Internal reference (gain = 4x), $V_{DD} = 5.25\text{ V} + 0.25\text{ V}_{PP}$, digipot at midscale, digipot load = $5\text{ k}\Omega \parallel 200\text{ pF}$

图 6-42. Output AC PSRR vs Frequency

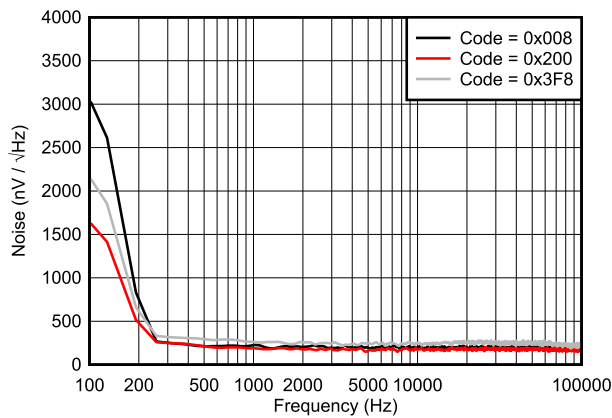

Reference = $V_{DD} = 5.5\text{ V}$

图 6-43. Output Noise Spectral Density

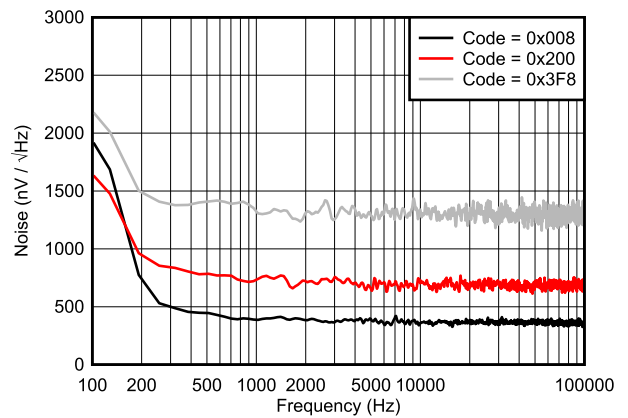

Internal reference (gain = 4x), $V_{DD} = 5.5\text{ V}$

图 6-44. Output Noise Spectral Density

6.11 Typical Characteristics (continued)

at $T_A = 25^\circ\text{C}$ and digipot outputs unloaded (unless otherwise noted)

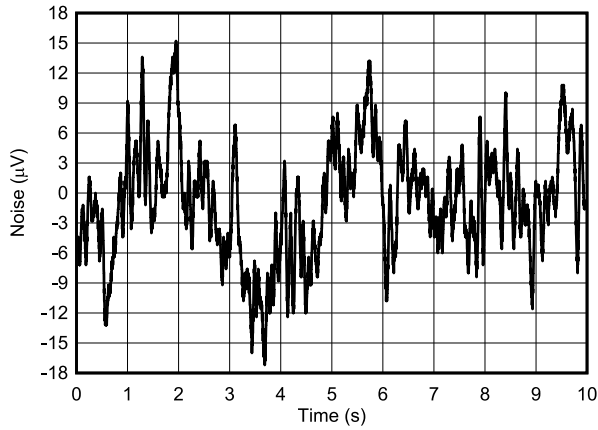

Reference = $V_{DD} = 5.5\text{ V}$, digipot at midscale

图 6-45. Digipot Output Noise: 0.1 Hz to 10 Hz

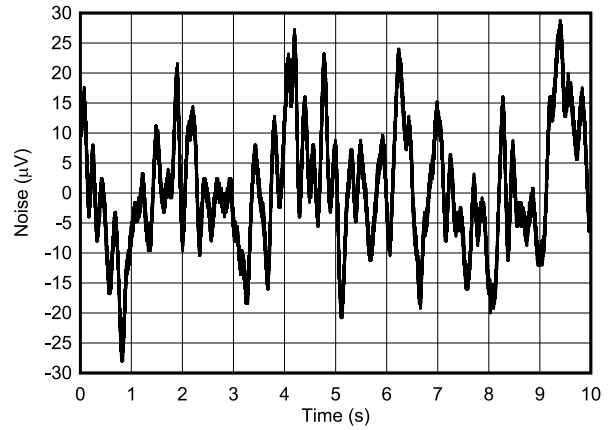

Internal reference (gain = 4x), $V_{DD} = 5.5\text{ V}$, digipot at midscale

图 6-46. Digipot Output Noise: 0.1 Hz to 10 Hz

7 Detailed Description

7.1 Overview

The TPL1401 is a digital potentiometer with buffered wiper. The buffered wiper helps achieve a higher load regulation as compared to standard digital potentiometers used in voltage-divider applications. This digipot contains nonvolatile memory (NVM) and an I²C interface. This makes the TPL1401 easy to use for factory trimming and calibration device in analog set-point applications. The TPL1401 operates with either the internal reference or the power supply as the reference, and provides a full-scale output of 1.8 V to 5.5 V.

The TPL1401 communicates through an I²C interface. This device supports I²C standard mode (100 kbps), fast mode (400 kbps), and fast mode plus (1 Mbps). This device also includes a wiper lock feature, an FB pin for current sink application, and 2 bytes of user-programmable NVM space.

The TPL1401 has a power-on-reset (POR) circuit that makes sure all the registers start with default or user-programmed settings using NVM. The digipot output powers on in high-impedance mode (default); this setting can be programmed to 10kΩ-GND using NVM.

7.2 Functional Block Diagram

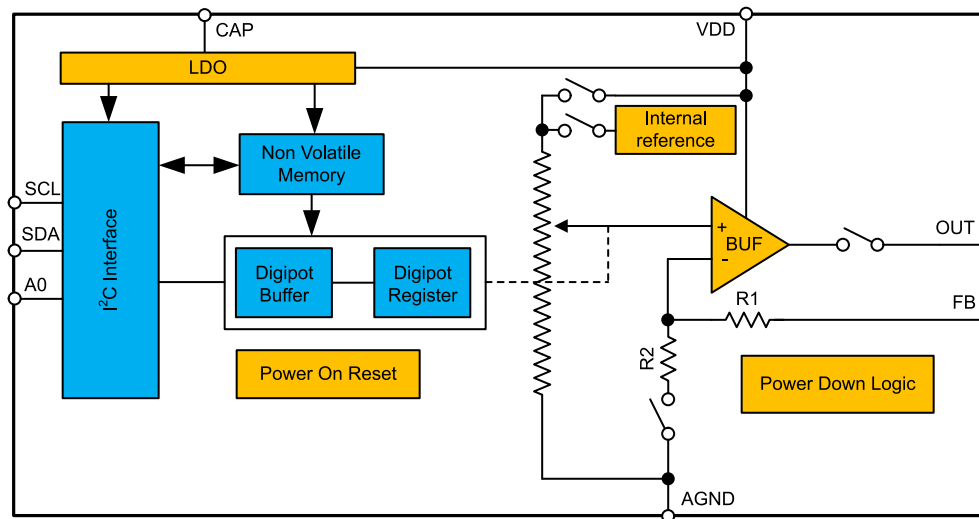

7.3 Feature Description

7.3.1 Digital Potentiometer (Digipot) Architecture

The TPL1401 consists of string architecture with an output buffer amplifier. [# 7.2](#) shows the digipot architecture within the block diagram. This digipot architecture operates from a 1.8-V to 5.5-V power supply. This device consume only 0.2 mA of current when using a 1.8-V power supply. The digipot output gets loaded from the NVM at power up. Write the required code so that the load circuit starts with a predictable operating point at power up.

7.3.1.1 Reference Selection and Digipot Transfer Function

The device writes the input data to the DPOT_POSITION register in straight-binary format. After a power-on or a reset event, the device sets all digipot registers to the values set in the NVM.

7.3.1.1.1 Power Supply as Reference

By default, the TPL1401 operates with the power-supply pin (VDD) as a reference. [方程式 1](#) shows the digipot transfer function when the power-supply pin is used as a reference.

$$V_{OUT} = \frac{DPOT_POS}{256} \times V_{DD} \quad (1)$$

where:

- DPOT_POS is the decimal equivalent of the binary code that is loaded to the digipot register.
- DPOT_POS ranges from 0 to 255.
- V_{DD} is used as the digipot reference voltage.

7.3.1.1.2 Internal Reference

The TPL1401 also contains an internal reference that is disabled by default. Enable the internal reference by writing 1 to REF_EN (address D1h). The internal reference generates a fixed 1.21-V voltage (typical). Using the OUT_SPAN (address D1h) bits, a gain of 1.5x, 2x, 3x, 4x can be achieved for the digipot output voltage (V_{OUT}) [方程式 2](#) shows digipot transfer function when the internal reference is used.

$$V_{OUT} = \frac{DPOT_POS}{256} \times V_{REF} \times GAIN \quad (2)$$

where:

- DPOT_POS is the decimal equivalent of the binary code that is loaded to the digipot register
- DPOT_POS ranges from 0 to 255.
- V_{REF} is the internal reference voltage = 1.21 V.
- GAIN = 1.5x, 2x, 3x, 4x based on OUT_SPAN (address D1h) bits.

7.3.2 Digipot Update

The digipot output pin (OUT) is updated at the end of I²C digipot write frame.

7.3.3 Nonvolatile Memory (EEPROM or NVM)

The TPL1401 contains nonvolatile memory (NVM) bits. These NVM bits are user programmable and erasable, and retain the set values in the absence of a power supply. All the register bits, as shown in 表 7-1, can be stored in the device NVM by setting NVM_PROG = 1 (address D3h). The NVM_BUSY bit (address D0h) is set to 1 by the device when an NVM write or reload operation is ongoing. During this time, the device blocks all write operations to the device. The NVM_BUSY bit is set to 0 after the write or reload operation is complete; at this point, all write operations to the device are allowed. The default value for all the registers in the TPL1401 is loaded from NVM as soon as a POR event is issued. Do not perform a read operation from the digipot register while NVM_BUSY = 1.

The TPL1401 also implements NVM_RELOAD bit (address D3h). Set this bit to 1 for the device to start an NVM reload operation. After the operation is complete, the device autoresets this bit to 0. During the NVM_RELOAD operation, the NVM_BUSY bit is set to 1.

表 7-1. NVM Programmable Registers

REGISTER ADDRESS	REGISTER NAME	BIT ADDRESS	BIT NAME
D1h	GENERAL_CONFIG	13	DEVICE_LOCK
		4:3	DPOT_PDN
		2	REF_EN
		1:0	OUT_SPAN
10h	DPOT_POSITION	11:2	DPOT_POS
25h	USER_BYTE1	11:4	USER_BYTE1 (8 most significant bits)
26h	USER_BYTE2	11:4	USER_BYTE2 (8 most significant bits)

7.3.3.1 NVM Cyclic Redundancy Check

The TPL1401 implements a cyclic redundancy check (CRC) feature to make sure that the data stored in the device NVM are uncorrupted. There are two types of CRC alarm bits implemented in TPL1401:

- NVM_CRC_ALARM_USER (address D0h) — This bit indicates the status of the user-programmable NVM bits.
- NVM_CRC_ALARM_INTERNAL (address D0h) — This bit indicates the status of the internal NVM bits.

The CRC feature is implemented by storing a 10-bit CRC (CRC-10-ATM) along with the NVM data each time NVM program operation (write or reload) is performed and during the device start up. The device reads the NVM data and validates the data with the stored CRC. The CRC alarm bits report any errors after the data are read from the device NVM.

7.3.3.1.1 NVM_CRC_ALARM_USER Bit

A logic 1 on NVM_CRC_ALARM_USER bit indicates that the user-programmable NVM data is corrupt. During this condition, all registers in the digipot are initialized with factory reset values, and any digipot registers can be written to or read from. To reset the alarm bits to 0, issue a [Software Reset](#) command, or cycle power to the digipot. A power cycle reloads the user-programmable NVM bits. After the reset, write the desired data to the registers and assert the NVM_PROG bit in the PROTECT register to program the NVM.

7.3.3.1.2 NVM_CRC_ALARM_INTERNAL Bit

A logic 1 on NVM_CRC_ALARM_INTERNAL bit indicates that the internal NVM data is corrupt. During this condition, all registers in the digipot are initialized with factory reset values, and any digipot registers can be written to or read from. To reset the alarm bits to 0, issue a [Software Reset](#) command, or cycle power to the digipot. The NVM_PROG bit in the PROTECT register (address D3h) is blocked when the NVM_CRC_ALARM_INTERNAL bit is set. The device reset or power cycle does not reset the CRC error if there is a permanent NVM failure.

7.3.4 Power-On Reset (POR)

The TPL1401 includes a power-on reset (POR) function that controls the output voltage at power up. After the V_{DD} supply has been established, a POR event is issued. The POR causes all registers to initialize to default values, and communication with the device is valid only after a 30-ms POR delay. The default value for all the registers in the TPL1401 is loaded from NVM as soon as the POR event is issued.

When the device powers up, a POR circuit sets the device to the default mode. The POR circuit requires specific V_{DD} levels, as indicated in [Figure 7-1](#), in order to make sure that the internal capacitors discharge and reset the device on power up. To make sure that a POR occurs, V_{DD} must be less than 0.7 V for at least 1 ms. When V_{DD} drops to less than 1.65 V, but remains greater than 0.7 V (shown as the undefined region), the device may or may not reset under all specified temperature and power-supply conditions. In this case, initiate a POR. When V_{DD} remains greater than 1.65 V, a POR does not occur.



图 7-1. Threshold Levels for V_{DD} POR Circuit

7.3.5 Software Reset

To initiate a device software reset event, write reserved code 1010 to the SW_RESET bits (address D3h). A software reset initiates a POR event.

7.3.6 Device Lock Feature

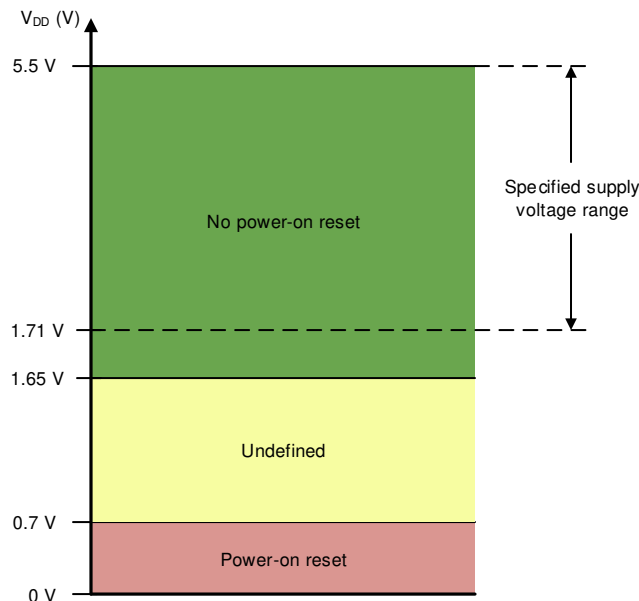
The TPL1401 implements a device lock feature that prevents an accidental or unintended write to the digipot registers. The device locks all the registers when the DEVICE_LOCK bit (address D1h) is set to 1. To bypass the DEVICE_LOCK setting, write 0101 to the DEVICE_UNLOCK_CODE bits (address D3h).

7.4 Device Functional Modes

7.4.1 Power Down Mode

The TPL1401 output amplifier and internal reference can be independently powered down through the DPOT_PDN bits (address D1h).

At power up, the digipot output and the internal reference are disabled by default.

In power-down mode, the digipot output (OUT pin) is in a high-impedance state.

To change this state to $10\text{k}\Omega\text{-A}_{\text{GND}}$ (at power up), use the DPOT_PDN bits (address D1h).

The digipot power-up state can be programmed to any state (power-down or normal mode) using the NVM. [表 7-2](#) shows the digipot power-down bits.

表 7-2. Digipot Power-Down Bits

REGISTER ADDRESS AND NAME	DPOT_PDN[1]	DPOT_PDN[0]	DESCRIPTION
D1h, GENERAL_CONFIG	0	0	Power up
	0	1	Power down to 10 k Ω
	1	0	Power down to high impedance (HiZ) (default)
	1	1	Power down to 10 k Ω

7.5 Programming

The TPL1401 devices have a 2-wire serial interface (SCL and SDA), and one address pin (A0), as shown in [Figure 5](#). The I²C bus consists of a data line (SDA) and a clock line (SCL) with pullup structures. When the bus is idle, both SDA and SCL lines are pulled high. All the I²C-compatible devices connect to the I²C bus through the open drain I/O pins, SDA and SCL.

The I²C specification states that the device that controls communication is called a *master*, and the devices that are controlled by the master are called *slaves*. The master device generates the SCL signal. The master device also generates special timing conditions (start condition, repeated start condition, and stop condition) on the bus to indicate the start or stop of a data transfer. Device addressing is completed by the master. The master device on an I²C bus is typically a microcontroller or digital signal processor (DSP). The TPL1401 operates as a slave device on the I²C bus. A slave device acknowledges master commands, and upon master control, receives or transmits data.

Typically, the TPL1401 operates as a slave receiver. A master device writes to the TPL1401, a slave receiver. However, if a master device requires the TPL1401 internal register data, the TPL1401 operates as a slave transmitter. In this case, the master device reads from the TPL1401. According to I²C terminology, read and write refer to the master device.

The TPL1401 is a slave and supports the following data transfer modes:

- Standard mode (100 kbps)
- Fast mode (400 kbps)
- Fast mode plus (1.0 Mbps)

The data transfer protocol for standard and fast modes is exactly the same; therefore, both modes are referred to as F/S-mode in this document. The fast mode plus protocol is supported in terms of data transfer speed, but not output current. The low-level output current would be 3 mA; similar to the case of standard and fast modes. The TPL1401 supports 7-bit addressing. The 10-bit addressing mode is not supported. The device supports the general call reset function. Sending the following sequence initiates a software reset within the device: start or repeated start, 0x00, 0x06, stop. The reset is asserted within the device on the rising edge of the ACK bit, following the second byte.

Other than specific timing signals, the I²C interface works with serial bytes. At the end of each byte, a ninth clock cycle generates and detects an acknowledge signal. Acknowledge is when the SDA line is pulled low during the high period of the ninth clock cycle. A not-acknowledge is when the SDA line is left high during the high period of the ninth clock cycle as shown in [Figure 7-2](#).



图 7-2. Acknowledge and Not Acknowledge on the I²C Bus

7.5.1 F/S Mode Protocol

The following steps explain a complete transaction in F/S mode.

1. The master initiates data transfer by generating a start condition. The start condition is when a high-to-low transition occurs on the SDA line while SCL is high, as shown in 图 7-3. All I²C-compatible devices recognize a start condition.
2. The master then generates the SCL pulses, and transmits the 7-bit address and the read/write direction bit (R/W) on the SDA line. During all transmissions, the master makes sure that data are valid. A valid data condition requires the SDA line to be stable during the entire high period of the clock pulse, as shown in 图 7-4. All devices recognize the address sent by the master and compare the address to the respective internal fixed address. Only the slave device with a matching address generates an acknowledge by pulling the SDA line low during the entire high period of the ninth SCL cycle, as shown in 图 7-2. When the master detects this acknowledge, the communication link with a slave has been established.
3. The master generates further SCL cycles to transmit (R/W bit 0) or receive (R/W bit 1) data to the slave. In either case, the receiver must acknowledge the data sent by the transmitter. The acknowledge signal can be generated by the master or by the slave, depending on which is the receiver. The 9-bit valid data sequences consists of 8-data bits and 1 acknowledge-bit, and can continue as long as necessary.
4. To signal the end of the data transfer, the master generates a stop condition by pulling the SDA line from low-to-high while the SCL line is high (see 图 7-4). This action releases the bus and stops the communication link with the addressed slave. All I²C-compatible devices recognize the stop condition. Upon receipt of a stop condition, the bus is released, and all slave devices then wait for a start condition followed by a matching address.

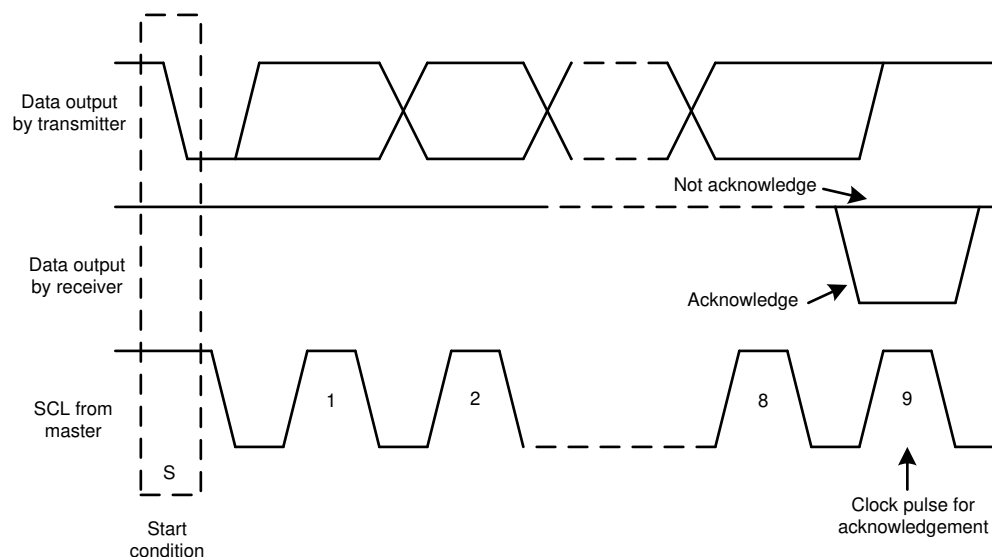

图 7-3. Start and Stop Conditions



图 7-4. Bit Transfer on the I²C Bus

7.5.2 I²C Update Sequence

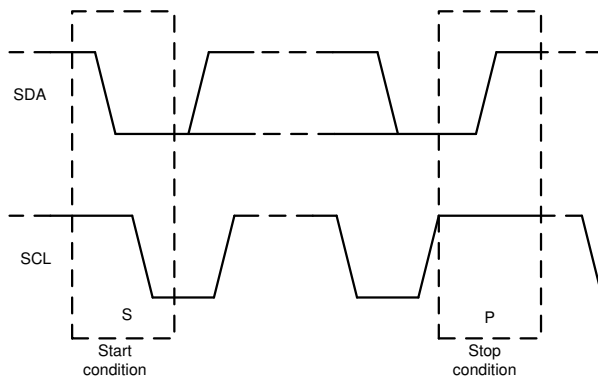
For a single update, the TPL1401 requires a start condition, a valid I²C address byte, a command byte, and two data bytes, as listed in 表 7-3.

表 7-3. Update Sequence

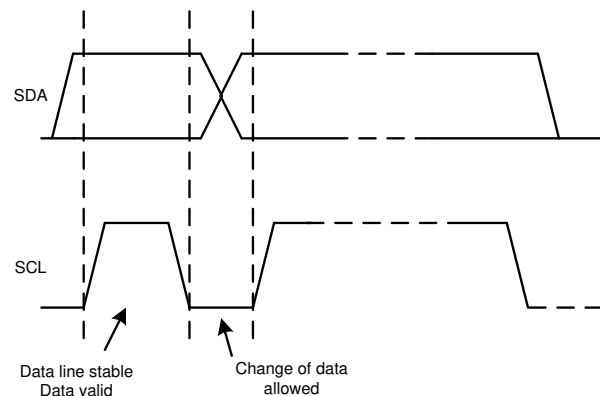
MSB	...	LSB	ACK	MSB	...	LSB	ACK	MSB	...	LSB	ACK	MSB	...	LSB	ACK
Address (A) byte 节 7.5.3				Command byte 节 7.5.4				Data byte - MSDB 节 8.2.3				Data byte - LSDB 节 8.2.3			
DB [31:24]				DB [23:16]				DB [15:8]				DB [7:0]			

After each byte is received, the TPL1401 acknowledges the byte by pulling the SDA line low during the high period of a single clock pulse, as shown in 图 7-5. These four bytes and acknowledge cycles make up the 36 clock cycles required for a single update to occur. A valid I²C address byte selects the TPL1401 device.



图 7-5. I²C Bus Protocol

The command byte sets the operating mode of the selected TPL1401. For a data update to occur when the operating mode is selected by this byte, the TPL1401 must receive two data bytes: the most significant data byte (MSDB) and least significant data byte (LSDB). The TPL1401 performs an update on the falling edge of the acknowledge signal that follows the LSDB.

When using fast mode (clock = 400 kHz), the maximum digipot update rate is limited to 10 kSPS. Using the fast mode plus (clock = 1 MHz), the maximum digipot update rate is limited to 25 kSPS. When a stop condition is received, the TPL1401 releases the I²C bus and awaits a new start condition.

7.5.3 Address Byte

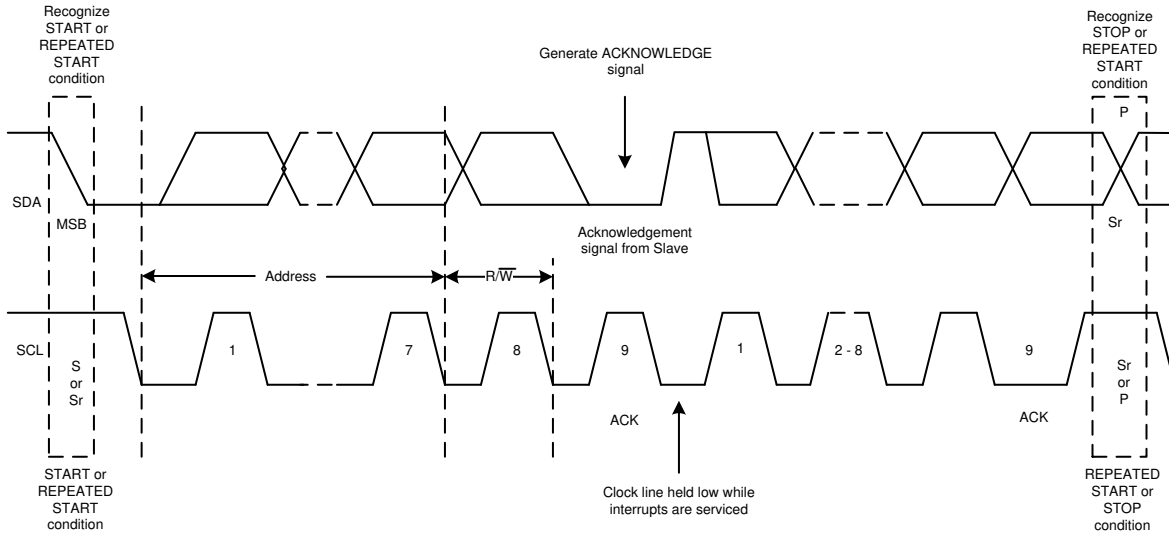
The address byte, as shown in 表 7-4, is the first byte received from the master device following the start condition. The first four bits (MSBs) of the address are factory preset to 1001. The next three bits of the address are controlled by the A0 pin. The A0 pin input can be connected to VDD, AGND, SCL, or SDA. The A0 pin is sampled during the first byte of each data frame to determine the address. The device latches the value of the address pin, and consequently responds to that particular address according to 表 7-5.

The TPL1401 supports broadcast addressing, which is used for synchronously updating or powering down multiple TPL1401 devices. When the broadcast address is used, the TPL1401 responds regardless of the address pin state. Broadcast is supported only in write mode.

表 7-4. Address Byte

COMMENT	MSB							LSB
	AD6	AD5	AD4	AD3	AD2	AD1	AD0	
—								R/ W
General address	1	0	0	1	See 表 7-5 (slave address column)			0 or 1
Broadcast address	1	0	0	0	1	1	1	0

表 7-5. Address Format

SLAVE ADDRESS	A0 PIN
000	AGND
001	VDD
010	SDA
011	SCL

7.5.4 Command Byte

表 7-6 lists the command byte.

表 7-6. Command Byte (Register Names)

ADDRESS	REGISTER NAME
D0h	STATUS
D1h	GENERAL_CONFIG
D3h	PROTECT
21h	DPOT_POSITION
25h	USER_BYTE1
26h	USER_BYTE2

7.5.5 I²C Read Sequence

To read any register, the following command sequence must be used, as shown in 表 7-7:

1. Send a start or repeated start command with a slave address and the R/ \bar{W} bit set to 0 for writing. The device acknowledges this event.
2. Send a command byte for the register to be read. The device acknowledges this event again.
3. Send a repeated start with the slave address and the R/ \bar{W} bit set to 1 for reading. The device acknowledges this event.
4. The device writes the MSDB byte of the addressed register. The master must acknowledge this byte.
5. Finally, the device writes out the LSDB of the register.

An alternative reading method allows for reading back the value of the last register written. The sequence is a start or repeated start with the slave address and the R/ \bar{W} bit set to 1, and the two bytes of the last register are read out.

The broadcast address cannot be used for reading.

表 7-7. Read Sequence

S	MSB	...	R/W (0)	ACK	MSB	...	LSB	ACK	Sr	MSB	...	R/W (1)	ACK	MSB	...	LSB	ACK	MSB	...	LSB	ACK	
	ADDRESS BYTE 节 7.5.3				COMMAND BYTE 节 7.5.4				Sr	ADDRESS BYTE 节 7.5.3				MSDB				LSDB				
From Master				Slave	From Master				Slave	From Master				Slave	From Slave			Master	From Slave			Master

7.6 Register Map

表 7-8. Register Map

ADDRESS	MOST SIGNIFICANT DATA BYTE (MSDB)								LEAST SIGNIFICANT DATA BYTE (LSDB)								
	BIT15	BIT14	BIT13	BIT12	BIT11	BIT10	BIT9	BIT8	BIT7	BIT6	BIT5	BIT4	BIT3	BIT2	BIT1	BIT0	
D0h	NVM_CRC_ALARM_USER	NVM_CRC_ALARM_INTERNAL	NVM_BUSY	X ⁽¹⁾	X				DEVICE_ID				VERSION_ID				
D1h	RESERVED		DEVICE_LOCK	RESERVED								DPOT_PDN		REF_EN	OUT_SPAN		
D3h	DEVICE_UNLOCK_CODE				X		DEVICE_CONFIG_RESET	RESERVED			NVM_RELOAD	NVM_PROG	SW_RESET				
21h	X				DPOT_POS[7:0]								X				
25h	X				USER_BYTE1[7:0]								X				
26h	X				USER_BYTE2[7:0]								X				

(1) X = Don't care.

表 7-9. Register Names

ADDRESS	REGISTER NAME	SECTION
D0h	STATUS	节 7.6.1
D1h	GENERAL_CONFIG	节 7.6.2
D3h	PROTECT	节 7.6.3
21h	DPOT_POSITION	节 7.6.4
25h	USER_BYTE1	节 7.6.5
26h	USER_BYTE2	节 7.6.6

表 7-10. Access Type Codes

Access Type	Code	Description
X	X	Don't care
Read Type		
R	R	Read
Write Type		
W	W	Write
Reset or Default Value		
-n		Value after reset or the default value

7.6.1 STATUS Register (address = D0h) (reset = 000Ch or 0014h)

表 7-11. STATUS Register

15	14	13	12	11	10	9	8	7	6	5	4	3	2	1	0
NVM_CRC_ALARM_USER	NVM_CRC_ALARM_INTERNAL	NVM_BUSY	X	X				DEVICE_ID				VERSION_ID			
R-0h	R-0h	R-0h	R-0h	X-00h				R-14h				R-0h			

表 7-12. STATUS Register Field Descriptions

Bit	Field	Type	Reset	Description
15	NVM_CRC_ALARM_USER	R	0	0 : No CRC error in user NVM bits 1: CRC error in user NVM bits
14	NVM_CRC_ALARM_INTERNAL	R	0	0 : No CRC error in internal NVM 1: CRC error in internal NVM bits
13	NVM_BUSY	R	0	0 : NVM write or load completed, Write to digipot registers allowed 1 : NVM write or load in progress, Write to digipot registers not allowed
12	X	R	0	Don't care
11 - 6	X	X	00h	Don't care
5 - 2	DEVICE_ID	R	14h	14h
1 - 0	VERSION_ID	R		Version ID as per the silicon version

7.6.2 GENERAL_CONFIG Register (address = D1h) (reset = 01F0h)

图 7-5. GENERAL_CONFIG Register

15	14	13	12	11	10	9	8	7	6	5	4	3	2	1	0
RESERVED		DEVICE_LOCK	RESERVED								DPOT_PDN	REF_EN	OUT_SPAN		
R-0h		W-0h	R-0Fh								R/ W-2h	R/ W-0h	R/ W-0h		

表 7-13. GENERAL_CONFIG Register Field Descriptions

Bit	Field	Type	Reset	Description
15 - 14	RESERVED	R	00	Always write 00b
13	DEVICE_LOCK	W	0	0 : Device not locked 1: Device locked, the device locks all the registers. This bit can be reset (unlock device) by writing 0101 to the DEVICE_UNLOCK_CODE bits (address D3h)
12 - 5	RESERVED	R	0Fh	Always write 0Fh
4 - 3	DPOT_PDN	R/ W	10	00: Power up 01: Power down to 10K 10: Power down to high impedance (default) 11: Power down to 10K
2	REF_EN	R/ W	0	0: Internal reference disabled, V _{DD} is digipot reference voltage, digipot output range from 0 V to V _{DD} . 1: Internal reference enabled, digipot reference = 1.21 V
1 - 0	OUT_SPAN	R/ W	00	Only applicable when internal reference is enabled. 00: Reference to V _{OUT} gain 1.5x 01: Reference to V _{OUT} gain 2x 10: Reference to V _{OUT} gain 3x 11: Reference to V _{OUT} gain 4x

7.6.3 PROTECT Register (address = D3h) (reset = 0008h)

图 7-6. PROTECT Register

15	14	13	12	11	10	9	8	7	6	5	4	3	2	1	0
DEVICE_UNLOCK_CODE				X	DEVICE_CONFIG_RESET		RESERVED			NVM_RELOAD	NVM_PROG	SW_RESET			
W-0h				X	W-0h		R-0h			W-0h	W-0h	W-8h			

表 7-14. PROTECT Register Field Descriptions

Bit	Field	Type	Reset	Description
15 - 12	DEVICE_UNLOCK_CODE	W	0000	Write 0101 to unlock the device to bypass DEVICE_LOCK bit.
11 - 10	X	X	0h	Don't care
9	DEVICE_CONFIG_RESET	W	0	0: Device configuration reset not initiated 1: Device configuration reset initiated. All registers loaded with factory reset values.
8 - 6	RESERVED	R	000	Always write 000b
5	NVM_RELOAD	W	0	0: NVM reload not initiated 1: NVM reload initiated, applicable digipot registers loaded with corresponding NVM. NVM_BUSY bit set to 1 while this operation is in progress. This bit is self-resetting.
4	NVM_PROG	W	0	0: NVM write not initiated 1: NVM write initiated, NVM corresponding to applicable digipot registers loaded with existing register settings. NVM_BUSY bit set to 1 while this operation is in progress. This bit is self-resetting.
3 - 0	SW_RESET	W	1000	1000: Software reset not initiated 1010: Software reset initiated, digipot registers loaded with corresponding NVMs, all other registers loaded with default settings.

7.6.4 DPOT_POSITION Register (address = 21h) (reset = 0000h)

表 7-15. DPOT_POSITION Register

15	14	13	12	11	10	9	8	7	6	5	4	3	2	1	0
X				DPOT_POS[7:0] - MSB Left aligned										X	
X-0h				R/W-000h										X-0h	

表 7-16. DPOT_DATA Register Field Descriptions

Bit	Field	Type	Reset	Description
15-12	X	X	0h	Don't care
11-2	DPOT_POS[7:0]	R/W	000h	Writing to the DPOT_POSITION register forces the digipot to update the active register data to the DPOT_POS. Data are in straight binary format and use the following format: { DPOT_POS[7:0], X, X } X = Don't care bits
1-0	X	X	0h	Don't care

7.6.5 USER_BYTE1 Register (address = 25h) (reset = 0000h)

表 7-17. USER_BYTE1 Register

15	14	13	12	11	10	9	8	7	6	5	4	3	2	1	0
X				USER_BYTE1[7:0] - MSB Left aligned											X
X-0h				R/W-000h											X-0h

表 7-18. USER_BYTE1 Register Field Descriptions

Bit	Field	Type	Reset	Description
15-12	X	X	0h	Don't care
11-2	USER_BYTE1[7:0] - MSB Left aligned	R/W	000h	8-bit user-programmable data. Data are in straight binary format and use the following format: { USER_BYTE1[7:0], X, X } X = Don't care bits
1-0	X	X	0h	Don't care

7.6.6 USER_BYTE2 Register (address = 26h) (reset = 0000h)

表 7-19. USER_BYTE2 Register

15	14	13	12	11	10	9	8	7	6	5	4	3	2	1	0
X				USER_BYTE2[7:0] - MSB Left aligned											X
X-0h				R/W-000h											X-0h

表 7-20. USER_BYTE2 Register Field Descriptions

Bit	Field	Type	Reset	Description
15-12	X	X	0h	Don't care
11-2	USER_BYTE2[7:0] - MSB Left aligned	R/W	000h	8-bit user-programmable data. Data are in straight binary format and follows the format below: { USER_BYTE2[7:0], X, X } X = Don't care bits
1-0	X	X	0h	Don't care

8 Application and Implementation

备注

以下应用部分的信息不属于 TI 组件规范，TI 不担保其准确性和完整性。客户应负责确定 TI 组件是否适用于其应用。客户应验证并测试其设计，以确保系统功能。

8.1 Application Information

The TPL1401 is a buffered, force-sense-output, single-channel, digipot that includes an internal reference and NVM, and is available in a tiny 2 mm × 2 mm package. This device interfaces to a processor using I²C. There are 4 I²C addresses possible by configuring the A0 pin as shown in 表 7-5. The NVM allows processor-less operation of this device after programming at factory. The force-sense output can work with a transistor to create a programmable current sink that can bias LEDs. These digipots are designed for general-purpose applications in a wide range of end equipment. Some of the most common applications for these devices are programmable current limits, adjustable power supplies, and offset and gain trimming in precision circuits.

8.2 Typical Application

Many analog and power devices, such as LED drivers, power amplifiers, high-side switches, e-fuses, and DC-DC converters, provide an analog input for an adjustable output current limit. Some of these devices recommend a resistor from this pin to ground for static settings. The TPL1401 is a very compact way to address the adjustable current limit requirements of such devices enabling scalability and configurability of these power devices. The integrated EEPROM makes sure the setting is retained even after power cycling, allowing the current limit to work without a processor. This section explains the design details of a programmable current limit application with an example LED driver, the TPS92692. 图 8-1 shows the simplified circuit diagram of this application.



图 8-1. Programmable Current Limit

8.2.1 Design Requirements

- LED driver: TPS92692
- LED driver current limit: 100 mA

8.2.2 Detailed Design Procedure

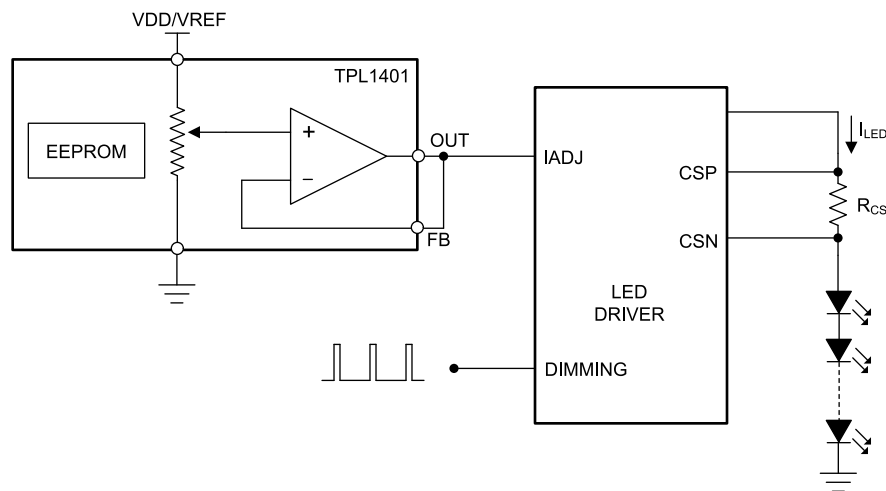
The TPS92692 data sheet provides the equation for the voltage required to set a given LED current limit. Use a sense resistor of 1-Ω for the TPS92692. The voltage at the IADJ pin, V_{IADJ} , must be 1.4 V for an LED current of 100 mA. The range for V_{IADJ} is 2.5 V. Enable the internal reference with 2x gain to set the digipot output range to 2.42 V that will fairly be in the range of current adjustment for the LED driver. Calculate the code needed to set the digipot output to 1.4 V using the following equation:

$$DPOT_POS = \frac{V_{IADJ}}{V_{REF} \times GAIN} \times 256 \quad (3)$$

The hex value for 148 is 0x94. Shift this value by 4 bits before writing to the DPOT_POSITION register, resulting in 0x940.

The pseudocode for the programmable current limit application is as follows:

```

//SYNTAX: WRITE <REGISTER NAME (Hex code)>, <MSB DATA>, <LSB DATA>
//Power-up the device, enable internal reference with 2x output span
WRITE GENERAL_CONFIG(0xD1), 0x11, 0xE5
//Write digipot code (12-bit aligned)
WRITE DPOT_POSITION(0x21), 0x09, 0x40
//Write settings to the NVM
WRITE PROTECT(0xD3), 0x00, 0x10
  
```

8.2.3 Application Curves



图 8-2. Digipot Code vs LED Current

9 Power Supply Recommendations

The TPL1401 does not require specific supply sequencing. The device requires a single power supply, V_{DD} . Use a 0.1- μF decoupling capacitor for the V_{DD} pin. Use a bypass capacitor with a value greater than 1.5- μF for the CAP pin.

10 Layout

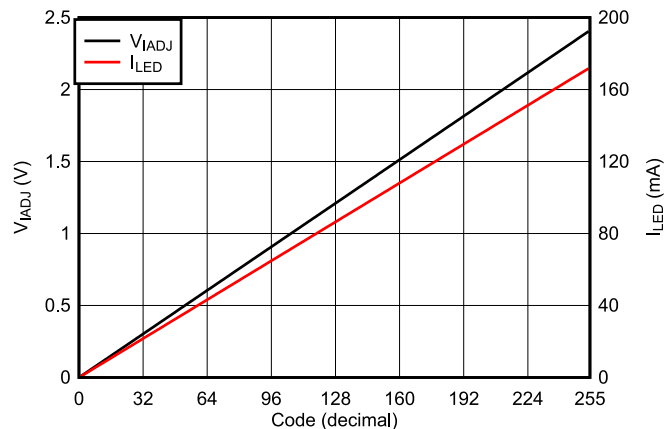
10.1 Layout Guidelines

The TPL1401 pin configuration separates the analog, digital, and power pins for an optimized layout. For signal integrity, separate the digital and analog traces, and place decoupling capacitors close to the device pins.

10.2 Layout Example

Figure 10-1 shows an example layout drawing with decoupling capacitors and pullup resistors.

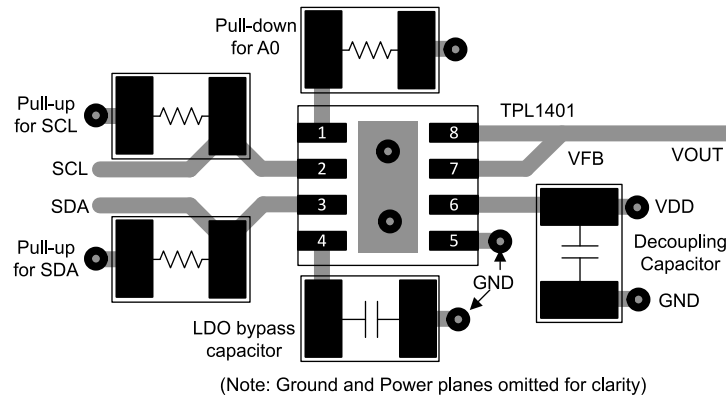

Figure 10-1. Layout Example

11 Device and Documentation Support

11.1 Documentation Support

11.1.1 Related Documentation

For related documentation see the following:

Texas, Instruments [TPL1401EVM user's guide](#)

11.2 接收文档更新通知

要接收文档更新通知，请导航至 [ti.com](#) 上的器件产品文件夹。点击 [订阅更新](#) 进行注册，即可每周接收产品信息更改摘要。有关更改的详细信息，请查看任何已修订文档中包含的修订历史记录。

11.3 支持资源

[TI E2E™ 支持论坛](#) 是工程师的重要参考资料，可直接从专家获得快速、经过验证的解答和设计帮助。搜索现有解答或提出自己的问题可获得所需的快速设计帮助。

链接的内容由各个贡献者“按原样”提供。这些内容并不构成 TI 技术规范，并且不一定反映 TI 的观点；请参阅 TI 的 [《使用条款》](#)。

11.4 Trademarks

TI E2E™ is a trademark of Texas Instruments.

所有商标均为其各自所有者的财产。

11.5 静电放电警告



静电放电 (ESD) 会损坏这个集成电路。德州仪器 (TI) 建议通过适当的预防措施处理所有集成电路。如果不遵守正确的处理和安装程序，可能会损坏集成电路。

ESD 的损坏小至导致微小的性能降级，大至整个器件故障。精密的集成电路可能更容易受到损坏，这是因为非常细微的参数更改都可能会导致器件与其发布的规格不相符。

11.6 术语表

[TI 术语表](#) 本术语表列出并解释了术语、首字母缩略词和定义。

12 Mechanical, Packaging, and Orderable Information

The following pages include mechanical, packaging, and orderable information. This information is the most current data available for the designated devices. This data is subject to change without notice and revision of this document. For browser-based versions of this data sheet, refer to the left-hand navigation.

PACKAGING INFORMATION

Orderable Device	Status (1)	Package Type	Package Drawing	Pins	Package Qty	Eco Plan (2)	Lead finish/ Ball material (6)	MSL Peak Temp (3)	Op Temp (°C)	Device Marking (4/5)	Samples
TPL1401DSGR	ACTIVE	WSON	DSG	8	3000	RoHS & Green	NIPDAU	Level-1-260C-UNLIM	-40 to 125	14_1	Samples
TPL1401DSGT	ACTIVE	WSON	DSG	8	250	RoHS & Green	NIPDAU	Level-1-260C-UNLIM	-40 to 125	14_1	Samples

(1) The marketing status values are defined as follows:

ACTIVE: Product device recommended for new designs.

LIFEBUY: TI has announced that the device will be discontinued, and a lifetime-buy period is in effect.

NRND: Not recommended for new designs. Device is in production to support existing customers, but TI does not recommend using this part in a new design.

PREVIEW: Device has been announced but is not in production. Samples may or may not be available.

OBSELETE: TI has discontinued the production of the device.

(2) **RoHS:** TI defines "RoHS" to mean semiconductor products that are compliant with the current EU RoHS requirements for all 10 RoHS substances, including the requirement that RoHS substance do not exceed 0.1% by weight in homogeneous materials. Where designed to be soldered at high temperatures, "RoHS" products are suitable for use in specified lead-free processes. TI may reference these types of products as "Pb-Free".

RoHS Exempt: TI defines "RoHS Exempt" to mean products that contain lead but are compliant with EU RoHS pursuant to a specific EU RoHS exemption.

Green: TI defines "Green" to mean the content of Chlorine (Cl) and Bromine (Br) based flame retardants meet JS709B low halogen requirements of <=1000ppm threshold. Antimony trioxide based flame retardants must also meet the <=1000ppm threshold requirement.

(3) MSL, Peak Temp. - The Moisture Sensitivity Level rating according to the JEDEC industry standard classifications, and peak solder temperature.

(4) There may be additional marking, which relates to the logo, the lot trace code information, or the environmental category on the device.

(5) Multiple Device Markings will be inside parentheses. Only one Device Marking contained in parentheses and separated by a "~" will appear on a device. If a line is indented then it is a continuation of the previous line and the two combined represent the entire Device Marking for that device.

(6) Lead finish/Ball material - Orderable Devices may have multiple material finish options. Finish options are separated by a vertical ruled line. Lead finish/Ball material values may wrap to two lines if the finish value exceeds the maximum column width.

Important Information and Disclaimer:The information provided on this page represents TI's knowledge and belief as of the date that it is provided. TI bases its knowledge and belief on information provided by third parties, and makes no representation or warranty as to the accuracy of such information. Efforts are underway to better integrate information from third parties. TI has taken and continues to take reasonable steps to provide representative and accurate information but may not have conducted destructive testing or chemical analysis on incoming materials and chemicals. TI and TI suppliers consider certain information to be proprietary, and thus CAS numbers and other limited information may not be available for release.

In no event shall TI's liability arising out of such information exceed the total purchase price of the TI part(s) at issue in this document sold by TI to Customer on an annual basis.

TAPE AND REEL INFORMATION

QUADRANT ASSIGNMENTS FOR PIN 1 ORIENTATION IN TAPE

*All dimensions are nominal

Device	Package Type	Package Drawing	Pins	SPQ	Reel Diameter (mm)	Reel Width W1 (mm)	A0 (mm)	B0 (mm)	K0 (mm)	P1 (mm)	W (mm)	Pin1 Quadrant
TPL1401DSGR	WSON	DSG	8	3000	180.0	8.4	2.3	2.3	1.15	4.0	8.0	Q2
TPL1401DSGT	WSON	DSG	8	250	180.0	8.4	2.3	2.3	1.15	4.0	8.0	Q2

TAPE AND REEL BOX DIMENSIONS

*All dimensions are nominal

Device	Package Type	Package Drawing	Pins	SPQ	Length (mm)	Width (mm)	Height (mm)
TPL1401DSGR	WSON	DSG	8	3000	210.0	185.0	35.0
TPL1401DSGT	WSON	DSG	8	250	210.0	185.0	35.0

GENERIC PACKAGE VIEW

DSG 8

WSON - 0.8 mm max height

2 x 2, 0.5 mm pitch

PLASTIC SMALL OUTLINE - NO LEAD

This image is a representation of the package family, actual package may vary.
Refer to the product data sheet for package details.

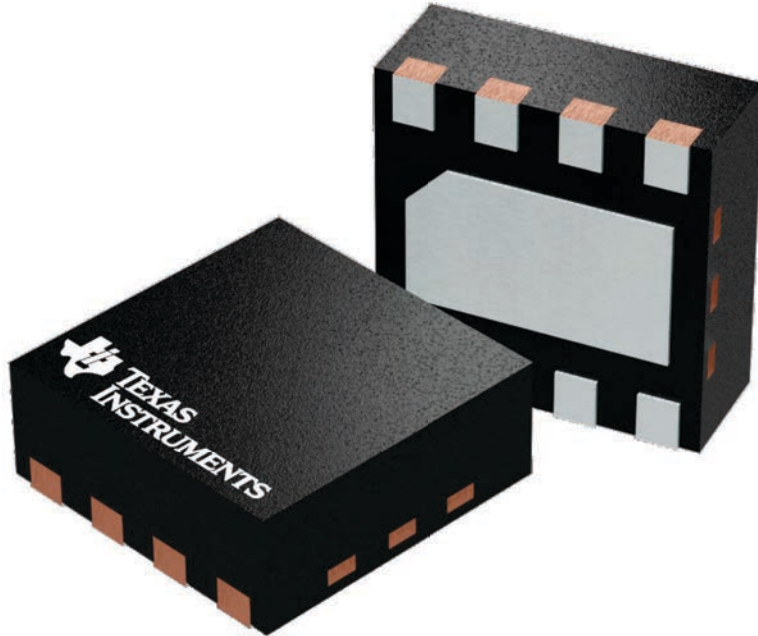

4224783/A

DSG0008A



PACKAGE OUTLINE

WSON - 0.8 mm max height

PLASTIC SMALL OUTLINE - NO LEAD



ALTERNATIVE TERMINAL SHAPE TYPICAL



SIDE WALL METAL THICKNESS DIM A	
OPTION 1	OPTION 2
0.1	0.2



4218900/E 08/2022

NOTES:

1. All linear dimensions are in millimeters. Any dimensions in parenthesis are for reference only. Dimensioning and tolerancing per ASME Y14.5M.
2. This drawing is subject to change without notice.
3. The package thermal pad must be soldered to the printed circuit board for thermal and mechanical performance.

重要声明和免责声明

TI“按原样”提供技术和可靠性数据（包括数据表）、设计资源（包括参考设计）、应用或其他设计建议、网络工具、安全信息和其他资源，不保证没有瑕疵且不做任何明示或暗示的担保，包括但不限于对适销性、某特定用途方面的适用性或不侵犯任何第三方知识产权的暗示担保。

这些资源可供使用 TI 产品进行设计的熟练开发人员使用。您将自行承担以下全部责任：(1) 针对您的应用选择合适的 TI 产品，(2) 设计、验证并测试您的应用，(3) 确保您的应用满足相应标准以及任何其他功能安全、信息安全、监管或其他要求。

这些资源如有变更，恕不另行通知。TI 授权您仅可将这些资源用于研发本资源所述的 TI 产品的应用。严禁对这些资源进行其他复制或展示。您无权使用任何其他 TI 知识产权或任何第三方知识产权。您应全额赔偿因在这些资源的使用中对 TI 及其代表造成的任何索赔、损害、成本、损失和债务，TI 对此概不负责。

TI 提供的产品受 [TI 的销售条款](#) 或 [ti.com](#) 上其他适用条款/TI 产品随附的其他适用条款的约束。TI 提供这些资源并不会扩展或以其他方式更改 TI 针对 TI 产品发布的适用的担保或担保免责声明。

TI 反对并拒绝您可能提出的任何其他或不同的条款。

邮寄地址：Texas Instruments, Post Office Box 655303, Dallas, Texas 75265

Copyright © 2022，德州仪器 (TI) 公司