

TPS548B27 具有遥感功能、3V 内部 LDO 和断续电流限制功能的 2.7V 至 16V 输入、20A 同步降压转换器

1 特性

- 输入范围为 4V 至 16V，电流高达 20A，无外部偏置
- 输入范围为 2.7V 至 16V 时，电流高达 20A，外部偏置范围为 3.13V 至 3.6V
- 输出电压范围：0.6V 至 5.5V
- 集成 7.7m Ω 和 2.4m Ω MOSFET，支持 20A 持续输出电流
- 在 D-CAP3™ 控制模式下可提供超快负载阶跃响应
- 支持所有陶瓷输出电容器
- 在 -40°C 至 +125°C 结温下实现差分遥感，V_{REF} 为 0.6V \pm 1%
- 自动跳跃 Eco-mode 可实现高轻负载效率
- 通过 R_{TRIP} 实现可编程电流限制
- 引脚可选开关频率：600kHz、800kHz、1MHz
- 可实现高输出精度的差分遥感功能
- 可编程软启动时间
- 外部基准输入，用于跟踪
- 预偏置启动功能
- 开漏电源正常状态输出
- 在发生 OC、UV 和 OV 故障时进入断续模式
- 4mm \times 3mm 19 引脚 VQFN-FCRLF 封装
- 完全符合 RoHS 标准，无需豁免

2 应用

- 机架式服务器和刀片式服务器
- 硬件加速卡和插件卡
- 数据中心交换机
- 工业 PC

3 说明

TPS548B27 器件是一款具有自适应导通时间 D-CAP3 控制模式的高效率、小尺寸同步降压转换器。该器件不需要外部补偿，因此易于使用并且仅需要很少的外部元件。该器件非常适合空间受限的数据中心应用。

TPS548B27 器件具有差分遥感功能和高性能集成 MOSFET，在整个工作结温范围具有高精度 (\pm 1%) 0.6V 电压基准。该器件具有快速负载瞬态响应、精确负载调节和线路调节、跳跃模式或 FCCM 运行以及可编程软启动功能。

TPS548B27 是一款无铅器件，完全符合 RoHS 标准，无需豁免。

器件信息

器件型号	封装 ⁽¹⁾	封装尺寸 (标称值)
TPS548B27	VQFN-FCRLF (19)	4.00mm \times 3.00mm

(1) 如需了解所有可用封装，请参阅数据表末尾的可订购产品附录。

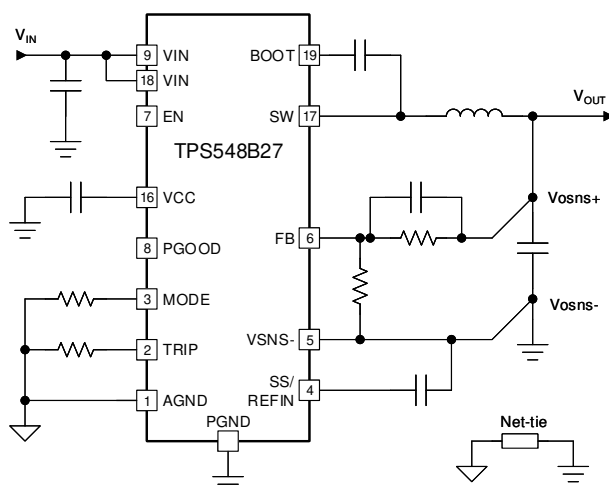

简化版应用

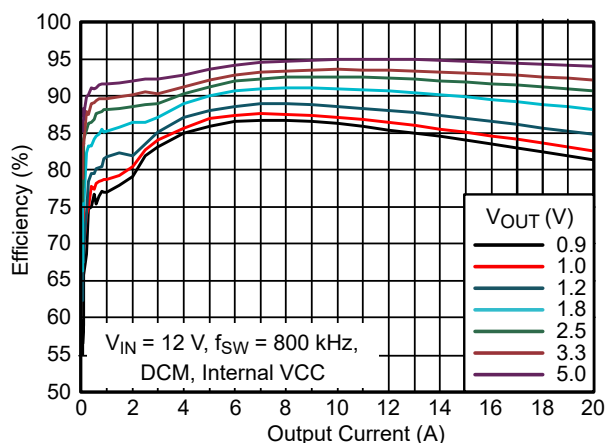

效率与输出电流间的关系



Table of Contents

1 特性	1	8 Application and Implementation	25
2 应用	1	8.1 Application Information.....	25
3 说明	1	8.2 Typical Application.....	25
4 Revision History	2	9 Power Supply Recommendations	35
5 Pin Configuration and Functions	3	10 布局	35
6 Specifications	5	10.1 Layout Guidelines.....	35
6.1 Absolute Maximum Ratings.....	5	10.2 Layout Example.....	36
6.2 ESD Ratings.....	5	11 Device and Documentation Support	37
6.3 Recommended Operating Conditions.....	6	11.1 Device Support.....	37
6.4 Thermal Information.....	6	11.2 Documentation Support.....	37
6.5 Electrical Characteristics.....	7	11.3 支持资源.....	37
6.6 Typical Characteristics.....	9	11.4 接收文档更新通知.....	37
7 Detailed Description	12	11.5 Trademarks.....	37
7.1 Overview.....	12	11.6 Electrostatic Discharge Caution.....	37
7.2 Functional Block Diagram.....	12	11.7 术语表.....	37
7.3 Feature Description.....	13	12 Mechanical, Packaging, and Orderable Information	38
7.4 Device Functional Modes.....	22		

4 Revision History

注：以前版本的页码可能与当前版本的页码不同

Changes from Revision * (July 2021) to Revision A (July 2021)	Page
• 更新了图 3-1	1
• Corrected package designator in 节 5	3
• Corrected package designator in 节 6.4	6

5 Pin Configuration and Functions



图 5-1. RYL Package, 19-Pin VQFN-FCRLF (Top View)



图 5-2. RYL Package, 19-Pin VQFN-FCRLF (Bottom View)

表 5-1. Pin Functions

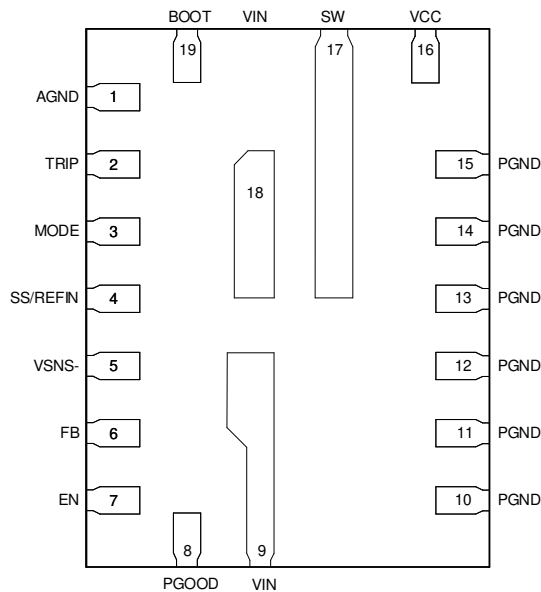
NAME	NO.	I/O ⁽¹⁾	DESCRIPTION
BOOT	19	I/O	Supply rail for the high-side gate driver (boost terminal). Connect the bootstrap capacitor from this pin to SW node.
AGND	1	G	Ground pin. Reference point for the internal control circuits
TRIP	2	I/O	Current limit setting pin. Connect a resistor to AGND to set the current limit trip point. $\pm 1\%$ tolerance resistor is highly recommended. See 节 7.3.9 for details on the OCL setting.
MODE	3	I	The MODE pin sets the Forced Continuous Conduction mode (FCCM) or Skip mode operation. It also selects the operating frequency by connecting a resistor from the MODE pin to AGND. $\pm 1\%$ tolerance resistor is recommended. See 表 7-1 for details.
SS/REFIN	4	I/O	Dual-function pin Soft-start function: Connecting a capacitor to the VSNS - pin programs the soft-start time. Minimum soft-start time (1.5 ms) is fixed internally. A minimum 1-nF capacitor is required for this pin to avoid overshoot during the charge of the soft-start capacitor. REFIN function: The device always looks at the voltage on this SS/REFIN pin as the reference for the control loop. The internal reference voltage can be overridden by an external DC voltage source on this pin for tracking application.
VSNS -	5	I	The return connection for a remote voltage sensing configuration. It is also used as ground for the internal reference. Short to AGND for a single-end sense configuration.
FB	6	I	Output voltage feedback input. A resistor divider from V_{OUT} to VSNS - (tapped to FB pin) sets the output voltage.
EN	7	I	Enable pin (EN). The Enable pin turns the DC/DC switching converter on or off. Floating the EN pin before start-up disables the converter. The maximum recommended operating condition for the EN pin is 5.5 V. <i>Do not</i> connect the EN pin to the VIN pin directly.
PGOOD	8	O	Open-drain power-good status signal. When FB voltage moves outside the specified limits, PGOOD goes low after a 2- μ s delay.
VIN	9,18	P	Power-supply input pins for both integrated power MOSFET pair and the internal LDO. Place the decoupling input capacitors from the VIN pins to the PGND pins as close as possible.
PGND	10,11,12,13,14,15	G	Power ground of the internal low-side MOSFET. At least six PGND vias are required to be placed as close as possible to the PGND pins. This minimizes parasitic impedance and lowers thermal resistance.

表 5-1. Pin Functions (continued)

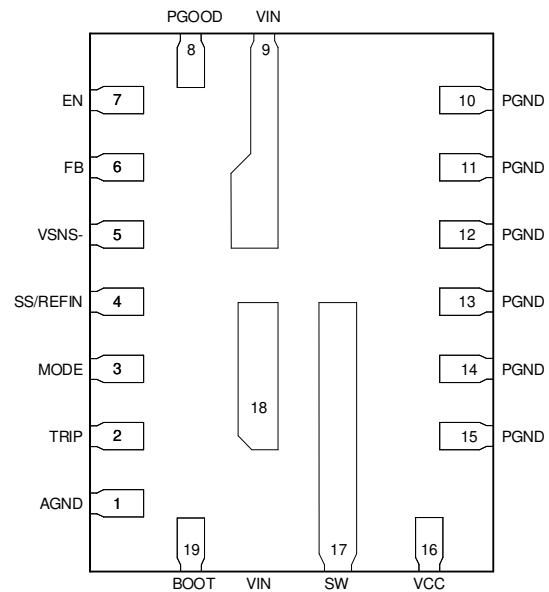
NAME	NO.	I/O ⁽¹⁾	DESCRIPTION
VCC	16	I/O	Internal 3-V LDO output. An external bias with 3.3-V or higher voltage can be connected to this pin to save the power losses on the internal LDO. The voltage source on this pin powers both the internal circuitry and gate driver. Requires a 2.2- μ F, at least 6.3-V, rating ceramic capacitor from the VCC pin to the PGND pins as the decoupling capacitor and the placement is required to be as close as possible.
SW	17	O	Output switching terminal of the power converter. Connect this pin to the output inductor.

(1) I = Input, O = Output, P = Supply, G = Ground

6 Specifications

6.1 Absolute Maximum Ratings

Over operating junction temperature range (unless otherwise noted) ⁽¹⁾

		MIN	MAX	UNIT
Pin voltage	VIN	- 0.3	18	V
	VIN - SW, DC	- 0.3	18	
	VIN - SW, < 10-ns transient	- 1.5	25	
	SW - PGND, DC	- 0.3	18	
	SW - PGND, < 10-ns transient	- 5	21.5	
	BOOT - PGND	- 0.3	22	
	BOOT - SW	- 0.3	4	
	VCC	- 0.3	4	
	EN, PGOOD	- 0.3	6	
	MODE	- 0.3	4	
	TRIP, SS/REFIN, FB	- 0.3	3	
	VSNS -	- 0.3	0.3	
Sinking current	Power-good sinking current capability		10	mA
Operating junction temperature, T _J		- 40	150	°C
Storage temperature, T _{stg}		- 55	150	

- (1) Operation outside the *Absolute Maximum Ratings* may cause permanent device damage. *Absolute Maximum Ratings* do not imply functional operation of the device at these or any other conditions beyond those listed under *Recommended Operating Conditions*. If used outside the *Recommended Operating Conditions* but within the *Absolute Maximum Ratings*, the device may not be fully functional, and this may affect device reliability, functionality, performance, and shorten the device lifetime.

6.2 ESD Ratings

			VALUE	UNIT
V _(ESD)	Electrostatic discharge	Human-body model (HBM), per ANSI/ESDA/ JEDEC JS-001 ⁽¹⁾	±2000	V
		Charged-device model (CDM), per JEDEC specification JESD22-C101 ⁽²⁾	±500	

- (1) JEDEC document JEP155 states that 500-V HBM allows safe manufacturing with a standard ESD control process.
 (2) JEDEC document JEP157 states that 250-V CDM allows safe manufacturing with a standard ESD control process.

6.3 Recommended Operating Conditions

Over operating junction temperature range (unless otherwise noted)

		MIN	NOM	MAX	UNIT
V _{IN}	Input voltage range when the VCC pin is powered by a valid external bias	2.7		16	V
	Input voltage range when using the internal VCC LDO	4.0		16	
	Minimum V _{IN} before enabling the converter when using the internal VCC LDO	3.3			
V _{OUT}	Output voltage range	0.6		5.5	
Pin voltage	External VCC bias	3.13		3.6	
	BOOT to SW	-0.1		3.6	
	EN, PGOOD	-0.1		5.5	
	MODE	-0.1		VCC	
	TRIP, SS/REFIN, FB	-0.1		1.5	
	VSNS - (refer to AGND)	-50		50	
I _{PG}	Power-good input current capability	0		10	mA
I _{LPEAK}	Maximum peak inductor current			28	A
	Minimum R _{TRIP}	0			Ω
T _J	Operating junction temperature	-40		125	°C

6.4 Thermal Information

THERMAL METRIC ⁽¹⁾		TPS548B27		UNIT
		RYL (VQFN, JEDEC)	RYL (VQFN, TI EVM)	
		19 PINS	19 PINS	
R _{θJA}	Junction-to-ambient thermal resistance	49.0	24.1	°C/W
R _{θJC(top)}	Junction-to-case (top) thermal resistance	23.0	Not applicable ⁽²⁾	°C/W
R _{θJB}	Junction-to-board thermal resistance	9.2	Not applicable ⁽²⁾	°C/W
ψ _{JT}	Junction-to-top characterization parameter	0.5	0.7	°C/W
ψ _{JB}	Junction-to-board characterization parameter	9.0	8.7	°C/W

- (1) For more information about traditional and new thermal metrics, see the [Semiconductor and IC Package Thermal Metrics](#) application report.
- (2) Not applicable to an EVM layout.

6.5 Electrical Characteristics

$T_J = -40^\circ\text{C}$ to $+125^\circ\text{C}$, $V_{CC} = 3\text{ V}$ (unless otherwise noted)

PARAMETER		TEST CONDITIONS	MIN	TYP	MAX	UNIT
SUPPLY						
$I_{Q(VIN)}$	V_{IN} quiescent current	$V_{IN} = 12\text{ V}$, $V_{EN} = 2\text{ V}$, $V_{FB} = V_{INTREF} + 50\text{ mV}$ (non-switching), no external bias on the VCC pin		910	1007	μA
$I_{SD(VIN)}$	V_{IN} shutdown supply current	$V_{IN} = 12\text{ V}$, $V_{EN} = 0\text{ V}$, no external bias on the VCC pin		9.5	20	μA
UVLO						
$V_{INUVLO(rise)}$	VIN UVLO rising threshold	V_{IN} rising, $V_{CC} = 3.3\text{-V}$ external bias	2.1	2.4	2.7	V
$V_{INUVLO(fall)}$	VIN UVLO falling threshold	V_{IN} falling, $V_{CC} = 3.3\text{-V}$ external bias	1.55	1.85	2.15	V
ENABLE						
$V_{EN(rise)}$	EN voltage rising threshold	EN rising, enable switching	1.17	1.22	1.27	V
$V_{EN(fall)}$	EN voltage falling threshold	EN falling, disable switching	0.97	1.02	1.07	V
$V_{EN(hyst)}$	EN voltage hysteresis			0.2		V
$V_{EN(LKG)}$	Input leakage current into the EN pin	$V_{EN} = 3.3\text{ V}$		0.5	5	μA
	EN internal pulldown resistance	EN pin to AGND, EN floating disables the converter.		6500		$\text{k}\Omega$
INTERNAL LDO (VCC PIN)						
$V_{CCUVLO(rise)}$	V_{CC} UVLO rising threshold	V_{CC} rising	2.80	2.87	2.94	V
$V_{CCUVLO(fall)}$	V_{CC} UVLO falling threshold	V_{CC} falling	2.62	2.70	2.77	
$V_{CCUVLO(hys)}$	V_{CC} UVLO hysteresis			0.17		V
	V_{CC} LDO dropout voltage, 20-mA load	$T_J = 25^\circ\text{C}$, $V_{IN} = 4.0\text{ V}$, $I_{VCC(Load)} = 20\text{ mA}$, nonswitching			1.037	V
	V_{CC} LDO short-circuit current limit	$V_{IN} = 12\text{ V}$, all temperature	52	105	158	mA
	FB threshold to turn off VCC LDO	VCC LDO turn-off is controlled by FB voltage during EN shutdown event.		90	146	mV
REFERENCE VOLTAGE						
$I_{FB(LKG)}$	Input leakage current into FB pin	$V_{FB} = V_{INTREF}$		1	40	nA
SWITCHING FREQUENCY						
f_{sw}	SW switching frequency, FCCM operation	$T_J = 25^\circ\text{C}$, $V_{IN} = 12\text{ V}$, $V_{OUT} = 1.25\text{ V}$, $R_{MODE} = 0\ \Omega$ to AGND	0.5	0.6	0.7	MHz
		$T_J = 25^\circ\text{C}$, $V_{IN} = 12\text{ V}$, $V_{OUT} = 1.25\text{ V}$, $R_{MODE} = 30.1\text{ k}\Omega$ to AGND	0.6	0.7	0.8	
		$T_J = 25^\circ\text{C}$, $V_{IN} = 12\text{ V}$, $V_{OUT} = 1.25\text{ V}$, $R_{MODE} = 60.4\text{ k}\Omega$ to AGND	0.70	0.85	1.0	
START-UP						
	EN to first switching delay, internal LDO	The delay from EN goes high to the first SW rising edge with internal LDO configuration. $C_{VCC} = 2.2\ \mu\text{F}$, $C_{SS/REFIN} = 220\text{ nF}$		0.93	2	ms
	EN to first switching delay, external VCC bias	The delay from EN goes high to the first SW rising edge with external VCC bias configuration. VCC bias should reach regulation before EN ramp up. $C_{SS/REFIN} = 220\text{ nF}$		0.55	0.9	ms
t_{ss}	Internal fixed soft-start time	V_O rising from 0 V to 95% of final setpoint, $C_{SS/REFIN} = 1\text{ nF}$	1	1.5		ms
	SS/REFIN sourcing current	$V_{SS/REFIN} = 0\text{ V}$		36		μA
	SS/REFIN sinking current	$V_{SS/REFIN} = 1\text{ V}$		12		μA
POWER STAGE						

6.5 Electrical Characteristics (continued)

$T_J = -40^\circ\text{C}$ to $+125^\circ\text{C}$, $V_{CC} = 3\text{ V}$ (unless otherwise noted)

PARAMETER		TEST CONDITIONS	MIN	TYP	MAX	UNIT
BOOT CIRCUIT						
$I_{\text{BOOT(LKG)}}$	BOOT leakage current	$T_J = 25^\circ\text{C}$, $V_{\text{BOOT-SW}} = 3.3\text{ V}$		35	50	μA
$V_{\text{BOOT-SW(UV_F)}}$	BOOT-SW UVLO falling threshold	$T_J = 25^\circ\text{C}$, $V_{\text{IN}} = 12\text{ V}$, $V_{\text{BOOT-SW}}$ falling		2.0		V
OVERCURRENT PROTECTION						
I_{NOCL}	Negative current limit threshold	All V_{INs}	-12	-10	-8	A
I_{ZC}	Zero-cross detection current threshold, open loop	$V_{\text{IN}} = 12\text{ V}$, $V_{\text{CC}} = \text{internal LDO}$		400		mA
OUTPUT OVP AND UVP						
V_{OVP}	Output overvoltage-protection (OVP) threshold voltage		113%	116%	119%	
$t_{\text{OVP(delay)}}$	Output OVP response delay	With 100-mV overdrive		400		ns
V_{UVP}	Output undervoltage-protection (UVP) threshold voltage		77%	80%	83%	
$t_{\text{UVP(delay)}}$	Output UVP filter delay			68		μs
POWER GOOD						
V_{PGTH}	PGOOD threshold	PGOOD high, FB rising	89%	92.5%	95%	
		PGOOD low, FB rising	113%	116%	119%	
		PGOOD low, FB falling	77%	80%	83%	
	OOB (out-of-bounds) threshold	PGOOD high, FB rising	103%	105.5%	108%	
I_{PG}	PGOOD sink current	$V_{\text{PGOOD}} = 0.4\text{ V}$, $V_{\text{IN}} = 12\text{ V}$, $V_{\text{CC}} = \text{internal LDO}$			17	mA
$V_{\text{PG(low)}}$	PGOOD low-level output voltage	$I_{\text{PGOOD}} = 5.5\text{ mA}$, $V_{\text{IN}} = 12\text{ V}$, $V_{\text{CC}} = \text{internal LDO}$			400	mV
$t_{\text{PGDLY(rise)}}$	Delay for PGOOD from low to high			1.06	1.33	ms
$t_{\text{PGDLY(fall)}}$	Delay for PGOOD from high to low			0.5	5	μs
$I_{\text{PG(LKG)}}$	PGOOD leakage current when pulled high	$T_J = 25^\circ\text{C}$, $V_{\text{PGOOD}} = 3.3\text{ V}$, $V_{\text{FB}} = V_{\text{INTREF}}$			5	μA
	PGOOD clamp low-level output voltage	$V_{\text{IN}} = 0\text{ V}$, $V_{\text{CC}} = 0\text{ V}$, $V_{\text{EN}} = 0\text{ V}$, PGOOD pulled up to 3.3 V through a 100-k Ω resistor		710	850	mV
		$V_{\text{IN}} = 0\text{ V}$, $V_{\text{CC}} = 0\text{ V}$, $V_{\text{EN}} = 0\text{ V}$, PGOOD pulled up to 3.3 V through a 10-k Ω resistor		850	1000	mV
	Min VCC for valid PGOOD output	$V_{\text{PGOOD}} \leq 0.4\text{ V}$			1.5	V
OUTPUT DISCHARGE						
R_{Dischg}	Output discharge resistance	$V_{\text{IN}} = 12\text{ V}$, $V_{\text{CC}} = \text{internal LDO}$, $V_{\text{SW}} = 0.5\text{ V}$, power conversion disabled		70		Ω
THERMAL SHUTDOWN						
T_{SDN}	Thermal shutdown threshold ⁽¹⁾	Temperature rising	150	165		$^\circ\text{C}$
T_{HYST}	Thermal shutdown hysteresis ⁽¹⁾			30		$^\circ\text{C}$

(1) Specified by design. Not production tested.

6.6 Typical Characteristics



图 6-1. Efficiency vs Output Current, 12 V_{IN} , 800 KHz, DCM, $V_{CC} = \text{Int}$



图 6-2. Efficiency vs Output Current, 12 V_{IN} , 800 KHz, DCM, $V_{CC} = \text{EXT } 3.3 \text{ V}$

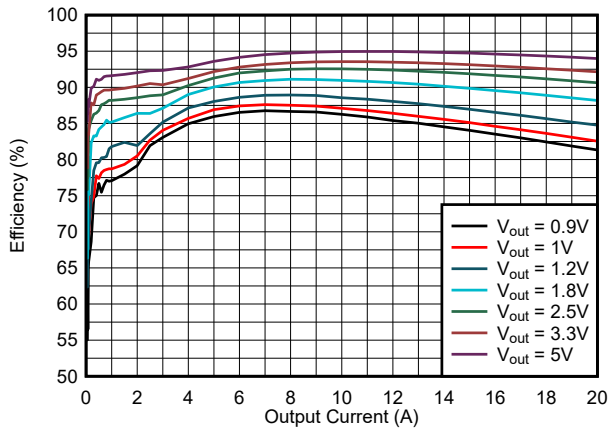

图 6-3. Safe Operating Area, $V_{OUT} = 1.0 \text{ V}$

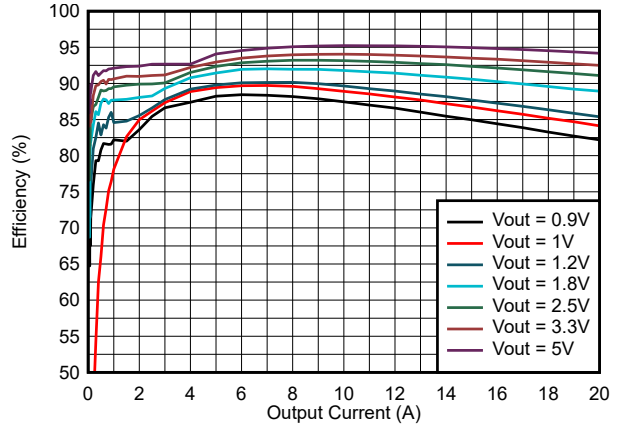

图 6-4. Safe Operating Area, $V_{OUT} = 5 \text{ V}$

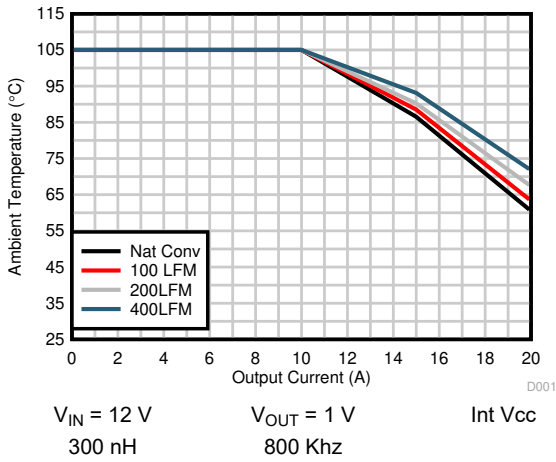

图 6-5. Safe Operating Area, $V_{OUT} = 1 \text{ V}$

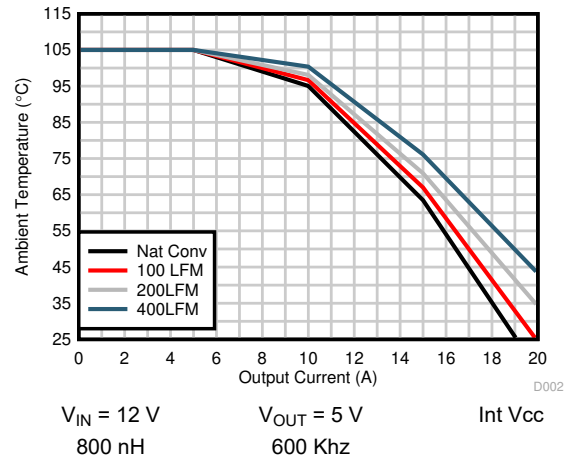

图 6-6. Safe Operating Area, $V_{OUT} = 5 \text{ V}$

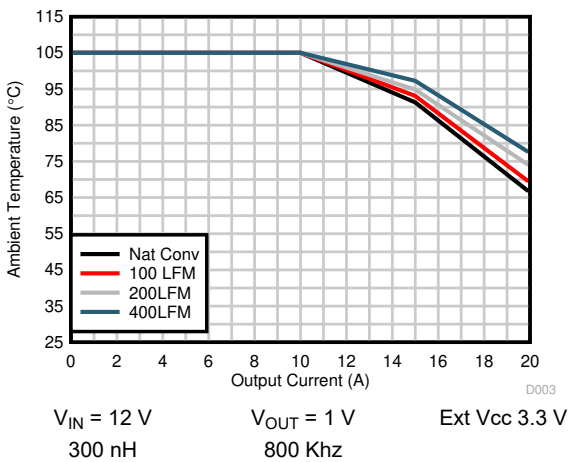

图 6-7. Output Voltage vs Output Current

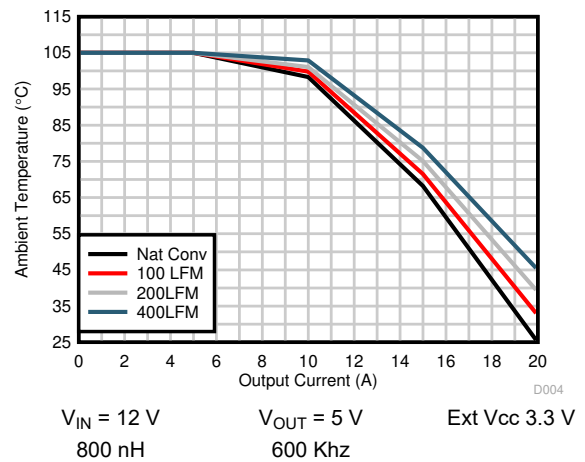

图 6-8. $I_{SD}(V_{IN})$ vs Junction Temperature

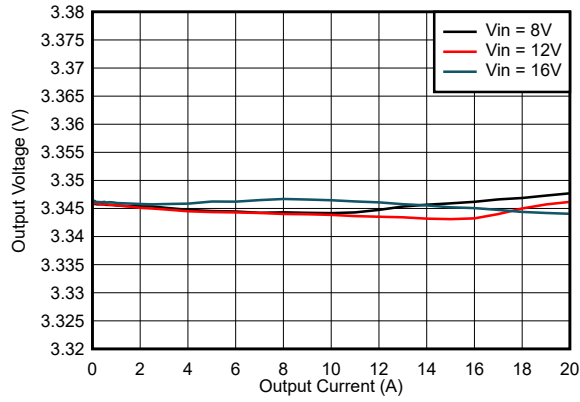

图 6-9. VCC LDO vs Junction Temperature

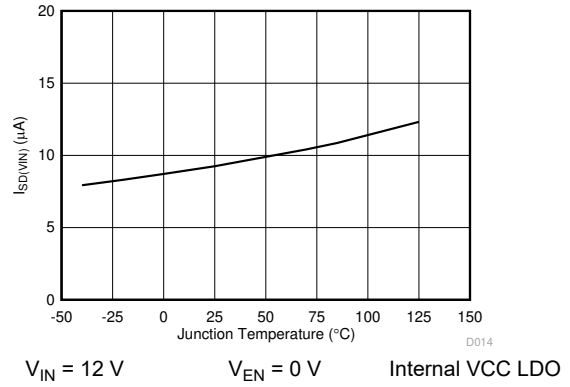

图 6-10. $I_{SS}(\text{source})$ vs Junction Temperature

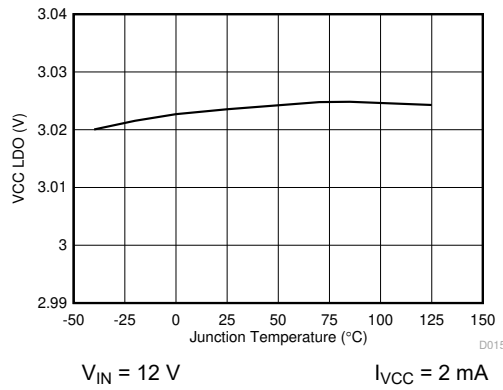

图 6-11. Load Transient

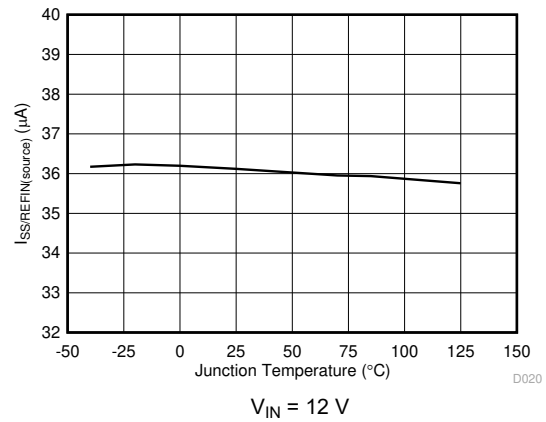

图 6-12. Unload Transient

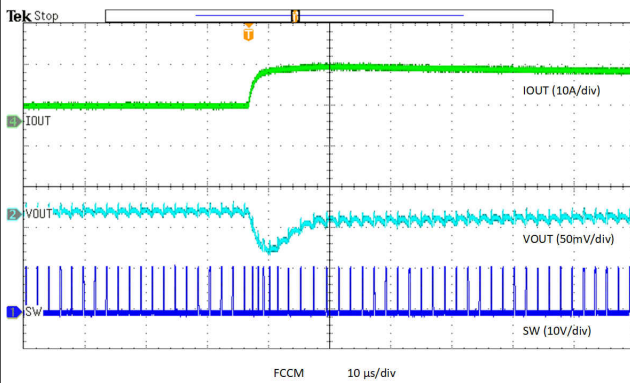

图 6-13. Enable Power Up, Skip

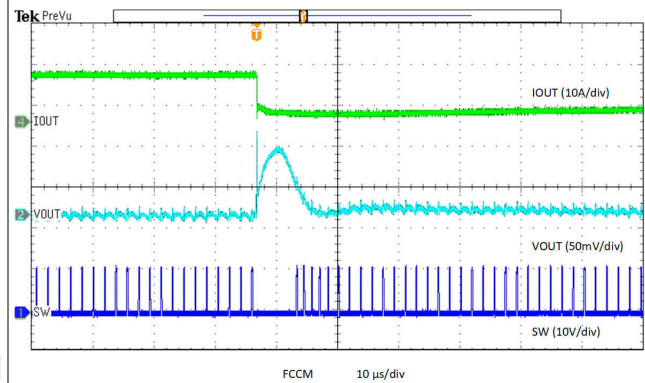

图 6-14. Enable Power Down, Skip

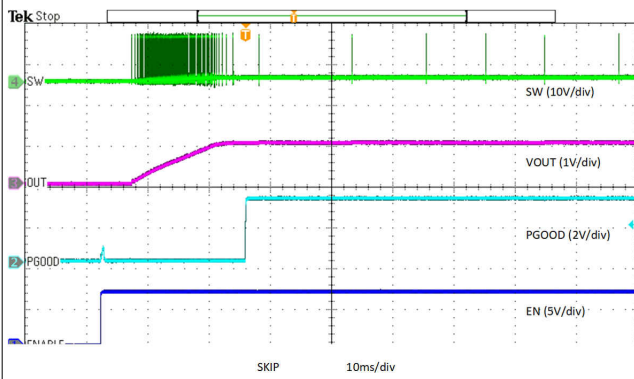

图 6-15. Enable Power Up, Pre-Bias

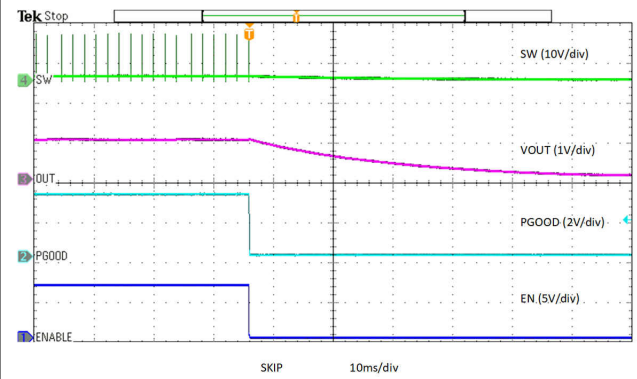

图 6-16. V_{OUT} Ripple, FCCM, 20-A Load

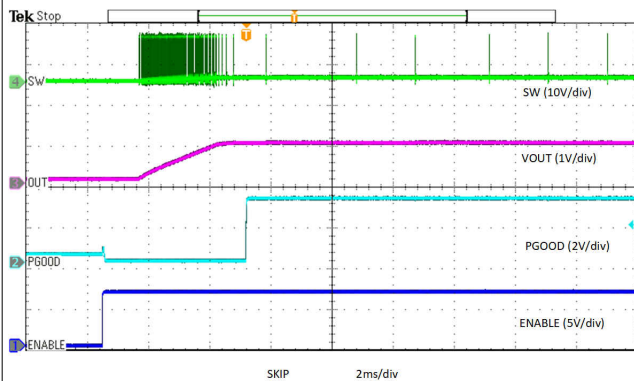

图 6-17. V_{OUT} Ripple, FCCM, 0-A Load

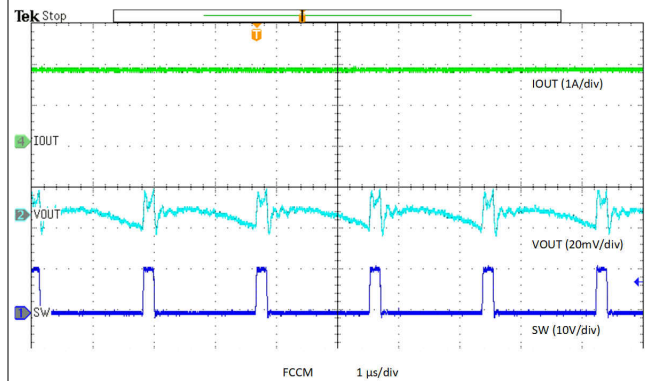

图 6-18. V_{OUT} Ripple, Skip Mode, 10-mA Load

7 Detailed Description

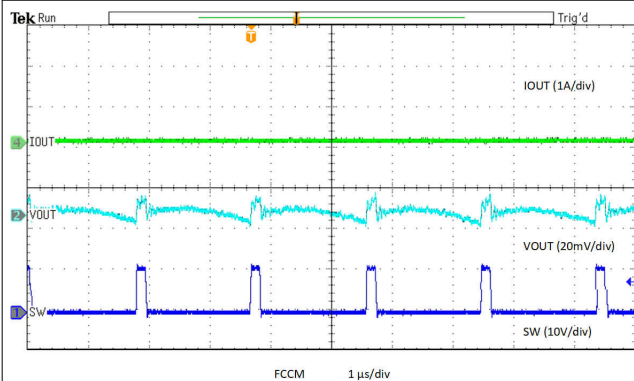
7.1 Overview

The TPS548B27 device is a high-efficiency, single-channel, small-sized, synchronous-buck converter. The device suits low output voltage point-of-load applications with 20-A or lower output current in server, storage, and similar computing applications. The TPS548B27 features proprietary D-CAP3 mode control combined with adaptive on-time architecture. This combination builds modern low-duty-ratio and ultra-fast load-step-response DC/DC converters in an ideal fashion. The output voltage ranges from 0.6 V to 5.5 V. The conversion input voltage ranges from 2.7 V to 16 V, and the VCC input voltage ranges from 3.13 V to 3.6 V. The D-CAP3 mode uses emulated current information to control the modulation. An advantage of this control scheme is that it does not require a phase-compensation network outside, which makes the device easy to use and also allows low external component count. Another advantage of this control scheme is that it supports stable operation with all low-ESR output capacitors (such as ceramic capacitor and low-ESR polymer capacitor). Adaptive on-time control tracks the preset switching frequency over a wide range of input and output voltages while increasing switching frequency as needed during load-step transient.

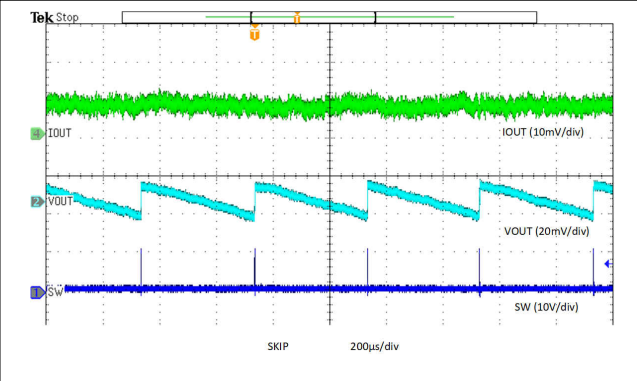
7.2 Functional Block Diagram

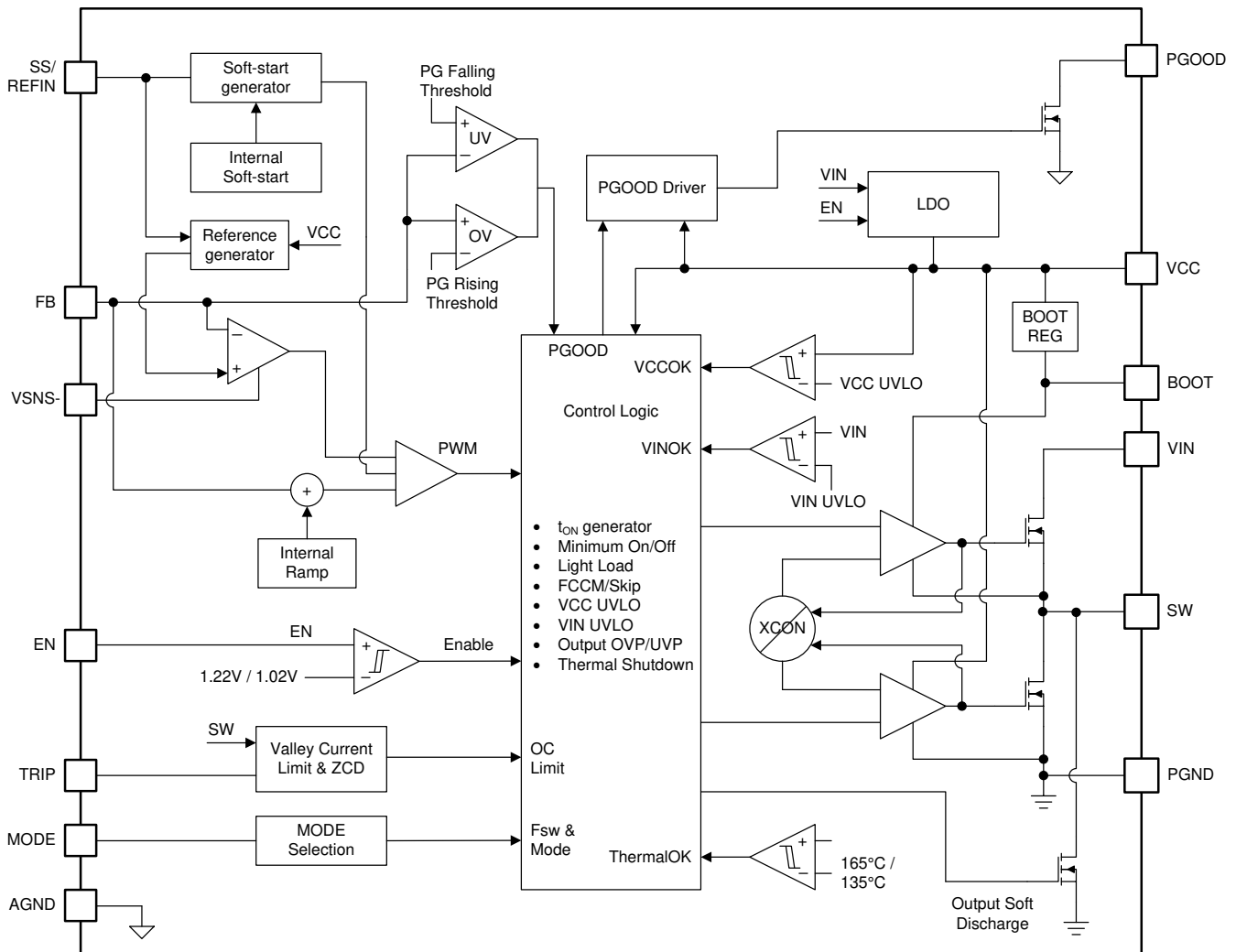

7.3 Feature Description

7.3.1 Internal VCC LDO and Using External Bias on VCC Pin

The TPS548B27 has an internal 3.0-V LDO, featuring input from VIN and output to VCC. When the EN voltage rises above the enable threshold (typically 1.22 V), the internal LDO is enabled and starts regulating output voltage on the VCC pin. The VCC voltage provides the bias voltage for the internal analog circuitry and also provides the supply voltage for the gate drives.

The VCC pin needs to be bypassed with a 2.2- μ F, at least 6.3-V rating, ceramic capacitor. An external bias that is above the output voltage of the internal LDO can override the internal LDO. This enhances the efficiency of the converter because the VCC current now runs off this external bias instead of the internal linear regulator.

The VCC UVLO circuit monitors the VCC pin voltage and disables the whole converter when VCC falls below the VCC UVLO falling threshold. Maintaining a stable and clean VCC voltage is required for a smooth operation of the device.

Considerations when using an external bias on the VCC pin are as follows:

- When the external bias is applied on the VCC pin early enough (for example, before EN signal comes in), the internal LDO will be always forced off and the internal analog circuits will have a stable power supply rail at their power enable.
- (Not recommended) When the external bias is applied on the VCC pin late (for example, after EN signal comes in), any power-up and power-down sequencing can be applied as long as there is no excess current pulled out of the VCC pin. It is important to understand that an external discharge path on the VCC pin, which can pull a current higher than the current limit of the internal LDO from the VCC pin, can potentially turn off VCC LDO, thereby shutting down the converter output.
- A good power-up sequence is when at least one of VIN UVLO rising threshold or EN rising threshold is satisfied later than the VCC UVLO rising threshold. For example, a practical power-up sequence is: VIN is applied first, then the external bias applied, and then EN signal goes high.

7.3.2 Enable

When the EN pin voltage rises above the enable threshold voltage (typically 1.22 V) and V_{IN} rises above the V_{IN} UVLO rising threshold, the device enters its internal power-up sequence. The EN to first switching delay is specified in the Start-up section in the Electrical Characteristics table.

When using the internal VCC LDO, the internal power-up sequence includes three sequential steps. During the first period, the VCC voltage is charged up on a VCC bypass capacitor by an 11-mA current source. The length of this VCC LDO start-up time varies with the capacitance on the VCC pin. However, if the V_{IN} voltage ramps up very slowly, the VCC LDO output voltage will be limited by the V_{IN} voltage level, thus the VCC LDO start-up time can be extended longer. Since the VCC LDO start-up time is relatively long, the internal V_{INTREF} build-up happens and finishes during this period. Once the VCC voltage crosses above VCC UVLO rising threshold (typically 2.87 V), the device moves to the second step, power-on delay. The MODE pin setting detection, SS/REFIN pin detection, and control loop initialization are finished within this 285- μ s delay. Soft-start ramp starts when the 285- μ s power-on delay finishes. During the soft-start ramp power stage, switching does not happen until the SS/REFIN pin voltage reaches 50 mV. This introduces a SS delay that varies with the external capacitance on the SS/REFIN pin.

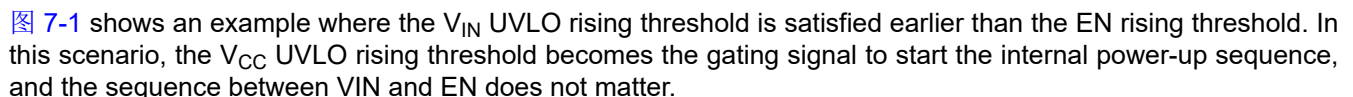
 **图 7-1** shows an example where the V_{IN} UVLO rising threshold is satisfied earlier than the EN rising threshold. In this scenario, the V_{CC} UVLO rising threshold becomes the gating signal to start the internal power-up sequence, and the sequence between V_{IN} and EN does not matter.

When using an external bias on the VCC pin, the internal power-up sequence still includes three sequential steps. The first period is much shorter since VCC voltage is built up already. A 100- μ s period allows the internal references to start up and reach regulation points. This 100- μ s period includes not only the 0.6-V V_{INTREF} , but also all of the other reference voltages for various functions. The device then moves to the second step, power-on delay. The MODE pin setting detection, SS/REFIN pin detection, and control loop initialization are finished within this 285- μ s delay. Soft-start ramp starts when the 285- μ s power-on delay finishes. During the soft-start

ramp power stage, switching does not happen until the SS/REFIN pin voltage reaches 50 mV. This introduces a SS delay that varies with the external capacitance on the SS/REFIN pin.

图 7-2 shows an example where the V_{IN} UVLO rising threshold and EN rising threshold are satisfied later than the V_{CC} UVLO rising threshold. In this scenario, the V_{IN} UVLO rising threshold or EN rising threshold, whichever is satisfied later, becomes the gating signal to start the internal power-up sequence.



图 7-1. Internal Power-Up Sequence Using Internal LDO



图 7-2. Internal Power-Up Sequence Using External Bias

The EN pin has an internal filter to avoid unexpected ON or OFF due to small glitches. The time constant of this RC filter is 5 μ s. For example, when applying a 3.3-V voltage source on the EN pin that jumps from 0 V to 3.3 V with an ideal rising edge, the internal EN signal will reach 2.086 V after 5 μ s, which is 63.2% of applied 3.3-V voltage level.

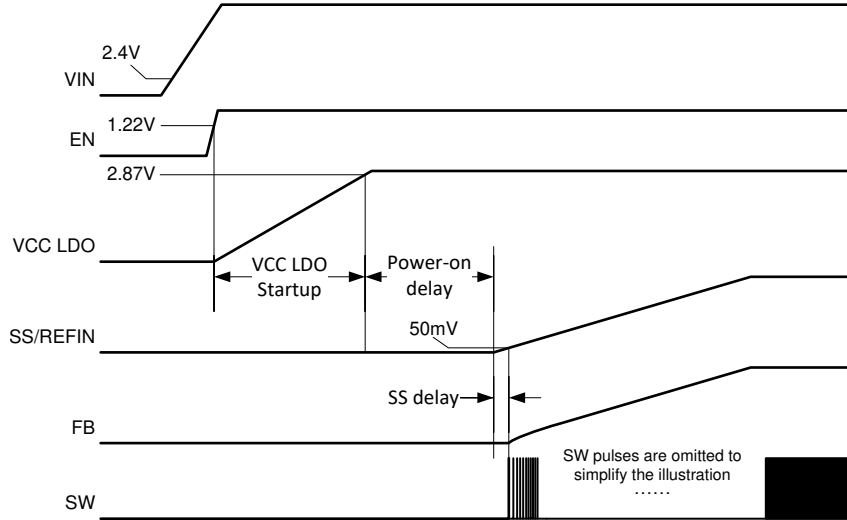
A internal pulldown resistor is implemented between the EN pin and AGND pin. To avoid impact to the EN rising/falling threshold, this internal pulldown resistor is set to 6.5 M Ω . With this pulldown resistor, floating the EN pin before start-up keeps the device under disabled state. During nominal operation when the power stage switches, this large internal pulldown resistor may not have enough noise immunity to hold EN the pin low.

The maximum recommended operating condition for the EN pin is 5.5 V. *Do not* connect the EN pin to the VIN pin directly.

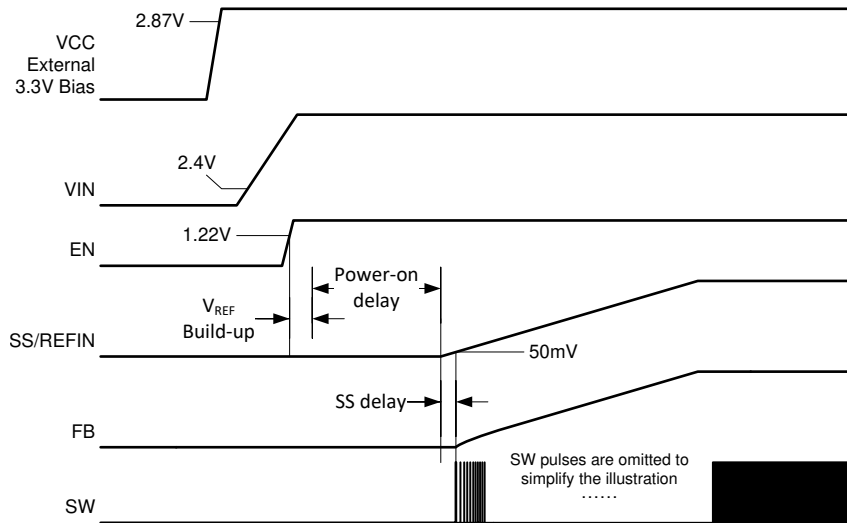
7.3.3 Output Voltage Setting

The output voltage is programmed by the voltage-divider resistors, R_{FB_HS} and R_{FB_LS} . Connect R_{FB_HS} between the FB pin and the positive node of the load, and connect R_{FB_LS} between the FB pin and VSNS - pin. The recommended R_{FB_LS} value is 10 k Ω , ranging from 1 k Ω to 20 k Ω . Determine R_{FB_HS} by using [方程式 1](#).

$$R_{FB_HS} = \frac{V_O - V_{INTREF}}{V_{INTREF}} \times R_{FB_LS} \quad (1)$$

The FB accuracy is determined by two elements. The first element is the accuracy of the internal 600-mV reference, which will be applied to the SS/REFIN pin unless an external V_{REF} is applied. The TPS548B27 device offers $\pm 0.5\%$ V_{INTREF} accuracy from a 0°C to 85°C temperature range, and $\pm 1.0\%$ V_{INTREF} accuracy from a -40°C to 125°C temperature range. The second element is the SS/REFIN-to-FB accuracy, which tells the user how accurately the control loop regulates FB node to SS/REFIN pin. The TPS548B27 offers $\pm 0.6\%$ SS/REFIN-to-FB accuracy from a -40°C to 125°C temperature range. For example, when operating from a 0°C to 85°C temperature range, the total FB accuracy is $\pm 1.1\%$, which includes the impact from chip junction temperature and also the variation from part to part.

To improve the overall V_{OUT} accuracy, using a $\pm 1\%$ accuracy or better resistor for the FB voltage divider is highly recommended.

Regardless of remote sensing or single-end sensing connection, the FB voltage divider, R_{FB_HS} and R_{FB_LS} , should be always placed as close as possible to the device.

7.3.3.1 Remote Sense

The TPS548B27 offers remote sense function through the FB and VSNS - pins. Remote sense function compensates a potential voltage drop on the PCB traces, helping maintain V_{OUT} tolerance under steady-state operation and load transient event. Connecting the FB voltage divider resistors to the remote location allows sensing to the output voltage at a remote location. The connections from the FB voltage divider resistors to the remote location should be a pair of PCB traces with at least 12-mil trace width, and should implement Kelvin sensing across a high bypass capacitor of 0.1 μ F or higher. The ground connection of the remote sensing signal must be connected to the VSNS - pin. The V_{OUT} connection of the remote sensing signal must be connected to the feedback resistor divider with the lower feedback resistor, R_{FB_LS} , terminated at the VSNS - pin. To maintain stable output voltage and minimize the ripple, the pair of remote sensing lines should stay away from any noise sources such as inductor and SW nodes, or high frequency clock lines. It is recommended to shield the pair of remote sensing lines with ground planes above and below.

Single-ended V_O sensing is often used for local sensing. For this configuration, connect the higher FB resistor, R_{FB_HS} , to a high-frequency local bypass capacitor of 0.1 μ F or higher, and short VSNS - to AGND.

The recommended VSNS - operating range (refer to AGND pin) is -50 mV to +50 mV.

7.3.4 Internal Fixed Soft Start and External Adjustable Soft Start

The TPS548B27 implements a circuit to allow both internal fixed soft start and external adjustable soft start. The internal soft-start time is typically 1.5 ms. The soft-start time can be increased by adding a soft-start (SS) capacitor between the SS/REFIN and VSNS - pins. The total SS capacitor value can be determined by [方程式 2](#). The device follows the longer SS ramp among the internal SS time and the SS time determined by the external SS capacitors. The recommended maximum SS capacitor is 1 μ F. A minimum 1-nF SS capacitor is required.

The device does not require a capacitor from the SS/REFIN pin to AGND, thus it is not recommended to place a capacitor from the SS/REFIN pin to AGND. If both $C_{SS/REFIN\text{-to-VSNS-}}$ and $C_{SS/REFIN\text{-to-AGND}}$ capacitors exist, place $C_{SS/REFIN\text{-to-VSNS-}}$ more closely with shortest trace back to the VSNS - pin.

$$C_{SS}(\text{nF}) = \frac{t_{SS}(\text{ms}) \times 36(\mu\text{A})}{V_{INTREF}(\text{V})} \quad (2)$$

The TPS548B27 provides an analog input pin (SS/REFIN) to accept an external reference. When an external voltage signal is applied between the SS/REFIN pin and VSNS - pin, it acts as the reference voltage, thus FB voltage follows this external voltage signal exactly. Applying this external reference to the SS/REFIN pin before the EN high signal is recommended. The external reference must be equal to or higher than the internal reference level to ensure correct power-good thresholds during soft start.

With an external reference applied, the internal fixed soft-start controls the output voltage ramp during start-up. After soft start finishes, the external voltage signal can be in a range of 0.5 V to 1.2 V.

When driving the SS/REFIN pin with an external resistor divider, the resistance should be low enough so that the external voltage source can overdrive the internal current source.

7.3.5 External REFIN For Output Voltage Tracking

The TPS548B27 provides an analog input pin (SS/REFIN) to accept an external reference (a DC voltage source). The device always looks at the voltage on this SS/REFIN pin as the reference for the control loop. When an external voltage reference is applied between the SS/REFIN pin and VSNS - pin, it acts as the reference voltage, so the FB voltage follows this external voltage reference exactly. The same $\pm 0.6\%$ SS/REFIN-to-FB accuracy from the -40°C to 125°C temperature range applies here too.

In the middle of internal power-on delay, a detection circuit senses the voltage on the SS/REFIN pin to tell whether an active DC voltage source is applied. Before the detection happens, the SS/REFIN pin tries to discharge any energy on SS/REFIN capacitors through an internal $120\text{-}\Omega$ resistor to AGND. This discharge lasts for $125\text{ }\mu\text{s}$. Then, within a $32\text{-}\mu\text{s}$ window, the detection circuit compares the SS/REFIN pin voltage with an internal reference equal to 89% of V_{INTREF} . This discharge operation ensures a SS capacitor with left-over energy will not be wrongly detected as a voltage reference. If the external voltage reference fails to supply sufficient current and hold voltage level higher than 89% of V_{INTREF} , the SS/REFIN detection circuit will provide the wrong detection result.

If the detection result is that SS/REFIN pin voltage falls below 89% of V_{INTREF} , which means no external reference is connected, the device first uses the internal fixed V_{INTREF} as the reference for the PGOOD, V_{OUT} OVP, and V_{OUT} UVP thresholds. On this configuration, given the SS/REFIN pin sees a soft-start ramp on this pin, the slower ramp along with the internal fixed soft start and the external soft start determine the start-up of FB. Once both the internal and external soft-start ramp finishes, the power-good signal becomes high after a 1.06-ms internal delay. The whole internal soft-start ramp takes 2 ms to finish. The external soft-start done signal goes high when FB reaches a threshold equal to $V_{\text{INTREF}} - 50\text{ mV}$. The device waits for the PGOOD status transition from low to high, then starts using the SS/REFIN pin voltage, instead of the internal V_{INTREF} as the reference for PGOOD, V_{OUT} OVP, and V_{OUT} UVP threshold.

If the detection result is that the SS/REFIN pin voltage holds higher than 89% of V_{INTREF} , which means an active DC voltage source is used as an external reference, the device always uses the SS/REFIN pin voltage instead of the internal V_{INTREF} as the reference for the PGOOD, V_{OUT} OVP, and V_{OUT} UVP thresholds. On this configuration, since the SS/REFIN pin sees a DC voltage and no soft-start ramp on this pin, the internal fixed soft start is used for start-up. Once the internal soft-start ramp finishes, the power-good signal becomes high after a 1.06-ms internal delay. The whole internal soft-start ramp takes 2 ms to finish because the soft-start ramp goes beyond V_{INTREF} .

On this external REFIN configuration, applying a stabilized DC external reference to the SS/REFIN pin before the EN high signal is recommended. During the internal power-on delay, the external reference should be capable of holding the SS/REFIN pin equal to or higher than 89% of V_{INTREF} , so that the device can correctly detect the external reference and choose the right thresholds for power good, V_{OUT} OVP, and V_{OUT} UVP. After the power-good status goes from low to high, the external reference can be set in a range from 0.5 V to 1.2 V . To overdrive the SS/REFIN pin during nominal operation, the external reference has to be able to sink more than $36\text{-}\mu\text{A}$ current if the external reference is lower than the internal V_{INTREF} , or source more than $12\text{-}\mu\text{A}$ current if the external reference is higher than the internal V_{INTREF} . When driving the SS/REFIN pin by an external reference through a resistor divider, the resistance of the divider should be low enough to provide the sinking, or sourcing current capability.

The configuration of applying EN high signal first, then applying an external ramp on the SS/REFIN pin as a tracking reference can be achieved, as long as design considerations for power good, V_{OUT} OVP, and V_{OUT} UVP have been taken. Please contact Texas Instruments for detailed information about this configuration.

If the external voltage source must transition up and down between any two voltage levels, the slew rate must be no more than 1 mV/ μ s.

7.3.6 Frequency and Operation Mode Selection

The TPS548B27 provides forced CCM operation for tight output ripple application and auto-skip Eco-mode for high light-load efficiency. The TPS548B27 allows users to select the switching frequency and operation mode by connecting a resistor from the MODE pin to AGND pin. 表 7-1 lists the resistor values for the switching frequency and operation mode selection. TI recommends $\pm 1\%$ tolerance resistors with a typical temperature coefficient of ± 100 ppm/ $^{\circ}$ C.

The MODE state will be set and latched during the internal power-on delay period. Changing the MODE pin resistance after the power-on delay will not change the status of the device. The internal circuit will set the MODE pin status to 600 kHz / Skip mode if the MODE pin is left open during the power-on delay period.

To make sure the internal circuit detects the desired option correctly, *do not* place any capacitor on the MODE pin.

表 7-1. MODE Pin Selection

MODE PIN CONNECTIONS	OPERATION MODE UNDER LIGHT LOAD	SWITCHING FREQUENCY (f_{sw}) (kHz) ⁽¹⁾
Short to VCC	Skip mode	600
243 k Ω \pm 10% to AGND	Skip mode	800
121 k Ω \pm 10% to AGND	Skip mode	1000
60.4 k Ω \pm 10% to AGND	Forced CCM	1000
30.1 k Ω \pm 10% to AGND	Forced CCM	800
Short to AGND	Forced CCM	600

(1) Switch frequency is based on 3.3 V_{OUT} . Frequency varies with V_{OUT} .

7.3.7 D-CAP3 Control



图 7-3. Internal RAMP Generation Circuit

The TPS548B27 uses D-CAP3 mode control to achieve fast load transient while maintaining the ease-of-use feature. The D-CAP3 control architecture includes an internal ripple generation network enabling, the use of very low-ESR output capacitors such as multi-layered ceramic capacitors (MLCC), and low-ESR polymer capacitors. No external current sensing network or voltage compensators are required with D-CAP3 control architecture. The role of the internal ripple generation network is to emulate the ripple component of the inductor current information and then combine it with the voltage feedback signal to regulate the loop operation. The amplitude of the ramp is determined by V_{IN} , V_{OUT} , operating frequency, and the R-C time-constant of the internal ramp circuit. At different switching frequency settings (see 表 7-1), the R-C time-constant varies to maintain relatively constant ramp amplitude. Also, the device uses internal circuitry to cancel the DC offset caused by an injected ramp, and significantly reduces the DC offset caused by the output ripple voltage, especially under light load condition.

For any control topologies supporting no external compensation design, there is a minimum range, maximum range, or both, of the output filter it can support. The output filter used with the TPS548B27 is a low-pass L-C circuit. This L-C filter has a double pole that is described in [方程式 3](#).

$$f_p = \frac{1}{2 \times \pi \times \sqrt{L_{OUT} \times C_{OUT}}} \quad (3)$$

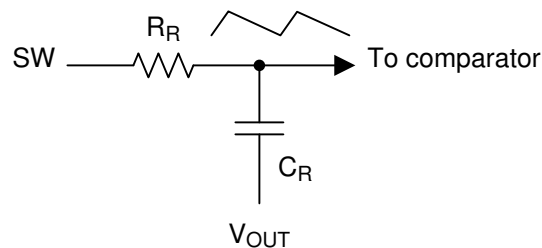
At low frequencies, the overall loop gain is set by the output set-point resistor divider network and the internal gain of the TPS548B27. The low frequency L-C double pole has a 180-degree drop in phase. At the output filter frequency, the gain rolls off at a -40-dB per decade rate and the phase drops rapidly. The internal ripple generation network introduces a high-frequency zero that reduces the gain roll off from -40-dB to -20-dB per decade and increases the phase by 90 degrees per decade above the zero frequency.

After identifying the application requirements, the output inductance should be designed so that the inductor peak-to-peak ripple current is approximately between 15% and 40% of the maximum output current.

The inductor and capacitor selected for the output filter must be such that the double pole of [方程式 3](#) is located no higher than 1/30th of operating frequency. Choose very small output capacitance leads to relative high frequency L-C double pole, allowing overall loop gain to stay high until the L-C double frequency. Given the zero from the internal ripple generation network is relatively high frequency as well, the loop with very small output capacitance may have too high crossover frequency, which is not desired. Use [表 7-2](#) to help locate the internal zero based on the selected switching frequency.

表 7-2. Locating the Zero

SWITCHING FREQUENCIES (f_{sw}) (kHz)	ZERO (f_z) LOCATION (kHz)
600	84.5
800	84.5
1000	106

In general, where reasonable (or smaller) output capacitance is desired, the output ripple requirement and load transient requirements can be used to determine the necessary output capacitance for stable operation.

For the maximum output capacitance recommendation, select the inductor and capacitor values so that the L-C double pole frequency is no less than 1/100th of operating frequency. With this starting point, verify the small signal response on the board making sure the phase margin at the loop crossover is greater than 50 degrees.

The actual maximum output capacitance can go higher as long as phase margin is greater than 50 degrees. However, small signal measurement (bode plot) should be done to confirm the design.

If MLCC is used, consider the derating characteristics to determine the final output capacitance for the design. For example, when using an MLCC with specifications of 10 μ F, X5R and 6.3 V, the derating by DC bias and AC bias are 80% and 50%, respectively. The effective derating is the product of these two factors, in this case, 40% and 4 μ F. Consult with capacitor manufacturers for specific characteristics of the capacitors to be used in the system/applications.

For higher output voltage at or above 2 V, additional phase boost can be required to secure sufficient phase margin due to phase delay/loss for higher output voltage (large on time (t_{ON})) setting in a fixed-on-time topology based operation. A feedforward capacitor placed in parallel with R_{FB_HS} is found to be very effective to boost the phase margin at loop crossover. Refer to the [Optimizing Transient Response of Internally Compensated dc-dc Converters With Feedforward Capacitor](#) application report for details.

Besides boosting the phase, a feedforward capacitor feeds more V_{OUT} node information into the FB node by the AC coupling. This feedforward during load transient event enables the control loop a faster response to V_{OUT} deviation. However, this feedforward during steady state operation also feeds more V_{OUT} ripple and noise into FB. High ripple and noise on FB usually leads to more jitter, or even double pulse behavior. To determine the final feedforward capacitor value, impacts to phase margin, load transient performance, and ripple and noise on

FB should be all considered. Using frequency analysis equipment to measure the crossover frequency and the phase margin is recommended.

7.3.8 Low-Side FET Zero-Crossing

The TPS548B27 uses a zero-crossing circuit to perform the zero inductor-current detection during Skip mode operation. The function compensates the inherent offset voltage of the Z-C comparator and delay time of the Z-C detection circuit. The zero-crossing threshold is set to a positive value to avoid negative inductor current. As a result, the device delivers better light-load efficiency.

7.3.9 Current Sense and Positive Overcurrent Protection

For a buck converter, during the on time of the high-side FET, the switch current increases at a linear rate determined by input voltage, output voltage, the on time, and the output inductor value. During the on time of the low-side FET, this current decreases linearly. The average value of the switch current equals to the load current.

The output overcurrent limit (OCL) in the TPS548B27 device is implemented using a cycle-by-cycle valley current detect control circuit. The inductor current is monitored during the on time of the low-side FET by measuring the low-side FET drain-to-source current. If the measured drain-to-source current of the low-side FET is above the current limit threshold, the low-side FET stays ON until the current level becomes lower than the current limit threshold. This type of behavior reduces the average output current sourced by the device. During an overcurrent condition, the current to the load exceeds the current to the output capacitors. Thus, the output voltage tends to decrease. Eventually, when the output voltage falls below the undervoltage-protection threshold (80%), the UVP comparator detects it and shuts down the device after a wait time of 68 μ s. The device then enters a hiccup sleep period for approximately 14 ms. After this waiting period, the device attempts to start up again. [图 7-4](#) shows the cycle-by-cycle valley current limit behavior as well as the wait time before the device shuts down.

If an OCL condition happens during start-up, the device still has cycle-by-cycle current limit based on low-side valley current. After soft start is finished, the UV event which is caused by the OC event, shuts down the device and enters Hiccup mode with a wait time of 68 μ s.

The resistor, R_{TRIP} , connected from the TRIP pin to AGND sets current limit threshold. A $\pm 1\%$ tolerance resistor is highly recommended because a worse tolerance resistor provides less accurate OCL threshold. [方程式 4](#) calculates the R_{TRIP} for a given overcurrent limit threshold on the device. To simplify the calculation, use a constant, K_{OCL} , to replace the value of 12×10^4 . [方程式 4](#) calculates the overcurrent limit threshold for a given R_{TRIP} value. The tolerance of K_{OCL} is listed in [节 6.5](#) to help the user analyze the tolerance of the overcurrent limit threshold.

To protect the device from unexpected connection on the TRIP pin, an internal fixed OCL clamp is implemented. This internal OCL clamp limits the maximum valley current on LS FET when TRIP pin has too small resistance to AGND, or is accidentally shorted to ground.

$$R_{TRIP} = \frac{12 \times 10^4}{I_{OCLIM} - \frac{1}{2} \times \frac{(V_{IN} - V_O) \times V_O}{V_{IN}} \times \frac{1}{L \times f_{SW}}} = \frac{K_{OCL}}{I_{OCLIM} - \frac{1}{2} \times \frac{(V_{IN} - V_O) \times V_O}{V_{IN}} \times \frac{1}{L \times f_{SW}}} \quad (4)$$

where

- I_{OCLIM} is overcurrent limit threshold for load current in A
- R_{TRIP} is TRIP resistor value in Ω
- K_{OCL} is a constant for the calculation
- V_{IN} is input voltage value in V
- V_O is output voltage value in V
- L is output inductor value in μ H
- f_{SW} is switching frequency in MHz

$$I_{OCLIM} = \frac{K_{OCL}}{R_{TRIP}} + \frac{1}{2} \times \frac{(V_{IN} - V_O) \times V_O}{V_{IN}} \times \frac{1}{L \times f_{SW}}$$

where

- I_{OCLIM} is overcurrent limit threshold for load current in A
- R_{TRIP} is TRIP resistor value in Ω
- K_{OCL} is a constant for the calculation
- V_{IN} is input voltage value in V
- V_O is output voltage value in V
- L is output inductor value in μH
- f_{SW} is switching frequency in MHz



图 7-4. Overcurrent Protection

7.3.10 Low-Side FET Negative Current Limit

The device has a fixed, cycle-by-cycle negative current limit. Similar with the positive overcurrent limit, the inductor current is monitored during the on time of the low-side FET. To prevent too large negative current flowing through the low-side FET, when the low-side FET detects a -10-A current (typical threshold), the device turns off the low-side FET, then turns on the high-side FET for a proper on time (determined by $V_{IN}/V_O/f_{SW}$). After the high-side FET on time expires, the low-side FET turns on again.

The device should not trigger the -10-A negative current limit threshold during nominal operation, unless a small inductor value that is too small is chosen or the inductor becomes saturated. This negative current limit is utilized to discharge output capacitors during an output OVP or an OOB event. See 节 7.3.12 and 节 7.3.13 for details.

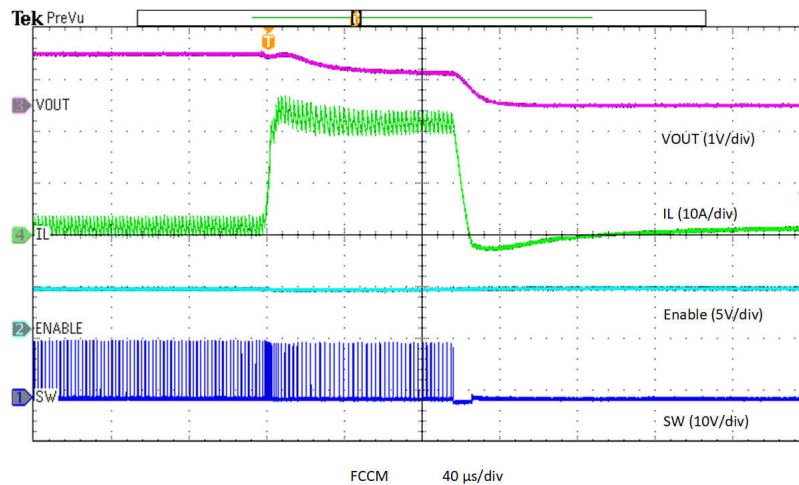
7.3.11 Power Good

The device has power-good output that indicates high when the converter output is within the target. The power-good output is an open-drain output and must be pulled up to the VCC pin or an external voltage source ($< 5.5\text{ V}$) through a pullup resistor (typically $30.1\text{ k}\Omega$). The recommended power-good pullup resistor value is $1\text{ k}\Omega$ to $100\text{ k}\Omega$.

Once both the internal and external soft-start ramp finishes, the power-good signal becomes high after a 1.06-ms internal delay. The whole internal soft-start ramp takes 2 ms to finish. The external soft-start done signal goes high when FB reaches threshold equal to $V_{INTREF} - 50\text{ mV}$. If the FB voltage drops to 80% of the V_{INTREF} voltage or exceeds 116% of the V_{INTREF} voltage, the power-good signal latches low after a $2\text{-}\mu\text{s}$ internal delay. The power-good signal can only be pulled high again after re-toggling EN or a reset of VIN.

If the input supply fails to power up the device, for example VIN and VCC both stay at zero volts, the PG pin clamps low by itself when this pin is pulled up through an external resistor.

Once VCC voltage level rises above the minimum VCC threshold for valid PGOOD output (maximum 1.5 V), internal power-good circuit is enabled to hold the PGOOD pin to the default status. By default, PGOOD is pulled low and this low-level output voltage is no more than 400 mV with 5.5-mA sinking current. The power-good function is fully activated after the soft-start operation is completed.

7.3.12 Overvoltage and Undervoltage Protection

The device monitors a resistor-divided feedback voltage to detect overvoltage and undervoltage events. When the FB voltage becomes lower than 80% of the V_{INTREF} voltage, the UVP comparator detects and an internal UVP delay counter begins counting. After the 68- μ s UVP delay time, the device enters Hiccup mode and restarts with a sleep time of 14 ms. The UVP function enables after the soft-start period is complete.

When the FB voltage becomes higher than 116% of the V_{INTREF} voltage, the OVP comparator detects and the circuit latches OFF the high-side MOSFET driver and turns on the low-side MOSFET until reaching a negative current limit I_{NOCL} . Upon reaching the negative current limit, the low-side FET is turned off, and the high-side FET is turned on again, for a proper on time (determined by $V_{IN}/V_O/f_{SW}$). The device operates in this cycle until the output voltage is pulled down under the UVP threshold voltage for 68 μ s. After the 68- μ s UVP delay time, the device enters hiccup mode and re-starts with a sleep time of 14 ms.

During the 68- μ s UVP delay time, if the output voltage becomes higher than the UV threshold, thus is not qualified for a UV event, the timer will be reset to zero. When the output voltage triggers the UV threshold again, the timer of the 68 μ s restarts.

7.3.13 Out-Of-Bounds (OOB) Operation

The device has an out-of-bounds (OOB) overvoltage protection that protects the output load at a much lower overvoltage threshold of 5% above the V_{INTREF} voltage. OOB protection does not trigger an overvoltage fault, so the device is on non-latch mode after an OOB event. OOB protection operates as an early no-fault overvoltage-protection mechanism. During the OOB operation, the controller operates in forced CCM mode. Turning on the low-side FET beyond the zero inductor current quickly discharges the output capacitor, thus helps the output voltage to fall quickly towards the setpoint. During the operation, the cycle-by-cycle negative current limit is also activated to ensure the safe operation of the internal FETs.

7.3.14 Output Voltage Discharge

When the device is disabled through EN, it enables the Output Voltage Discharge mode. This mode forces both high-side and low-side FETs to latch off, but turns on the discharge FET, which is connected from SW to PGND, to discharge the output voltage. Once the FB voltage drops below 90 mV, the discharge FET is turned off.

The output voltage discharge mode is activated by any of the following fault events:

1. EN pin goes low to disable the converter.
2. Thermal shutdown (OTP) is triggered.
3. V_{CC} UVLO (falling) is triggered.
4. V_{IN} UVLO (falling) is triggered.

7.3.15 UVLO Protection

The device monitors the voltage on both the VIN and the VCC pins. If the VCC pin voltage is lower than the V_{CCUVLO} falling threshold voltage, the device shuts off. If the VCC voltage increases beyond the V_{CCUVLO} rising threshold voltage, the device turns back on. VCC UVLO is a non-latch protection.

When the VIN pin voltage is lower than the V_{INUVLO} falling threshold voltage but the VCC pin voltage is still higher than V_{CCUVLO} rising threshold voltage, the device stops switching and discharges SS/REFIN pin. Once the VIN voltage increases beyond the V_{INUVLO} rising threshold voltage, the device re-initiates the soft start and switches again. V_{IN} UVLO is a non-latch protection.

7.3.16 Thermal Shutdown

The device monitors internal junction temperature. If the temperature exceeds the threshold value (typically 165°C), the device stops switching and discharges the SS/REFIN pin. When the temperature falls approximately

30°C below the threshold value, the device turns back on with a re-initiated soft start. Thermal shutdown is a non-latch protection.

7.4 Device Functional Modes

7.4.1 Auto-Skip Eco-mode Light Load Operation

While the MODE pin is pulled to VCC directly or connected to the AGND pin through a resistor larger than 121 k Ω , the device automatically reduces the switching frequency at light-load conditions to maintain high efficiency. This section describes the operation in detail.

As the output current decreases from heavy load condition, the inductor current also decreases until the rippled valley of the inductor current touches zero level. Zero level is the boundary between the Continuous-conduction and Discontinuous-conduction modes. The synchronous MOSFET turns off when this zero inductor current is detected. As the load current decreases further, the converter runs into Discontinuous-conduction mode (DCM). The on time is maintained to a level approximately the same as during Continuous-conduction mode operation so that discharging the output capacitor with a smaller load current to the level of the reference voltage requires more time. The transition point to the light-load operation $I_{O(LL)}$ (for example, the threshold between Continuous- and Discontinuous-conduction mode) is calculated as shown in [方程式 5](#).

$$I_{OUT(LL)} = \frac{1}{2 \times L \times f_{SW}} \times \frac{(V_{IN} - V_{OUT}) \times V_{OUT}}{V_{IN}} \quad (5)$$

where

- f_{SW} is the switching frequency

Only using ceramic capacitors is recommended for Skip mode.

7.4.2 Forced Continuous Conduction Mode

When the MODE pin is tied to the AGND pin through a resistor less than 60.4 k Ω , the controller operates in Continuous-conduction mode (CCM) during light-load conditions. During CCM, the switching frequency maintained to an almost constant level over the entire load range which is suitable for applications requiring tight control of the switching frequency at the cost of lower efficiency.

7.4.3 Powering the Device from a 12-V Bus

The device works well when powering from a 12-V bus with a single V_{IN} configuration. As a single V_{IN} configuration, the internal LDO is powered by a 12-V bus and generates a 3.0-V output to bias the internal analog circuitry and powers up the gate drives. The V_{IN} input range under this configuration is 4 V to 16 V for up to 20-A load current. [图 7-5](#) shows an example for this single V_{IN} configuration.

VIN and EN are the two signals to enable the part. For start-up sequence, any sequence between the VIN and EN signals can power the device up correctly.



图 7-5. Single V_{IN} Configuration for a 12-V Bus

7.4.4 Powering the Device from a 3.3-V Bus

The device can also work for up to a 20-A load current when powering from a 3.3-V bus with a single V_{IN} configuration. To ensure the internal analog circuitry and the gate drives are powered up properly, the VCC pin should be shorted to the VIN pins with low impedance trace. A trace with at least 24-mil width is recommended. A 2.2- μ F, at least 6.3-V rating VCC-to-PGND decoupling capacitor is still recommended to be placed as close as possible to the VCC pin. Due to the maximum rating limit on the VCC pin, the V_{IN} input range under this configuration is 3 V to 3.6 V. The input voltage must stay higher than both VIN UVLO and VCC UVLO, otherwise the device will shut down immediately. 图 7-6 shows an example for this single V_{IN} configuration.

VIN and EN are the two signals to enable the part. For start-up sequence, any sequence between the VIN and EN signals can power the device up correctly.

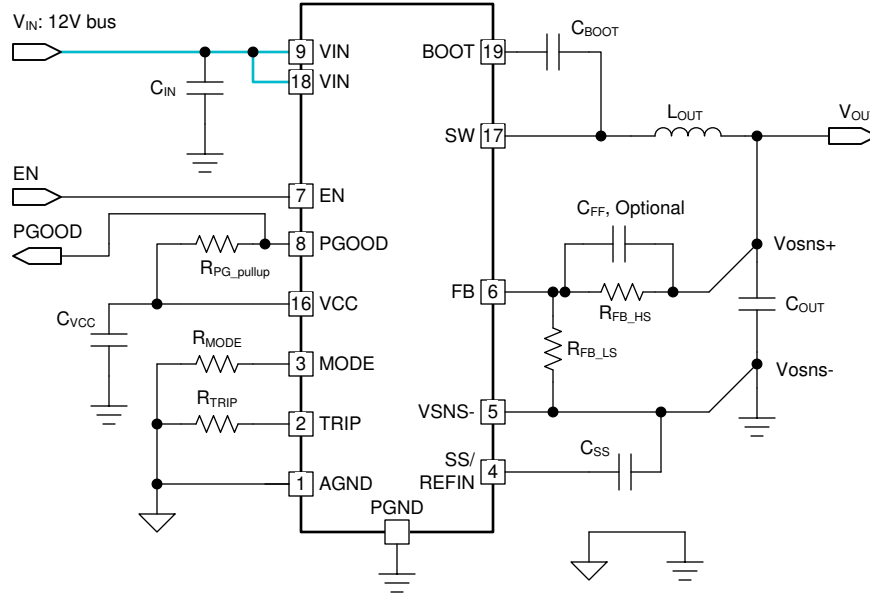

图 7-6. Single V_{IN} Configuration for a 3.3-V Bus

7.4.5 Powering The Device from a Split-rail Configuration

When an external bias, which is at a different level from main V_{IN} bus, is applied onto the VCC pin, the device can be configured to split-rail by using both the main V_{IN} bus and VCC bias. Connecting a valid VCC bias to VCC pin overrides the internal LDO, thus saving power loss on that linear regulator. This configuration helps improve overall system level efficiency but requires a valid VCC bias. A 3.3-V rail is the common choice as VCC bias. With a stable VCC bias, the V_{IN} input range under this configuration can be as low as 2.7 V and up to 16 V.

The noise of the external bias affects the internal analog circuitry. To ensure a proper operation, a clean, low-noise external bias and good local decoupling capacitor from the VCC pin to PGND pin are required. 图 7-7 shows an example for this split rail configuration.

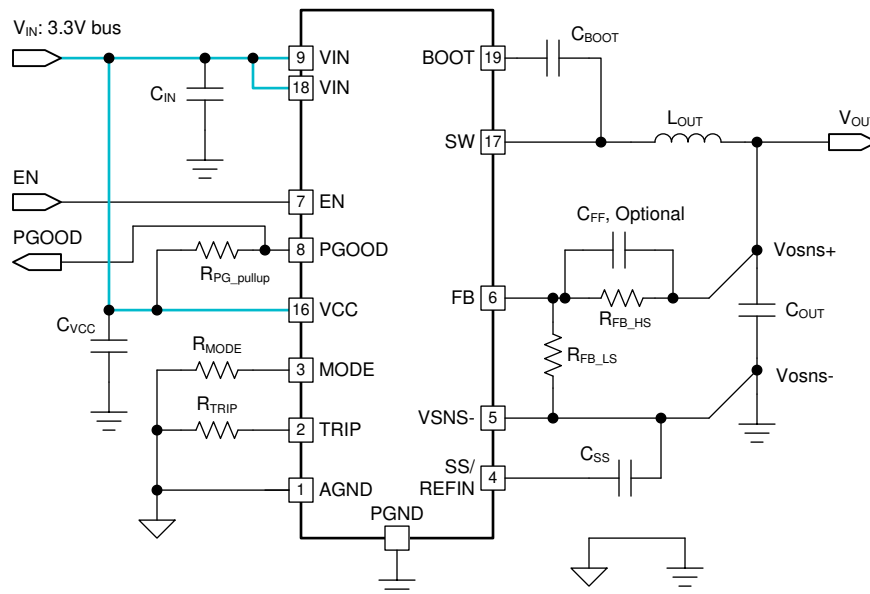
The VCC external bias current during nominal operation varies with the bias voltage level and also the operating frequency. For example, by setting the device to Skip mode, the VCC pins draw less and less current from the external bias when the frequency decreases under light load condition. The typical VCC external bias current under FCCM operation is listed in 节 6.5 to help the user prepare the capacity of the external bias.

Under split rail configuration, V_{IN} , VCC bias, and EN are the signals to enable the part. For start-up sequence, it is recommended that at least one of V_{IN} UVLO rising threshold and EN rising threshold is satisfied later than the VCC UVLO rising threshold. A practical start-up sequence example is: V_{IN} applied first, the external bias applied, and then EN signal goes high.



图 7-7. Split Rail Configuration with External VCC Bias

8 Application and Implementation

备注

以下应用部分中的信息不属于 TI 器件规格的范围，TI 不担保其准确性和完整性。TI 的客户应负责确定器件是否适用于其应用。客户应验证并测试其设计，以确保系统功能。

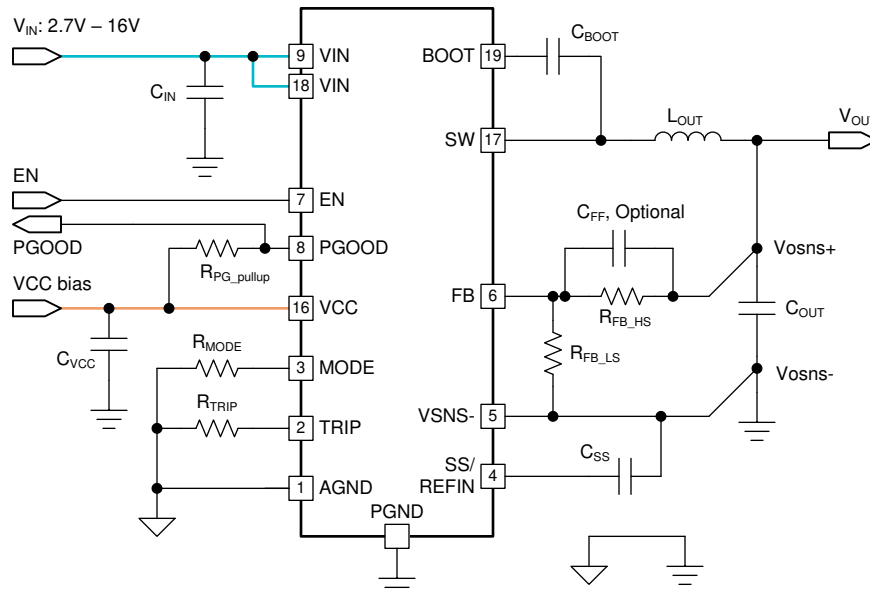
8.1 Application Information

The TPS548B27 device is a high-efficiency, single-channel, small-sized, synchronous-buck converter. The device suits low output voltage point-of-load applications with 20 A or lower output current in server, storage, and similar computing applications. The TPS548B27 features proprietary D-CAP3 mode control combined with adaptive on-time architecture. This combination builds modern low-duty-ratio and ultra-fast load-step-response DC/DC converters in an ideal fashion. The output voltage ranges from 0.6 V to 5.5 V. The conversion input voltage ranges from 2.7 V to 16 V, and the VCC input voltage ranges from 3.13 V to 3.6 V. The D-CAP3 mode uses emulated current information to control the modulation. An advantage of this control scheme is that it does not require an external phase-compensation network, which makes the device easy to use and allows for a low external component count. Another advantage of this control scheme is that it supports stable operation with all low-ESR output capacitors (such as ceramic capacitor and low-ESR polymer capacitor). Adaptive on-time control tracks the preset switching frequency over a wide range of input and output voltages while increasing switching frequency as needed during a load-step transient.

8.2 Typical Application

The schematic shows a typical application for TPS548B27. This example describes the design procedure of converting an input voltage range of 8V to 16 V down to 1 V with a maximum output current of 20 A.



图 8-1. TPS548B27 Application Circuit Diagram

8.2.1 Design Requirements

This design uses the parameters listed in .

8.2.2 Detailed Design Procedure

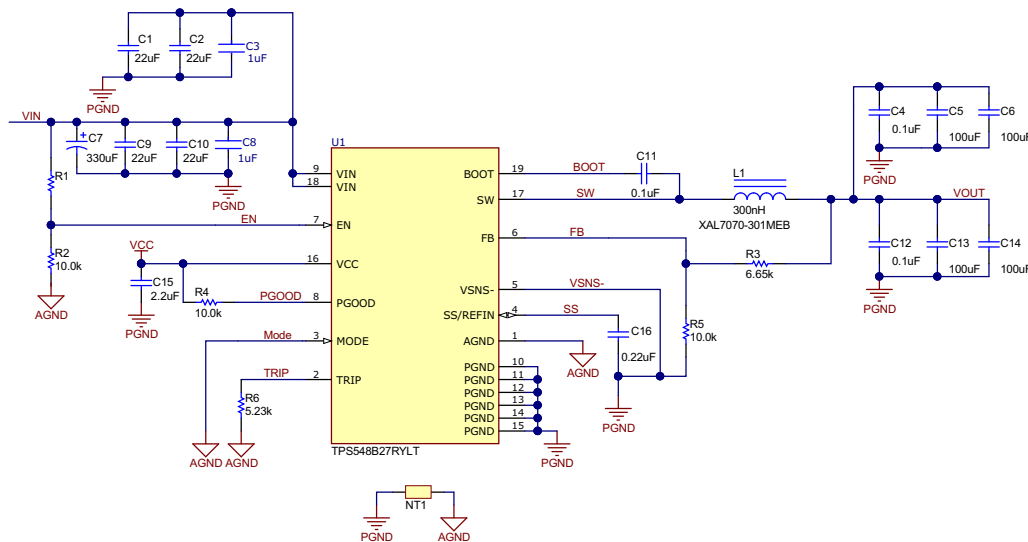
The external component selection is a simple process using D-CAP3 mode. Select the external components using the following steps.

8.2.2.1 Output Voltage Setting Point

The output voltage is programmed by the voltage divider resistors, R1 and R2, shown in [方程式 6](#). Connect R1 between the FB pin and the output, and connect R2 between the FB pin and VSNS -. The recommended R2 value is 10 kΩ, but it can also be set to another value between the range of 1 kΩ to 20 kΩ. Determine R1 by using [方程式 6](#):

$$R_1 = R_2 \times \left(\frac{V_{OUT} - V_{REF}}{V_{REF}} \right) = 10 \text{ k}\Omega \times \left(\frac{1.0 \text{ V} - 0.6 \text{ V}}{0.6 \text{ V}} \right) = 6.67 \text{ k}\Omega \quad (6)$$

8.2.2.2 Choose the Switching Frequency and the Operation Mode

The switching frequency and operation mode are configured by the resistor on the MODE pin. Select one of three switching frequencies: 600 kHz, 800 kHz, or 1 MHz. Refer to [表 7-1](#) for the relationship between the switching frequency, operation mode, and R_{MODE}.

Switching frequency selection is a tradeoff between higher efficiency and smaller system solution size. Lower switching frequency yields higher overall efficiency, but relatively bigger external components. Higher switching frequencies cause additional switching losses, which impact efficiency and thermal performance. For this design, short the MODE pin to AGND to set the switching frequency to 0.6 MHz and set the operation mode as FCCM.

When selecting the switching frequency of a buck converter, the minimum on time and minimum off time must be considered. [方程式 7](#) calculates the maximum f_{SW} before being limited by the minimum on time. When hitting the minimum on-time limits of a converter with D-CAP3 control, the effective switching frequency will change to keep the output voltage regulated. This calculation ignores resistive drops in the converter to give a worst case estimation.

$$f_{SW}(\text{max}) = \frac{V_{OUT}}{V_{IN}(\text{max})} \times \frac{1}{t_{ON_MIN}(\text{max})} = \frac{1.0 \text{ V}}{16 \text{ V}} \times \frac{1}{85 \text{ ns}} = 715 \text{ kHz} \quad (7)$$

[方程式 7](#) calculates the maximum f_{SW} before being limited by the minimum off time. When hitting the minimum off-time limits of a converter with D-CAP3 control, the operating duty cycle will max out and the output voltage will begin to drop with the input voltage. This equation requires the DC resistance of the inductor, R_{DCR}, selected in the following step, so this preliminary calculation assumes a resistance of 1.1mΩ. If operating near the maximum f_{SW} limited by the minimum off time, the variation in resistance across temperature must be considered when using [方程式 8](#). The selected f_{SW} of 600 kHz is below the two calculated maximum values.

$$f_{SW(\text{max})} = \frac{V_{IN(\text{min})} - V_{OUT} - I_{OUT(\text{max})} \times (R_{DCR} + R_{DS(\text{on})HS})}{t_{OFFMIN(\text{max})} \times (V_{IN(\text{min})} - I_{OUT(\text{max})} \times (R_{DS(\text{on})HS} - R_{DS(\text{on})LS})} \quad (8)$$

$$= \frac{8 \text{ V} - 1 \text{ V} - 20 \text{ A} \times (2.2 \text{ m}\Omega + 7.7 \text{ m}\Omega)}{220 \text{ ns} \times (8 \text{ V} - 20 \text{ A} \times (7.7 \text{ m}\Omega - 2.4 \text{ m}\Omega))} = 3929 \text{ kHz}$$

8.2.2.3 Choose the Inductor

To calculate the value of the output inductor (L_{OUT}), use [方程式 9](#). The output capacitor filters the inductor-ripple current (I_{IND(ripple)}). Therefore, selecting a high inductor-ripple current impacts the selection of the output capacitor because the output capacitor must have a ripple-current rating equal to or greater than the inductor-ripple current. On the other hand, larger ripple current increases output ripple voltage, but improves signal-to-

noise ratio and helps stabilize operation. Generally speaking, the inductance value should set the ripple current at approximately 15% to 40% of the maximum output current for a balanced performance.

For this design, the inductor-ripple current is set to 30% of 20-A output current. With a 600-kHz switching frequency, 16 V as maximum V_{IN} , and 1.0 V as the output voltage, the calculated inductance is 0.260 μH .

$$L = \frac{(V_{IN}(\text{max}) - V_{OUT}) \times V_{OUT}}{I_{\text{RIPPLE}} \times V_{IN}(\text{max}) \times f_{\text{SW}}} = \frac{(16 \text{ V} - 1.0 \text{ V}) \times 1.0 \text{ V}}{0.3 \times 20 \text{ A} \times 16 \text{ V} \times 600 \text{ kHz}} = 0.260 \mu\text{H} \quad (9)$$

The inductor requires a low DCR to achieve good efficiency. The inductor also requires enough room above peak inductor current before saturation. The peak inductor current is estimated using 方程式 11. For this design, by selecting 5.24k Ω as the R_{TRIP} , $I_{\text{OC}(\text{valley})}$ is set to 23 A, thus peak inductor current under maximum V_{IN} is calculated as 5.208A.

$$I_{\text{RIPPLE}} = \frac{(V_{IN}(\text{max}) - V_{OUT}) \times V_{OUT}}{L \times V_{IN}(\text{max}) \times f_{\text{SW}}} = \frac{(16 \text{ V} - 1.0 \text{ V}) \times 1.0 \text{ V}}{0.3 \mu\text{H} \times 16 \text{ V} \times 600 \text{ kHz}} = 5.208 \text{ A} \quad (10)$$

$$I_{\text{L}(\text{PEAK})} = I_{\text{OUT}} + \frac{I_{\text{RIPPLE}}}{2} = 20 \text{ A} + \frac{5.208 \text{ A}}{2} = 22.604 \text{ A} \quad (11)$$

$$I_{\text{L}(\text{RMS})} = \sqrt{I_{\text{OUT}}^2 + \frac{I_{\text{RIPPLE}}^2}{12}} = \sqrt{20 \text{ A}^2 + \frac{5.208 \text{ A}^2}{12}} = 20.06 \text{ A} \quad (12)$$

The selected inductance is a Coilcraft XAL7070-301MEB. This has a saturation current rating of 55.6 A, RMS current rating of 26.1 A, and a DCR of 1.17-m Ω max. This inductor was selected for its low DCR to get high efficiency.

8.2.2.4 Set the Current Limit (TRIP)

The R_{TRIP} resistor sets the valley current limit. 方程式 13 calculates the recommended current limit target as 17.57 A. We increased this value by 30% to 22.84A. Use 方程式 14 to calculate the R_{TRIP} resistor to set the current limit. The typical valley current limit target is 22.84A and the closest standard value for R_{TRIP} is 5.24k Ω .

$$I_{\text{LIM_VALLEY}} = \left(I_{\text{OUT}} - \frac{1}{2} \times \frac{(V_{IN}(\text{min}) - V_{OUT}) \times V_{OUT}}{L \times V_{IN}(\text{min}) \times f_{\text{SW}}} \right)$$

$$I_{\text{LIM_VALLEY}} = \left(20 \text{ A} - \frac{1}{2} \times \frac{(8 \text{ V} - 1.0 \text{ V}) \times 1.0 \text{ V}}{0.3 \mu\text{H} \times 8 \text{ V} \times 600 \text{ kHz}} \right) = 17.57 \text{ A} \quad (13)$$

$$R_{\text{TRIP}} = \frac{120000}{I_{\text{LIM_VALLEY}}} = \frac{120000}{22.84 \text{ A}} = 5.25 \text{ k}\Omega \quad (14)$$

With the current limit set, 方程式 15 calculates the typical maximum output current at current limit. 方程式 16 calculates the typical peak current at current limit. As mentioned in 节 8.2.2.3, the saturation behavior of the inductor at the peak current during current limit must be considered. For worst case calculations, the tolerance of the inductance and the current limit must be included.

$$I_{\text{OUT_LIM}(\text{min})} = I_{\text{LIM_VALLEY}} + \frac{1}{2} \times \frac{(V_{IN}(\text{min}) - V_{OUT}) \times V_{OUT}}{L \times V_{IN}(\text{min}) \times f_{\text{SW}}} = 20 \text{ A} + \frac{1}{2} \times \frac{(8 \text{ V} - 1.0 \text{ V}) \times 1.0 \text{ V}}{0.3 \mu\text{H} \times 8 \text{ V} \times 600 \text{ kHz}} = 22.43 \text{ A} \quad (15)$$

$$I_{\text{L}(\text{PEAK})} = I_{\text{OUT}} + \frac{I_{\text{RIPPLE}}}{2} = 20 \text{ A} + \frac{5.208 \text{ A}}{2} = 22.604 \text{ A} \quad (16)$$

8.2.2.5 Choose the Output Capacitor

There are three considerations for selecting the value of the output capacitor:

1. Stability
2. Steady state output voltage ripple
3. Regulator transient response to a change load current

First, the minimum output capacitance should be calculated based on these three requirements. 方程式 17 calculates the minimum capacitance to keep the LC double pole below 1/30th the f_{SW} in order to meet stability requirements. This requirement helps keep the LC double pole close to the internal zero. 方程式 18 calculates the minimum capacitance to meet the steady state output voltage ripple requirement of 10 mV. This calculation is for CCM operation and does not include the portion of the output voltage ripple caused by the ESR or ESL of the output capacitors.

$$C_{OUT_STABILITY} > \left(\frac{30}{2\pi \times f_{SW}} \right)^2 \times \frac{1}{L} = \left(\frac{30}{2\pi \times 600 \text{ kHz}} \right)^2 \times \frac{1}{0.3 \mu\text{H}} = 211.3 \mu\text{F} \quad (17)$$

$$C_{OUT_RIPPLE} > \frac{I_{RIPPLE}}{8 \times V_{RIPPLE} \times f_{SW}} = \frac{5.208 \text{ A}}{8 \times 10 \text{ mV} \times 600 \text{ kHz}} = 108.5 \mu\text{F} \quad (18)$$

方程式 19 和 方程式 20 calculate the minimum capacitance to meet the transient response requirement of 50mV with a 10-A step. These equations calculate the necessary output capacitance to hold the output voltage steady while the inductor current ramps up or ramps down after a load step.

$$C_{OUT_UNDERSHOOT} > \frac{L \times I_{STEP}^2 \times \left(\frac{V_{OUT}}{V_{IN}(\text{min}) \times f_{SW}} + t_{OFF_MIN}(\text{max}) \right)}{2 \times V_{TRANS} \times V_{OUT} \times \left(\frac{V_{IN}(\text{min}) - V_{OUT}}{V_{IN}(\text{min}) \times f_{SW}} - t_{OFF_MIN}(\text{max}) \right)}$$

$$C_{OUT_UNDERSHOOT} > \frac{0.3 \mu\text{H} \times 10 \text{ A}^2 \times \left(\frac{1.0 \text{ V}}{8 \text{ V} \times 600 \text{ kHz}} + 220 \text{ ns} \right)}{2 \times 50 \text{ mV} \times 1.0 \text{ V} \times \left(\frac{8 \text{ V} - 1.0 \text{ V}}{8 \text{ V} \times 600 \text{ kHz}} - 220 \text{ ns} \right)} = 104 \mu\text{F} \quad (19)$$

$$C_{OUT_OVERSHOOT} > \frac{L \times I_{STEP}^2}{2 \times V_{TRANS} \times V_{OUT}} = \frac{0.3 \mu\text{H} \times 10 \text{ A}^2}{2 \times 50 \text{ mV} \times 1.0 \text{ V}} = 300 \mu\text{F} \quad (20)$$

The output capacitance needed to meet the overshoot requirement is the highest value so this sets the required minimum output capacitance for this example. Stability requirements can also limit the maximum output capacitance and 方程式 21 calculates the recommended maximum output capacitance. This calculation keeps the LC double pole above 1/100th the f_{SW} . It is possible to use more output capacitance but the stability must be checked through a bode plot or transient response measurement. The selected output capacitance is $4 \times 100\text{-}\mu\text{F}$ 10-V ceramic capacitors. When using ceramic capacitors, the capacitance must be derated due to DC and AC bias effects. The selected capacitors derate to 85% their nominal value giving an effective total capacitance of 340 μF . This effective capacitance meets the minimum and maximum requirements.

$$C_{OUT_STABILITY} < \left(\frac{50}{\pi \times f_{SW}} \right)^2 \times \frac{1}{L} = \left(\frac{50}{\pi \times 600 \text{ kHz}} \right)^2 \times \frac{1}{0.3 \mu\text{H}} = 2334.8 \mu\text{F} \quad (21)$$

This application uses all ceramic capacitors so the effects of ESR on the ripple and transient were ignored. If using non-ceramic capacitors, as a starting point, the ESR should be below the values calculated in 方程式 22 to

meet the ripple requirement and [方程式 23](#) to meet the transient requirement. For more accurate calculations or if using mixed output capacitors, the impedance of the output capacitors should be used to determine if the ripple and transient requirements can be met.

$$R_{ESR_RIPPLE} < \frac{V_{RIPPLE}}{I_{RIPPLE}} = \frac{10 \text{ mV}}{5.208 \text{ A}} = 1.92 \text{ m}\Omega \quad (22)$$

$$R_{ESR_TRANS} < \frac{V_{TRANS}}{I_{STEP}} = \frac{50 \text{ mV}}{10 \text{ A}} = 5 \text{ m}\Omega \quad (23)$$

8.2.2.6 Choose the Input Capacitors (C_{IN})

The device requires input bypass capacitors between the VIN and PGND pins to bypass the power-stage. The bypass capacitors must be placed as close as possible to the pins of the IC as the layout will allow. At least 10 μF of ceramic capacitance and 1- μF high frequency ceramic bypass capacitors are required. A 1- μF , 16-V X6S size 0402 ceramic capacitor on VIN pins is required. A 1- μF 16-V X6S ceramic capacitor on the bottom layer is recommended for high current applications. The high frequency bypass capacitor minimizes high frequency voltage overshoot across the power-stage. The ceramic capacitors must be a high-quality dielectric of X6S or better for their high capacitance-to-volume ratio and stable characteristics across temperature. In addition to this, more bulk capacitance can be needed on the input depending on the application to minimize variations on the input voltage during transient conditions.

The input capacitance required to meet a specific input ripple target can be calculated with [方程式 24](#). A recommended target input voltage ripple is 5% the minimum input voltage, which is 400 mV in this example. The calculated input capacitance needed is 9.11 μF and four 22- μF ceramic capacitors are recommended for this example.

$$C_{IN} > \frac{V_{OUT} \times I_{OUT} \times \left(1 - \frac{V_{OUT}}{V_{IN}(\text{min})}\right)}{f_{SW} \times V_{IN}(\text{min}) \times V_{IN_RIPPLE}} = \frac{1.0 \text{ V} \times 20 \text{ A} \times \left(1 - \frac{1.0\text{V}}{8}\right)}{600 \text{ kHz} \times 8 \text{ V} \times 400 \text{ mV}} = 9.11 \mu\text{F} \quad (24)$$

The capacitor must also have an RMS current rating greater than the maximum input RMS current in the application. The input RMS current the input capacitors must support is calculated by [方程式 25](#) and is 6.636 A in this example. The ceramic input capacitors have a current rating greater than this.

$$I_{CIN(RMS)} = \sqrt{\frac{V_{OUT}}{V_{IN}(\text{min})} \times \left(\frac{(V_{IN}(\text{min}) - V_{OUT})}{V_{IN}(\text{min})} \times I_{OUT}^2 + \frac{I_{ripple}^2}{12} \right)}$$

$$I_{CIN(RMS)} = \sqrt{\frac{1.0 \text{ V}}{8 \text{ V}} \times \left(\frac{(8 \text{ V} - 1.0 \text{ V})}{8 \text{ V}} \times 20^2 + \frac{5.208^2}{12} \right)} = 6.636 \text{ A} \quad (25)$$

For applications requiring bulk capacitance on the input, such as ones with low input voltage and high current, the selection process in this [article](#) is recommended.

8.2.2.7 Soft-Start Capacitor (SS/REFIN Pin)

The capacitor placed on the SS/REFIN pin can be used to extend the soft-start time past the internal 1.5-ms soft start. This example uses a 3.7-ms soft-start time and the required external capacitance can be calculated with [方程式 26](#). In this example, a 220-nF capacitor is used.

$$C_{SS} = \frac{I_{SS} \times t_{SS}}{V_{REF}} = \frac{36 \mu\text{A} \times 3.7 \text{ ms}}{0.6 \text{ V}} = 200 \text{ nF} \quad (26)$$

A minimum capacitor value of 1 nF is required at the SS/REFIN pin. The SS/REFIN capacitor must use the VSNS - pin for its ground.

8.2.2.8 EN Pin Resistor Divider

A resistor divider on the EN pin can be used to increase the input voltage and begin the start-up sequence of the converter. To set the start voltage, first select the bottom resistor (R_{EN_B}). The recommended value is between 1 k Ω and 100 k Ω . There is an internal pulldown resistance with a nominal value of 6 M Ω . This must be included for the most accurate calculations. This is especially important when the bottom resistor is a higher value, near 100 k Ω . This example uses a 10-k Ω resistor and this combined with the internal resistance in parallel results in an equivalent bottom resistance of 9.98 k Ω . The top resistor value for the target start voltage is calculated with [方程式 27](#). In this example, the nearest standard value of 20 k Ω is selected for R_{EN_T} . When selecting a start voltage in a wide input range application, be cautious that the EN pin absolute maximum voltage of 6 V is not exceeded.

$$R_{EN_T} = \frac{R_{EN_B} \times V_{START}}{V_{ENH}} - R_{EN_B} = \frac{10 \text{ k}\Omega \times 3.7 \text{ V}}{1.22 \text{ V}} - 10 \text{ k}\Omega = 20 \text{ k}\Omega \quad (27)$$

The start and stop voltages with the selected EN resistor divider can be calculated with [方程式 28](#) and [方程式 29](#).

$$V_{START} = V_{ENH} \times \frac{R_{EN_B} + R_{EN_T}}{R_{EN_B}} = 1.22 \text{ V} \times \frac{10 \text{ k}\Omega + 20 \text{ k}\Omega}{10 \text{ k}\Omega} = 3.66 \text{ V} \quad (28)$$

$$V_{STOP} = V_{ENL} \times \frac{R_{EN_B} + R_{EN_T}}{R_{EN_B}} = 1.02 \text{ V} \times \frac{10 \text{ k}\Omega + 20 \text{ k}\Omega}{10 \text{ k}\Omega} = 3.06 \text{ V} \quad (29)$$

8.2.2.9 VCC Bypass Capacitor

At a minimum, a 2.2- μ F, at least 6.3-V rating, X5R ceramic bypass capacitor is needed on the VCC pin located as close to the pin as the layout will allow.

8.2.2.10 BOOT Capacitor

At a minimum, a 0.1- μ F 10-V X5R ceramic bypass capacitor is needed between the BOOT and SW pins located as close to the pin as the layout will allow. It is good practice to use a 0- Ω resistor in series with BOOT capacitor.

8.2.2.11 PGOOD Pullup Resistor

The PGOOD pin is open-drain, so a pullup resistor is required when using this pin. The recommended value is between 1 k Ω and 100 k Ω .

8.2.3 Application Curves



图 8-2. Efficiency vs Output Current, Internal VCC Bias, FCCM



图 8-3. Efficiency vs Output Current, Internal VCC Bias, Skip

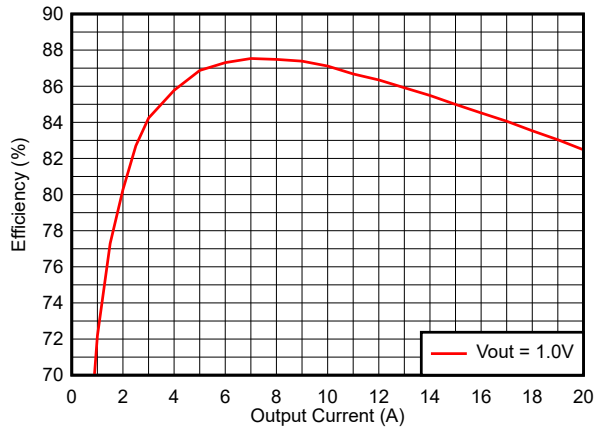

图 8-4. Efficiency vs Output Current, VCC = 3.3-V External Bias, FCCM

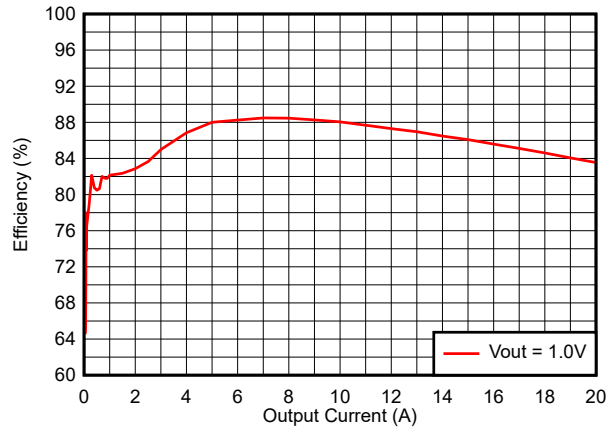

图 8-5. Switching Frequency vs Output Current

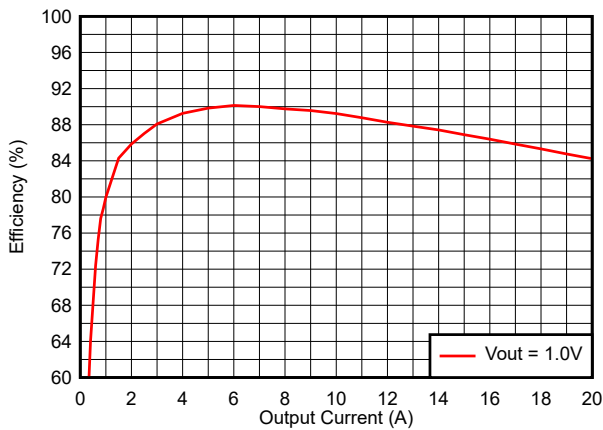

图 8-6. Switching Frequency vs Input Voltage

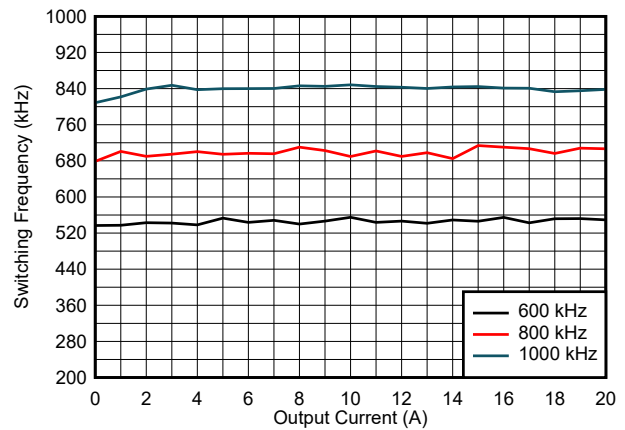

图 8-7. Output Voltage vs Output Current, Internal VCC Bias, Skip

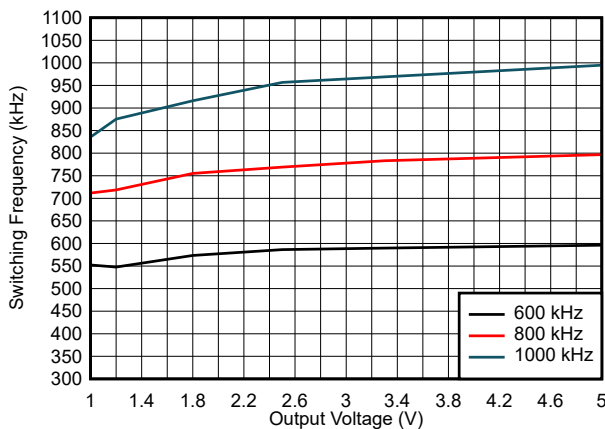

图 8-8. Output Voltage vs Output Current, Internal VCC Bias, FCCM

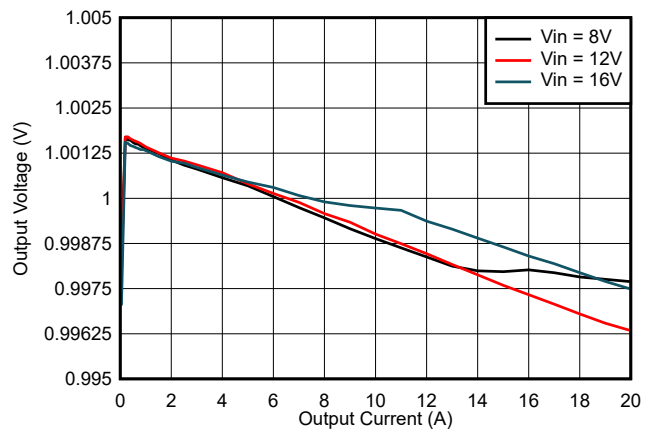

图 8-9. Output Voltage vs Output Current, VCC = 3.3-V External Bias, Skip

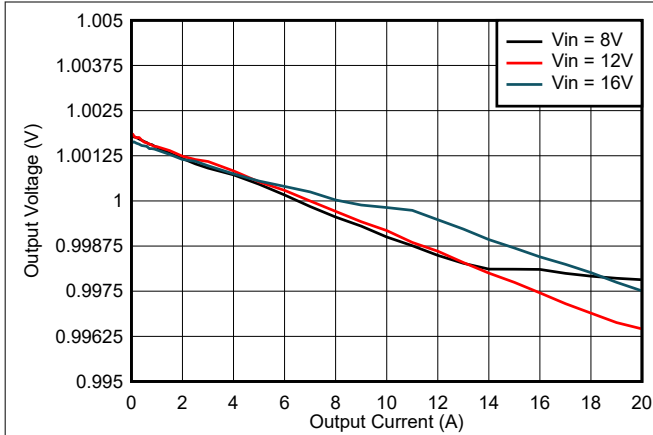

图 8-10. Output Voltage vs Output Current, VCC = 3.3-V External Bias, FCCM

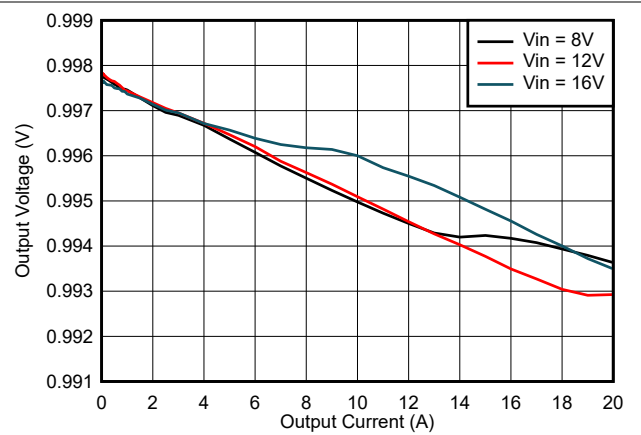

图 8-11. Output Voltage vs Input Voltage, Internal VCC Bias

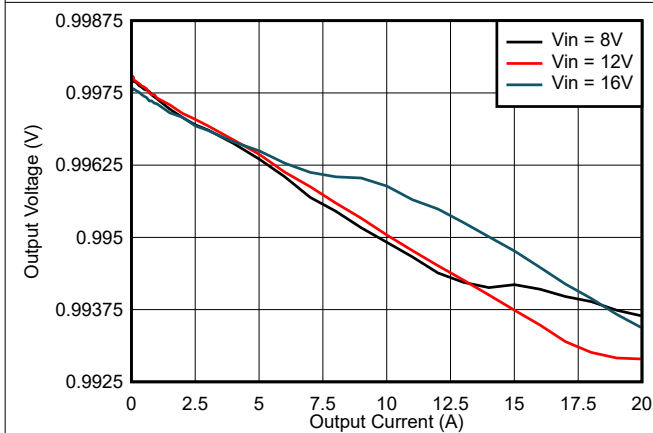

图 8-12. Output Voltage vs Input Voltage, VCC = 3.3-V External Bias

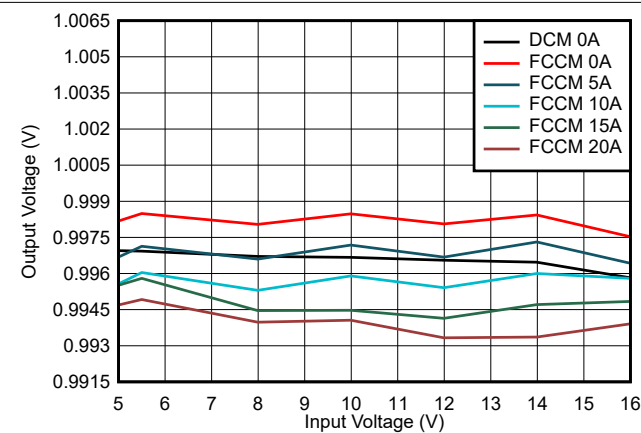

图 8-13. ICC Current vs External VCC Voltage

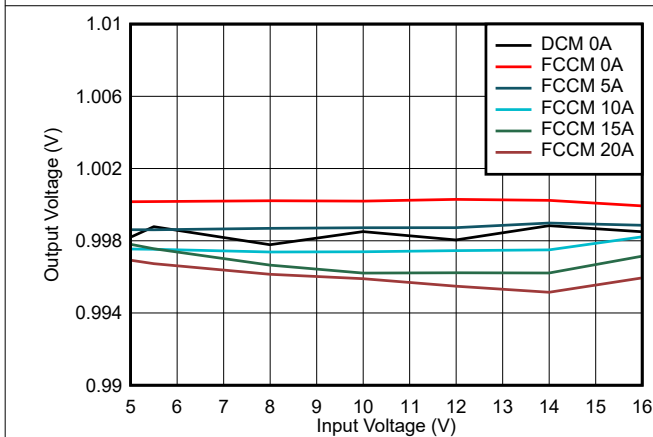

图 8-14. Enable Start-Up, Prebias

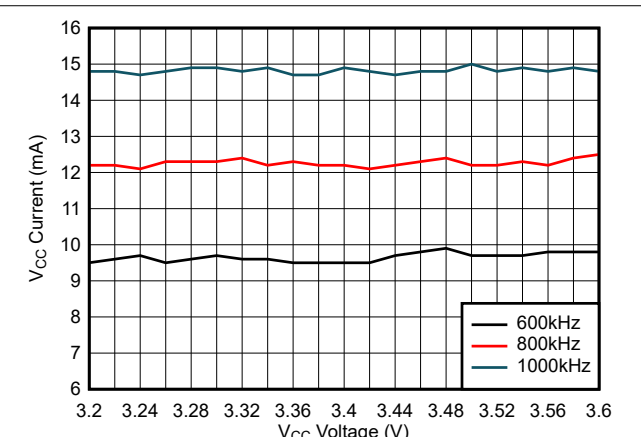

图 8-15. Prebias Power Down

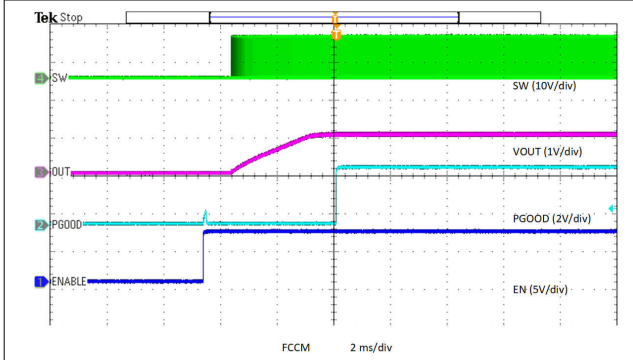

图 8-16. Enable Power Up, Skip

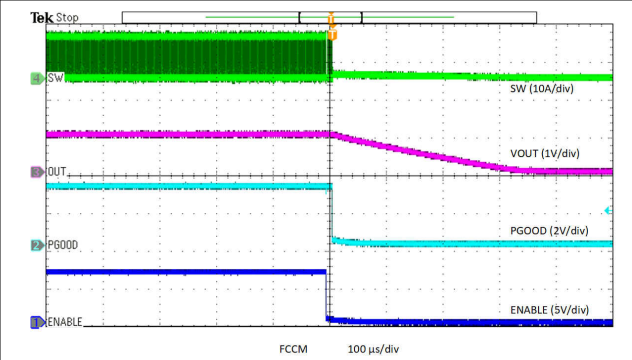

图 8-17. Enable Power Down, Skip

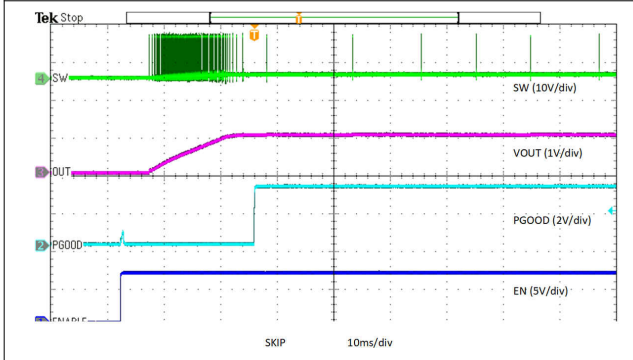

图 8-18. Enable Power Up into Pre-bias, Skip

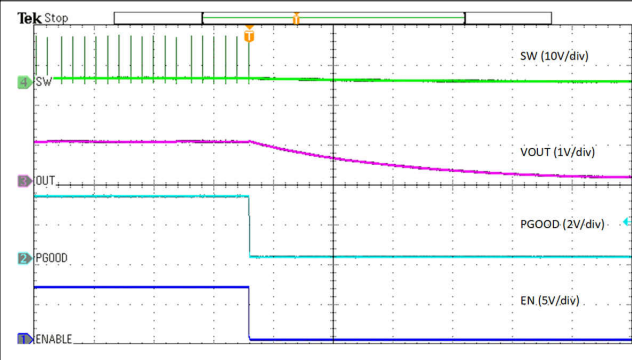

图 8-19. Enable Power Down with Pre-bias, Skip

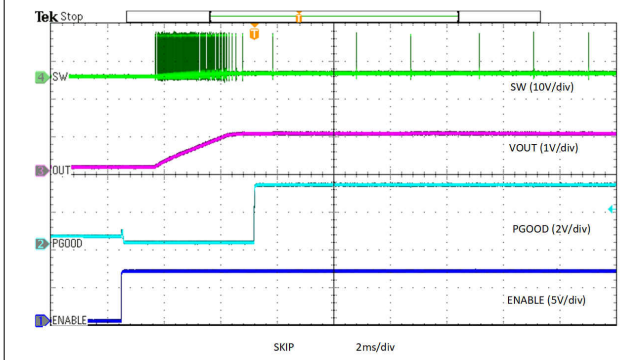

图 8-20. Unload Transient

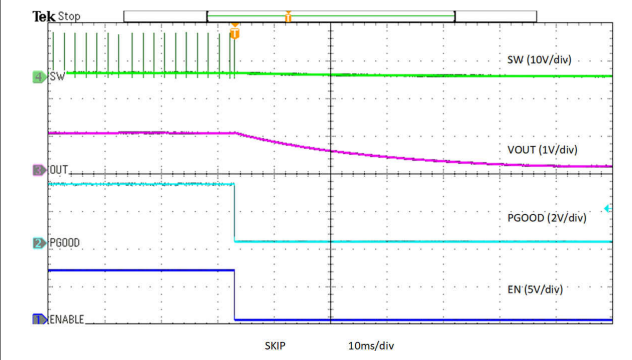

图 8-21. Output Voltage Ripple, FCCM, 0-A Load

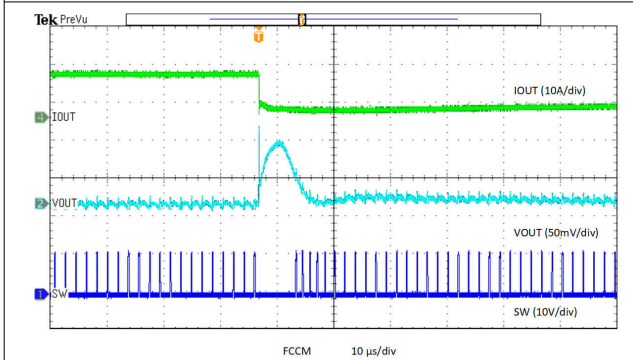

图 8-22. Output Voltage Ripple, FCCM, 0.5-A Load

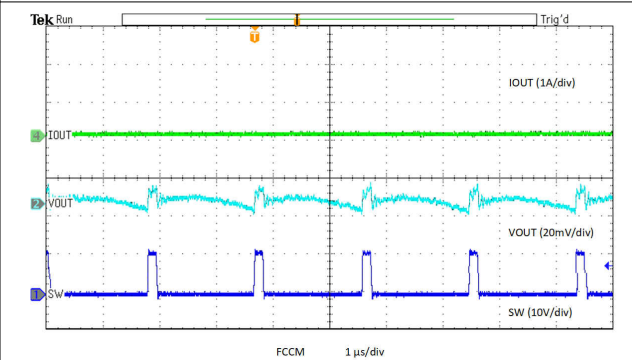

图 8-23. Output Voltage Ripple, FCCM, 20-A Load

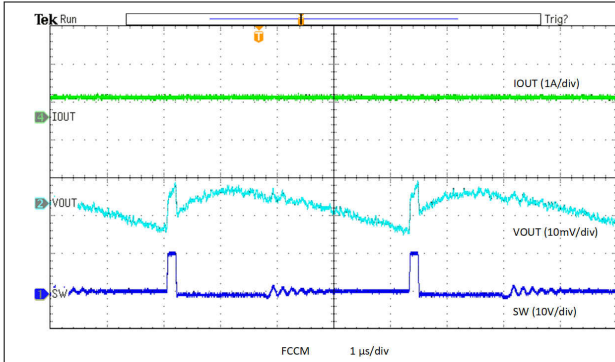

图 8-24. Output Voltage Ripple, Skip, 0.01-A Load



图 8-25. Output Voltage Ripple, Skip, 1-A Load

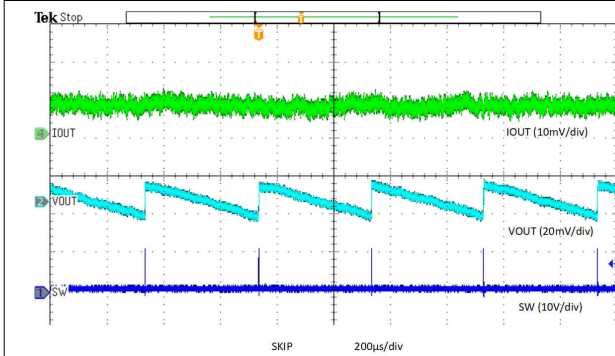

图 8-26. Overtemperature Protection in FCCM

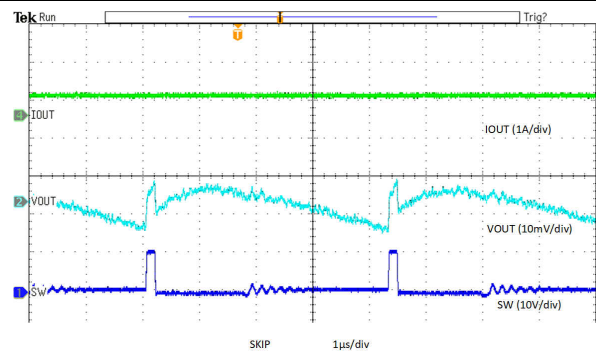

图 8-27. Exiting Overtemperature Protection in FCCM

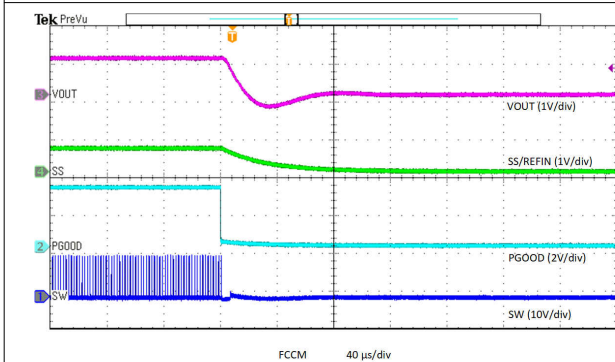

图 8-28. Enabled into Overcurrent

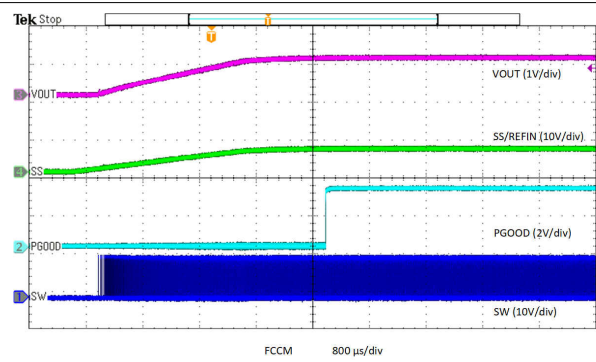

图 8-29. Hiccup Overcurrent

9 Power Supply Recommendations

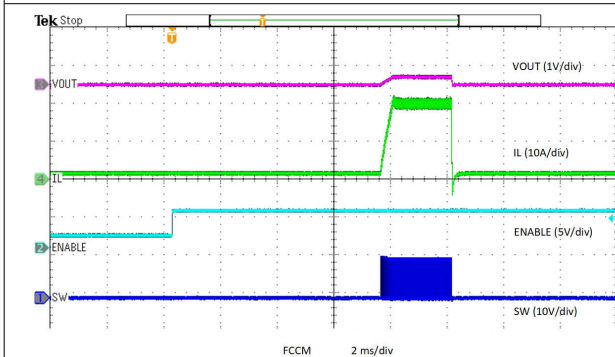
The device is designed to operate from a wide input voltage supply range between 2.7 V and 16 V when the VCC pin is powered by external bias ranging from 3.13 V to 3.6 V. Both input supplies (VIN and VCC bias) must be well regulated. Proper bypassing of input supplies (VIN and VCC bias) is also critical for noise performance, as are PCB layout and grounding scheme. See the recommendations in [节 10](#).

10 布局

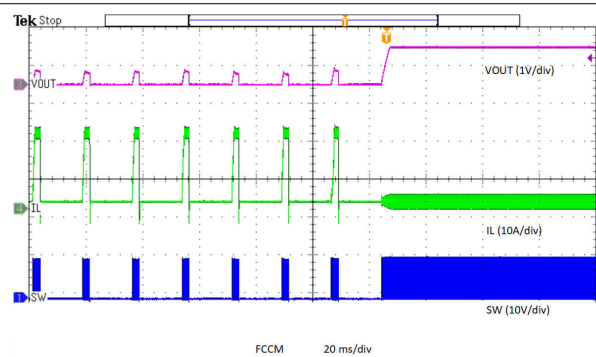
10.1 Layout Guidelines

Before beginning a design using the device, consider the following:

- Place the power components (including input and output capacitors, the inductor, and the IC) on the top side of the PCB. In order to shield and isolate the small signal traces from noisy power lines, insert at least one solid ground inner plane.
- VIN decoupling capacitors are important for FET robustness. A 1- μ F/25-V/X6S/0402 ceramic capacitor on VIN pin 18 is required. The PGND vias for this decoupling capacitor should be placed so that the decoupling capacitor is closer to IC than the PGND vias. To lower ESL from via connection, two 8-mil vias are recommended for the PGND connection to inner PGND plane.
- A 1- μ F/25-V/X6S/0402 ceramic capacitor on VIN pin 9 is highly recommended. If this 0402 size capacitor is not used, the bigger size VIN decoupling capacitors (0603 or 0805 size) are required to be placed as close as possible to IC pin 9 and pin 10.
- Two 1- μ F/25-V/X6S/0402 ceramic capacitors on bottom layer are recommended for high current applications ($I_{OUT} > 13$ A). One of these two capacitors should be centered between VINs. To have good connection for this capacitor, a V_{IN} copper on bottom layer and two V_{IN} vias are needed. The other one can be placed close to IC package just like a mirrored copy to the 0402 capacitor on top layer.
- At least six PGND vias are required to be placed as close as possible to the PGND pins. This minimizes parasitic impedance and also lowers thermal resistance.
- Place the VCC decoupling capacitor (2.2- μ F/6.3-V/X6S/0402 or 2.2- μ F/6.3-V/X7R/0603) as close as possible to the device. Ensure the VCC decoupling loop is smallest.
- Place BOOT capacitor as close as possible to the BOOT and SW pins. Use traces with a width of 12 mil or wider to route the connection. TI recommends using a 0.1- μ F to 1- μ F bootstrap capacitor with a 10-V rating.
- The PCB trace, which connects the SW pin and high-voltage side of the inductor, is defined as switch node. The switch node must be as short and wide as possible.
- Always place the feedback resistors near the device to minimize the FB trace distance, no matter single-end sensing or remote sensing.
 - For remote sensing, the connections from the FB voltage divider resistors to the remote location should be a pair of PCB traces with at least 12-mil trace width, and should implement Kelvin sensing across a high bypass capacitor of 0.1 μ F or higher. The ground connection of the remote sensing signal must be connected to VSNS $^-$ pin. The V_{OUT} connection of the remote sensing signal must be connected to the feedback resistor divider with the lower feedback resistor terminated at VSNS $^-$ pin. To maintain stable output voltage and minimize the ripple, the pair of remote sensing lines should stay away from any noise sources such as inductor and SW nodes, or high frequency clock lines. It is recommended to shield the pair of remote sensing lines with ground planes above and below.
 - For single-end sensing, connect the higher FB resistor to a high-frequency local bypass capacitor of 0.1 μ F or higher, and short VSNS $^-$ to AGND with shortest trace.
- This device does not require a capacitor from the SS/REFIN pin to AGND, thus it is not recommended to place a capacitor from SS/REFIN pin to AGND. If both $C_{SS/REFIN-to-VSNS^-}$ and $C_{SS/REFIN-to-AGND}$ capacitors exist, place $C_{SS/REFIN-to-VSNS^-}$ more closely with shortest trace to the VSNS $^-$ pin.
- Pin 1 (AGND pin) must be connected to a solid PGND plane on inner layer. Use the common AGND via to connect the resistors to the inner ground plane if applicable.
- See [节 10.2](#) for the layout recommendation.

10.2 Layout Example



图 10-1. Layout Recommendation

11 Device and Documentation Support

11.1 Device Support

11.1.1 第三方产品免责声明

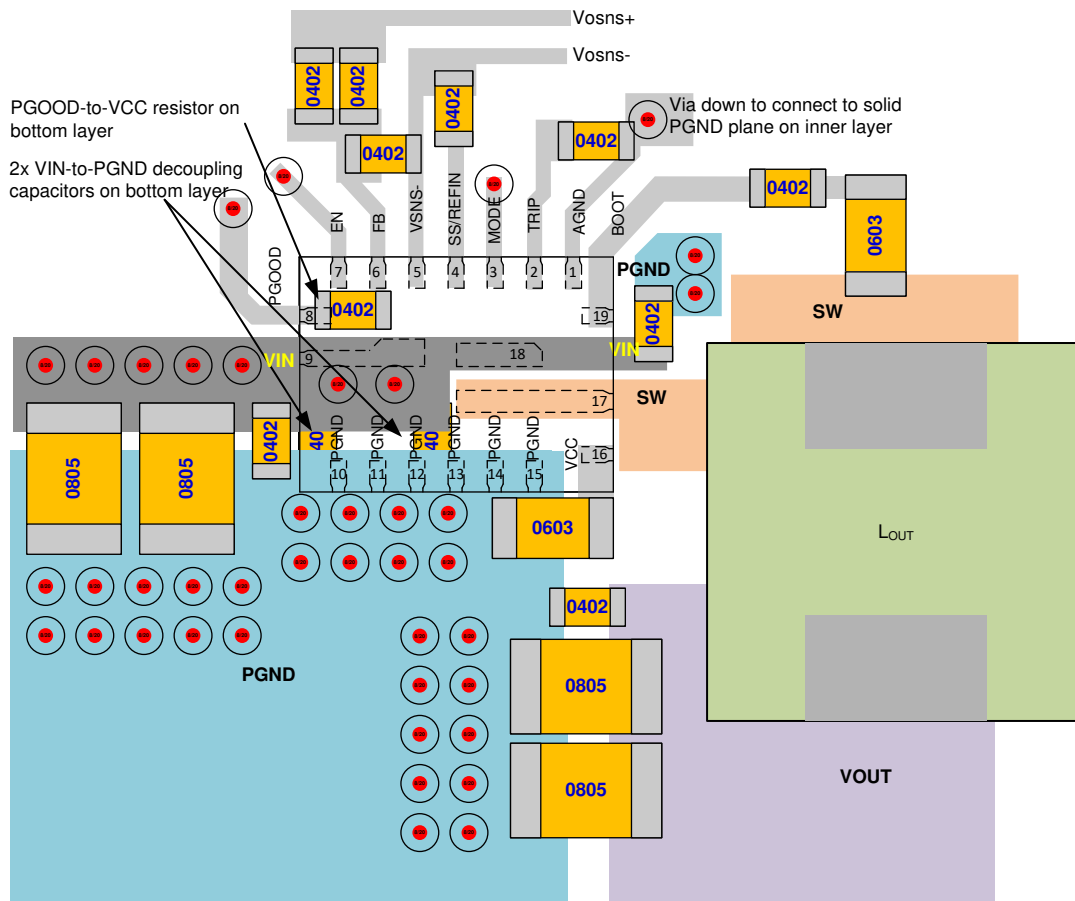
TI 发布的与第三方产品或服务有关的信息，不能构成与此类产品或服务或保修的适用性有关的认可，不能构成此类产品或服务单独或与任何 TI 产品或服务一起的表示或认可。

11.2 Documentation Support

11.2.1 Related Documentation

- [Optimizing Transient Response of Internally Compensated DC-DC Converters with Feedforward Capacitor](#)
- [Non-isolated Point-of-load Solutions for VR13.HC in Rack Server and Datacenter Applications](#)

11.3 支持资源

TI E2E™ 支持论坛是工程师的重要参考资料，可直接从专家获得快速、经过验证的解答和设计帮助。搜索现有解答或提出自己的问题可获得所需的快速设计帮助。

链接的内容由各个贡献者“按原样”提供。这些内容并不构成 TI 技术规范，并且不一定反映 TI 的观点；请参阅 TI 的《使用条款》。

11.4 接收文档更新通知

要接收文档更新通知，请导航至 ti.com 上的器件产品文件夹。点击 [订阅更新](#) 进行注册，即可每周接收产品信息更改摘要。有关更改的详细信息，请查看任何已修订文档中包含的修订历史记录。

11.5 Trademarks

D-CAP3™ and TI E2E™ are trademarks of Texas Instruments.

所有商标均为其各自所有者的财产。

11.6 Electrostatic Discharge Caution



This integrated circuit can be damaged by ESD. Texas Instruments recommends that all integrated circuits be handled with appropriate precautions. Failure to observe proper handling and installation procedures can cause damage.

ESD damage can range from subtle performance degradation to complete device failure. Precision integrated circuits may be more susceptible to damage because very small parametric changes could cause the device not to meet its published specifications.

11.7 术语表

TI 术语表

本术语表列出并解释了术语、首字母缩略词和定义。

12 Mechanical, Packaging, and Orderable Information

The following pages include mechanical, packaging, and orderable information. This information is the most current data available for the designated devices. This data is subject to change without notice and revision of this document. For browser-based versions of this data sheet, refer to the left-hand navigation.

重要声明和免责声明

TI 提供技术和可靠性数据 (包括数据表)、设计资源 (包括参考设计)、应用或其他设计建议、网络工具、安全信息和其他资源, 不保证没有瑕疵且不做任何明示或暗示的担保, 包括但不限于对适销性、某特定用途方面的适用性或不侵犯任何第三方知识产权的暗示担保。

这些资源可供使用 TI 产品进行设计的熟练开发人员使用。您将自行承担以下全部责任: (1) 针对您的应用选择合适的 TI 产品, (2) 设计、验证并测试您的应用, (3) 确保您的应用满足相应标准以及任何其他安全、安保或其他要求。这些资源如有变更, 恕不另行通知。TI 授权您仅可将这些资源用于研发本资源所述的 TI 产品的应用。严禁对这些资源进行其他复制或展示。您无权使用任何其他 TI 知识产权或任何第三方知识产权。您应全额赔偿因在这些资源的使用中对 TI 及其代表造成的任何索赔、损害、成本、损失和债务, TI 对此概不负责。

TI 提供的产品受 TI 的销售条款 (<https://www.ti.com/legal/termsofsale.html>) 或 [ti.com](https://www.ti.com) 上其他适用条款/TI 产品随附的其他适用条款的约束。TI 提供这些资源并不会扩展或以其他方式更改 TI 针对 TI 产品发布的适用的担保或担保免责声明。

邮寄地址: Texas Instruments, Post Office Box 655303, Dallas, Texas 75265
Copyright © 2021, 德州仪器 (TI) 公司

PACKAGING INFORMATION

Orderable Device	Status (1)	Package Type	Package Drawing	Pins	Package Qty	Eco Plan (2)	Lead finish/ Ball material (6)	MSL Peak Temp (3)	Op Temp (°C)	Device Marking (4/5)	Samples
TPS548B27RYLR	ACTIVE	VQFN-FCRLF	RYL	19	3000	RoHS & Green	NIPDAU	Level-2-260C-1 YEAR	-40 to 125	T548B27	Samples

(1) The marketing status values are defined as follows:

ACTIVE: Product device recommended for new designs.

LIFEBUY: TI has announced that the device will be discontinued, and a lifetime-buy period is in effect.

NRND: Not recommended for new designs. Device is in production to support existing customers, but TI does not recommend using this part in a new design.

PREVIEW: Device has been announced but is not in production. Samples may or may not be available.

OBSELETE: TI has discontinued the production of the device.

(2) **RoHS:** TI defines "RoHS" to mean semiconductor products that are compliant with the current EU RoHS requirements for all 10 RoHS substances, including the requirement that RoHS substance do not exceed 0.1% by weight in homogeneous materials. Where designed to be soldered at high temperatures, "RoHS" products are suitable for use in specified lead-free processes. TI may reference these types of products as "Pb-Free".

RoHS Exempt: TI defines "RoHS Exempt" to mean products that contain lead but are compliant with EU RoHS pursuant to a specific EU RoHS exemption.

Green: TI defines "Green" to mean the content of Chlorine (Cl) and Bromine (Br) based flame retardants meet JS709B low halogen requirements of <=1000ppm threshold. Antimony trioxide based flame retardants must also meet the <=1000ppm threshold requirement.

(3) MSL, Peak Temp. - The Moisture Sensitivity Level rating according to the JEDEC industry standard classifications, and peak solder temperature.

(4) There may be additional marking, which relates to the logo, the lot trace code information, or the environmental category on the device.

(5) Multiple Device Markings will be inside parentheses. Only one Device Marking contained in parentheses and separated by a "-" will appear on a device. If a line is indented then it is a continuation of the previous line and the two combined represent the entire Device Marking for that device.

(6) Lead finish/Ball material - Orderable Devices may have multiple material finish options. Finish options are separated by a vertical ruled line. Lead finish/Ball material values may wrap to two lines if the finish value exceeds the maximum column width.

Important Information and Disclaimer:The information provided on this page represents TI's knowledge and belief as of the date that it is provided. TI bases its knowledge and belief on information provided by third parties, and makes no representation or warranty as to the accuracy of such information. Efforts are underway to better integrate information from third parties. TI has taken and continues to take reasonable steps to provide representative and accurate information but may not have conducted destructive testing or chemical analysis on incoming materials and chemicals. TI and TI suppliers consider certain information to be proprietary, and thus CAS numbers and other limited information may not be available for release.

In no event shall TI's liability arising out of such information exceed the total purchase price of the TI part(s) at issue in this document sold by TI to Customer on an annual basis.

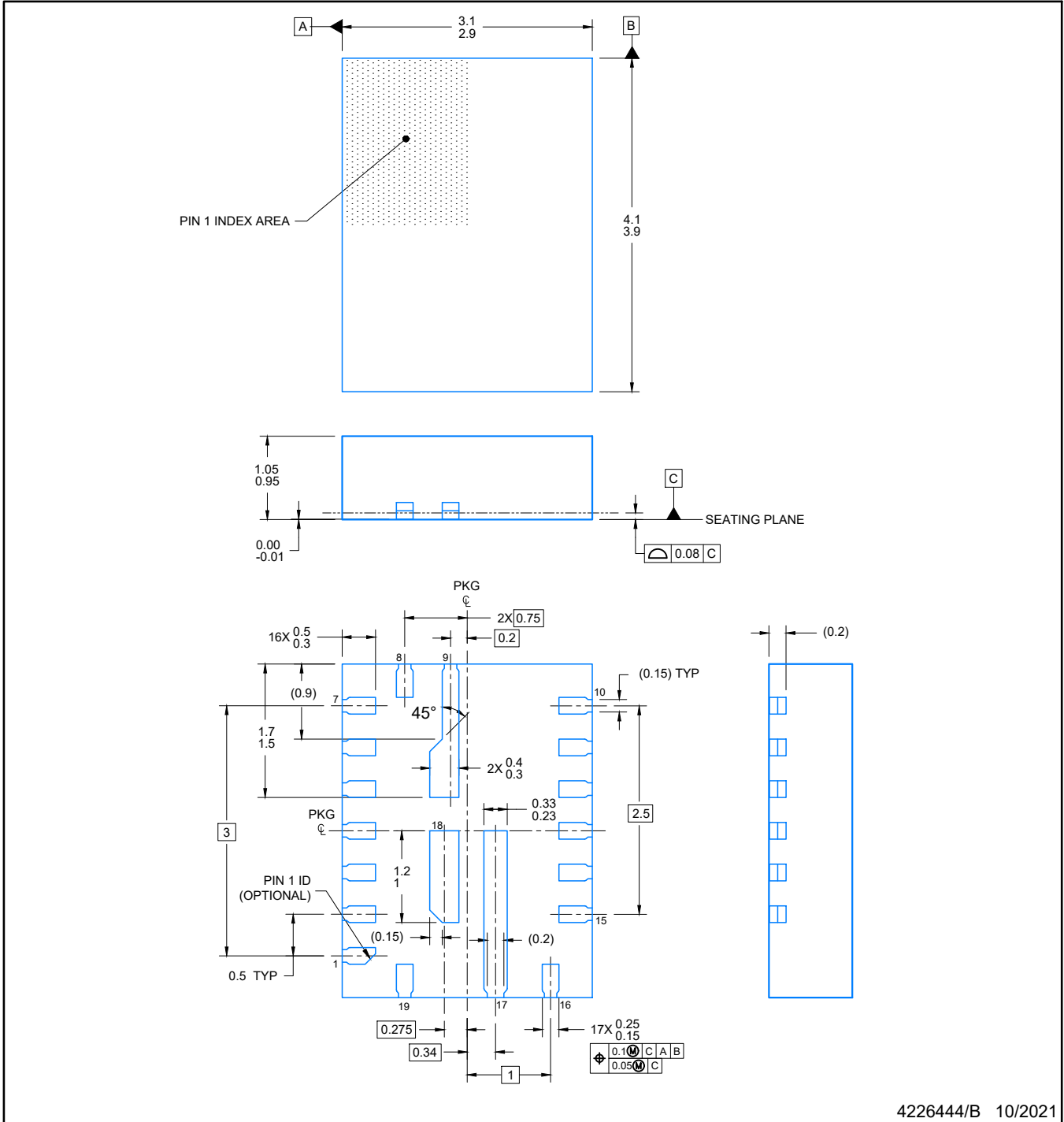

4226444/B 10/2021

NOTES:

1. All linear dimensions are in millimeters. Any dimensions in parenthesis are for reference only. Dimensioning and tolerancing per ASME Y14.5M.
2. This drawing is subject to change without notice.
3. The package thermal pad must be soldered to the printed circuit board for optimal thermal and mechanical performance.

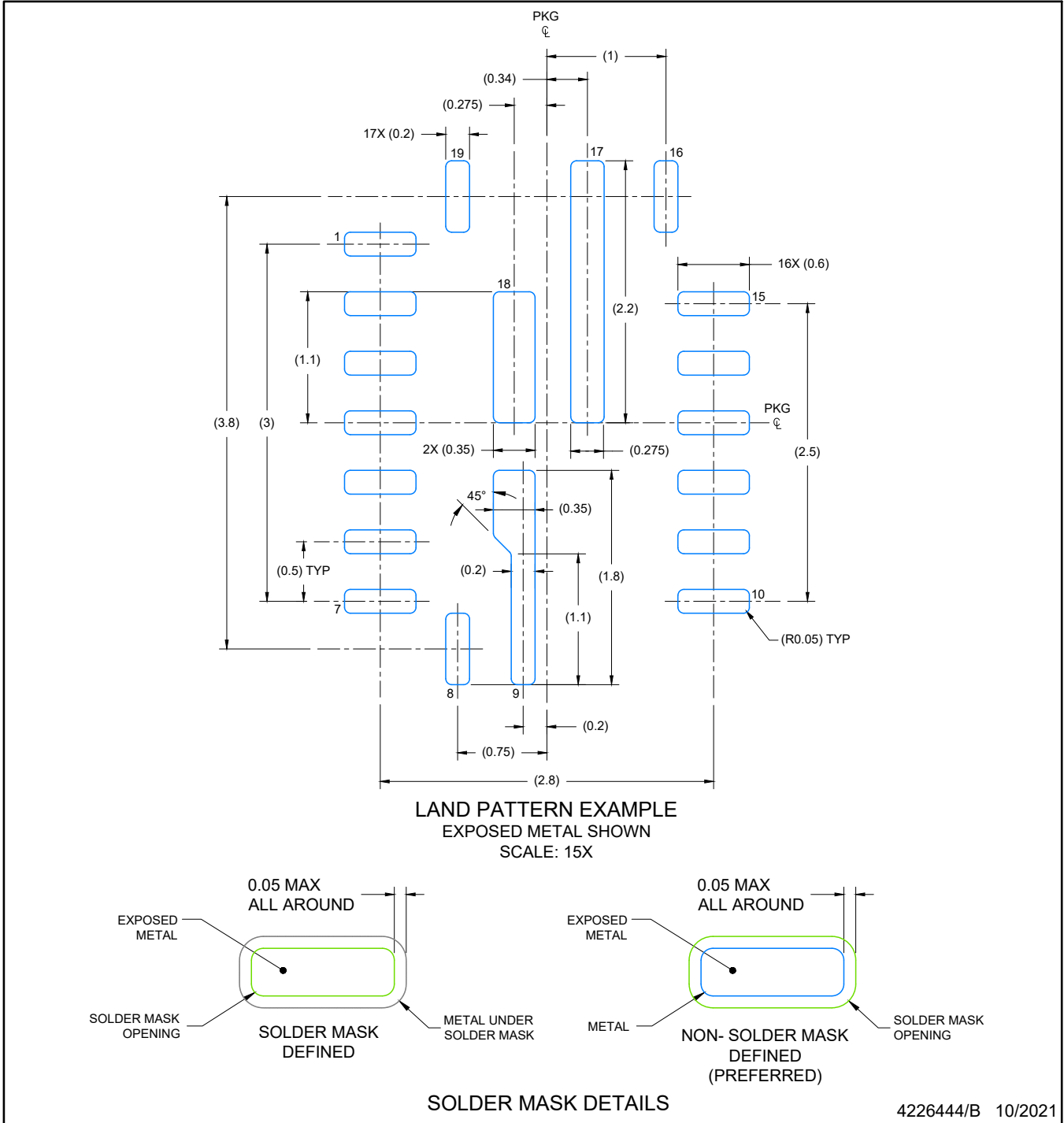

NOTES: (continued)

4. This package is designed to be soldered to a thermal pad on the board. For more information, see Texas Instruments literature number SLUA271 (www.ti.com/lit/slua271).
5. Vias are optional depending on application, refer to device data sheet. If any vias are implemented, refer to their locations shown on this view. It is recommended that vias under paste be filled, plugged or tented.

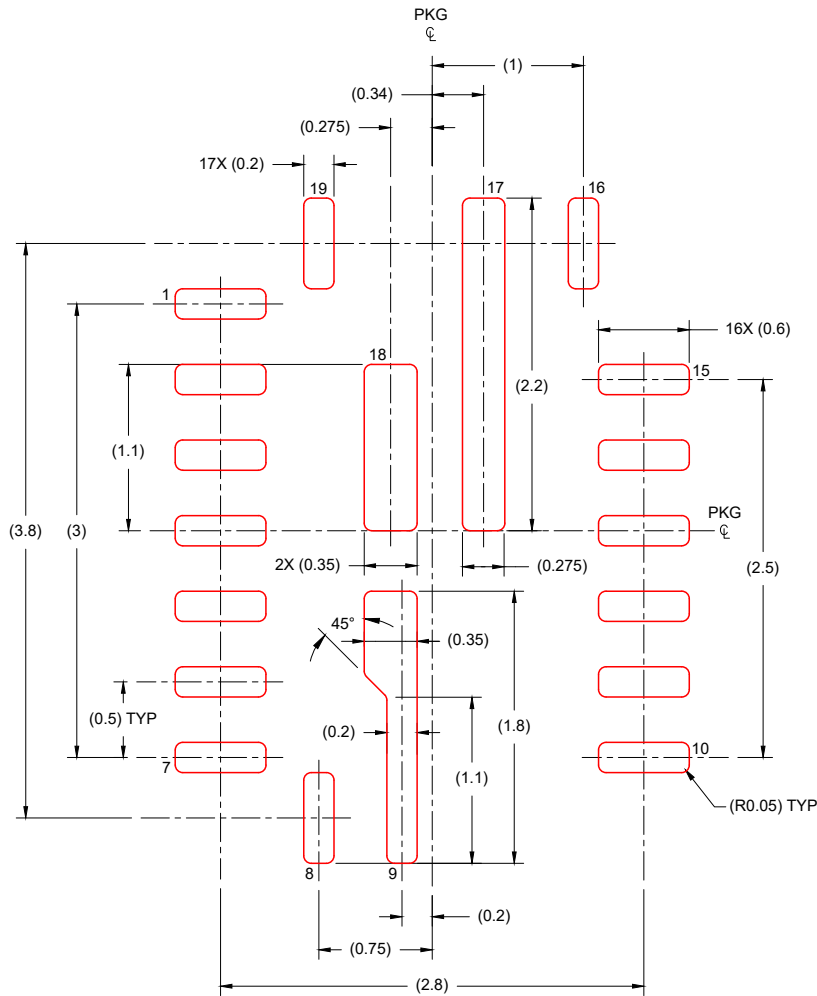

SOLDER PASTE EXAMPLE
 BASED ON 0.125 mm THICK STENCIL
 SCALE : 18X

4226444/B 10/2021

NOTES: (continued)

- 6. Laser cutting apertures with trapezoidal walls and rounded corners may offer better paste release. IPC-7525 may have alternate design recommendations.

重要声明和免责声明

TI“按原样”提供技术和可靠性数据（包括数据表）、设计资源（包括参考设计）、应用或其他设计建议、网络工具、安全信息和其他资源，不保证没有瑕疵且不做任何明示或暗示的担保，包括但不限于对适销性、某特定用途方面的适用性或不侵犯任何第三方知识产权的暗示担保。

这些资源可供使用 TI 产品进行设计的熟练开发人员使用。您将自行承担以下全部责任：(1) 针对您的应用选择合适的 TI 产品，(2) 设计、验证并测试您的应用，(3) 确保您的应用满足相应标准以及任何其他功能安全、信息安全、监管或其他要求。

这些资源如有变更，恕不另行通知。TI 授权您仅可将这些资源用于研发本资源所述的 TI 产品的应用。严禁对这些资源进行其他复制或展示。您无权使用任何其他 TI 知识产权或任何第三方知识产权。您应全额赔偿因在这些资源的使用中对 TI 及其代表造成的任何索赔、损害、成本、损失和债务，TI 对此概不负责。

TI 提供的产品受 [TI 的销售条款](#) 或 [ti.com](#) 上其他适用条款/TI 产品随附的其他适用条款的约束。TI 提供这些资源并不会扩展或以其他方式更改 TI 针对 TI 产品发布的适用的担保或担保免责声明。

TI 反对并拒绝您可能提出的任何其他或不同的条款。

邮寄地址：Texas Instruments, Post Office Box 655303, Dallas, Texas 75265

Copyright © 2024，德州仪器 (TI) 公司