

# TPS715-Q1 采用 SC70 封装的 50mA、24V、3.2 $\mu$ A 静态电流 低压降线性稳压器

## 1 特性

- 符合面向汽车应用的 AEC-Q100 标准：
  - 温度等级 1：-40°C 至 +125°C，T<sub>A</sub>
  - 器件 HBM ESD 分类等级 H2
  - 旧芯片的器件 CDM ESD 分类等级为 C4B，新芯片为 C5
- 输入电压范围：2.5 V 至 24 V
- 可配置的输出电压选项：
  - 固定：1.8V 至 5V
  - 可调节：1.2 V 至 15 V
- 输出电流：高达 50 mA
- 超低 I<sub>Q</sub>：50mA 负载电流下为 3.2  $\mu$ A
- 与  $\geq 0.47 \mu$ F 的输出电容器一起工作时可保持稳定
- 过流保护
- 封装：5 引脚 SC70 (DCK)

## 2 应用

- 混合动力、电动和动力总成系统
- 车身电子装置和照明
- 信息娱乐系统与仪表组
- 工厂自动化和控制

## 3 说明

TPS715-Q1 低压降 (LDO) 线性稳压器是低静态电流器件，可提供采用微型封装、具有宽输入电压范围和实现低功耗运行的优势。因此，TPS715-Q1 专为电池供电应用而设计，可用作低功耗微控制器的电源管理附件。

TPS715-Q1 有固定电压和可调节电压两种版本可供选用。为了获得更大的灵活性或更高的输出电压，可调节电压版本使用反馈电阻器将输出电压设置为 1.2V 至 15V。TPS715-Q1 LDO 在负载电流为 50mA 时支持典型值为 415mV 的低压降。低静态电流（典型值为 3.2 $\mu$ A）在整个输出负载电流（0mA 至 50mA）范围内都是稳定的。TPS715-Q1 还具有内部软启动功能，可降低浪涌电流。内置过流限制有助于在发生负载短路或故障时保护稳压器。

TPS715-Q1 采用 2.00mm  $\times$  1.25mm、5 引脚 SC-70 (DCK) 封装（对于固定和可调输出）。

### 封装信息

器件型号	封装 <sup>(1) (2)</sup>	封装尺寸 (标称值)
TPS715-Q1	DCK ( SC70, 5 )	2.00mm $\times$ 1.25mm

- 如需了解所有可用封装，请参阅数据表末尾的可订购产品附录。
- 如需介于 1.8 V 和 5.0 V 之间的其他电压选项，请联系德州仪器 (TI)。

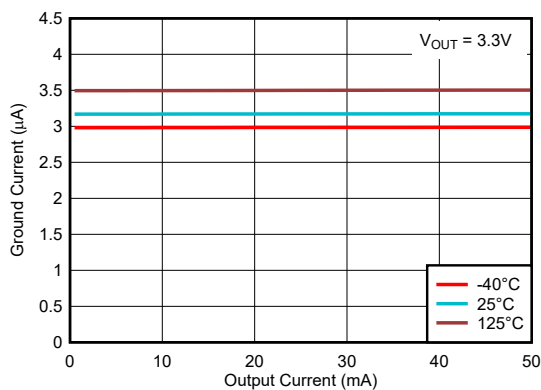

TPS715-Q1 的静态电流与负载电流之间的关系 (仅限新芯片)

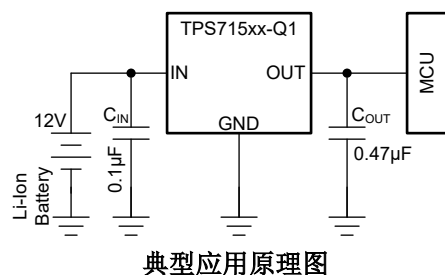

## Table of Contents

<b>1 特性</b> .....	1	7.4 Device Functional Modes.....	13
<b>2 应用</b> .....	1	<b>8 Application and Implementation</b> .....	14
<b>3 说明</b> .....	1	8.1 Application Information.....	14
<b>4 Revision History</b> .....	2	8.2 Typical Application.....	14
<b>5 Pin Configuration and Functions</b> .....	3	8.3 Power Supply Recommendations.....	20
<b>6 Specifications</b> .....	4	8.4 Layout.....	20
6.1 Absolute Maximum Ratings.....	4	<b>9 Device and Documentation Support</b> .....	21
6.2 ESD Ratings.....	4	9.1 Device Support.....	21
6.3 Recommended Operating Conditions.....	4	9.2 Documentation Support.....	21
Thermal Information.....	5	9.3 接收文档更新通知.....	21
6.4 Electrical Characteristics.....	6	9.4 支持资源.....	21
6.5 Typical Characteristics.....	7	9.5 Trademarks.....	21
<b>7 Detailed Description</b> .....	11	9.6 静电放电警告.....	22
7.1 Overview.....	11	9.7 术语表.....	22
7.2 Functional Block Diagrams.....	11	<b>10 Mechanical, Packaging, and Orderable Information</b> .....	22
7.3 Feature Description.....	11		

## 4 Revision History

注：以前版本的页码可能与当前版本的页码不同

<b>Changes from Revision H (October 2015) to Revision I (May 2023)</b>	<b>Page</b>
• 向文档添加了 M3 器件.....	1
• 更改了文档标题以及特性、应用和说明部分.....	1
• Changed <i>Pin Configuration and Functions</i> section: Added fixed and adjustable pinouts and changed <i>Description</i> column of <i>Pin Functions</i> table.....	3
• Changed <i>Typical Characteristics</i> section: Reordered curves and added M3-specific curves.....	7
• Changed <i>Overview</i> section.....	11
• Changed <i>Feature Description</i> : Added new subsections, deleted <i>Regulator Protection</i> and <i>Adjustable Output Voltage</i> sections, changed <i>Current Limit</i> section.....	11
• Changed <i>Device Functional Modes</i> section: Deleted <i>Disabled</i> row from <i>Device Functional Mode Comparison</i> table and changed <i>Dropout Operation</i> section.....	13
• Changed <i>Application Information</i> section.....	14
• Changed <i>Typical Application Circuit (Fixed-Voltage Version)</i> figure and added <i>TPS71501 Adjustable LDO Regulator Programming</i> figure.....	14
• Changed <i>Detailed Design Procedure</i> section: Added subsections, changed <i>External Capacitor Requirements</i> section.....	14
• Added M3-specific curves to <i>Application Curves</i> section.....	17
• Added <i>Device Support</i> and <i>Documentation Support</i> sections.....	21

<b>Changes from Revision G (July 2013) to Revision H (October 2015)</b>	<b>Page</b>
• 添加了 ESD 等级表、特性说明部分、器件功能模式、应用和实施部分、电源相关建议部分、布局部分、器件和文档支持部分以及机械、封装和可订购信息部分.....	1

## 5 Pin Configuration and Functions



图 5-1. DCK Package (Fixed), 5-Pin SC70 (Top View)



图 5-2. DCK Package (Adjustable), 5-Pin SC70 (Top View)

表 5-1. Pin Functions

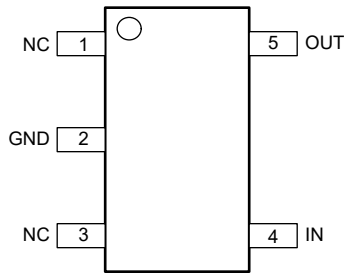
NAME	PIN		TYPE	DESCRIPTION
	SC70			
	FIXED	ADJ.		
FB		1	Input	In the adjustable configuration, this pin sets the output voltage with the help of the feedback divider.
NC	1		NC	No connect pin. This pin is not connected internally. Connect this pin to ground for best thermal performance or leave floating.
GND	2	2	GND	Ground pin.
NC	3	3	NC	No connect pin. This pin is not connected internally. Connect this pin to ground for best thermal performance or leave floating.
IN	4	4	Input	Input supply pin. See the <i>Recommended Operating Conditions</i> table and the <i>Input and Output Capacitor Requirements</i> section for more information.
OUT	5	5	Output	Output of the regulator. See the <i>Recommended Operating Conditions</i> table and the <i>Input and Output Capacitor Requirements</i> section for more information.

## 6 Specifications

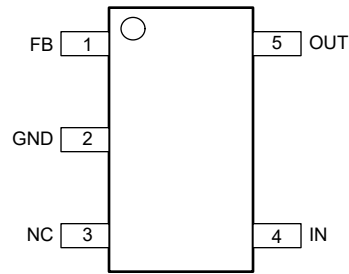
### 6.1 Absolute Maximum Ratings

over operating temperature range (unless otherwise noted)<sup>(1)</sup> <sup>(2)</sup>

		MIN	MAX	UNIT
Voltage	V <sub>IN</sub> (for legacy chip only)	- 0.3	24	V
	V <sub>IN</sub> (for new chip only)	- 0.3	30	
	V <sub>OUT</sub> (for fixed output new chip only)	- 0.3	$2 \times V_{OUT(typ)}$ or $V_{IN} + 0.3$ or 5.5 (whichever is lower)	
Current	Peak output current	Internally limited		
Temperature	Junction, T <sub>J</sub>	- 40	150	°C
	Storage, T <sub>stg</sub>	- 65	150	

(1) Stresses beyond those listed under *Absolute Maximum Ratings* may cause permanent damage to the device. These are stress ratings only, which do not imply functional operation of the device at these or any other conditions beyond those indicated under *Recommended Operating Conditions*. Exposure to absolute-maximum-rated conditions for extended periods may affect device reliability.

(2) All voltage values are with respect to network ground terminal.

### 6.2 ESD Ratings

		VALUE (legacy chip)	VALUE (new chip)	UNIT	
V <sub>(ESD)</sub>	Electrostatic discharge	Human-body model (HBM), per AEC Q100-002 <sup>(1)</sup>		V	
		Charged-device model (CDM), per AEC Q100-011	All pins		±500
			Corner pins (1, 3, 4, and 5)		±700

(1) AEC Q100-002 indicates that HBM stressing shall be in accordance with the ANSI/ESDA/JEDEC JS-001 specification.

### 6.3 Recommended Operating Conditions

over operating free-air temperature range (unless otherwise noted)<sup>(1)</sup>

		MIN	NOM	MAX	UNIT
V <sub>IN</sub>	Input supply voltage	2.5		24	V
C <sub>IN</sub>	Input capacitor <sup>(2)</sup>	0	0.047		μF
C <sub>OUT</sub>	Output capacitor (for legacy chip only)	0.47	1		
	Output capacitor (for new chip only) <sup>(3)</sup>	1			
T <sub>J</sub>	Operating junction temperature	-40		125	°C

(1) All voltages are with respect to GND.

(2) An input capacitor is not required for LDO stability. However, an input capacitor with an effective value of 0.047 μF is recommended to counteract the effect of source resistance and inductance, which may in some cases cause symptoms of system level instability such as ringing or oscillation, especially in the presence of load transients.

(3) All capacitor values are assumed to derate to 50% of the nominal capacitor value. Maintain an effective output capacitance of 0.47 μF minimum for the stability.

## Thermal Information

THERMAL METRIC <sup>(1)</sup>		Legacy Chip <sup>(2)</sup>	New Chip <sup>(2)</sup>	UNIT
		DCK (SC-70)	DCK (SC-70)	
		5 PINS	5 PINS	
$R_{\theta JA}$	Junction-to-ambient thermal resistance	253.8	195.7	°C/W
$R_{\theta JC(top)}$	Junction-to-case (top) thermal resistance	73.7	88.2	°C/W
$R_{\theta JB}$	Junction-to-board thermal resistance	84.6	40.7	°C/W
$\psi_{JT}$	Junction-to-top characterization parameter	1.1	11.2	°C/W
$\psi_{JB}$	Junction-to-board characterization parameter	83.9	40.5	°C/W

- (1) For more information about traditional and new thermal metrics, see the [Semiconductor and IC package thermal metrics](#) application report.
- (2) Thermal performance results are based on the JEDEC standard of 2s2p PCB config. These thermal metric parameters can be further improved by 35-55% based on thermally optimized PCB layout designs. See the analysis of the [Impact of board layout on LDO thermal performance](#) application report.

## 6.4 Electrical Characteristics

over operating junction temperature range ( $T_J = -40^\circ\text{C}$  to  $125^\circ\text{C}$ ),  $V_{IN} = V_{OUT(nom)} + 1\text{ V}$ ,  $I_{OUT} = 1\text{ mA}$ , and  $C_{OUT} = 1\ \mu\text{F}$  (unless otherwise noted); typical values are at  $T_J = 25^\circ\text{C}$

PARAMETER		TEST CONDITIONS	MIN	TYP	MAX	UNIT
$V_{IN}$	Input voltage <sup>(1)</sup>	$I_O = 10\text{ mA}$	2.5		24	V
		$I_O = 50\text{ mA}$	3		24	
$V_{OUT}$	Output voltage range (TPS71501)		1.205		15	V
	Output voltage accuracy <sup>(1) (2)</sup>	$V_{OUT} + 1\text{ V} \leq V_{IN} \leq 24\text{ V}$ , $100\ \mu\text{A} \leq I_{OUT} \leq 50\text{ mA}$	-4		4	%
$I_{GND}$	Ground pin current (legacy chip) <sup>(3)</sup>	$0 \leq I_{OUT} \leq 50\text{ mA}$ , $T_J = -40^\circ\text{C}$ to $85^\circ\text{C}$		3.2	4.2	$\mu\text{A}$
		$0\text{ mA} \leq I_{OUT} \leq 50\text{ mA}$		3.2	4.8	
		$0\text{ mA} \leq I_{OUT} \leq 50\text{ mA}$ , $V_{IN} = 24\text{ V}$			5.8	
	Ground pin current (new chip) <sup>(3)</sup>	$0 \leq I_{OUT} \leq 50\text{ mA}$ , $T_J = -40^\circ\text{C}$ to $85^\circ\text{C}$		3.2	4.1	
		$0\text{ mA} \leq I_{OUT} \leq 50\text{ mA}$		3.2	4.3	
		$0\text{ mA} \leq I_{OUT} \leq 50\text{ mA}$ , $V_{IN} = 24\text{ V}$			4.5	
$\Delta V_{OUT} (\Delta I_{OUT})$	Load regulation	$I_{OUT} = 100\ \mu\text{A}$ to $50\text{ mA}$		22		mV
$\Delta V_{OUT} (\Delta V_{IN})$	Output voltage line regulation (legacy chip) <sup>(1)</sup>	$V_{OUT(NOM)} + 1\text{ V} \leq V_{IN} \leq 24\text{ V}$		20	60	mV
	Output voltage line regulation (new chip) <sup>(1)</sup>	$V_{OUT(NOM)} + 1\text{ V} \leq V_{IN} \leq 24\text{ V}$		20	22	
$V_n$	Output noise voltage (legacy chip) <sup>(4)</sup>	$BW = 200\text{ Hz}$ to $100\text{ kHz}$ , $C_{OUT} = 10\ \mu\text{F}$ , $I_{OUT} = 50\text{ mA}$		575		$\mu\text{V}_{rms}$
	Output noise voltage (new chip) <sup>(4)</sup>	$BW = 200\text{ Hz}$ to $100\text{ kHz}$ , $C_{OUT} = 10\ \mu\text{F}$ , $I_{OUT} = 50\text{ mA}$		425		
$I_{CL}$	Output current limit (legacy chip)	$V_{OUT} = 0\text{ V}$ , $V_{IN} \geq 3.5\text{ V}$	125		750	mA
		$V_{OUT} = 0\text{ V}$ , $V_{IN} < 3.5\text{ V}$	90		750	
	Output current limit (new chip)	$V_{OUT} = 0\text{ V}$ , $V_{IN} \geq 3.5\text{ V}$	125		350	
		$V_{OUT} = 0\text{ V}$ , $V_{IN} < 3.5\text{ V}$	90		350	
PSRR	Power-supply ripple rejection	$f = 100\text{ kHz}$ , $C_{OUT} = 10\ \mu\text{F}$		60		dB
$V_{DO}$	Dropout voltage (legacy chip)	$I_{OUT} = 50\text{ mA}$ , $V_{IN} = V_{OUT(nom)} - 0.1\text{ V}$		415	750	mV
	Dropout voltage (new chip)	V		415	525	

- (1) Minimum  $V_{IN} = V_{OUT} + V_{DO}$  or the value shown for *Input voltage* in this table, whichever is greater.
- (2) For adjustable device, output accuracy excludes the tolerance and mismatch associated with external resistors used for setting up the output voltage level.
- (3) This device employs a leakage null control circuit. This circuit is active only if output current is less than pass transistor leakage current. The circuit is typically active when output load is less than  $5\ \mu\text{A}$ ,  $V_{IN}$  is greater than  $18\text{ V}$ , and die temperature is greater than  $100^\circ\text{C}$ .
- (4) See *Device nomenclature* for details about new and legacy chip descriptions.

### 6.5 Typical Characteristics

at operating temperature  $T_J = 25^\circ\text{C}$ ,  $V_{IN} = V_{OUT(NOM)} + 1.0\text{ V}$  or  $2.5\text{ V}$  (whichever is greater),  $I_{OUT} = 1\text{ mA}$ ,  $C_{IN} = 1\ \mu\text{F}$ , and  $C_{OUT} = 1\ \mu\text{F}$  (unless otherwise noted)

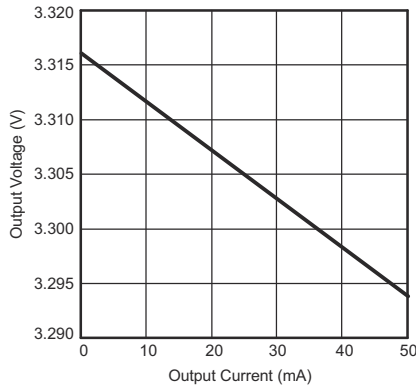

$V_{IN} = 4.3\text{ V}$ ,  $C_{OUT} = 1\ \mu\text{F}$ ,  $T_J = 25^\circ\text{C}$

图 6-1. Output Voltage vs Output Current for Legacy Chip

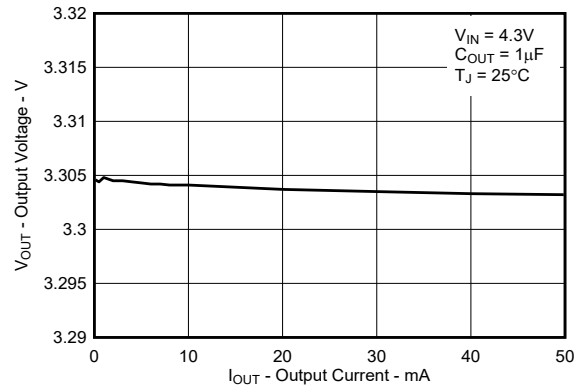

$V_{IN} = 4.3\text{ V}$ ,  $C_{OUT} = 1\ \mu\text{F}$ ,  $T_J = 25^\circ\text{C}$

图 6-2. Output Voltage vs Output Current for New Chip

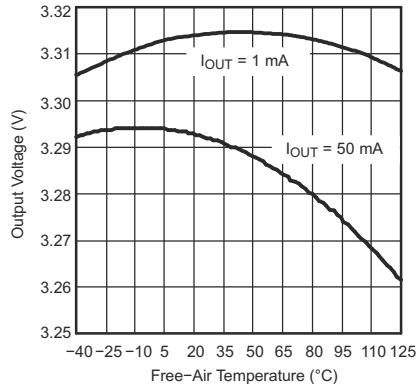

$V_{IN} = 4.3\text{ V}$ ,  $C_{OUT} = 1\ \mu\text{F}$

图 6-3. Output Voltage vs Free-Air Temperature for Legacy Chip

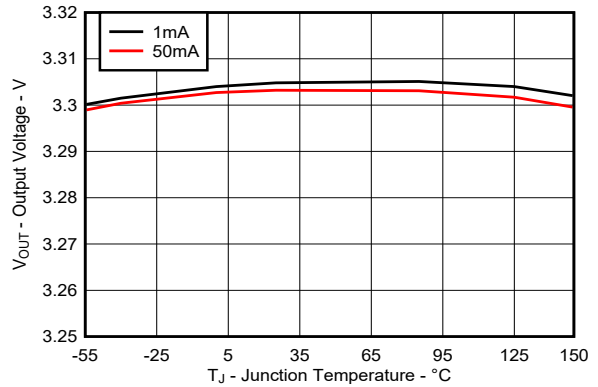

$V_{IN} = 4.3\text{ V}$ ,  $C_{OUT} = 1\ \mu\text{F}$

图 6-4. Output Voltage vs Free-Air Temperature for New Chip

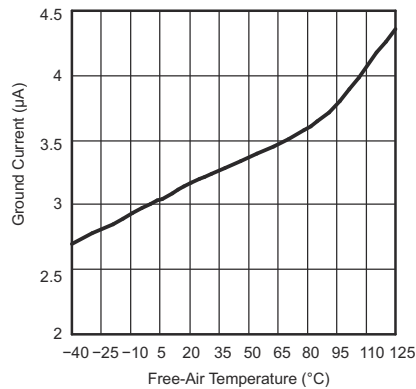

$V_{IN} = 4.3\text{ V}$ ,  $V_{OUT} = 3.3\text{ V}$ ,  $I_{OUT} = 1\ \mu\text{F}$

图 6-5. Quiescent Current vs Free-Air Temperature for Legacy Chip

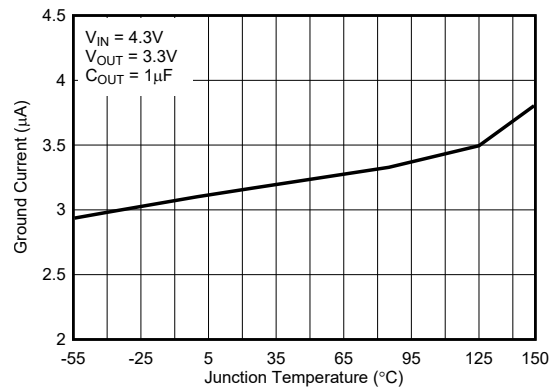

$V_{IN} = 4.3\text{ V}$ ,  $V_{OUT} = 3.3\text{ V}$ ,  $C_{OUT} = 1\ \mu\text{F}$

图 6-6. Quiescent Current vs Free-Air Temperature for New Chip

### 6.5 Typical Characteristics (continued)

at operating temperature  $T_J = 25^\circ\text{C}$ ,  $V_{IN} = V_{OUT(NOM)} + 1.0\text{ V}$  or  $2.5\text{ V}$  (whichever is greater),  $I_{OUT} = 1\text{ mA}$ ,  $C_{IN} = 1\ \mu\text{F}$ , and  $C_{OUT} = 1\ \mu\text{F}$  (unless otherwise noted)

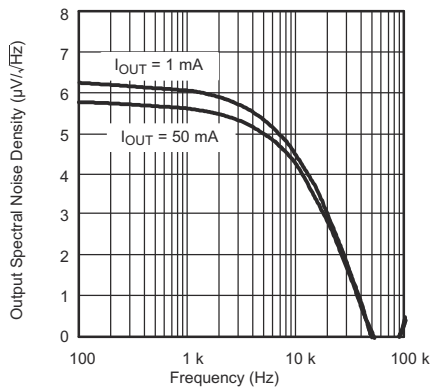

$V_{IN} = 4.3\text{ V}$ ,  $V_{OUT} = 3.3\text{ V}$ ,  $C_{OUT} = 1\ \mu\text{F}$

图 6-7. Output Spectral Noise Density vs Frequency for Legacy Chip

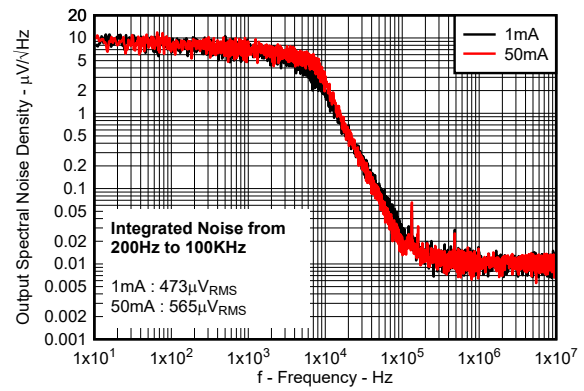

$V_{IN} = 4.3\text{ V}$ ,  $V_{OUT} = 3.3\text{ V}$ ,  $C_{OUT} = 1\ \mu\text{F}$

图 6-8. Output Spectral Noise Density vs Frequency for New Chip

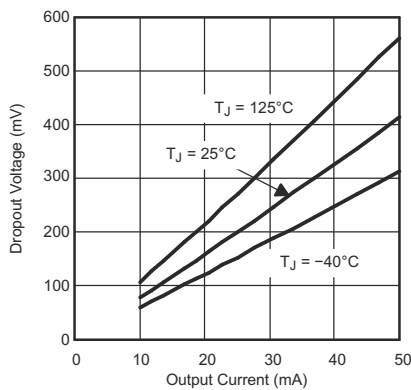

$V_{IN} = 3.2\text{ V}$ ,  $C_{OUT} = 1\ \mu\text{F}$

图 6-9. Dropout Voltage vs Output Current for Legacy Chip

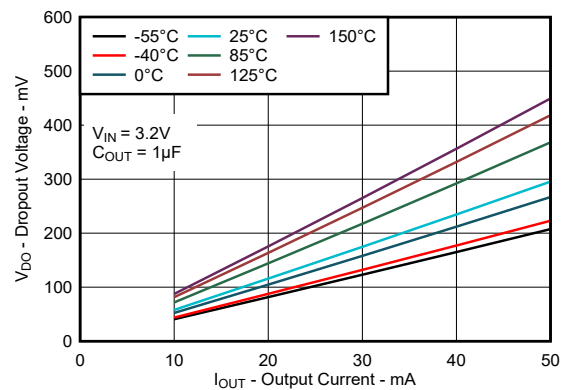

$V_{IN} = 3.2\text{ V}$ ,  $C_{OUT} = 1\ \mu\text{F}$

图 6-10. Dropout Voltage vs Output Current for New Chip

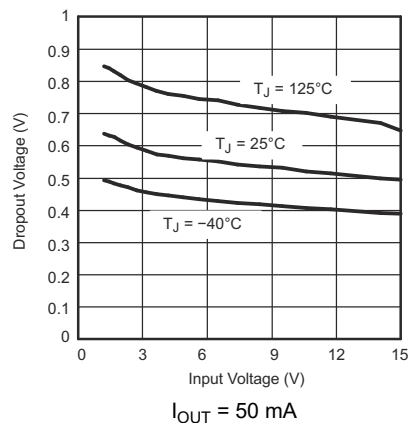

$I_{OUT} = 50\text{ mA}$

图 6-11. TPS71501 Dropout Voltage vs Input Voltage for Legacy Chip

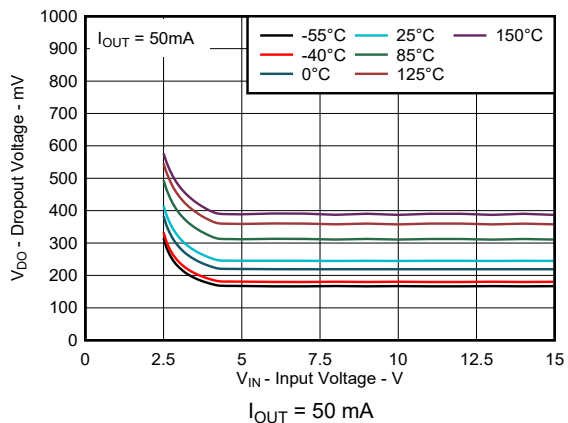

$I_{OUT} = 50\text{ mA}$

图 6-12. TPS71501 Dropout Voltage vs Input Voltage for New Chip



### 6.5 Typical Characteristics (continued)

at operating temperature  $T_J = 25^\circ\text{C}$ ,  $V_{IN} = V_{OUT(NOM)} + 1.0\text{ V}$  or  $2.5\text{ V}$  (whichever is greater),  $I_{OUT} = 1\text{ mA}$ ,  $C_{IN} = 1\ \mu\text{F}$ , and  $C_{OUT} = 1\ \mu\text{F}$  (unless otherwise noted)



图 6-13. Dropout Voltage vs Free-Air Temperature for Legacy Chip



图 6-14. Dropout Voltage vs Free-Air Temperature for New Chip

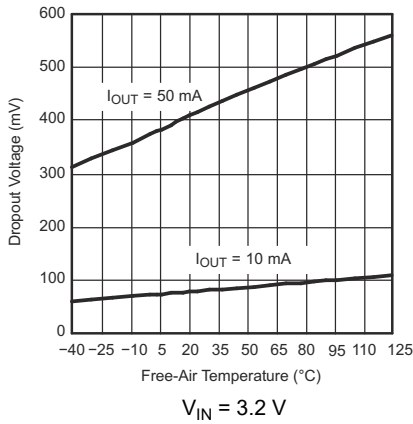

图 6-15. Power-Supply Ripple Rejection vs Frequency for Legacy Chip

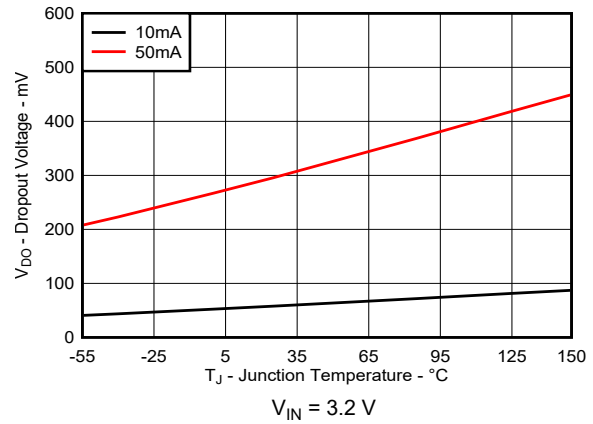

图 6-16. Power-Supply Ripple Rejection vs Frequency for New Chip

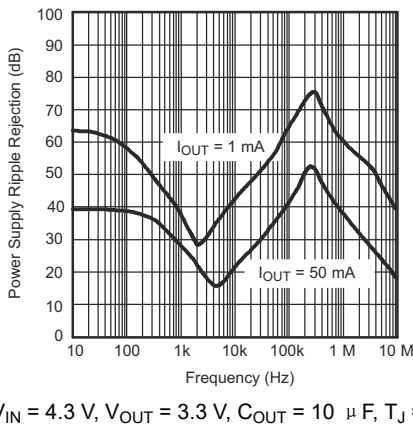

图 6-17. Power-Up and Power-Down for Legacy Chip

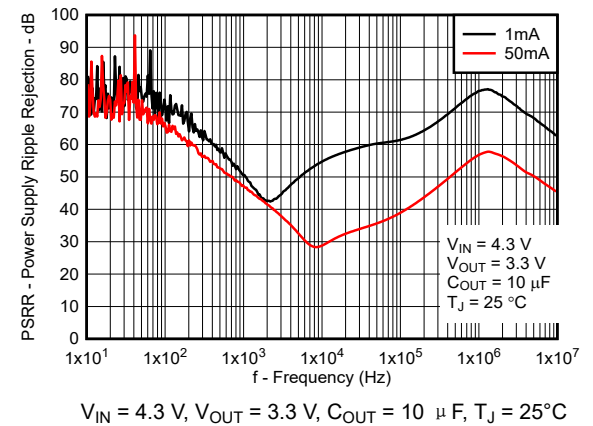

图 6-18. Power-Up and Power-Down for New Chip

### 6.5 Typical Characteristics (continued)

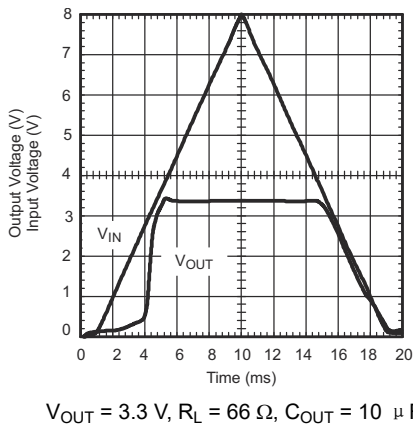
at operating temperature  $T_J = 25^\circ\text{C}$ ,  $V_{IN} = V_{OUT(NOM)} + 1.0\text{ V}$  or  $2.5\text{ V}$  (whichever is greater),  $I_{OUT} = 1\text{ mA}$ ,  $C_{IN} = 1\ \mu\text{F}$ , and  $C_{OUT} = 1\ \mu\text{F}$  (unless otherwise noted)

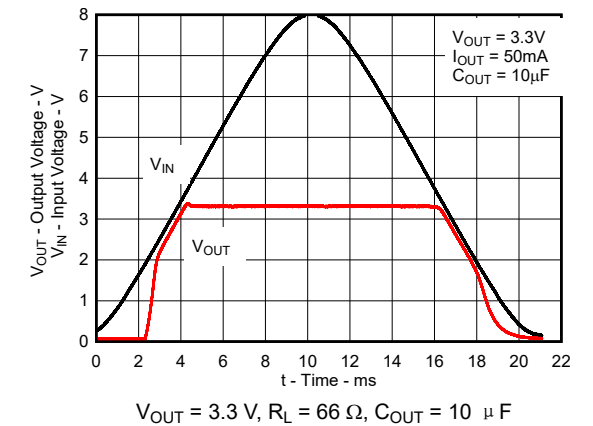
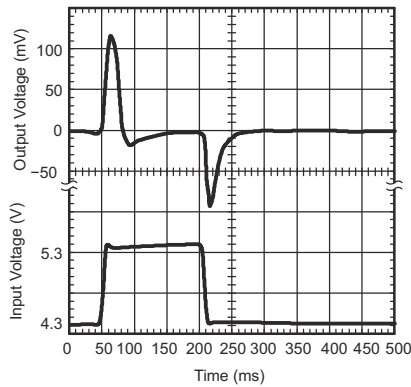

$V_{OUT} = 3.3\text{ V}$ ,  $I_{OUT} = 50\text{ mA}$ ,  $C_{OUT} = 10\ \mu\text{F}$

图 6-19. Line Transient Response for Legacy Chip

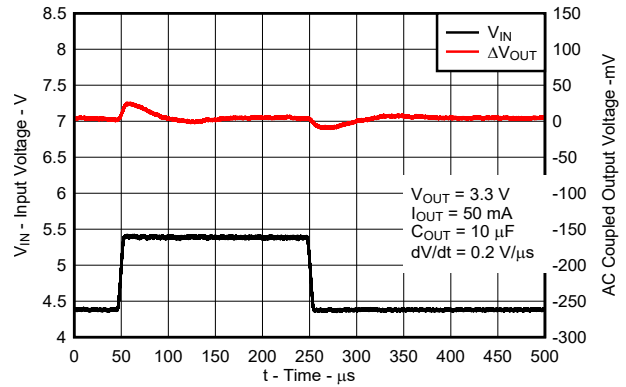

$V_{OUT} = 3.3\text{ V}$ ,  $I_{OUT} = 50\text{ mA}$ ,  $C_{OUT} = 10\ \mu\text{F}$

图 6-20. Line Transient Response for New Chip

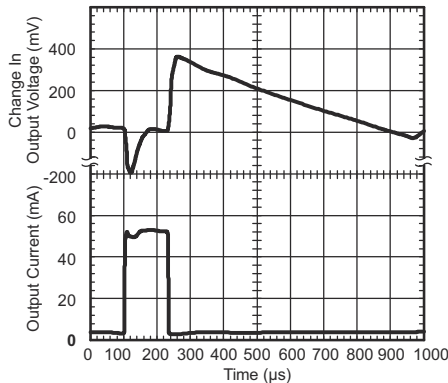

$V_{IN} = 4.3\text{ V}$ ,  $V_{OUT} = 3.3\text{ V}$ ,  $C_{OUT} = 10\ \mu\text{F}$

图 6-21. Load Transient Response for Legacy Chip

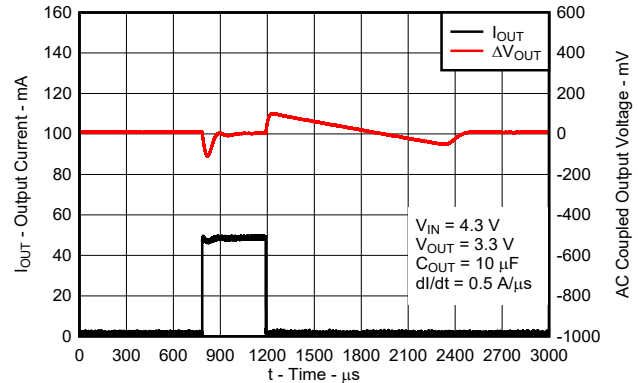

$V_{IN} = 4.3\text{ V}$ ,  $V_{OUT} = 3.3\text{ V}$ ,  $C_{OUT} = 10\ \mu\text{F}$

图 6-22. Load Transient Response for New Chip

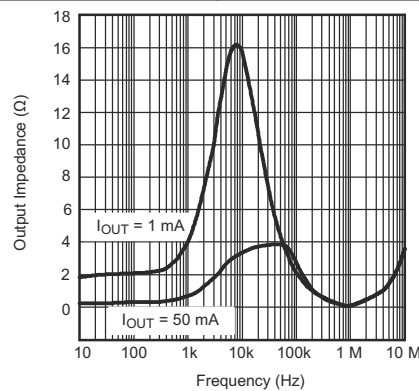

$V_{IN} = 4.3\text{ V}$ ,  $V_{OUT} = 3.3\text{ V}$ ,  $C_{OUT} = 1\ \mu\text{F}$ ,  $T_J = 25^\circ\text{C}$

图 6-23. Output Impedance vs Frequency for Legacy Chip

## 7 Detailed Description

### 7.1 Overview

The TPS715-Q1 low-dropout regulator (LDO) consumes only 3.2  $\mu\text{A}$  (typ) of quiescent current across the entire output current range, while offering a wide input voltage range and low-dropout voltage in small packaging. The device, which operates over an input range of 2.5 V to 24 V, is stable with any output capacitor greater than or equal to 0.47  $\mu\text{F}$ . The low quiescent current across the complete load current range makes the TPS715-Q1 optimal for powering battery-operated applications. The TPS715-Q1 has internal soft-start to control inrush current into the output capacitor. This LDO also has overcurrent protection during a load-short or fault condition on the output.

### 7.2 Functional Block Diagrams



图 7-1. Functional Block Diagram—Adjustable Version



图 7-2. Functional Block Diagram—Fixed Version

### 7.3 Feature Description

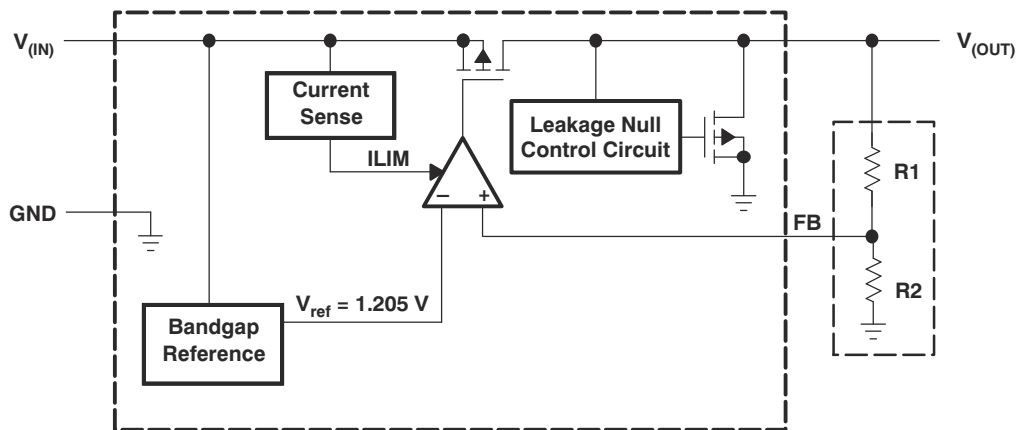
#### 7.3.1 Wide Supply Range

The TPS715-Q1 has an operational input supply range of 2.5 V to 24 V, allowing for a wide range of applications. This wide supply range is designed for applications that have either large transients or high DC voltage supplies.

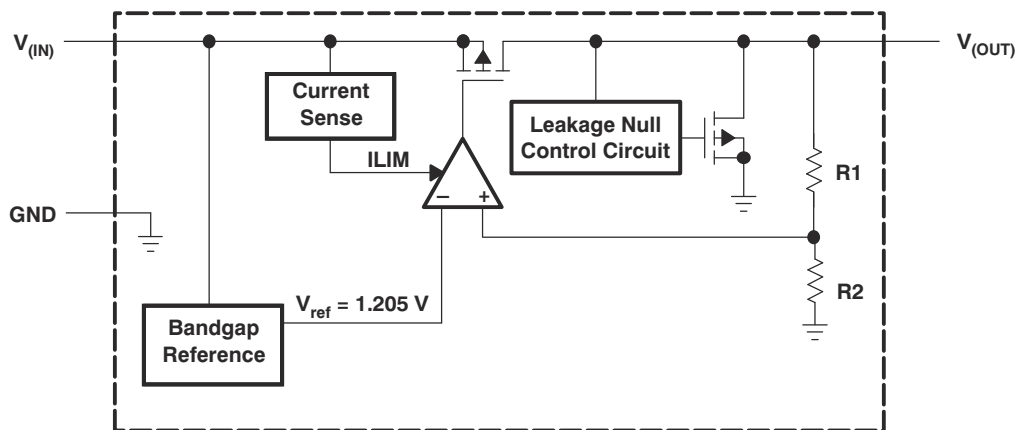
#### 7.3.2 Low Quiescent Current

The TPS715-Q1 only requires 3.2  $\mu\text{A}$  (typical) of quiescent current across the complete load current range (0 mA to 50 mA) from  $-40^{\circ}\text{C}$  to  $+125^{\circ}\text{C}$ .

### 7.3.3 Dropout Voltage ( $V_{DO}$ )

Dropout voltage ( $V_{DO}$ ) is defined as the input voltage minus the output voltage ( $V_{IN} - V_{OUT}$ ) at the rated output current ( $I_{RATED}$ ), where the pass transistor is fully on.  $I_{RATED}$  is the maximum  $I_{OUT}$  listed in the *Recommended Operating Conditions* table. In dropout operation, the pass transistor is in the ohmic or triode region of operation, and acts as a switch. The dropout voltage indirectly specifies a minimum input voltage greater than the nominal programmed output voltage at which the output voltage is expected to stay in regulation. If the input voltage falls to less than the value required to maintain output regulation, then the output voltage falls as well.

For a CMOS regulator, the dropout voltage is determined by the drain-source, on-state resistance ( $R_{DS(ON)}$ ) of the pass transistor. Therefore, if the linear regulator operates at less than the rated current, the dropout voltage for that current scales accordingly. Use [方程式 1](#) to calculate the  $R_{DS(ON)}$  of the device.

$$R_{DS(ON)} = \frac{V_{DO}}{I_{RATED}} \quad (1)$$

### 7.3.4 Current Limit

The device has an internal current limit circuit that protects the regulator during transient high-load current faults or shorting events. The current limit is a brick-wall scheme. In a high-load current fault, the brick-wall scheme limits the output current to the current limit ( $I_{CL}$ ).  $I_{CL}$  is listed in the *Electrical Characteristics* table.

The output voltage is not regulated when the device is in current limit. When a current limit event occurs, the device begins to heat up because of the increase in power dissipation. When the device is in brick-wall current limit, the pass transistor dissipates power  $[(V_{IN} - V_{OUT}) \times I_{CL}]$ . For more information on current limits, see the [Know Your Limits application note](#).

[图 7-3](#) shows a diagram of the current limit.

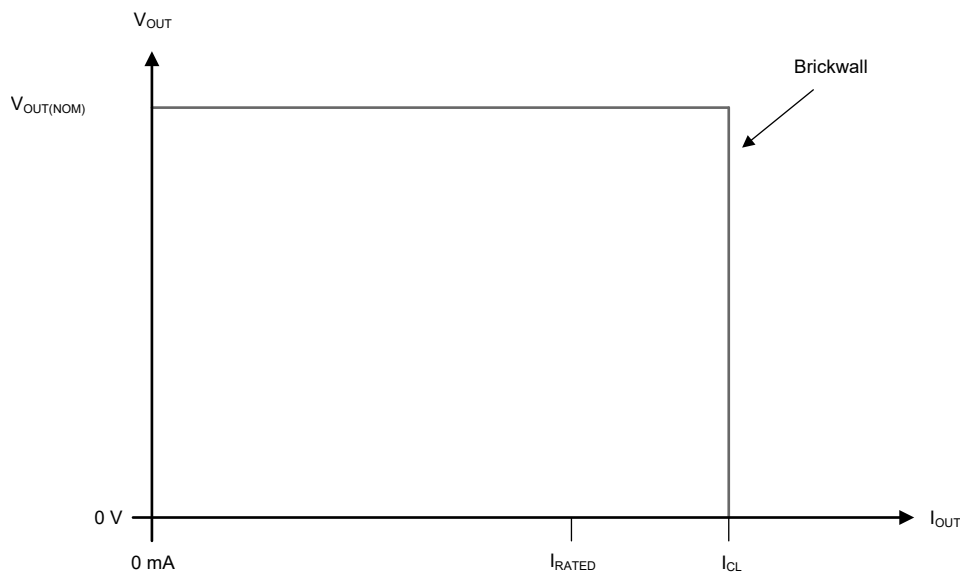

**图 7-3. Current Limit**

## 7.4 Device Functional Modes

表 7-1 provides a quick comparison between the normal and dropout modes of operation.

**表 7-1. Device Functional Mode Comparison**

OPERATING MODE	PARAMETER	
	$V_{IN}$	$I_{OUT}$
Normal	$V_{IN} > V_{OUT(nom)} + V_{DO}$	$I_{OUT} < I_{CL}$
Dropout	$V_{IN} < V_{OUT(nom)} + V_{DO}$	$I_{OUT} < I_{CL}$

### 7.4.1 Normal Operation

The device regulates to the nominal output voltage under the following conditions:

- The input voltage is greater than the nominal output voltage plus the dropout voltage ( $V_{OUT(nom)} + V_{DO}$ )
- The output current is less than the current limit ( $I_{OUT} < I_{CL}$ )
- The device junction temperature is greater than  $-40^{\circ}\text{C}$  and less than  $+125^{\circ}\text{C}$

### 7.4.2 Dropout Operation

If the input voltage is lower than the nominal output voltage plus the specified dropout voltage, but all other conditions are met for normal operation, the device operates in dropout mode. In this mode, the output voltage tracks the input voltage. During this mode, the transient performance of the device becomes significantly degraded because the pass transistor is in the ohmic or triode region, and acts as a switch. Line or load transients in dropout can result in large output voltage deviations.

When the device is in a steady dropout state (defined as when the device is in dropout,  $V_{IN} < V_{OUT(NOM)} + V_{DO}$ , directly after being in a normal regulation state, but *not* during start-up), the pass transistor is driven into the ohmic or triode region. When the input voltage returns to a value greater than or equal to the nominal output voltage plus the dropout voltage ( $V_{OUT(NOM)} + V_{DO}$ ), the output voltage can overshoot for a short period of time while the device pulls the pass transistor back into the linear region.

## 8 Application and Implementation

### 备注

以下应用部分中的信息不属于 TI 器件规格的范围，TI 不担保其准确性和完整性。TI 的客户应负责确定器件是否适用于其应用。客户应验证并测试其设计，以确保系统功能。

### 8.1 Application Information

The TPS715-Q1 LDO regulator is designed for battery-powered applications and is a good supply for low-power microcontrollers (such as the [MSP430](#)) because of the device low  $I_Q$  performance across load current range. The ultra-low-supply current of the TPS715-Q1 maximizes efficiency at light loads, and the high input voltage range and flexibility of output voltage selection in the adjustable configuration and fixed output levels makes the device an optimal supply for infotainment and cluster systems and body electronics in automotive applications.

### 8.2 Typical Application



图 8-1. Typical Application Circuit (Fixed-Voltage Version)



图 8-2. TPS71501-Q1 Adjustable LDO Regulator Programming

#### 8.2.1 Detailed Design Procedure

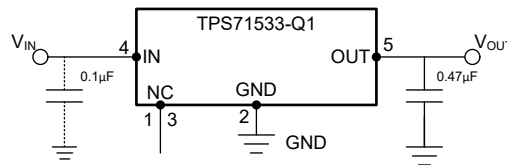
##### 8.2.1.1 Programming the TPS71501-Q1 Adjustable LDO Regulator

The output voltage of the TPS71501-Q1 adjustable regulator is programmed using an external resistor divider as shown in [图 8-3](#). The output voltage is calculated using [方程式 2](#).

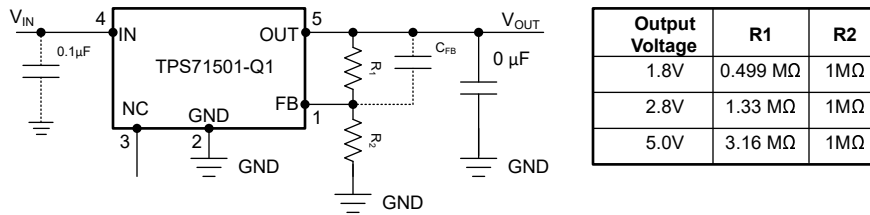
$$V_O = V_{ref} \times \left(1 + \frac{R1}{R2}\right) \tag{2}$$

where:

- $V_{REF} = 1.205 \text{ V typ}$  (the internal reference voltage)



图 8-3. TPS71501-Q1 Adjustable LDO Regulator Programming

Choose resistors R1 and R2 for an approximately 1.5-  $\mu$  A divider current. Lower value resistors can be used for improved noise performance, but the solution consumes more power. Avoid higher resistor values because leakage current into and out of FB across R1 and R2 creates an offset voltage that artificially increases or decreases the feedback voltage and thus erroneously decreases or increases  $V_O$ . The recommended design procedure is to choose R2 equal to 1 M $\Omega$  to set the divider current at 1.5  $\mu$  A and then calculate R1 using [方程式 3](#).

$$R1 = \left( \frac{V_O}{V_{ref}} - 1 \right) \times R2 \quad (3)$$

### 8.2.1.2 External Capacitor Requirements

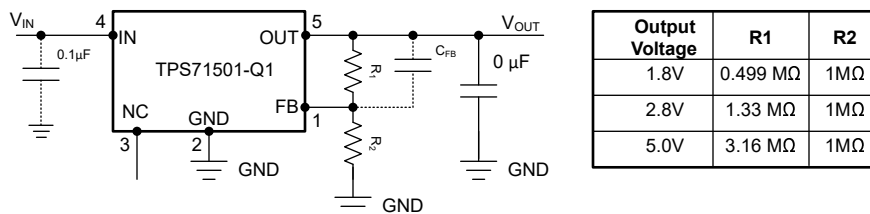
The device is designed to be stable using low equivalent series resistance (ESR) ceramic capacitors at the input and output. Multilayer ceramic capacitors have become the industry standard for these types of applications and are recommended, but must be used with good judgment. Ceramic capacitors that employ X7R-, X5R-, and COG-rated dielectric materials provide relatively good capacitive stability across temperature, whereas the use of Y5V-rated capacitors is discouraged because of large variations in capacitance.

Regardless of the ceramic capacitor type selected, the effective capacitance varies with operating voltage and temperature. Generally, expect the effective capacitance to decrease by as much as 50%. The input and output capacitors listed in the *Recommended Operating Conditions* table account for an effective capacitance of approximately 50% of the nominal value.

### 8.2.1.3 Input and Output Capacitor Requirements

Although an input capacitor is not required for stability, good analog design practice is to connect a capacitor from IN to GND. This capacitor counteracts reactive input sources and improves transient response, input ripple, and PSRR. An input capacitor is recommended if the source impedance is more than 0.5  $\Omega$ . A higher value capacitor can be necessary if large, fast rise-time load or line transients are anticipated or if the device is located several inches from the input power source.

Dynamic performance of the device is improved with the use of a large output capacitor. Use an output capacitor within the range specified in the *Recommended Operating Conditions* table for stability.

### 8.2.1.4 Reverse Current

Excessive reverse current can damage this device. Reverse current flows through the intrinsic body diode of the PMOS pass transistor instead of the normal conducting channel. At high magnitudes, this current flow degrades the long-term reliability of the device.

Conditions where reverse current can occur are outlined in this section, all of which can exceed the absolute maximum rating of  $V_{OUT} \leq V_{IN} + 0.3$  V. These conditions are:

- If the device has a large  $C_{OUT}$  and the input supply collapses with little or no load current
- The output is biased when the input supply is not established
- The output is biased above the input supply

If reverse current flow is expected in the application, external protection is recommended to protect the device. Reverse current is not limited in the device, so external limiting is required if extended reverse voltage operation is anticipated. Limit reverse current to 5% or less of the rated output current of the device in the event this current cannot be avoided.

图 8-4 shows one approach for protecting the device.



图 8-4. Example Circuit for Reverse Current Protection Using a Schottky Diode

### 8.2.1.5 Feed-Forward Capacitor ( $C_{FF}$ )

For the adjustable-voltage version device, a feed-forward capacitor ( $C_{FF}$ ) can be connected from the OUT pin to the FB pin.  $C_{FF}$  improves transient, noise, and PSRR performance, but is not required for regulator stability. Recommended  $C_{FF}$  values are listed in the *Recommended Operating Conditions* table. A higher capacitance  $C_{FF}$  can be used; however, the start-up time increases. For a detailed description of  $C_{FF}$  tradeoffs, see the [Pros and Cons of Using a Feedforward Capacitor with a Low-Dropout Regulator application note](#).

$C_{FF}$  and  $R_1$  form a zero in the loop gain at frequency  $f_z$ , while  $C_{FF}$ ,  $R_1$ , and  $R_2$  form a pole in the loop gain at frequency  $f_p$ .  $C_{FF}$  zero and pole frequencies can be calculated from the following equations:

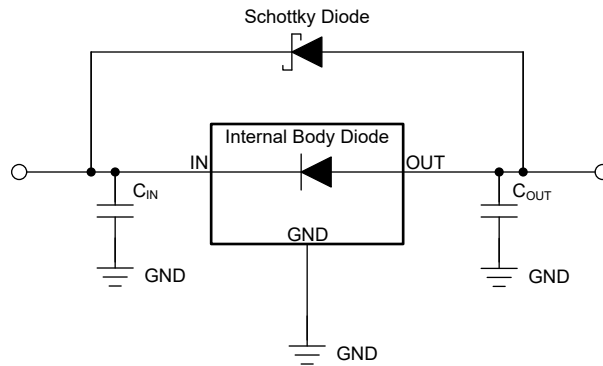
$$f_z = 1 / (2 \times \pi \times C_{FF} \times R_1) \quad (4)$$

$$f_p = 1 / (2 \times \pi \times C_{FF} \times (R_1 \parallel R_2)) \quad (5)$$

$C_{FF} \geq 10$  pF is required for stability if the feedback divider current is less than 5  $\mu$ A. 方程式 6 calculates the feedback divider current.

$$I_{FB\_Divider} = V_{OUT} / (R_1 + R_2) \quad (6)$$

To avoid start-up time increases from  $C_{FF}$ , limit the product  $C_{FF} \times R_1 < 50$   $\mu$ s.

For an output voltage of 1.205 V with the FB pin tied to the OUT pin, no  $C_{FF}$  is used.

### 8.2.1.6 Power Dissipation ( $P_D$ )

Circuit reliability requires consideration of the device power dissipation, location of the circuit on the printed circuit board (PCB), and correct sizing of the thermal plane. The PCB area around the regulator must have few or no other heat-generating devices that cause added thermal stress.

To first-order approximation, power dissipation in the regulator depends on the input-to-output voltage difference and load conditions. The following equation calculates power dissipation ( $P_D$ ).

$$P_D = (V_{IN} - V_{OUT}) \times I_{OUT} \quad (7)$$

#### 备注

Power dissipation can be minimized, and therefore greater efficiency can be achieved, by correct selection of the system voltage rails. For the lowest power dissipation, use the minimum input voltage required for correct output regulation.



For devices with a thermal pad, the primary heat conduction path for the device package is through the thermal pad to the PCB. Solder the thermal pad to a copper pad area under the device. This pad area must contain an array of plated vias that conduct heat to additional copper planes for increased heat dissipation.

The maximum power dissipation determines the maximum allowable ambient temperature ( $T_A$ ) for the device. According to the following equation, power dissipation and junction temperature are most often related by the junction-to-ambient thermal resistance ( $R_{\theta JA}$ ) of the combined PCB and device package and the temperature of the ambient air ( $T_A$ ).

$$T_J = T_A + (R_{\theta JA} \times P_D) \quad (8)$$

Thermal resistance ( $R_{\theta JA}$ ) is highly dependent on the heat-spreading capability built into the particular PCB design, and therefore varies according to the total copper area, copper weight, and location of the planes. The junction-to-ambient thermal resistance listed in the *Thermal Information* table is determined by the JEDEC standard PCB and copper-spreading area, and is used as a relative measure of package thermal performance.

### 8.2.1.7 Estimating Junction Temperature

The JEDEC standard now recommends the use of psi ( $\Psi$ ) thermal metrics to estimate the junction temperatures of the linear regulator when in-circuit on a typical PCB board application. These metrics are not thermal resistance parameters and instead offer a practical and relative way to estimate junction temperature. These psi metrics are determined to be significantly independent of the copper area available for heat-spreading. The *Thermal Information* table lists the primary thermal metrics, which are the junction-to-top characterization parameter ( $\psi_{JT}$ ) and junction-to-board characterization parameter ( $\psi_{JB}$ ). These parameters provide two methods for calculating the junction temperature ( $T_J$ ), as described in the following equations. Use the junction-to-top characterization parameter ( $\psi_{JT}$ ) with the temperature at the center-top of device package ( $T_T$ ) to calculate the junction temperature. Use the junction-to-board characterization parameter ( $\psi_{JB}$ ) with the PCB surface temperature 1 mm from the device package ( $T_B$ ) to calculate the junction temperature.

$$T_J = T_T + \psi_{JT} \times P_D \quad (9)$$

where:

- $P_D$  is the dissipated power
- $T_T$  is the temperature at the center-top of the device package

$$T_J = T_B + \psi_{JB} \times P_D \quad (10)$$

where:

- $T_B$  is the PCB surface temperature measured 1 mm from the device package and centered on the package edge

For detailed information on the thermal metrics and how to use them, see the [Semiconductor and IC Package Thermal Metrics application note](#).

### 8.2.2 Application Curves

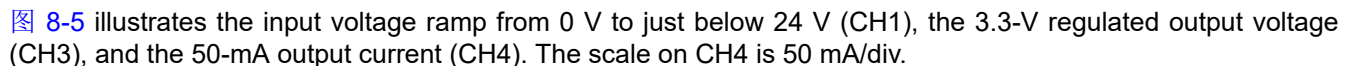
 **Figure 8-5** illustrates the input voltage ramp from 0 V to just below 24 V (CH1), the 3.3-V regulated output voltage (CH3), and the 50-mA output current (CH4). The scale on CH4 is 50 mA/div.

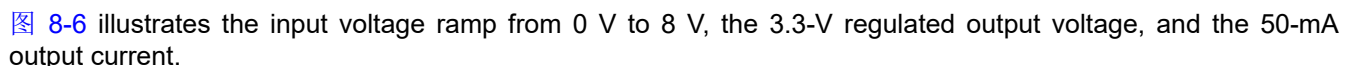
 **Figure 8-6** illustrates the input voltage ramp from 0 V to 8 V, the 3.3-V regulated output voltage, and the 50-mA output current.

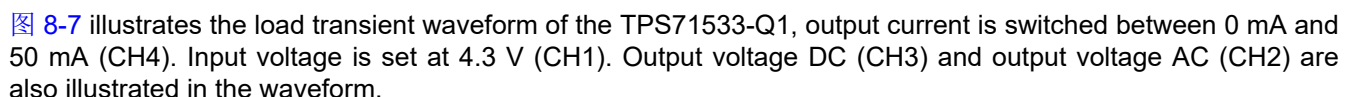
 **Figure 8-7** illustrates the load transient waveform of the TPS71533-Q1, output current is switched between 0 mA and 50 mA (CH4). Input voltage is set at 4.3 V (CH1). Output voltage DC (CH3) and output voltage AC (CH2) are also illustrated in the waveform.

TPS715-Q1

ZHCSMQ01 - OCTOBER 2004 - REVISED MAY 2023

图 8-8 illustrates the load transient waveform of the TPS71533-Q1, output current is switched between 0 mA and 50 mA with a slew rate of  $0.5 \text{ A}/\mu\text{s}$ . Input voltage is set at 4.3 V. Output voltage AC is illustrated in the waveform to capture the undershoot and overshoot behavior.

图 8-9 illustrates the line transient waveform of the TPS71533-Q1, where input voltage is switched between 5 V and 14 V with slew rate of  $0.66 \text{ V}/\mu\text{s}$ . Load current is set at 50 mA. Output voltage AC is illustrated in the waveform to capture the undershoot and overshoot behavior.

图 8-10 illustrates the fast dropout exit waveform of the TPS71533-Q1, where input voltage is switched between 2.5 V and 14 V with slew rate of  $1.15 \text{ V}/\mu\text{s}$ . Load current is set at 1 mA and 50 mA. Output voltage AC is illustrated in the waveform to capture the undershoot and overshoot behavior.



图 8-5. TPS71533-Q1 Power-Up and Power-Down Waveform for Legacy Chip



图 8-6. TPS71533-Q1 Power-Up and Power-Down Waveform for New Chip

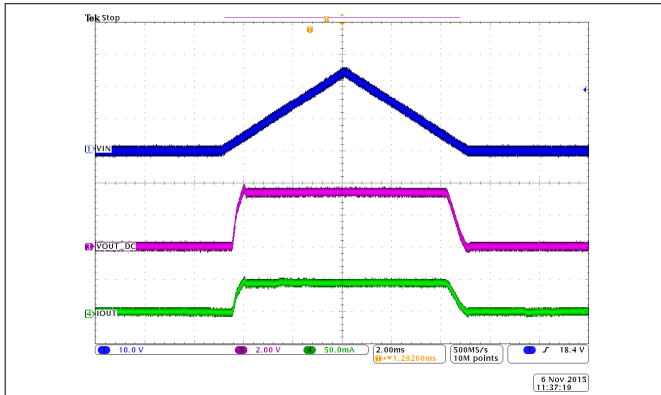

图 8-7. TPS71533-Q1 Load Transient Waveform for Legacy Chip

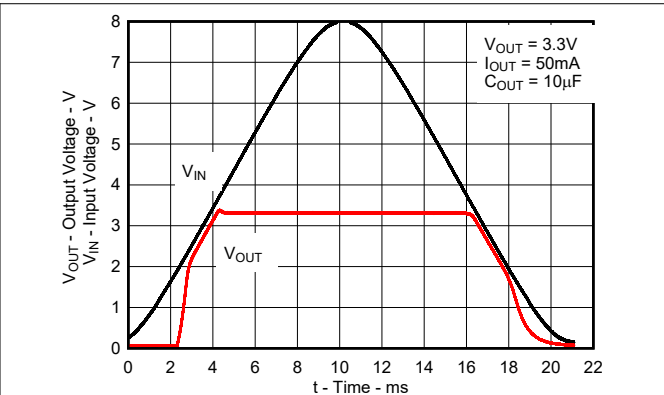

图 8-8. TPS71533-Q1 Load Transient Waveform for New Chip

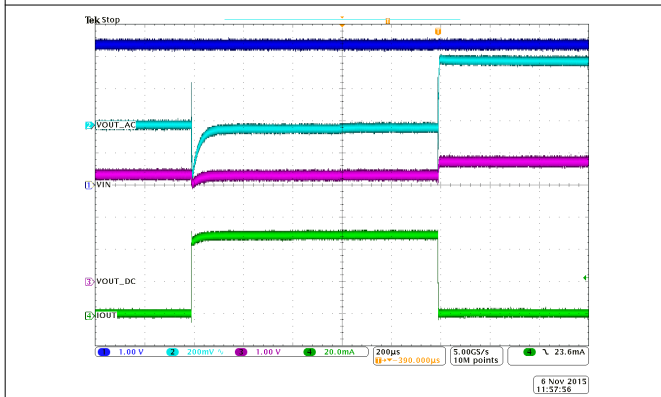

图 8-9. TPS71533-Q1 Fast Line Transient Waveform for New Chip

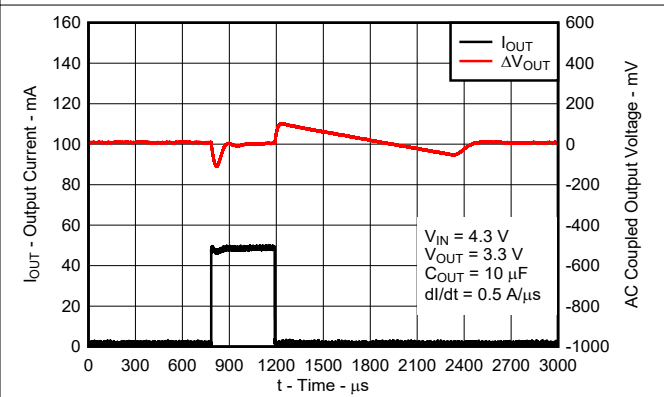

图 8-10. TPS71533-Q1 Dropout Exit Transient Response for New Chip

### 8.3 Power Supply Recommendations

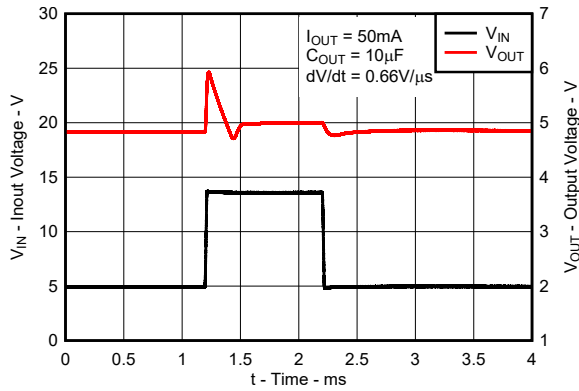
The device is designed to operate from a max 24-V input voltage supply. This input supply must be well regulated. If the input supply is located more than a few inches from the TPS715-Q1, add a microfarad ( $\mu\text{F}$ ) level bulk capacitor and a nanofarad (nF) level ceramic bypass capacitor at the input.

### 8.4 Layout

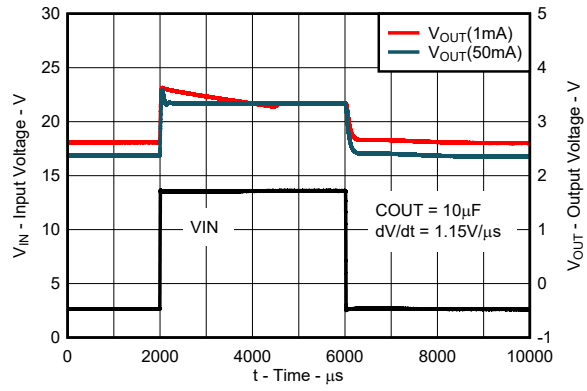
#### 8.4.1 Layout Guidelines

For the LDO power supply, layout is an important step. If layout is not carefully designed, the regulator can possibly not deliver enough output current because of the thermal limitation. To improve the thermal performance of the device, and maximize the current output at high ambient temperature, spread the ground copper as large as possible. 图 8-11 shows an example layout.

##### 8.4.1.1 Power Dissipation

To provide reliable operation, worst-case junction temperature must not exceed  $125^{\circ}\text{C}$ . This restriction limits the power dissipation the regulator can handle in any given application. To make sure the junction temperature is within acceptable limits, calculate the maximum allowable dissipation,  $P_{D(\text{max})}$ , and the actual dissipation,  $P_D$ , which must be less than or equal to  $P_{D(\text{max})}$ .

The maximum-power-dissipation limit is determined using 方程式 11:

$$P_{D(\text{max})} = \frac{T_{J\text{max}} - T_A}{R_{\theta\text{JA}}} \quad (11)$$

where:

- $T_{J\text{max}}$  is the maximum allowable junction temperature
- $R_{\theta\text{JA}}$  is the thermal resistance junction-to-ambient for the package (see the *Thermal Information* table)
- $T_A$  is the ambient temperature

The regulator dissipation is calculated using 方程式 12:

$$P_D = (V_{\text{IN}} - V_{\text{OUT}}) \times I_{\text{OUT}} \quad (12)$$

#### 8.4.2 Layout Example



图 8-11. TPS715-Q1 Layout Example

## 9 Device and Documentation Support

### 9.1 Device Support

#### 9.1.1 Development Support

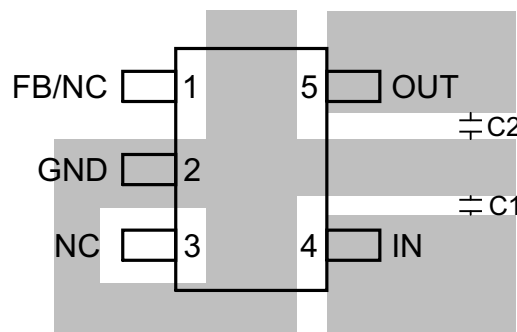
##### 9.1.1.1 Evaluation Module

An evaluation module (EVM) is available to assist in the initial circuit performance evaluation using the TPS715-Q1. The [TPS71533EVM evaluation module](#) (and related [user's guide](#)) can be requested at the TI website through the product folders or purchased directly from [the TI eStore](#).

##### 9.1.1.2 Spice Models

Computer simulation of circuit performance using SPICE is often useful when analyzing the performance of analog circuits and systems. A SPICE model for the TPS715-Q1 is available through the product folders under *Tools & Software*.

#### 9.1.2 Device Nomenclature

**表 9-1. Device Nomenclature<sup>(1)</sup>**

PRODUCT	$V_{OUT}$
TPS715xxQyyy zQ1 Legacy chip	<b>xx</b> is the nominal output voltage (for example, 28 = 2.8 V, 285 = 2.85 V, 01 = Adjustable). <b>yyy</b> is the package designator. <b>z</b> is the package quantity.
TPS715xxQyyy z M3 New chip	<b>xx</b> is the nominal output voltage (for example, 28 = 2.8 V, 285 = 2.85 V, 01 = Adjustable). <b>yyy</b> is the package designator. <b>z</b> is the package quantity. <b>M3</b> is a suffix designator for new chip redesigns on the latest TI process technology.

(1) For the most current package and ordering information see the Package Option Addendum at the end of this document, or see the TI website at [www.ti.com](#).

## 9.2 Documentation Support

### 9.2.1 Related Documentation

For related documentation see the following:

- Texas Instruments, [TPS715A 24-V High Input Voltage, Micropower, 80-mA LDO Voltage Regulator data sheet](#)
- Texas Instruments, [TPS71533EVM LDO Evaluation Module user guide](#)
- Texas Instruments, [Pros and Cons of Using a Feedforward Capacitor with a Low-Dropout Regulator application note](#)
- Texas Instruments, [Know Your Limits application note](#)

### 9.3 接收文档更新通知

要接收文档更新通知，请导航至 [ti.com](#) 上的器件产品文件夹。点击 [订阅更新](#) 进行注册，即可每周接收产品信息更改摘要。有关更改的详细信息，请查看任何已修订文档中包含的修订历史记录。

### 9.4 支持资源

[TI E2E™ 支持论坛](#) 是工程师的重要参考资料，可直接从专家获得快速、经过验证的解答和设计帮助。搜索现有解答或提出自己的问题可获得所需的快速设计帮助。

链接的内容由各个贡献者“按原样”提供。这些内容并不构成 TI 技术规范，并且不一定反映 TI 的观点；请参阅 TI 的《[使用条款](#)》。

### 9.5 Trademarks

TI E2E™ is a trademark of Texas Instruments.

所有商标均为其各自所有者的财产。

## 9.6 静电放电警告



静电放电 (ESD) 会损坏这个集成电路。德州仪器 (TI) 建议通过适当的预防措施处理所有集成电路。如果不遵守正确的处理和安装程序，可能会损坏集成电路。

ESD 的损坏小至导致微小的性能降级，大至整个器件故障。精密的集成电路可能更容易受到损坏，这是因为非常细微的参数更改都可能会导致器件与其发布的规格不相符。

## 9.7 术语表

[TI 术语表](#) 本术语表列出并解释了术语、首字母缩略词和定义。

## 10 Mechanical, Packaging, and Orderable Information

The following pages include mechanical, packaging, and orderable information. This information is the most current data available for the designated devices. This data is subject to change without notice and revision of this document. For browser-based versions of this data sheet, refer to the left-hand navigation.

**PACKAGING INFORMATION**

Orderable Device	Status (1)	Package Type	Package Drawing	Pins	Package Qty	Eco Plan (2)	Lead finish/ Ball material (6)	MSL Peak Temp (3)	Op Temp (°C)	Device Marking (4/5)	Samples
TPS71501QDCKRM3Q1	ACTIVE	SC70	DCK	5	3000	RoHS & Green	NIPDAU	Level-1-260C-UNLIM	-40 to 125	ANS	<a href="#">Samples</a>
TPS71501QDCKRQ1	ACTIVE	SC70	DCK	5	3000	RoHS & Green	NIPDAU   NIPDAUAG	Level-1-260C-UNLIM	-40 to 125	ANS	<a href="#">Samples</a>
TPS71525QDCKRM3Q1	ACTIVE	SC70	DCK	5	3000	RoHS & Green	NIPDAU	Level-1-260C-UNLIM	-40 to 125	ANU	<a href="#">Samples</a>
TPS71525QDCKRQ1	ACTIVE	SC70	DCK	5	3000	RoHS & Green	NIPDAU   NIPDAUAG	Level-1-260C-UNLIM	-40 to 125	ANU	<a href="#">Samples</a>
TPS71530QDCKRM3Q1	ACTIVE	SC70	DCK	5	3000	RoHS & Green	NIPDAU	Level-1-260C-UNLIM	-40 to 125	ANV	<a href="#">Samples</a>
TPS71530QDCKRQ1	ACTIVE	SC70	DCK	5	3000	RoHS & Green	NIPDAUAG	Level-1-260C-UNLIM	-40 to 125	ANV	<a href="#">Samples</a>
TPS71533QDCKRM3Q1	ACTIVE	SC70	DCK	5	3000	RoHS & Green	NIPDAU	Level-1-260C-UNLIM	-40 to 125	ANW	<a href="#">Samples</a>
TPS71533QDCKRQ1	ACTIVE	SC70	DCK	5	3000	RoHS & Green	NIPDAU   NIPDAUAG	Level-1-260C-UNLIM	-40 to 125	ANW	<a href="#">Samples</a>
TPS71550QDCKRM3Q1	ACTIVE	SC70	DCK	5	3000	RoHS & Green	NIPDAU	Level-1-260C-UNLIM	-40 to 125	ANX	<a href="#">Samples</a>
TPS71550QDCKRQ1	ACTIVE	SC70	DCK	5	3000	RoHS & Green	NIPDAU   NIPDAUAG	Level-1-260C-UNLIM	-40 to 125	ANX	<a href="#">Samples</a>

(1) The marketing status values are defined as follows:

**ACTIVE:** Product device recommended for new designs.

**LIFEBUY:** TI has announced that the device will be discontinued, and a lifetime-buy period is in effect.

**NRND:** Not recommended for new designs. Device is in production to support existing customers, but TI does not recommend using this part in a new design.

**PREVIEW:** Device has been announced but is not in production. Samples may or may not be available.

**OBSOLETE:** TI has discontinued the production of the device.

(2) **RoHS:** TI defines "RoHS" to mean semiconductor products that are compliant with the current EU RoHS requirements for all 10 RoHS substances, including the requirement that RoHS substance do not exceed 0.1% by weight in homogeneous materials. Where designed to be soldered at high temperatures, "RoHS" products are suitable for use in specified lead-free processes. TI may reference these types of products as "Pb-Free".

**RoHS Exempt:** TI defines "RoHS Exempt" to mean products that contain lead but are compliant with EU RoHS pursuant to a specific EU RoHS exemption.

**Green:** TI defines "Green" to mean the content of Chlorine (Cl) and Bromine (Br) based flame retardants meet JS709B low halogen requirements of <=1000ppm threshold. Antimony trioxide based flame retardants must also meet the <=1000ppm threshold requirement.

(3) MSL, Peak Temp. - The Moisture Sensitivity Level rating according to the JEDEC industry standard classifications, and peak solder temperature.

(4) There may be additional marking, which relates to the logo, the lot trace code information, or the environmental category on the device.

<sup>(5)</sup> Multiple Device Markings will be inside parentheses. Only one Device Marking contained in parentheses and separated by a "~" will appear on a device. If a line is indented then it is a continuation of the previous line and the two combined represent the entire Device Marking for that device.

<sup>(6)</sup> Lead finish/Ball material - Orderable Devices may have multiple material finish options. Finish options are separated by a vertical ruled line. Lead finish/Ball material values may wrap to two lines if the finish value exceeds the maximum column width.

**Important Information and Disclaimer:**The information provided on this page represents TI's knowledge and belief as of the date that it is provided. TI bases its knowledge and belief on information provided by third parties, and makes no representation or warranty as to the accuracy of such information. Efforts are underway to better integrate information from third parties. TI has taken and continues to take reasonable steps to provide representative and accurate information but may not have conducted destructive testing or chemical analysis on incoming materials and chemicals. TI and TI suppliers consider certain information to be proprietary, and thus CAS numbers and other limited information may not be available for release.

In no event shall TI's liability arising out of such information exceed the total purchase price of the TI part(s) at issue in this document sold by TI to Customer on an annual basis.

**OTHER QUALIFIED VERSIONS OF TPS715-Q1 :**

- Catalog : [TPS715](#)

NOTE: Qualified Version Definitions:

- Catalog - TI's standard catalog product



**TAPE AND REEL INFORMATION**

**QUADRANT ASSIGNMENTS FOR PIN 1 ORIENTATION IN TAPE**

\*All dimensions are nominal

Device	Package Type	Package Drawing	Pins	SPQ	Reel Diameter (mm)	Reel Width W1 (mm)	A0 (mm)	B0 (mm)	K0 (mm)	P1 (mm)	W (mm)	Pin1 Quadrant
TPS71501QDCKRM3Q1	SC70	DCK	5	3000	178.0	9.0	2.4	2.5	1.2	4.0	8.0	Q3
TPS71501QDCKRQ1	SC70	DCK	5	3000	178.0	9.0	2.4	2.5	1.2	4.0	8.0	Q3
TPS71525QDCKRM3Q1	SC70	DCK	5	3000	178.0	9.0	2.4	2.5	1.2	4.0	8.0	Q3
TPS71525QDCKRQ1	SC70	DCK	5	3000	178.0	9.0	2.4	2.5	1.2	4.0	8.0	Q3
TPS71530QDCKRM3Q1	SC70	DCK	5	3000	178.0	9.0	2.4	2.5	1.2	4.0	8.0	Q3
TPS71533QDCKRM3Q1	SC70	DCK	5	3000	178.0	9.0	2.4	2.5	1.2	4.0	8.0	Q3
TPS71533QDCKRQ1	SC70	DCK	5	3000	178.0	9.0	2.4	2.5	1.2	4.0	8.0	Q3
TPS71550QDCKRM3Q1	SC70	DCK	5	3000	178.0	9.0	2.4	2.5	1.2	4.0	8.0	Q3

**TAPE AND REEL BOX DIMENSIONS**

\*All dimensions are nominal

Device	Package Type	Package Drawing	Pins	SPQ	Length (mm)	Width (mm)	Height (mm)
TPS71501QDCKRM3Q1	SC70	DCK	5	3000	180.0	180.0	18.0
TPS71501QDCKRQ1	SC70	DCK	5	3000	180.0	180.0	18.0
TPS71525QDCKRM3Q1	SC70	DCK	5	3000	180.0	180.0	18.0
TPS71525QDCKRQ1	SC70	DCK	5	3000	340.0	340.0	38.0
TPS71530QDCKRM3Q1	SC70	DCK	5	3000	180.0	180.0	18.0
TPS71533QDCKRM3Q1	SC70	DCK	5	3000	180.0	180.0	18.0
TPS71533QDCKRQ1	SC70	DCK	5	3000	340.0	340.0	38.0
TPS71550QDCKRM3Q1	SC70	DCK	5	3000	180.0	180.0	18.0



# EXAMPLE BOARD LAYOUT

DCK0005A

SOT - 1.1 max height

SMALL OUTLINE TRANSISTOR

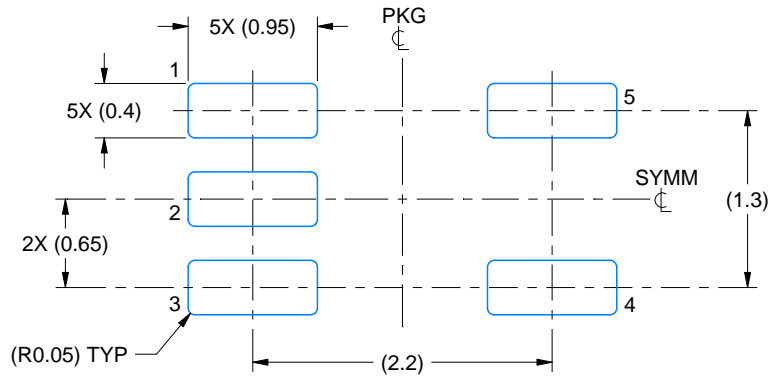

LAND PATTERN EXAMPLE  
EXPOSED METAL SHOWN  
SCALE:18X

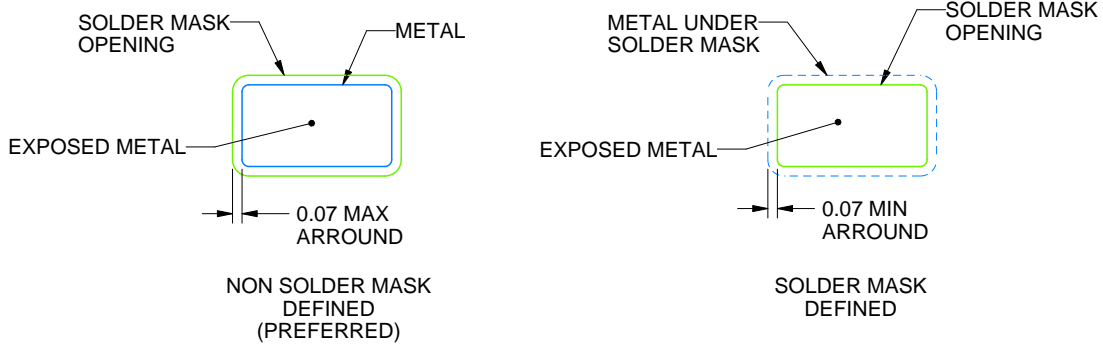

SOLDER MASK DETAILS

4214834/E 06/2024

NOTES: (continued)

- 7. Publication IPC-7351 may have alternate designs.
- 8. Solder mask tolerances between and around signal pads can vary based on board fabrication site.

# EXAMPLE STENCIL DESIGN

DCK0005A

SOT - 1.1 max height

SMALL OUTLINE TRANSISTOR

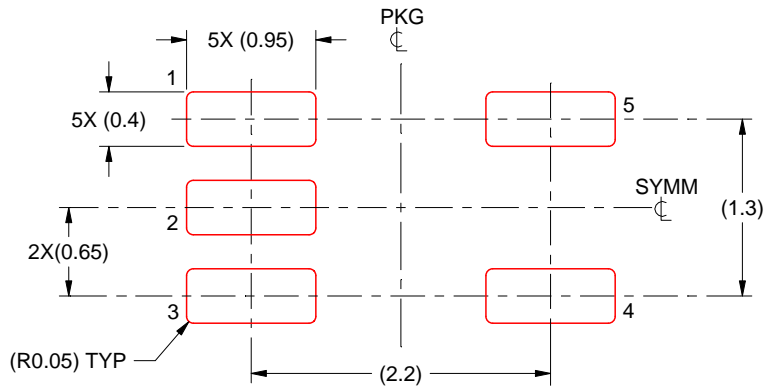

SOLDER PASTE EXAMPLE  
BASED ON 0.125 THICK STENCIL  
SCALE: 18X

4214834/E 06/2024

NOTES: (continued)

9. Laser cutting apertures with trapezoidal walls and rounded corners may offer better paste release. IPC-7525 may have alternate design recommendations.
10. Board assembly site may have different recommendations for stencil design.

## 重要声明和免责声明

TI“按原样”提供技术和可靠性数据（包括数据表）、设计资源（包括参考设计）、应用或其他设计建议、网络工具、安全信息和其他资源，不保证没有瑕疵且不做任何明示或暗示的担保，包括但不限于对适销性、某特定用途方面的适用性或不侵犯任何第三方知识产权的暗示担保。

这些资源可供使用 TI 产品进行设计的熟练开发人员使用。您将自行承担以下全部责任：(1) 针对您的应用选择合适的 TI 产品，(2) 设计、验证并测试您的应用，(3) 确保您的应用满足相应标准以及任何其他功能安全、信息安全、监管或其他要求。

这些资源如有变更，恕不另行通知。TI 授权您仅可将这些资源用于研发本资源所述的 TI 产品的应用。严禁对这些资源进行其他复制或展示。您无权使用任何其他 TI 知识产权或任何第三方知识产权。您应全额赔偿因在这些资源的使用中对 TI 及其代表造成的任何索赔、损害、成本、损失和债务，TI 对此概不负责。

TI 提供的产品受 [TI 的销售条款](#) 或 [ti.com](#) 上其他适用条款/TI 产品随附的其他适用条款的约束。TI 提供这些资源并不会扩展或以其他方式更改 TI 针对 TI 产品发布的适用的担保或担保免责声明。

TI 反对并拒绝您可能提出的任何其他或不同的条款。

邮寄地址：Texas Instruments, Post Office Box 655303, Dallas, Texas 75265  
Copyright © 2024，德州仪器 (TI) 公司