

## TI Designs: TIDA-01570

# 具有目标数据输出的车用 77GHz 雷达模块参考设计



### 说明

该汽车摄像头参考设计提供适用于 76GHz 至 81GHz 雷达传感器模块的完整解决方案。板载电源将汽车蓄电池输入转换为雷达模拟前端 (AFE)、处理器以及带弹性数据传输速率的控制器局域网 (CAN-FD) 收发器所需的电压轨。经过处理后，目标数据经由随附的 CAN-FD 物理层 (PHY) 传输。

### 资源

|                               |       |
|-------------------------------|-------|
| <a href="#">TIDA-01570</a>    | 设计文件夹 |
| <a href="#">AWR1642</a>       | 产品文件夹 |
| <a href="#">LP87702-Q1</a>    | 产品文件夹 |
| <a href="#">TPS7A52-Q1</a>    | 产品文件夹 |
| <a href="#">LM53625-Q1</a>    | 产品文件夹 |
| <a href="#">TCAN1042GV-Q1</a> | 产品文件夹 |



咨询我们的 E2E 专家

### 特性

- 设计经过空间优化，可安装在单块 PCB（约 50mm x 71mm）上
- 电源经过优化，减小了尺寸，提高了效率
- 单芯片 76GHz 至 81GHz 汽车雷达传感器集成了 DSP 和 MCU，经由 CAN-FD 提供目标数据
- 宽输入电压范围，36V 电池外电源电压，最高可支持 42V 电压
- 适用于 ASIL B 的诊断和监控功能应用

### 应用

- [ADAS 雷达系统](#)
- [盲点监测系统 \(BSD\)](#)
- [车道变换辅助系统 \(LCA\)](#)
- [前/后侧向来车警示系统 \(F/RCTA\)](#)
- [自主紧急制动 \(AEB\)](#)
- [自适应巡航控制 \(ACC\)](#)

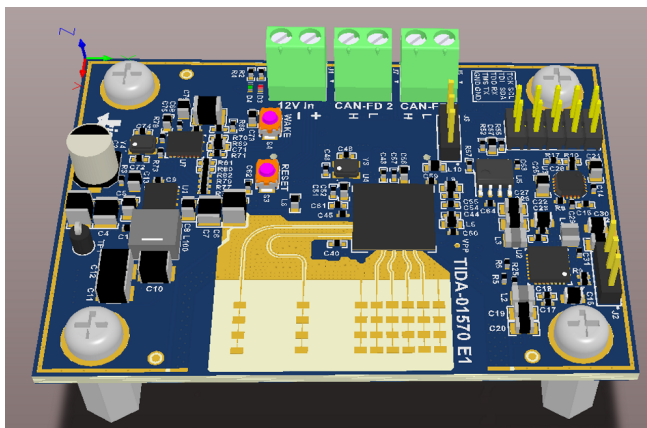
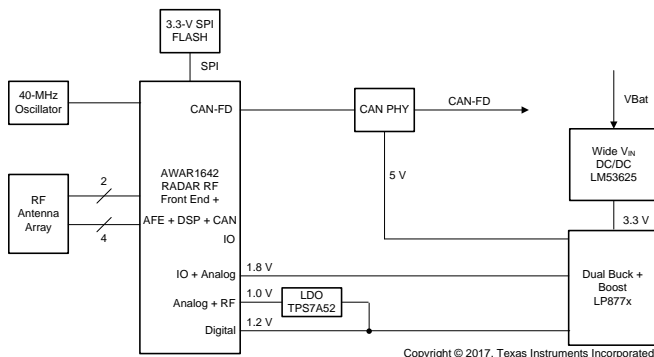

该 TI 参考设计末尾的重要声明表述了授权使用、知识产权问题和其他重要的免责声明和信息。

## 1 System Description

Radar sensors are a requirement for many automotive safety systems. Locating these sensors in bumpers and side mirrors can be difficult. A very small sensor simplifies the process of meeting these market demands and provides a less expensive approach to meet such requirements. This reference design addresses these concerns by combining a single-chip, 76- to 81-GHz automotive radar sensor with a CAN-FD PHY and providing the necessary power supply. All of this functionality is contained on a 50×71-mm circuit board. The only two connections that the system requires are the battery power in and CAN-FD out

The battery power connects to the 12-V input terminal, J1. The wide  $V_{IN}$  buck, LM536253-Q1, is utilized to convert this 12-V input to a 3.3-V output. The LP87702-Q1 then takes the 3.3-V input and creates 5.0-V, 1.8-V, and 1.24-V rails. To ensure a low-noise supply, the TPS7A52-Q1 low-dropout linear regulator (LDO) creates a clean 1-V rail for the radio frequency (RF) section of the radar.

The radar section of this design utilizes a printed-circuit-board (PCB) etched antenna with two transmit elements and four receive elements. By using this antenna, a modulated chirp is transmitted and reflections are sampled into the onboard digital signal processor (DSP). With this information, the sensor can record distance, angle, and velocity measurements from objects within the antenna field of view.

The design offers a feature to write out the object data to a central electronic control unit (ECU) on the CAN-FD bus at a rate of 5 Mb/s.

### 1.1 Key System Specifications

表 1. Key System Specifications

| PARAMETER   |                         | COMMENTS               | MIN | TYP | MAX | UNIT |
|-------------|-------------------------|------------------------|-----|-----|-----|------|
| $V_{IN}$    | Supply voltage          | Battery input          | 4   | 12  | 42  | V    |
| $P_{TOTAL}$ | Total power consumption | $V_{IN} = 12\text{ V}$ | —   | 2.6 | —   | W    |
| CAN-FD      | Data rate               | —                      | —   | —   | 5   | Mb/s |

## 2 System Overview

### 2.1 Block Diagram



图 1. Radar Block Diagram

### 2.2 Highlighted Products

This reference design uses the following TI products:

- **AWR1642-Q1:** This integrated, single-chip frequency-modulated continuous wave (FMCW) radar sensor is capable of operation in the 76- to 81-GHz band. The device is built with TI's low-power 45-nm RFCMOS process and enables unprecedented levels of integration in an extremely-small form factor (SFF). The AWR1642 is an ideal solution for low-power, self-monitored, ultra-accurate radar systems in the automotive space.
- **LP87702-Q1:** This automotive-qualified power device is optimized for radar applications with a dual high-current buck converter and 5-V boost. The high switching frequency of up to 4 MHz allows the use of small inductors and improves system performance because the second harmonic is out of the IF band of the AWR1642 sensor. The LP87702-Q1 includes diagnostics functions such as monitoring of the internal and two external rails, two programmable power-good outputs, and a window watchdog.
- **TPS7A52-Q1:** The TPS7A52-Q1 is an automotive-qualified, low-noise 2-A linear regulator with ultra-low dropout. This linear regulator filters any power supply noise that emanates from the upstream switching supplies while minimizing dissipation through ultra-low dropout operation.
- **LM536253-Q1:** The LM536253-Q1 synchronous buck regulator is optimized for automotive applications and provides an output voltage of 5 V, 3.3 V, or an adjustable output. Advanced high-speed circuitry allows the LM53625-Q1/LM53635-Q1 to regulate from an input of 18 V to an output of 3.3 V at a fixed frequency of 2.1 MHz. Innovative architecture allows this device to regulate a 3.3-V output from an input voltage of only 3.55 V. All aspects of the LM53625-Q1/LM53635-Q1 are optimized for automotive and performance-driven industrial customers. An input voltage range up to 36 V, with transient tolerance up to 42 V, eases input surge protection design.
- **TCAN1042GV-Q1:** This automotive CAN transceiver meets the ISO11898-2 (2016) high speed CAN physical layer standard.

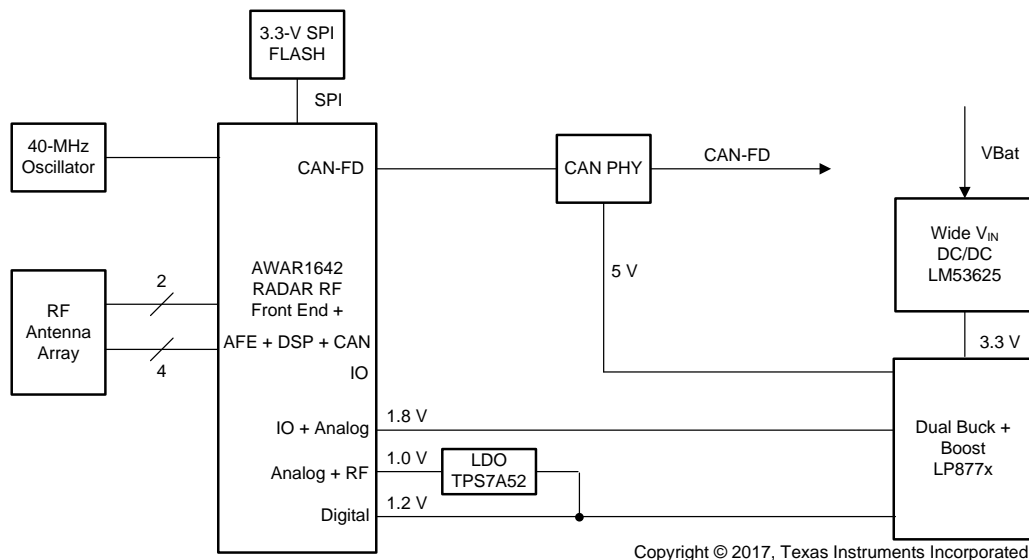
The following subsections provide more information on each device and why they have been chosen for this application.

### 2.2.1 AWR1642-Q1 CMOS RADAR

AWR1642 is a single-chip radar sensor built with four receivers and two transmitters. Built with RFCMOS technology, the device integrates the RF and analog subsystem with the digital subsystem to deliver low power in an SFF for ultra-short-range radar (USRR) and short-range radar (SRR) applications. The device is based on closed-loop phase-locked-loop (PLL) architecture for precise and linear chirp synthesis. The device includes a built-in radio processor (BIST) for RF calibration and safety monitoring. Based on complex baseband architecture, the sensor device supports an intermediate frequency (IF) bandwidth of 5 MHz with reconfigurable output sampling rates. Integration of an ARM® Cortex®-R4F processor and Texas Instruments C674x DSP (fixed and floating point), along with 1.5MB of on-chip RAM, enables high-level algorithm development.

### 2.2.2 LP87702-Q1

The LP87702x-Q1 contains two high-current (up to 3.5 A) buck converters and a 5-V boost for CAN supply. The device supports remote voltage sensing to compensate IR drop between the regulator output and the point-of-load (POL), which improves the accuracy of the output voltage. The device is either controlled by an I<sup>2</sup>C-compatible serial interface, enable signal, or both.

The 4-MHz high-switching frequency of the LP87702D-Q1 allows the use of small inductors and improves system performance by pushing the second harmonic out of the maximum IF band of the AWR1642 device. To further protect the system from electromagnetic interference (EMI), the buck and boost converters are programmed to forced pulse-width modulation (PWM) mode for a fixed switching noise spectrum. When an external clock is provided, the device automatically synchronizes buck and boost clocks to the external clock.

The integrated diagnostic functions of the LP87702D-Q1 help to reduce the radar solution size. The validity of the internal regulator output voltages, 3.3-V input, and two external rails can be monitored through two programmable power-good outputs. The device also includes a window watchdog with programmable open and close times and reset output.

### 2.2.3 TPS7A52-Q1

The combination of low-noise ( $4.4 \mu\text{V}_{\text{RMS}}$ ), high power-supply rejection ratio (PSRR), and high output current capability makes the TPS7A52-Q1 ideal to power noise-sensitive components, such as the RF portion of an automotive radar sensor.

The RF supply rails (1.3 V) can be overridden and supplied with an external 1.0-V voltage regulator; however, this supply must be free of excessive noise, which can be detrimental to system performance. The TPS7A52-Q1 has high PSRR over an extended bandwidth to ensure that any upstream switching noise at or above 1 MHz is attenuated effectively. The TPS7A52-Q1 also has very low levels of intrinsic noise (as low as  $4.4 \mu\text{V}_{\text{RMS}}$ ) through the use of a noise-reduction capacitor. Together, these qualities make this device a good choice to ensure a quiet power supply.

Additionally, this device is capable of low dropout operation with the use of a higher bias rail. Use of this rail limits the minimal power dissipated across the LDO that typically heats up the board and surrounding components. Rather than dissipate power with the internal LDO from 1.3 V to 1.0 V, using the TPS7A52-Q1 enables a 1.2-V to 1.0-V conversion and cuts the dissipation by 33%.

### 2.2.4 LM536253-Q1

The LM536253-Q1 is designed to support a smaller solution size and run at cooler temperatures in a application, which is a combination of package technology and higher overall efficiency in operation. Using several techniques to minimize switch noise and minimized parasitic impedance, this device offers low noise emission which helps to lower system electromagnetic compatibility (EMC) and assist with the ease of design. The DC/DC converter is optimized for out-of-standard regulation conditions, which can either be fault conditions or normal operation (like cold crank and load dump). The LM536253-Q1 offers the full capability to assist front-end automotive power supply designs.

### 2.2.5 TCAN1042GV-Q1

This automotive CAN transceiver meets the ISO11898-2 (2016) high-speed CAN physical layer standard. This PHY has a low power standby mode with remote wake request and many protection features to enhance device and network robustness. This PHY was chosen for its simplicity and small size.

## 2.3 Design Considerations

### 2.3.1 PCB and Form Factor

This reference design is not intended to fit any particular form-factor. The only goal of the design with regards to the PCB is to make a compact solution that serves as a fully-featured automotive radar sensor. With the mounting holes, the board measures roughly 50 mm × 71 mm (2 in × 2.8 in). [图 2](#) and [图 3](#) show the top view and bottom view of the PCB.



图 2. PCB Top View



图 3. PCB Bottom View

## 2.3.2 Power Supply Topology

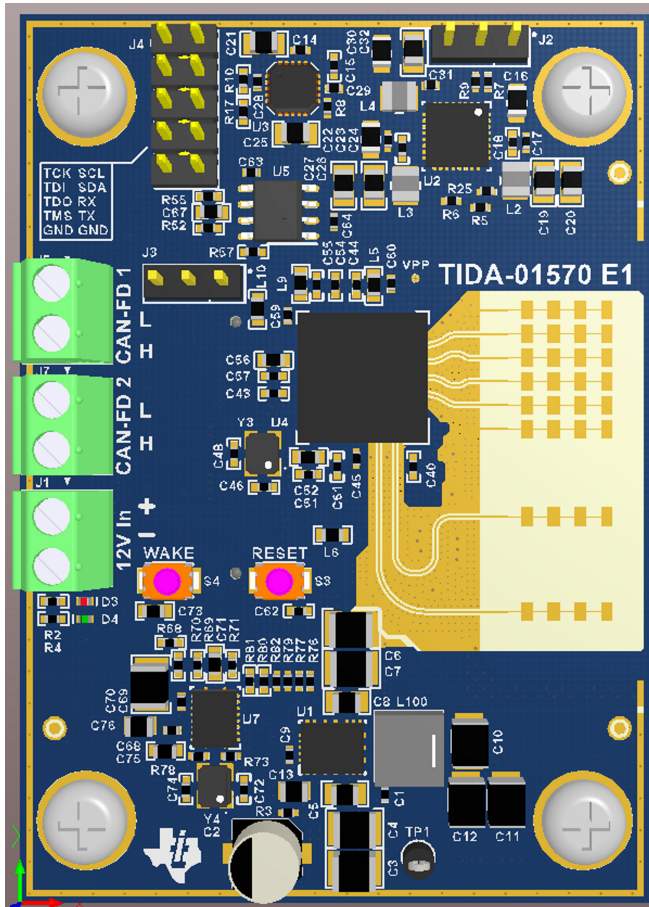
As the previous [图 1](#) shows, the radar sensor reference design is intended to connect directly to the vehicle battery. The voltages required for the design are:

- 5 V for CAN-FD PHY
- 3.3 V for radar I/O
- 1.8 V for radar analog, RF, VCO, and CMOS
- 1.2 V for radar digital and SRAM
- 1 V or 1.3 V for radar analog and RF

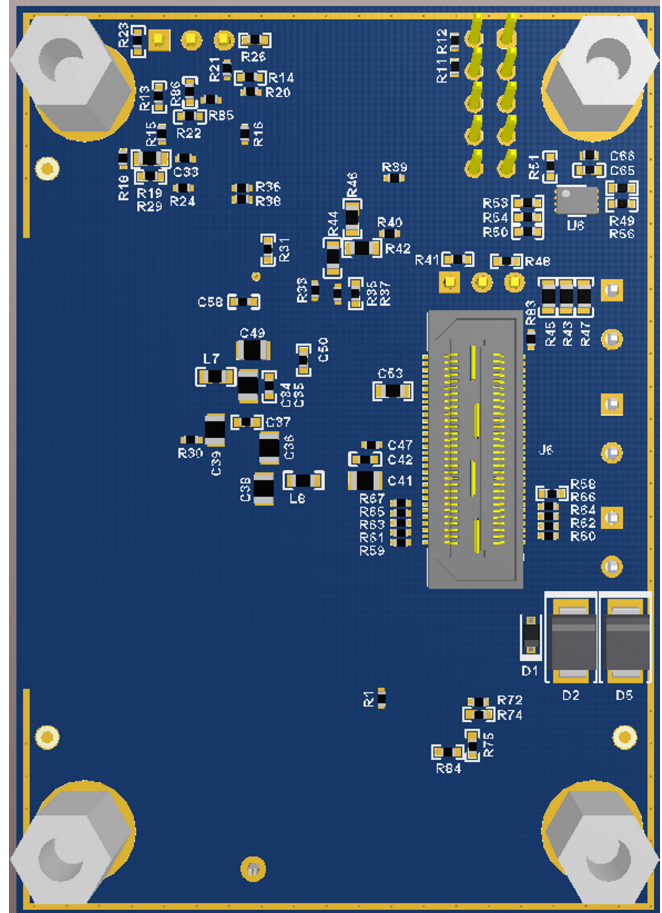
An automotive battery supplies the power input to this sensor; therefore, the design requires a wide  $V_{IN}$  buck that can tolerate up to 40 V as the first stage of the power supply. Use a multi-rail power supply, which has been specifically designed for this application, to create the 5-V, 1.8-V, and 1.2-V rails. The designer has the option to provide the radar analog and RF supply as a 1.3-V input to the LDO inside the AWR1642 device. Another option is to directly supply the radar analog and RF supply as a low noise 1-V rail. The latter option reduces the power dissipated by the AWR1642 device. This option may also reduce the total system power, depending on the system architecture. For this design, supply the radar analog and RF supply externally with a low-noise LDO. By raising the 1.2-V rail to 1.24 V, enough headroom becomes available to cover the dropout on the LDO that produces the 1-V output. This action also reduces the power dissipated in the LDO by using 1.24 V as the input to the LDO, rather than the next higher voltage rail, 1.8 V.

### 2.3.2.1 AWR1642 Power Supply Considerations

The AWR1642 device utilizes four power rails for its operation: a 1.2-V digital supply, 3.3-V IO supply, 1.8-V analog supply, and 1-V RF supply. [表 2](#) lists the peak currents on each of the rails. The average current consumption depends on the chirp profile and frame configuration used; for example, a 1Tx, 4Rx use case with a 50% duty cycle and DSP processing consumes approximately 1.9 W of average power.

**表 2. Power Rail Current Requirements**

| POWER RAIL | PEAK CURRENT                              |
|------------|---|
| 1.2 V      | 1000 mA                                   |
| 1.8 V      | 850 mA                                    |
| 1 V        | 2000 mA                                   |
| 3.3 V      | Depends on the interfaces used on AWR1642 |

In a case where the 1-V supply is derived from the 1.2 V using a regulator (such as in this reference design), the 1.2 V (1.24 V) of available current must include both 1.2-V and 1-V rail currents. [图 4](#) shows a block diagram of the AWR1642 power supply filters.

One of the key concerns when using the switching regulators for the power supply is to prevent the switching frequency of the regulator from coupling onto the analog circuitry through the supply or ground. At a 4-MHz switching frequency, the AWR1642 can tolerate approximately  $35.5\text{-}\mu\text{V}_{\text{RMS}}$  ripple on the 1.8-V supply to keep the spur in the RX spectrum of less than  $-120\text{ dBm}$  (at the LNA input). The following steps offer ways to reduce the supply ripple level:

- Use LC filtering on the analog and RF supplies (1.8 V and 1 V).
- Some of the output voltage ripple of a switching buck regulator is caused by the inductor ripple current charging and discharging the output capacitor. Minimize this inductor ripple current by using a high



switching frequency, in this case 4 MHz. The recommended inductance for LP87702-Q1 buck regulators is 0.47  $\mu$ H.

- A higher output capacitance reduces the output voltage ripple and also improves load step behavior. Use ceramic capacitors with low to minimize ripple. The  $R_{ESR}$  is frequency dependent (as well as temperature dependent); make sure the value used for the selection process is at the switching frequency. Use the point-of-load capacitors to further decrease the ripple voltage and improve load transient performance.

- Use the LC filter to continue filtering the output from the regulator. Place a series ferrite bead on the supply path, along with the decoupling capacitors of the supply, so that they can act as an LC filter to reduce the ripple amplitude. Choose the values such that the corner frequency of the LC filter is much lower than the switching frequency. For example, in this design, the LP87702 switches at a 4-MHz frequency. The LC filter is designed with the part number BLM18KG121TH1 to provide a cutoff frequency of approximately 120 KHz with the decoupling capacitors on the 1.8-V supply rail.

注: The IR drop across the inductor must be kept as low as possible, for which TI recommends a very-low DC resistance inductor. From the data sheet, the BLM18KG121TH1 has a data capture record (DCR) of 25 mΩ.

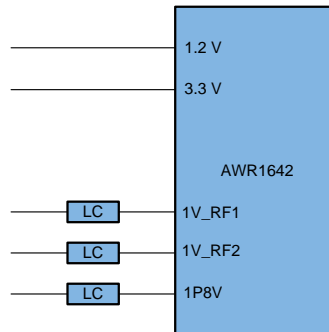

Copyright © 2017, Texas Instruments Incorporated

图 4. AWR1642 Power Supply Filters

- By providing ground cuts, the designer can reduce the interference of the switching currents for the regulator and the analog currents on the AWR1642 device (see 图 5). The circuits most vulnerable to ripple are the XTAL lines, VOUT\_14SYNTH, VOUT\_14APLL, VIN\_18VCLK, and VIN\_18VCO supplies.



图 5. Cuts in Layer 2 Ground Plane

### 2.3.2.1.1 Wide $V_{IN}$ Buck

Under start-stop or cold-crank conditions, the voltage can drop quite dramatically—and to a level that causes the buck converter to go out of regulation. Some instances may require the designer to use a boost converter in the circuit to assist the system. If designing the power supply to support sudden voltage drops, the designer may be able to account for the cost of the boost, as well as the cost, space, and power consumption associated with the additional components.

A combination of a nearly 100% duty cycle, very-short minimum OFF-time, and a low  $R_{DS(ON)}$  high-side field-effect transistor (FET) resistance enables the power supply to support a deep dropout of less than 0.6 V under a full load and full operating temperature range, all while maintaining regulation for downstream power supplies without adding additional design complexity. This feat is made possible by using the LM53625-Q1 under typical and extreme conditions in an automotive system.

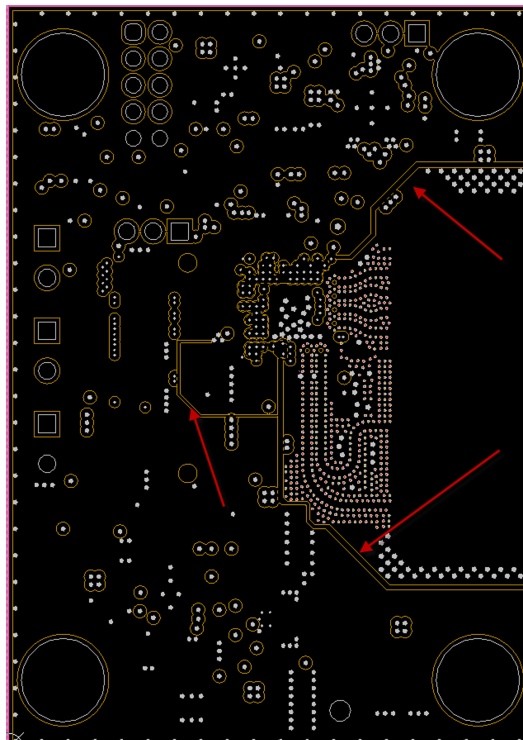
Maintaining regulation and stopping the power supply from becoming unstable is critical in automotive power supplies around the minimum drop-out and high  $V_{IN}$  conditions. System-related conditions like cold crank or even load dump from faulty alternators can affect the regulation and output power. Support for low dropout requires that the device output does not oscillate. This oscillation would translate into high-frequency noise and can cause disturbances elsewhere in the system. The LM53625-Q1 is used here because it is designed to support very-low  $T_{MIN-ON}$  and  $T_{MIN-OFF}$  conditions. Stable control of the power supply is critical and smooth operation into and out of a desired regulation range is required, as this controls the noise that is generated.

### 2.3.2.1.2 Reducing EMI

The selection of available, low EMI power supplies is increasingly important due to many factors, including the progressively complex wire harnesses used in automobiles and the number of ECU nodes to add to the system. Each harness wire and each ECU has the ability to create noise that can be transmitted around the automobile and affect other applications. Given the increasing number of safety applications, the ability to offer low EMI is highly desirable. Several techniques can be used in the design of the power supply to minimize EMI.

One technique to lower the EMI is to choose a converter in a package that is optimized for layout placement and positioning of the passive components used in regulation and filtering. LM53625-Q1 uses a pinout that offers symmetrical placement of the high-frequency input capacitors, which are grounded on either side of the switch node. This placement creates reduced inductance between ground (GND) and the switch, which cancels any noise.

Additionally, by constructing the package in a certain manner, the designer can remove the parasitic loop inductance and capacitance inside the package and reduce the switch-node ringing, which is a major contributor to noise generation. The general idea is to reduce the noise at the source to avoid any problems caused by additional components. The LM53625-Q1 uses a flip chip package construction that removes the bond wires, which can, in some instances, add to the noise and degrade dropout and efficiency.

Another technique for reducing noise in the system is spread-spectrum technology, which modulates the central switching frequency and suppresses the harmonics and sub-harmonics. Spread-spectrum is very effective for reducing the overall noise peaks, but does not influence the noise floor due to the spreading of the noise, as the name suggests. However, because spread-spectrum helps with high-frequency harmonics, it can help meet the stringent original equipment manufacturer (OEM) standards for EMI, simplify printed-circuit board (PCB) designs, and reduce filtering component size and cost. The LM53625-Q1 offers a version with and without spread spectrum to provide flexible options to the customer across multiple designs and systems.

### 2.3.2.1.3 Antenna

This reference design includes onboard-etched antennas for the four receivers and two transmitters that enable tracking multiple objects with their distance and angle information. This antenna design utilizes the estimation of distance and elevation angle, which, in turn, enables object detection in a two-dimensional plane. 图 6 和 图 7 show the PCB antennas.



图 6. Altium Antenna Design



图 7. Antenna as Appears on PCB

The antenna peak gain is greater than 9 dBi across the operating frequency band of 76 GHz to 81 GHz. The peak output power with the antenna gain is less than 55 dBm equivalent isotropically radiated power (EIRP), as required by the European regulations. 图 8 shows the radiation pattern of the antenna in the horizontal plane (H-plane  $\Phi = 0^\circ$ ) and elevation plane (E-plane  $\Phi = 90^\circ$ ).

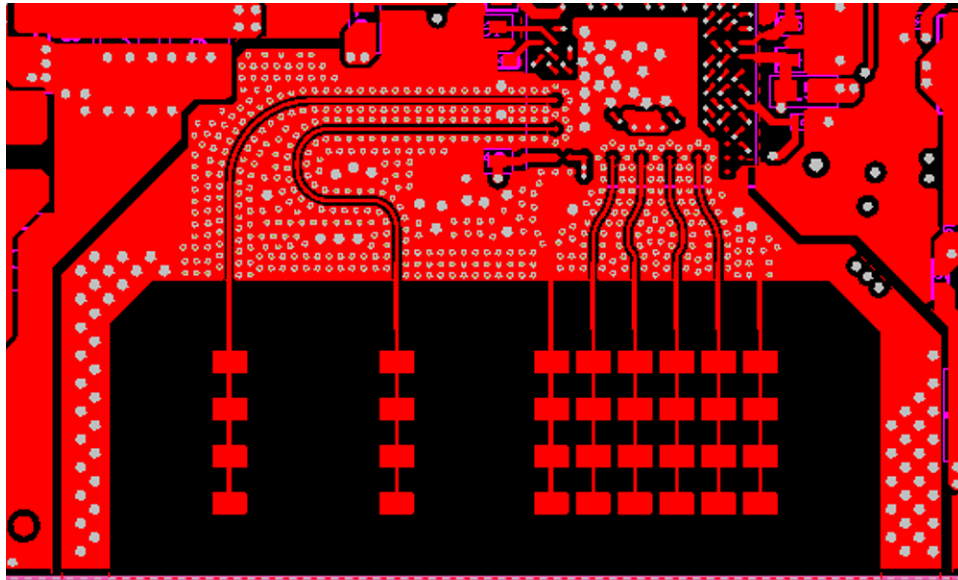

图 8. Antenna Pattern

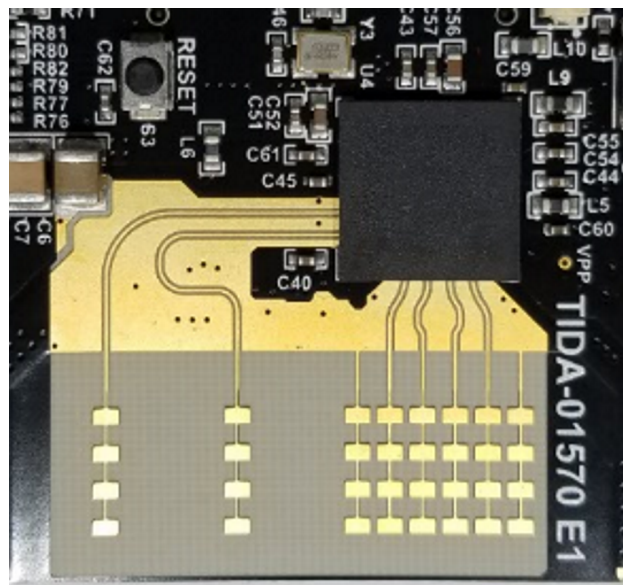
#### 2.3.2.1.4 CAN Termination

The ISO 11898 standard specifies the interconnect as a twisted pair cable (shielded or unshielded) with 120-Ω characteristic impedance ( $Z_0$ ). Resistors equal to the characteristic impedance of the line must be used to terminate both ends of the cable to prevent signal reflections. Unterminated drop lines (stubs) connecting nodes to the bus must be kept as short as possible to minimize signal reflections. The termination may be on the cable or in a node, but if nodes may be removed from the bus, the termination must be carefully placed so that two terminations always exist on the network. Termination may be a single 120-Ω resistor at the end of the bus, either on the cable or in a terminating node. If the designer wishes to filter and stabilize the common-mode voltage of the bus, then split termination may be used (see 图 9). Split termination improves the electromagnetic emissions behavior of the network.

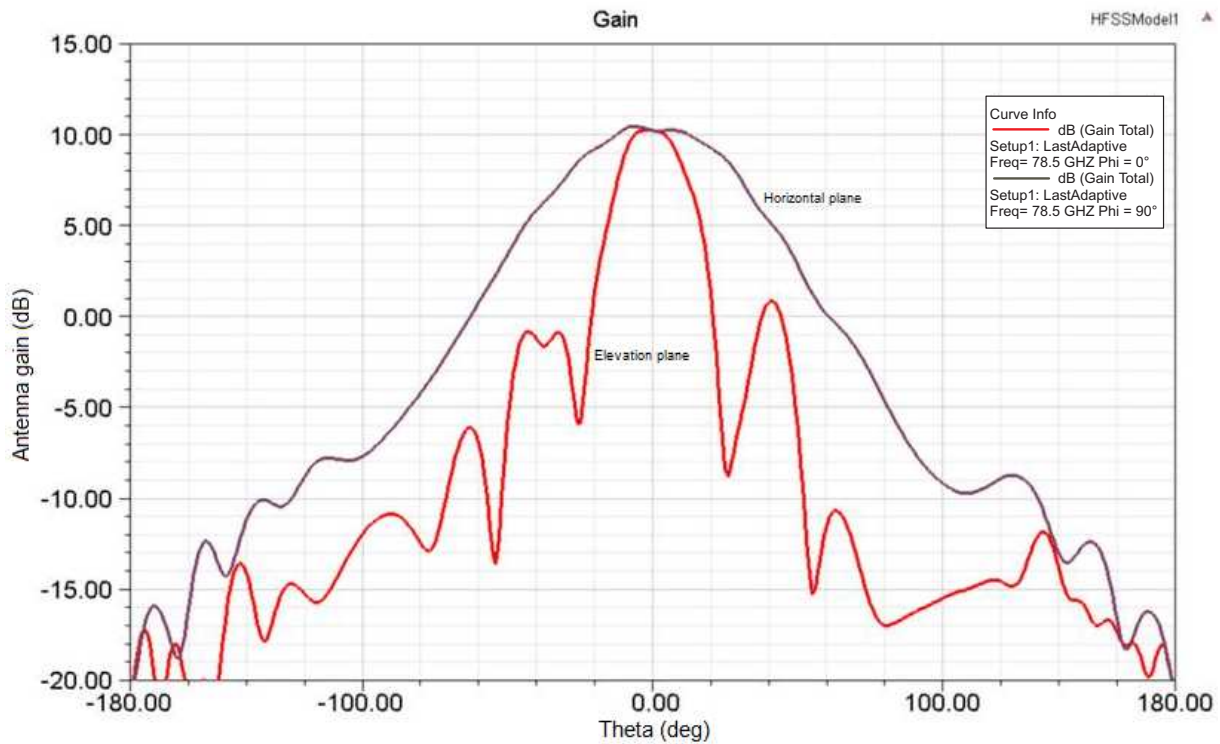
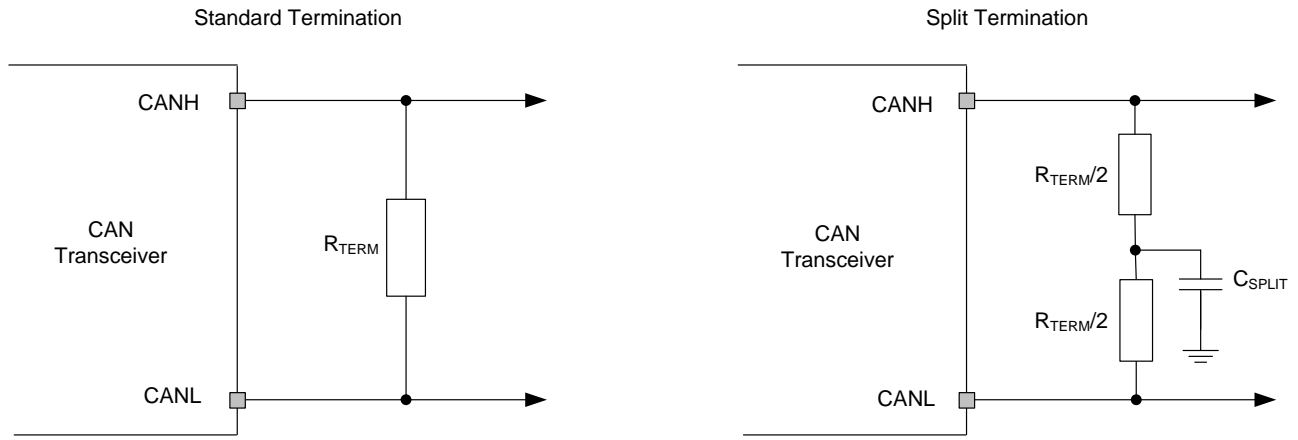

Copyright © 2016, Texas Instruments Incorporated

**图 9. CAN Bus Termination Concepts**

### 3 Getting Started Hardware

Connect the TIDA-01570 reference design to a 12-V nominal "battery" supply using the screw terminals on J1 (see [图 10](#)). The object data output is available on the CAN-FD signals on J5.

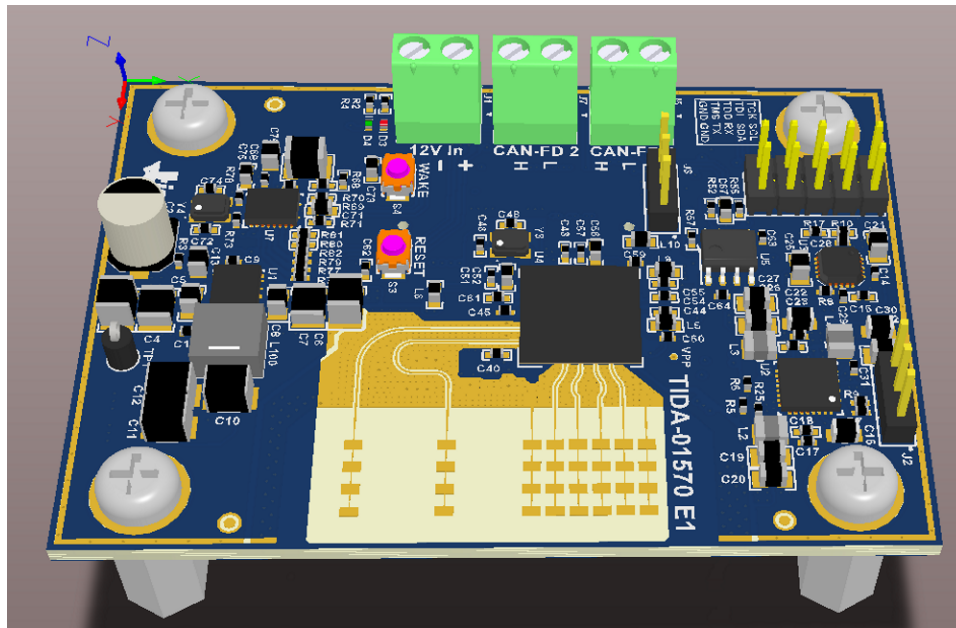

**图 10. Getting Started With Board**

#### 3.1 AWR1642 Initialization: Board Programming

Now that the board is powered with the 12-V connection, a program must be loaded into the FLASH. This program executes each time the board boots and the AWR16 is released from RESET. TI provides a mmWave Software Development Kit (SDK). This SDK is a unified software platform for the AWR1x family of mmWave sensors, which enable evaluation and development. The use of this design environment is covered in the documentation for the mmWave SDK: [MMWAVE-DEVPACK](#) and [MMWave Demo Visualizer User's Guide](#). The following procedure is for loading a binary file.

- Use UniFlash with an FTDI cable to load the program.
- During the following procedure, the AWR1642 universal asynchronous receiver/transmitter (UART) RX/TX pins are connected to the PC through a USB cable using an FTDI cable. The specific cable used is the UART to USB: TTL-232R-RPI CABLE USB-SERIAL RASPBERRYPI. Be sure to install the correct PC drivers for the selected USB and UART cables.
- Install the UniFlash software, which is available for download at: <http://www.ti.com/tool/uniflash>. Proceed to the next step after installation.
- Move or install the jumper on J3, as [图 11](#) shows. This action puts the AWR16 device into "flash" mode. Connect the black (GND), yellow (RX), and orange (TX) wires of the FTDI cable to J4.





图 11. FTDI Cable Connection and J3 Setting

- Open the UniFlash software. Select *mmWave* from the *Category* header, select *AWR1642* from the field of available devices, and then click the *Start* button (see 图 12).

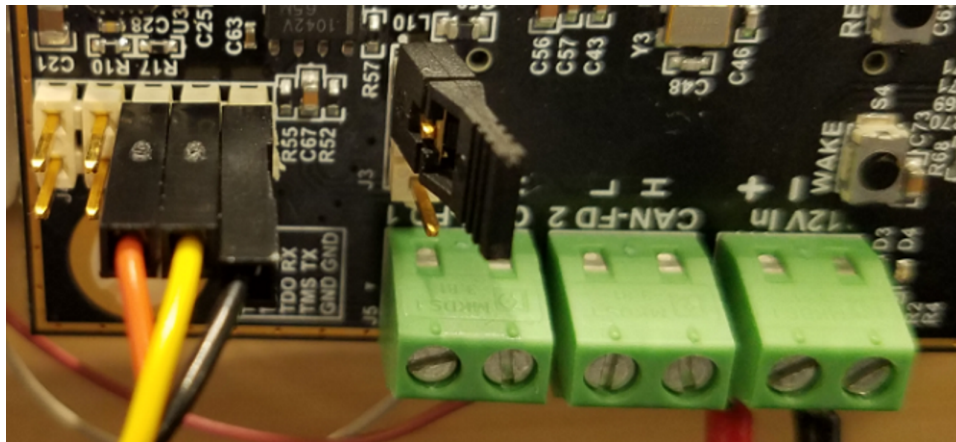

图 12. Uniflash Configuration

- Next, click the *Browse* button and navigate to the binary file to load. After the name of the file populates the field, click on the *Settings & Utilities* menu on the left side of the program (see 图 13).

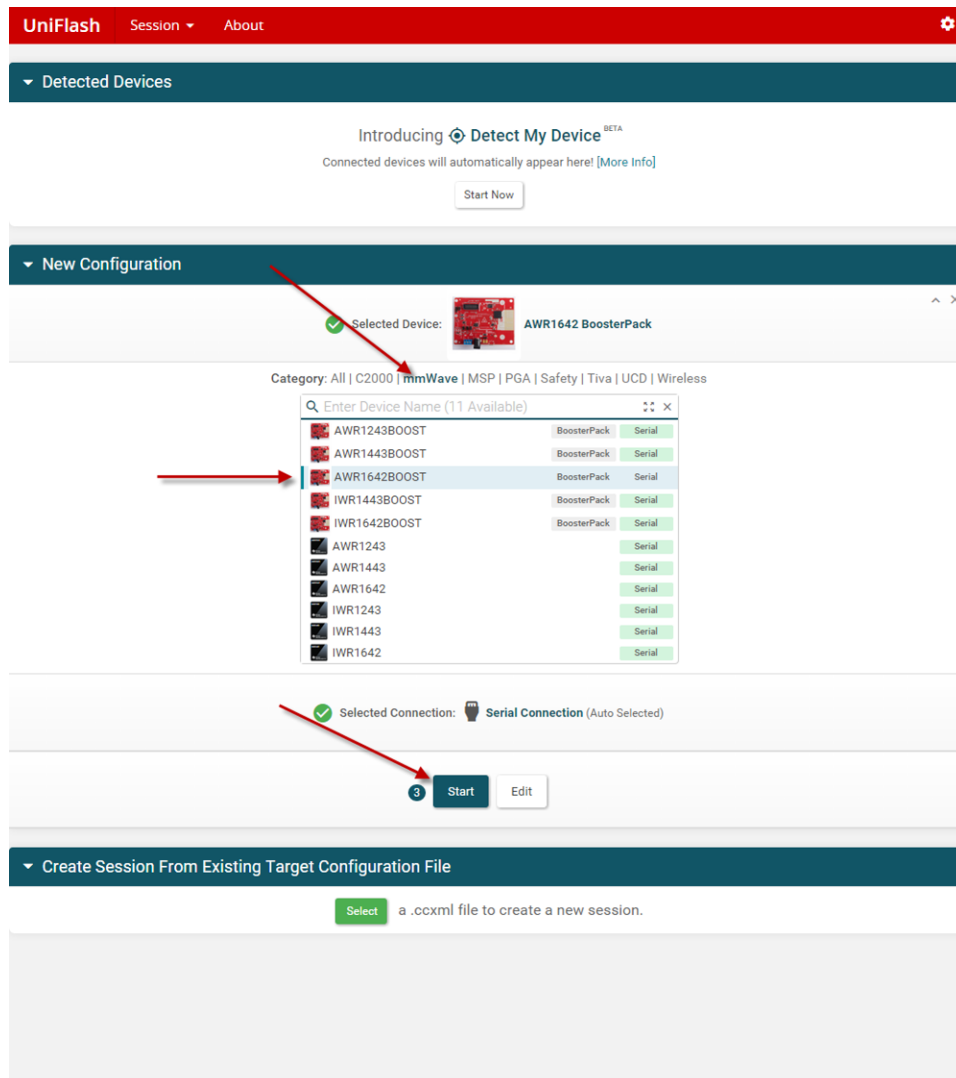

图 13. Uniflash Settings

- Now determine which COM port to use. After plugging the FTDI cable into a USB port, open up Windows Device Manager. Find the USB serial port and note which COM port is used to connect to the FTDI. The example in 图 14 shows this COM port to be COM3.

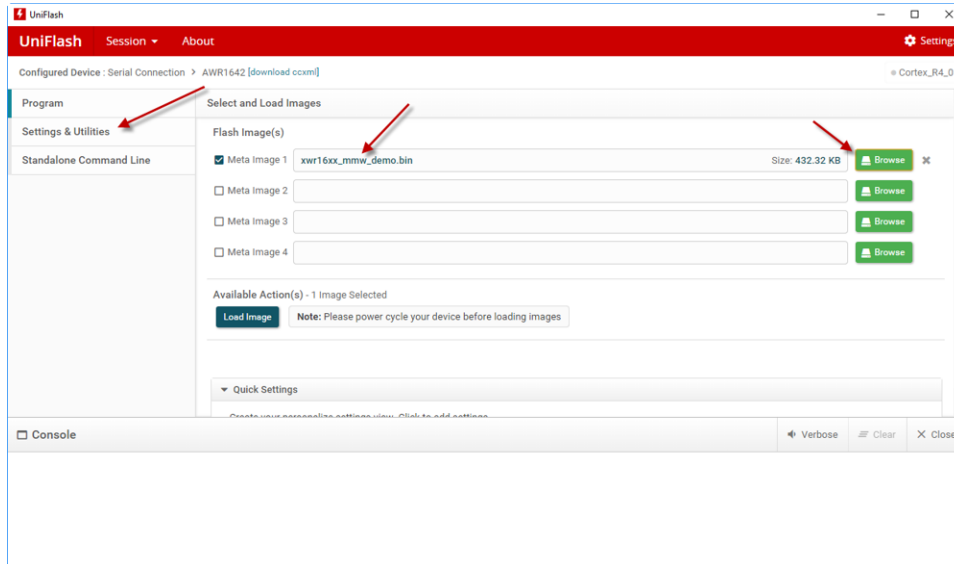

图 14. Determine COM Port

- Return to the UniFlash software and enter the COM port from the device manager. Then click the *Program* menu on the left side of the window to go back to the previous menu (see 图 15).

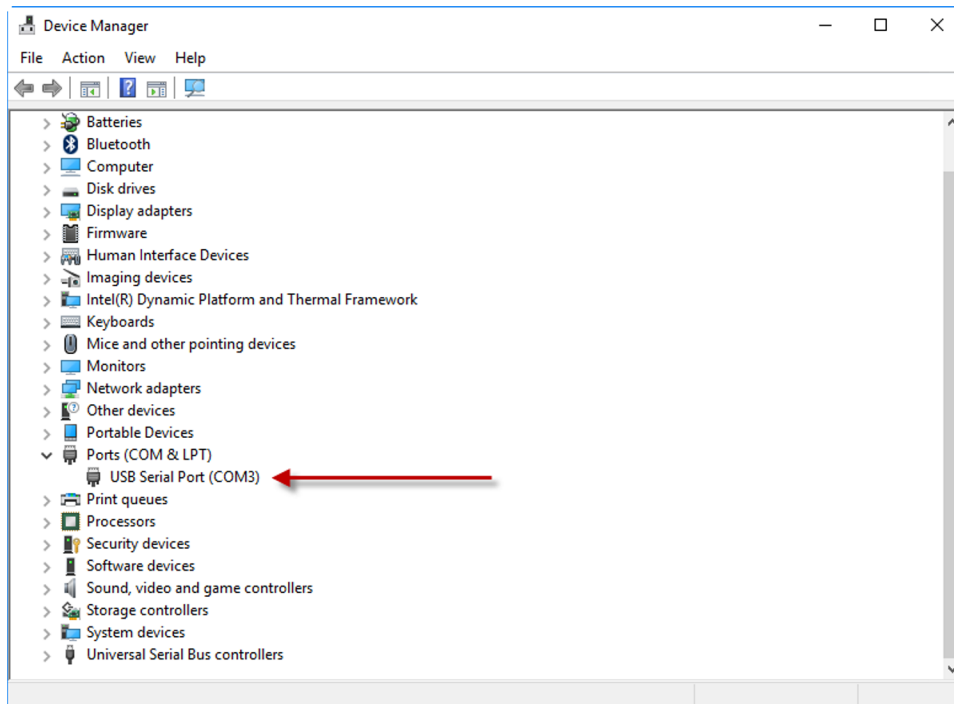

图 15. Enter COM Port

- Reset the ASR16 device by pressing the reset button on the board (S3). Then select *Load Image*. This action loads the program into the FLASH. To execute the program, move the jumper on J4 back to the pin 2/3 position and press the reset button. The program then runs. Note that the board draws more current from the 12-V supply.

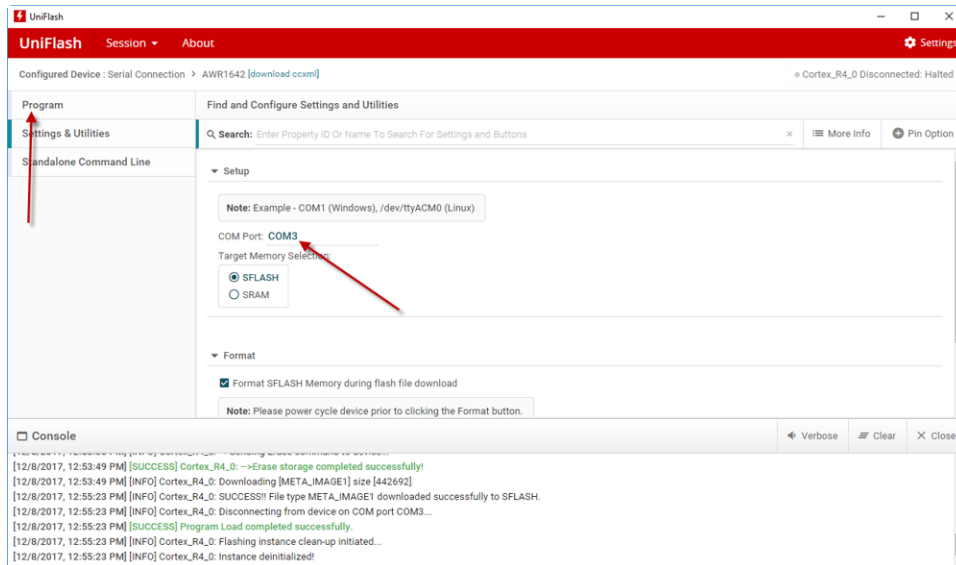

图 16. Load Image

### 3.2 Sense-on-Power (SOP) Jumpers

As the previous [图 11](#) shows, the J3 jumper is used to configure the device into FLASH programming mode. Two additional resistor dividers are used to configure the AWR1642 device at start-up. These SOP configuration options are shown at the bottom of sheet 2 of the schematic (available for download in [Schematics](#)). These lines are sensed only during boot up of the AWR device. [表 3](#) provides a description of the SOP modes. A "0" represents pulling the pin low and a "1" represents pulling the pin high.

**表 3. SOP Modes**

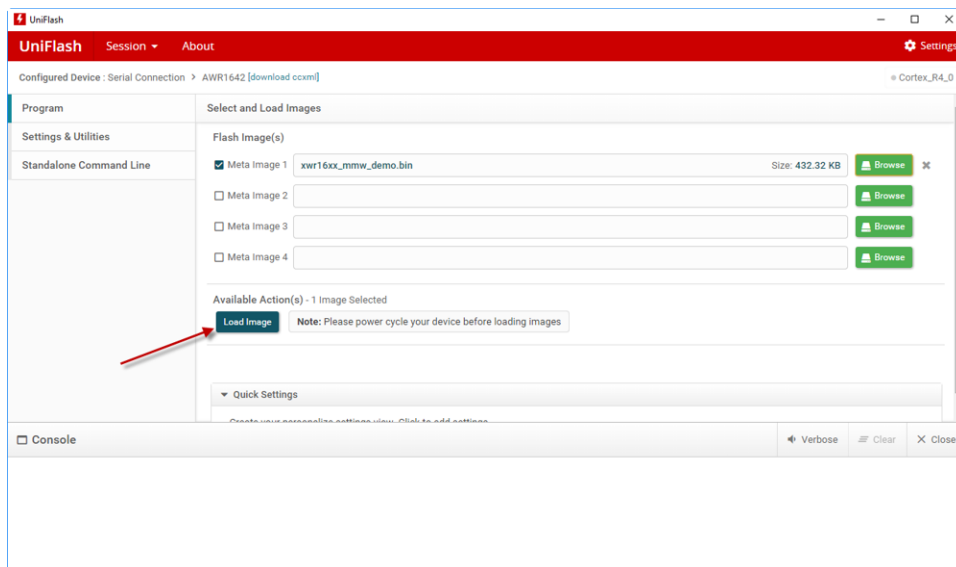
| MODE | SOP2 | SOP1 | SOP0 | MODE DESCRIPTION   |
|------|------|------|------|--|
| 1    | 0    | 0    | 1    | Functional mode: The device bootloader loads the user application from the QSPI serial flash to the internal RAM and switches the control to it. |
| 3    | 0    | 1    | 1    | Debug mode: The bootloader is bypassed and the R4F processor is halted, which allows the user to connect the emulator at a known point.          |
| 5    | 1    | 0    | 1    | Flashing mode: The device bootloader spins in a loop to allow flashing of the user application (or the device firmware patch, supplied by TI).   |

## 4 Testing and Results

### 4.1 Characterization Test Setup

TI has developed a PC application, TI CAN VISUALIZER, for use in demonstrating the performance of the TIDA-01570 radar sensor module. 图 17 shows a screenshot of the setup for using this application. The PC can control the module over the UART on pins N4 and N5 of the AWR1642 device. These pins are connected to pins 6 and 8 of the J4 connector. For the following examples, this UART is connected to the PC through a USB, using a FTDI cable. The CAN-FD output from the module is read into the PC using a CAN-FD to USB translator. The specific modules used here are:

- UART to USB: TTL-232R-RPI CABLE USB-SERIAL RASPBERRYPI
- CAN-FD to USB: PCAN-USB FD Adapter, IPEH-004022

To use the CAN-FD to USB adapter, connect the CAN 1\_HI and CAN1\_LOW pins on J5 to the appropriate pins on the adapter connector. After establishing this connection, start the PC program *PCANBasicExample.exe*. 图 17 shows the TI CAN VISUALIZER user interface. Click the *Initialize* button to begin logging the CAN data.



图 17. TI CAN VISUALIZER Start-Up

The object data that the CAN bus sends begins scrolling in the large white box (see 图 18). The blue dots in the scatter plot represent the object information in graphical form.

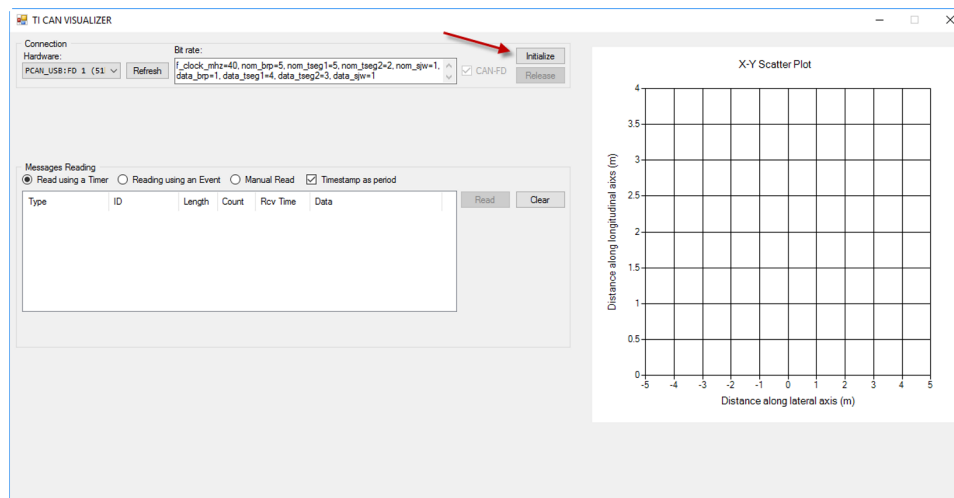

图 18. TI CAN VISUALIZER Running

## 5 Design Files

### 5.1 Schematics

To download the schematics, see the design files at [TIDA-01570](#).

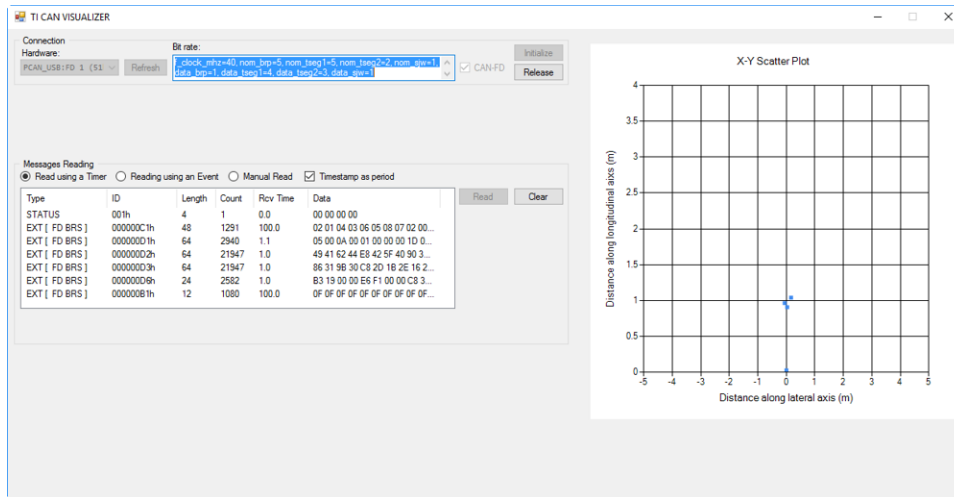
### 5.2 Bill of Materials

To download the bill of materials (BOM), see the design files at [TIDA-01570](#).

### 5.3 PCB Layout Recommendations

#### 5.3.1 Switching DC-DC Converters

For optimal layout during placement and routing, be sure to always consider the path the current takes through the circuit.

For the main 3.3-V buck converter:

The yellow line in [图 19](#) shows the current path from the bulk input capacitor C2, across the ceramic input capacitors C3 and C4, and into the converter U1 or LM536253-Q1. The green line follows the 3.3-V output of the switcher to the output inductor L100 and output capacitors C10, C11, and C12. [图 19](#) shows how any return currents from the input capacitors or the output capacitor are joined together on the top layer and connected to the ground plane. This configuration allows much of the capacitor currents to cancel each other out in layer 1 and reduces the amount of return currents traveling in the internal ground planes, which, in turn, reduces voltage gradients in the ground plane that register as noise to other components. This optimization may not be noticeable in the performance of the converter, but it will reduce its coupled noise into other devices.



图 19. Current Paths Through Switching Converter



### 5.3.2 PCB Layer Stackup Recommendations

A normal FR4 board material results in unacceptable losses for the 77-GHz antenna included in the top two layers of this design. This design uses ceramic material from Rogers Corporation to meet the dielectric requirements. Additionally, the RO4000® LoPro® series of laminates from Rogers Corporation uses a reverse-treated foil for a smoother metal. This selection of material results in a lower variation in etched-feature dimensions. With wavelengths of less than 4 mm, these tolerances are very important.

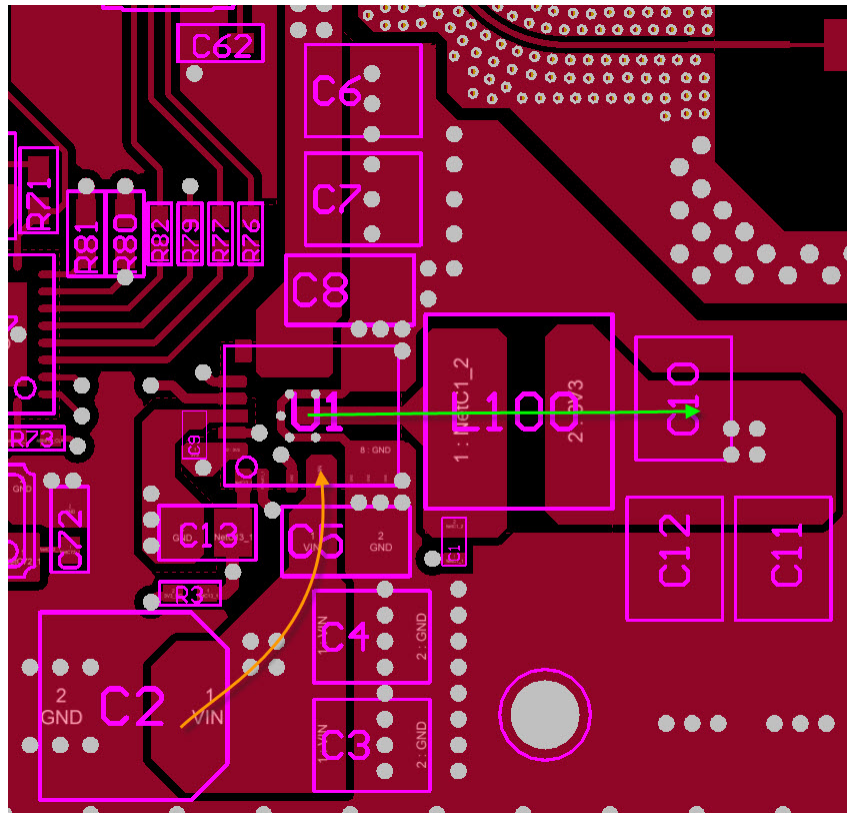
图 20 shows the PCB layer stackup recommendations.

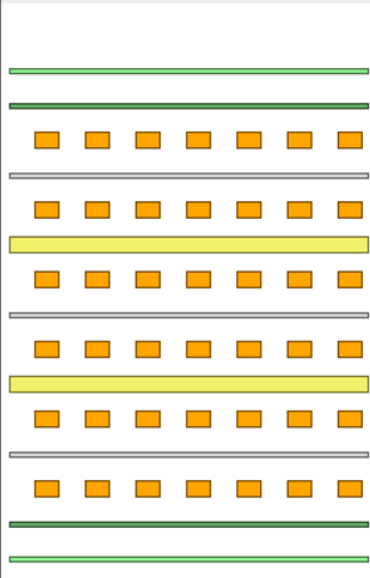

| Layer Name           | Type              | Material         | Thickness (mil) | Dielectric Material | Dielectric Constant |
|----------------------|-------------------|------------------|-----------------|---------------------|---------------------|
| Top Overlay          | Overlay           |                  |                 |                     |                     |
| Top Solder           | Solder Mask/Co... | Surface Material | 0.4             | Solder Resist       | 3.5                 |
| Layer 1 - Top Lay... | Signal            | Copper           | 1.4             |                     |                     |
| Dielectric 1         | Dielectric        | Prepreg          | 12.6            | 370HR               | 4.2                 |
| Layer 2 - GND        | Signal            | Copper           | 1.4             |                     |                     |
| Dielectric 2         | Dielectric        | Core             | 8               | 370HR               | 4.2                 |
| Layer 3 - Signal     | Signal            | Copper           | 1.417           |                     |                     |
| Dielectric 3         | Dielectric        | Prepreg          | 16.6            | 370HR               | 4.2                 |
| Layer 4 - Signal     | Signal            | Copper           | 1.417           |                     |                     |
| Dielectric 4         | Dielectric        | Core             | 8               | 370HR               | 4.2                 |
| Layer 5 - PWR        | Signal            | Copper           | 1.4             |                     |                     |
| Dielectric 5         | Dielectric        | Prepreg          | 12.6            | 370HR               | 4.2                 |
| Layer 6 - Bottom...  | Signal            | Copper           | 1.4             |                     |                     |
| Bottom Solder        | Solder Mask/Co... | Surface Material | 0.4             | Solder Resist       | 3.5                 |
| Bottom Overlay       | Overlay           |                  |                 |                     |                     |

图 20. Layer Stackup

### 5.3.3 Layout Prints

To download the layer plots, see the design files at [TIDA-01570](#).

### 5.4 Altium Project

To download the Altium project files, see the design files at [TIDA-01570](#).

### 5.5 Gerber Files

To download the Gerber files, see the design files at [TIDA-01570](#).

## 6 Related Documentation

1. Texas Instruments, [Moving from legacy 24 GHz to state-of-the-art 77 GHz radar](#)
2. Texas Instruments, [Short-Range Radar \(SRR\) Reference Design Using AWR1642](#)
3. Texas Instruments, [AWR1642 mmWave sensor: 76-81-GHz radar-on-chip for short-range radar applications](#)
4. Texas Instruments, [TI's smart sensors ideal for automated driving applications](#)
5. Texas Instruments, [The fundamentals of millimeter wave sensors](#)

## 6.1 商标

ARM, Cortex are registered trademarks of ARM Ltd.  
RO4000, LoPro are registered trademarks of Rogers Corporation.  
All other trademarks are the property of their respective owners.

## 有关 TI 设计信息和资源的重要通知

德州仪器 (TI) 公司提供的技术、应用或其他设计建议、服务或信息，包括但不限于与评估模块有关的参考设计和材料（总称“TI 资源”），旨在帮助设计人员开发整合了 TI 产品的应用；如果您（个人，或如果是代表贵公司，则为贵公司）以任何方式下载、访问或使用了任何特定的 TI 资源，即表示贵方同意仅为该等目标，按照本通知的条款进行使用。

TI 所提供的 TI 资源，并未扩大或以其他方式修改 TI 对 TI 产品的公开适用的质保及质保免责声明；也未导致 TI 承担任何额外的义务或责任。TI 有权对其 TI 资源进行纠正、增强、改进和其他修改。

您理解并同意，在设计应用时应自行实施独立的分析、评价和判断，且应全权负责并确保应用的安全性，以及您的应用（包括应用中使用的 TI 产品）应符合所有适用的法律法规及其他相关要求。您就您的应用声明，您具备制订和实施下列保障措施所需的一切必要专业知识，能够 (1) 预见故障的危险后果，(2) 监视故障及其后果，以及 (3) 降低可能导致危险的故障几率并采取适当措施。您同意，在使用或分发包含 TI 产品的任何应用前，您将彻底测试该等应用和该等应用所用 TI 产品的功能而设计。除特定 TI 资源的公开文档中明确列出的测试外，TI 未进行任何其他测试。

您只有在为开发包含该等 TI 资源所列 TI 产品的应用时，才被授权使用、复制和修改任何相关单项 TI 资源。但并未依据禁止反言原则或其他法律授予您任何 TI 知识产权的任何其他明示或默示的许可，也未授予您 TI 或第三方的任何技术或知识产权的许可，该等许可包括但不限于任何专利权、版权、屏蔽作品权或与使用 TI 产品或服务的任何整合、机器制作、流程相关的其他知识产权。涉及或参考了第三方产品或服务的信息不构成使用此类产品或服务的许可或与其相关的保证或认可。使用 TI 资源可能需要您向第三方获得对该等第三方专利或其他知识产权的许可。

TI 资源系“按原样”提供。TI 兹免除对 TI 资源及其使用作出所有其他明确或默示的保证或陈述，包括但不限于对准确性或完整性、产权保证、无屡发故障保证，以及适销性、适合特定用途和不侵犯任何第三方知识产权的任何默认保证。

TI 不负责任何申索，包括但不限于因组合产品所致或与之有关的申索，也不为您辩护或赔偿，即使该等产品组合已列于 TI 资源或其他地方。对因 TI 资源或其使用引起或与之有关的任何实际的、直接的、特殊的、附带的、间接的、惩罚性的、偶发的、从属或惩戒性损害赔偿，不管 TI 是否获悉可能会产生上述损害赔偿，TI 概不负责。

您同意向 TI 及其代表全额赔偿因您不遵守本通知条款和条件而引起的任何损害、费用、损失和/或责任。

本通知适用于 TI 资源。另有其他条款适用于某些类型的材料、TI 产品和服务的使用和采购。这些条款包括但不限于适用于 TI 的半导体产品 (<http://www.ti.com/sc/docs/stdterms.htm>)、[评估模块](http://www.ti.com/sc/docs/sampters.htm)和样品 (<http://www.ti.com/sc/docs/sampters.htm>) 的标准条款。

邮寄地址：上海市浦东新区世纪大道 1568 号中建大厦 32 楼，邮政编码：200122  
Copyright © 2018 德州仪器半导体技术（上海）有限公司