

Project file structure

TI Precision Labs – PSpice® for TI

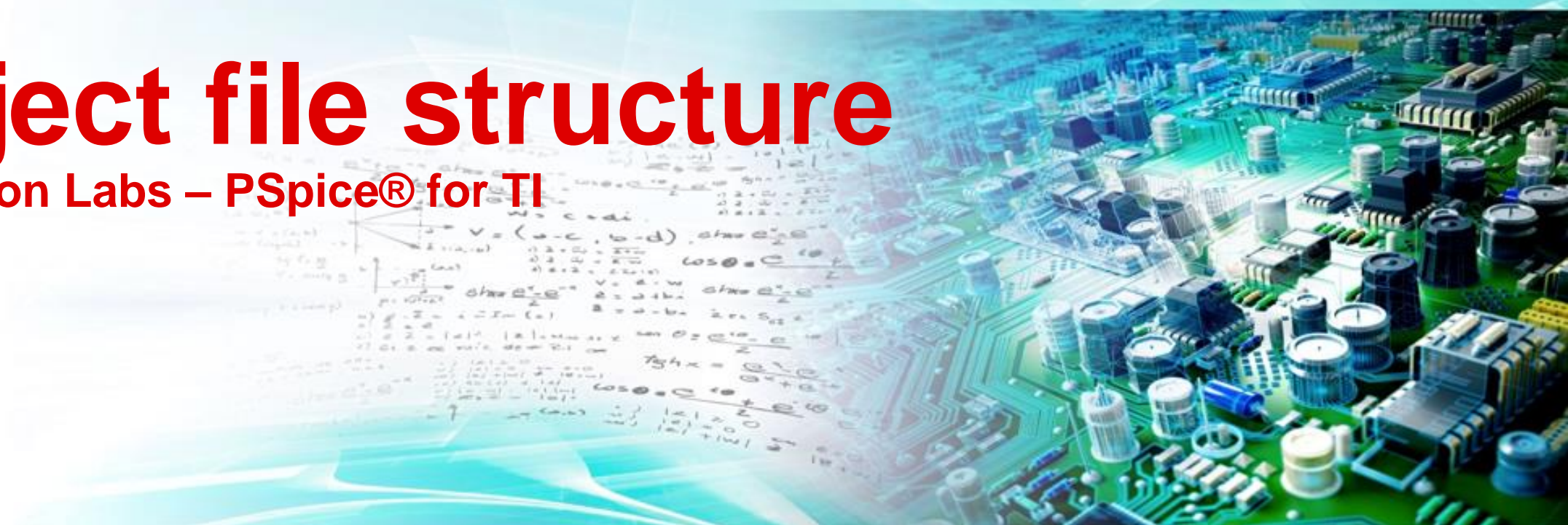

New project

- Each .dsn file will automatically have one page inside one schematic

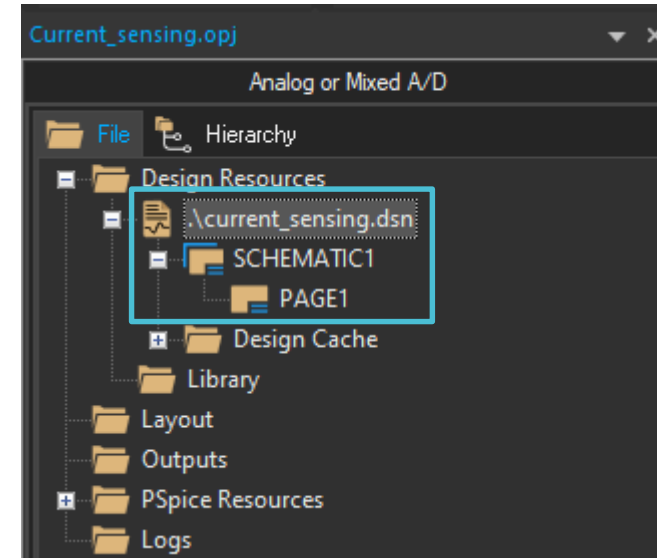
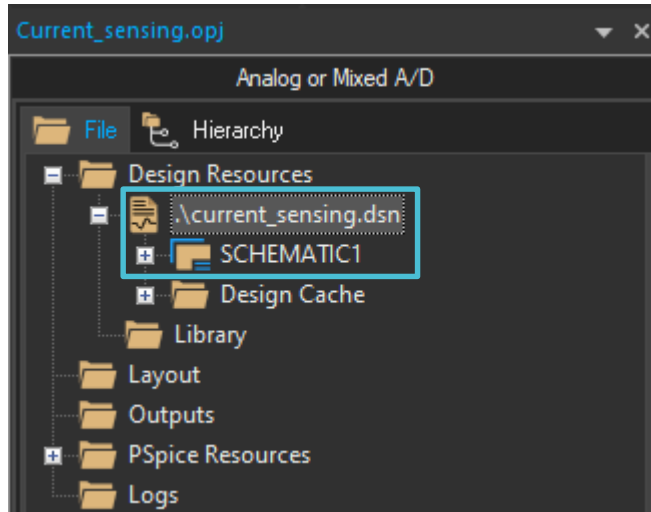

Renaming schematics

- Right click on a schematic to rename

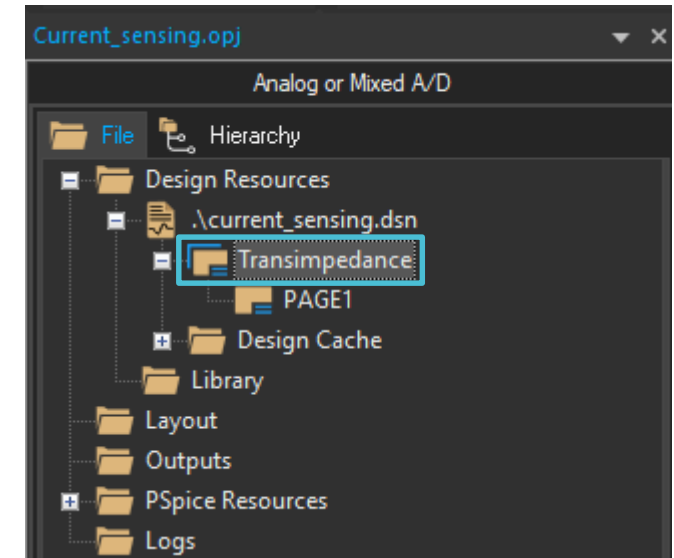
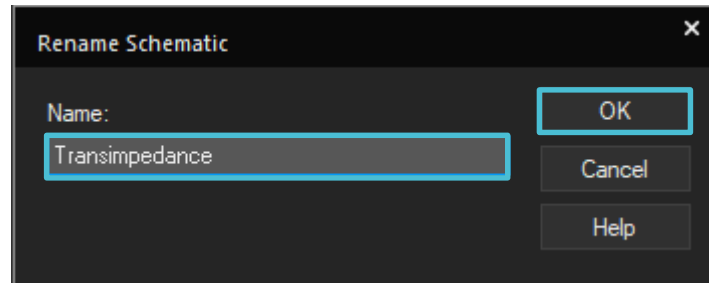
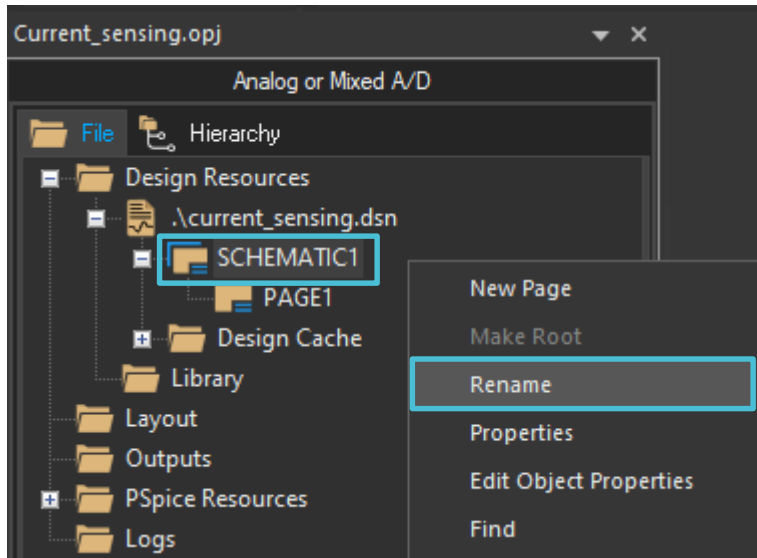

Renaming pages

- Right click on a page to rename

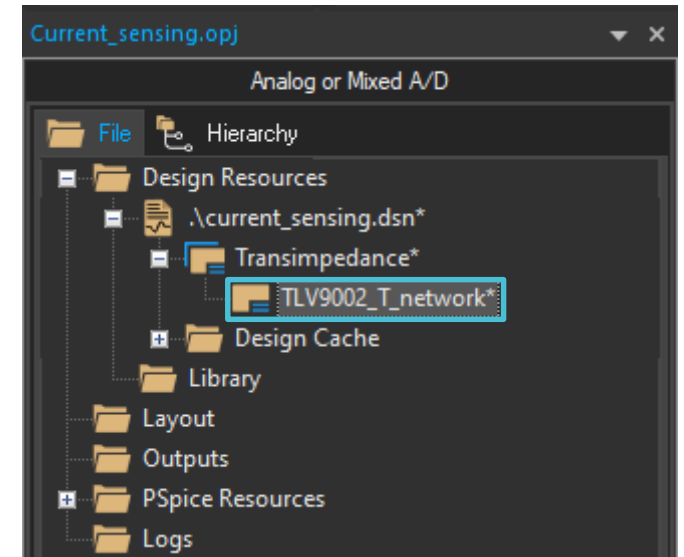
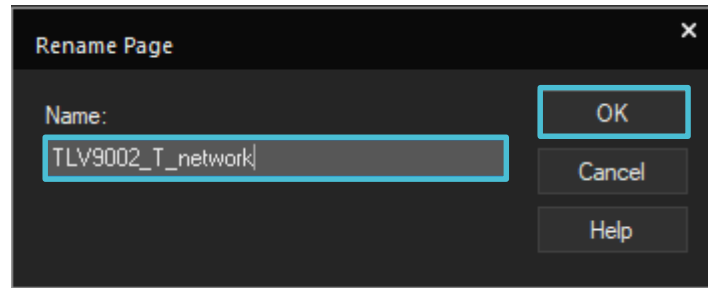
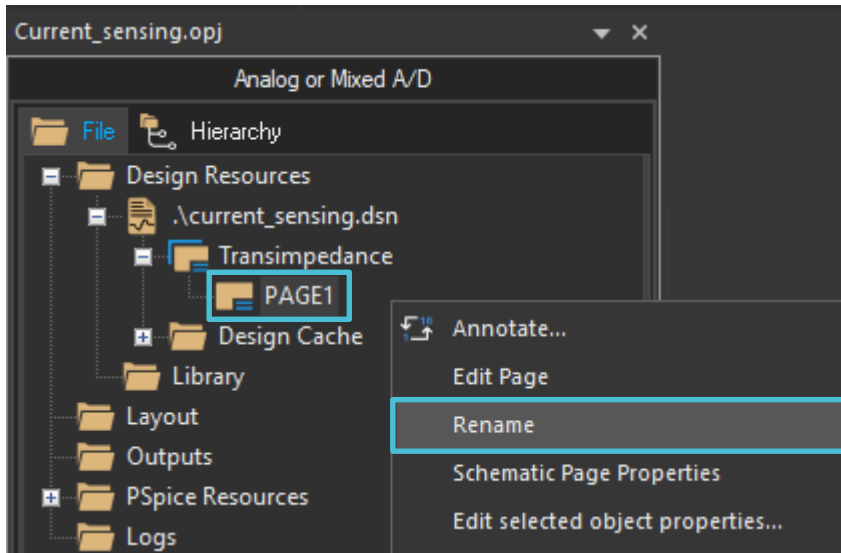

Adding a page to a schematic

- Right click on a schematic to add a new page

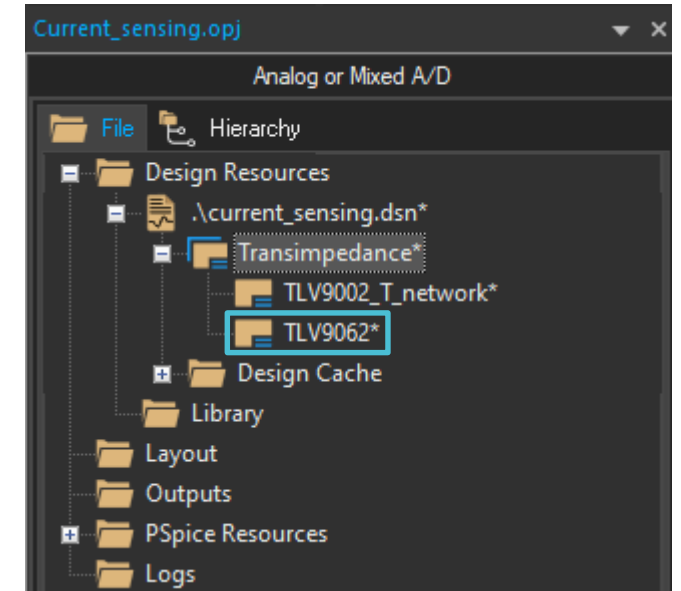
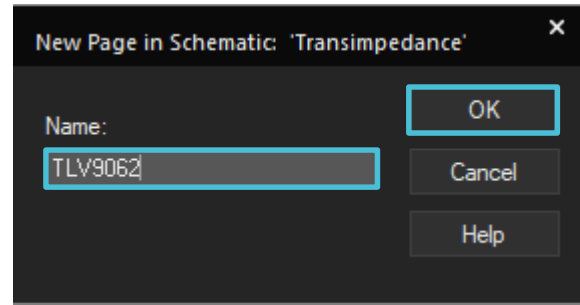
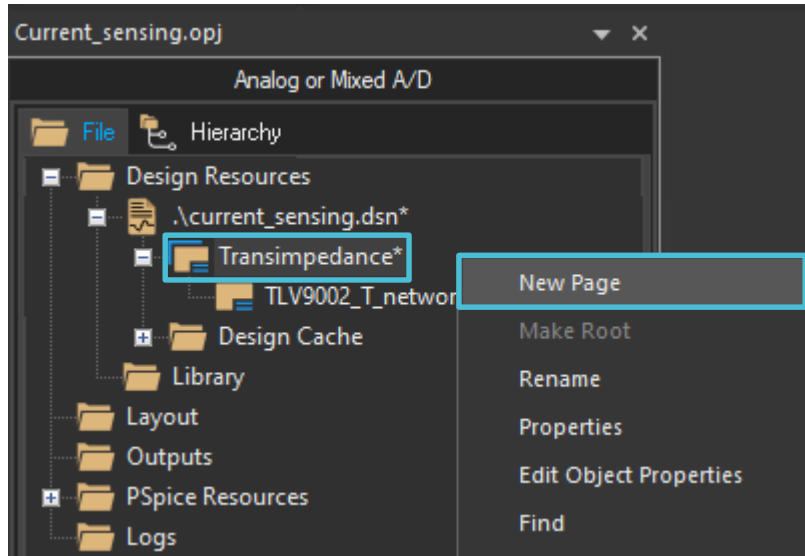

Alphabetical page re-order

- The pages within a schematic will automatically re-order alphabetically

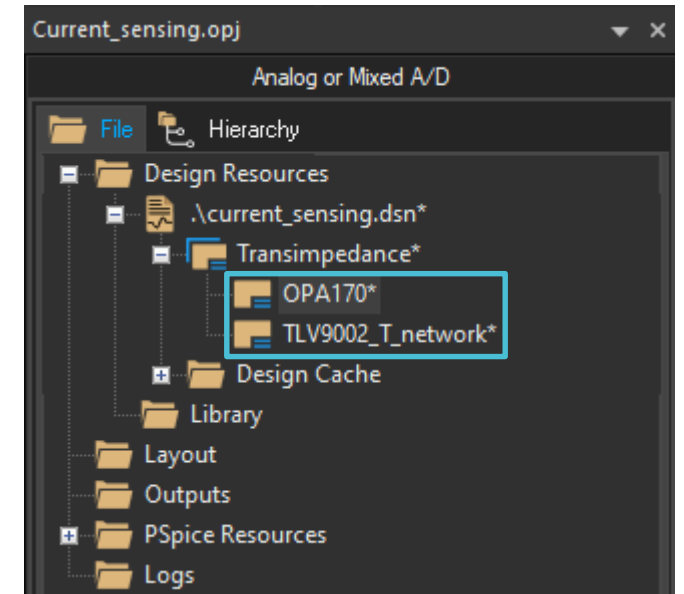
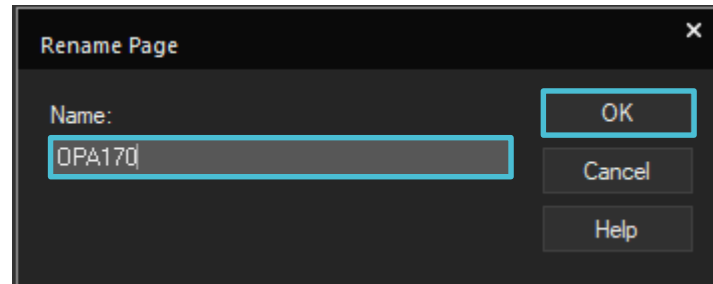
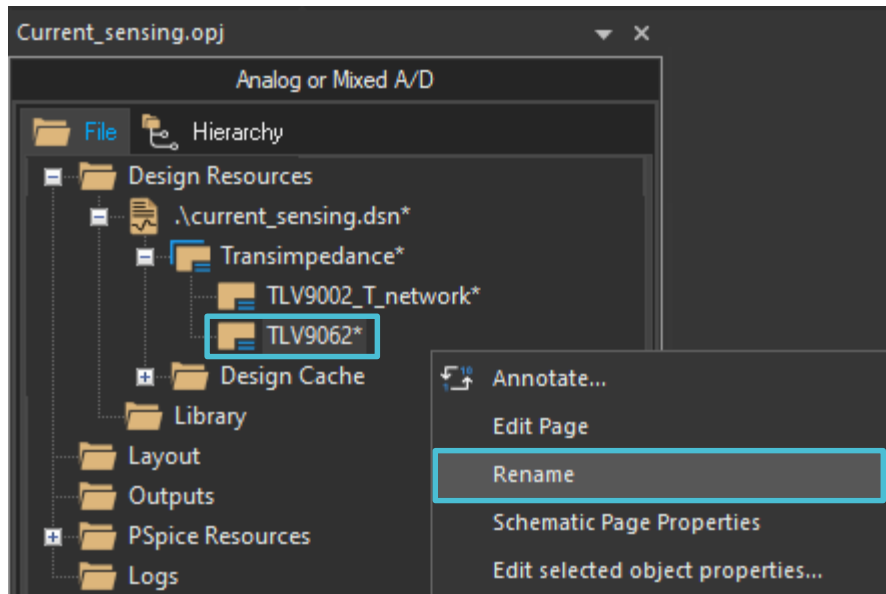

New schematic

- Right click on the design file and select “New Schematic...”

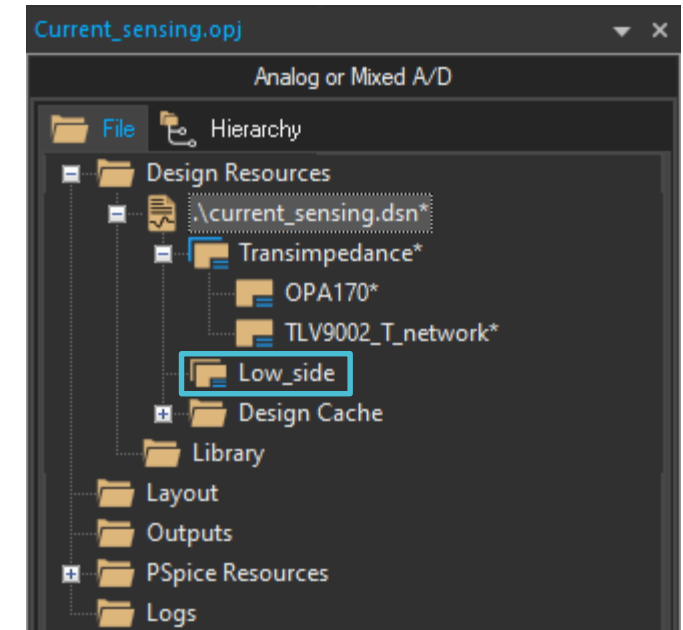
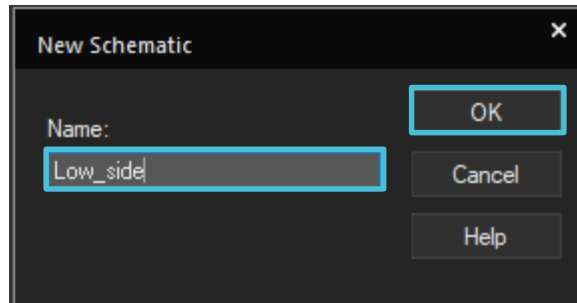
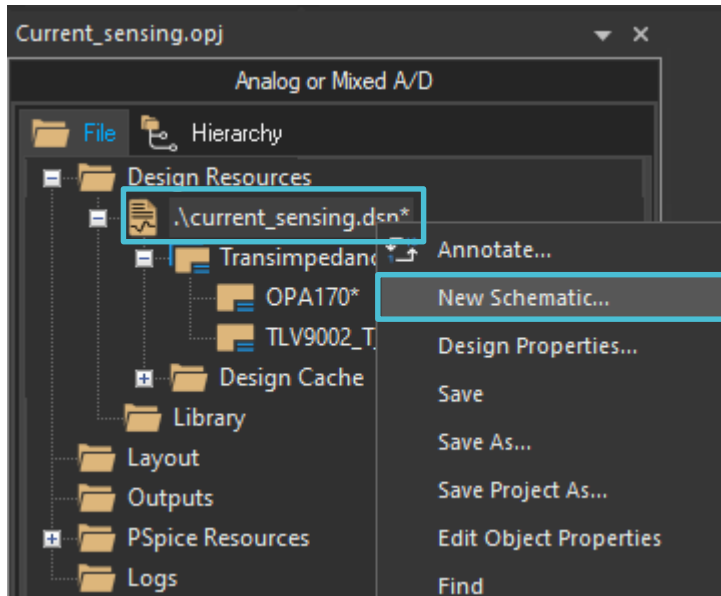

Save the project

- Saving a level within the hierarchy will save all levels below it

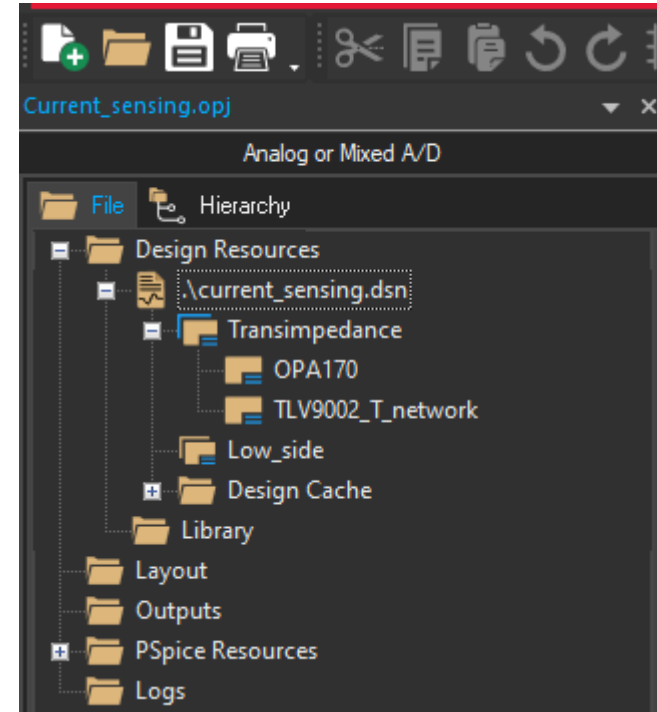
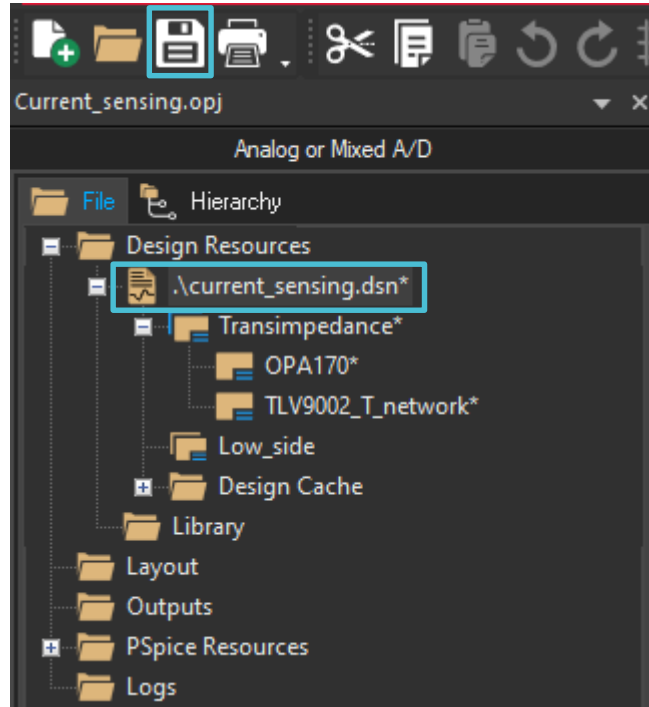

Project file structure

- Design
 - Schematic #1
 - Page 1
 - Page 2
 - Schematic #2
 - Page 1
 - Page 2
 - Schematic #3
 - Page 1

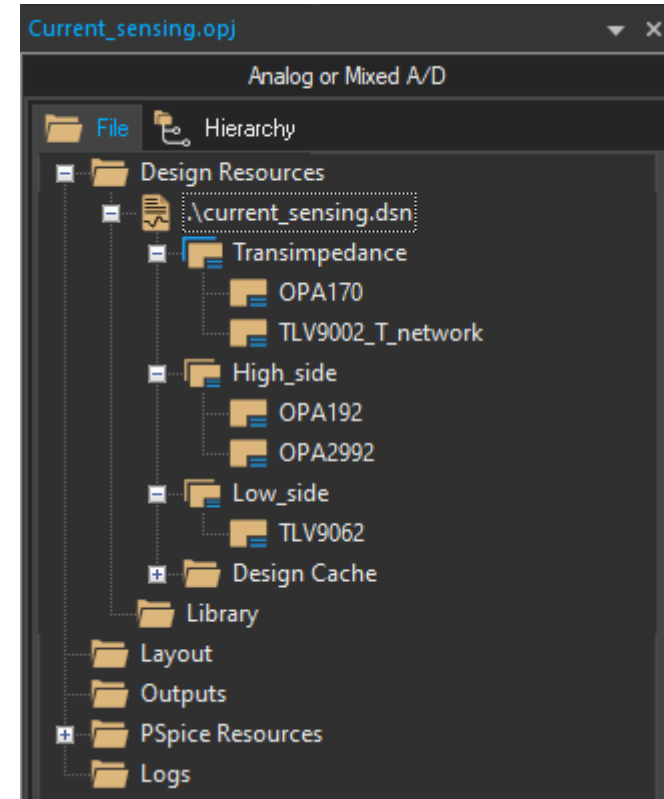

Root schematic

- A schematic must be the root of the project in order to be simulated.

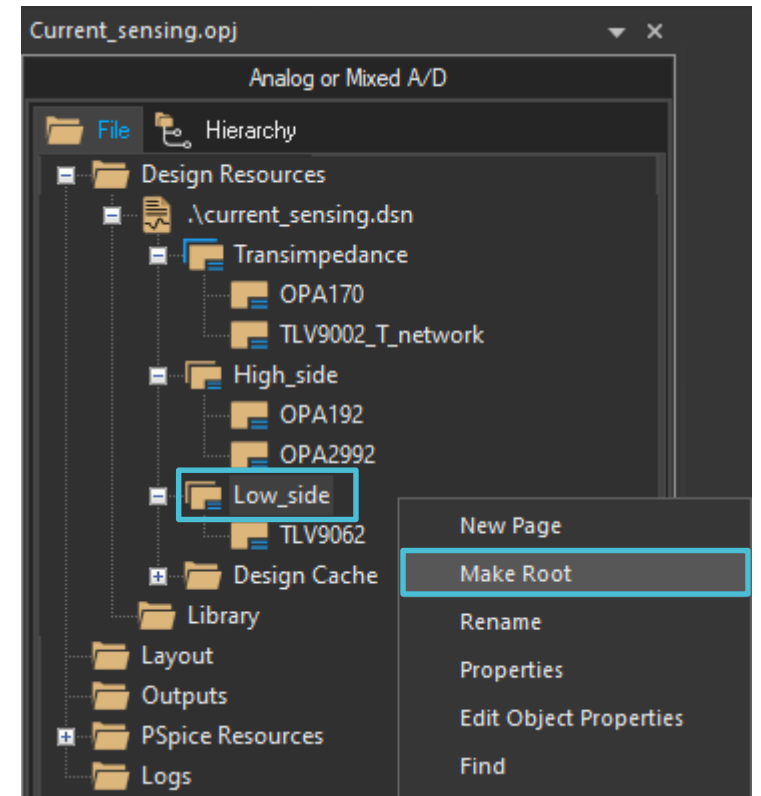
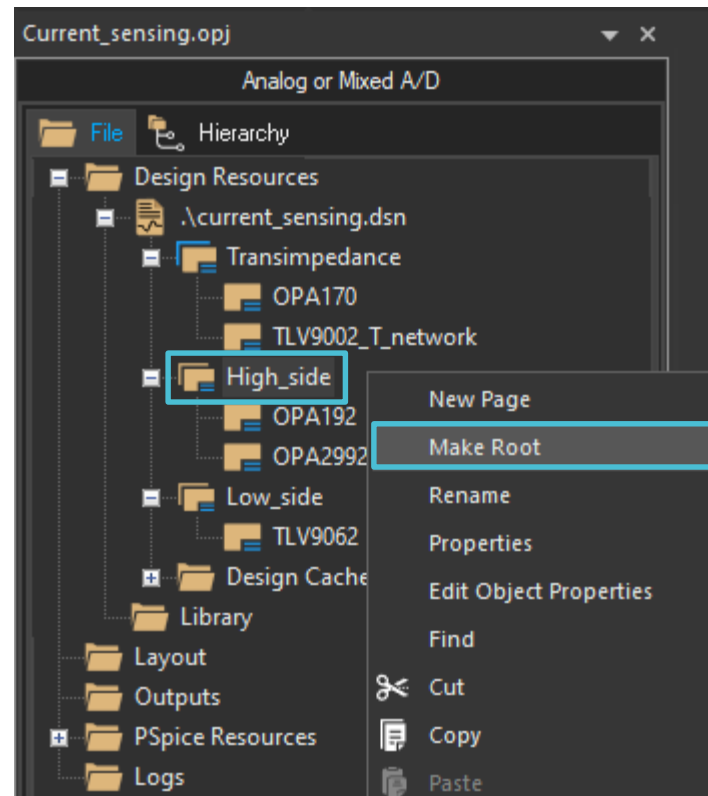
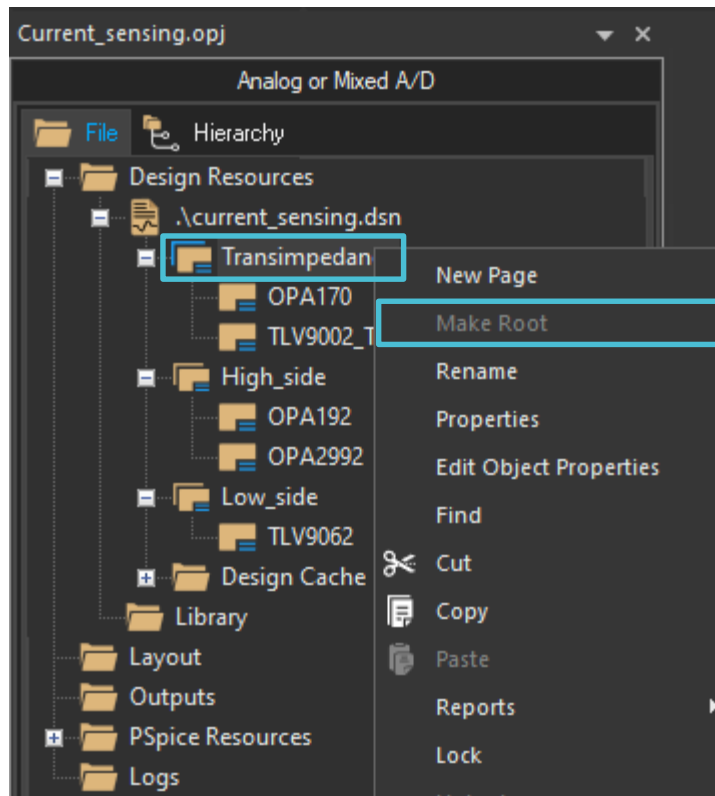

Project hierarchy

- The project root is at the top of the hierarchy

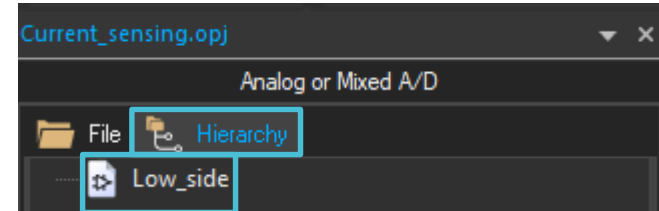
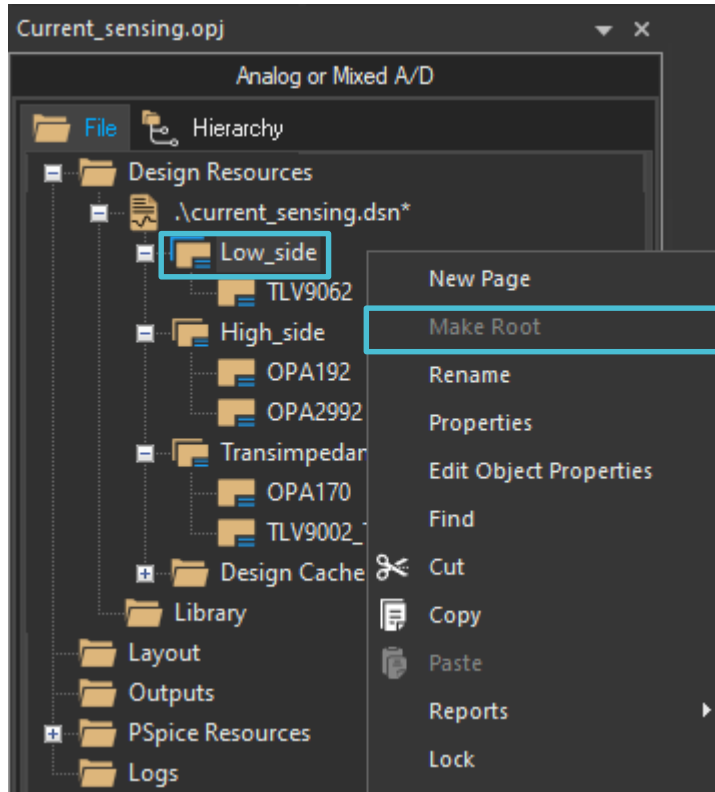

Net aliases

- Net aliases can be shared across different pages within a schematic. However, net aliases cannot be shared across schematics within a design.

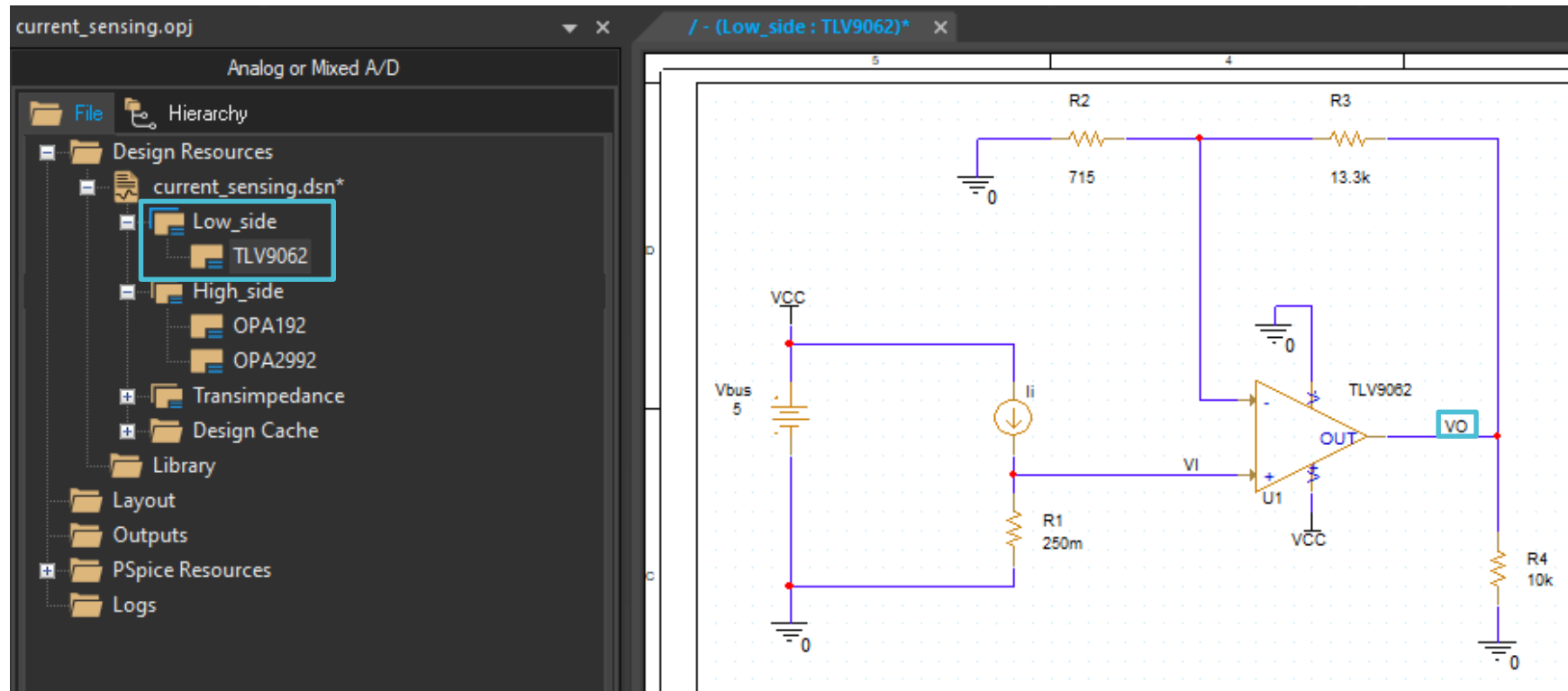

Thanks for your time!

To find more **PSpice® for TI**
technical resources and search products,
visit **[ti.com/tool/PSPICE-FOR-TI](https://www.ti.com/tool/PSPICE-FOR-TI)**.