

Introduction to mmwave Sensing: FMCW Radars

Sandeep Rao, Texas Instruments

INTRODUCTION TO MMWAVE SENSING: FMCW RADARS

Module 1 : Range Estimation

- Basics of FMCW radar operation
- Using the radar to measure range of multiple objects in front of the radar
- Concept of IF signal and IF bandwidth
- Range Resolution

In this module we'll try to answer the following questions.....

How does the radar estimate the range of an object?

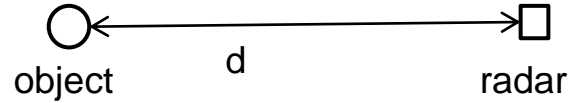

What if there are multiple objects?

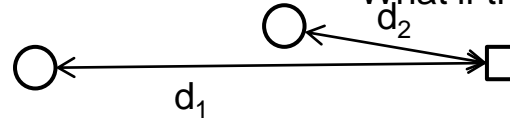

How close can two objects get and still be resolved as two objects?



What determines the furthest distance a radar can see?

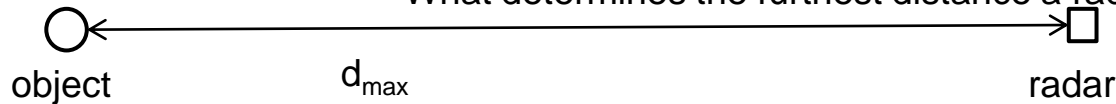

What is a chirp?

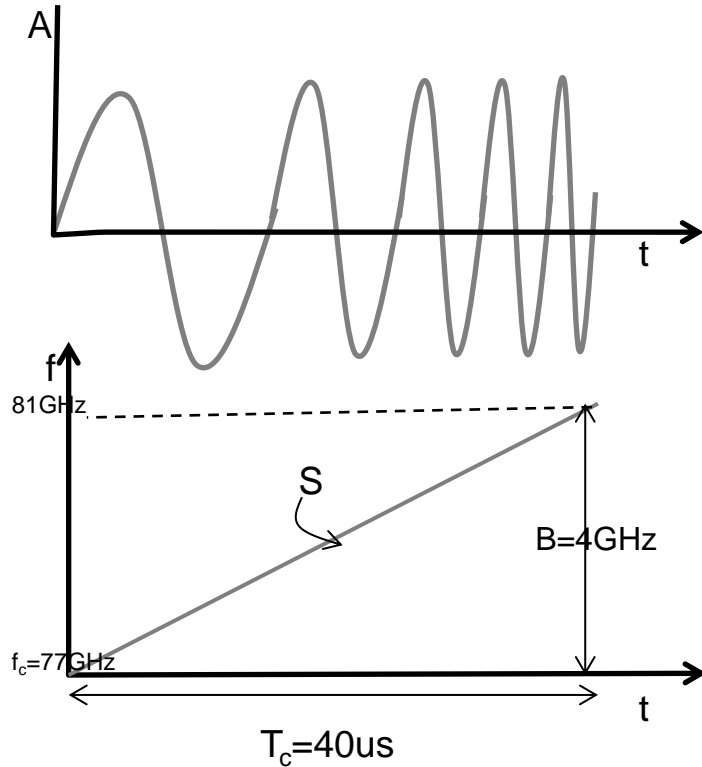

An FMCW radar transmits a signal called a “chirp”. A chirp is a sinusoid whose frequency increases linearly with time, as shown in the Amplitude vs time (or ‘A-t’ plot) here.

- A frequency vs time plot (or ‘f-t plot’) is a convenient way to represent a chirp.
- A chirp is characterized by a start frequency (f_c), Bandwidth(B) and duration (T_c).
- The Slope (S) of the chirp defines the rate at which the chirp ramps up. In this example the chirp is sweeping a bandwidth of 4GHz in 40us which corresponds to a Slope of 100MHz/us

A 1TX-1RX FMCW radar

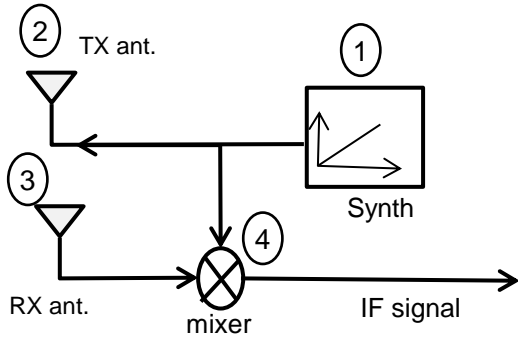

1. A synthesizer (synth) generates a chirp
2. The chirp is transmitted by the TX antenna
3. The chirp is reflected off an object and the reflected chirp is received at the RX antenna.
4. The RX signal and TX signal are 'mixed' and the resulting signal is called an 'IF signal'. We'll analyze the IF signal in more detail in the next slide

What is a mixer?

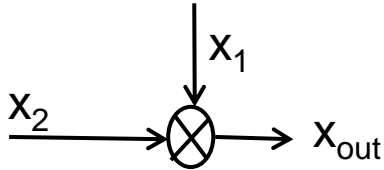

A mixer is a 3 port device with 2 inputs and 1 output. For our purposes, a mixer can be modelled as follows. For two sinusoids x_1 and x_2 input at the two input ports, the output is a sinusoid with:

- Instantaneous frequency equal to the difference of the instantaneous frequencies of the two input sinusoids.
- Phase equal to the difference of the phase of the two input sinusoids

$$x_1 = \sin[w_1 t + \phi_1]$$

$$x_2 = \sin[w_2 t + \phi_2]$$

$$x_{out} = \sin[(w_1 - w_2)t + (\phi_1 - \phi_2)]$$

The IF signal

The mixers operation can be understood easily using the f-t plot.

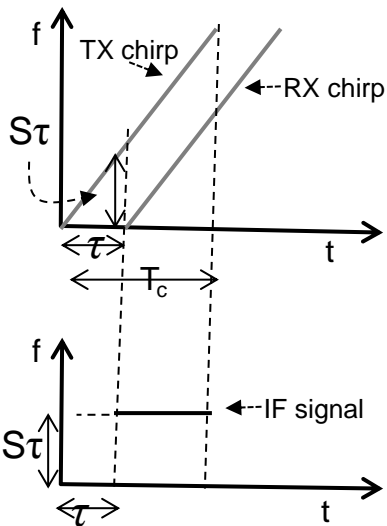

- The top figure shows the TX-signal and the RX-signal that is reflected from an object. Note that the RX-signal is just a delayed version of the TX signal. (τ denotes the round-trip time between the radar and the object. Also S denotes the slope of the chirp)
- Recall that the frequency of the signal at the mixers output is the difference of the instantaneous frequency of the TX-chirp and RX-chirp. As shown in the figure below, this is a straight line.
- Hence: A single object in front of the radar produces an IF signal that is a constant frequency tone.
 - The frequency of this tone is $S\tau = S2d/c$; [Since $\tau = 2d/c$, where d is distance of the object and c is the speed of light]

Note that τ is typically a small fraction of the total chirp time \Rightarrow non-overlapping segment of the TX chirp is usually negligible. E.g. For a radar with a max distance of 300m and $T_c=40\mu\text{s}$. $\tau/T_c = 5\%$

A single object in front of the radar produces an IF signal with a constant frequency of $S2d/c$

Fourier Transforms : A quick review

- Fourier Transform converts a time domain signal into the frequency domain.
- A sinusoid in the time domain produces a single peak in the frequency domain.

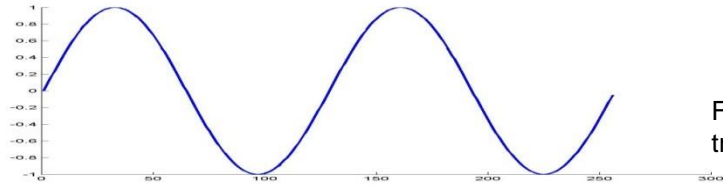

Fourier
transform

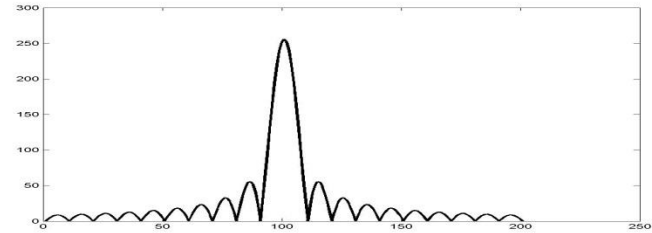

Fourier Transforms: A quick review

Within the observation window T below, the red tone completes 2 cycles, while the blue tone completes 2.5 cycles. The difference of 0.5 cycles is not sufficient to resolve the tones in the frequency spectrum.

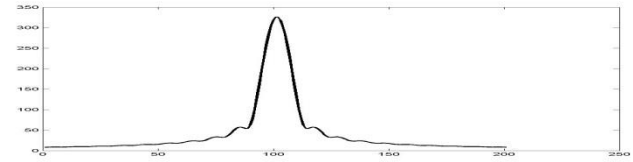
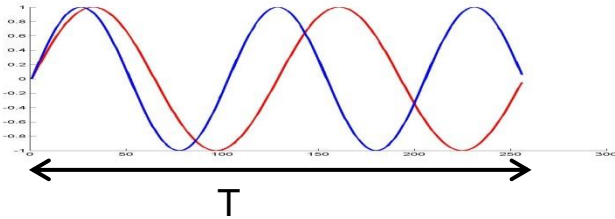

Doubling the observation window results in a difference of 1 cycle \Rightarrow the tones are resolved in the frequency spectrum

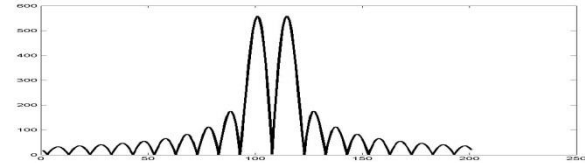
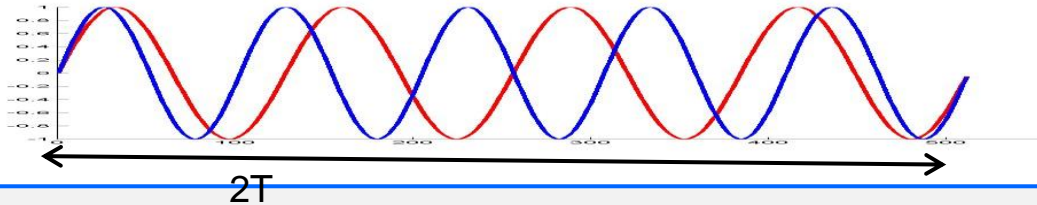

Longer the observation period \Rightarrow better the resolution. In general, an observation window of T can separate frequency components that are separated by more than $1/T$ Hz

Multiple objects in front of the radar

Multiple objects in front of the radar=> multiple reflected chirps at the RX antenna

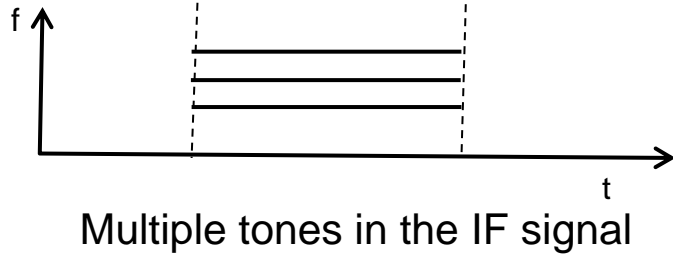
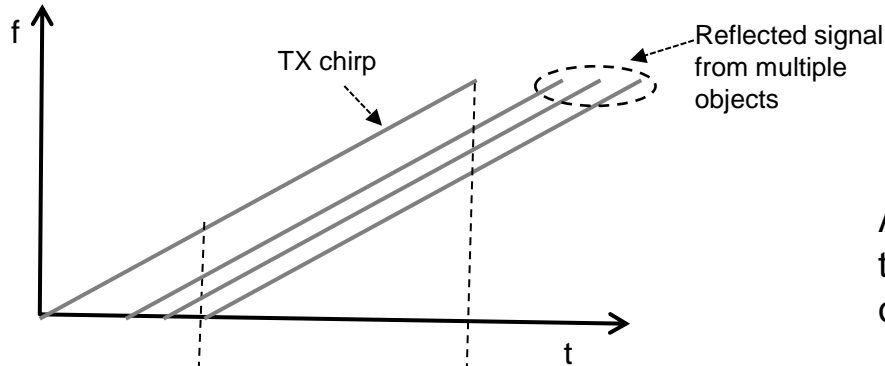

A frequency spectrum of the IF signal will reveal multiple tones, the frequency of each being proportional to the range of each object from the radar

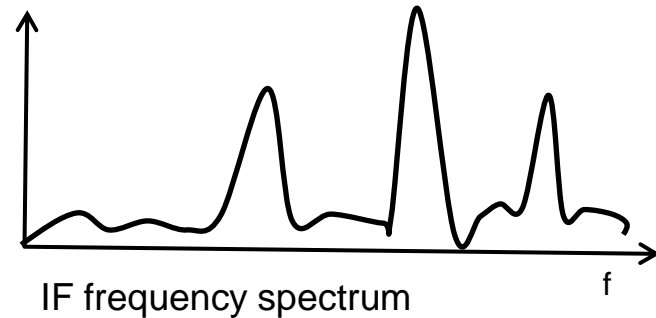

Range Resolution in a radar

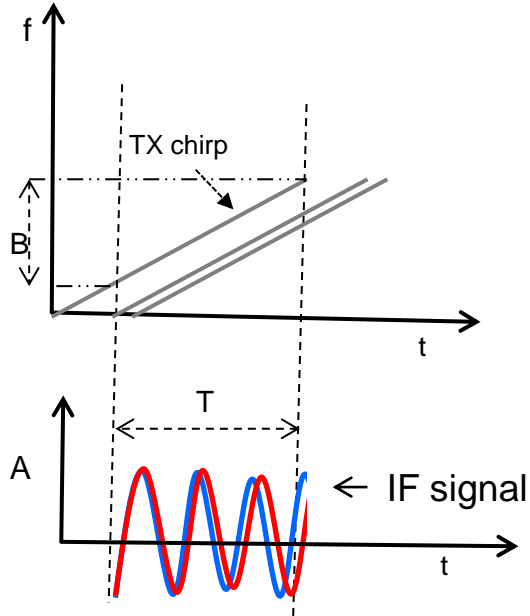

- Range Resolution refers to the ability to resolve two closely spaced objects.
- In this slide, the two objects are too close that they show up as a single peak in the frequency spectrum

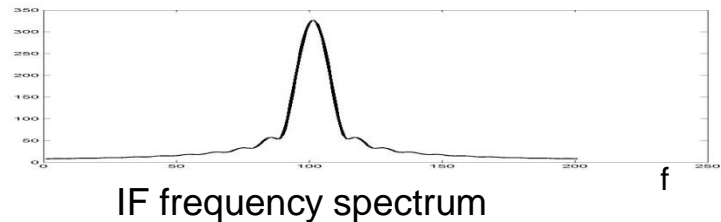

Range Resolution in a radar

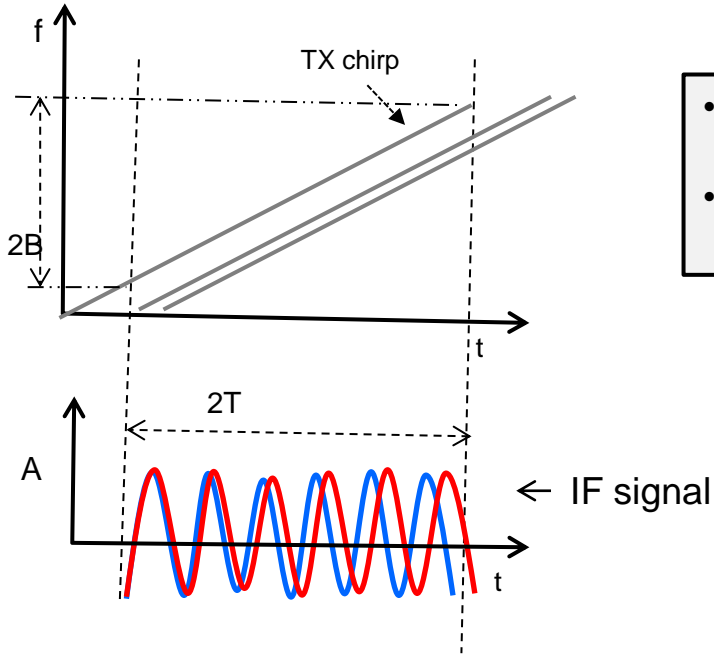

- The two objects can be resolved by increasing the length of the IF signal.
- Note that this also proportionally increases the bandwidth. Thus intuitively: Greater the Bandwidth \Rightarrow better the resolution

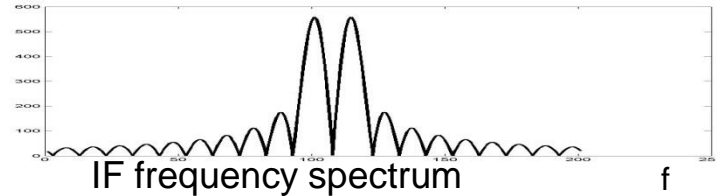

Range Resolution in a radar

- Recall that
 - An object at a distance d results in an IF tone of frequency $S2d/c$
 - Two tones can be resolved in frequency as long as the frequency difference $\Delta f > 1/T$
- Can you use the above to derive an equation for the range resolution of the radar?
 - On what parameters does the range resolution depend ? Chirp Duration, Bandwidth, Slope?

For two objects separated by a distance Δd , the difference in their IF frequencies is given by $\Delta f = \frac{S2\Delta d}{c}$

Since the observation interval is T_c , this means that

$$\Delta f > \frac{1}{T_c} \Rightarrow \frac{S2\Delta d}{c} > \frac{1}{T_c} \Rightarrow \Delta d > \frac{c}{2ST_c} \Rightarrow \frac{c}{2B} \quad (\text{since } B=ST_c)$$

The Range Resolution (d_{res}) depends only on the Bandwidth swept by the chirp

$$d_{res} = \frac{c}{2B}$$

Question

- Which of these two chirps gives a better range-resolution?
 - What is the intuition behind this result?

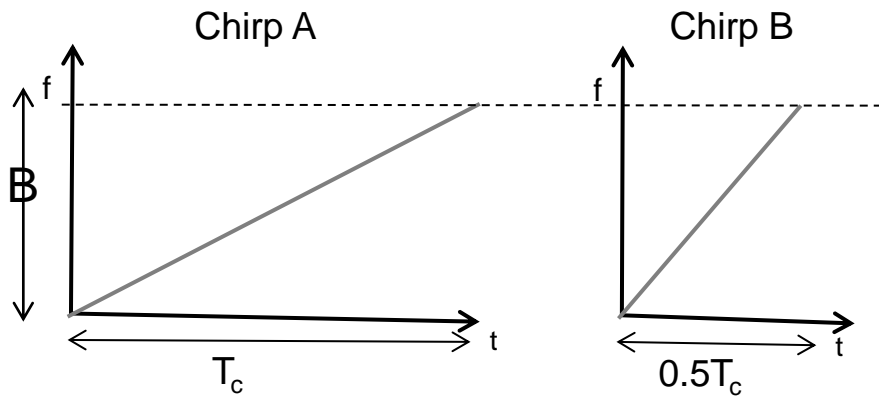

Question

- Which of these two chirps gives a better range-resolution?
 - What is the intuition behind this result?

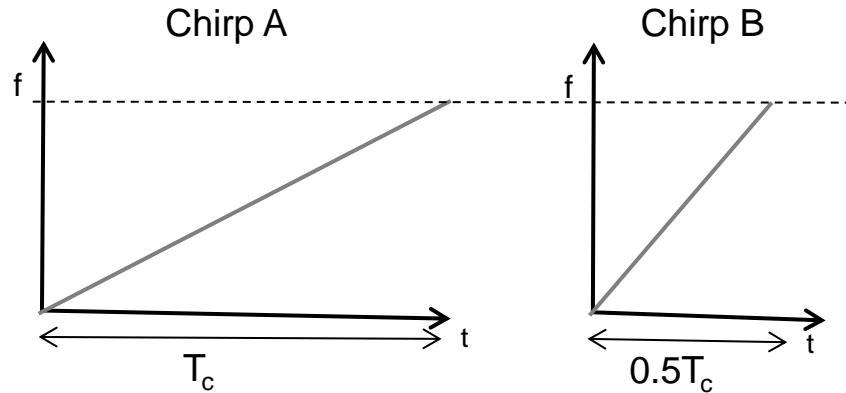

Some typical numbers

Bandwidth	Range Resolution
4GHz	3.75cm
2GHz	7.5cm
1GHz	15cm
600MHz	25cm

Digitizing the IF signal

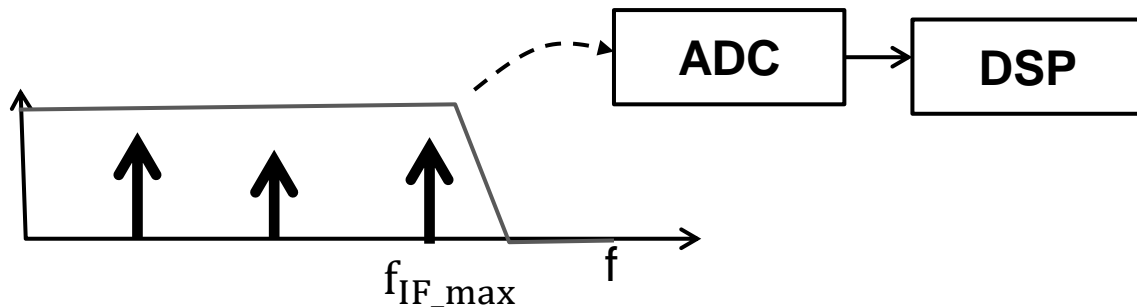

- The bandwidth of interest of the IF signal depends on the desired maximum distance : $f_{IF_max} = \frac{S2d_{max}}{c}$
- IF signal is typically digitized (LPF+ADC) for further processing on a DSP.
- IF Bandwidth is thus limited by the ADC sampling rate (F_s). $F_s \geq \frac{S2d_{max}}{c}$

An ADC sampling rate of F_s limits the maximum range of the radar to

$$d_{max} = \frac{F_s c}{2S}$$

Question

- Revisiting our earlier example, what more can we now say about these two chirps?

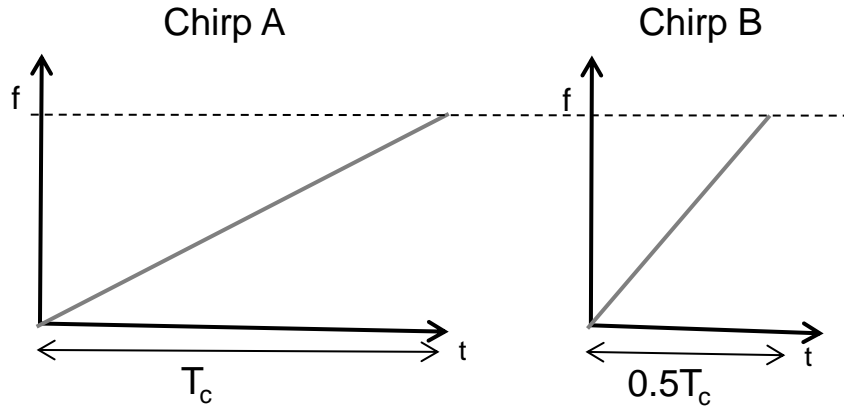

While both Chirp A and B have the same range resolution:

- For the same d_{\max} , Chirp A requires only half the IF bandwidth (\Rightarrow smaller F_s on the ADC).
- But Chirp B has the advantage of requiring half the measurement time.

Summary

2 Chirp is transmitted. RX sees delayed versions of this chirp

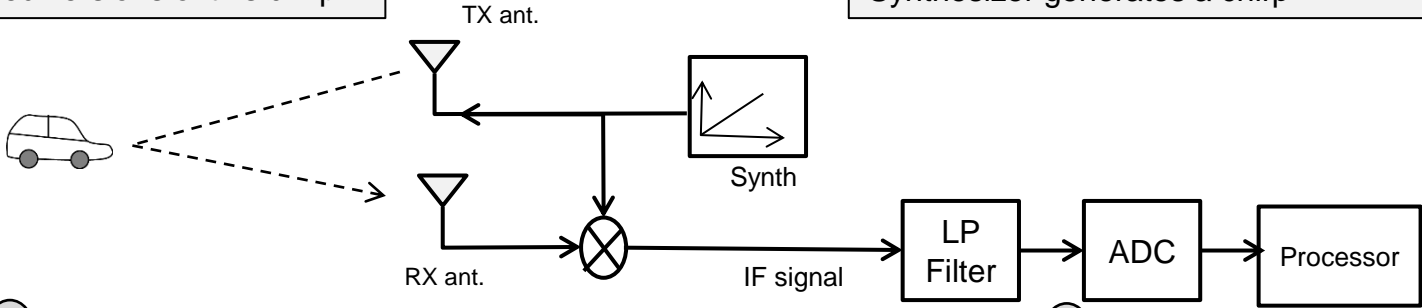

1 Synthesizer generates a chirp

3 IF signal consists of multiple tones, the frequency (f) of each tone being proportional to the distance (d) of the corresponding object

4 The IF signal is digitized. The ADC must support an IF bandwidth of $S2d_{max}/c$

5 An FFT is performed on the ADC data. The location of peaks in the frequency spectrum directly correspond to the range of objects

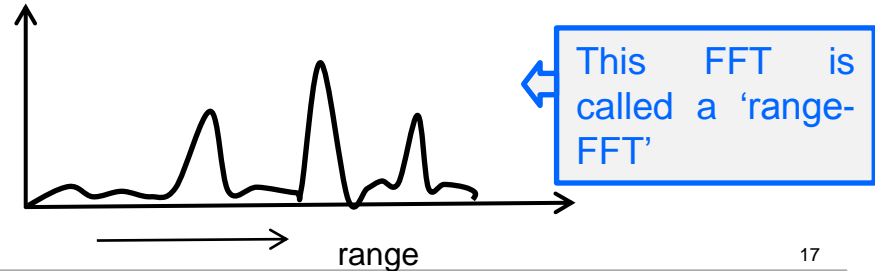

Key concepts /formulas

- An object at a distance d produces an IF frequency of:

$$- f_{IF} = \frac{S2d}{c}$$

- Range resolution (d_{res}) depends on the bandwidth (B):

$$- d_{res} = \frac{c}{2B}$$

- The ADC sampling rate F_s , limits the max range (d_{max}) to

$$- d_{max} = \frac{F_s c}{2S}$$

Chirp Bandwidth vs IF bandwidth?

Larger Chirp Bandwidth => better range resolution

Larger IF Bandwidth => faster chirps , better maximum distance

Epilogue

- Two objects equidistant from the radar. How will the range-FFT look like?

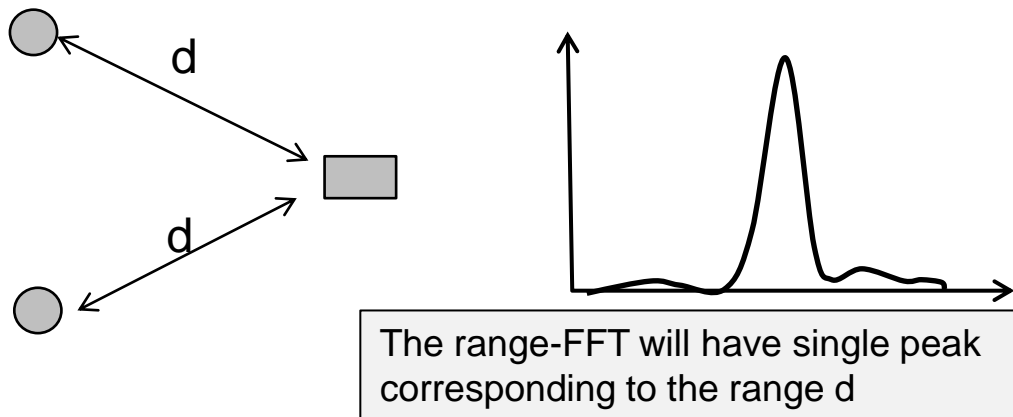

- How do we separate these two objects?
 - It turns out that if the 2 objects have different velocities relative to the radar, then these objects can be separated out by further signal processing. To understand that we need to look at the phase of the IF-signal and which is something we will do in the next module

INTRODUCTION TO MMWAVE SENSING: FMCW RADARS

Module 2 : The Phase of the IF signal

Fourier Transforms : A quick review

- Fourier Transform converts a time domain signal into the frequency domain.
- A sinusoid in the time domain produces a peak in the frequency domain. In general, the signal in the Frequency domain is complex (i.e. each value is a phasor with a amplitude and a phase)

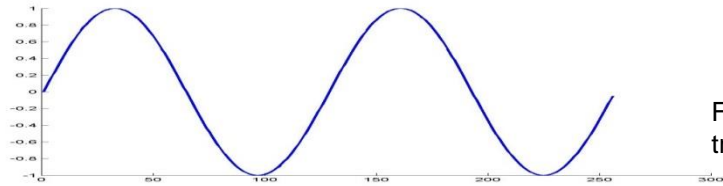

Fourier transform

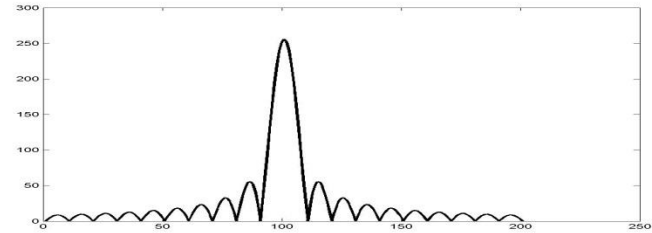

$$Ae^{j\theta}$$

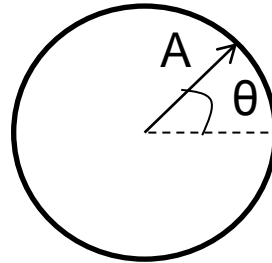

Fourier Transforms : A quick review

- Fourier Transform converts a time domain signal into the frequency domain.
- A sinusoid in the time domain produces a peak in the frequency domain. In general, the signal in the Frequency domain is complex (i.e. each value is a phasor with an amplitude and a phase)

Phase of the peak is equal to the initial phase of the sinusoid

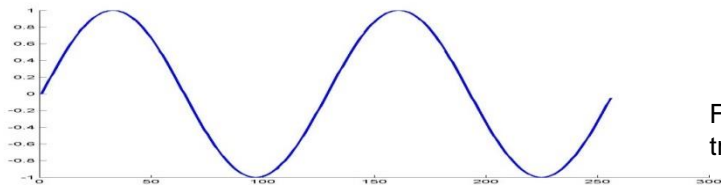

Fourier transform

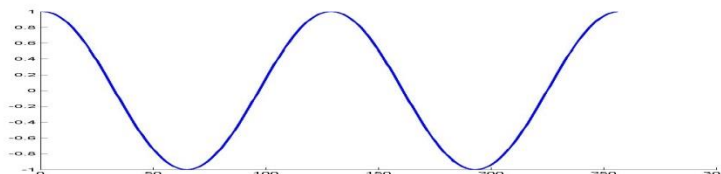
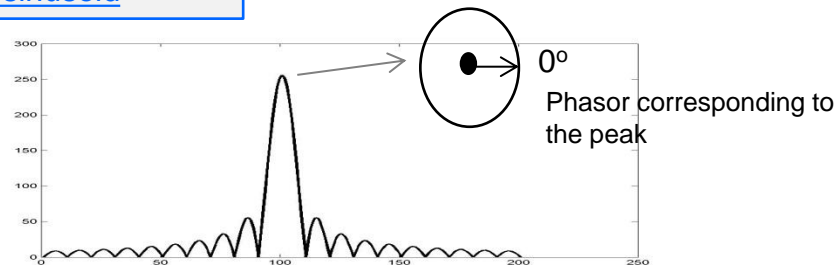

Fourier transform

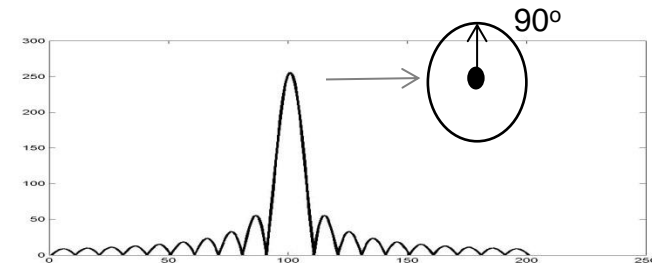

Frequency of the IF signal : Recap from module 1

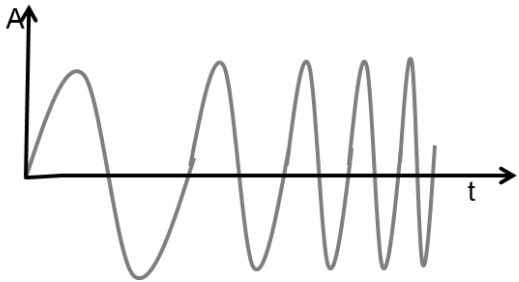

Let us quickly recap material from module 1. We saw that an FMCW radar transmits a chirp, which can be represented using an freq vs time (or f-t) plot as shown here or equivalently using an (Amplitude vs time) or A-t plot here. Focussing on the f-t plot, the radar receives a reflected chirp from an object, after a round-trip delay of τ . The transmit signal and the reflected signal are mixed in a mixer, to create an IF signal which has a constant frequency of $S\tau$ (or equivalently $S2d/c$, where d is the distance to the object). PAUSE

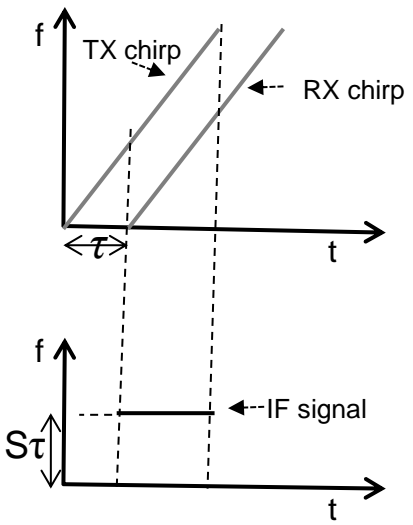

A single object in front of the radar produces an IF signal with a constant frequency of $S2d/c$

Phase of the IF signal

To get more intuition into the nature of the IF signal, let's look at the 'A-t' plot.

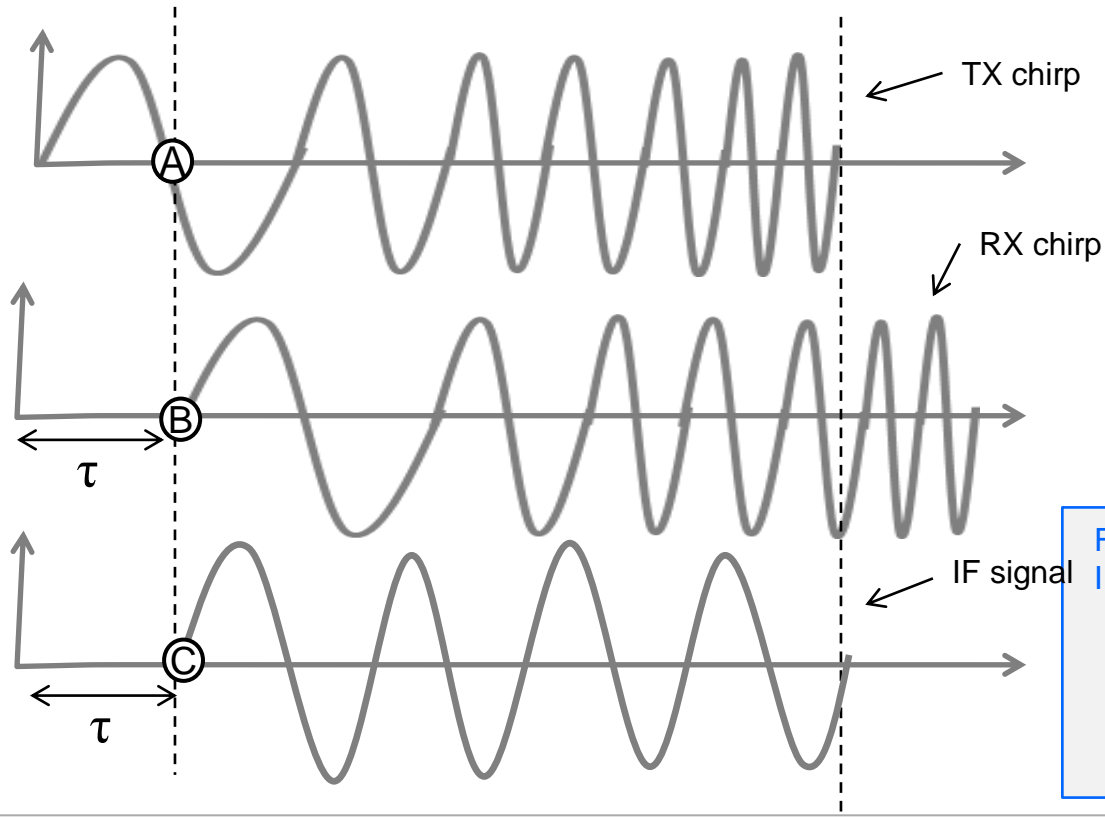

Recall that the initial phase of the signal at the mixer output is the difference of the initial phases of the two inputs.

For an object at a distance d from the radar, the IF signal will be a sinusoid:

$$A \sin(2\pi f t + \phi_0)$$

$$f = \frac{S2d}{c}$$

Phase of the IF signal

What happens if the round-trip delay changes by a small amount $\Delta\tau$

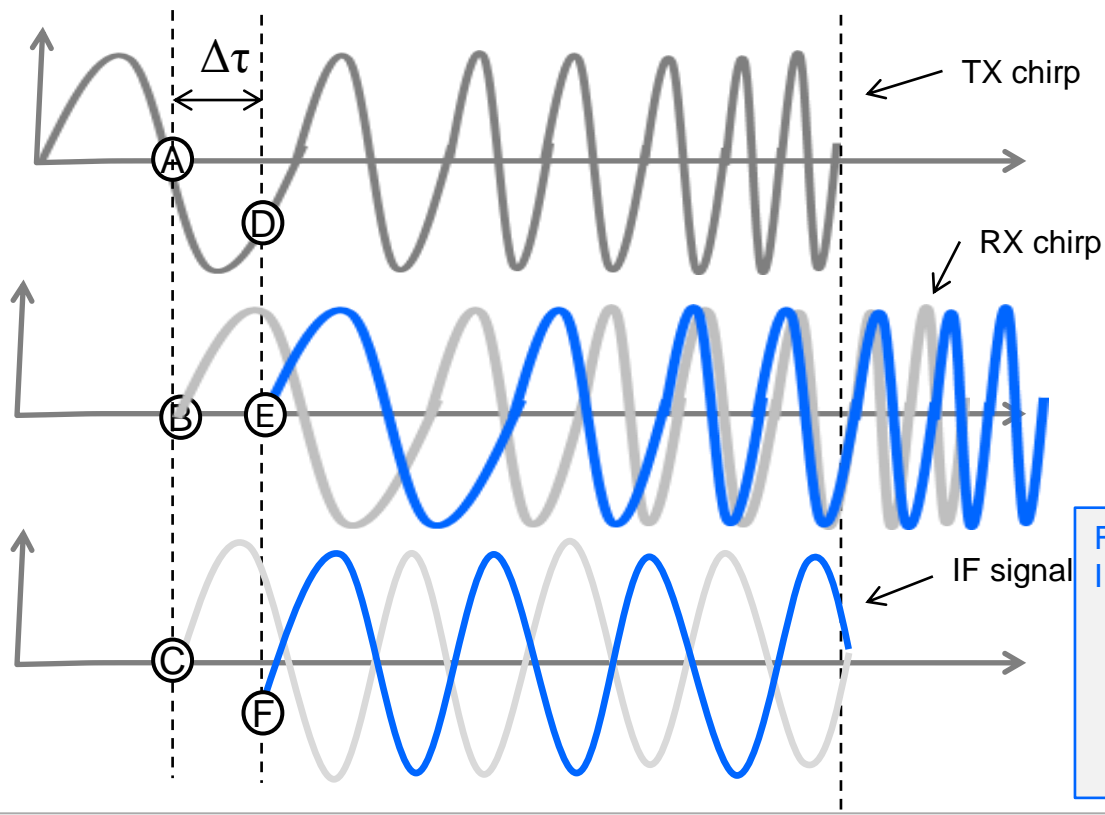

Phase difference between A and D is

$$\Delta\Phi = 2\pi f_c \Delta\tau = \frac{4\pi\Delta d}{\lambda}$$

This is also the phase difference between C and F

For an object at a distance d from the radar, the IF signal will be a sinusoid:

$$A \sin(2\pi f t + \phi_0)$$

$$f = \frac{S2d}{c}$$

$$\Delta\Phi = \frac{4\pi\Delta d}{\lambda}$$

Sensitivity of the IF signal for small displacements in the object(1/2)

Recall that for an object at a distance d from the radar, the IF signal will be a sinusoid:

$$A \sin(2\pi f t + \phi_o)$$
$$f = \frac{S2d}{c} \qquad \Delta\phi = \frac{4\pi\Delta d}{\lambda}$$

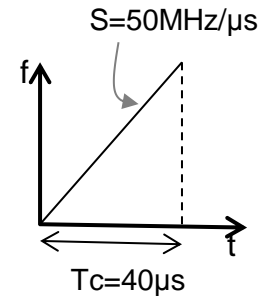

- Consider the chirp shown to the left. What happens if an object in front of the radar changes its position by 1mm (for 77GHz radar $1\text{mm} = \lambda/4$)
- The phase of the IF signal changes by $\Delta\phi = \frac{4\pi\Delta d}{\lambda} = \pi = 180^\circ$
- The frequency of the IF signal changes by $\Delta f = \frac{S2\Delta d}{c} = \frac{50 \times 10^{12} \times 2 \times 1 \times 10^{-3}}{3 \times 10^8} = 333\text{Hz}$. Now, 333Hz looks like a big number, but in the observation window this corresponds to only additional $\Delta f T_c = 333 \times 40 \times 10^{-6} = 0.013$ cycles. This change would not be discernible in the frequency spectrum

The phase of the IF signal is very sensitive to small changes in object range

Sensitivity of the IF signal for small displacements in the object(2/2)

An object at certain distance produces an IF signal with a certain frequency and phase

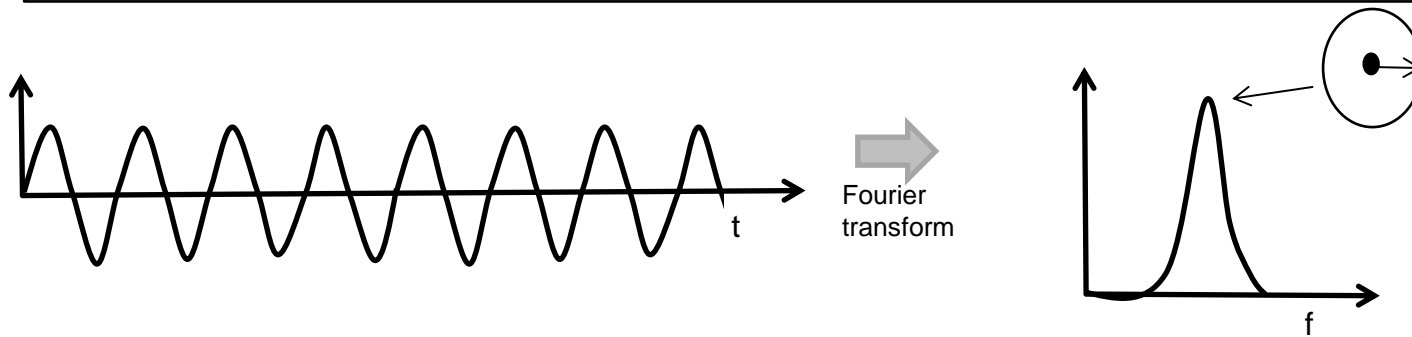

Small motion in the object changes the phase of the IF signal but not the frequency

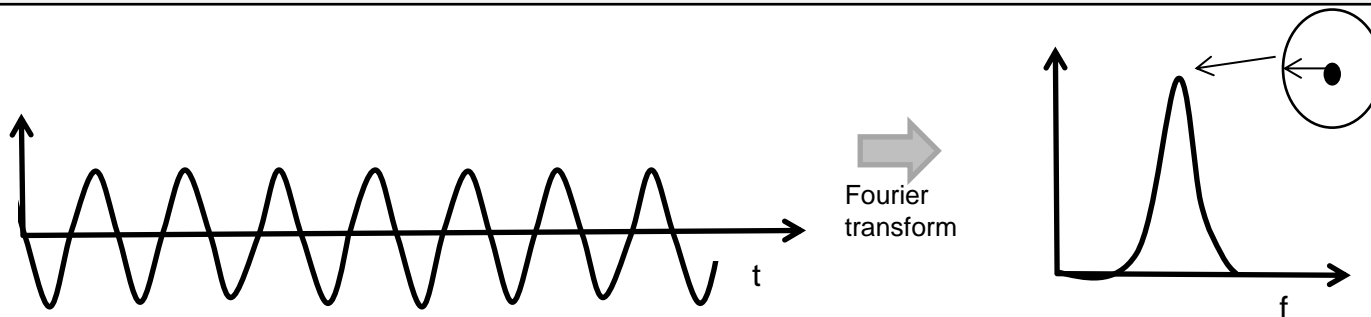

How to measure the velocity (v) of an object using 2 chirps

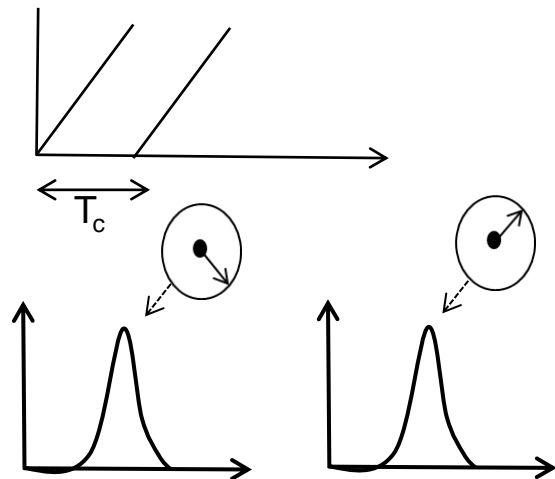

- Transmit two chirps separated by T_c
- The range-FFTs corresponding to each chirp will have peaks in the same location but with differing phase.
- The measured phase difference (ω) corresponds to a motion in the object of vT_c

$$\omega = \frac{4\pi v T_c}{\lambda} \Rightarrow v = \frac{\lambda \omega}{4\pi T_c}$$

The phase difference measured across two consecutive chirps can be used to estimate the velocity of the object

Measurements on a Vibrating Object

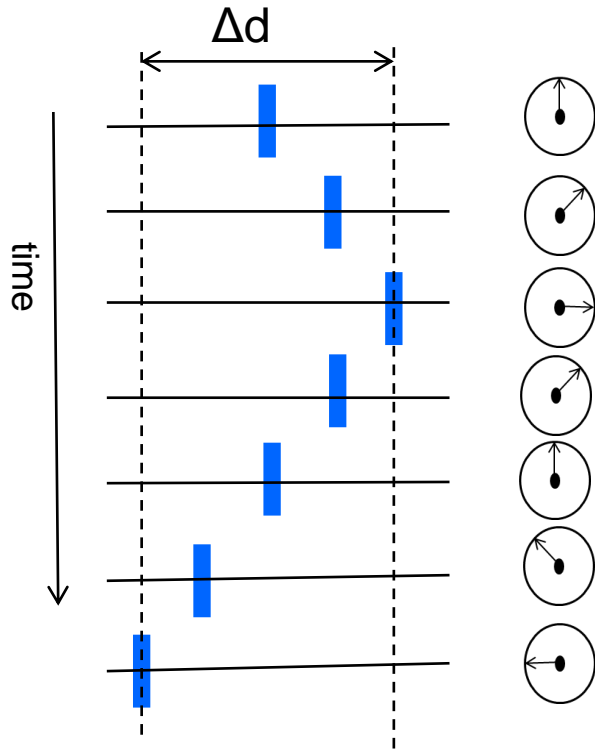

Besides velocity measurement, -The fact that the phase of the IF signal is very sensitive to small movements is also the basis for interesting applications such as vibration monitoring of motors, heart beat monitoring. This slide is a quick introduction to how that works. This figure depicts the time evolution of an object moving with an oscillatory motion. This could represent for e.g a vibrating object. The assumption here is that these movements are very small, so maximum displacement Δd of the object is a fraction of a wavelength (for e.g. a mm or less). What happens if we place a radar in front of this oscillating object and transmit a bunch of equispaced chirps. Each of these TX chirps, would result in a reflected chirp and processed IF signal would result in a peak in the range-FFT. Now the frequency of this peak is not going to change much across chirps. But the phase of the peak is going to respond to the oscillatory movement of the object.

Measurements on a Vibrating Object

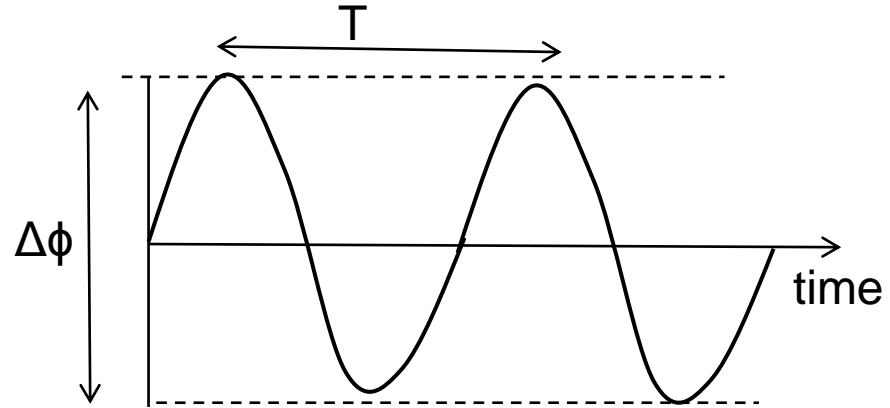
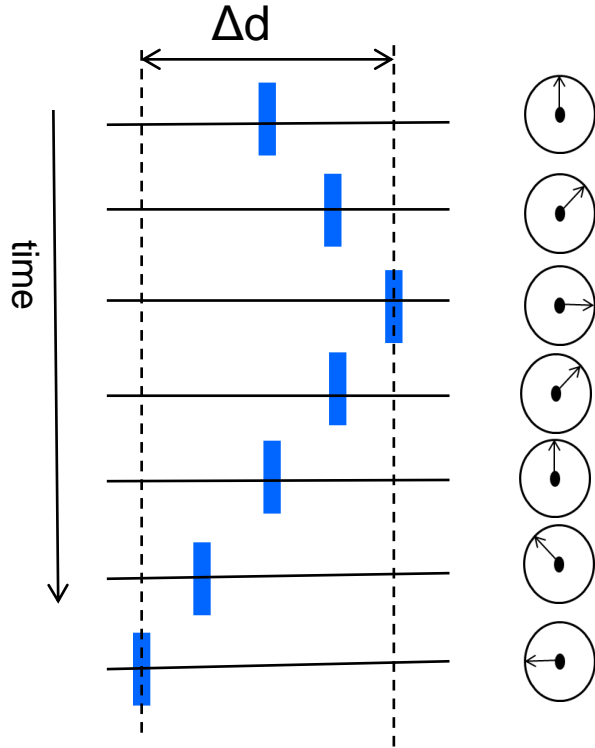

$$\Delta\phi = \frac{4\pi\Delta d}{\lambda} \Rightarrow \Delta d = \frac{\lambda\Delta\phi}{4\pi}$$

The time evolution of phase can be used to estimate both the amplitude and periodicity of the vibration

Epilogue

- Multiple objects equidistant from the radar, but with differing velocities relative to the radar.

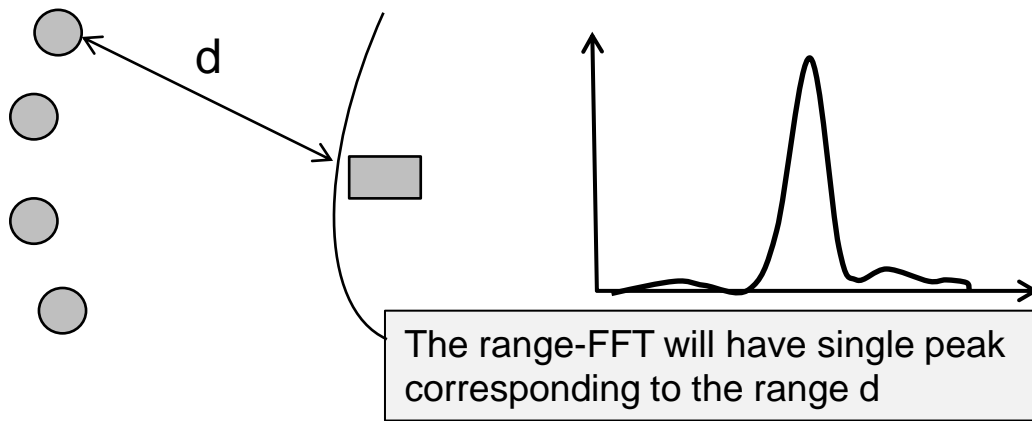

- How do we separate these objects?
 - Equi-range objects which have differing velocities relative to the radar can be separated out using a “Doppler-FFT”. This is something we will look at in the next module.

INTRODUCTION TO MMWAVE SENSING: FMCW RADARS

Module 3 : Velocity Estimation

- Quick review of background material on FFT's
- Measuring Velocity
- Maximum measurable velocity
- Velocity Resolution and concept of frame

FFT's on a complex sequence : A quick review (1/3)

- Consider a discrete signal corresponding to a phasor rotating a constant rate of ω radians per sample. An FFT on these series of samples produces a peak with the location of the peak at ω

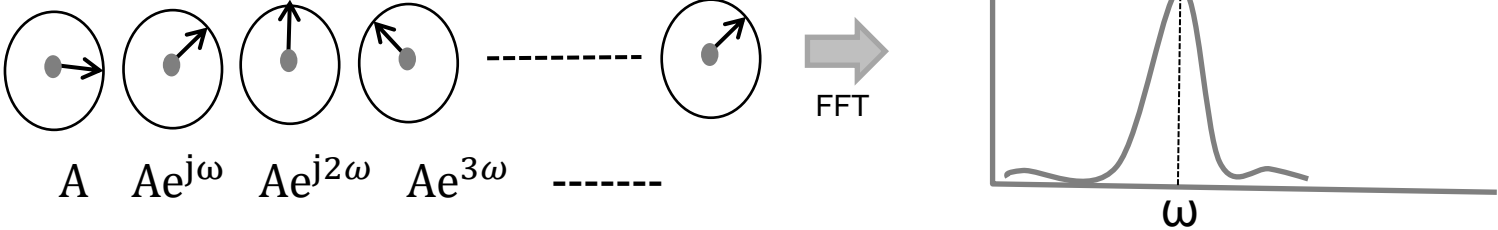

If the signal consists of the sum of two phasors, the FFT has two peaks (each phasor rotating at the rate of ω_1 and ω_2 radians per sample, respectively)

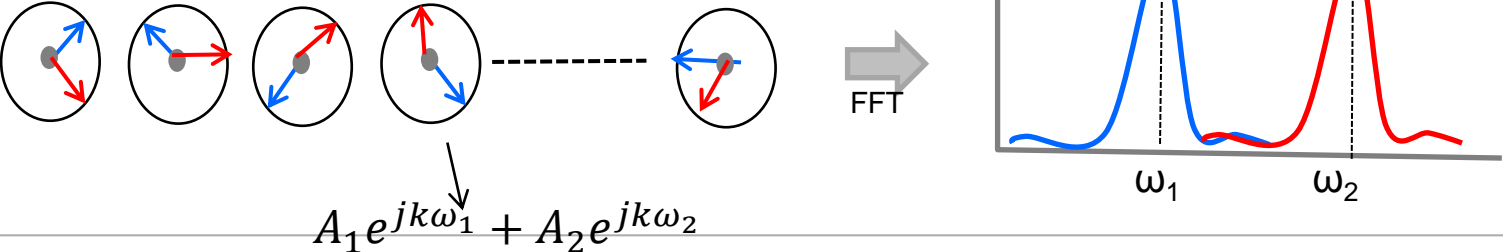

FFT's on a complex sequence : A quick review (2/3)

- $\omega_1=0$, $\omega_2=\pi/N$. Over N samples, the 2nd phasor has traversed half a cycle (π rads) more than the 1st phasor => not sufficient to resolve the two objects in the frequency domain

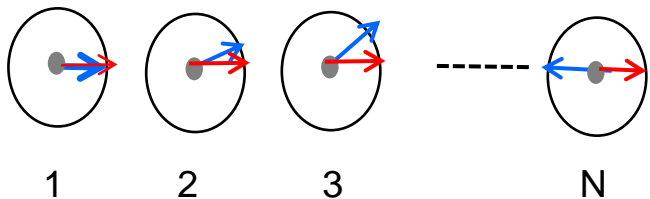

FFT

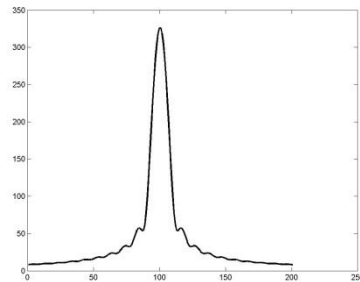

- Over $2N$ samples, the 2nd phasor has traversed a complete cycle (2π rads) more than the 1st phasor => two objects are resolved in the frequency domain

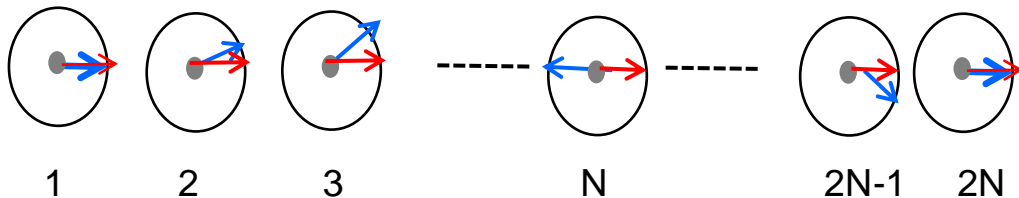

FFT

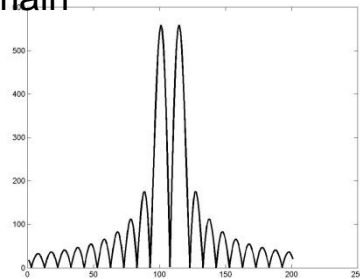

Longer the sequence length => better the resolution. In general, a sequence of length N can separate angular frequencies that are separated by more than $2\pi/N$ rad/sample

FFT's on a complex sequence : A quick review (3/3)

Comparing the frequency domain resolution criteria for continuous and discrete signals

- Continuous signals : $\Delta f = \frac{1}{T}$ cycles/sec
- Discrete signals: $\Delta\omega = \frac{2\pi}{N}$ radians/sample
 $= \frac{1}{N}$ cycles/sample

How to measure the velocity (v) of an object using 2 chirps

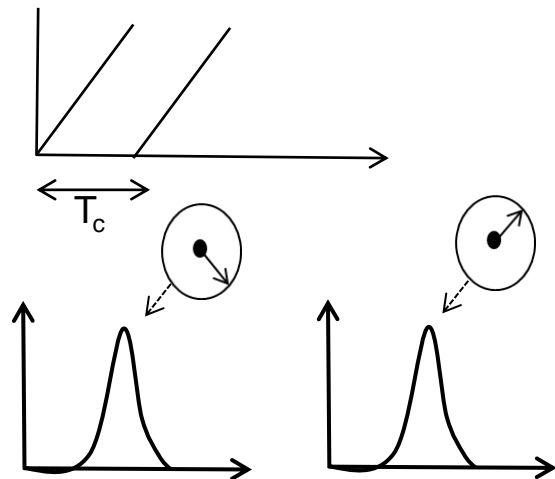

- Transmit two chirps separated by T_c
- The range-FFTs corresponding to each chirp will have peaks in the same location but with differing phase.
- The measured phase difference (ω) corresponds to a motion in the object of vT_c

$$\omega = \frac{4\pi v T_c}{\lambda} \Rightarrow v = \frac{\lambda \omega}{4\pi T_c}$$

The phase difference measured across two consecutive chirps can be used to estimate the velocity of the object

Maximum measurable velocity

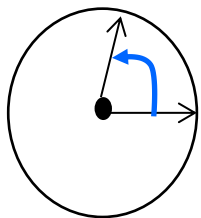

Movement away from radar $\Rightarrow \omega > 0$

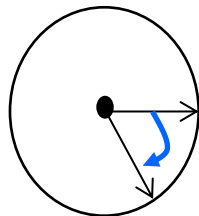

Movement towards the radar $\Rightarrow \omega < 0$

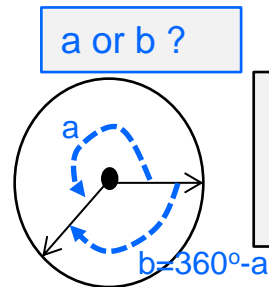

The measurement is unambiguous only if $|\omega| < 180^\circ$ (i.e. π radians)

• Unambiguous measurement of velocity $\Rightarrow |\omega| < \pi$

$$\bullet \frac{4\pi v T_c}{\lambda} < \pi \Rightarrow v < \frac{\lambda}{4T_c}$$

The maximum relative speed (v_{max}) that can be measured by two chirps spaced T_c apart is

$$v_{max} = \frac{\lambda}{4T_c}$$

Thus higher v_{max} requires closely spaced chirps

Measuring velocity with multiple objects at the same range

Consider two objects equidistant from the radar approaching the radar at speeds v_1 and v_2

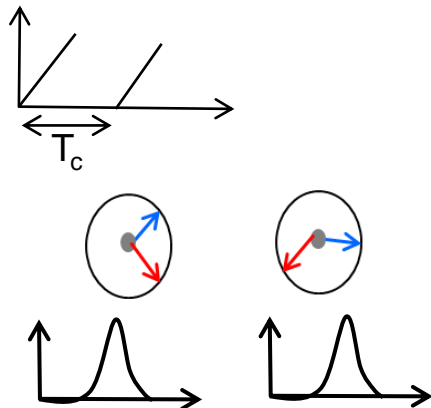
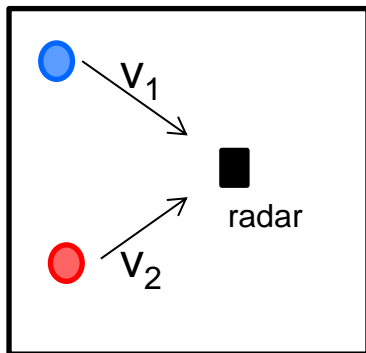

The value at the peak has phasor components from both objects. Hence previous approach will not work

Measuring velocity with multiple objects at the same range

Solution : Transmit N equi-spaced chirps. (This unit is typically called a 'frame')

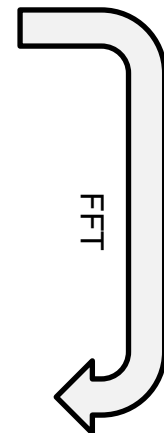
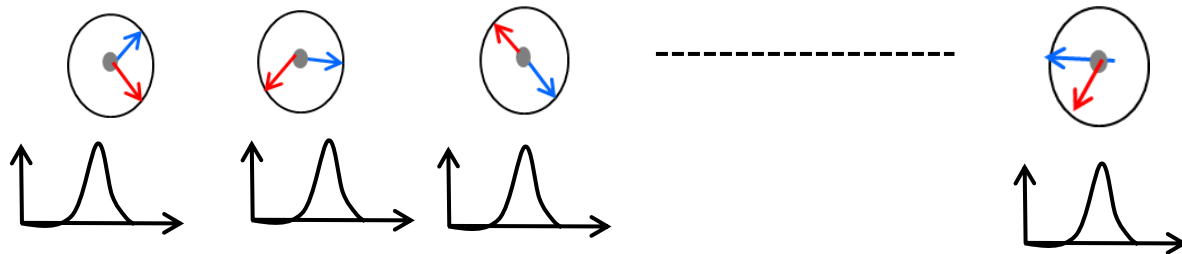
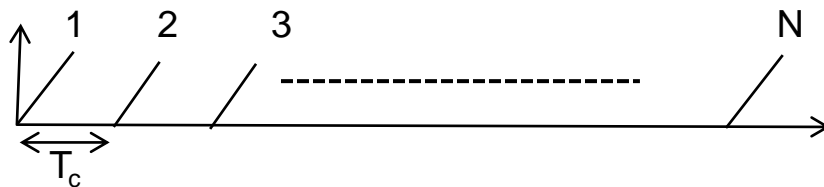
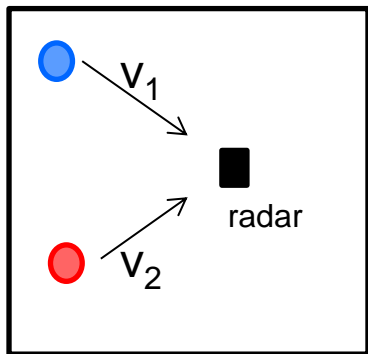

An FFT on the sequence of phasors corresponding to the range-FFT peaks resolves the two objects. This is called a doppler-FFT

ω_1 and ω_2 correspond to the phase difference between consecutive chirps for the respective objects

$$v_1 = \frac{\lambda \omega_1}{4\pi T_c}, v_2 = \frac{\lambda \omega_2}{4\pi T_c}$$

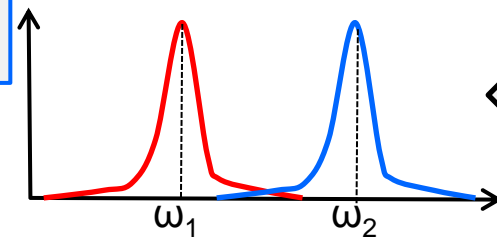

Velocity resolution

- What is the velocity resolution (v_{res}) capability of the “doppler-FFT”?
 - i.e., what is the minimum separation between v_1 and v_2 for them to show up as two peaks in the doppler-FFT
 - Recall that an FFT on a sequence of length N , can separate two frequencies ω_1 and ω_2 as long $|\omega_1 - \omega_2| > 2\pi/N$. This can be used to derive v_{res} as shown in the box (left below)



The velocity resolution of the radar is inversely proportional to the frame time (T_f) and is given by

$$v_{\text{res}} = \frac{\lambda}{2T_f}$$

$$\begin{aligned}\Delta\omega &= \frac{4\pi\Delta v T_c}{\lambda} \\ \Delta\omega &> \frac{2\pi}{N} \\ \Rightarrow \Delta v &> \frac{\lambda}{2NT_c}\end{aligned}$$

Question

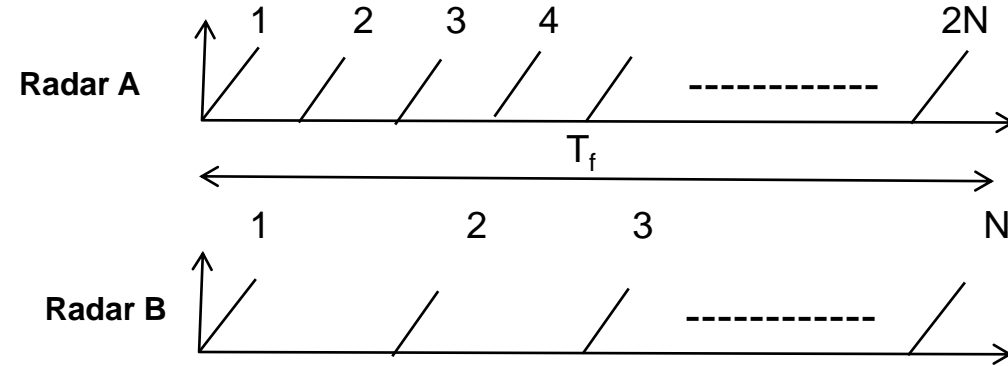

A frame in Radar A has a frame of length T_f consisting of 2N equispaced chirps

A frame in Radar B has a frame of the same length T_f but half the number of chirps (N).

- What can you say about the maximum measurable velocity (v_{\max}) and velocity resolution (v_{res}) of the 2 radars?

Visualizing the 2D-FFT

Two object equidistant from the radar approaching it at different velocities

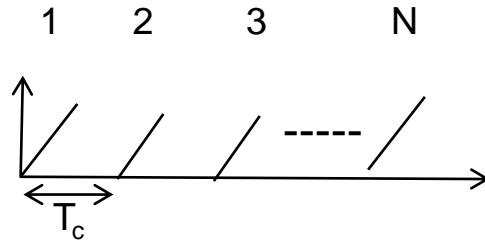
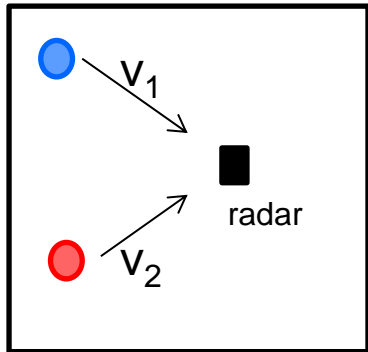

Radar transmits N chirps

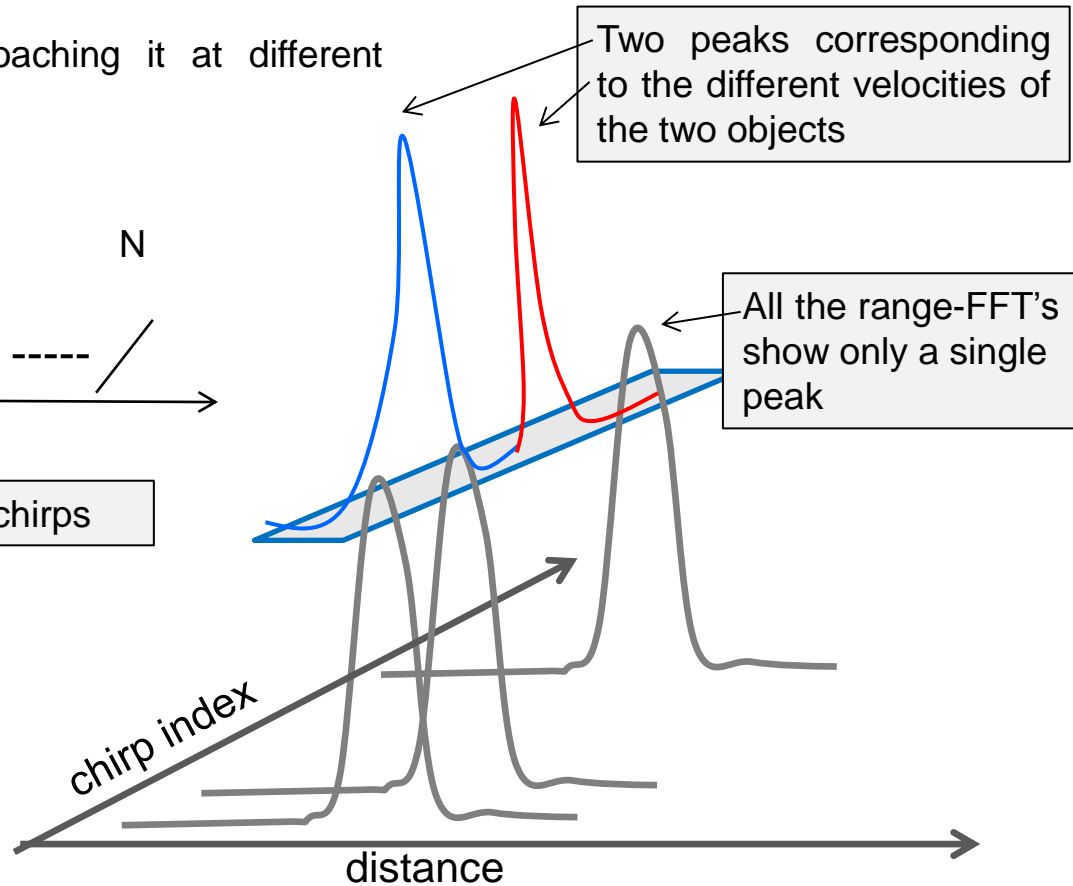

INTRODUCTION TO MMWAVE SENSING: FMCWRADARS

Module 4 : Some System Design topics

- 2D-FFT processing
- Trade-offs involved in designing a frame
- Radar range equation

FMCW 2D FFT processing in a nutshell

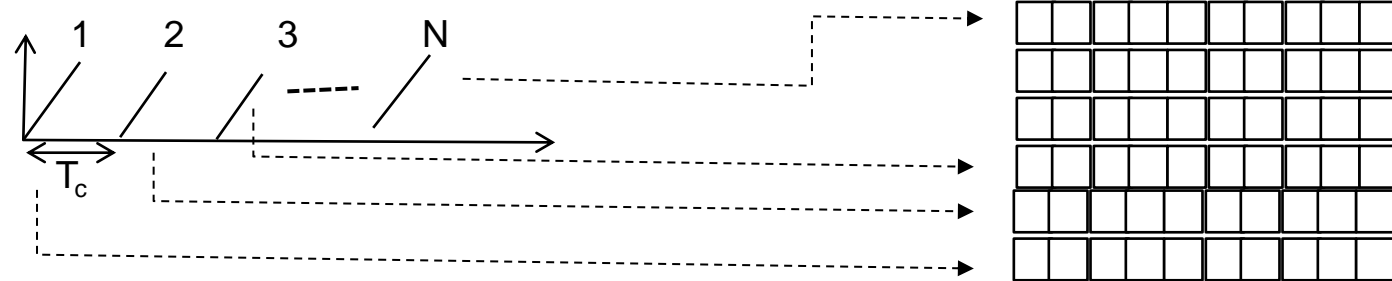

1
ADC data corresponding to chirps are stored as the rows of a matrix

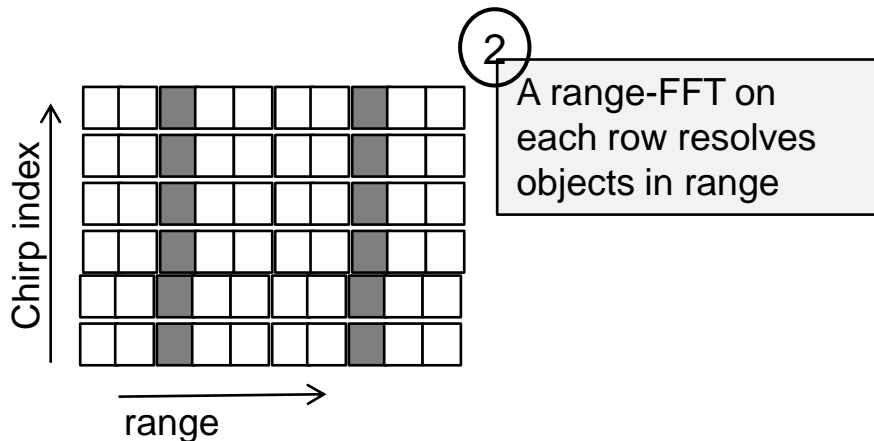

2
A range-FFT on each row resolves objects in range

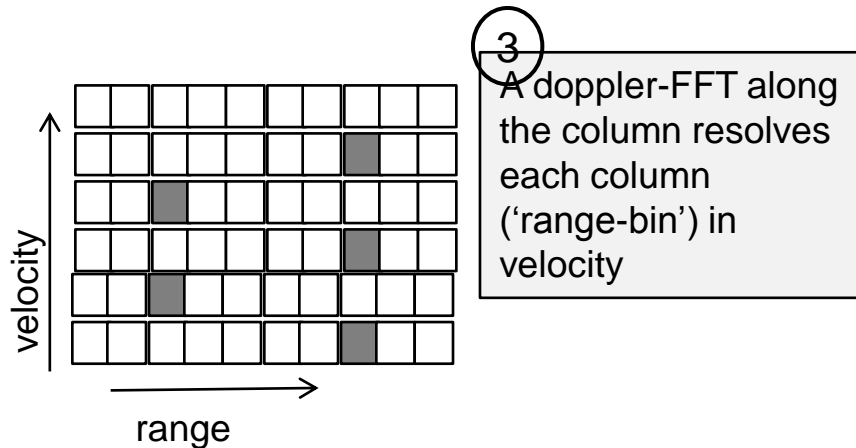

3
A doppler-FFT along the column resolves each column ('range-bin') in velocity

FMCW 2D FFT processing in a nutshell

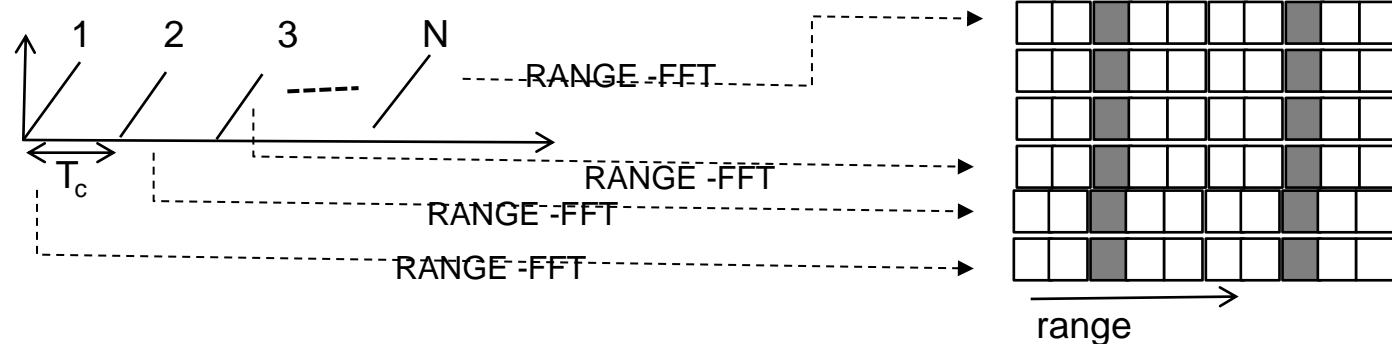

1
Range-FFT for each chirp stored as rows of the matrix

In most implementations the range-FFT is done inline prior to storing the ADC samples into memory

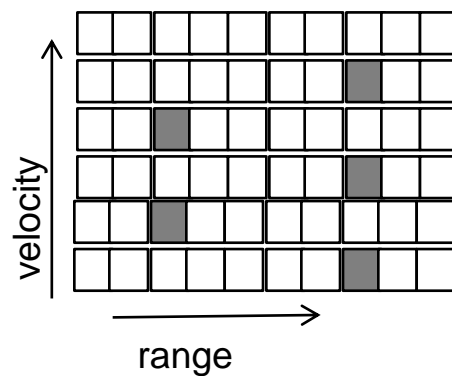

2
A doppler-FFT along the column resolves each column ('range-bin') in velocity

Mapping requirements to Chirp Parameters

Given range resolution (d_{res}), max range (d_{max}), velocity resolution (v_{res}), max velocity (v_{max}), how do we design a frame?. Lets sketch a possible design method

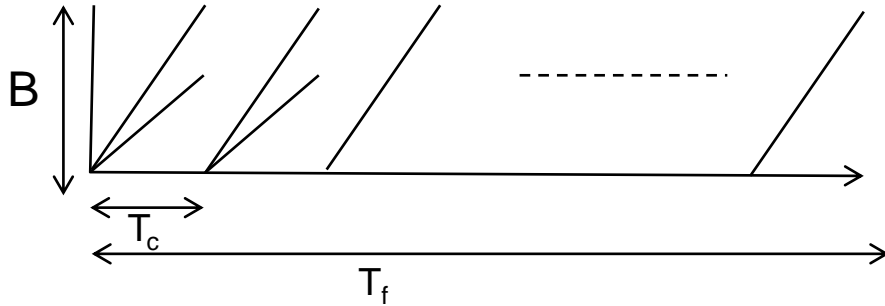

1. T_c determined using v_{max}
2. B determined using d_{res} . Note that with B and T_c known, the slope S is now determined by $S = B/T_c$
3. Frame Time T_f can be determined using v_{res}

$$v_{max} = \frac{\lambda}{4 T_c}$$

$$v_{res} = \frac{\lambda}{2 T_f}$$

$$d_{res} = \frac{c}{2 B}$$

$$T_{f_max} = \frac{S 2 d_{max}}{c}$$

Mapping requirements to Chirp Parameters

- In practice, the process of arriving at the chirp parameters might be more iterative than indicated in the previous slide.
 - The maximum required IF bandwidth might not be supported by the device
 - Since $f_{\text{IF_max}} = S d_{\text{max}} / c$, a trade-off in either S or d_{max} might be needed
 - The device must be able to generate the required Slope
 - Device specific requirements for idle time between adjacent chirps need to be honored
 - Device must have sufficient memory to store the range-FFT data for all the chirps in the frame.
 - Note that range-FFT data for all the chirps in the frame must be stored before Doppler-FFT computation can start.

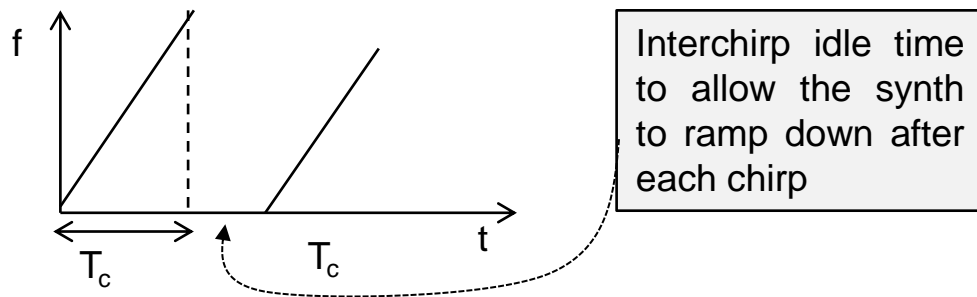

Mapping requirements to Chirp Parameters

- The product $Sx d_{\max}$ is limited by the available IF bandwidth in the device.
- Hence as d_{\max} increases \Rightarrow S has to be decreased.
- Assuming T_c is frozen based on v_{\max} , a smaller slope directly translates to poorer resolution

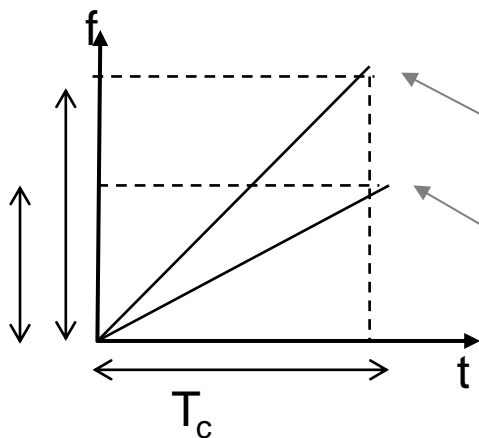

For a given T_c :

A short range radar has a higher slope and a larger chirp bandwidth (\Rightarrow better resolution)

A long range radar has a lower slope and a smaller chirp bandwidth

The Radar Range Equation

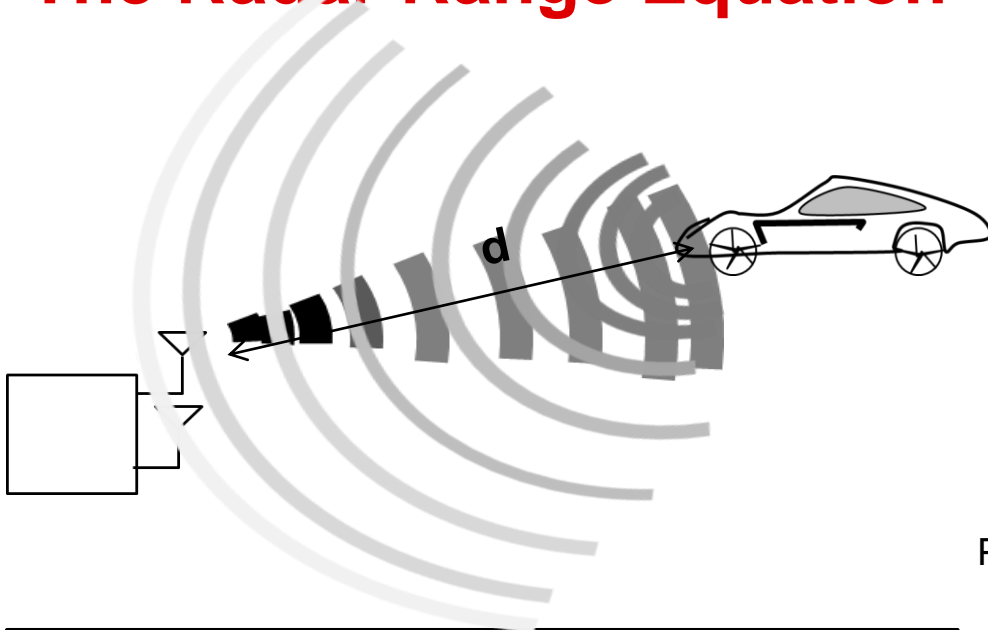

$$\text{Radiated Power Density} = \frac{P_t G_{TX}}{4\pi d^2} \text{ W/m}^2$$

$$\text{Power reflected by object} = \frac{P_t G_{TX} \sigma}{4\pi d^2} \text{ W}$$

$$\text{Power density at RX ant} = \frac{P_t G_{TX} \sigma}{(4\pi)^2 d^4} \text{ W/m}^2$$

$$\begin{aligned} \text{Power captured at RX ant} &= \frac{P_t G_{TX} \sigma A_{RX}}{(4\pi)^2 d^4} \text{ W} \\ &= \frac{P_t G_{TX} \sigma G_{RX} \lambda^2}{(4\pi)^3 d^4} \text{ W} \end{aligned}$$

P_t : Output power of device

$G_{TX/RX}$: TX/RX Antenna Gain

σ : Radar Cross Section of the Target (RCS)

A_{RX} : Effective aperture area of RX antenna

$$A_{RX} = \frac{G_{RX} \lambda^2}{4\pi}$$

The Radar Range Equation

$$SNR = \frac{\sigma P_t G_{TX} G_{RX} \lambda^2 T_{meas}}{(4\pi)^3 d^4 k T F}$$

Total measurement time (NT_c)

Thermal noise at the receiver (k=Boltzman constant, T=Antenna temperature)

- There is a minimum SNR (SNR_{min}) that is required for detecting a target.
 - Choice of SNR_{min} is trade-off between probability of missed detections and probability of false alarms. Typical numbers are in the 15dB-20dB range.
- Given an SNR_{min}, the maximum distance that can be seen by the radar can be computed as:

$$d_{max} = \left(\frac{\sigma P_t G_{TX} G_{RX} \lambda^2 T_{meas}}{(4\pi)^3 SNR_{min} k T F} \right)^{\frac{1}{4}}$$

Epilogue

- Two objects equidistant from the radar and with the same velocity relative to the radar. How will the range-velocity plot look like?

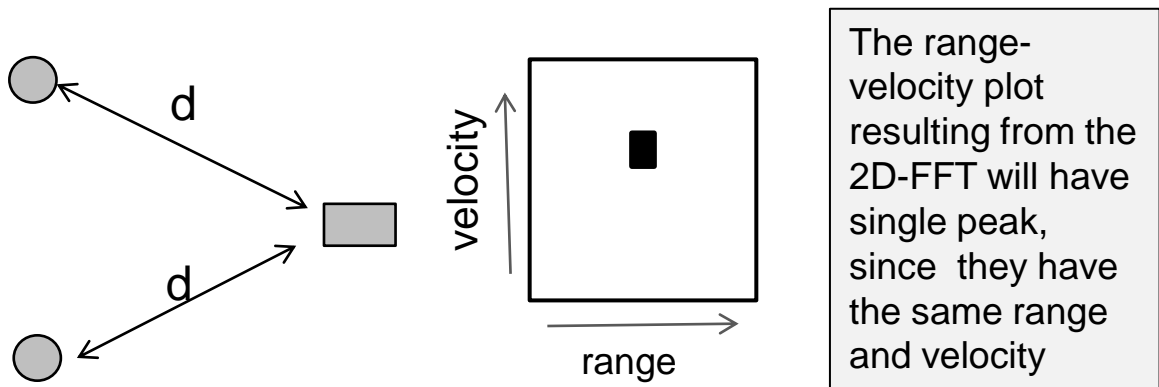

- How do we separate these two objects?
 - Need multiple antennas to estimate the angle of arrival. Discussed in the next module

INTRODUCTION TO MMWAVE SENSING: FMCW RADARS

Module 5 : Angle Estimation

Welcome to this 5th module in this introductory series on fmcw radars. Over the past 4 modules have focussed on sensing along two dimensions namely range and velocity. This module is going to focus on the 3rd sensing dimension : angle.

- Angle Estimation of a single object
- Field of view
- Angle resolution
- Discussion on Range, Velocity and Angle Resolution

In this module we'll try to answer the following questions.....

How does the radar estimate the angle of arrival of an object in front of the radar?

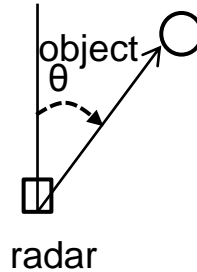

What if there are multiple objects at different angles?

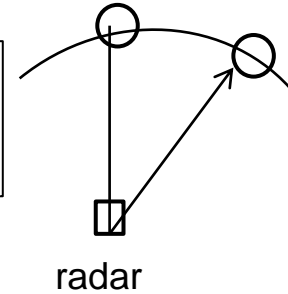

What does the angle resolution depend on?

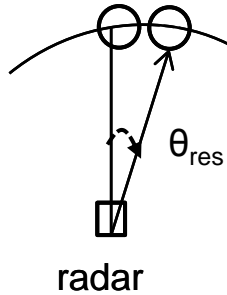

What determines the maximum field of view

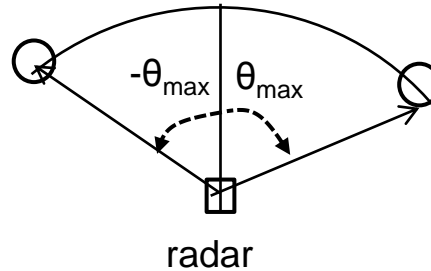

Basis of Angle of Arrival (AoA) estimation

Recall that a small change in the distance of the object result in a phase change (ω) in the peak of the range-FFT

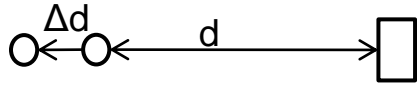

$$\omega = \frac{4\pi\Delta d}{\lambda}$$

Angle Estimation requires at least 2 RX antennas. The differential distance from the object to each of the antennas results in a phase change in the 2D-FFT peak which is exploited to estimate the angle of arrival

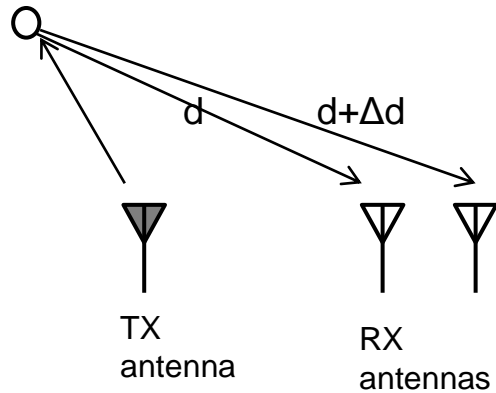

$$\omega = \frac{2\pi\Delta d}{\lambda}$$

Why are these two expressions off by a factor of 2?

How to measure the AoA of an object using 2 RX antennas

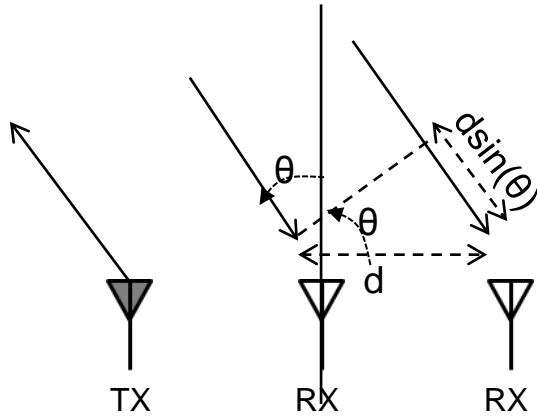

- TX antenna transmits a frame of chirps
- The 2D-FFT corresponding to each RX antenna will have peaks in the same location but with differing phase.
- The measured phase difference (ω) can be used to estimate the angle of arrival of the object

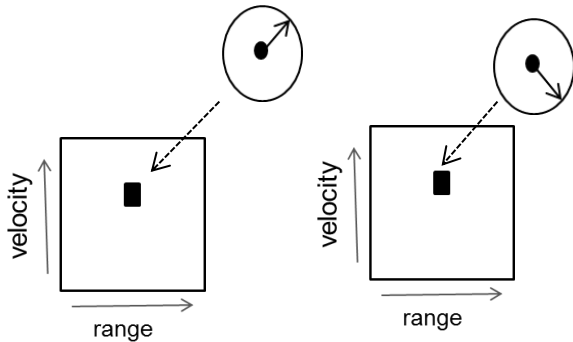

$$\omega = \frac{2\pi d \sin(\theta)}{\lambda} \Rightarrow \theta = \sin^{-1} \left(\frac{\lambda \omega}{2\pi d} \right)$$

Estimation accuracy depends AoA

Sensitivity of $\sin(\theta)$ to θ degrades as θ increases

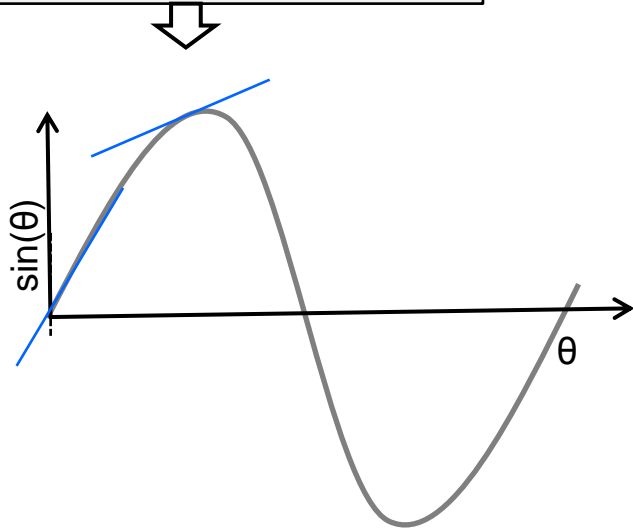

$$\omega = \frac{2\pi d \sin(\theta)}{\lambda}$$

- Note that the relationship between ω and θ is a non-linear relationship. (unlike in the case of velocity where $\omega = \frac{4\pi v T_c}{\lambda}$)
- At $\theta = 0$, ω is most sensitive to changes in θ . The sensitivity of ω to θ reduces as θ increases (becoming 0 at $\theta = 90^\circ$)
- Hence estimation of θ is more error prone as θ increases.

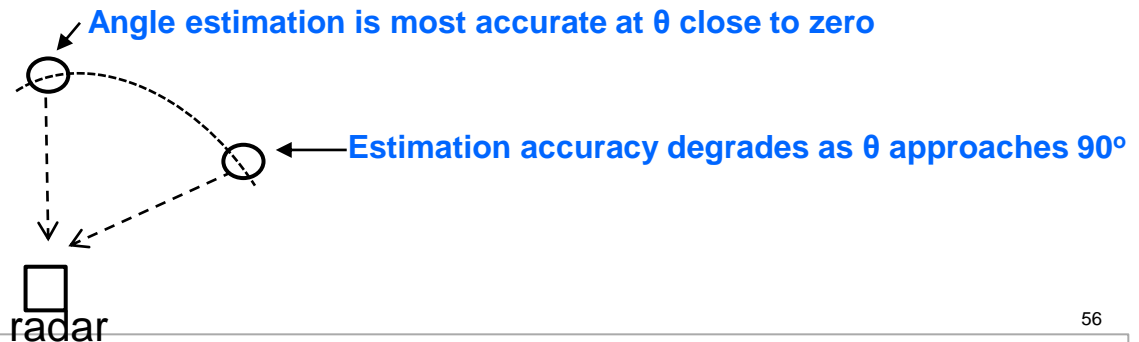

Angular Field of View

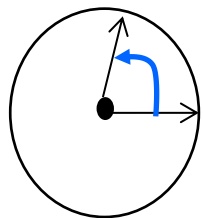

Objects to the left of the radar => $\omega > 0$

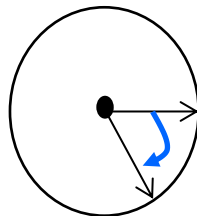

Objects to the right of the radar => $\omega < 0$

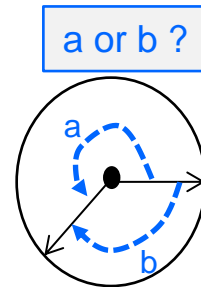

The measurement is unambiguous only if $|\omega| < 180^\circ$ (i.e. π radians)

• Unambiguous measurement of velocity => $|\omega| < 180^\circ$

• $\frac{2\pi d \sin(\theta)}{\lambda} < \pi \Rightarrow \theta < \sin^{-1}\left(\frac{\lambda}{2d}\right)$

The maximum field of view that can be serviced by two antennas spaced d apart is

$$\theta_{\max} = \sin^{-1}\left(\frac{\lambda}{2d}\right)$$

A spacing d of $\lambda/2$ results in the largest field of view ($\pm 90^\circ$)

Measuring AoA of multiple objects at the same range and velocity

Consider two objects equidistant from the radar approaching the radar at the same relative speed to the radar

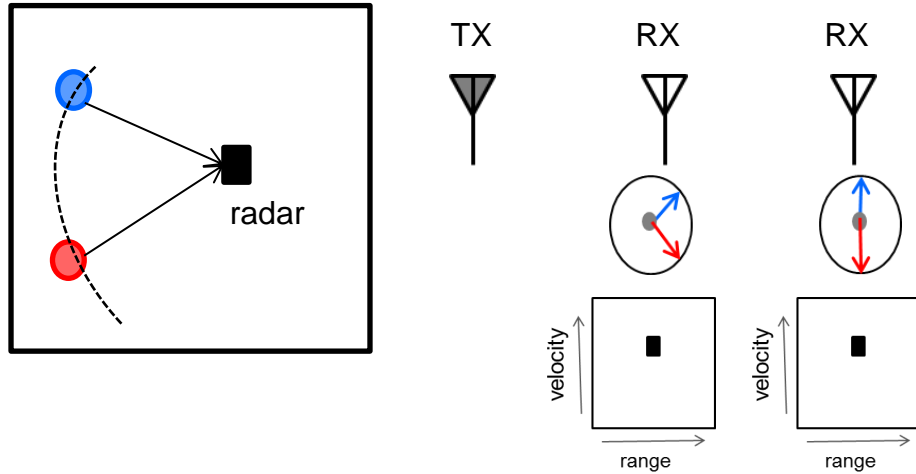

The value at the peak has phasor components from both objects. Hence previous approach will not work

Measuring AoA of multiple objects at the same range and velocity

Solution : An array of receive N antennas

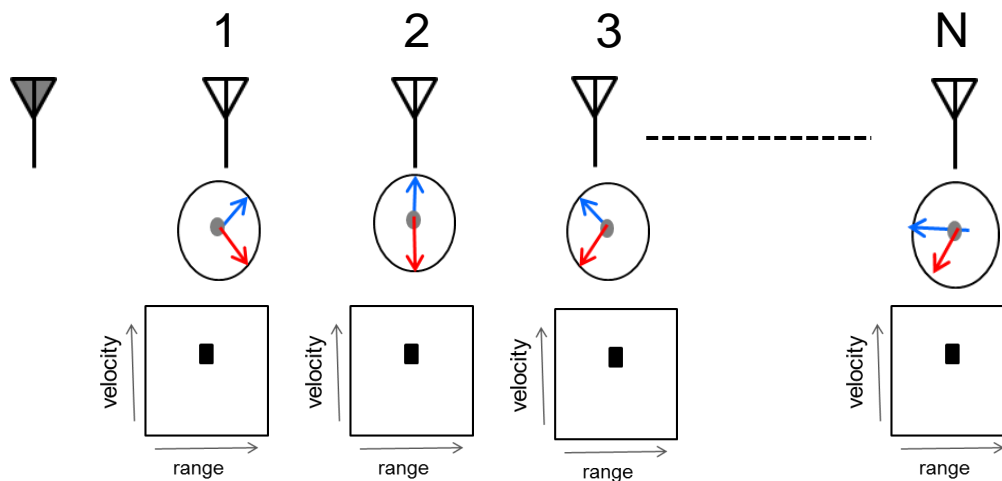
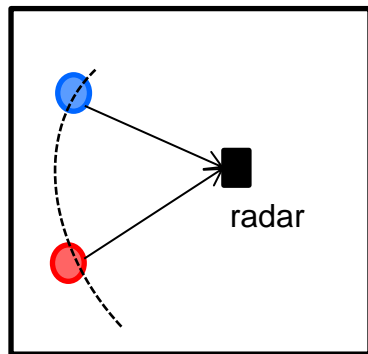

An FFT on the sequence of phasors corresponding to the 2D-FFT peaks resolves the two objects. This is called angle-FFT

ω_1 and ω_2 correspond to the phase difference between consecutive chirps for the respective objects

$$\theta_1 = \sin^{-1} \left(\frac{\lambda \omega_1}{2\pi d} \right), \quad \theta_2 = \sin^{-1} \left(\frac{\lambda \omega_2}{2\pi d} \right)$$

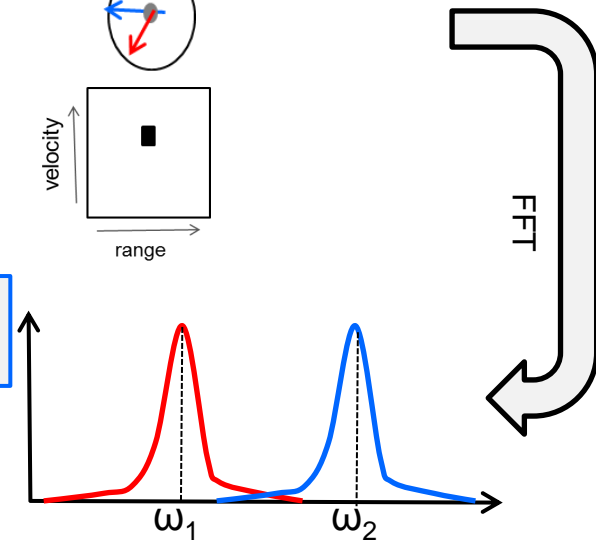

Angle resolution

- Angle resolution (θ_{res}) is the minimum angle separation for the two objects to appear as separate peaks in the angle-FFT. Given by the formula:

- $\theta_{\text{res}} = \frac{\lambda}{Nd\cos(\theta)}$ <=Note the dependency of the resolution on θ . Resolution best at $\theta=0$ (Why?)

- Resolution is often quoted assuming $d=\lambda/2$ and $\theta=0 \Rightarrow \theta_{\text{res}} = \frac{2}{N}$

Angle resolution

- Angle resolution (θ_{res}) is the minimum angle separation for the two objects to appear as separate peaks in the angle-FFT. Given by the formula:

- $\theta_{\text{res}} = \frac{\lambda}{Nd \cos(\theta)}$ <=Note the dependency of the resolution on θ . Resolution best at $\theta=0$ (Why?)

- Resolution is often quoted assuming $d=\lambda/2$ and $\theta=0 \Rightarrow \theta_{\text{res}} = \frac{2}{N}$

Resolution degrades as AoA increases

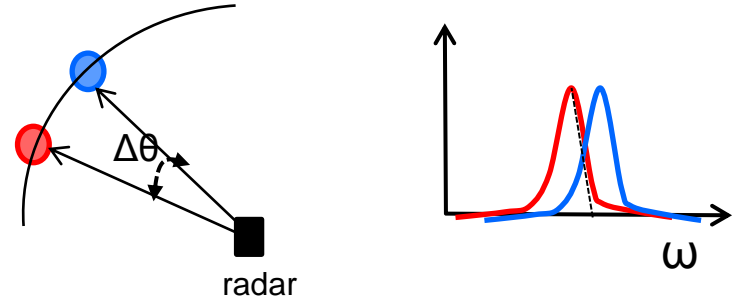
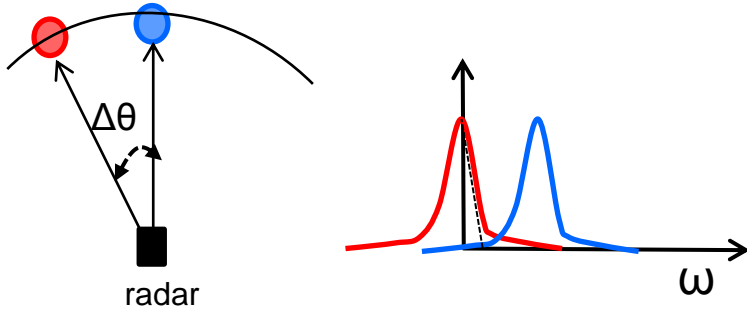

Angle Resolution

$$\begin{aligned}\Delta\omega &= \frac{2\pi d}{\lambda} (\sin(\theta + \Delta\theta) - \sin(\theta)) \\ &\approx \frac{2\pi d}{\lambda} \cos(\theta) \Delta\theta \\ \Delta\omega &> \frac{2\pi}{N} \\ \Rightarrow \frac{2\pi d}{\lambda} \cos(\theta) \Delta\theta &> \frac{2\pi}{N} \\ \Rightarrow \Delta\theta &> \frac{\lambda}{Nd\cos(\theta)}\end{aligned}$$

Since derivative of $\sin(\theta)$ is $\cos(\theta)$

$$\frac{\sin(\theta + \Delta\theta) - \sin(\theta)}{\Delta\theta} = \cos(\theta)$$

Angle resolution given by : $\theta_{\text{res}} = \frac{\lambda}{Nd\cos(\theta)}$

Resolution is often quoted assuming $d=\lambda/2$ and $\theta=0 \Rightarrow \theta_{\text{res}} = \frac{2}{N}$

Comparision of Angle & Velocity Estimation

Both angle estimation and velocity estimation rely on similar concepts and hence its instructive to compare our discussion on these two

ANGLE ESTIMATION

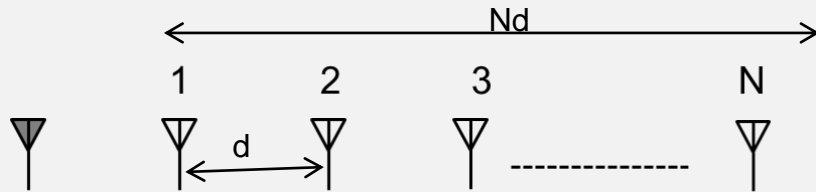

- Exploits phase change across chirps separated in space
- Resolution depends on Antenna array length (Nd is array length) ($\theta_{res} = \frac{\lambda}{Nd\cos(\theta)}$)
- Maximum angle that can be unambiguously measured depends on the distance d between consecutive antennas ($\theta_{max} = \frac{\lambda}{2d}$)

VELOCITY ESTIMATION

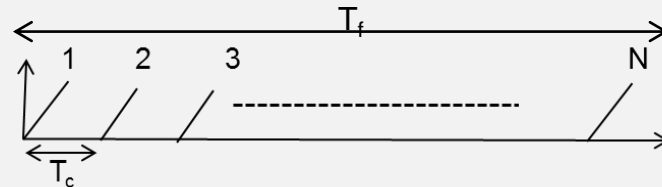

- Exploits phase change across chirps separated in time
- Resolution depends on Frame length ($v_{res} = \frac{\lambda}{2T_f}$)
- Maximum velocity that can be unambiguously measured depends on the time T_c between consecutive chirps ($v_{max} = \frac{\lambda}{4T_c}$)

Angle estimation in FMCW radar

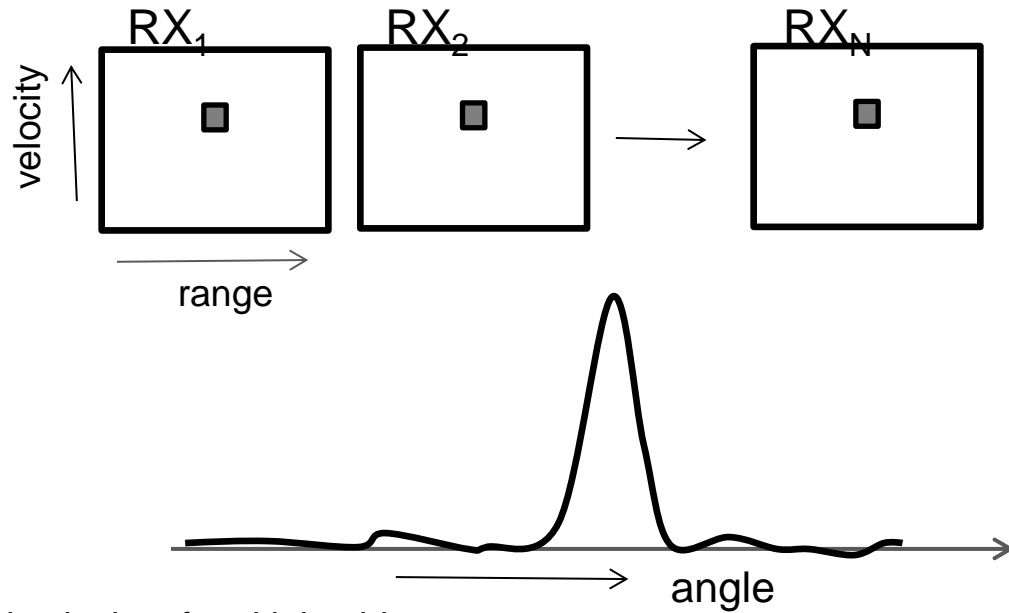
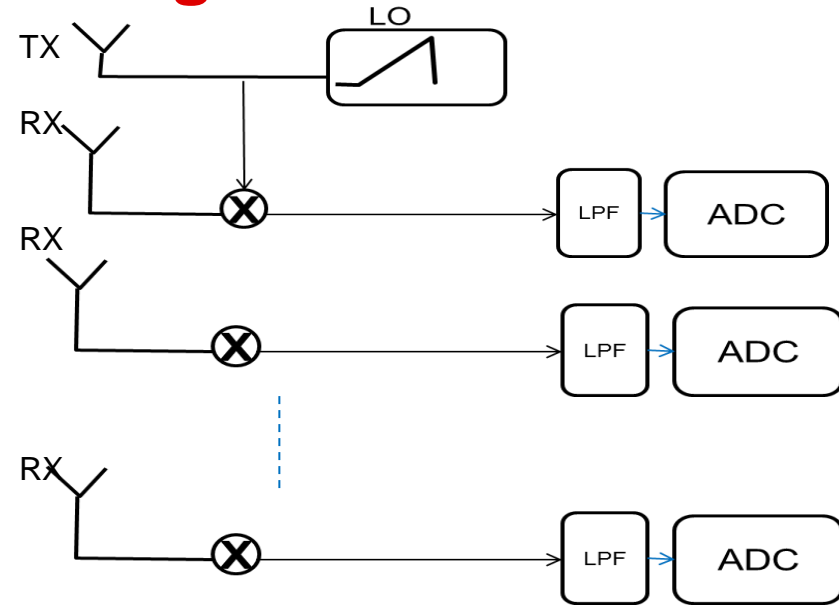

- A single TX, RX chain can estimate the range and velocity of multiple objects.
- Besides range, angle information is needed for localization
- Multiple RX antennas are needed for angle estimation.
 - The 2D FFT grid is generated at each RX chain (corresponding to each antenna)
 - FFT on the corresponding peak across antennas is used to estimate the angle

Question

- Two stationary objects are at the same range from a radar which has 1 TX and 2 RX antennas.
- Is it possible to estimate the angle of arrival of both the objects

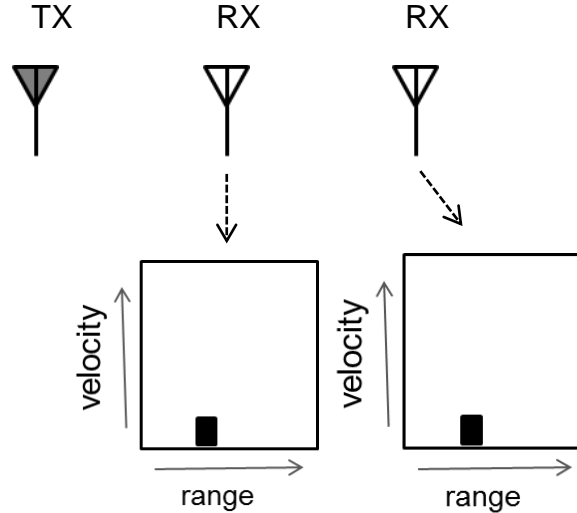
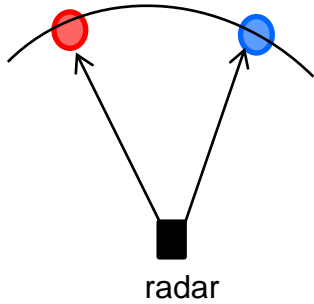

Both the objects appear in the same bin in both RX's. Cannot be separated out using only 2 antennas

Question

- What about if one of the objects has non-zero velocity?

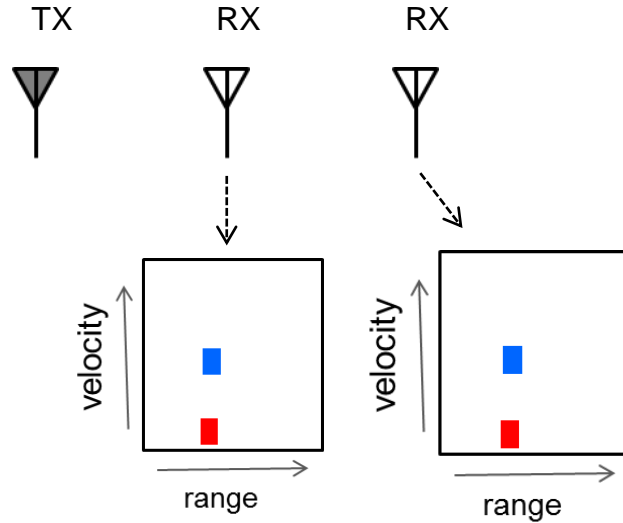
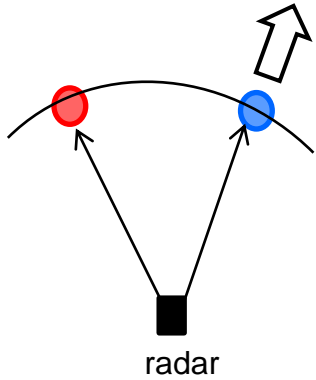

Both objects now appear in different 'bins' in the 2D-FFT. Angle Estimation can now be performed by comparing the phase of blue/red bins

Range, Velocity and Angle Resolution

- Range resolution:
 - Directly proportional to the bandwidth (B) spanned by the chirp.
 - A good synthesizer should be able to span a large bandwidth. (4GHz=> 4cm)
- Velocity resolution:
 - Velocity resolution can be improved by increasing frame time (T_f)=> No hardware cost.
 - A T_f of 5ms => v_{res} of 1.5 kmph
- Angle resolution:
 - Improving angle resolution requires increasing the number of receive antennas. Each receive antenna has its own receive chain (LNA, mixer, LPF, ADC).
 - Cost and area constraints limit most radar on a chip solutions to a small number RX chains (Further improvements possible via multi-chip cascading)

$$d_{res} = \frac{c}{2B}$$

$$v_{res} = \frac{\lambda}{2T_f}$$

$$\theta_{res} = \frac{2}{N}$$

Range and Velocity resolution are the native strengths of radar

Range, Velocity and Angle Resolution

- Objects need to be mutually resolved only in one of the dimensions of range, velocity and angle. Hence a radar with a good range and velocity resolution can ease the requirements on the angle resolution

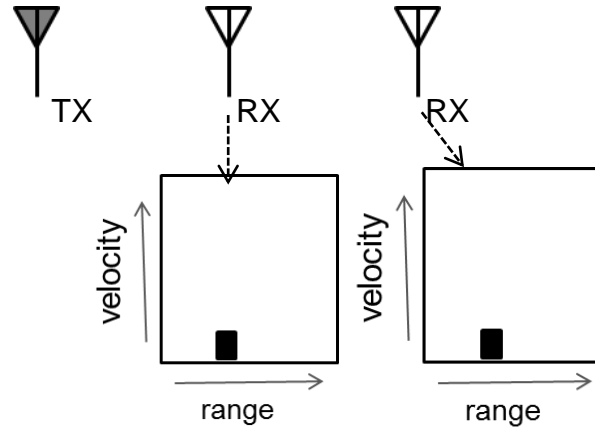
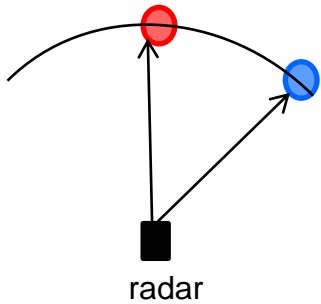

That is illustrated in these examples here. Which means that separating these signals will have to rely on angle resolution capability of the radar

Two stationary objects equidistant from the radar => their signals fall in the same range-Doppler bin => need good angle resolution to resolve them.

Range, Velocity and Angle Resolution

- Objects need to be mutually resolved only in one of the dimensions of range, velocity and angle. Hence a radar with a good range and velocity resolution can ease the requirements on the angle estimation

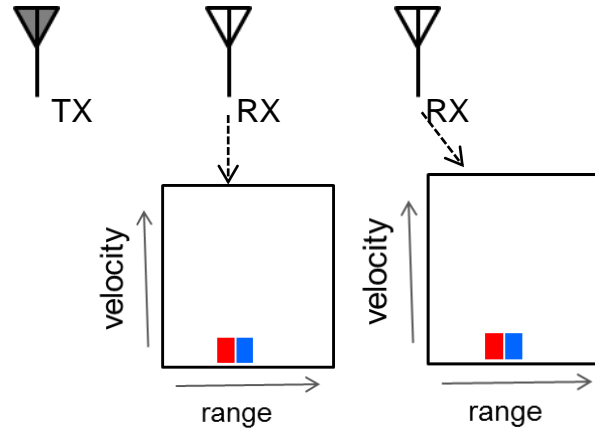
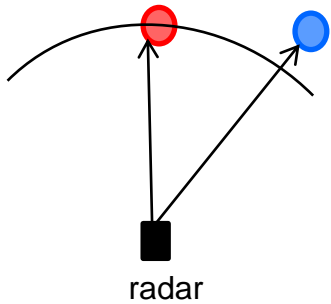

This object has a slightly different range
The moment the range difference $>$ range resolution
Do not have to be resolved in angle any more

In practice it is highly unlikely that two objects are exactly equidistant. Better the range resolution more likely the signals will separate out into separate bins.

Range, Velocity and Angle Resolution

- Objects need to be mutually resolved only in one of the dimensions of range, velocity and angle. Hence a radar with a good range and velocity resolution can ease the requirements on the angle estimation

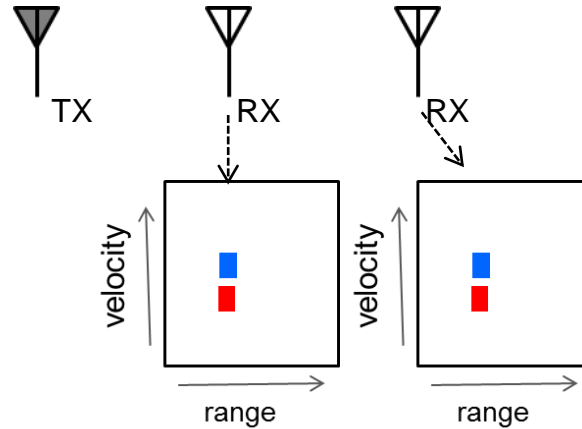
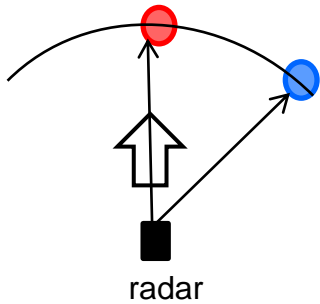

As long as the radar is stationary, these two stat objects have the same relative velocity (namely zero w.r.t radar). But the moment the radar starts moving forward in this case each of these objects will have a different rv wrt radar and hence will separate out in the velocity dimension.

Motion of the radar can also help in separating out stationary objects. Better the velocity resolution => smaller velocity suffices